

General Catalogue

Catálogo General

Generalkatalog

MATTES

INSTRUMENTE GmbH
MEDIZINTECHNIK

Haldenstraße 27
D-78532 Tuttlingen-Nendingen / Germany
Telefon +49 (0)74 61/36 43
Telefax +49 (0)74 61/7 73 99
E-mail: jens.mattes@mattes-medizintechnik.com
Homepage: www.mattes-medizintechnik.com

History der Firma Mattes-Instrumente GmbH, Tuttlingen-Nendingen

Im Januar 1947 machte Herr Fred Mattes die Lehre als Export Manager in einem einschlägigen Herstellungsbetrieb von chirurgischen Instrumente aller Art in Tuttlingen.

Im Bereich der Herstellung von chirurgischen Instrumenten konnte Herr Mattes eine gute Berufserfahrung sammeln für die spätere Selbständigkeit.

Am 1. April 1967 wurde die Firma Fred Mattes, in Tuttlingen-Nendingen gegründet. Der damalige Erfolg war der Grundstock des heutigen Unternehmens. Viele Kunden kamen durch die Mundwerbung zur Firma Mattes.

Da der damalige Export in viele Länder wuchs ist die Firma Mattes ins Handelsregister unter der Nummer HRA 591 TU eingetragen worden.

Ende 1989 ist Herr Fred Mattes altershalber aus der Firma ausgeschieden. Danach ab Januar 1990 hat sein Sohn Jens Mattes die Firma übernommen und in Firma Mattes Instrumente GmbH 78532 Tuttlingen, Haldenstr. 27 geändert.

Es war auch eine Neueintragung im Handelsregister notwendig unter Nr. HRB 537 TU vom 28.12.1990.

Im Jahr 1998 übernahm Herr Jens Mattes auch die Geschäftsführung des Unternehmens.

Inzwischen exportiert die Firma Mattes Instrumente GmbH ihre chir. Instrumente Instrumente und Osteosynthes Produkte weltweit mit großer Resonanz.

Mit dem Aufbau des Qualitätsmanagement-Systems nach DIN ISO 13485 und der Zertifizierung des Systems möchten wir die erreichte Marktposition und Wettbewerbsfähigkeit halten und weiter ausbauen.

Mattes Instrumente GmbH
MEDIZINTECHNIK
Haldenstr. 27
TUTTLINGEN / GERMANY

MATTES

History of Mattes-Instrumente GmbH, Tuttlingen-Nendingen

In January 1947, Fred Mattes started his professional career with a training in export management in a Tuttlingen based company manufacturing various surgical instruments.

The experiences Mr. Mattes was able to collect in the field of manufacturing surgical instruments proved very valuable for his own business.

On April 1st, 1967 the company Fred Mattes was founded in Tuttlingen-Nendingen. The success that followed laid the foundation of the company as it is today. Many customers were brought to Mattes by word of mouth.

The enormous increase of export to many countries at that time led to the registration of Mattes in the commercial register under Nr. HRB 537 TU.

Approaching retirement age, Fred Mattes handed over operational responsibilities to his son at the end of 1989. From January 1990 Jens Mattes took over the company changing its name to Mattes Instrumente GmbH, Haldenstr. 27, 78532 Tuttlingen, Germany.

Also, on December 28, 1990 a new registration in the commercial register followed under nr. HRB 537 TU.

Effectively 1998 Mr. Jens Mattes took over as president of his company.

Nowadays the products of Mattes Instrumente are exported very successfully all over the world.

With the introduction of a quality management system according to DIN ISO 13485 followed by certification we intend to maintain and further increase our market position and competitive strength.

Mattes Instrumente GmbH
medical technologies
Haldenstr. 27
TUTTLINGEN/GERMANY

INDEX

03+71 GYNÄKOLOGIE
 05+10 SKALPELLE, MESSER
 07+17 DIAGNOSTIK
 8 NARKOSE
 11 PINZETTEN
 13 SCHEREN
 14 MICRO-SCHEREN
 16 GIPS-VERBAND
 17 MESS-INSTRUMENTE
 18 TC-SCISSORS
 19 TC-PINZETTEN
 20 TC-NADELHALTER
 24 NADELHALTER
 22+24 NAHT
 26 KLEMMEN
 28 TUPFERKLEMMEN
 30 GALLE, DARMKLEMMEN
 31 TUCHKLEMMEN
 35 ATRAUMA, HERZGEFÄSS CHIR.
 37 TRACHEOTOMIE
 40 WUNDHAKEN
 42+52 KNOCHENCHIRURGIE

46 BAUCHDECKENHALTER
 48 HOHLMEISSELZANGEN
 49 KNOCHENSPLITZERZANGEN
 50 KNOCHENH.-ZANGE U. -HEBEL
 52 BOHRDRÄHTE
 53 NEUROCHIRURGIE + KEHLKOPF
 55 SCHARFE LÖFFEL
 57 LAMINEKTOMIE
 58 KEHLKOPF
 60+65 REKTUM
 62 THORAX
 64 UROLOGIE
 60+71 GYNÄKOLOGIE
 73 GEBURT SZANGEN
 75 DERMATOLOGIE, HYGIENE
 78 CONTAINER, SCHALEN

82 OPHTALMOLOGIE
 83 OTOLOGIE
 84 RHINOLOGIE
 85 MUND UND ZUNGE
 86 TONSILLE

90 REDON NADELN

INDEX

03+71 GYNECOLOGY
 05+10 SKALPELS
 07+17 DIAGNOSTIC
 8 ANESTHESIA
 11 THUMP + TISSUE FORC.
 13 SCISSORS
 14 MICRO SCISSORS
 16 PLASTER OF PARIS
 17 MEASURING INSTR.
 18 TUNGSTEN CARBIDGE SCISSORS
 19 TUNGSTEN CARBIDGE FORCEPS
 20 TUNGSTEN CARBIDGE NEEDLEHOLDERS
 24 NEEDLEHOLDER
 22+24 SUTURING INSTRUMENTS
 26 HEMOSTATIC FORCEPS
 28 DRESSING FORCEPS
 30 GALL, STOMACH-FORCEPS
 31 TOWEL FORCEPS
 35 ATRAUMA. CARDIOVASCULAR SURGERY
 37 TRACHEOTOMY
 40 RETRACTORS
 42+52 BONE SURGERY


48 RONGEUR
 49 BONE CUTTING FORCEPS
 50 BONE HOLDING FORC. AND LEVERS
 52 DRILL WIRES
 53 NEURO CHIRURGY + LARYNX
 55 BONE CURETTES
 57 LAMINECTOMY
 58 RHINOLOGY
 60+65 RECTUM
 62 THORAX
 64 UROLOGY
 60+71 GYNECOLOGY
 73 OBSTETRICS
 75 DERMATOLOGIE, HYGIENE
 78 CONTAINERS


82 OPHTHALMOLOGY
 83 OTOLOGY
 84 RHINOLOGY
 85 MOUTH TONGUE
 86 TONSIL


90 REDON NEEDLES


ZEICHENERKLÄRUNG
EXPLANATION OF SYMBOLS
EXPLICATION DES SYMBOLS
EXPLICACIÓN DE LOS SIMBOLOS
SPIEGAZIONE DEI SIMBOLI

2000.14 = Endnummer 14 ist die Länge oder Figur, oder mm des Instruments
14 is the size of Fig. of instruments
14 taille ou numero de fig

 = Gerades Instrument
Straight Instrument
Instrument droit
Instrumento recto
Strumento retto

 = Gebogenes Instrument
Curved Instrument
Instrument courbe
Instrumento curvo
Strumento curvo

 = Scharfes Instrument
Sharp Instrument
Instrument pointu
Instrumento agudo
Strumento acuto

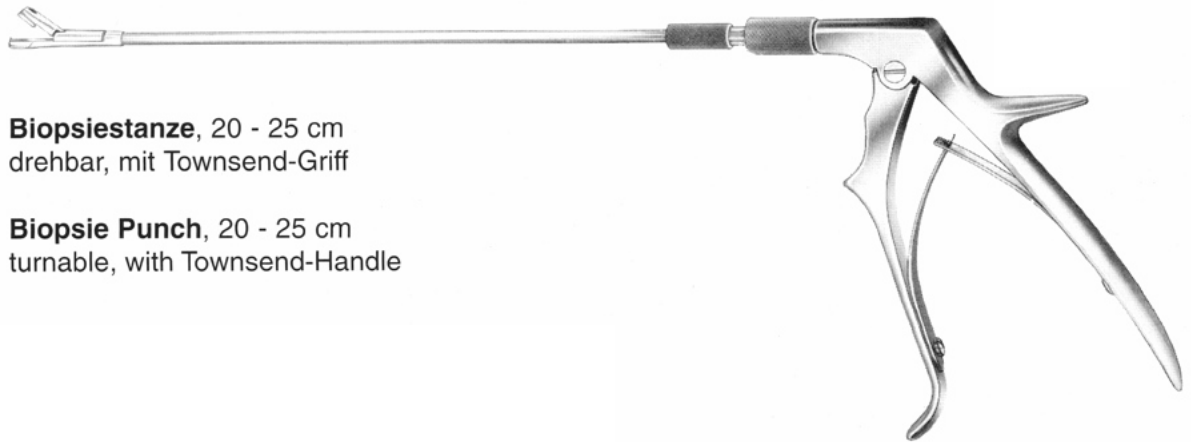
 = Stumpfes Instrument
Blunt Instrument
Instrument mousse
Instrumento romo
Strumento smusso

TC 4505.13 = Mit TC-Einsätzen
TC Lined
A mors TC
Con bocas TC
Con morso TC

TC 3710.14 = TC Schneiden
TC Cutting Edges
Tranchant TC
Filos de corte TC
Taglio TC

TI 5151.14 = Instrument aus Titan
Instrument from Titanium
Instrument en Titane
Instrumento de Titanio
Strumento in Titanio

**INSTRUMENTE FÜR GYNÄKOLOGIE
INSTRUMENTS FOR GYNECOLOGY**



Biopsiestanze, 20 - 25 cm
drehbar, mit Townsend-Griff

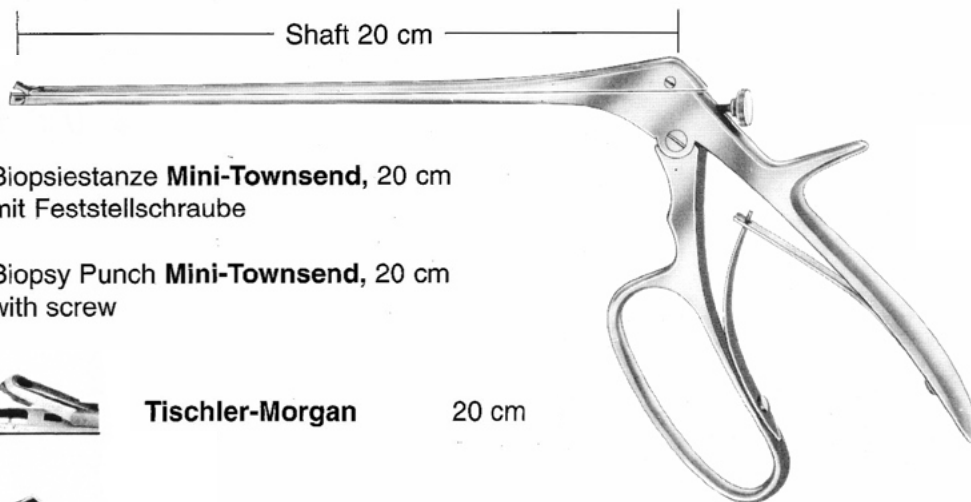
Biopsie Punch, 20 - 25 cm
turnable, with Townsend-Handle

118.25



25 cm

Townsend Griff ohne Aufsatz
Townsend Handle without top



Shaft 20 cm

Biopsiestanze **Mini-Townsend**, 20 cm
mit Feststellschraube

Biopsy Punch **Mini-Townsend**, 20 cm
with screw

121.20



Tischler-Morgan 20 cm

122.20



Mini Townsend 20 cm

124.20

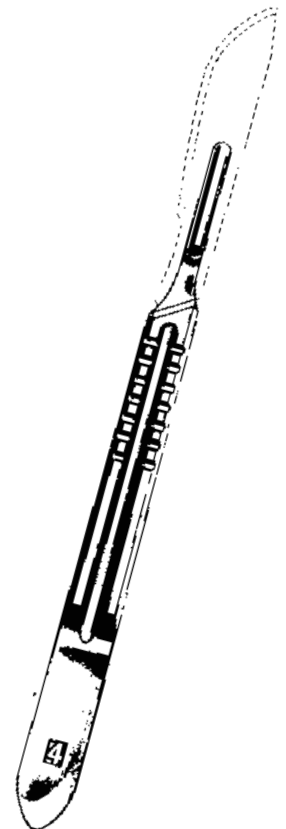
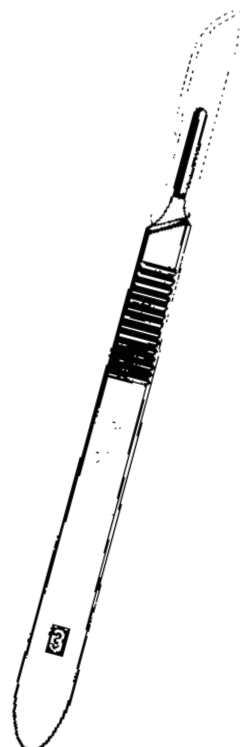


Kevorkian 20 cm

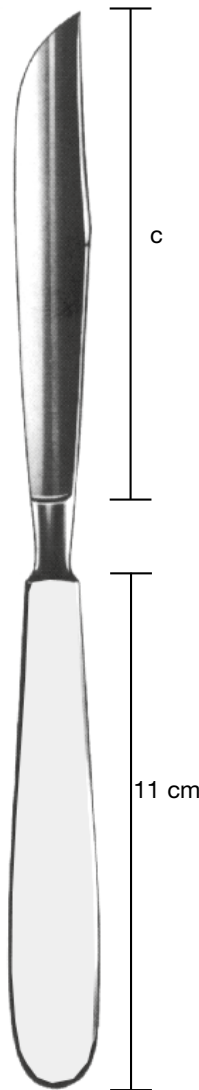
MATTES

Sezier-, Hirn- und Organmesser
Autopsy- Brain- and Post mortem knives
Cuchillos para autopsia- cerebro- órganos
Coltelli per cartilagini- cervello e autopsia

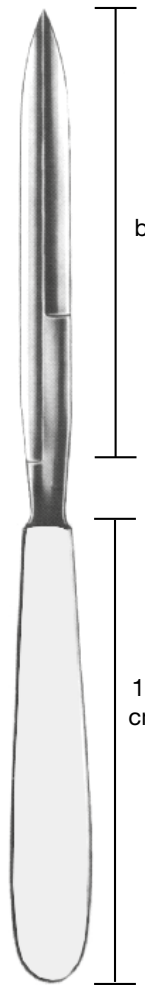
SKALPELLGRIFFE, KLINGEN
SCALPELL HANDLES, BLADES
MANCHES DE BISOURIES, LAMES
MANGOS DE BISTURIES, HOJAS DE BISTURIES
MANICI PER BISTURI, LAMI STERILE



AMPUTATIONSMESSER
 AMPUTATION KNIVES
 CUCHILLOS PARA AMPUTACIÓN
 COLTELLI PER AMPUTAZIONE

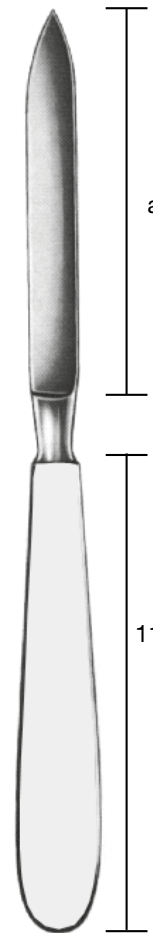


Langenbeck
1065.12



1067.11

Zwischenknochen-
messer doppel-
schneidig
Inerosseous knife
double aftingedeges
Cuchillo interóseo
filo doble
Coltello interosseo
filo doppio



1068.09

Phalangen-
messer
Phalangeal knife
Cuchillos para
falanges
Coltello per falangi

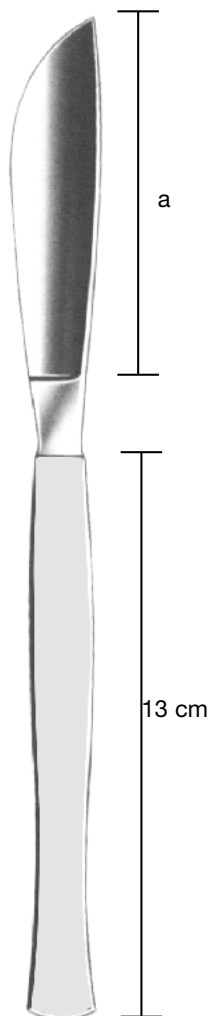
Schnittlänge
 Length of blades
 Largo de hojas
 Lunghezze delle lame

a - 9,5 cm c - 12,0 cm e - 15,0 cm g - 17,0 cm i - 20,0 cm
 b - 11,0 cm d - 13,0 cm f - 16,0 cm h - 19,0 cm j - 22,0 cm

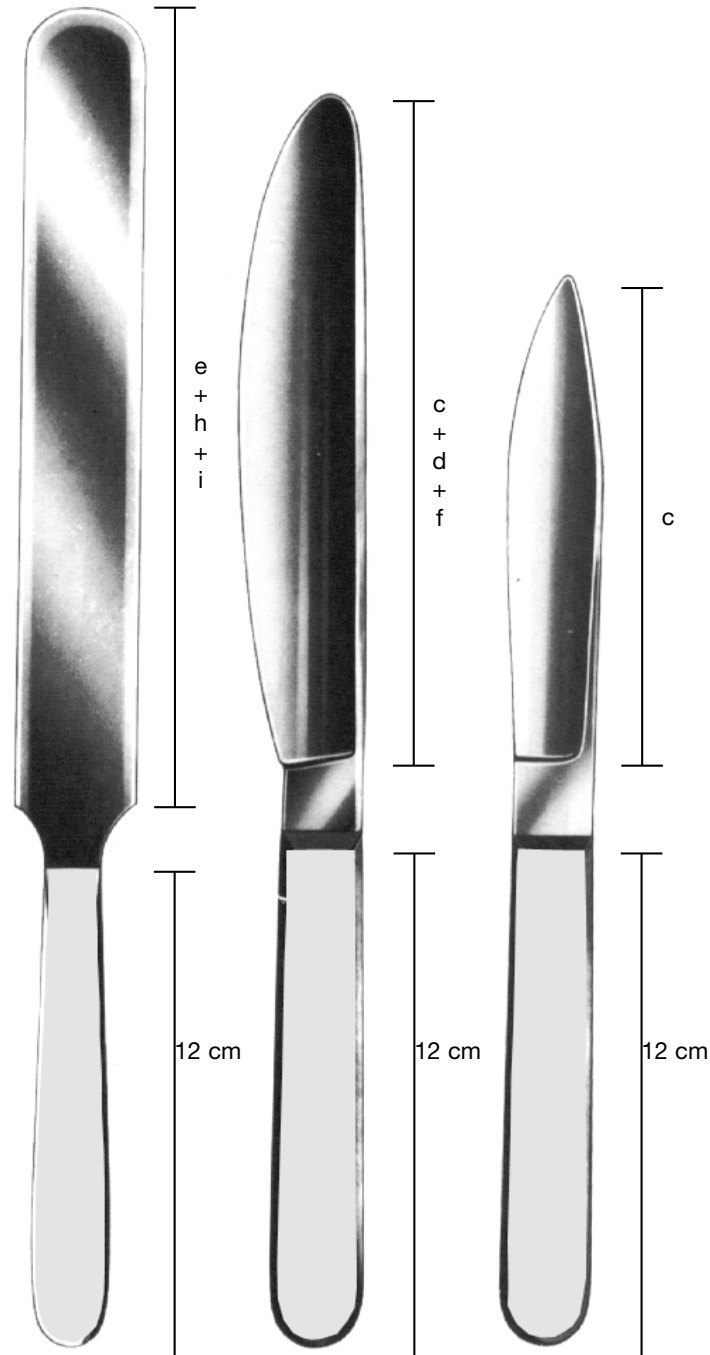
SEZIER-, HIRN- UND ORGANMESSER
 AUTOPSY- BRAIN- AND POST MORTEM KNIVES
 CUCHILLOS PAR AUTOPSIA- CEREBRO- ÓRGANOS
 COLTELLI PER CARTILAGINI- CERVELLO E AUTOPSIA

Schnittlänge
 Length of blades
 Largo de hojas
 Lunghezze delle lame

- a - 8,5 cm
- b - 9,5 cm
- c - 11,0 cm
- d - 14,0 cm
- e - 16,0 cm
- f - 17,0 cm
- g - 19,5 cm
- h - 20,0 cm
- i - 24,0 cm



Virchow
1070.08



Virchow
1920.16
1920.20
1920.24

1074.11
1074.14
1074.17

1075.11

ALLGEMEINE CHIRURGIE
GENERAL SURGERY
CHIRURGIE GÉNÉRALE
CIRUGÍA GENERAL
CHIRURGIA GENERALE

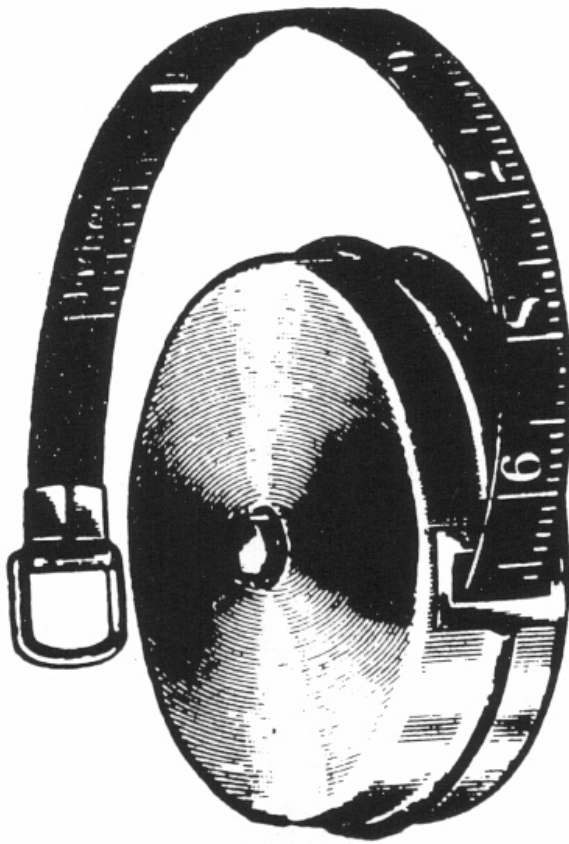
Resektionsmesser
Resection knives
Couteaux à résection
Cuchillos p. resección
Coltelli per resezione



Langenbeck
1102.05

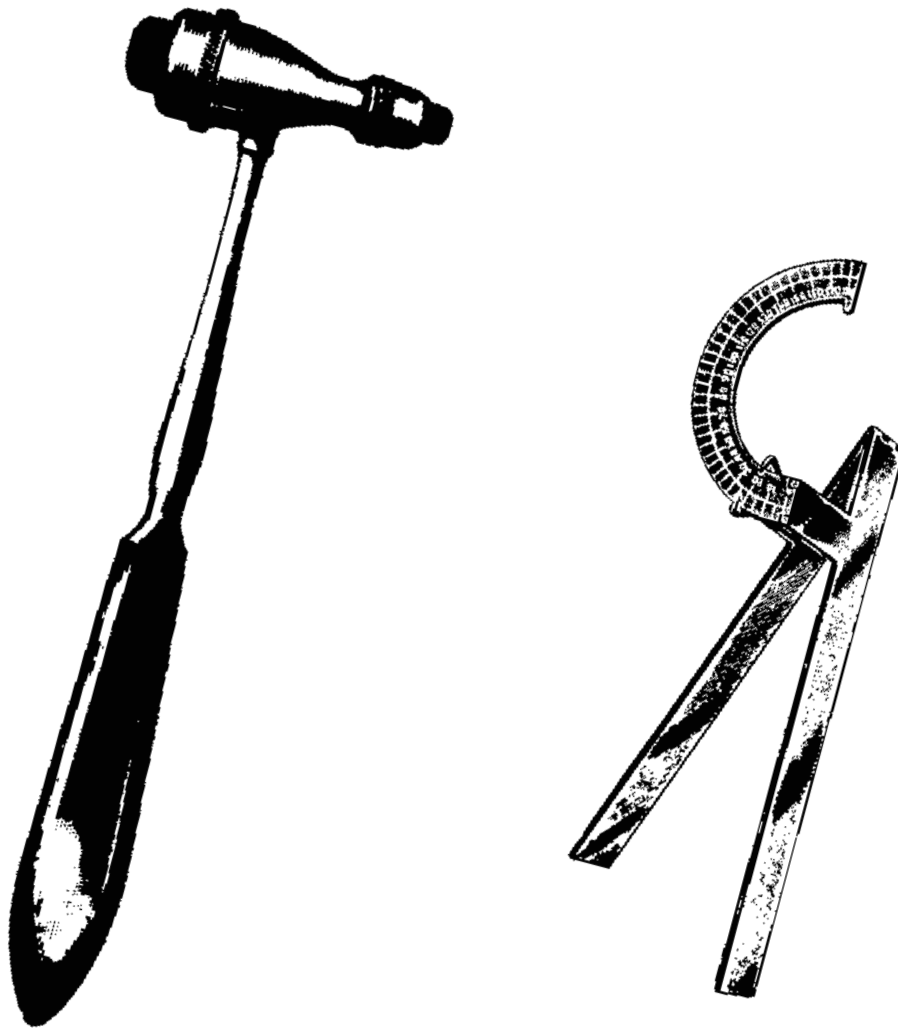
cm = Klingenlänge
Longuer of blade

1,8 Meter



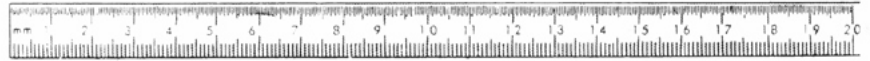
3693.15	Leinen - Linen
3694.15	Stahl - Steel

DIAGNOSTIK

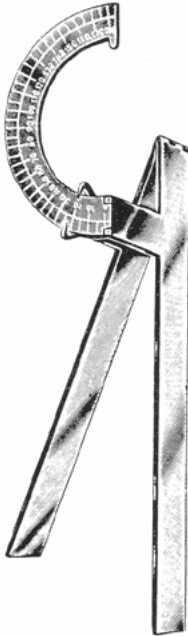


MATTES

DIAGNOSTIK
DIAGNOSTICS
DIAGNOSTICO
DIAGNOSTICA



Meßinstrumente - Measuring-Instruments



Möltgen
3691.00



Wartenberg
3692.00

Metall

3699.15	15 cm	6"
3699.20	20 cm	8"
3699.30	30 cm	12"
3699.50	50 cm	20"

Stethoskope



aus Holz
all wood
de bois
de madera
3697.00

aus Aluminium
all aluminium
en aluminium
de aluminio
3698.00

Pinard

**KNOPFSONDEN - ÖHRSONDEN
PROBES - DIRECTORS
STYLETS - SONDES
SONDAS - ESTILETES
SONDE - SPECILLI**



2,0 mm Ø 1000.11
 2,0 mm Ø 1000.13
 2,0 mm Ø 1000.14
 2,0 mm Ø 1000.16
 2,0 mm Ø 1000.20
 2,0 mm Ø 1000.25
 1,5 mm Ø 1001.14
 1,0 mm Ø 1002.14
 2,0 mm Ø 1000.18
 2,0 mm Ø 1000.30

1010.11
 1010.13
 1010.14
 1010.16
 1010.20
 1010.25

Stacke
 1005.10
 10,5 cm

Nelaton
 1006.16
 16 cm

1030.11
 1030.13
 1030.14
 1030.16

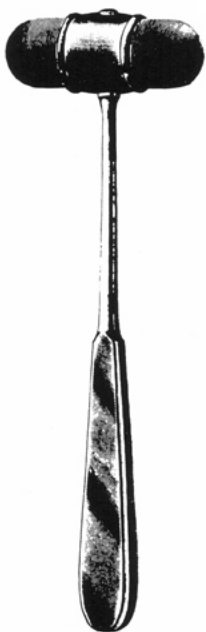
Fish
 1007.14
 1007.18

1050.13
 1050.14
 1050.16

Doyen
 1008.14
 14 cm

1060.11
 1060.13
 1060.14
 1060.16
 1060.20
 1060.18

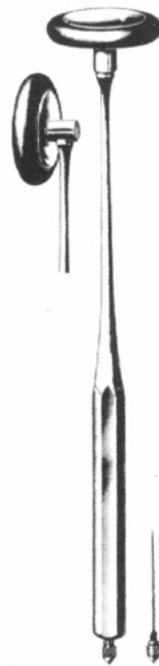
**PERKUSSIONSHÄMMER
PERCUSSION HAMMERS
MARTILLOS DE PERCUSSION
MARTELLI PERCUSSORI**



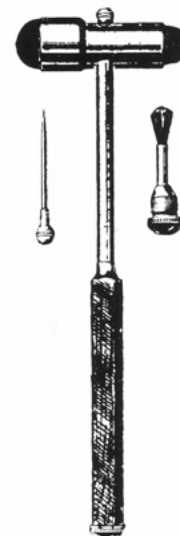
Dejerine
 20 cm/8"
 1200.20



Taylor - USA Mod.
 1211.17
 1211.20



Babinsky
 1212.22



Buck
 18cm/7"
 1230.18



1250.03
 Gummi
 allein
 klein
 oder
 groß
 p. Stück

Trömner
 1250.24
 24 cm/9 1/2"

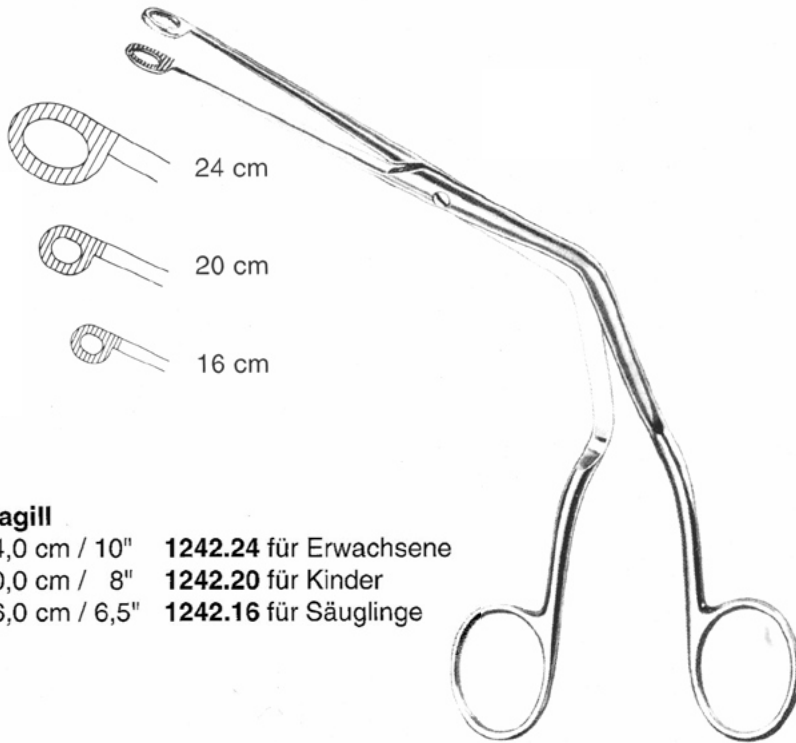


Band allein
1122.92

Spiegel allein
112191

Ziegler
1120.90

ASPIRATION, ANAESTHESIE
 ASPIRATION, ANESTHESIA
 ASPIRATION, ANESTHÉSIE
 ASPIRACIÓN, ANESTESIA
 ASPIRAZIONE, ANESTESIA



Magill
 24,0 cm / 10" **1242.24** für Erwachsene
 20,0 cm / 8" **1242.20** für Kinder
 16,0 cm / 6,5" **1242.16** für Säuglinge

Schärfe im Griff



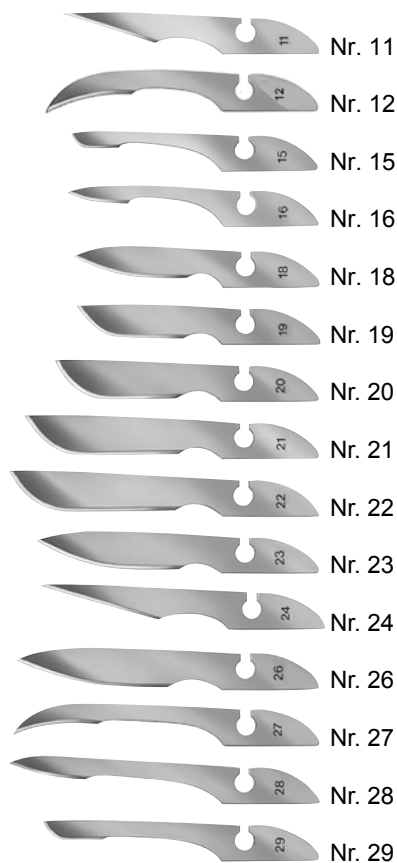
BAYHA® Skalpelle
mit auswechselbaren
Klingen

BAYHA® Klingenformen

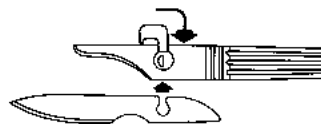
- Klingen aus Kohlenstoffstahl, einzeln verpackt
- 1 Verpackungseinheit (VE) = 144 Stk. (12 Dtzd.)
- sterile Klingen in medizinischer Spezialfolie
- unsterile Klingen in Papierfolie

Vorteile:

- alle Klingenformen passen in jeden BAYHA-Griff
- bewährtes Riegelsystem für festen Sitz der Klinge im Griff
- seitliche Einführung der Klinge in den Griff
- Sicher in der Handhabung



Ideal – das bewährte BAYHA-Riegelsystem



1. Riegel nach oben stellen,
Klinge ist lose.

BAYHA® Sicherheitsklingen



Nr. 240*

ohne Spitze

Nr. 18R*

runde Spitze

*nur in unsteriler Ausführung lieferbar

C. Bruno Bayha GmbH
Dr. Karl-Storz-Straße 14
D-78532 Tuttlingen
Tel. +49 (0)7461/8711
Fax +49 (0)7461/4944
Mail: info@bayha-skalpelle.de
Internet: www.bayha-skalpelle.de



BAYHA® Griffe

- aus Edelstahl, rostfrei
- passend für alle Klingenformen



Fig. 1
13 cm



Fig. 2
13 cm



Fig. 3
20 cm



Fig. 4
16 cm



Fig. 5
15 cm



Fig. 6
16 cm

ergonomische Griffschale
Griff 6 ist nicht für sterile Aufbereitung geeignet

BAYHA® Schutzkappe

- passend für alle BAYHA-Skalpellgriffe

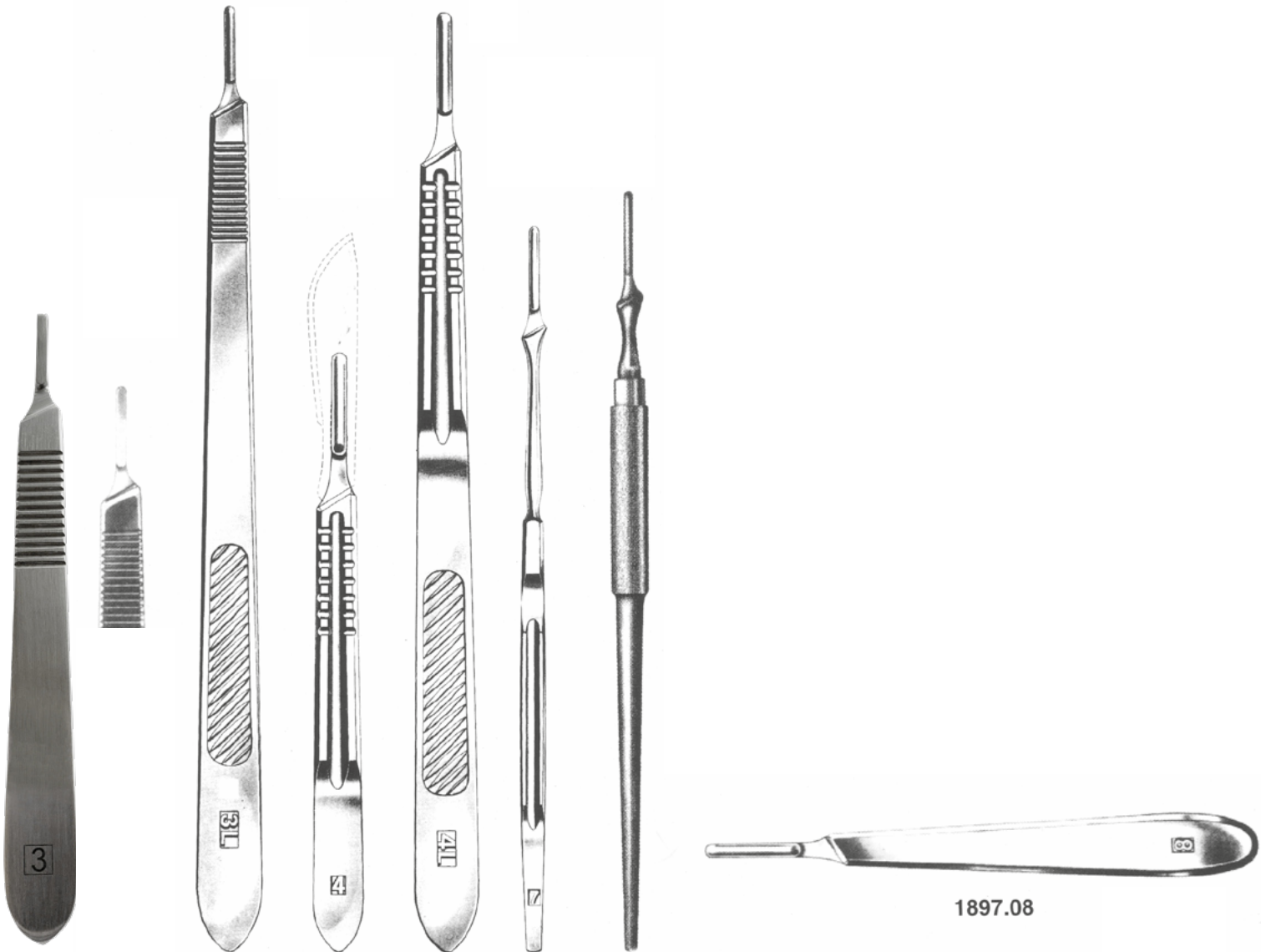


nicht für sterile Aufbereitung geeignet

MATTES

SKALPELLGRIFFE, KLINGEN
 SCALPELL HANDLES, BLADES
 MANCHES DE BISOURIES, LAMES
 MANGOS DE BISTURIES, HOJAS DE BISTURIES RIES
 MANICI PER BISTURI. LAMI STERILE

Skalpellklingen
 Auf Anfrage



1880.03 1879.08 1885.31 1890.04 1894.41 1895.07 1896.03 R 1897.08

MATTES

SKALPELLE MIT METALLHEFT
 SCALPELS WITH METAL HANDLE
 BISTURIÉS, MANGO METÁLICO
 BISTURI, MANICO DI METALLO



17 cm



Fig. 1
1903.01



Fig. 2
1903.02

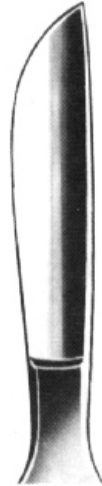


Fig. 3
1903.03



Fig. 4
1903.04



Fig. 5
1903.05



Fig. 6
1903.06



Fig. 7
1903.07



Fig. 8
1903.08



Fig. 9
1903.09

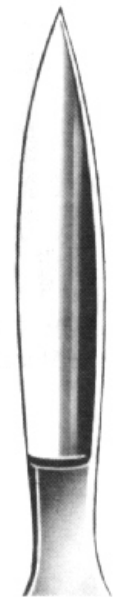
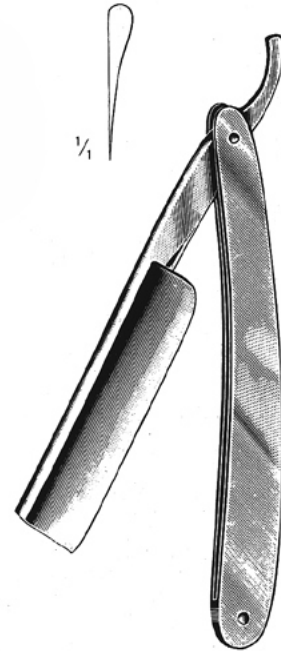


Fig. 10
1903.10

KLINGENBRECHER, RASIERKLINGEN
 BLADE BREAKERS, RAZOR BLADES
 CASSE-LAMES, RASOIRS
 ROMPE-HOJAS, HOJAS DE AFEITAR
 PINZE ROMPE-LAMETTE, LAMETTE

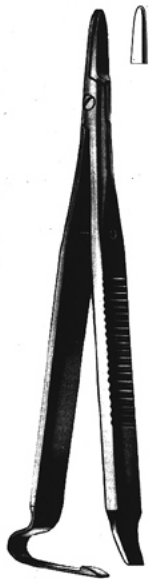


Rasiermesser
 Razor
 Rasoir
 Navaja
 Rasoio

1916.00



1905.12
 Troutman
 9 cm

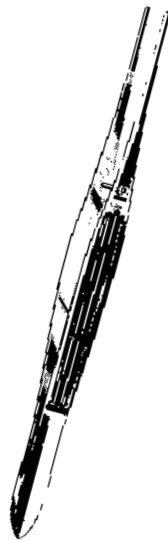


1910.11
 11 cm



1915.13
 Castroviejo
 13 cm

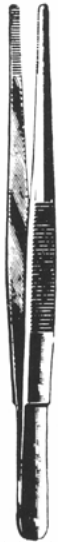
PINZETTEN FORCEPS
PINCES
PINZAS
PINZE



MATTES

**PINZETTEN
THUMB FORCEPS
PINCES À DISSECTION
PINZAS DE DISECCIÓN
PINZE PER DISSEZIONE**

Standard



- 9,0 cm 2000.09
- 10,5 cm/4¼" 2000.10
- 11,5 cm/4½" 2000.11
- 13,0 cm/5" 2000.13
- 14,5 cm/5½" 2000.14
- 16,0 cm/6¼" 2000.16
- 18,0 cm/7" 2000.18
- 20,0 cm/8" 2000.20
- 25,0 cm/10" 2000.25
- 30,0 cm/12" 2000.30

schmal
narrow
strette



- 2010.10
- 2010.11
- 2010.13
- 2010.14
- 2010.16
- 2010.18
- 2010.20
- 2010.25
- 2010.30



- Modell USA**
- 2020.13
 - 2020.14
 - 2020.18
 - 2020.20

schmal
narrow
estrechas
étroit



- Modell USA**
- 2030.13
 - 2030.14



- Adson 15 cm 2040.15**
- 12,5 cm 2040.13
 - Micro 2041.13



micro



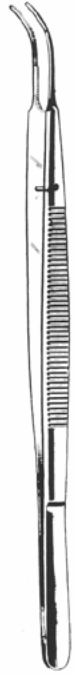
- Mc Indoe**
- 2045.15
 - 15,0 cm



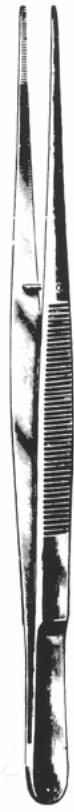
- Semken**
- 12,5 cm 2050.12
 - 15,0 cm 2050.15
 - 20,0 cm 2050.20



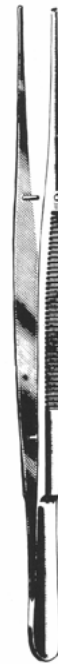
- Gerald**
- 18,0 cm 2060.18



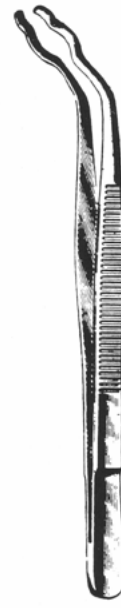
- Gerald**
- 18,0 cm 2070.18



- Potts-Smith**
- 18 cm 2080.18
 - 21 cm 2080.21
 - 25 cm 2080.25



- Taylor**
- 17 cm 2090.17

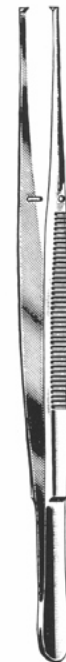
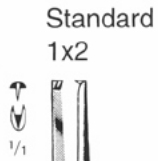


- Sterilisier**
- 16,0 cm 2095.16
 - 20,0 cm 2095.20
 - 24,0 cm 2095.24



- Feilchenfeld**
- 7,5 cm 2098.07
 - 9,0 cm 2098.09
 - 11,5 cm 2098.11

CHIRURGISCHE PINZETTEN
TISSUE FORCEPS
PINCES À DISSECTION À GIFFES
PINZAS DE DISECCIÓN CON DIENTES
PINZE CHIRURGICHE



- 10,5 cm/4 1/4" **2100.10**
- 11,5 cm/4 1/2" **2100.11**
- 13,0 cm/5" **2100.13**
- 14,5 cm/5 1/2" **2100.14**
- 16,0 cm/6 1/4" **2100.16**
- 18,0 cm/7" **2100.18**
- 20,0 cm/8" **2100.20**
- 25,0 cm/10" **2100.25**
- 30,0 cm/12" **2100.30**

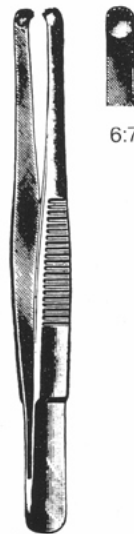
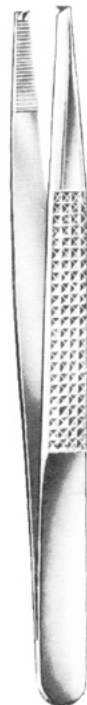
- 2110.13**
- 2110.14**
- 2110.18**

- 2120.13**
- 2120.14**
- 2120.16**

- Adson**
 12,5 cm **2130.13**
 micro **2131.13**
2131.15

- schmal
 narrow
2105.13
2105.14
2105.16
2105.18
2105.20
2105.25

- Adson Brown**
 12,0 cm **2140.12**
- Semken**
2142.12
2142.15



- 15,0 cm/6" **2150.15**
- 20,0 cm/8" **2150.20**
- 25,0 cm/12" **2150.25**

- Russian**
2150.15
2150.20
2150.25

- Gillies**
2155.15
 15,0 cm

- Potts Smith**
 18,0 cm **2160.18**
 21,0 cm **2160.21**
 25,0 cm **2160.25**

- Bonney**
2162.18
 18,0 cm

- Durante**
 14,5 cm **2175.14**
 16,0 cm **2175.16**
 20,0 cm **2175.20**

- Gerald**
 17,0 cm **2180.17**

- Gerald**
 17,0 cm **2190.17**

MATTES

CHIRURGISCHE PINZETTEN, FASSPINZETTEN
 TISSUE FORCEPS
 PINZAS DE DISECCIÓN, CON DIENTES
 PINZE PER DISSEZIONE, CHIRURGICHE



Nelson
 2165.15
 2165.18
 2165.23



Lane
 2166.14
 14,5 cm



Lane
 2167.14
 14,5 cm



Duval
 2168.14
 14,5 cm



USA
 2170.13
 2170.14
 2170.16



2x3
 2171.16
 2171.18



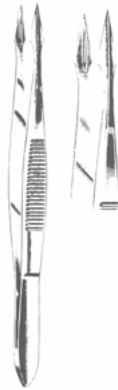
Taylor
 2172.18

1x2
 mit Dissektorende
 with dissector end
 avec extrémité
 servant de rugine
 con extremo raspa

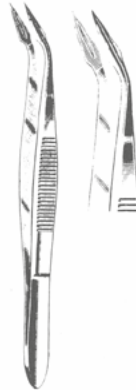
SPLITTERPINZETTEN, -ZANGEN
 SPLINTER FORCEPS
 PINCES À ÉCHARDES
 PINZAS PARA ESPINAS
 PINZE PER SCHEGGE



2091.12
 12,0 cm



Hunter
 2096.10
 10,0 cm



Hunter
 2097.10
 10,0 cm



2099.11
 2099.13



Tröltsch
 2195.12
 2195.18
 12,5 cm



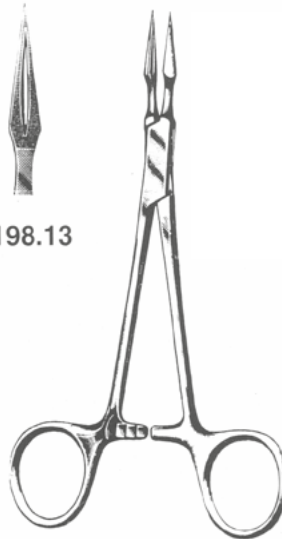
Lucae
 2196.14
 14,5 cm



Lucae
 2197.16
 16,0 cm
 2197.20
 20,0 cm



2198.13



Stieglitz
 13,5 cm



2173.11
 11,5 cm

MATTES

SPLITTERPINZETTEN, -ZANGEN
SPLINTER FORCEPS
PINCES À ÉCHARDES
PINZAS PARA ESPINAS
PINZE PER SCHEGGE

Zeckenpinzette

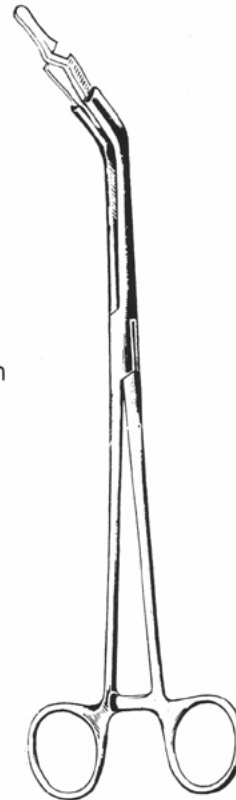
gerade
straight
retta



gebogen
curved
curvas

John Hopkins

51 mm	2220.51	2222.51
70 mm	2220.70	2222.70
75 mm	2220.75	2222.75
90 mm	2220.90	2222.90



2229.23
23 cm



9 cm
2245.09



2245.09-2

Uhrmacherpinzetten



No. 1
12 cm/4¾"
2240.01



No. 4
11 cm/4¼"
2240.04



No. 5
11 cm/4¼"
2240.05



No. 7
11,5 cm/4½"
2240.07

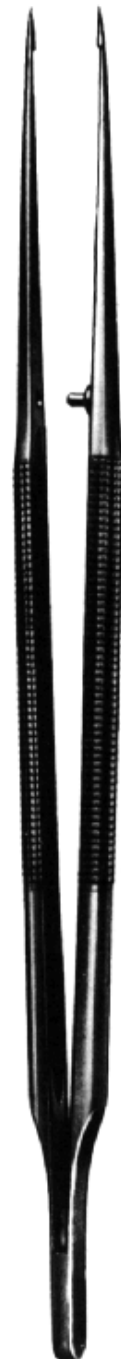


Dieffenbach gerade
3,5 cm **2230.04**
5,0 cm **2230.05**



gebogen
2235.04
2235.05

MIKROCHIRURGIE-PINZETTEN
MICROSURGERY FORCEPS
PINZAS PARA MICROCIURUGÍA
PINZE PER MICROCHIRURGIA



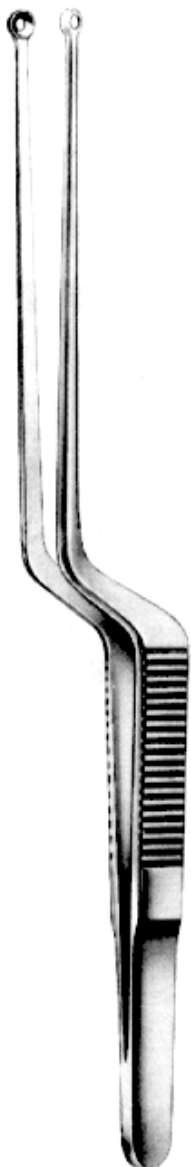
2246.18
18 cm



2247.18
18 cm

MATTES

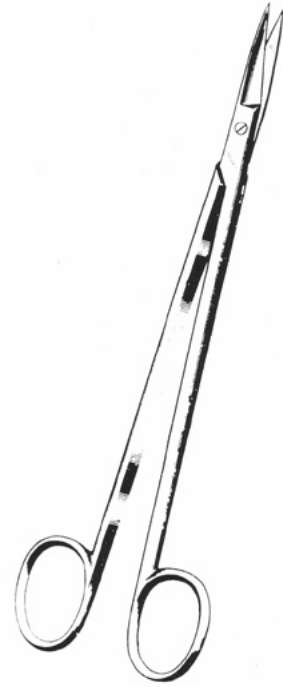
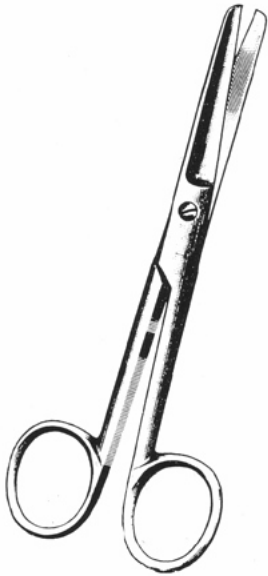
TUMORPINZETTEN
TUMOR FORCEPS
PINZAS PARA TUMORES
PINZE PER TUMORI



2272.22
ø 5 mm

Yasargil
2272.22
22 cm

CHIRURGISCHE SCHEREN
OPERATING SCISSORS
CISEAUX À CHIRURGIE
TIJERAS PARA CIRURGÍA
FORBICI PER CHIRURGIA



MATTES

CHIRURGISCHE SCHEREN
OPERATING SCISSORS
CISEAUX À CHIRURGIE
TIJERAS PARA CIRURGÍA
FORBICI PER CHIRURGIA

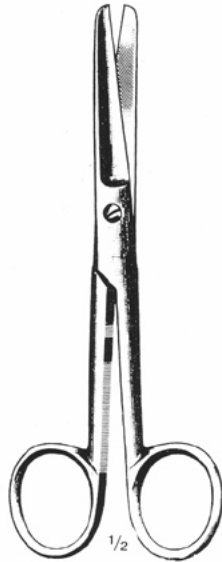


Fig. 1



Fig. 2



Fig. 3

Standard Modell
gerade - rectas
straight - droits

11,5 cm/4½"	3000.11	3010.11	3020.11
13,0 cm/5"	3000.13	3010.13	3020.13
14,5 cm/5½"	3000.14	3010.14	3020.14
15,5 cm/6"	3000.15	3010.15	3020.15
16,5 cm/6½"	3000.16	3010.16	3020.16
18,5 cm/7¼"	3000.18	3010.18	3020.18
20,0 cm/8"	3000.20	3010.20	3020.20



Fig. 1



Fig. 2

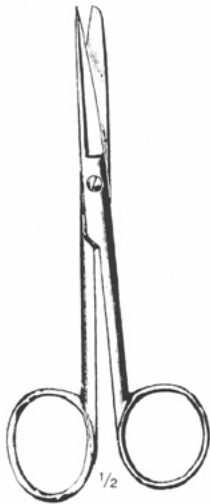


Fig. 3

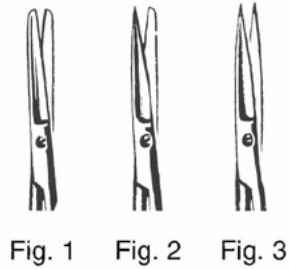
Standard Modell
gebogen - curvas
curved - courbes
curve

11,5 cm/4½"	3035.11	3045.11	3055.11
13,0 cm/5"	3035.13	3045.13	3055.13
14,5 cm/5½"	3035.14	3045.14	3055.14
15,5 cm/6"	3035.15	3045.15	3055.15
16,5 cm/6½"	3035.16	3045.16	3055.16
18,5 cm/7¼"	3035.18	3045.18	3055.18
20,0 cm/8"	3035.20	3045.20	3055.20

**CHIRURGISCHE SCHEREN
OPERATING SCISSORS
CISEAUX À CHIRURGIE
TIJERAS PARA CIRURGIÁ
FORBICI PER CHIRURGIA**

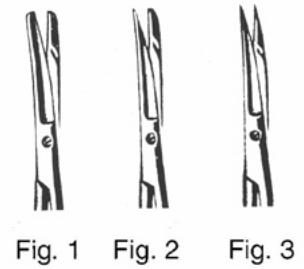
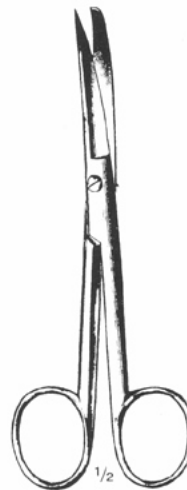


13,5 cm/4"
14,5 cm/5½"



Grazil
gerade - rectas
straight - droits
rette

3090.14 3100.14 3110.14

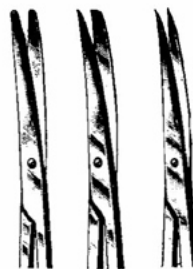


Grazil
gebogen - curvas
curved - courbes - curve

3115.14 3125.14 3135.13
3135.14



gerade - straight - droits



1 2 3
Metzenbaum

14,5 cm/5½"
18,0 cm/7"
20,0 cm/8"
23,0 cm/9"
25,0 cm/10"
30,0 cm/12"



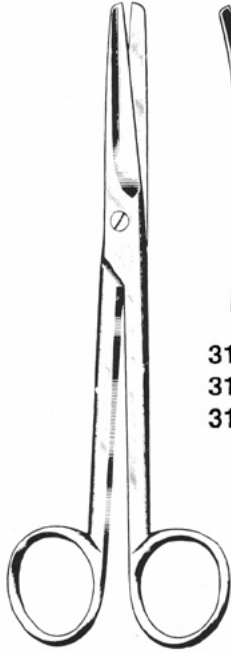
gebogen - curved - curvas

Fig. 1	Fig. 2	Fig. 3
3150.14	3160.14	3170.14
3150.18	3160.18	3170.18
3150.20	3160.20	3170.20
3150.23	3160.23	3170.23
3150.25	3160.25	
3150.30	3160.30	

Fig. 1	Fig. 2	Fig. 3
3155.14	3165.14	3175.14
3155.18	3165.18	3175.18
3155.20	3165.20	3175.20
3155.23	3165.23	3175.23
3155.25	3165.25	3175.25
3155.30	3165.30	3175.30

MATTES

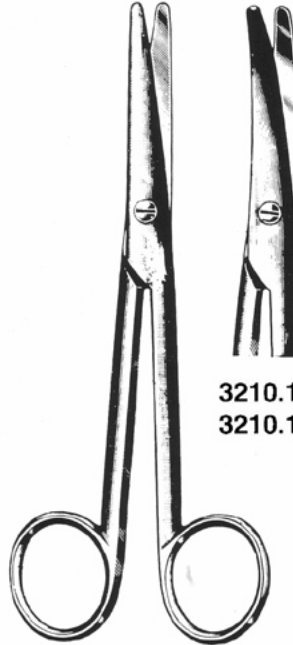
CHIRURGISCHE SCHEREN
OPERATING SCISSORS
CISEAUX À CHIRURGIE
TIJERAS PARA CIRURGÍA
FORBICI PER CHIRURGIA



3190.14
3190.17
3190.23

Mayo

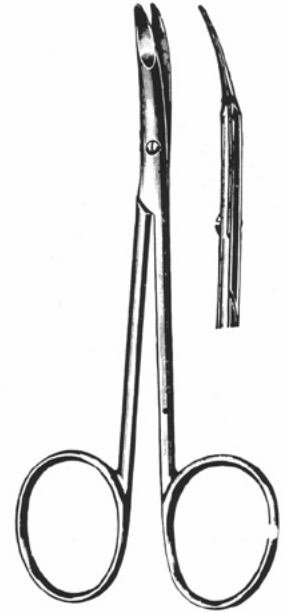
14,5 cm/5½" **3180.14**
17,0 cm/6¾" **3180.17**
23,0 cm/9" **3180.23**



3210.15
3210.17

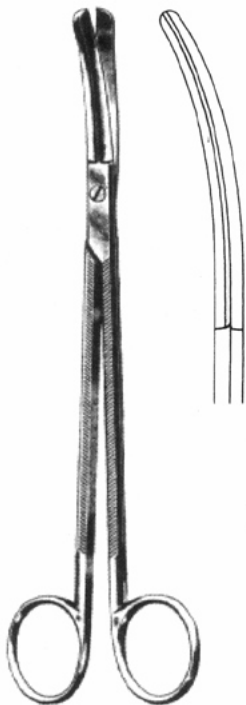
Mayo Stille

3200.15
3200.17

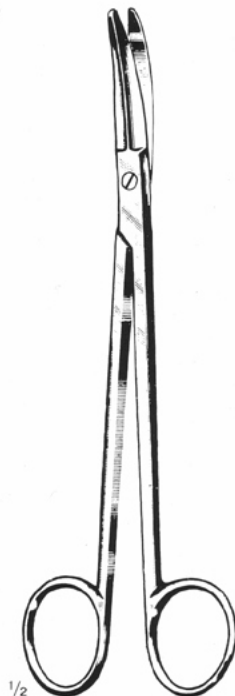


Ragnell Killner

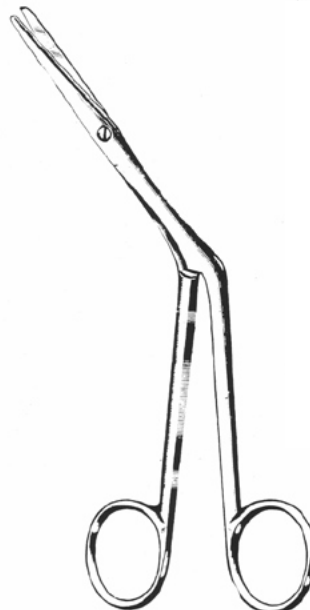
12,0 cm **3220.12**
15,0 cm **3220.15**



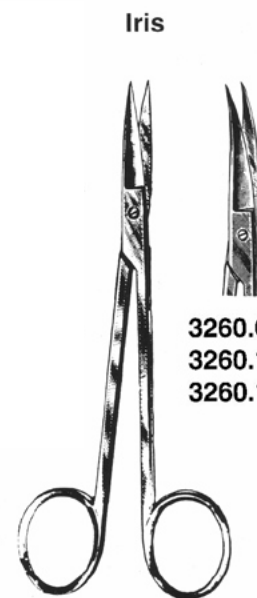
Good
3229.19 19 cm



Boettcher
18,0 cm **3230.18**



Heymann
18,0 cm **3240.18**



Iris

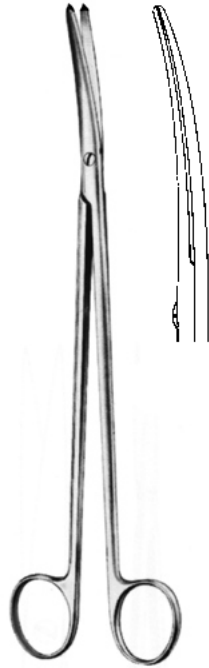
3260.09
3260.10
3260.11

9,0 cm **3250.09**
10,0 cm **3250.10**
11,5 cm **3250.11**

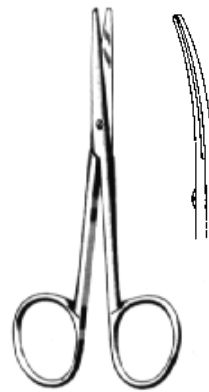
PRÄPARIERSCHEREN
DISSECTING SCISSORS
TIJERAS DE DISECCIÓN
FORBICI PER DISSEZIONE



Metzenbaum fino
3242.15 15 cm
3242.18 18 cm
3242.20 20 cm
3242.23 23 cm
3242.25 25 cm
3242.28 28 cm



Metzenbaum fino
3243.15 15 cm
3243.18 18 cm
3243.20 20 cm
3243.23 23 cm
3243.25 25 cm
3243.28 28 cm



Lexer Baby
3244.10 10 cm 3245.10

SCHEREN, OPHTHALMOLOGIE
SCISSORS, OPHTHALMOLOGY
TIJERAS, OFTALMOLOGÍA
FORBICI, PER OFTALMOLOGIA

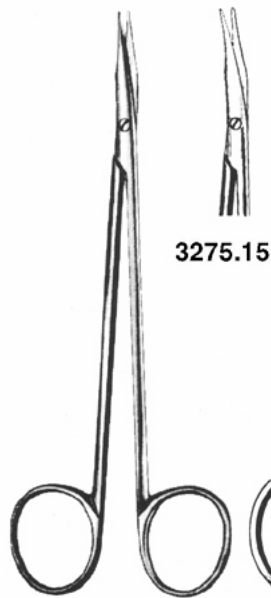


10 cm

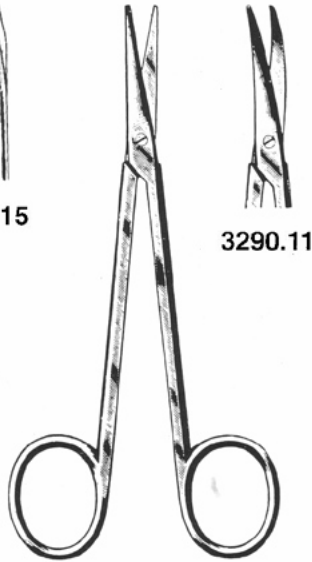
gerade	gebogen
straight	curved
rectas	curvas
retta	curva
3247.10	3248.10

MATTES

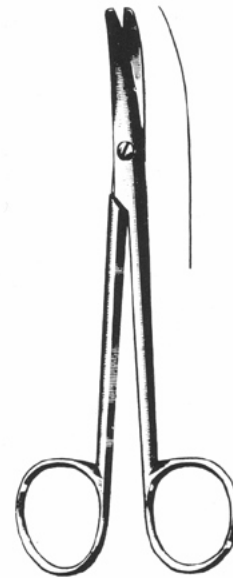
PRÄPARIERSCHEREN - STRABISMUSSCHEREN - ENUKLEATIONSCHEREN
 DISSECTING SCISSORS - STRABISMUS SCISSORS - ENUCLEATION SCISSORS
 TIJERAS P/DISECCION - TIJERAS P/ESTRABISMO - TIJERAS P/ENUCLEACIÓN



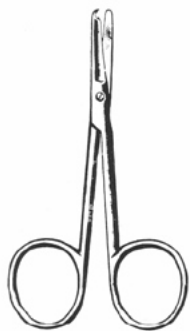
Reynolds
3270.15



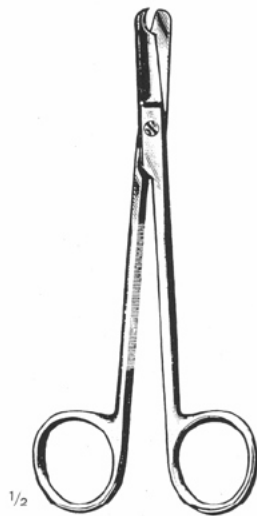
Strabismus
3280.11



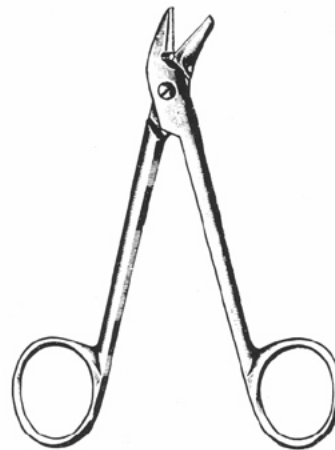
leicht
gebogen
3300.11



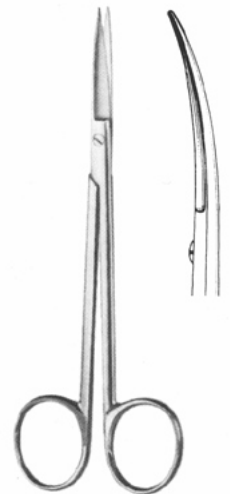
Spencer
9,0 cm 3320.09
13,0 cm 3320.13



Littauer
14,0 cm 3330.14

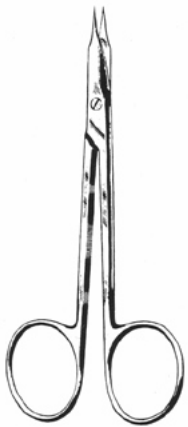


Universal
12,0 cm 3340.12
gezahnt - saw edge - dentada



Joseph
3331.14 14 cm 3332.14

**ZAHNFLEISCHSCHEREN
GUM SCISSORS
CISEAUX À GENCIVES
TIJERAS PARA ENCÍAS
FORBICI GINGIVALI**



Stevens 11,0 cm



**fig. 1
3341.01**



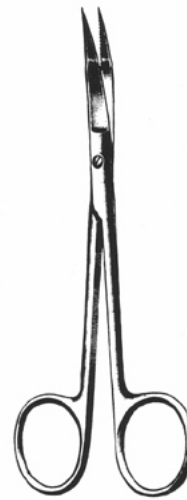
**fig. 2
3341.02**



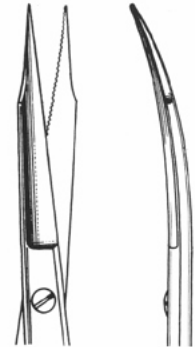
**fig. 3
3341.03**



**fig. 4
3341.04**



**3342.13
gerade
straight**

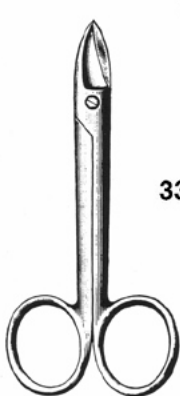


**Goldman-Fox
3343.13
gebogen
curved**

**DARMSCHEREN
ENTEROTOMY SCISSORS
CISEAUX À ENTÉROTOMIE
ENTERÓTOMOS
FORBICI PER ENTEROTOMIA**



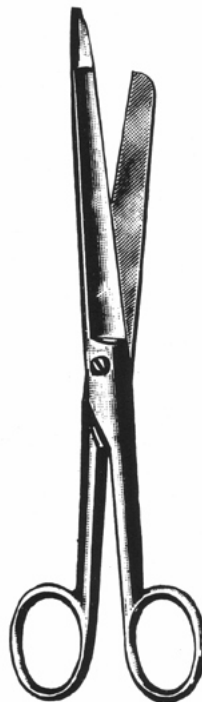
**Fomon
3349.15
15 cm**



**Beebee
3344.10**



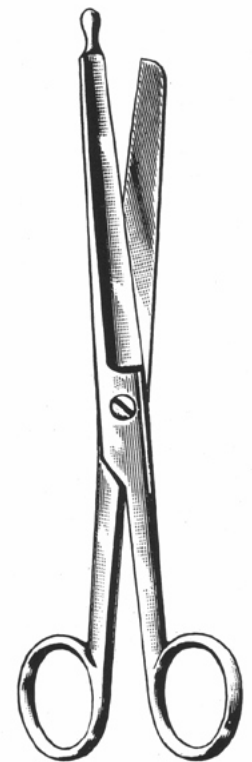
3345.10



3346.21



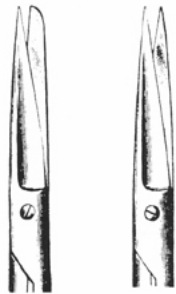
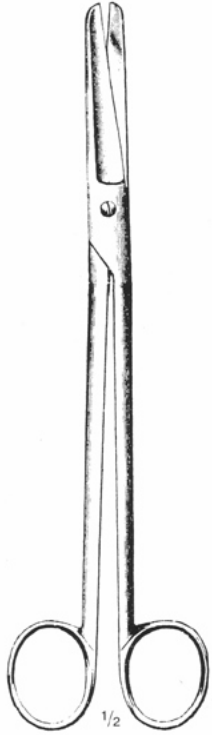
3347.21



3348.21

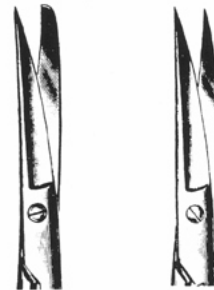
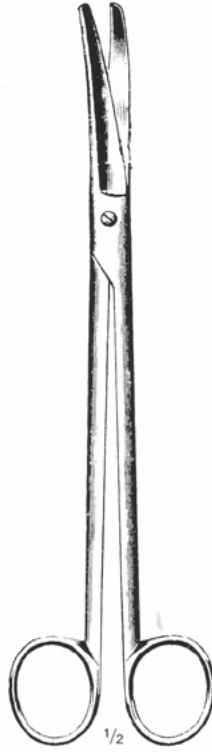
MATTES

**GYNÄKOLOGISCHE SCHEREN
GYNÆCOLOGICAL SCISSORS
CISEAUX GYNÉCOLOGIQUES
TIJERAS GINECOLÓGICAS
FORBICI GINECOLOGICHE**



gerade
droite - rectas
straight - rette

3360.20 3370.20
3360.23 3370.23



gebogen - curved
courbes - curvas -
curve

3365.20 3375.20
3365.23

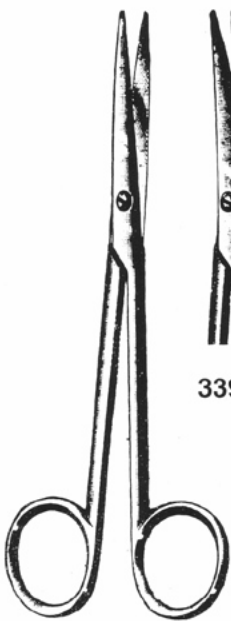
Sims

20,0 cm 3350.20
23,0 cm 3350.23

Sims

20,0 cm 3350.20
23,0 cm 3350.23

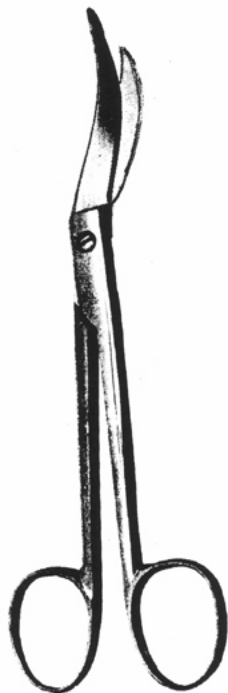
**Fistelscheren
Fistula Scissors
Tijeras p/fistulas**



3395.16

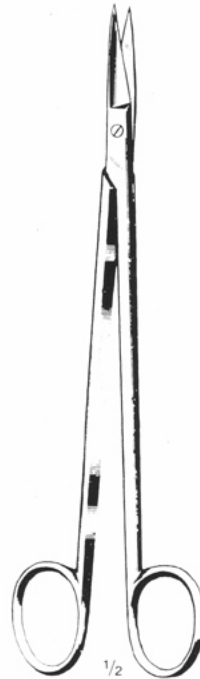
Lexer

16,0 cm 3390.16



Waldmann

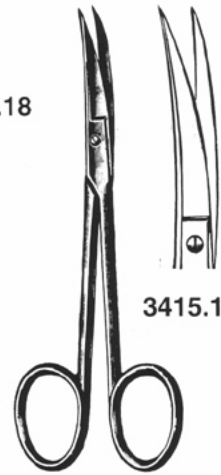
18,0 cm 3395.18



3405.18

Kelly

18,0 cm 3400.18

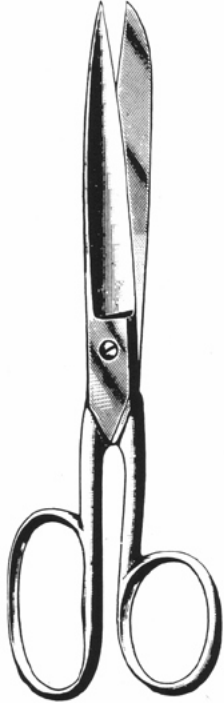


3415.12

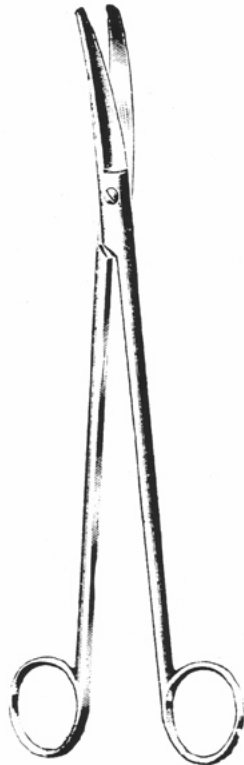
Wagner

12,5 cm 3410.12

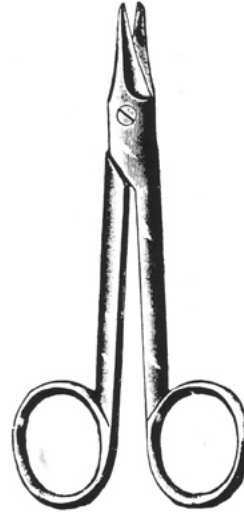
SCHEREN
TIJERAS
SCISSORS
FORBICI



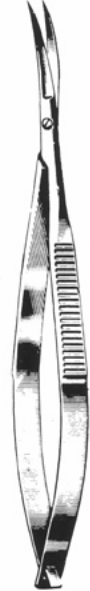
Smith U.S.
18,0 cm/7" 3420.18
20,0 cm/8" 3420.20
23,0 cm/9" 3420.23



Wertheim
19,0 cm 3430.19
22,0 cm 3430.22

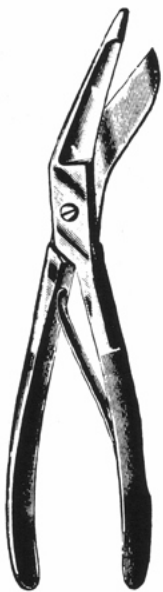


Sistrunk
13,0 cm 3440.13

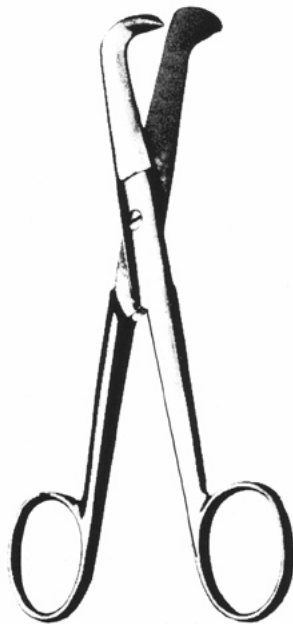


Westcott
11,0 cm 3450.11

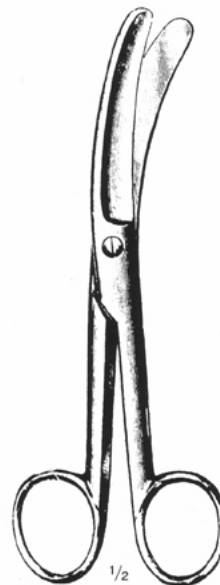
Nabelschnur Scheren - Umbilical Scissors



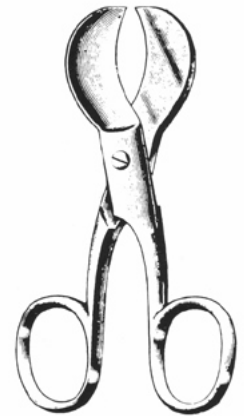
Seutin
23,0 cm 3460.23



Schumacher
16,0 cm 3470.16



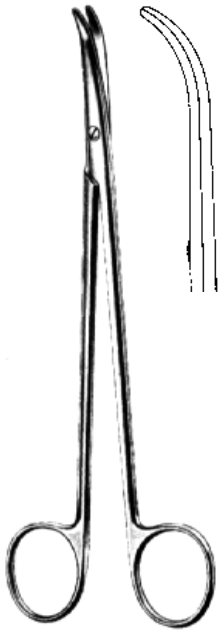
Busch
16,0 cm 3480.16



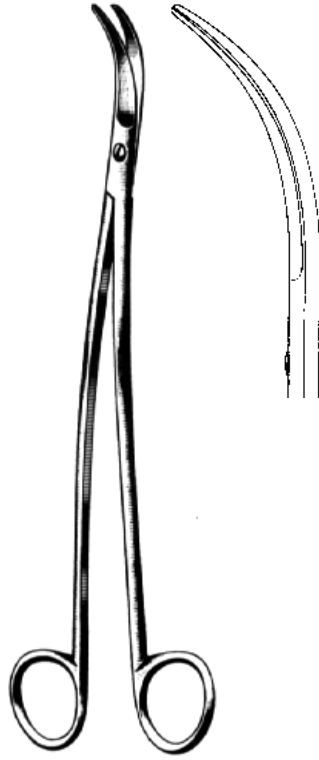
U.S. Pattern
10,0 cm 3490.10

MATTES

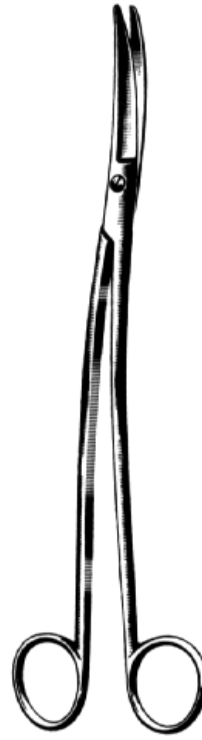
CHIRURGISCHE SCHEREN
OPERATING SCISSORS
TIJERAS PARA CIRUGÍA
FORBICI PER CHIRURGIA



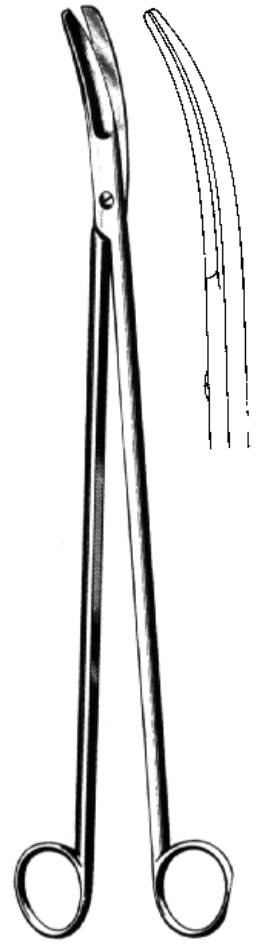
Thorek
3481.19 19 cm
3481.25 25 cm



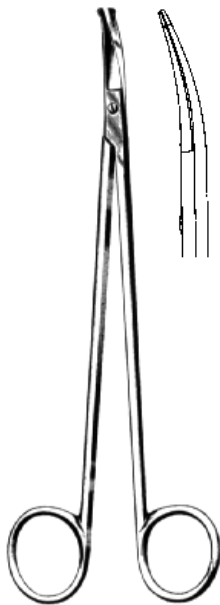
Satinsky
3482.24 24 cm



Klinkenbergh-Lot
3483.23 23 cm



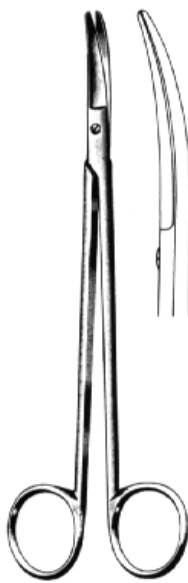
Crafoord
3484.30 30 cm



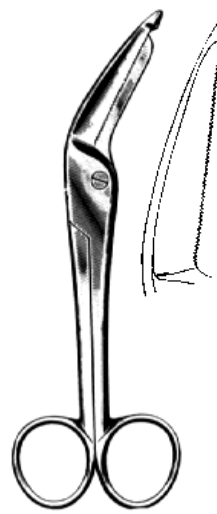
Strully
3485.22
22 cm



Toennis-Adson
3486.18
18 cm



Toennis-Adson
3486.17
18,5 cm



Excenter
3487.16 16 cm
3487.19 19 cm
gezahnt
toothed
dentadas



McIndoe
3488.19
19 cm



Fomon
3489.13
13 cm

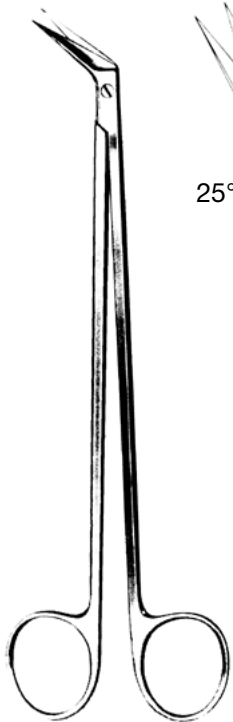
TONSILLEN-, GEFÄSSSCHEREN
 TONSIL, VASCULAR SCISSORS
 TIJERAS, AMÍGDALAS Y VASCULARES
 FORBICI PER TONSILLI E VASCOLARI



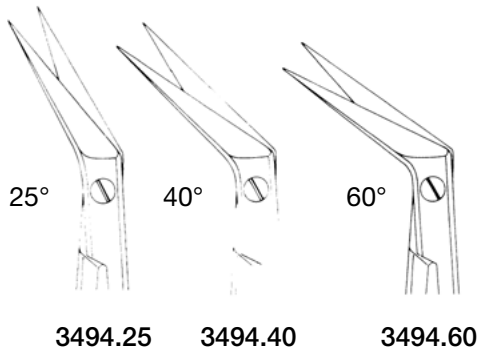
Cottle
 3491.16 16 cm



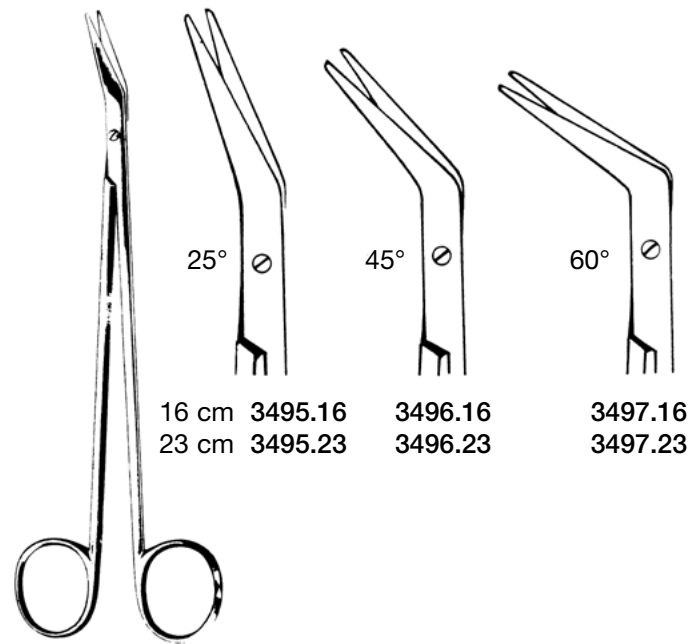
Dean
 3492.17 17 cm
 gezahnt
 toothed



Potts-Smith
 19 cm



3494.25 3494.40 3494.60

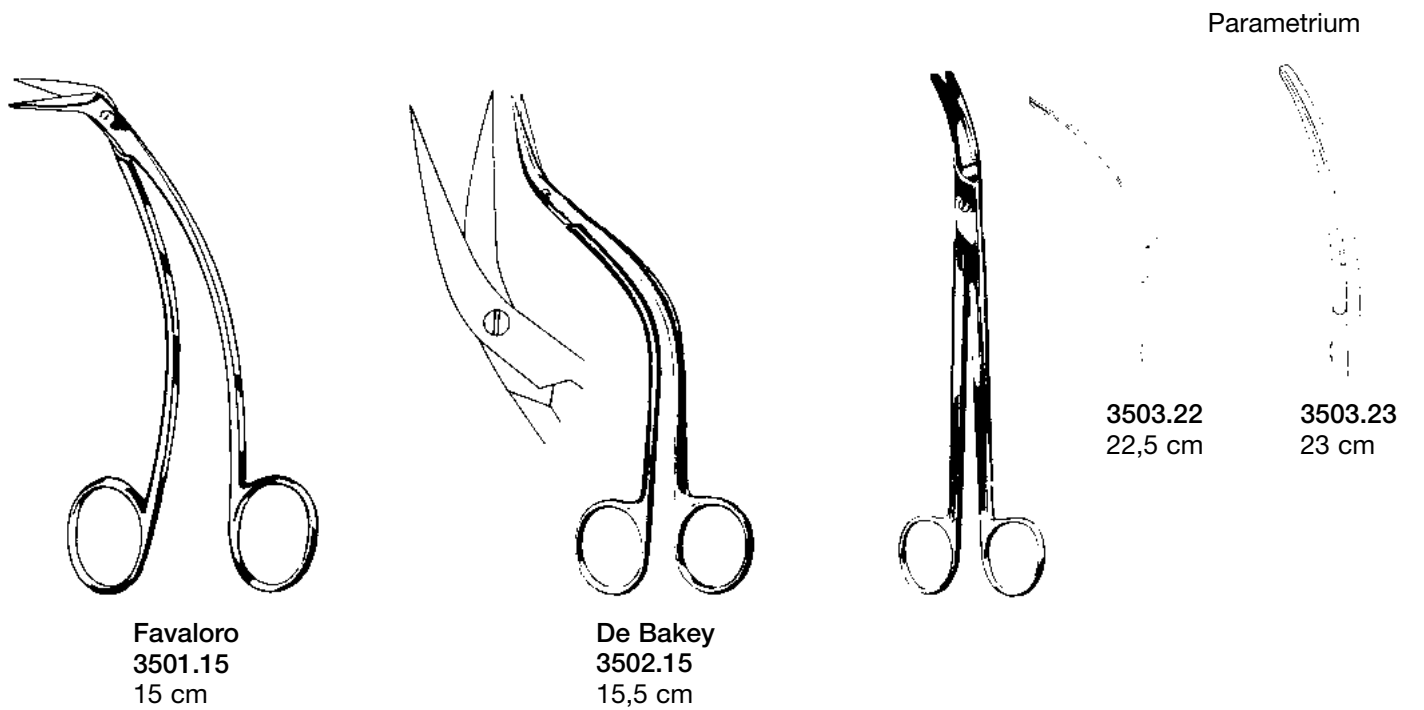
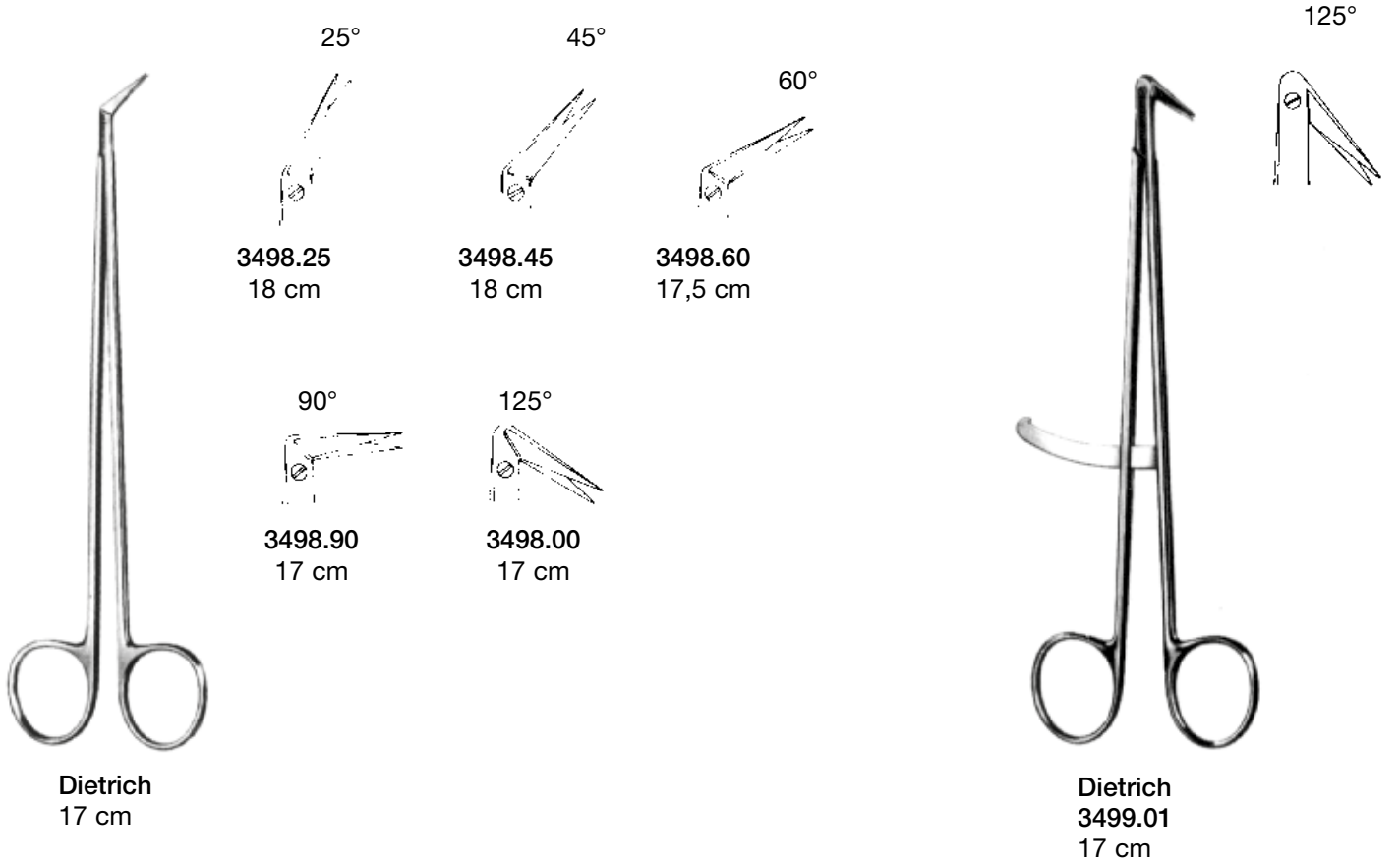


De Bakey

25° 45° 60°
 16 cm 3495.16 3496.16 3497.16
 23 cm 3495.23 3496.23 3497.23

MATTES

SCHEREN, THORAX UND GEFÄSSE
 SCISSORS, THORAX AND VASCULAR
 TIJERAS, TORÁCICAS Y VASCULARES
 FORBICI VASCOLARI E TORACICHE



MATTES

MIKRO-SCHEREN
MICRO-SCISSORS
MICRO-TIJERAS
MICRO-FORBICI



Mikro-Scheren
bajonett



3506.22

22,5 cm



3507.22



3508.18

18,5 cm



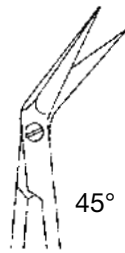
3509.18

MIKRO-SCHEREN
MICRO-SCISSORS
MICRO-TIJERAS
MICRO-FORBICI



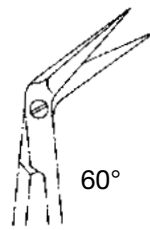
25°

3513.25



45°

3513.45



60°

3513.60

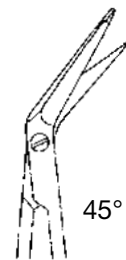


18 cm



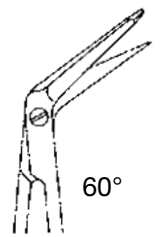
25°

3514.25



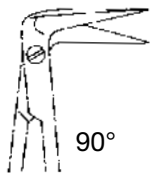
45°

3514.45



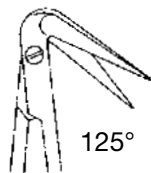
60°

3514.60



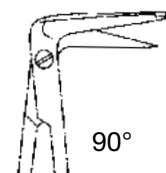
90°

3513.90



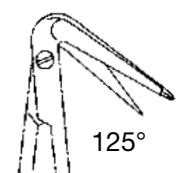
125°

3513.00



90°

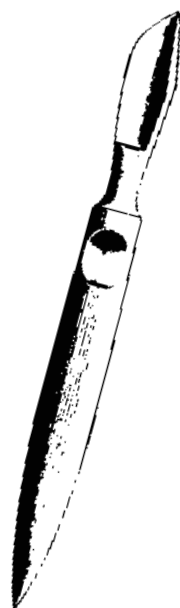
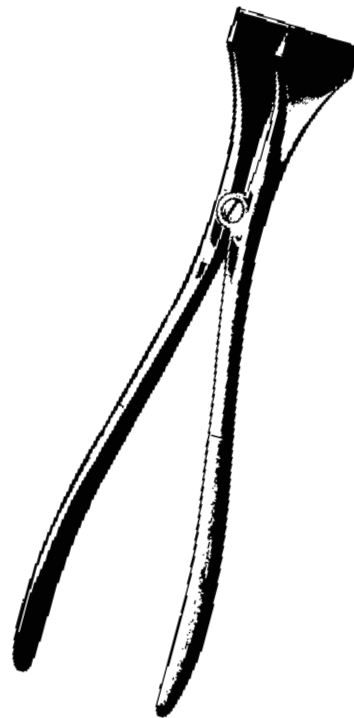
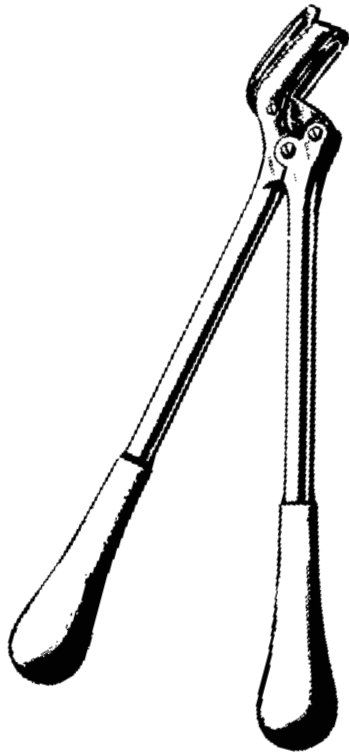
3514.90



125°

3514.00

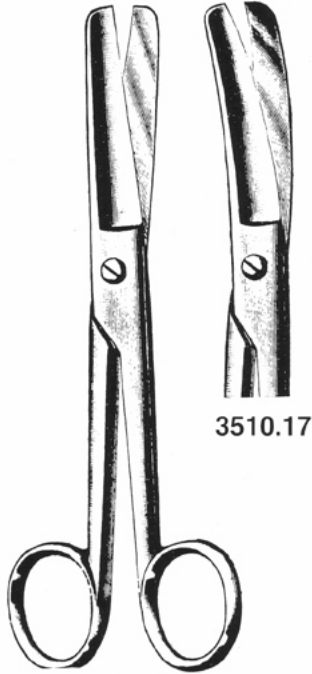
GIPSSPREIZER, GIPSMESSER, GIPSABREISSZANGEN
PLASTER CAST INSTRUMENTS, KNIVES
INSTRUMENTOS PARA VENDAJES ENYESADOS, CUCHILLIOS
STRUMENTI P. APPARECCHI GESSATI, COLTELLI



MATTES

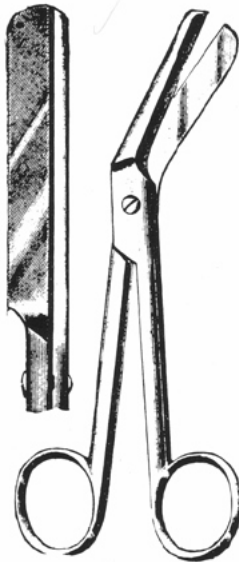
VERBAND-SCHEREN
BANDAGE SCISSORS
CISEAUX À BANDAGES
TIJERAS PARA VENDAJES
FORBICI PER BENDAGGI

Episiotomie - Episiotomy - Episiotomia

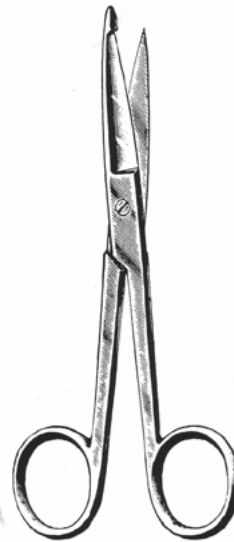


3510.17

Doyen
17,5 cm 3500.17



Braun Stadler
14,5 cm 3520.14
21,0 cm 3520.21



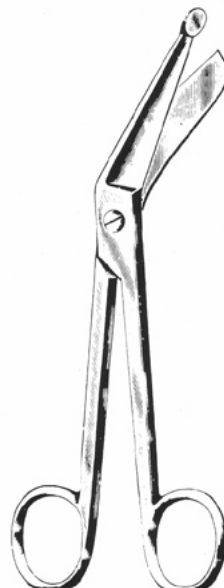
Knowles
14,5 cm 3530.14



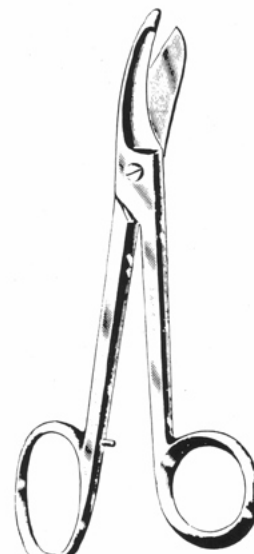
Lister
11,0 cm 3550.11
14,5 cm 3550.14
16,0 cm 3550.16
18,0 cm 3550.18
20,0 cm 3550.20



Esmarch
20,0 cm 3560.20
22,0 cm 3560.22



Bergmann
23,0 cm 3570.23



Bruns
24,0 cm 3580.24
gezahnt, toothed
3585.24



20,0 cm 3590.20

3550.14L Linkshänder
3550.18L Linkshänder

PLASTER SAW „ELECTRONIC POWER”


Volt	
110	3591.11 EP
230	3591.23 EP

Säge kompl. – Saw complete		
Ø		Typ – Saw only
50	3592.50	normal
50	3593.50	Hart/hard/dure/dura
65	3592.65	normal
65	3593.65	Hart/hard/dure/dura

Plaster Saw „Electronic Power”	
Art.-No. 3591.23	Art.-No. 3591.11
230 V~, 50 Hz	110 V~, 60 Hz
Power 500 Watt	Power 500 Watt
6500-24000 oscillations, infinitely variable	6500-24000 oscillations, infinitely variable
5 meter cable with EURO-plug	3 meter cable with USA-plug
Plaster saw complete with carton 1 piece sawblade 3592.50 Ø 50 mm for normal plaster 1 piece sawblade 3592.65 Ø 65 mm for normal plaster 1 par wrenches 3594.02 for sawblade changing 1 piece instruction manual	
Optional (extra charges): Version in front, however with sawblades for synthetic dressings Convenient, practical, robust and pleasant form case for transport- and/or filing incl. inlay Identification plate service Sawblades in many different forms and coatings for varied employments	

- | | |
|------------------------------------------------------------------------------------------------------------------------------------------------------------------------------------------------------------------------------------------------------------------------------------------------------------------------------------------------------------------------------------------------------------------------------------------------------------------------------------------------------------------------------------------------------------------------------------------------------------------------------------------------------------------------|-----------------------------------------------------------------------------------------------------------------------------------------------------------------------------------------------------------------------------------------------------------------------------------------------------------------------------------------------------------------------------------------------------------------------------------------------------------------------------------------------------------------------|
| <ul style="list-style-type: none"> ✓ 500 Watt power ✓ 6500 bis 24000 oscillations, infinitely variable ✓ Fullautomatical power-compensation above the whole oscillations field ✓ Slim motor edition with silent motor 52 -77 dB(A) in relation to the selected oscillations ✓ Latest electronic system with various protection and security functions ✓ Special positioning of the motor, protected by plaster dust ✓ Robust construction for highest loading capacity by continuous operation ✓ Safety ON / OFF switch ✓ Weight only 1,25 kg without cable (1,5 kg with cable) | <ul style="list-style-type: none"> ✓ Vibrations- and maintenance-free ✓ Regulation from outside of the manual operating area ✓ 5 meter cable with EU-connection, 230 Volt version
or ✓ 3 meter cable with US-connection, 110 Volt version ✓ Double protection isolation according to class II, medical use of typ BF ✓ Radio and TV suppressed ✓ CE conformity ✓ EN 60601-1, EN 60601-1-2,
IEC 60601-1, IEC 60601-1-2 inspected |
|------------------------------------------------------------------------------------------------------------------------------------------------------------------------------------------------------------------------------------------------------------------------------------------------------------------------------------------------------------------------------------------------------------------------------------------------------------------------------------------------------------------------------------------------------------------------------------------------------------------------------------------------------------------------|-----------------------------------------------------------------------------------------------------------------------------------------------------------------------------------------------------------------------------------------------------------------------------------------------------------------------------------------------------------------------------------------------------------------------------------------------------------------------------------------------------------------------|

MATTES

VERBAND-SCHEREN
BANDAGE SCISSORS
CISEAUX À BANDAGES
TIJERAS PARA VENDAJES
FORBICI PER BENDAGGI



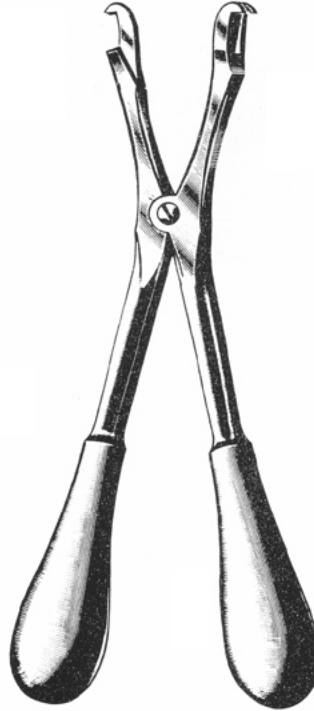
Stille

23,0 cm **3600.23**

26,0 cm **3600.26**

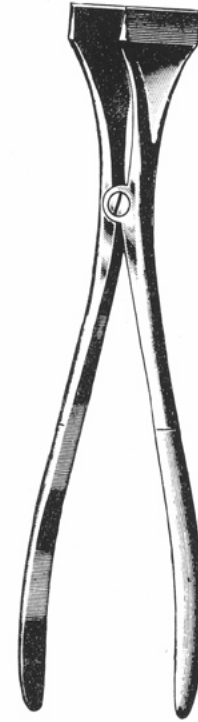
37,0 cm **3600.37**

m/verstärktem Rücken
reinforced back



Haglund

28,0 cm/11" **3630.28**



Hennig

28,0 cm/11" **3640.28**



Hopkins

3642.20 20 cm



Esmarch

18,0 cm

3650.18



Reiner

18,5 cm

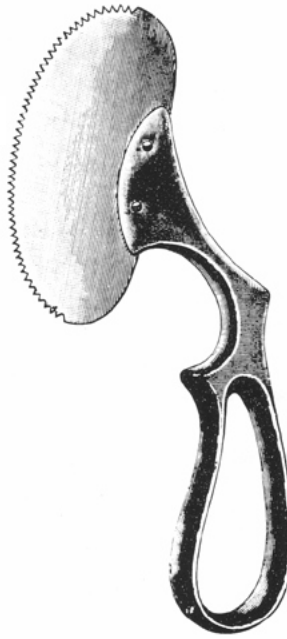
3660.18



Wolf

18,0 cm **3670.18**

24,0 cm **3670.24**



Engel

14,0 cm **3680.14**



Wigmore

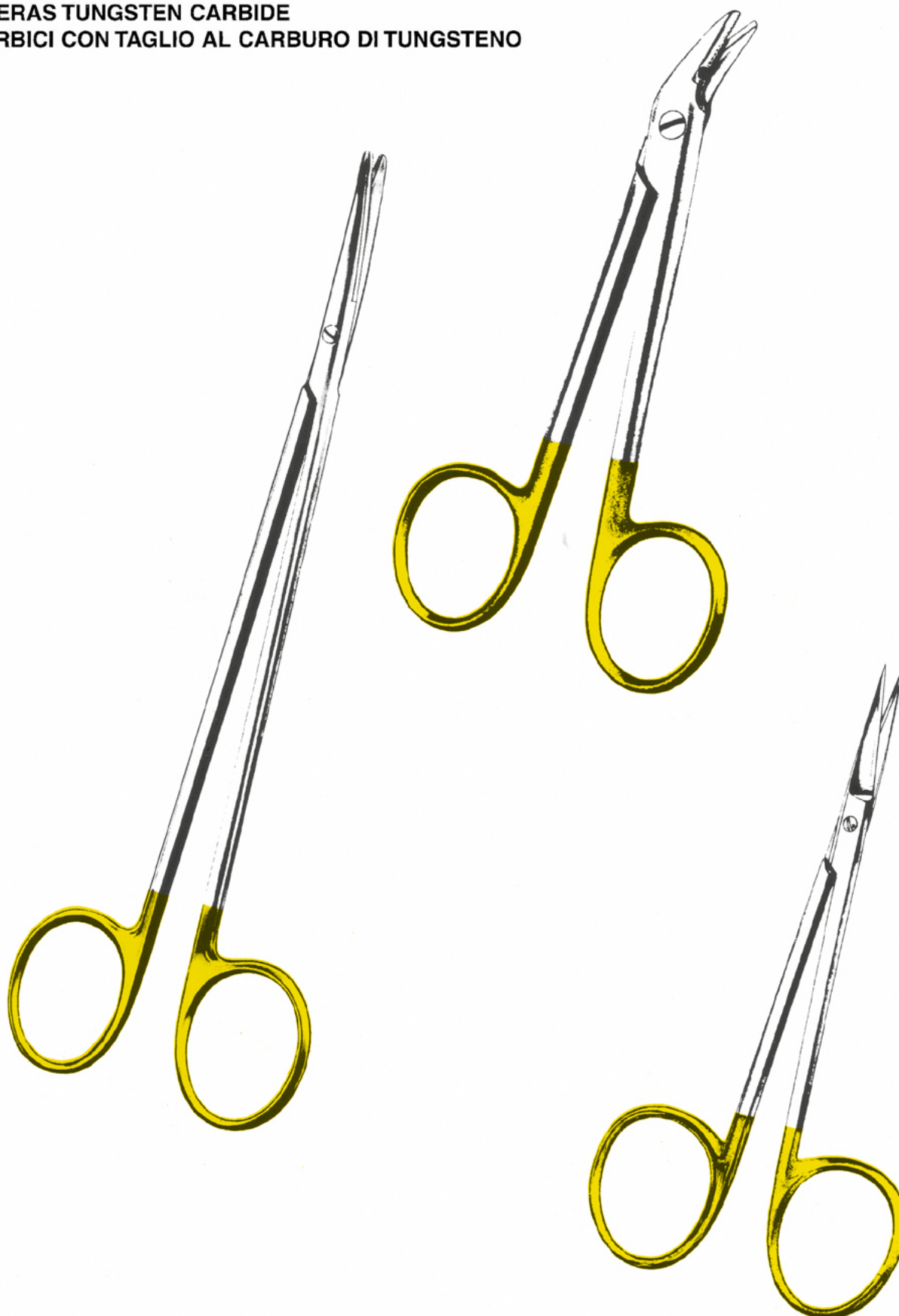
3641.23



Wigmore

3643.00

HARTMETALL-SCHEREN
SCISSORS TUNGSTEN CARBIDE JAWS
CISEAUX AVEC CARBURE DE TUNGSTÈNE
TIJERAS TUNGSTEN CARBIDE
FORBICI CON TAGLIO AL CARBURO DI TUNGSTENO

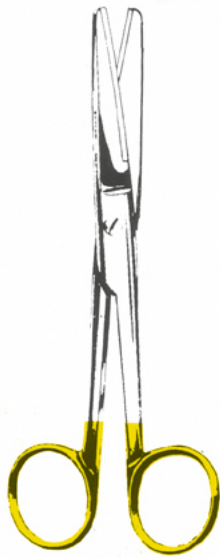


MATTES

HARTMETALL-SCHEREN
SCISSORS TUNGSTEN CARBIDE JAWS
CISEAUX AVEC CARBURE DE TUNGSTÈNE
TIJERAS TUNGSTEN CARBIDE
FORBICI CON TAGLIO AL CARBURO DI TUNGSTENO

gerade - droite - rette - straight

gebogen - curvas - courbes - curved



TC 3700.14



Fig. 2



Fig. 3



Fig. 1



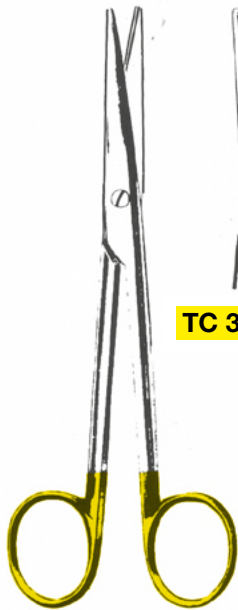
Fig. 2



Fig. 3

Standard

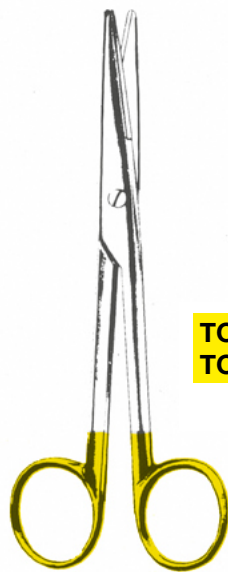
TC 3710.14 TC 3720.14 TC 3705.14 TC 3715.14 TC 3725.14



Mayo-Lexer
 16,0 cm **TC 3740.16**



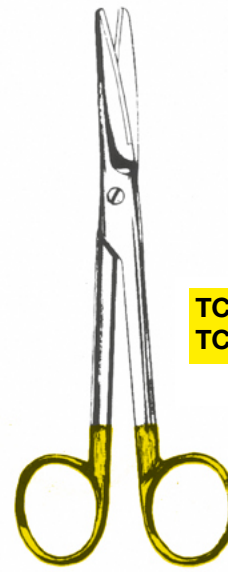
TC 3745.16



Mayo-Stille
 15,0 cm **TC 3750.15**
TC 3750.17



TC 3755.15
TC 3755.17



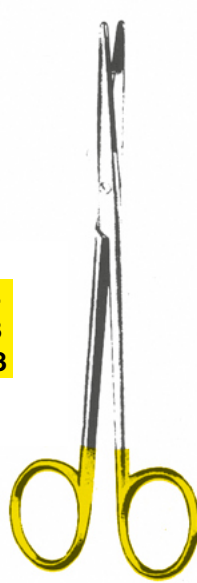
Mayo
 14,0 cm **TC 3760.14**
 17,0 cm **TC 3760.17**



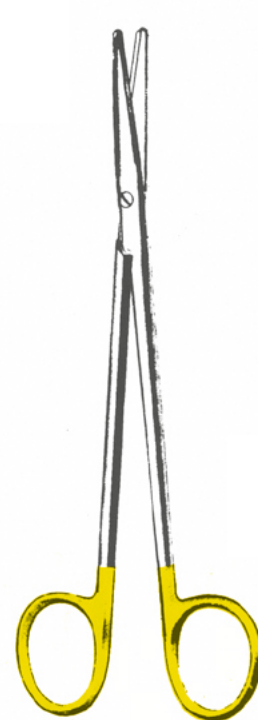
TC 3765.14
TC 3765.17

HARTMETALL-SCHEREN
SCISSORS TUNGSTEN CARBIDE JAWS
CISEAUX AVEC CARBURE DE TUNGSTÈNE
TIJERAS TUNGSTEN CARBIDE
FORBICI CON TAGLIO AL CARBURO DI TUNGSTENO

Metzenbaum-Fino
 14,5 cm **TC 3780.14**
 18,0 cm **TC 3780.18**
 23,0 cm **TC 3780.23**

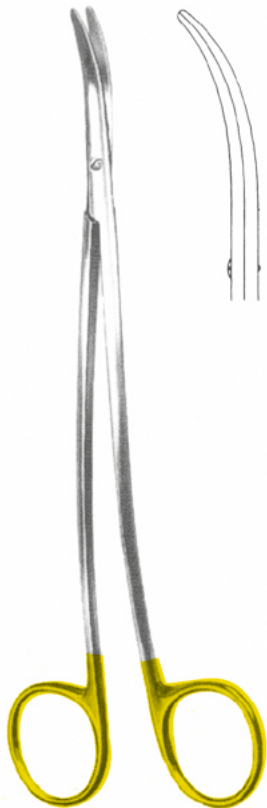


gebogen
 curved
TC 3785.14
TC 3785.18
TC 3785.20
TC 3785.23



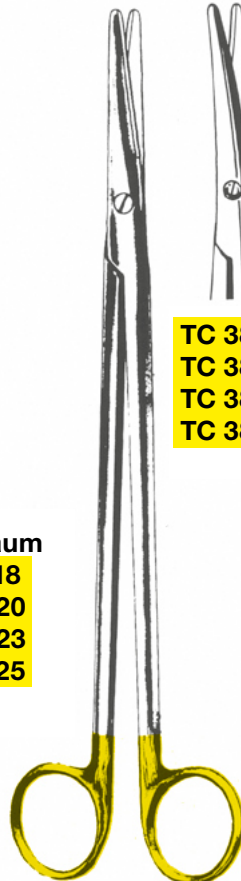
gebogen
 curved
TC 3795.14

Metzenbaum-Präparierscheren
 Standardmodell

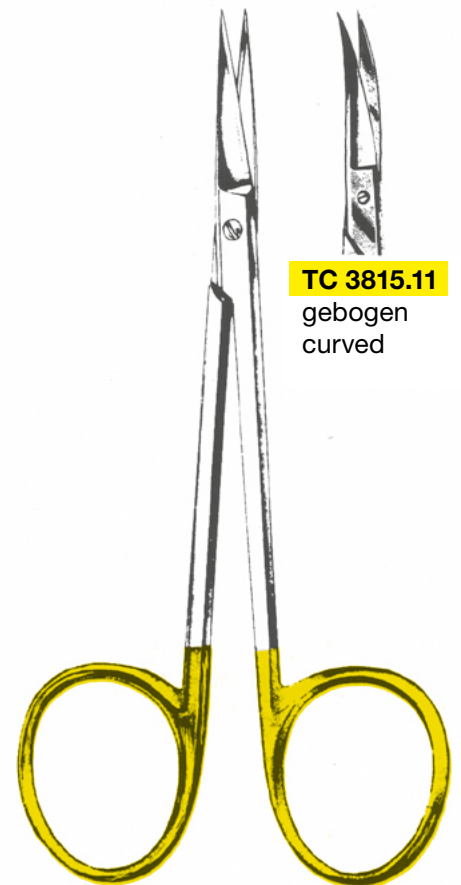


Metzenbaum „S“
TC 3797.18
TC 3797.23

Nelson-Metzenbaum
 18,0 cm **TC 3800.18**
 20,0 cm **TC 3800.20**
 23,0 cm **TC 3800.23**
 25,0 cm **TC 3800.25**



gebogen
 curved
TC 3805.18
TC 3805.20
TC 3805.23
TC 3805.25

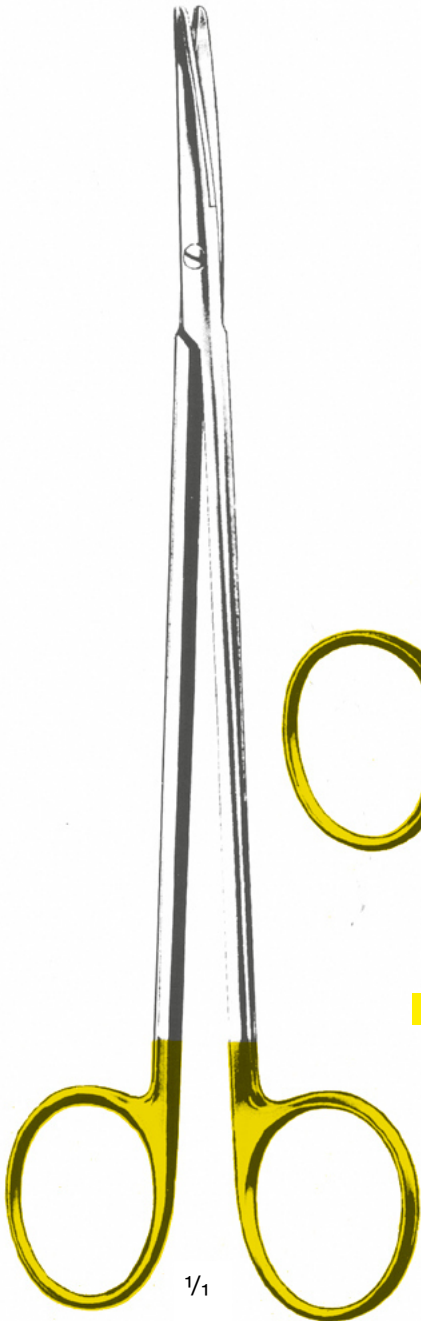


TC 3815.11
 gebogen
 curved

Iris straight, droite
 11,5 cm **TC 3810.11**

MATTES

HARTMETALL-SCHEREN
SCISSORS TUNGSTEN CARBIDE JAWS
CISEAUX AVEC CARBURE DE TUNGSTÈNE
TIJERAS TUNGSTEN CARBIDE
FORBICI CON TAGLIO AL CARBURO DI TUNGSTENO



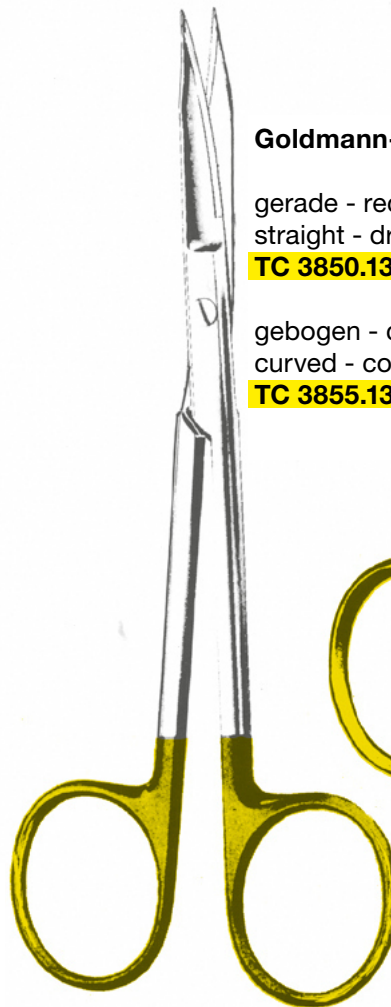
Toennis Adson-Fino
 17,5 cm **TC 3820.17**

1/1



11,5 cm
Strabismus
 gerade - rectas straight
 droits rette
TC 3830.11

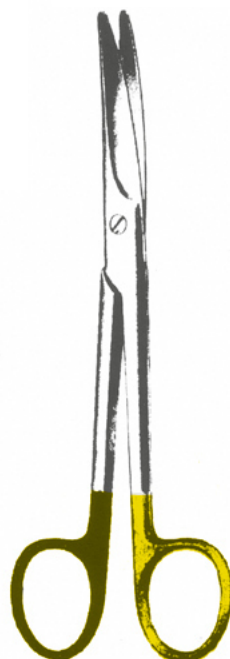
gebogen - curvas -
 curved - courbes -
 curve
TC 3835.11



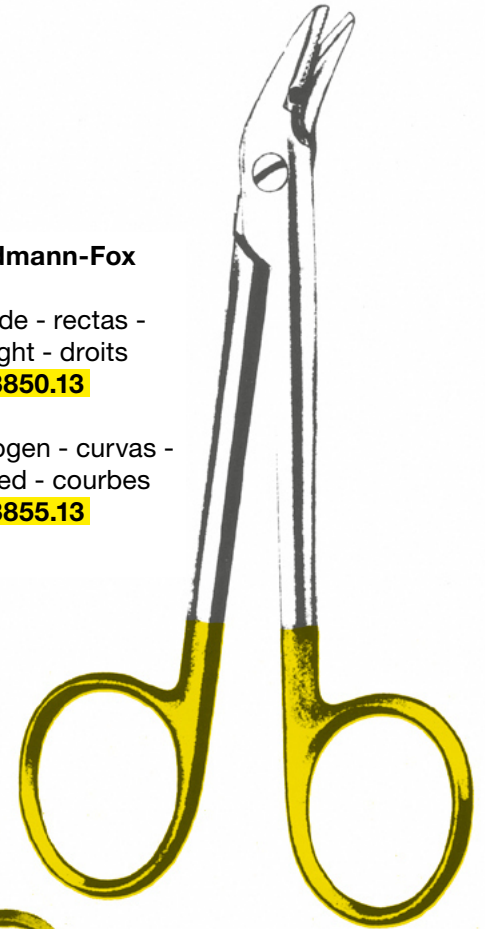
Goldmann-Fox
 gerade - rectas -
 straight - droits
TC 3850.13

gebogen - curvas -
 curved - courbes
TC 3855.13

Goldmann-Fox 13,0 cm



14,0 cm **TC 3857.14**
 17,0 cm **TC 3857.17**
 gebogen-curvas-curved
SCHWARZ-GOLD-RING
 black - gold

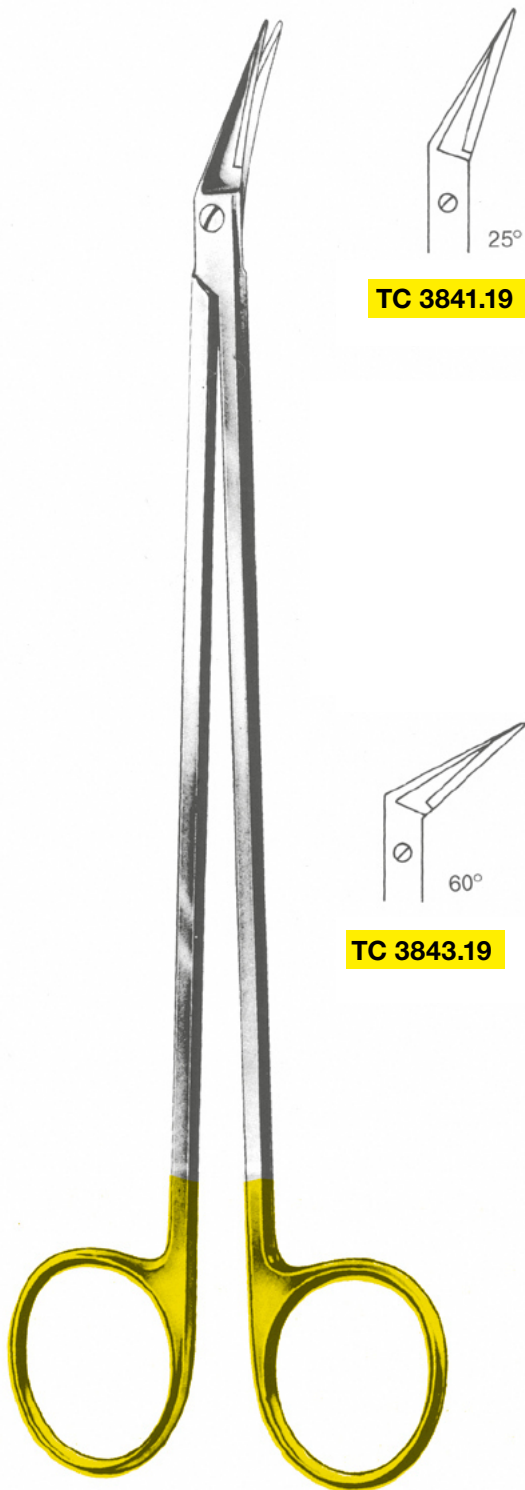


Universal
 12,5 cm **TC 3840.12**



Nahtscheren
Suture scissors
Tijeras para suturas

HARTMETALL-SCHEREN
SCISSORS TUNGSTEN CARBIDE JAWS
CISEAUX AVEC CARBURE DE TUNGSTÈNE
TIJERAS TUNGSTEN CARBIDE
FORBICI CON TAGLIO AL CARBURO DI TUNGSTENO



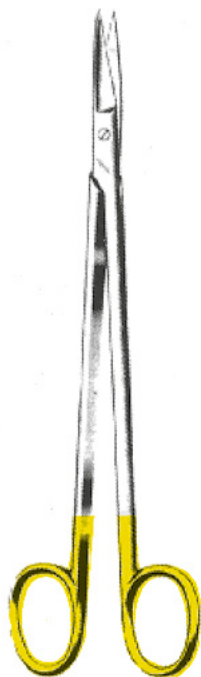
TC 3841.19

TC 3843.19

Potts-Smith
19,0 cm

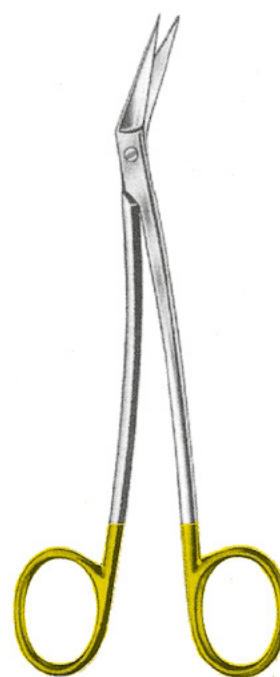
MATTES

SCHEREN MIT HARTMETALLEINSÄTZEN
 SCISSORS WITH TUNGSTEN CARBIDE
 TIJERAS CON CARBURO DE TUNGSTENO
 FORBICI CON CARBURO DI TUNGSTENO



Kelly

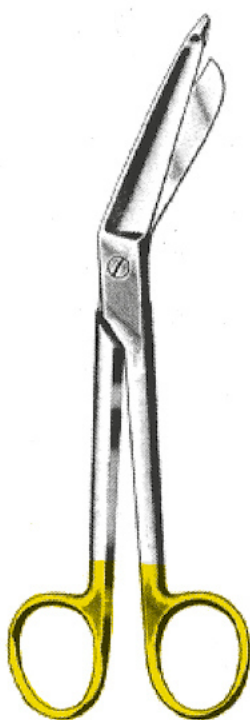
TC 3860.16 16 cm TC 3861.16



Locklin

TC 3862.17

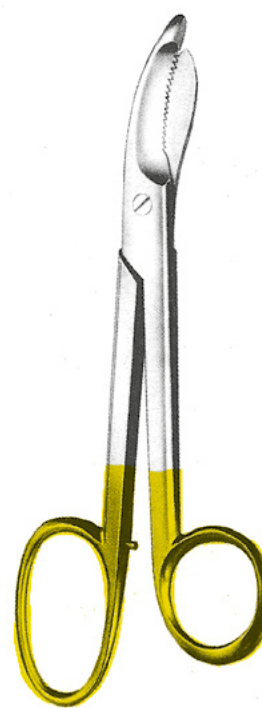
16,5 cm



Lister

TC 3865.14

TC 3865.18



Bruns

TC 3870.23

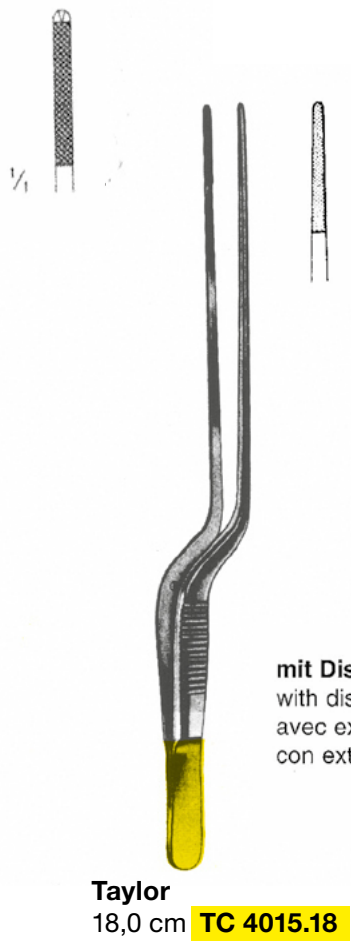
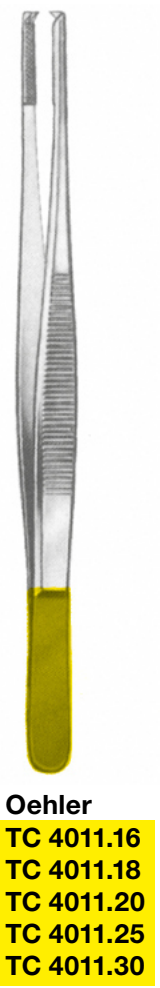
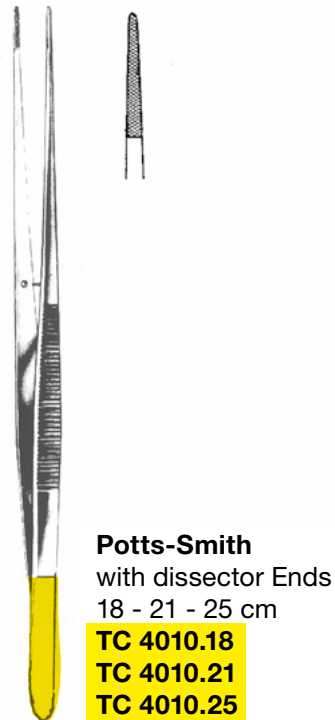
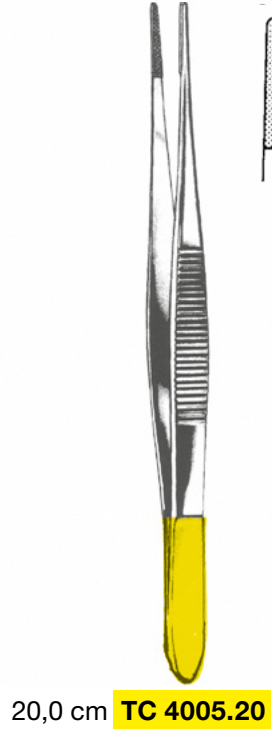
23 cm

HARTMETALL-PINZETTEN
PINZAS TUNGSTEN CARBIDE INSERTS
PINCES TUNGSTEN CARBIDE
PINZAS AVEC CARBURE DE TUNGSTENE
PINZE CON TAGLIO AL CARBURO DI TUNGSTENO

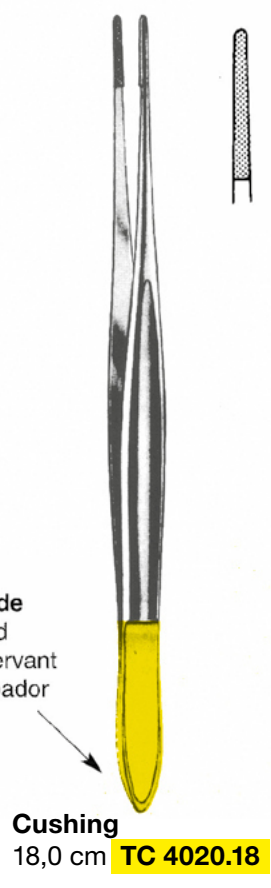


MATTES

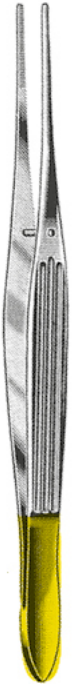
HARTMETALL PINZETTEN
 PINZAS TUNGSTEN CARBIDE INSERTS
 PINCES TUNGSTEN CARBIDE
 PINZAS AVEC CARBURE DE TUNGSTENE
 PINZE CON TAGLIO AL CARBURO DI TUNGSTENO



mit Dissektorende
 with dissector end
 avec extrémité servant
 con extremo raspador



**ANATOMISCHE UND CHIRURGISCHE PINZETTEN, FASSPINZETTEN
DRESSING AND TISSUE FORCEPS
PINZAS DE DISECCIÓN, SIN/CON DIENTES
PINZE PER DISSEZIONE, CHIRURGICHE/ANATOMICHE**



Mc Indoe
TC 4030.15
15 cm



Gillies
TC 4031.15
15,5 cm

1x2



Semken
TC 4034.15
15,5 cm

1x2



Cushing
TC 4041.17
17 cm

1x2



Gerald
TC 4042.17
17 cm



Gerald
TC 4043.17
17,5 cm

1x2



TC 4045.15
15 cm



TC 4045.23
23 cm

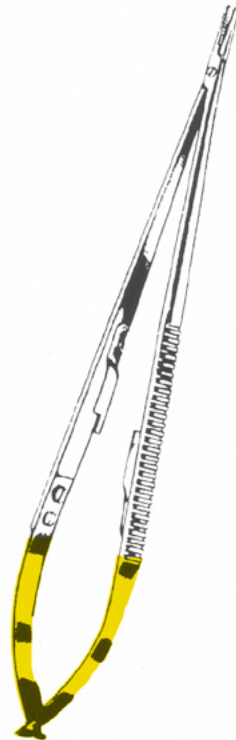
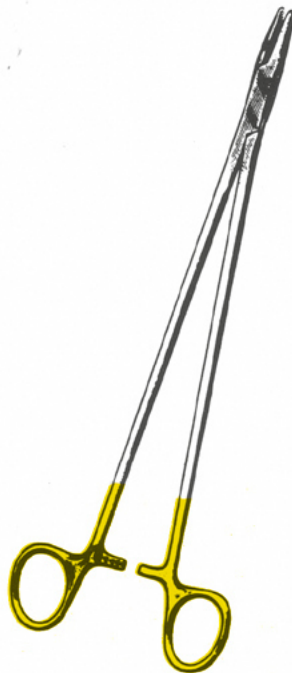
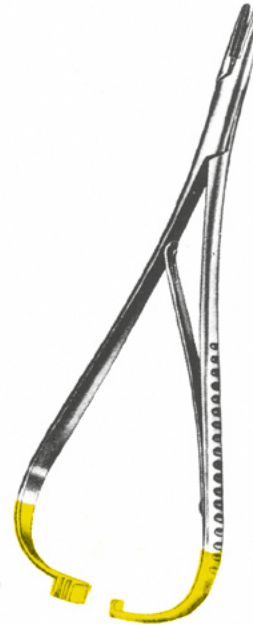


TC 4045.25
25 cm



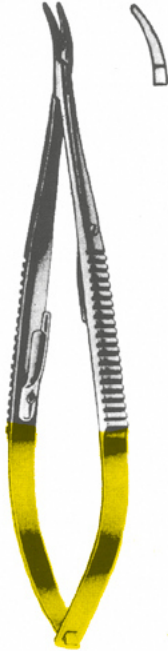
Wangensteen

NADELHALTER HARTMETALL
NEEDLEHOLDERS WITH TUNGSTEN CARBIDE INSERTS
PORTE AIGUILLES À MORS EN CARBURO DE TUNGSTENO
PORT'AGHI CON PLACCHE DI CARBURO DI TUNGSTENO

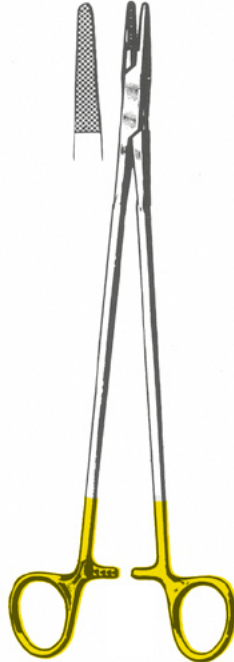


MATTES

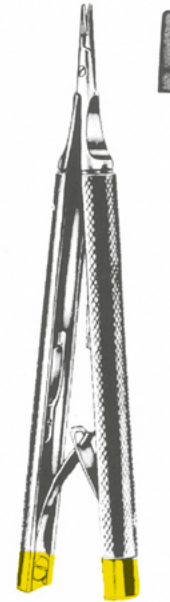
NADELHALTER HARTMETALL
 NEEDLEHOLDERS WITH TUNGSTEN CARBIDE INSERTS
 PORTE AIGUILLES À MORS EN CARBURE DE TUNGSTÈNE
 PORTA AGUJAS CON BOCAS DE CARBURO DE TUNGSTENO
 PORT'AGHI CON PLACCHE DI CARBURO DI TUNGSTENO



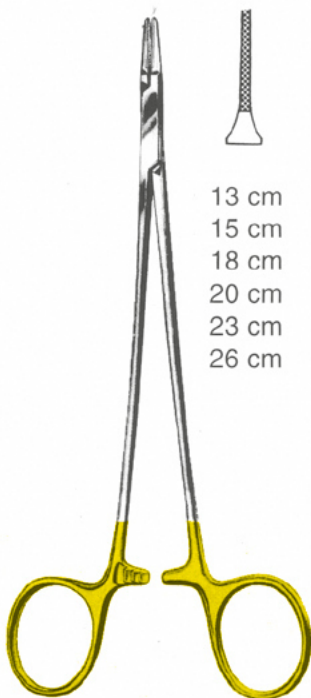
Castroviejo
TC 4430.14
 14,0 cm



De Bakey
 18,0 cm **TC 4435.18**
 20,0 cm **TC 4435.20**
 23,0 cm **TC 4435.23**
 26,0 cm **TC 4435.26**
 31,0 cm **TC 4435.30**

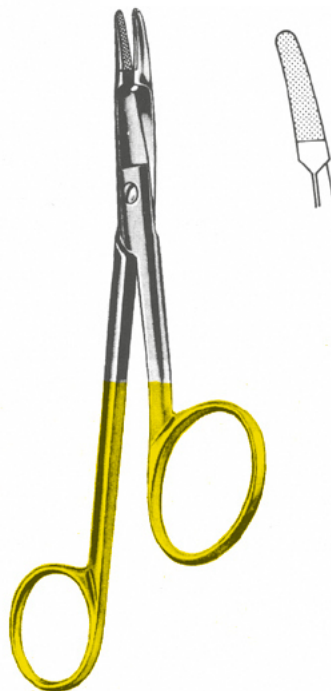


Castroviejo
TC 4440.13
 13,0 cm




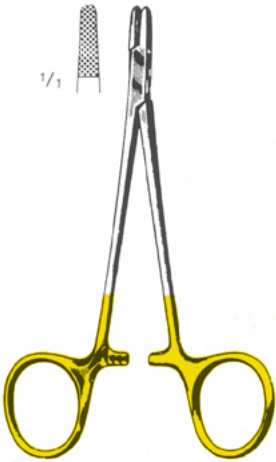
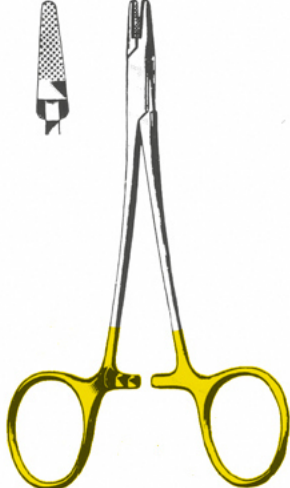

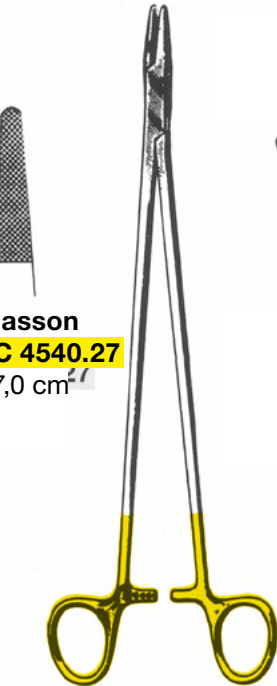

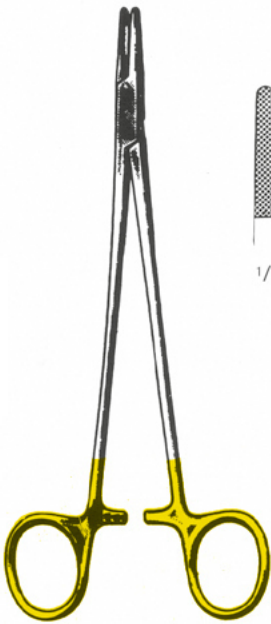

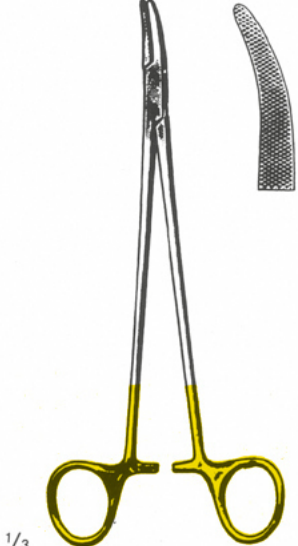
13 cm
 15 cm
 18 cm
 20 cm
 23 cm
 26 cm

Ryder
TC 4450.13 TC 4450.20
TC 4450.15 TC 4450.23
TC 4450.18 TC 4450.26



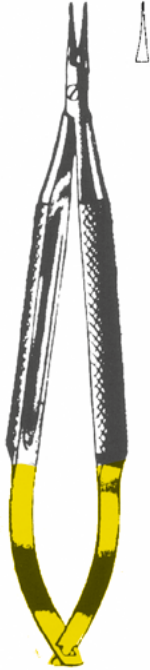
Gillies
 16,0 cm **TC 4455.16**

NADELHALTER HARTMETALL
NEEDLEHOLDERS WITH TUNGSTEN CARBIDE INSERTS
PORTE AIGUILLES À MORS EN CARBURE DE TUNGSTÈNE
PORTA AGUJAS CON BOCAS DE CARBURO DE TUNGSTENO
PORT'AGHI CON PLACCHE DI CARBURO DI TUNGSTENO

 <p>1/2</p>	 <p>1/2</p>		
<p>Halsey 13,0 cm TC 4500.13 Serrated - gerieft</p>	<p>Derf 12,5 cm TC 4510.12</p>	<p>Baumgartner 14,0 cm TC 4520.14</p>	<p>Crile Wood 15,0 cm TC 4530.15 18,0 cm TC 4530.18 20,0 cm TC 4530.20 23,0 cm TC 4530.23 23,0 cm TC 4530.26</p>
			
<p>Masson TC 4540.27 27,0 cm</p>	<p>Finochietto TC 4545.27 27,0 cm</p>	<p>Mayo-Hegar 14,0 cm TC 4550.14 16,0 cm TC 4550.16 18,0 cm TC 4550.18 20,0 cm TC 4550.20 24,0 cm TC 4550.24 26,0 cm TC 4550.26 30,0 cm TC 4550.30</p>	<p>Mayo-Hegar-Fino 18,0 cm TC 4555.18 20,0 cm TC 4555.20</p>
			
			<p>Heaney 20,0 cm TC 4560.20 24,0 cm TC 4560.24 26,0 cm TC 4560.26</p>

MATTES

NADELHALTER - MICRO
 NEEDLE HOLDERS - MICRO
 PORTE-AIGUILLES - MICRO
 PORTA-AGUJAS - MICRO
 PORT'AGHI - MICRO



Barraquer
 10,0 cm **TC 4561.10**



10,0 cm **TC 4562.10**



Castroviejo
 TC 4565.14



14,5 cm TC 4565.14
 gerieft
 serrated
 esteriada
 serrata



Arruga
 TC 4568.16

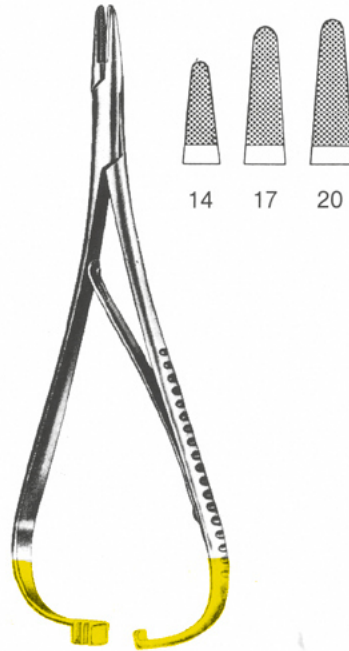


16 cm TC 4568.16

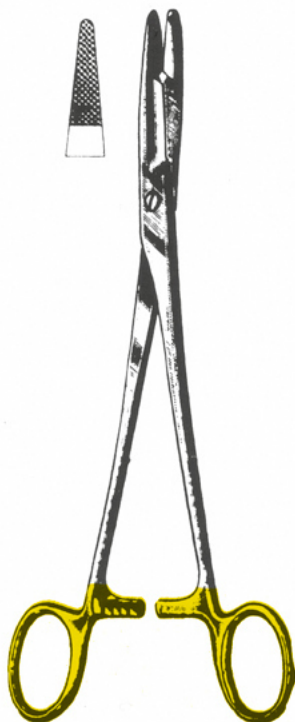
NADELHALTER HARTMETALL
NEEDLEHOLDERS WITH TUNGSTEN CARBIDE INSERTS
PORTE AIGUILLES À MORS EN CARBURE DE TUNGSTÈNE
PORTA AGUJAS CON BOCAS DE CARBURO DE TUNGSTENO
PORT'AGHI CON PLACCHE DI CARBURO DI TUNGSTENO



Langenbeck
TC 4570.18
TC 4570.20
TC 4570.23



Mathieu
 14,0 cm **TC 4580.14**
 17,0 cm **TC 4580.17**
 20,0 cm **TC 4580.20**



Olsen-Hegar
 14,5 cm **TC 4795.14**
 18,5 cm **TC 4795.18**



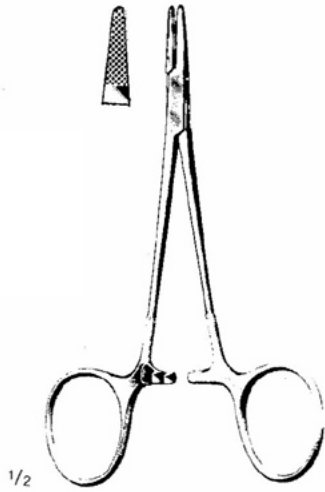
Lichtenberg
 20,0 cm **TC 4610.20**

NAHT-INSTRUMENTE
SUTURING INSTRUMENTS
INSTRUMENTS À SUTURES
INSTRUMENTOS PARA SUTURAS
STRUMENTI PER SUTURE

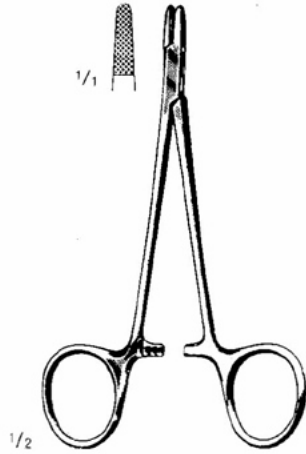


MATTES

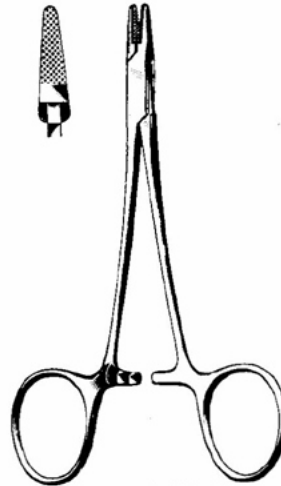
NADELHALTER
NEEDLE HOLDERS
PORTE-AIGUILLES
PORTA-AGUJAS
PORT'AGHI



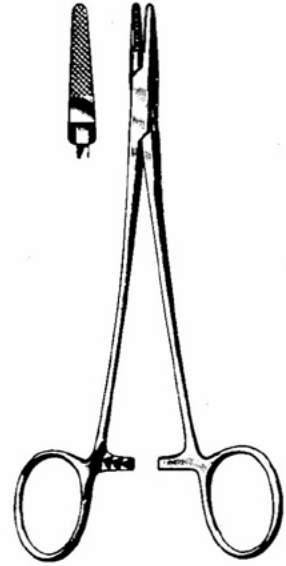
Halsey
13,0 cm 4500.13
Serrated - gerieft



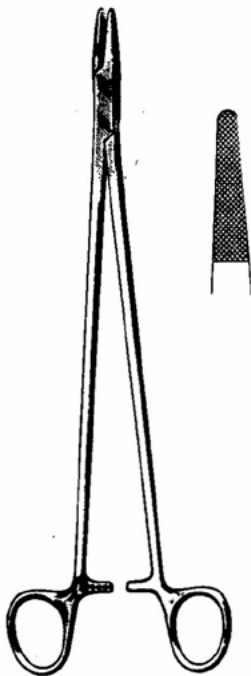
Derf
12,5 cm 4510.12



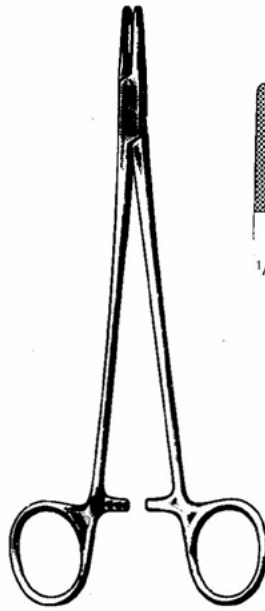
Baumgartner
14,0 cm 4520.14



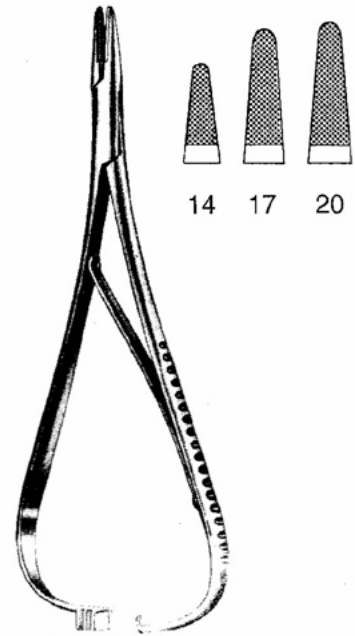
Crile Wood
15,0 cm 4530.15
18,0 cm 4530.18
20,0 cm 4530.20
23,0 cm 4530.23
16,0 cm 4530.16



Masson
27,0 cm 4540.27



Mayo-Hegar
14,0 cm 4550.14
16,0 cm 4550.16
18,0 cm 4550.18
20,0 cm 4550.20
24,0 cm 4550.24
26,0 cm 4550.26
30,0 cm 4550.30

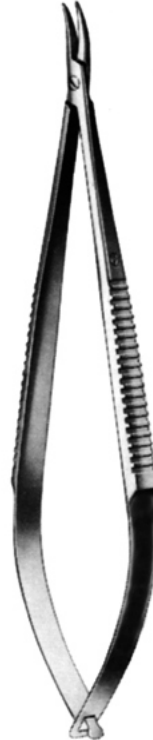


Mathieu
14,0 cm 4560.14
17,0 cm 4560.17
20,0 cm 4560.20

MIKOR-NADELHALTER
MICRO-NEEDLE HOLDERS
MICRO-PORTA-AGUJAS
MICRO-PORT'AGHI



Castroviejo-Standard
4572.14



Castroviejo-Standard
4573.14

MATTES

NAHT-INSTRUMENTE
SUTURING INSTRUMENTS
INSTRUMENTS À SUTURES
INSTRUMENTOS PARA SUTURAS
STRUMENTI PER SUTURE



Young Boomerang
25,0 cm 4800.25



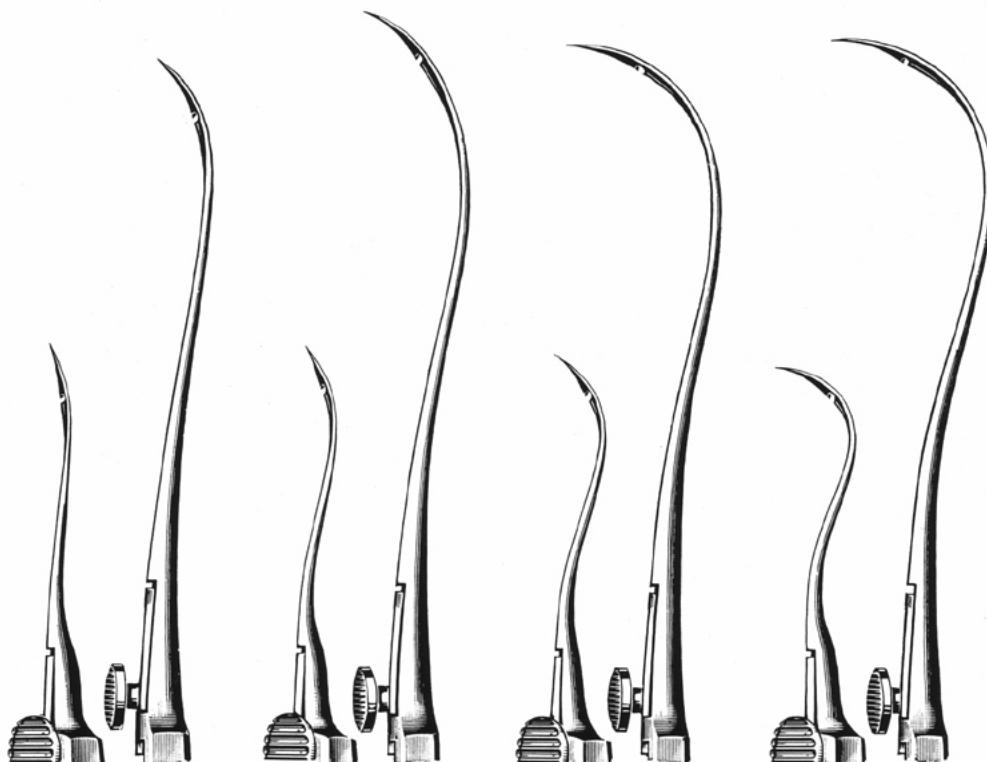
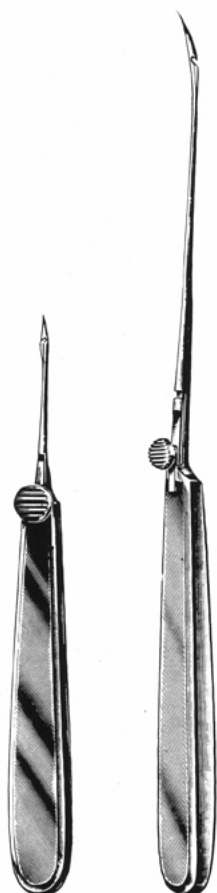
Fig. 1
4801.01



Fig. 2
4801.02



Fig. 3
4801.03



Reverdin

cm	Fig. 1	Fig. 2	Fig. 3	Fig. 4
15	4811.15	4812.15	4813.15	4814.15
19	4811.19	4812.19	4813.19	4814.19
21	4811.21	4812.21	4813.21	4814.21
23	4811.23	4812.23	4813.23	4814.23

WUNDKLAMMERN, -INSTRUMENTE
 CLIPS AND INSTRUMENTS
 AGRAFES ET INSTRUMENTS
 AGRAFES E INSTRUMENTOS
 AGRAFES E STRUMENTI



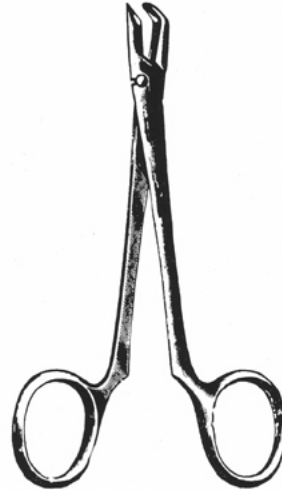
Michel
4858.12



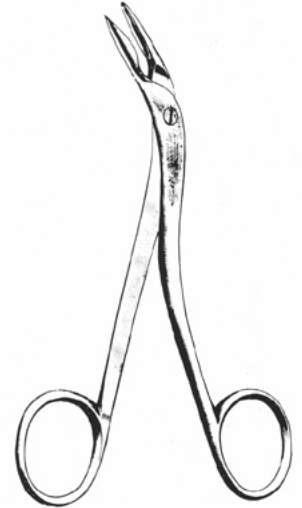
Hegenbarth
4860.12



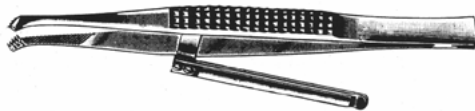
Michel
4865.12



Collin
4870.13



Richter-Heath
4875.14



Childe
4852.18 18 cm

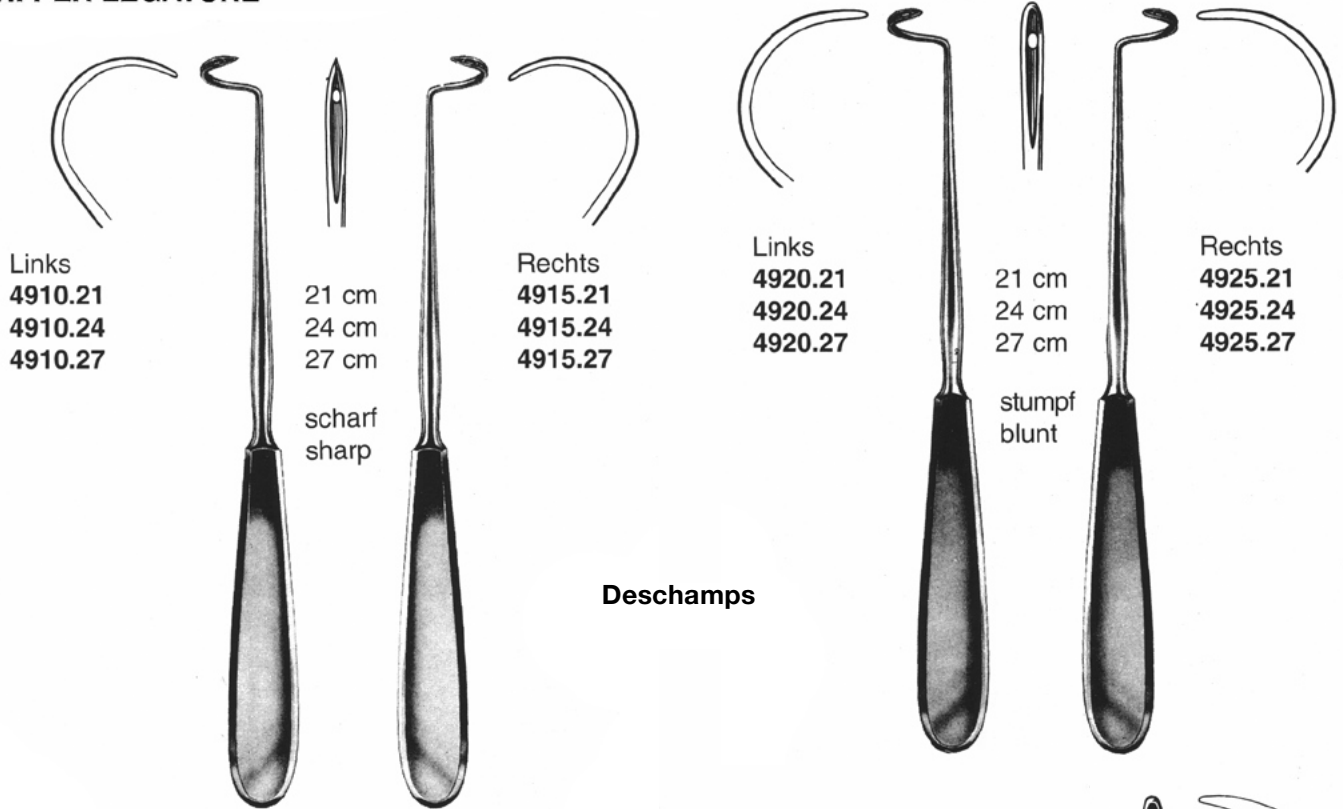
Estuche para sutura, en caja de metal,
 compuesto de:

- Pinza para agrafes de Michel
- Pinza para juntar los bordes de la herida,
 de Wachenfeldt, con porta-agrafes
- 50 Agrafes (Grapas) de Michel

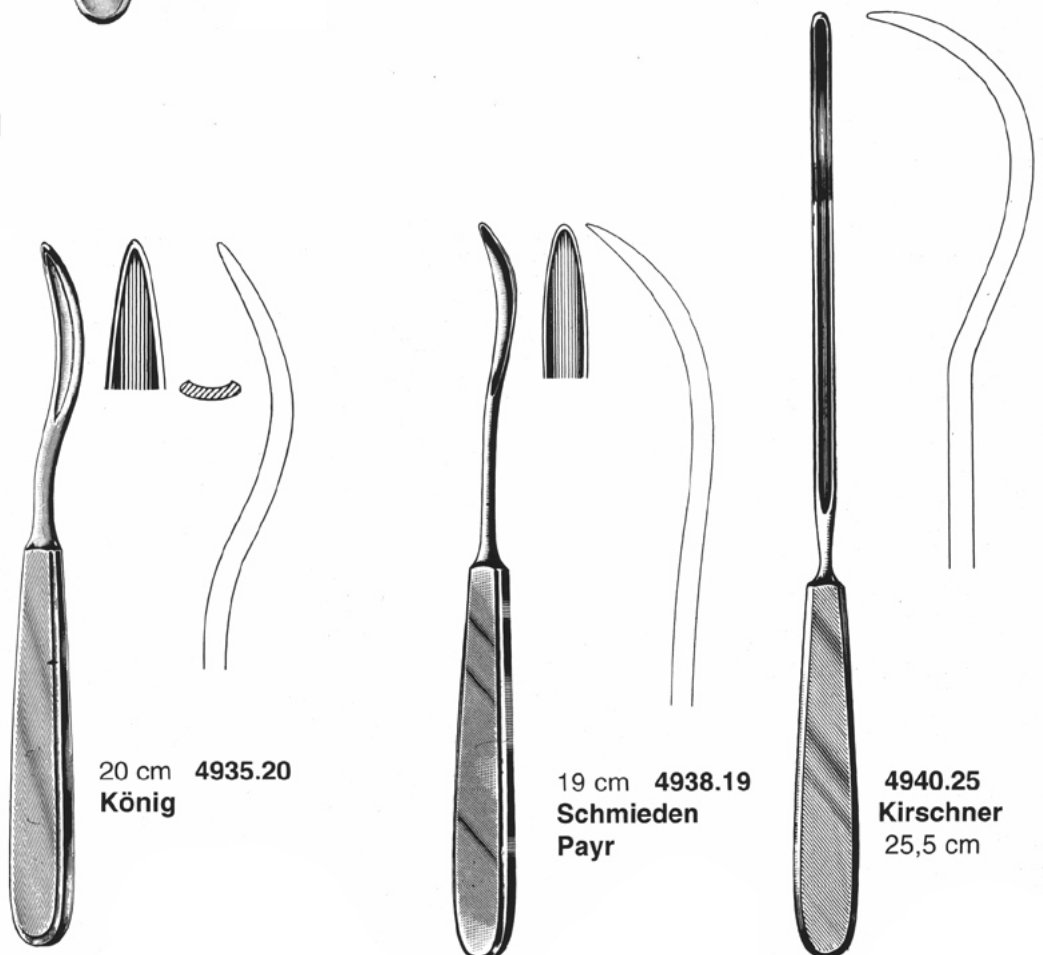
Set di clip per suture in astuccio di metallo
 composto da:

- Pinza di Michel per clip
- Pinza Wachenfeldt con fermagli per sutura
- 50 Agrafes di Michel

**UNTERBINDUNGSNADELN
LIGATURE NEEDLES
AIGUILLES À LIGATURES
AGUJAS PARA LIGADURAS
AGHI PER LEGATURE**



**FÜHRUNGS-HOHLSONDEN
LIGATURE CONDUCTORS
SONDES CONDUCTRICES
SONDAS CONDUCTORAS**



MATTES

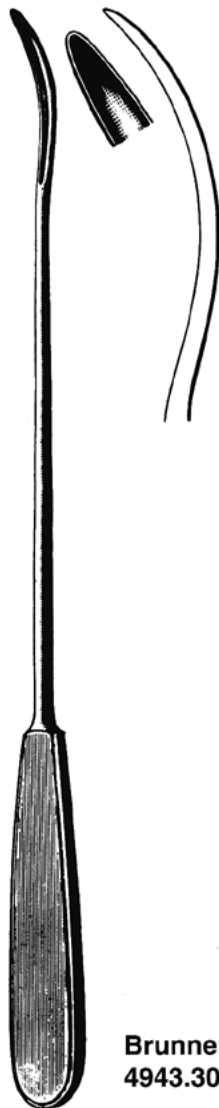
FÜHRUNGSHOHLSONDEN
 LIGATURE CONDUCTORS
 SONDAS CONDUCTORAS
 SONDE CONDUTTRICI



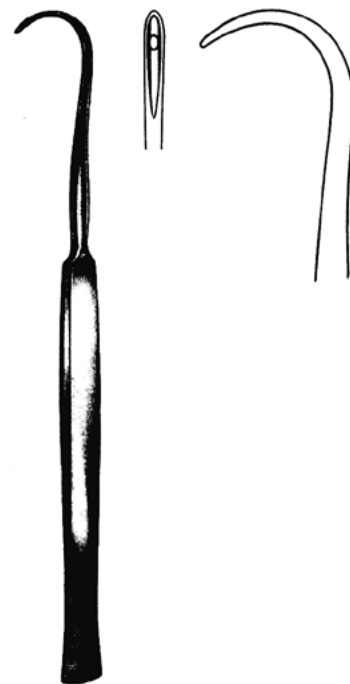
Payr
 4941.22
 22 cm



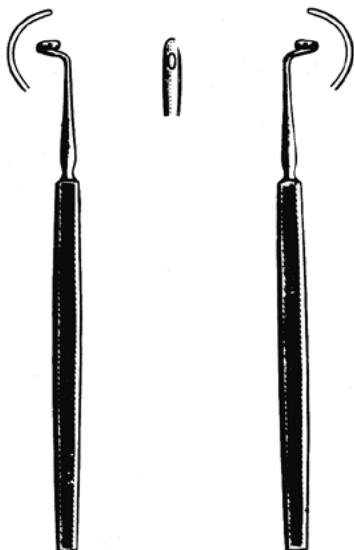
Payr
 4942.22
 22 cm



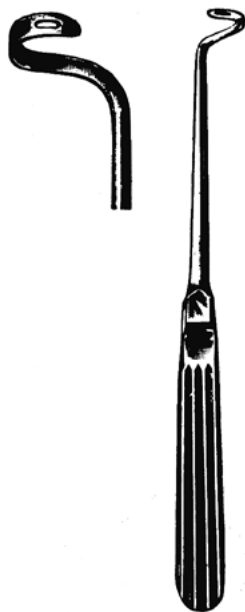
Brunner
 4943.30 30 cm



Cooper
 4944.19 19 cm



L Kronecker R
 4945.13 13 cm 4946.13

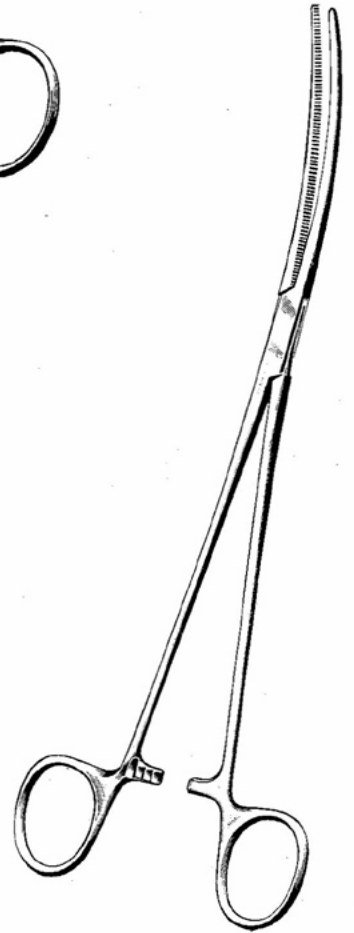
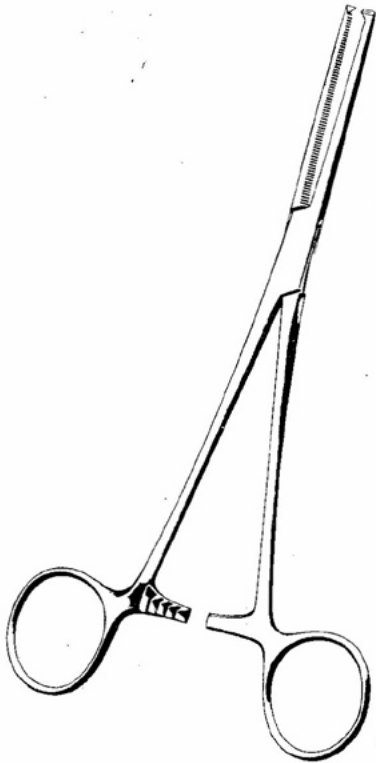
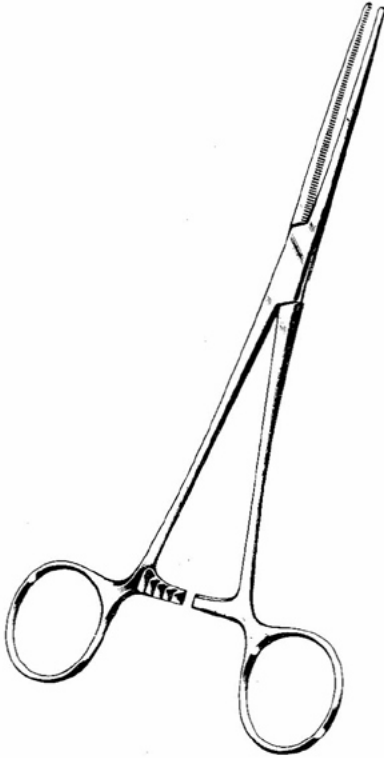


L Nelson R
 4947.24 24,5 cm 4948.24



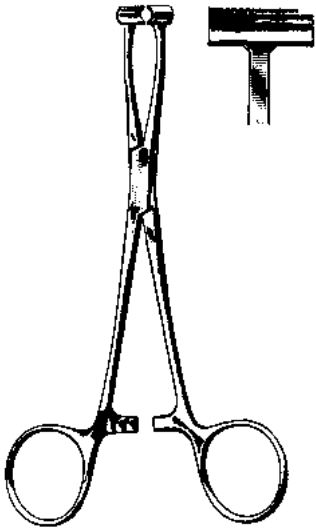
4950.23 23 cm

ARTERIENKLEMMEN
HEMOSTATIC FORCEPS
PINCES HÉMOSTATIQUES
PINZAS HEMOSTÁTICAS
PINZE EMOSTATICHE

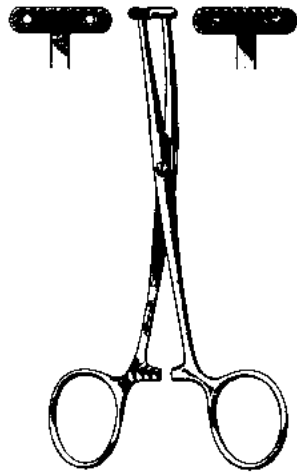


MATTES

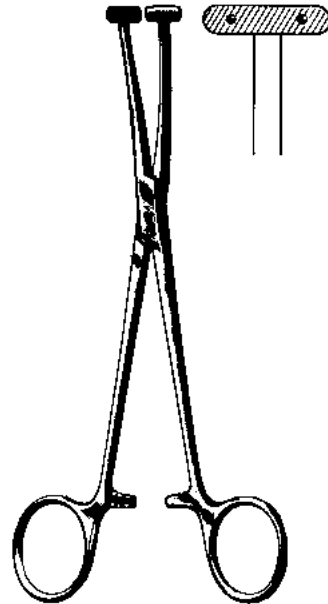
ARTERIENKLEMMEN
HEMOSTATIC FORCEPS
PINZAS HEMOSTÁTICAS
PINZE EMOSTATICHE



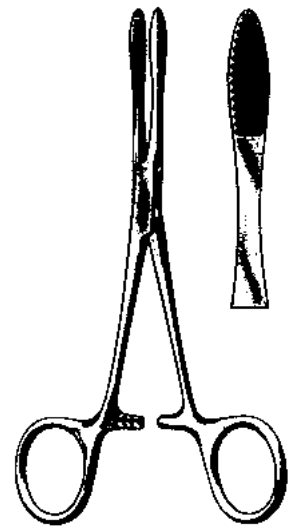
Pratt
4980.15 15 cm



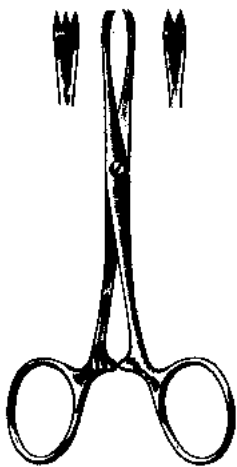
Martel
4984.14 14 cm



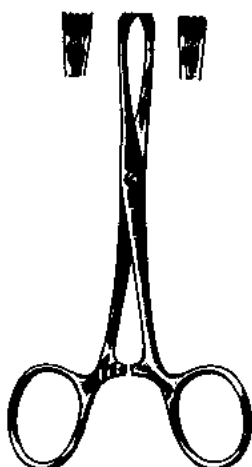
Willet Martel
4986.19 19 cm



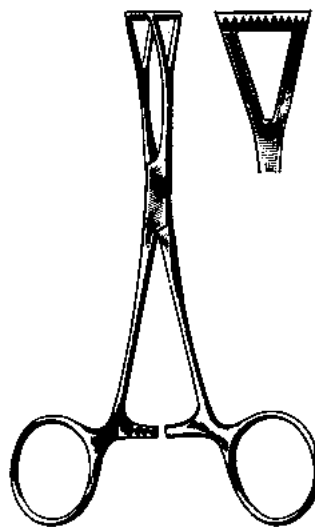
Pean
4988.14 14 cm
4988.16 16 cm



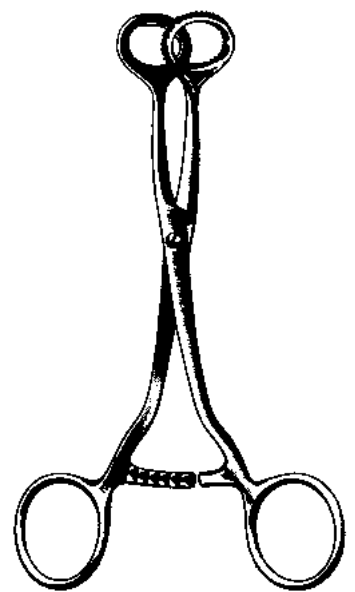
Chaput
4990.13 13 cm



Tuffier
4992.13 13 cm

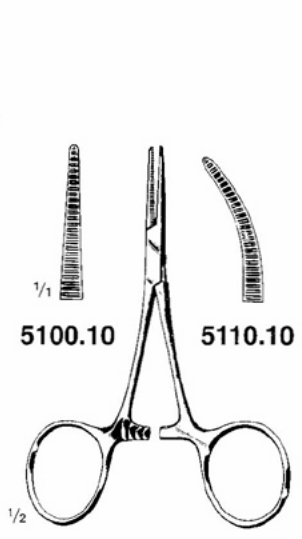


Collin
4994.14 14 cm

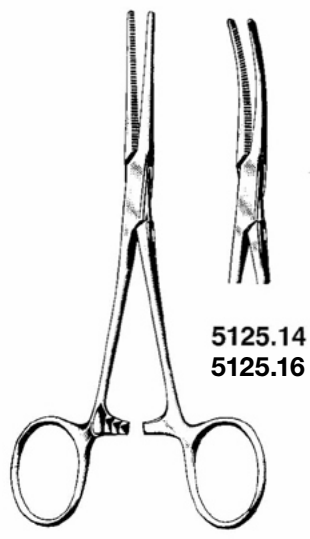


Collin
12320.16 16 cm

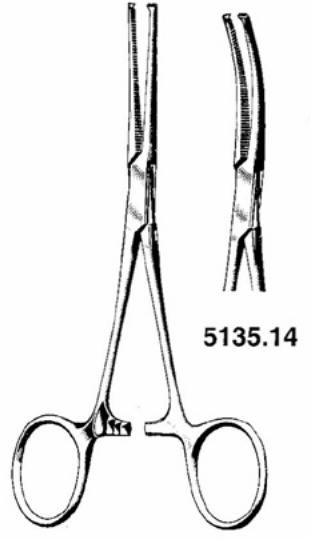
**ARTERIENKLEMMEN
HEMOSTATIC FORCEPS
PINCES HÉMOSTATIQUES
PINZAS HEMOSTÁTICAS
PINZE EMOSTATICHE**



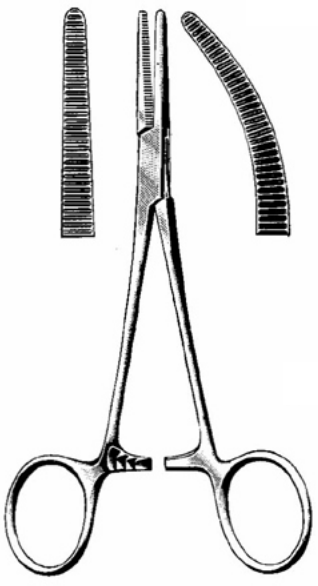
5100.10 5110.10
Hartmann
9,0 cm



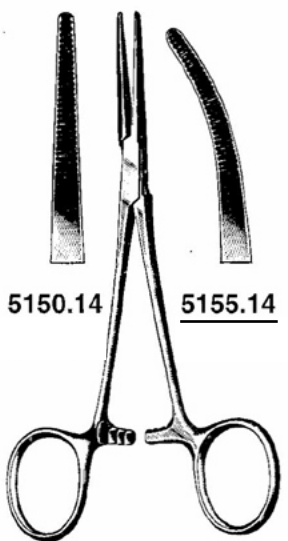
5125.14 5125.16
Pean-Fino
14,0 cm 5120.14



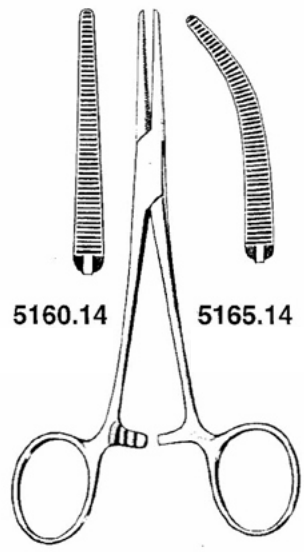
5135.14
Kocher-Fino
14,0 cm 5130.14



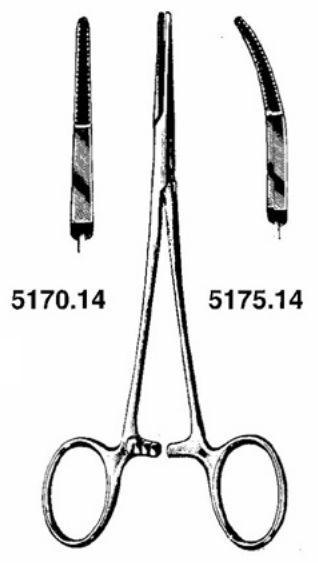
Spencer Wells
5140.13 13,0 cm 5145.13
5140.15 15,0 cm 5145.15
5140.18 18,0 cm 5145.18
5140.20 20,0 cm 5145.20



5150.14 5155.14
Kelly
14,0 cm



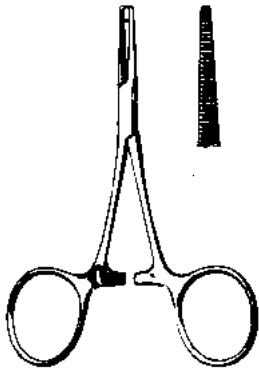
5160.14 5165.14
Crile
14,0 cm



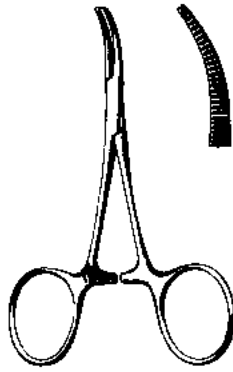
5170.14 5175.14
Providence-Hospital
14,0 cm

MATTES

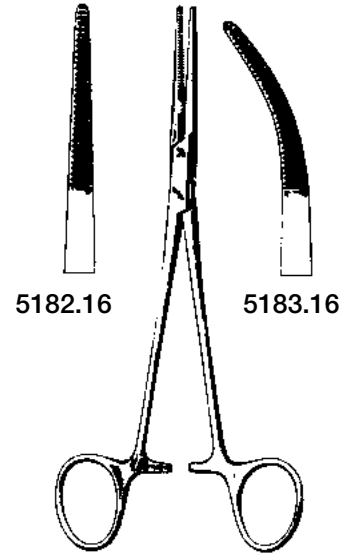
ARTERIENKLEMMEN
HEMOSTATIC FORCEPS
PINZAS HEMOSTÁTICAS
PINZE EMOSTATICHE



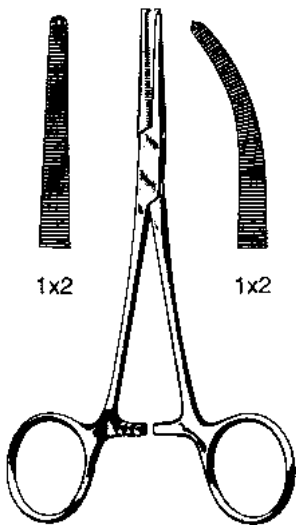
Hartmann
5180.10 10 cm



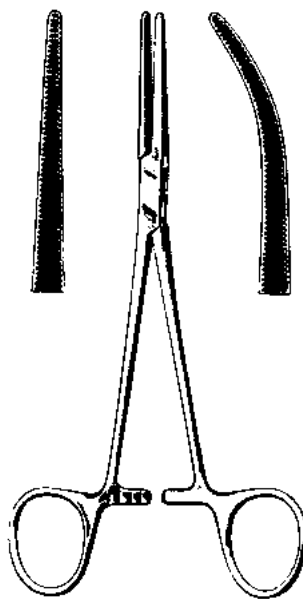
Hartmann
5181.10 10 cm



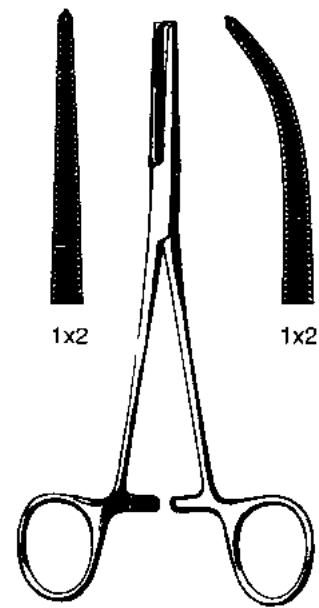
5182.16 5183.16
Kelly-Rankin
5182.16 - 5183.16
16 cm



1x2 1x2
Crile
5184.14 14 cm 5185.14

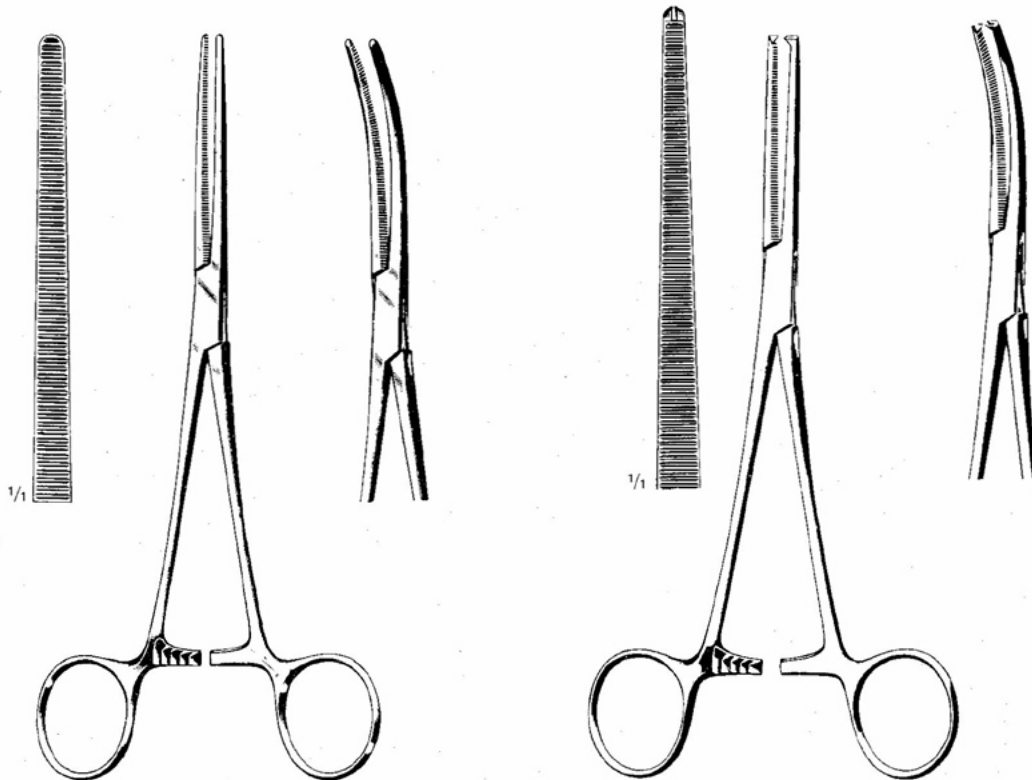


Crile-Rankin
5186.16 16 cm 5187.16



1x2 1x2
Crile-Rankin
5188.16 16 cm 5189.16

**ARTERIENKLEMMEN
HEMOSTATIC FORCEPS
PINCES HÉMOSTATIQUES
PINZAS HEMOSTÁTICAS
PINZE EMOSTATICHE**



Rochester-Pean

Rochester-Ochsner

gerade
straight
rectas
rette

gebogen
curved
curvas
curve

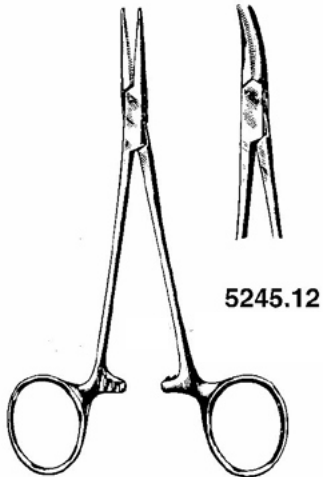
gerade
straight
rectas
rette

gebogen
curved
curvas
curve

13 cm	5220.13	5225.13		
14,0 cm/5½"	5220.14	5225.14	5230.14	5235.14
16,0 cm/6¼"	5220.16	5225.16	5230.16	5235.16
18,0 cm/7"	5220.18	5225.18	5230.18	5235.18
20,0 cm/8"	5220.20	5225.20	5230.20	5235.20
22,0 cm/8¾"	5220.22	5225.22	5230.22	5235.22
24,0 cm/9½"	5220.24	5225.24	5230.24	5235.24
26,0 cm/10¼"	5220.26	5225.26	5230.26	5235.26
28,0 cm/11"	5220.28	5225.28		
30,0 cm/12"	5220.30	5225.30	5230.30	5235.30

MATTES

ARTERIENKLEMMEN
HEMOSTATIC FORCEPS
PINCES HÉMOSTATIQUES
PINZAS HEMOSTÁTICAS
PINZE EMOSTATICHE



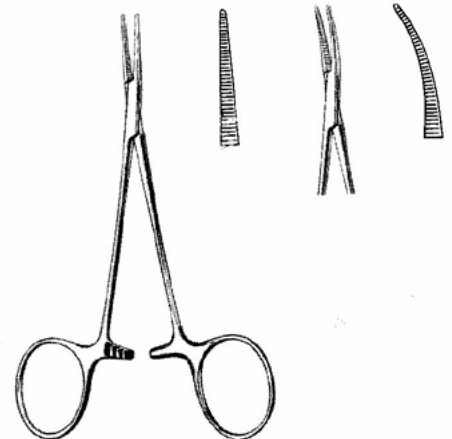
5245.12

Halstead-Mosquito
12,5 cm 5240.12
14,0 cm 5240.14

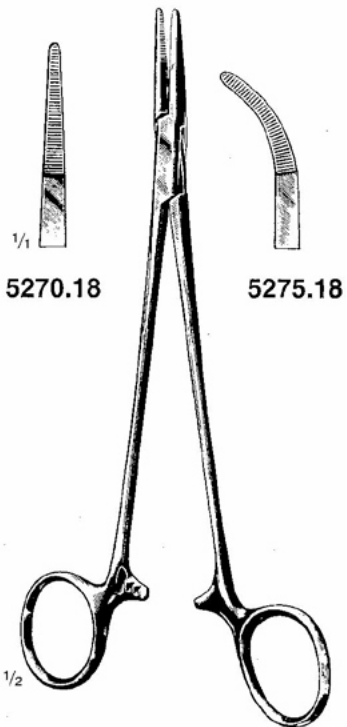


5255.12

Halstead-Mosquito
12,5 cm 5250.12



Halstead-Mosquito micro
5241.12 5246.12

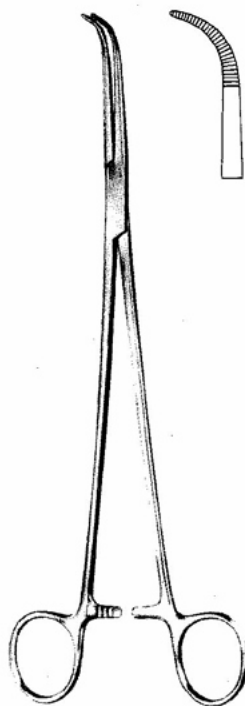


5270.18

Adson
18,5 cm



5275.18



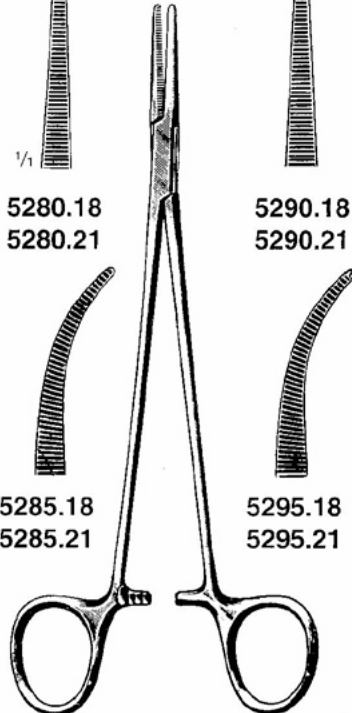
Adson Baby
14,0 cm 5278.14
18,0 cm 5278.18



5280.18
5280.21



5285.18
5285.21



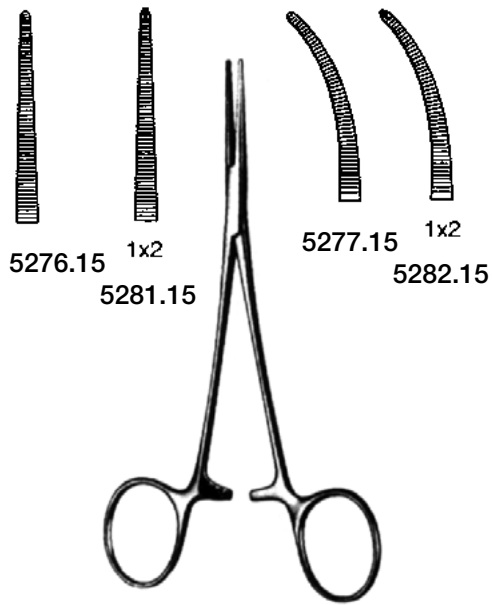
5290.18
5290.21



5295.18
5295.21

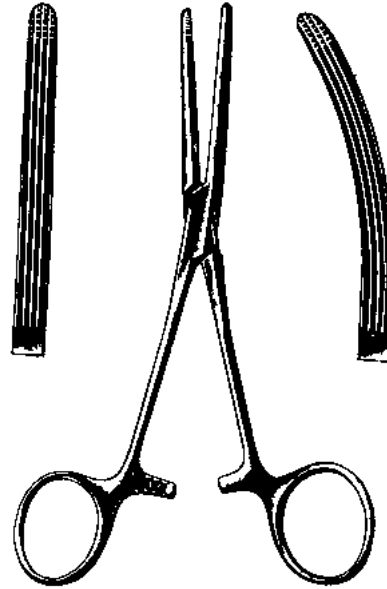
Halstead-Mosquito
18,0 cm/21,0 cm

ARTERIENKLEMMEN
HEMOSTATIC FORCEPS
PINZAS HEMOSTÁTICAS
PINZE EMOSTATICHE

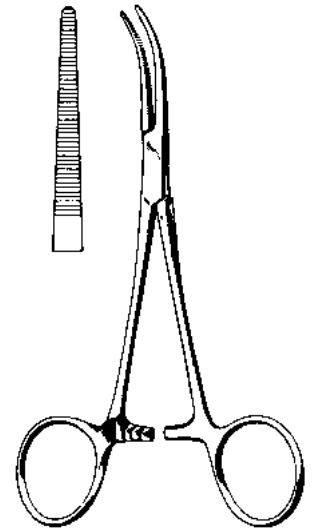


5276.15 1x2
5281.15

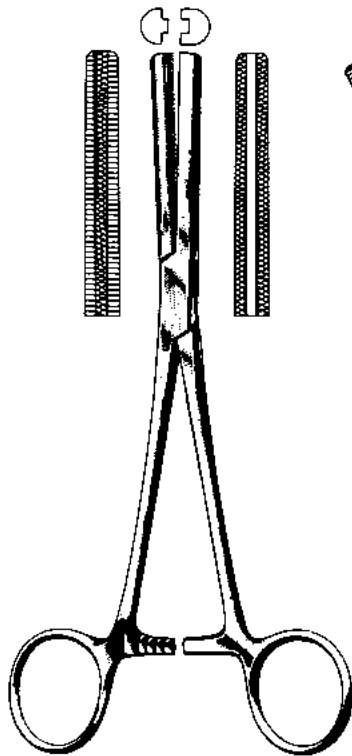
Leriche
16 cm



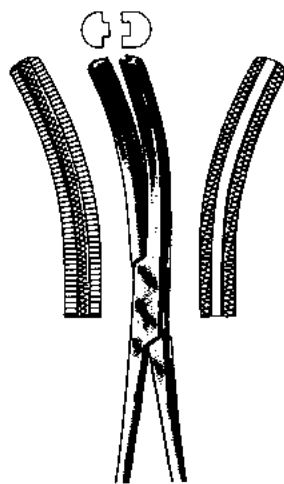
Rochester-Carmalt
5283.16 16 cm 5284.16
5283.20 20 cm 5284.20



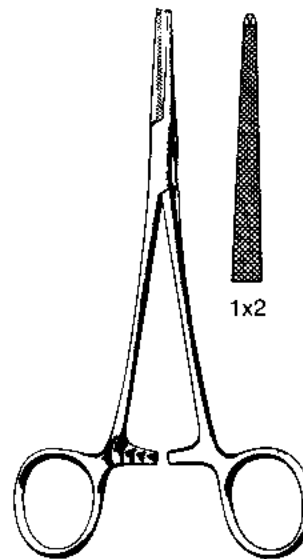
Dandy
5286.14 14 cm



Fergusson
5287.16 16 cm 5288.16
5287.20 20 cm 5288.20



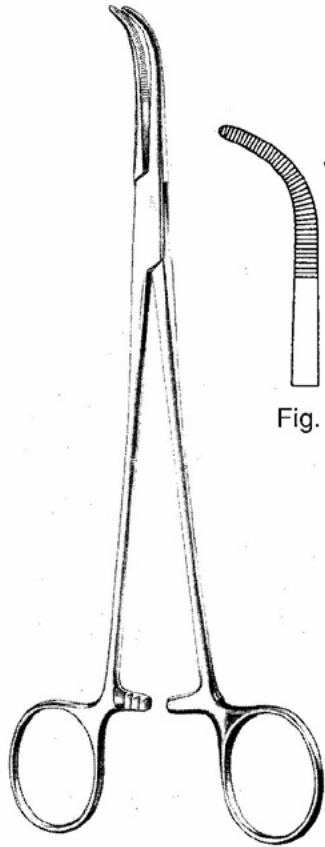
Lovelace
5289.16 15,5 cm



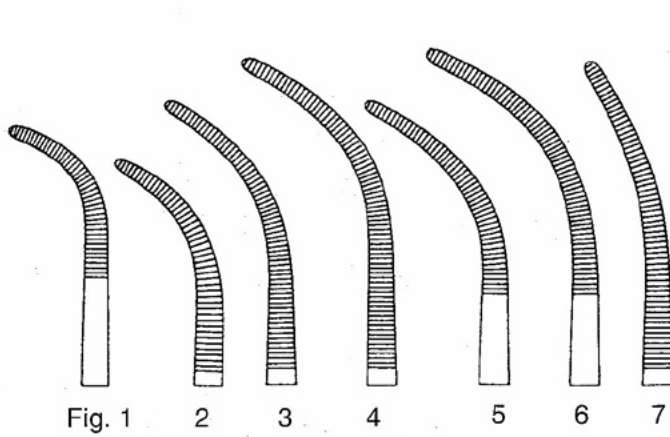
Pennington
5291.16 15,5 cm
5291.20 20,0 cm

MATTES

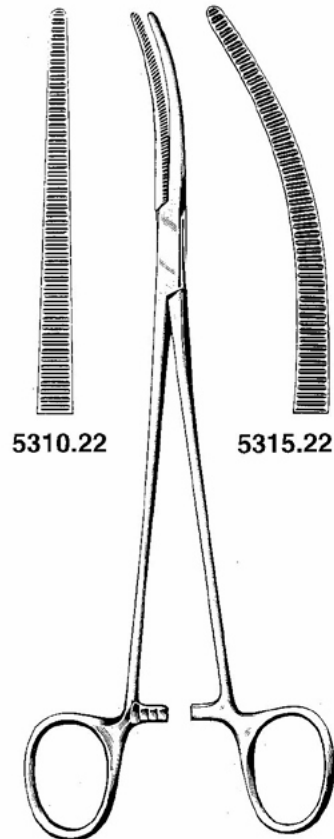
ARTERIENKLEMMEN
 HEMOSTATIC FORCEPS
 PINCES HÉMOSTATIQUES
 PINZAS HEMOSTÁTICAS
 PINZE EMOSTATICHE



Overholt-Geissendörfer
 21 cm/8¼" 27,0 cm/10¾"

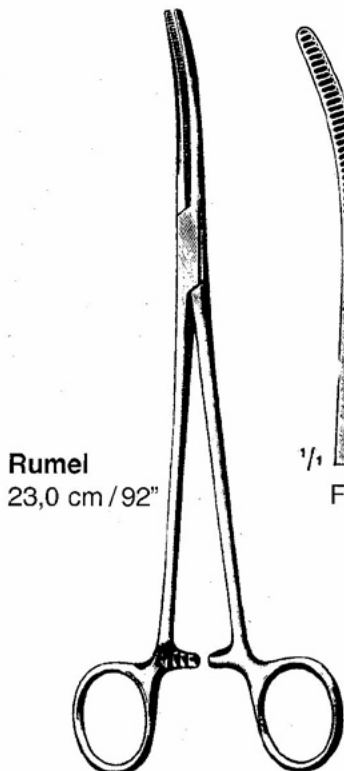


- Overholt-Geissendörfer**
 21 cm/8¼" 27 cm/10¾"
- | | |
|----------------|----------------|
| 5300.01 Fig. 1 | 5305.01 Fig. 1 |
| 5300.02 Fig. 2 | 5305.02 Fig. 2 |
| 5300.03 Fig. 3 | 5305.03 Fig. 3 |
| 5300.04 Fig. 4 | 5305.04 Fig. 4 |
| 5300.05 Fig. 5 | 5305.05 Fig. 5 |
| 5300.06 Fig. 6 | 5305.06 Fig. 6 |
| 5300.07 Fig. 7 | 5305.07 Fig. 7 |

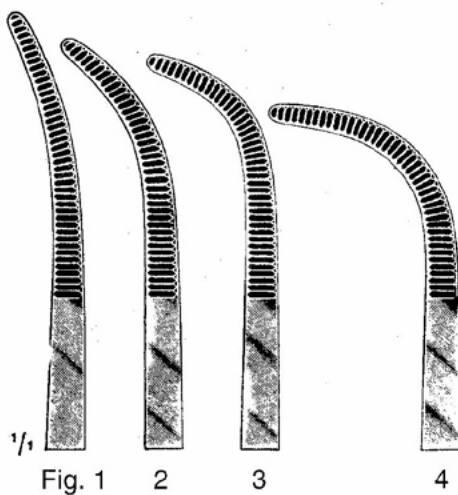


5310.22 5315.22

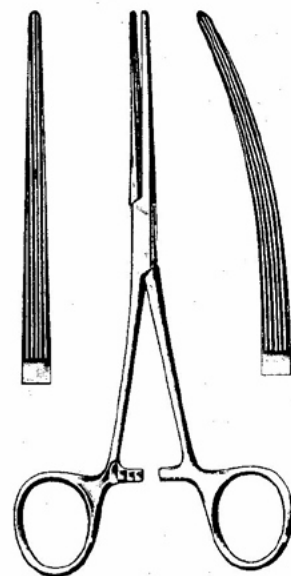
Roberts 22,0 cm/8¾"



Rumel
 23,0 cm/92"

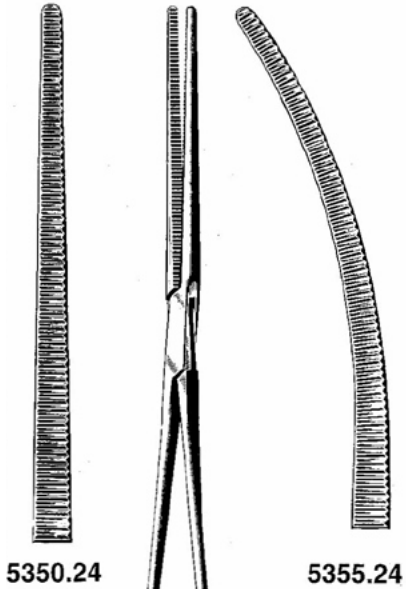


- | |
|----------------|
| 5330.01 Fig. 1 |
| 5330.02 Fig. 2 |
| 5330.03 Fig. 3 |
| 5330.04 Fig. 4 |



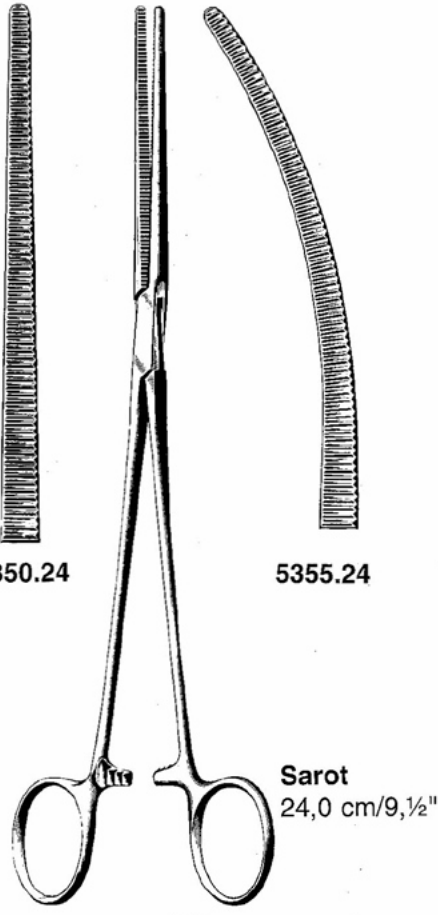
Bainbridge
 15 cm = 5340.15 5345.15
 18 cm = 5340.18 5345.18

**BRONCHUSKLEMMEN
BRONCHUS FORCEPS
PINCES-CLAMPS À BRONCHES
PINZAS CLAMPS BRONQUIALES
PINZE PER BRONCHI**

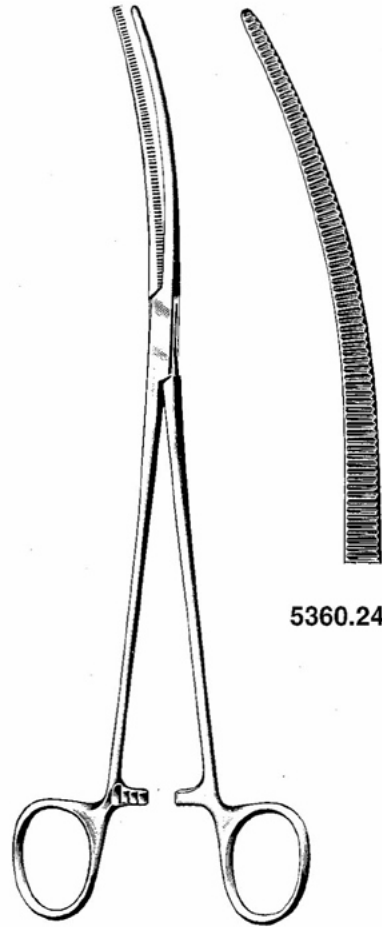


5350.24

5355.24

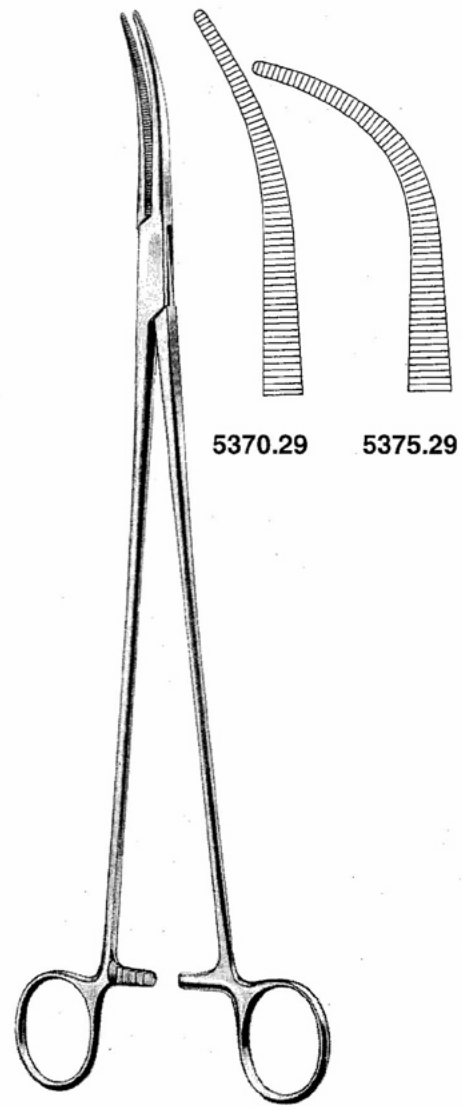


Sarot
24,0 cm/9,½"



Crafoord
24,0 cm/9½"

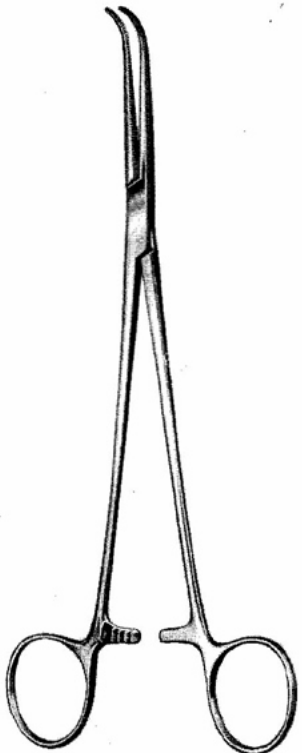
5360.24



Zenker
29,5 cm/11½"

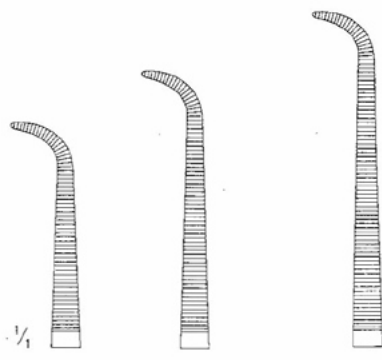
5370.29

5375.29



Gemini

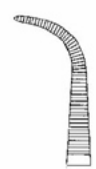
Gemini
mini



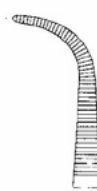
5378.18
18,0 cm

5378.22
22,0 cm

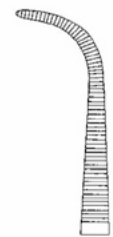
5378.25
25,0 cm



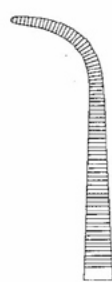
5379.13
13,0 cm



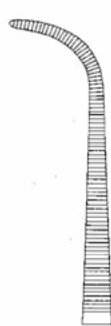
5379.16
16,0 cm



5379.18
18,0 cm



5379.20
20,0 cm



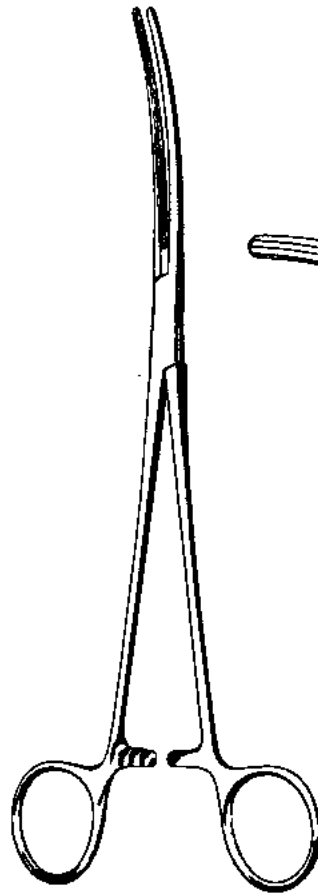
5379.23
23,0 cm



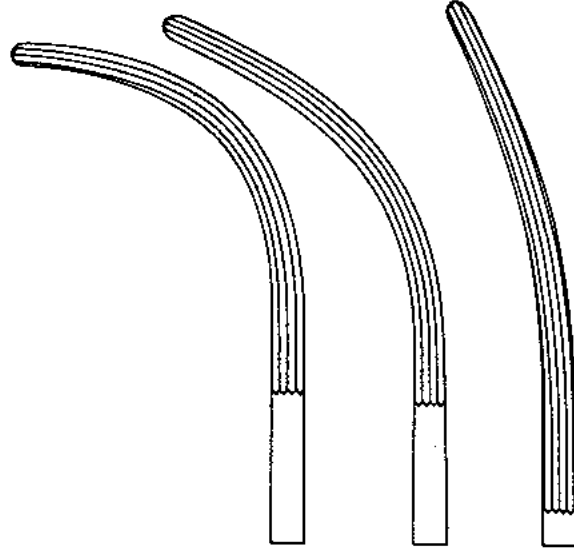
5379.25
25,0 cm

MATTES

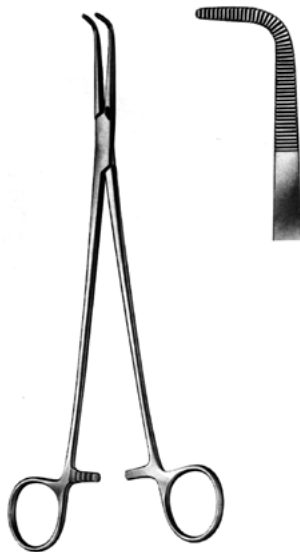
ARTERIENKLEMMEN
HEMOSTATIC FORCEPS
PINZAS HEMOSTÁTICAS
PINZE EMOSTATICHE



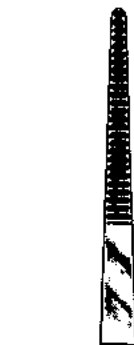
Crafoord-Sellors
24 cm



5383.01 5383.02 5383.03



Kantrowitz
5386.19 19 cm
5386.24 24 cm
5386.26 26 cm

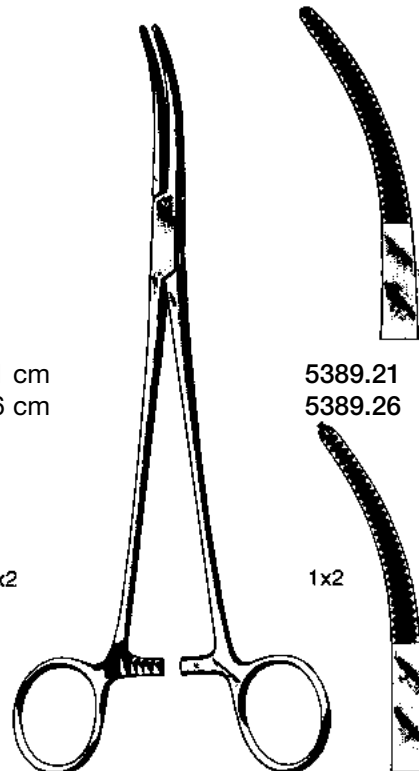


5388.21 21 cm
5388.26 26 cm

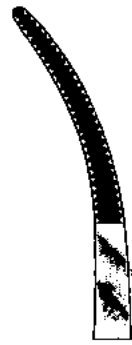


5390.26 26 cm

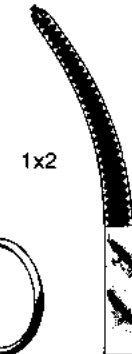
1x2



Toennis



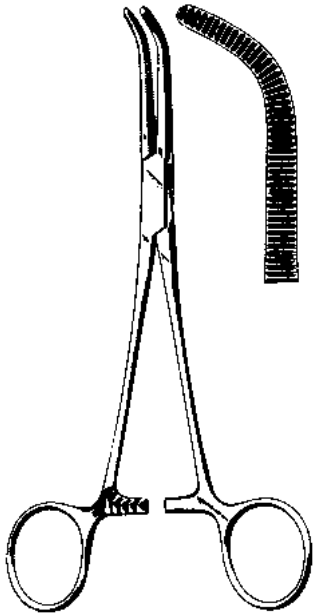
5389.21 21 cm
5389.26 26 cm



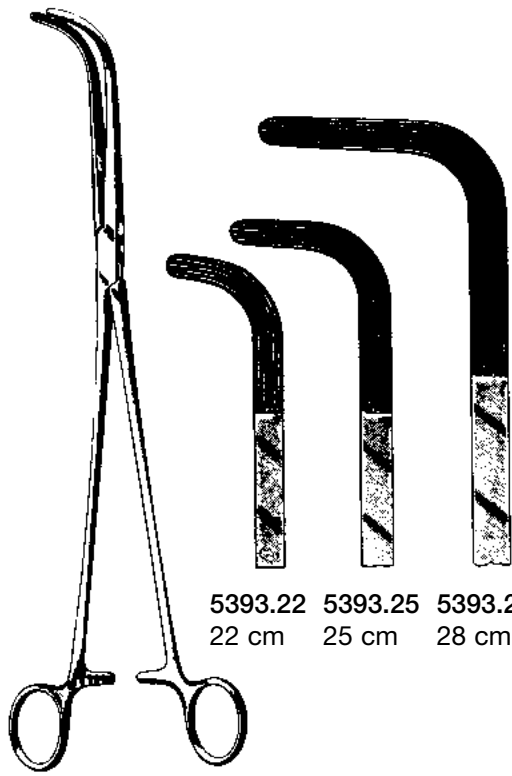
5391.21 21 cm
5391.26 26 cm

1x2

ARTERIENKLEMMEN
HEMOSTATIC FORCEPS
PINZAS HEMOSTÁTICAS
PINZE EMOSTATICHE

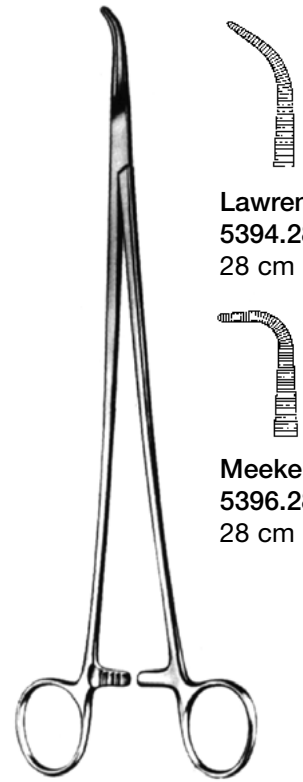


Mixer-O'Shaugnessy
5392.15 15,5 cm
5392.19 19,0 cm



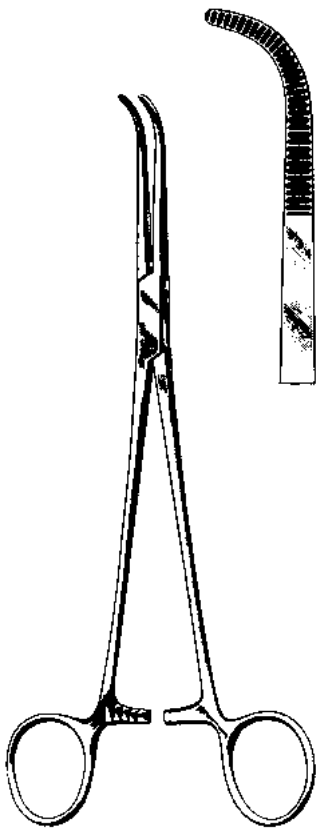
5393.22 22 cm
5393.25 25 cm
5393.28 28 cm

Mixer

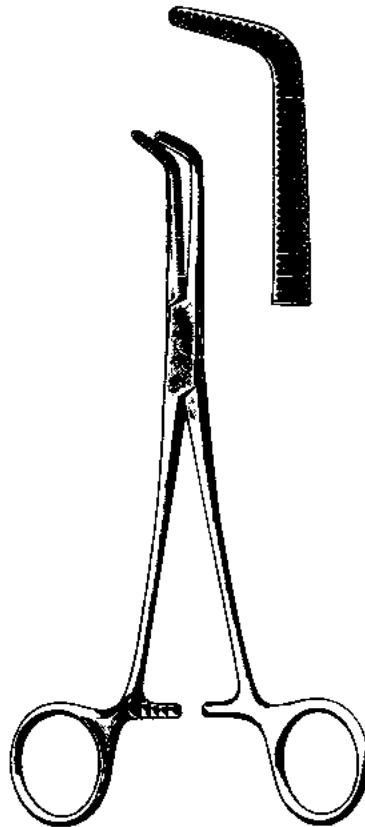


Lawrence
5394.28
28 cm

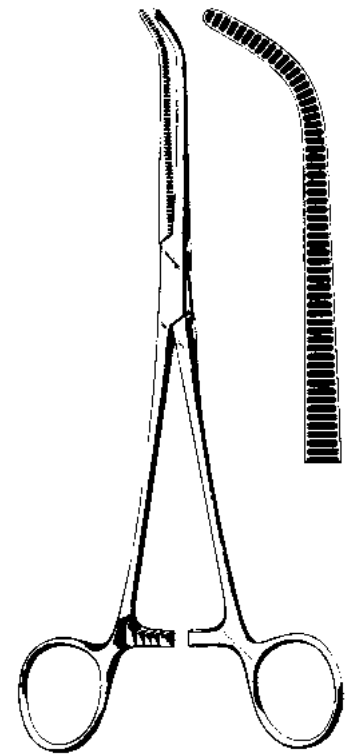
Meeker
5396.28
28 cm



Mixer
5397.22 22 cm



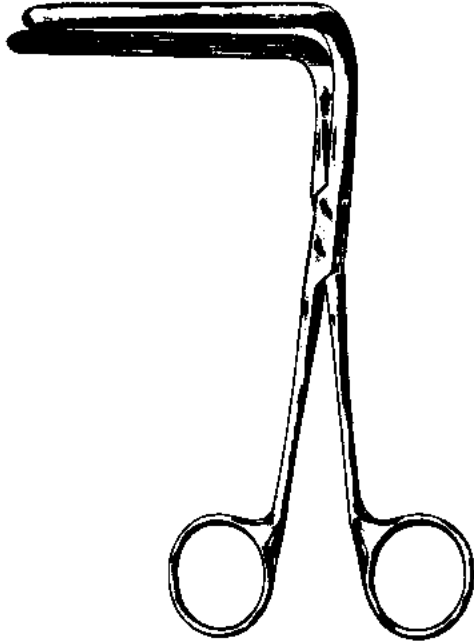
Mixer
5398.14 13,2 cm
5398.16 16 cm
5398.18 18 cm
5398.23 23 cm



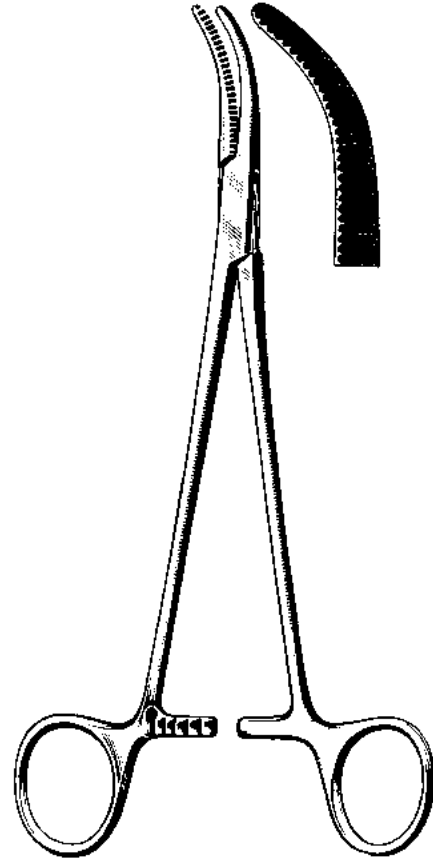
Johns-Hopkins
5399.20 20 cm

MATTES

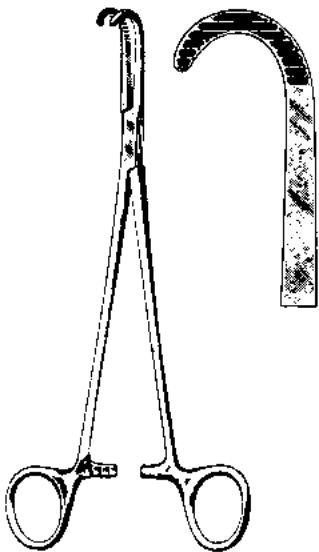
ARTERIENKLEMMEN
HEMOSTATIC FORCEPS
PINZAS HEMOSTÁTICAS
PINZE EMOSTATICHE



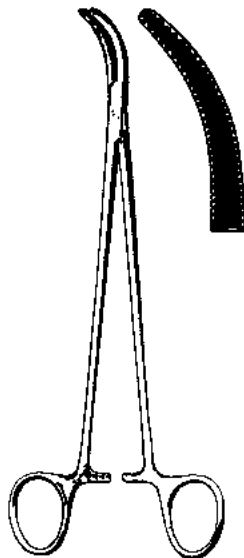
Mixer
5401.16 16,5 cm



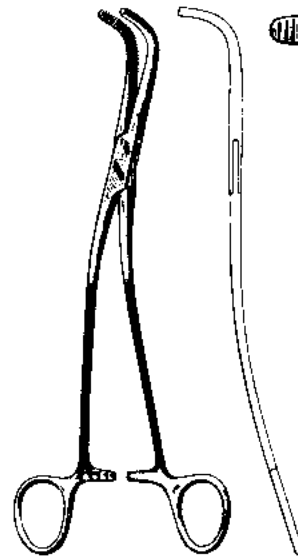
Moynihan
5402.23 23 cm



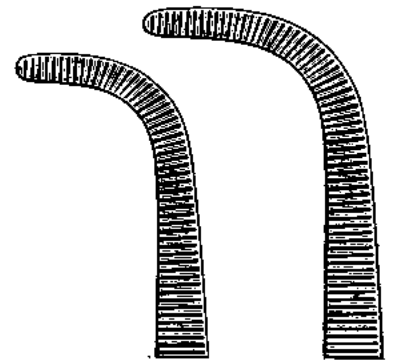
Desjardins
5403.21 21 cm



Desjardins
5404.21 21 cm



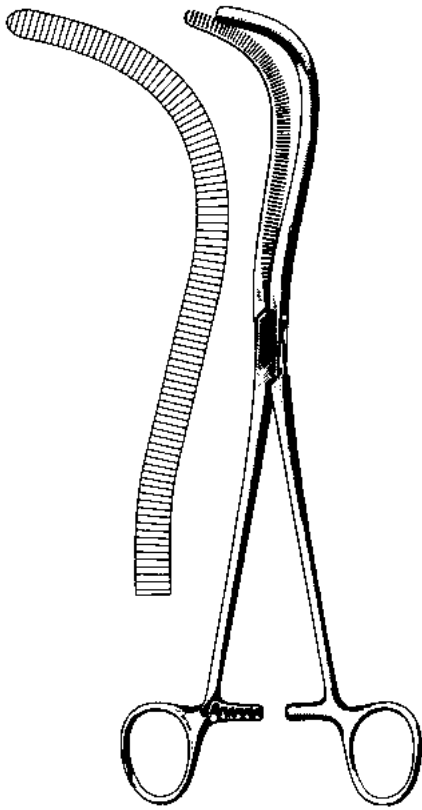
Gray



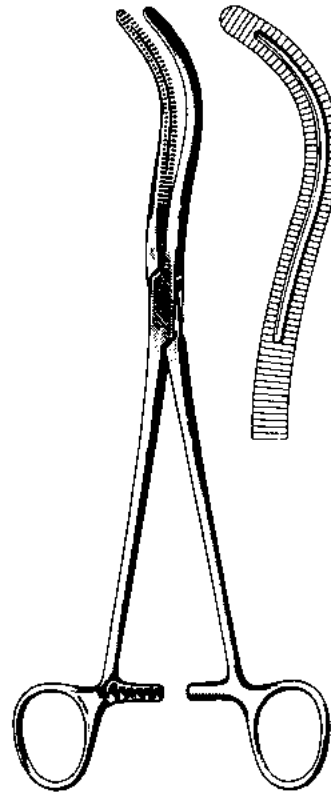
5405.22
22 cm

5405.23
23 cm

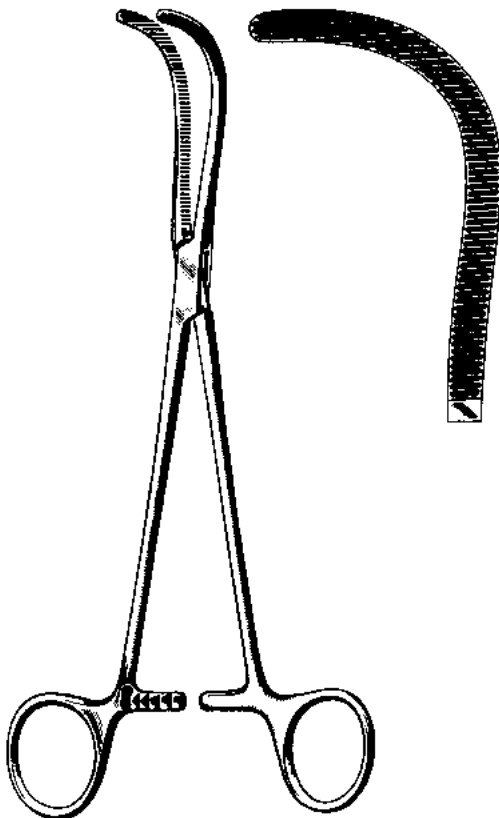
ARTERIENKLEMMEN
HEMOSTATIC FORCEPS
PINZAS HEMOSTÁTICAS
PINZE EMOSTATICHE



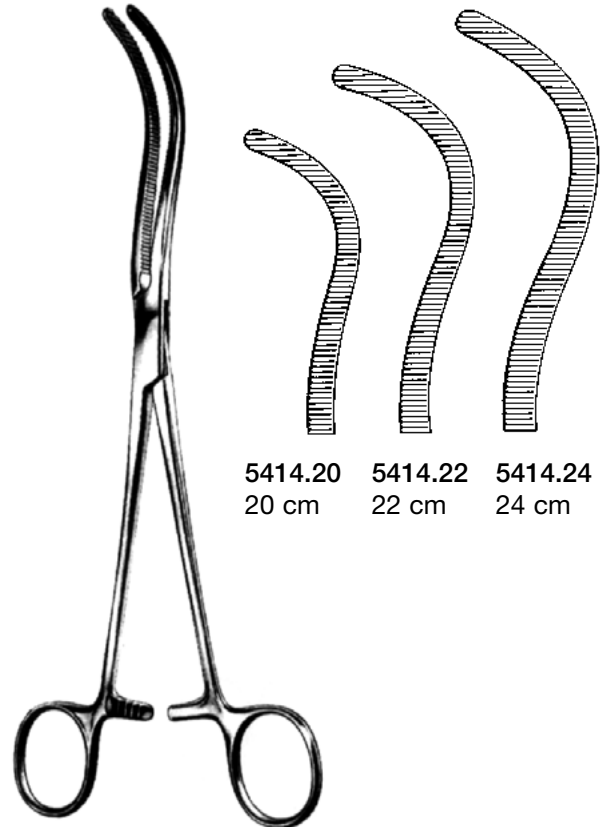
Mayo-Guyon
5411.23 23 cm



Stille
5412.23 23 cm



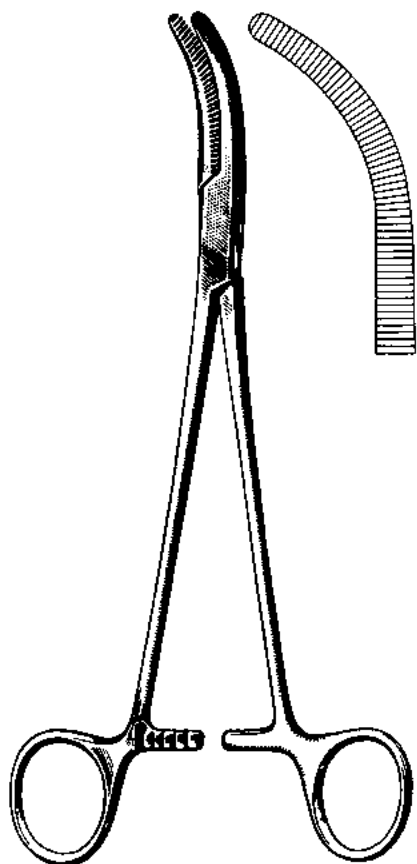
Guyon
5413.23 23 cm



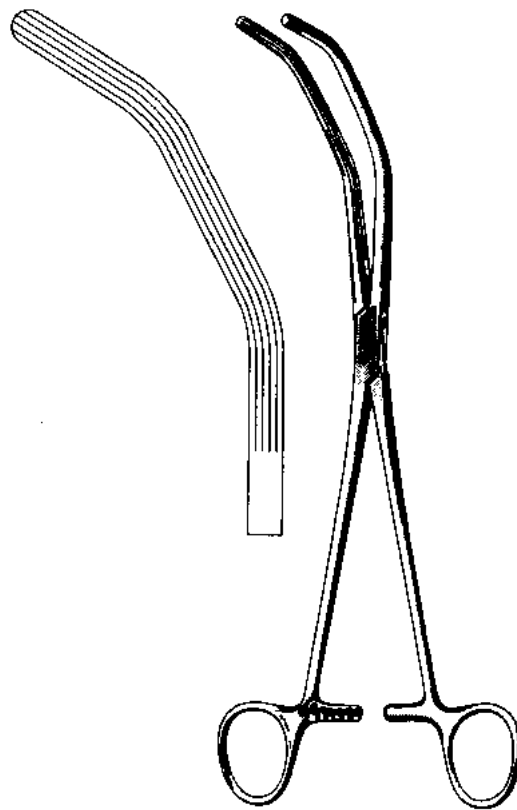
5414.20 20 cm
5414.22 22 cm
5414.24 24 cm

Guyon

HYSTEREKTOMIEKLEMMEN
HYSTERECTOMY FORCEPS
PINZAS PARA HISTERECTOMÍA
PINZE PER ISTERECTOMIA

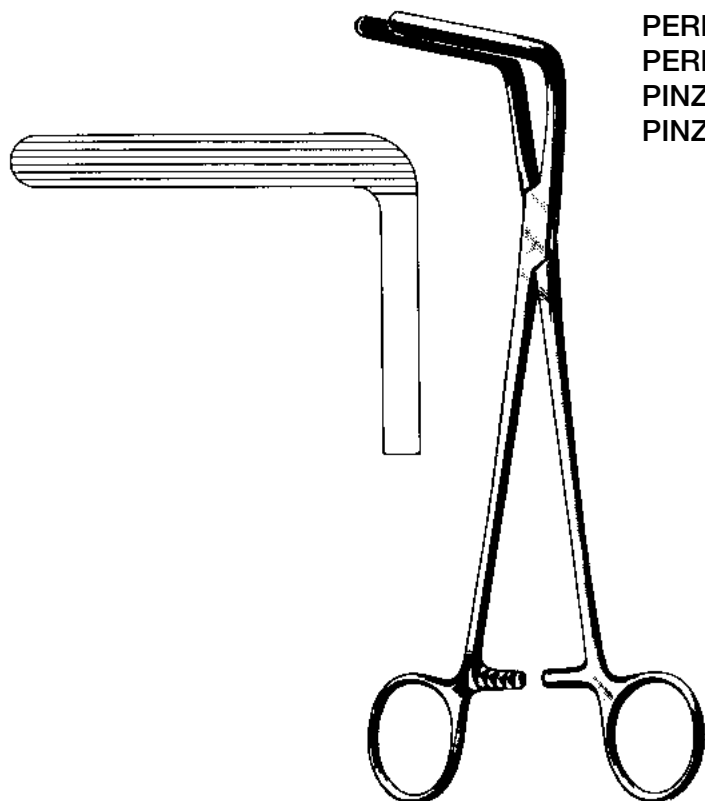


Wertheim
5420.25 25 cm

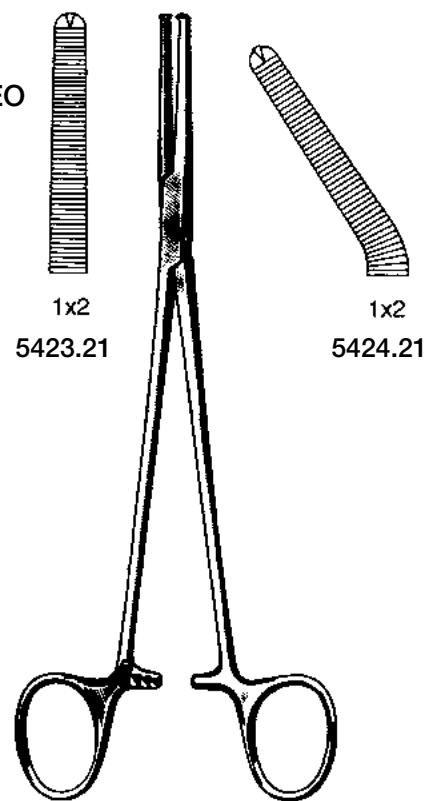


Herrick
5421.23 23 cm

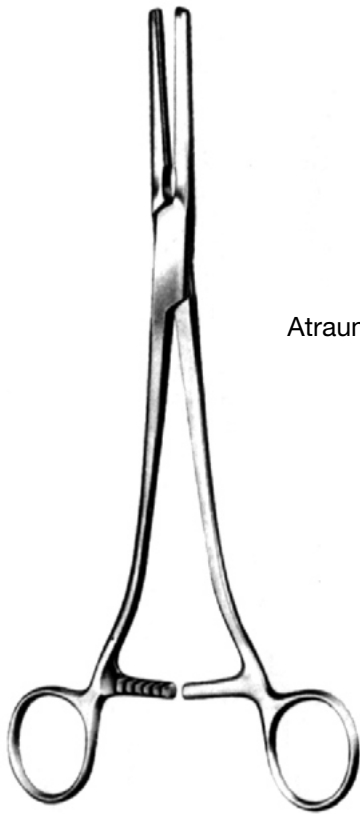
PERITONEUM-KLEMMME
PERITONEUM FORCEPS
PINZAS PARA PERITONEO
PINZE PERITONEALI



Wertheim-Cullen
5422.22 21,5 cm



Phaneuf
5423.21 21 cm 5424.21



Atrauma

Rogers
5425.10 - 5427.40

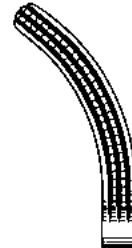
HYSTEREKTOMIEKLEMMEN
HYSTERECTOMY FORCEPS
PINZAS PARA HISTERECTOMÍA
PINZE PER ISTERECTOMIA



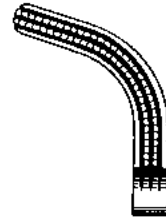
5425.10
22 cm



5425.20
21,5 cm



5425.30
21 cm



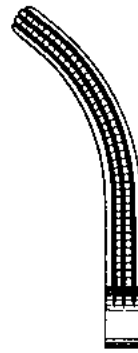
5425.40
20,5 cm



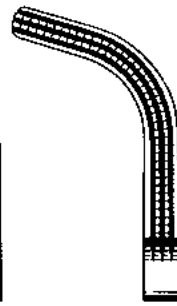
5427.10
25 cm



5427.20
25 cm



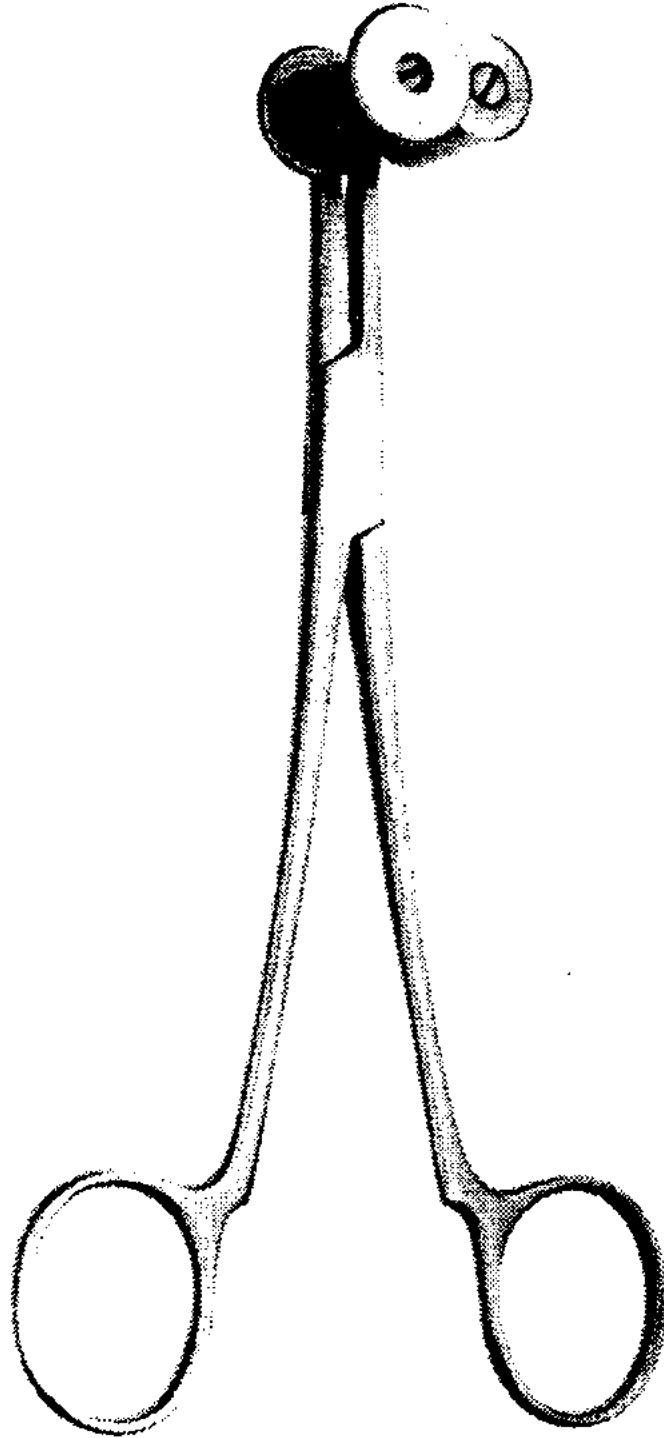
5427.30
24,5 cm



5427.40
23 cm

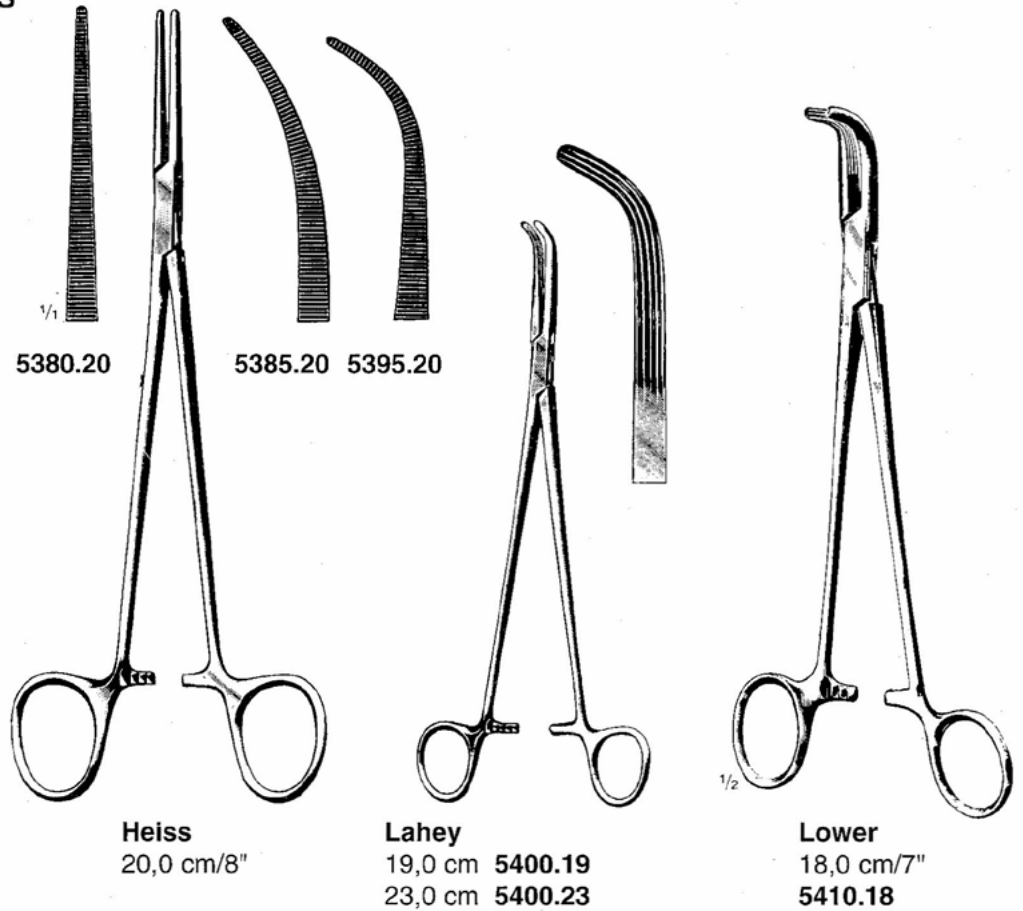
MATTES

SCHLAUCHKLEMME
TUBING CLAMPS
PINZAS CIERRA-TUBOS
PINZE SERRATUBI A RULLI

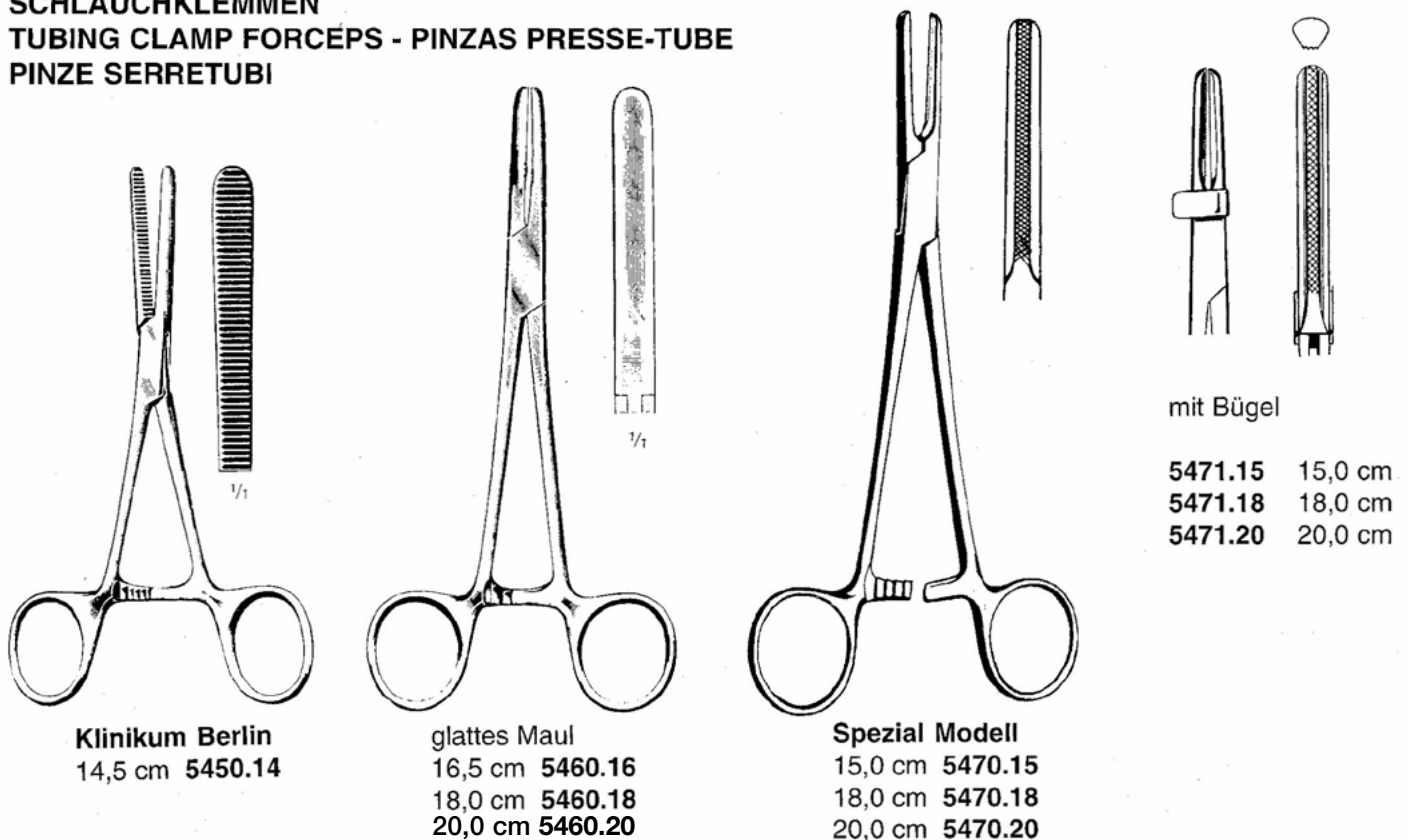


Bülow-Gunar-Hey
5465.18
18 cm

**ARTERIENKLEMMEN
HEMOSTATIC FORCEPS
PINCES HÉMOSTATIQUES
PINZAS HEMOSTÁTICAS
PINZE EMOSTATICHE**



**SCHLAUCHKLEMMEN
TUBING CLAMP FORCEPS - PINZAS PRESSE-TUBE
PINZE SERRETUBI**

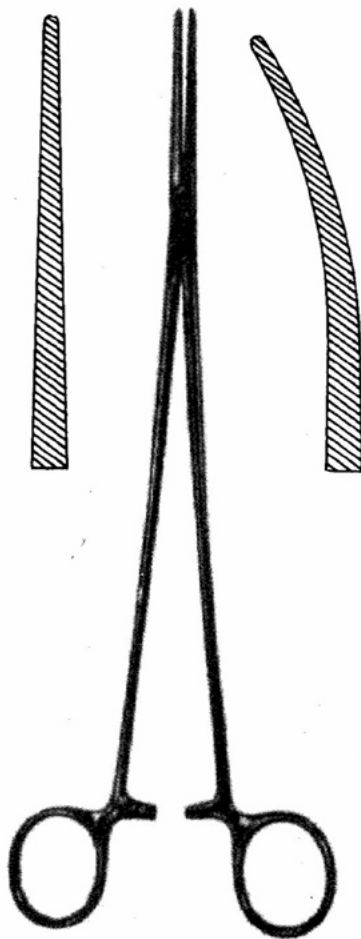


mit Bügel

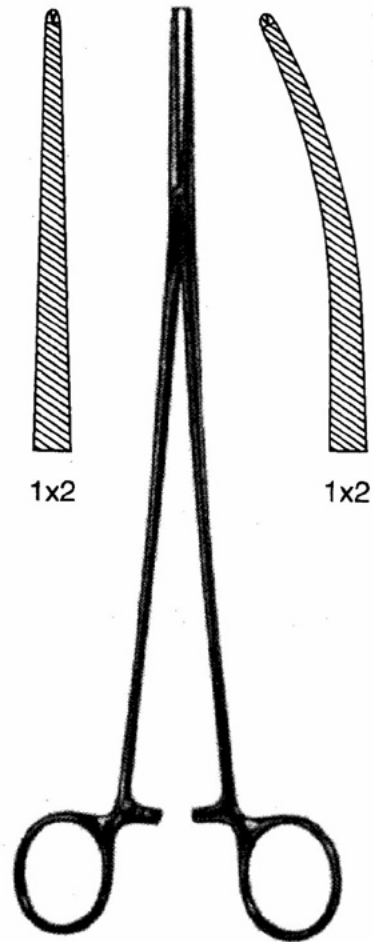
- 5471.15 15,0 cm
- 5471.18 18,0 cm
- 5471.20 20,0 cm

MATTES

ARTERIENKLEMMEN
 HEMOSTATIC FORCEPS
 PINCES HÉMOSTATIQUES
 PINZAS HEMOSTÁTICAS
 PINZE EMOSTATICHE

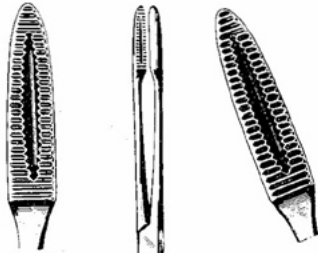


Bengolea
 5356.20 20 cm 5357.20
 5356.26 20 cm 5357.26



Bengolea
 5358.20 20 cm 5359.20
 5358.26 20 cm 5359.26

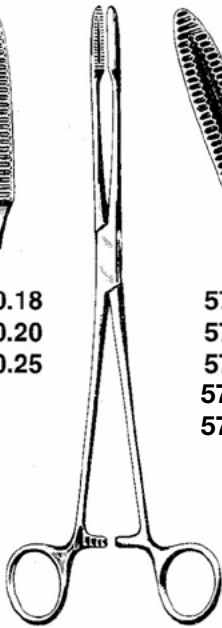
TUPFERZANGEN POLYPENZANGEN - COTTON SWAB FORCEPS
 POLYPUS AND DRESSING FORCEPS
 PINZAS PARA TAMPONES
 PINZAS PARA PÓLIPOS
 PINZE PER TAMPONI POLIPI



5790.18
 5790.20
 5790.25



5795.18
 5795.20
 5795.25
 5795.35
 5795.40



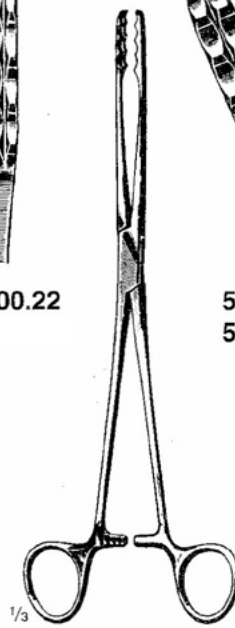
Maier
 18,0 cm/20,0 cm/25,0 cm



5800.22



5805.22
 5805.25



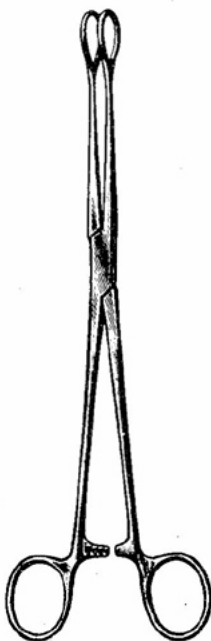
Ulrich
 22,0 cm/25,0 cm



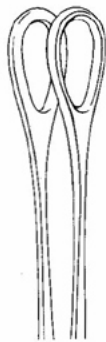
1/1



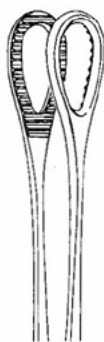
Rampley
 25,0 cm/10" 5860.25



Förster
 18,0 cm/20,0 cm/25,0 cm



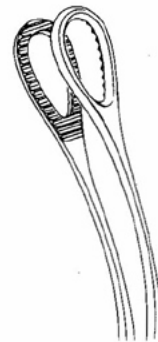
5820.25
 glatt
 smooth



5830.18
 5830.20
 5830.25
 gerieft
 serrated
 5830.30

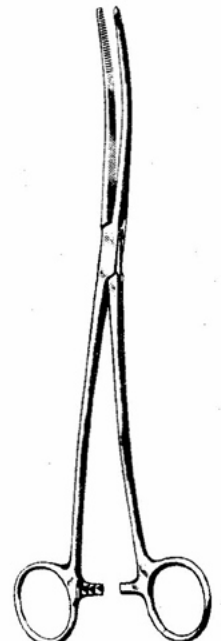


5825.25
 glatt
 smooth



5835.18
 5835.20
 5835.25
 gerieft
 serrated

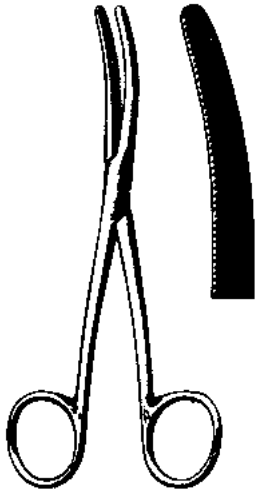
Förster



Bozemann
 26,0 cm/10 1/4"
 5880.26

MATTES

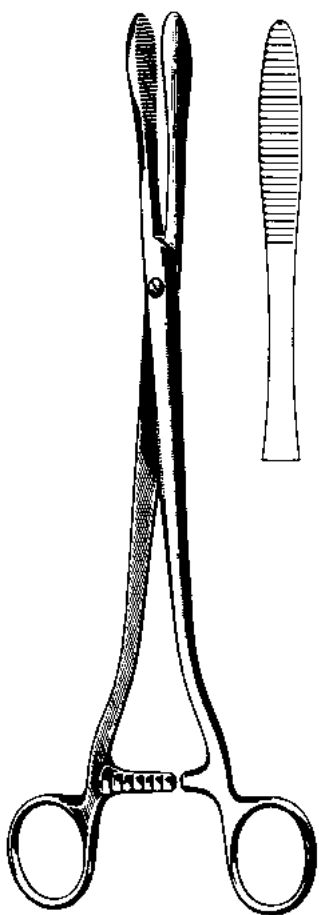
TUPFERZANGEN
DRESSING FORCEPS
PINZAS-PORTA-ESPONJAS
PINZE PER TAMPONI



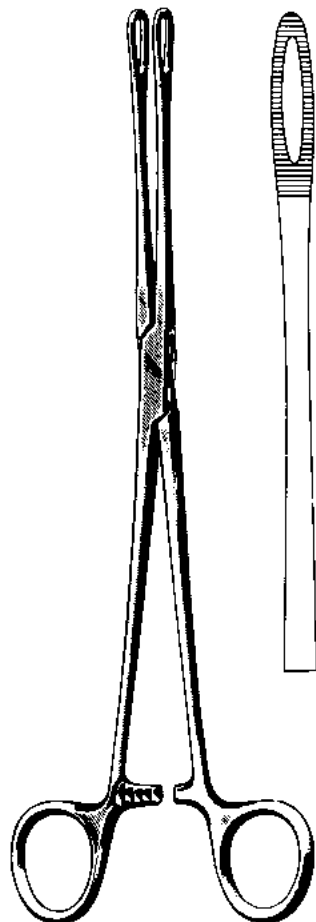
Bryant
5881.13 13 cm



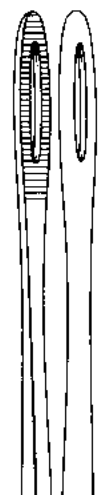
Lister (Sinus)
5882.13 13 cm
5882.16 16 cm
5882.18 18 cm



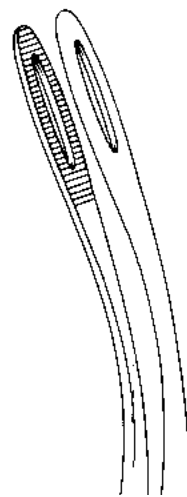
Collin
5885.25 25 cm



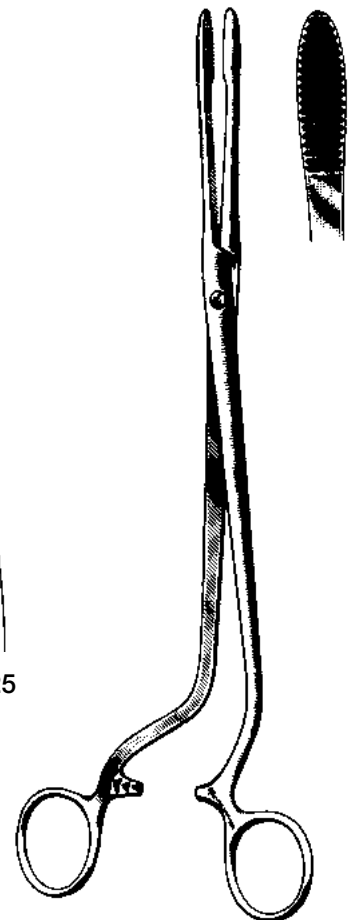
Foerster
5887.25 - 5888.25



5887.25
25 cm

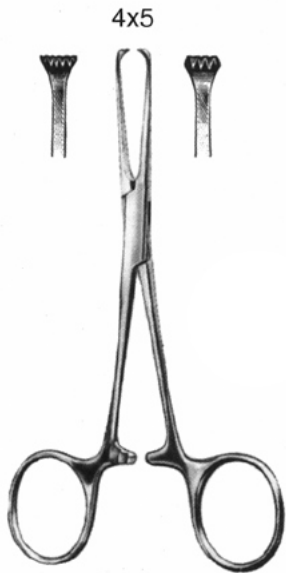


5888.25
25 cm



Cheron
5890.25 25 cm

DARM- UND GEWEBEFASSZANGEN
BOWEL AND TISSUE GRASPING FORCEPS
PINCES À SAISIR LES INTESTINS ET LES TISSUS
PINZAS PARA COGER INTESTINOS Y TEJIDOS
PINZE PER AFFERRARE INTESTINI E TESSUTI



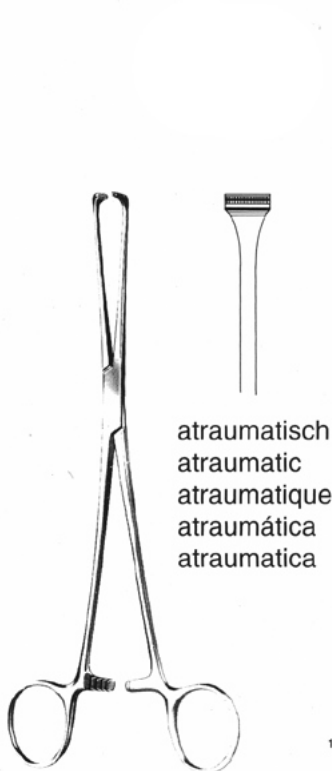
Allis-Baby
 5969.12 12 cm
 5969.14 14 cm



Allis
 4x5 15,0 cm 5970.15
 5x6 15,0 cm 5975.15
 5x6 18,0 cm 5980.18
 5x6 24,0 cm 5990.24

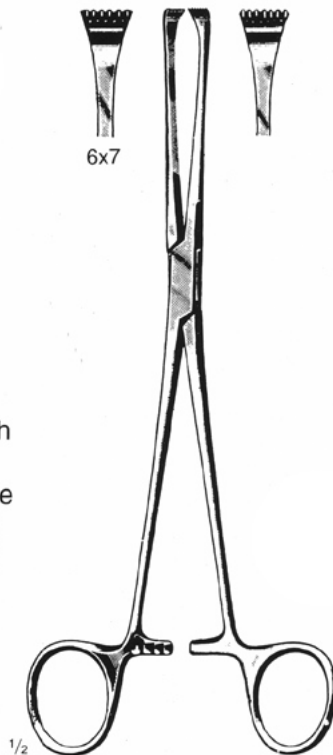


Judd-Allis
 15,0 cm 6010.15
 19,0 cm 6015.19

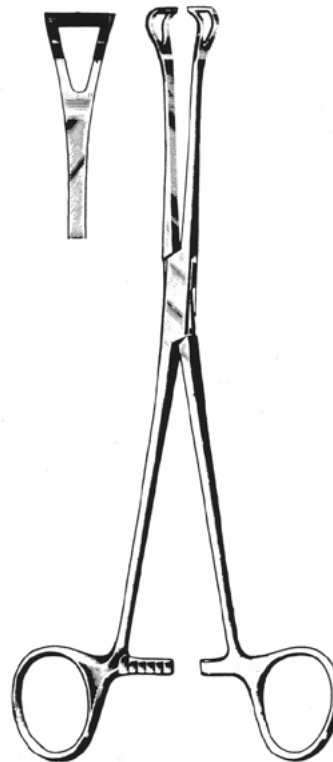


atraumatisch
 atraumatic
 atraumatique
 atraumática
 atraumatica

Allis
 16,0 cm 6017.16
 20,0 cm 6017.20
 25,0 cm 6017.25



Thoms-Allis
 20,0 cm 6020.20



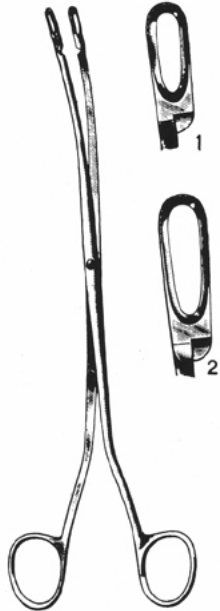
atraumatisch
 atraumatic
 atraumatique
 atraumática
 atraumatica

Babcock
 16,0 cm 6032.16
 20,0 cm 6032.20

Babcock
 16,0 cm 6030.16
 18,0 cm 6030.18
 20,0 cm 6030.20

MATTES

GALLENSTEINZANGE - NIERENSTEINZANGE
GALL STONE FORCEPS - KIDNEY FORCEPS
PINZAS PARA CÁLCULOS BILIARES - PINZAS PARA RIÑÓN
PINCES RENALE



Desjardin
 23,0 cm
 Fig. 1 6035.01
 Fig. 2 6035.02



Fig. 4 Fig. 3 Fig. 2 Fig. 1

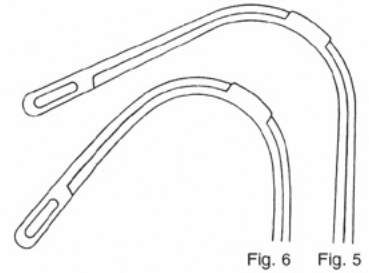
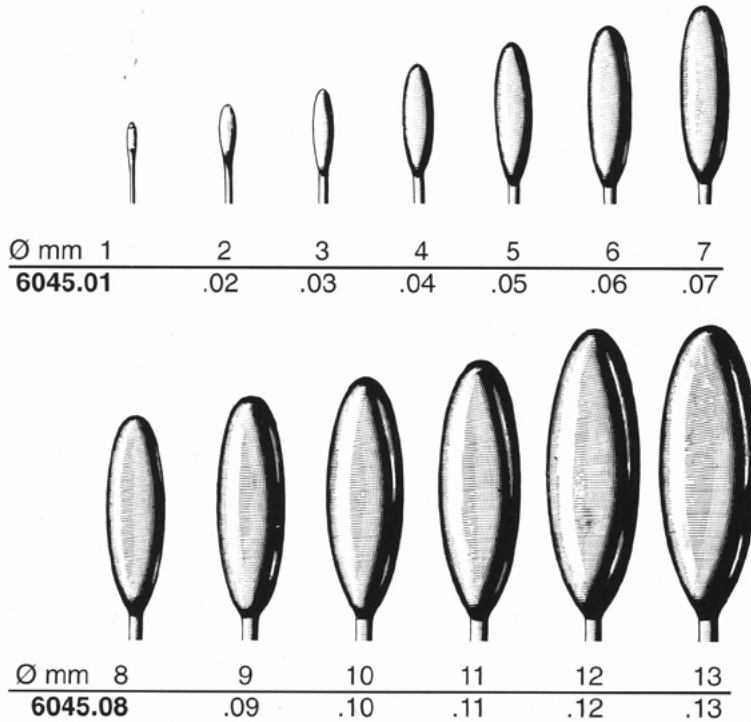


Fig. 6 Fig. 5

Randall	Fig.	cm
6040.01	1	23,0
6040.02	2	22,0
6040.03	3	22,0
6040.04	4	22,0
6040.05	5	19,0
6040.06	6	19,0



Ø mm 1 2 3 4 5 6 7
 6045.01 .02 .03 .04 .05 .06 .07

Ø mm 8 9 10 11 12 13
 6045.08 .09 .10 .11 .12 .13

.Bakes
 6045.01 bis 6045.13



Pelkmann
 6050.25
 25,0 cm

GALLENSTEINZANGEN
 GALL STONE FORCEPS
 PINZAS PARA CÁLCULOS BILIARES
 PINZE PER CALCOLI BILIARI



Elsässer
 6056.20 20 cm



Blake
 6057.20 20 cm



6058.20
 20 cm



Mayo-Blake
 6059.20 20 cm



Mayo-Blake
 6060.20 20 cm

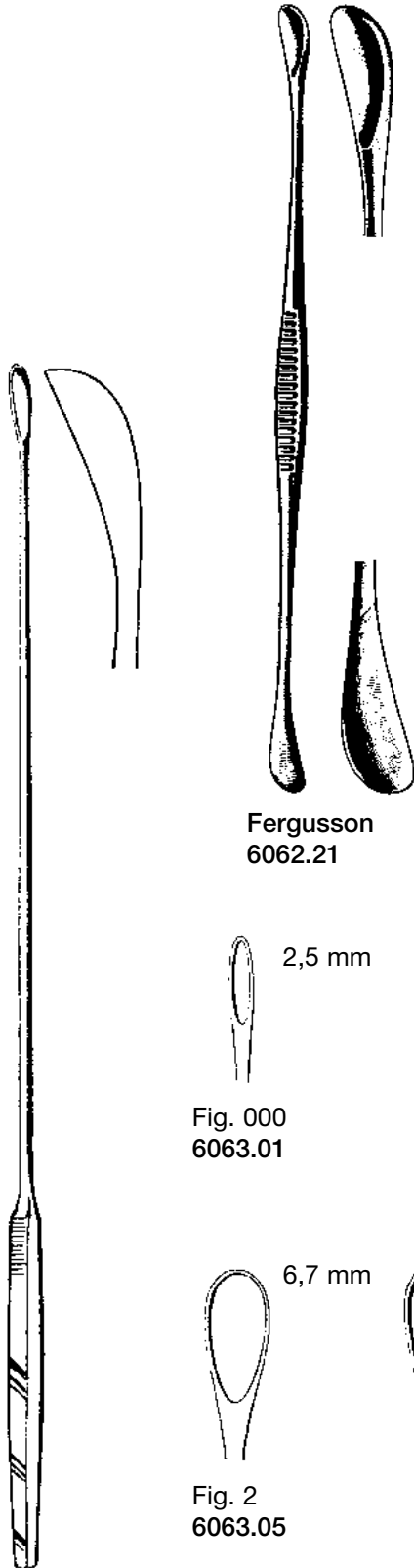


Mixer
 6061.22 22 cm

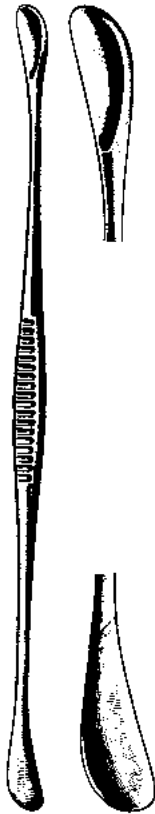
MATTES

GALLENSTEINLÖFFEL
 GALL STONE SCOOPS
 CUCHARILLAS PARA CÁLCULOS BILIARES
 CUCCIAI PER CALCOLI BILIARI

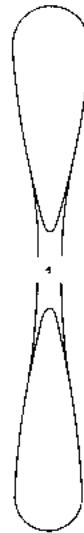
biegsam
 malleable
 maleables
 malleabili



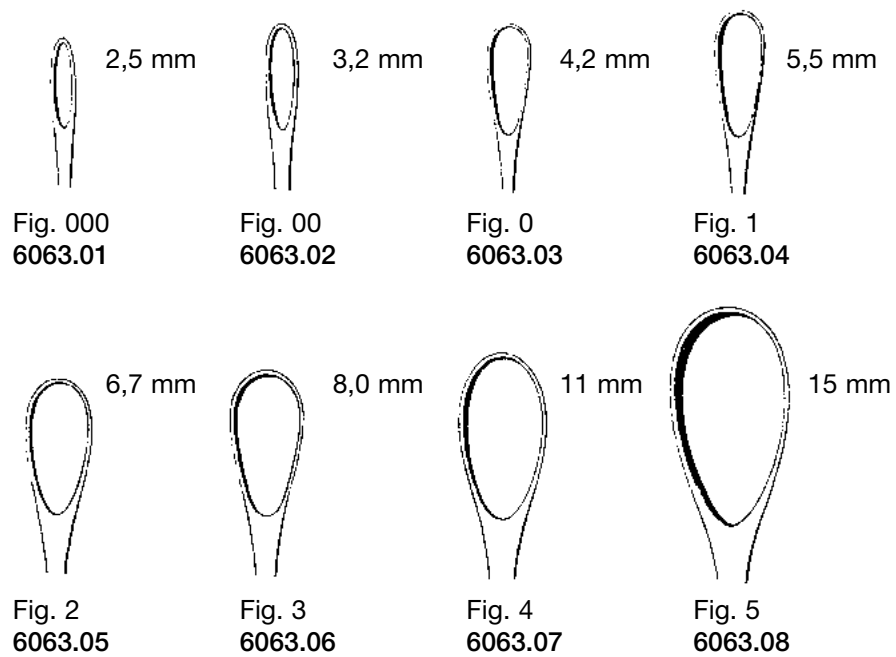
Luer-Koerte
 6063.01 - 6063.08
 32 cm



Fergusson
 6062.21



6062.21
 21,5 cm



GALLENSTEINLÖFFEL
 GALL STONE SCOOPS
 CUCHARILLAS PARA CÁLCULOS BILIARES
 CUCCIAI PER CALCOLI BILIARI



Mayo
 6064.27 27 cm



Mayo
 6065.01 - 6065.03
 27 cm

6065.01
 klein, small, pequeña, piccola

6065.03
 groß, large, grande



federnd
 elastic
 elásticas
 elastiche

Desjardins
 6066.01 - 6066.04



17 Charr.

Fig. 1
 6066.01



21 Charr.

Fig. 2
 6066.02



24 Charr.

Fig. 3
 6066.03



27 Charr.

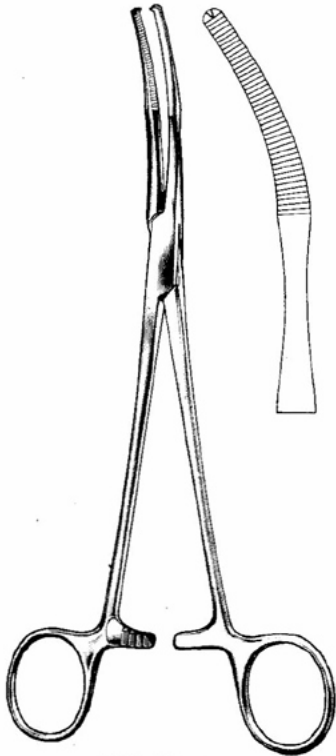
Fig. 4
 6066.04



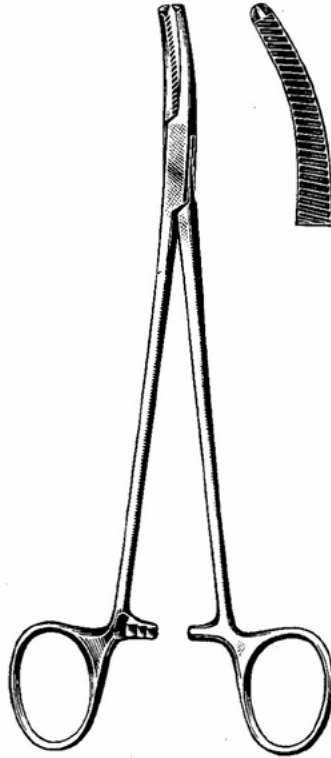
Mayo
 6067.32 32 cm

MATTES

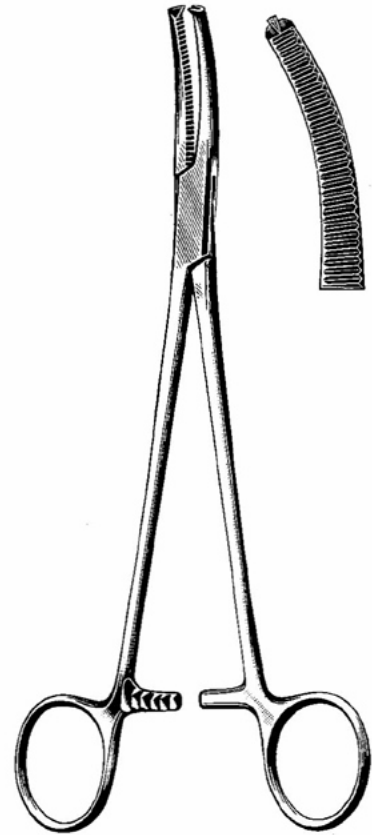
HYSTEREKTOMIE-KLEMMEN
 HYSTERECTOMY FORCEPS
 PINCES À HYSTERECTOMIE
 PINZAS PARA HISTERECTOMIA
 PINZE PER ISTERECTOMIA



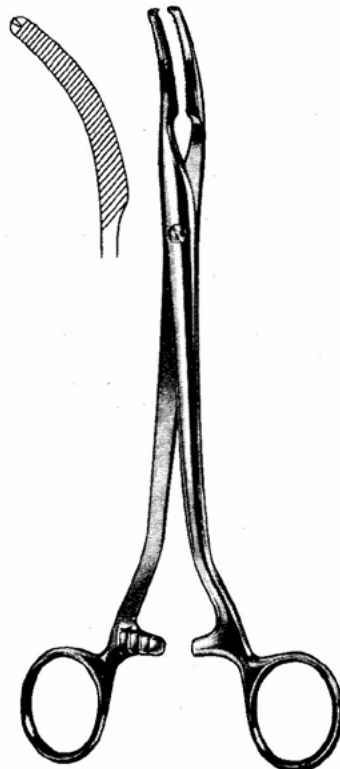
Mikulicz
 20,0 cm/8"
 6070.20



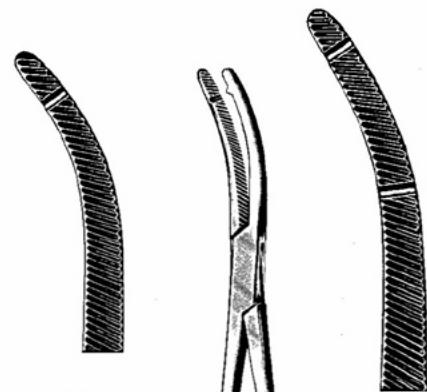
Mikulicz Faure
 20,0 cm
 6075.20



Wertheim
 23,0 cm
 6080.23

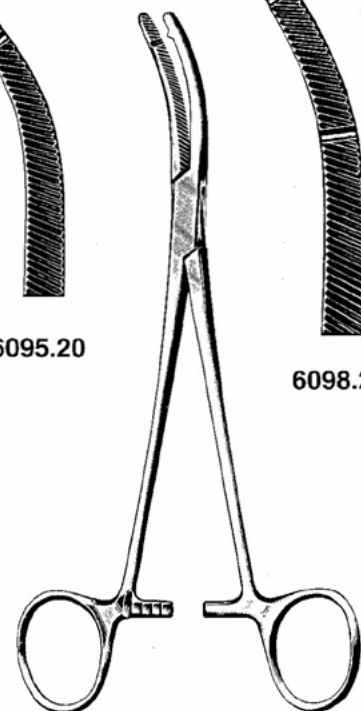


Mikulicz
 20,0 cm 6090.20



6095.20

6098.20



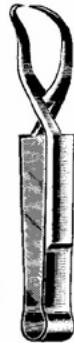
Heany
 20,0 cm

**TUCHKLEMMEN
TOWEL FORCEPS
PINCES À CHAMPS
PINZAS PARA CAMPOS
PINZE FISSATELI**

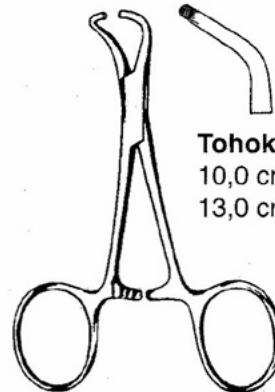
Jones-Clip
6129.09 9 cm



Schaedel
6130.09



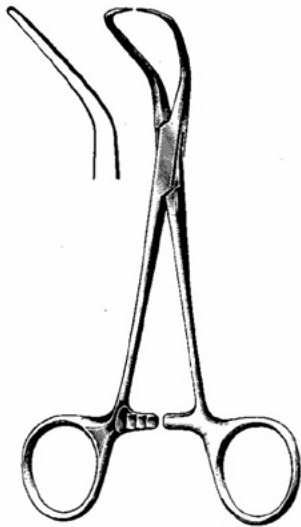
Jones
6135.09



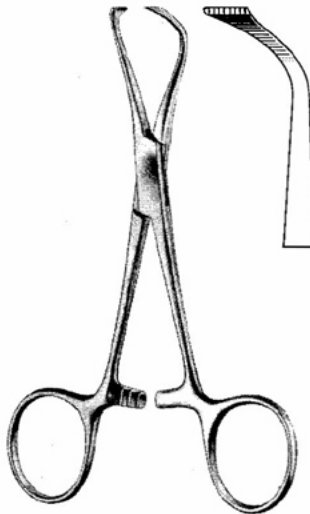
Tohoku
10,0 cm 6137.10
13,0 cm 6137.13



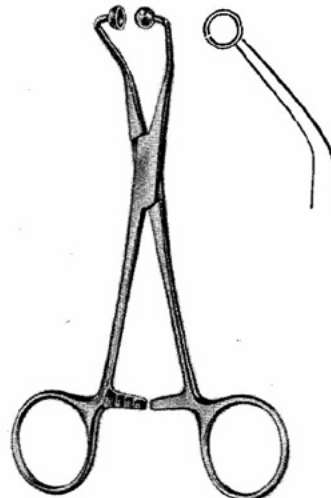
Peers
6138.14 14,5 cm



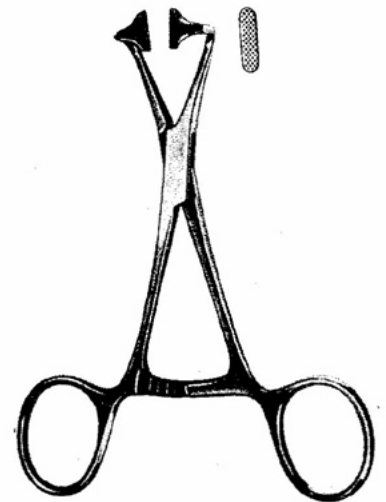
Backhaus
9,0 cm 6140.09
11,0 cm 6140.11
13,0 cm 6140.13



Lorna
10,0 cm 6145.10
13,0 cm 6145.13

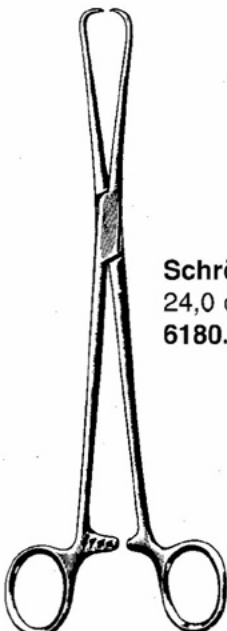


Ball+Socket
11,5 cm 6160.11
13,0 cm 6160.13

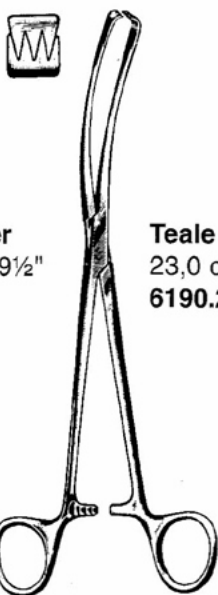


Papier-Tuchklemme
13,0 cm 6165.13

**HAKENZANGE
TENACULUM FORCEPS
PINCES POUR ABAISSEMENT DU COL DE L'UTÉRUS
PINZAS PARA COGER CUELLO DEL ÚTERO
PINZE PER ABBASSARE IL COLLO DELL'UTERO**



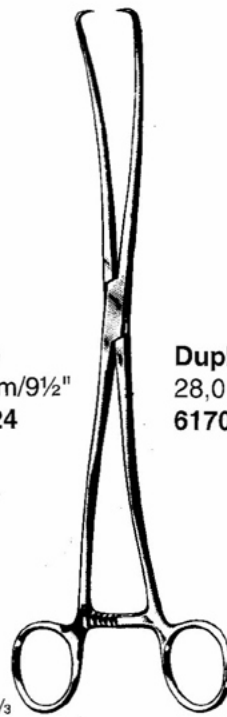
Schröder
24,0 cm/9½"
6180.24



Teale
23,0 cm/9"
6190.23



Skene
24,0 cm/9½"
6171.24



Duplay
28,0 cm/11"
6170.28

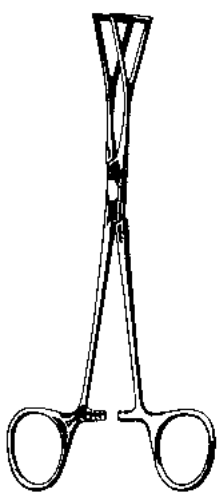
MATTES

LUNGENFASSZANGE, BRONCHUSKLEMMEN

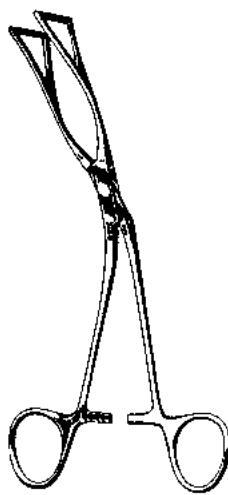
LUNG GRASPING FORCEPS, BRONCHUS FORCEPS

PINZAS PARA COGER EL PULMÓN, PINZAS CLAMPS BRONQUIALES

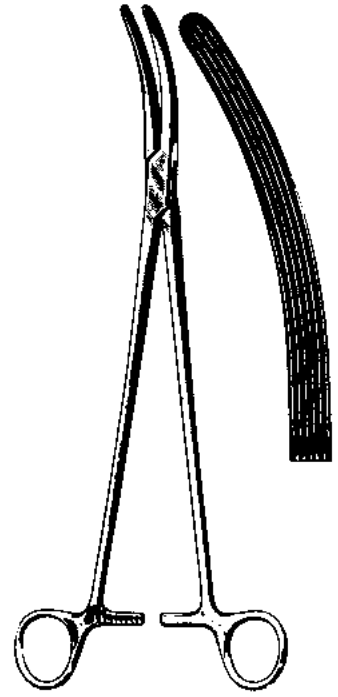
PINZE PER AFFERRARE IL POLMONE, PINZE PER BRONCHI



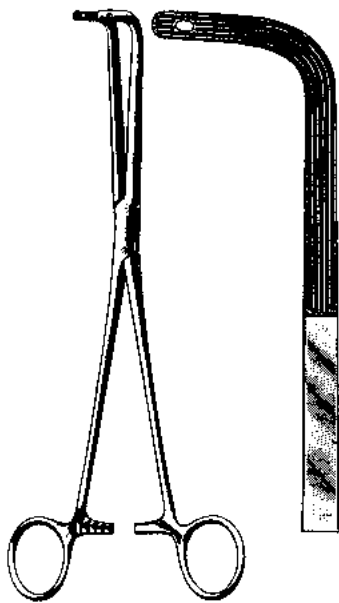
Lovelace
6201.20 20 cm



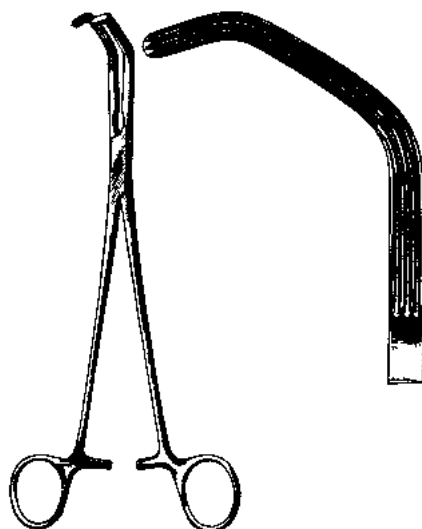
Lovelace
6202.20 20 cm



Harrington
6203.30 30,5 cm

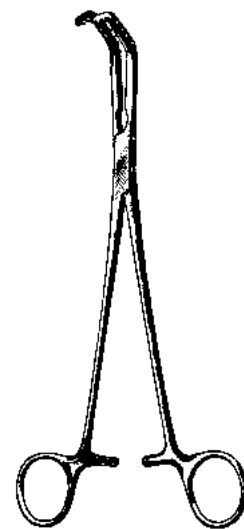


Finocchietto
6204.24 24 cm



Price-Thomas
6205.22 22 cm

Zähne links
tooth left
diente izquierda
dente sinistro
6206.22



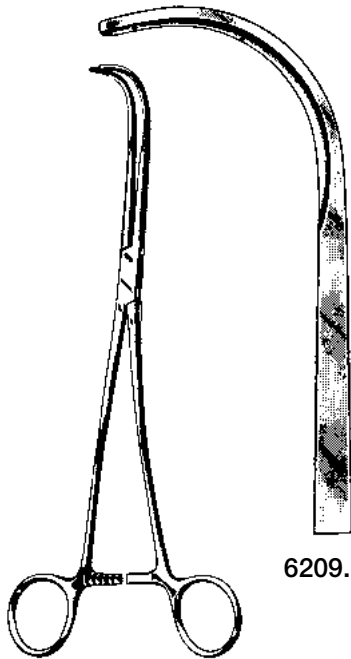
Price-Thomas
22 cm

rechts
right
derecha
destro
6207.22

GEFÄSSKLEMMEN
 BLOOD VESSEL CLAMPS
 PINZAS-CLAMPS PARA VASOS
 PINZE CARDIOVASCOLARI

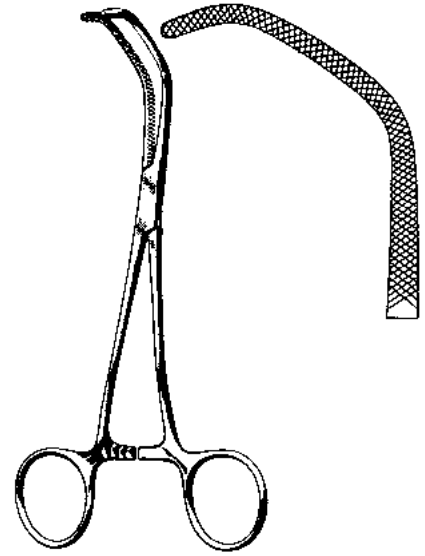


6208.23

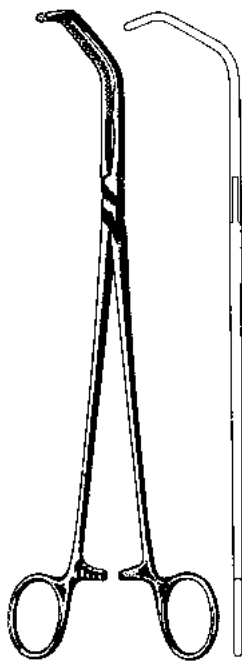


6209.23

Semb
 23 cm



Satinsky
 6211.15 15 cm



Satinsky
 6212.01 - 6212.02
 26 cm

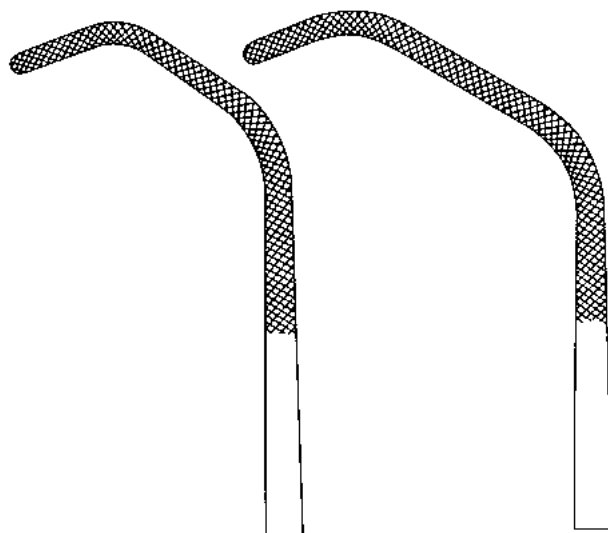


Fig. 1
 6212.01

Fig. 2
 6212.02

MATTES

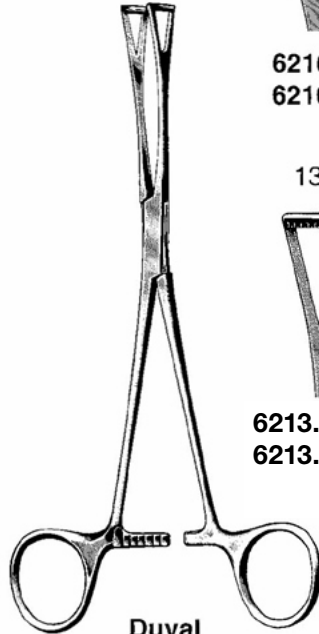
DARM, MAGEN
 INTESTINES AND STOMACH
 INTESTIN, ESTOMAC
 INTESTINES, ESTÓMAGO
 INTESTINI, STOMACO



6200.15
 6200.21
 6200.29
 6200.35

Payr

15,0 cm
 21,0 cm
 29,0 cm
 35,0 cm



Duval
 18,0 und 20,0 cm

25mm

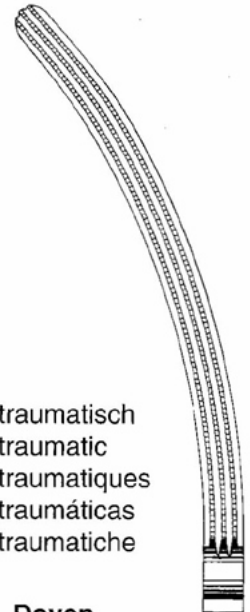


6210.20
 6210.23

13mm



6213.18
 6213.20

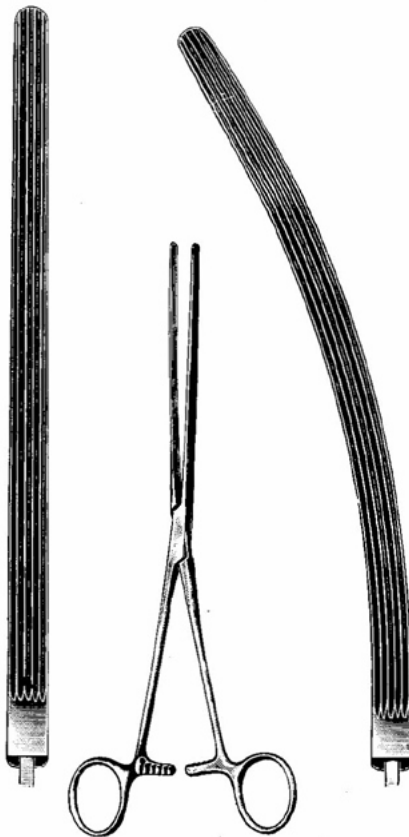


atraumatisch
 atraumatic
 atraumatiques
 atraumáticas
 atraumatiche

Doyen

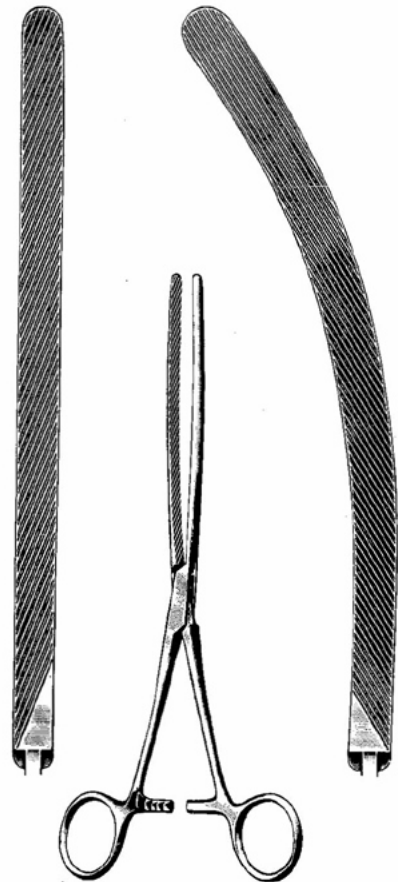
6220.18 18,0 cm 6225.18

6220.23 23,0 cm 6225.23



Kocher-Doyen

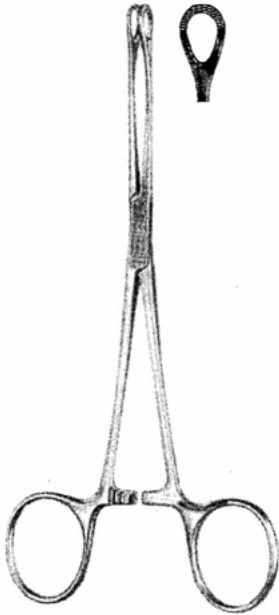
6240.22 22,0 cm 6245.22
 6240.25 25,0 cm 6245.25
 6240.28 28,0 cm 6245.28



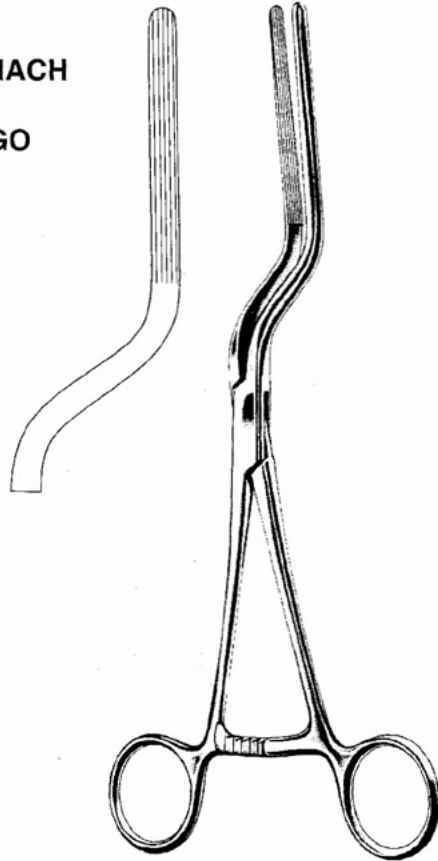
Doyen

6250.21 21,0 cm 6255.21
 6250.23 23,0 cm 6255.23

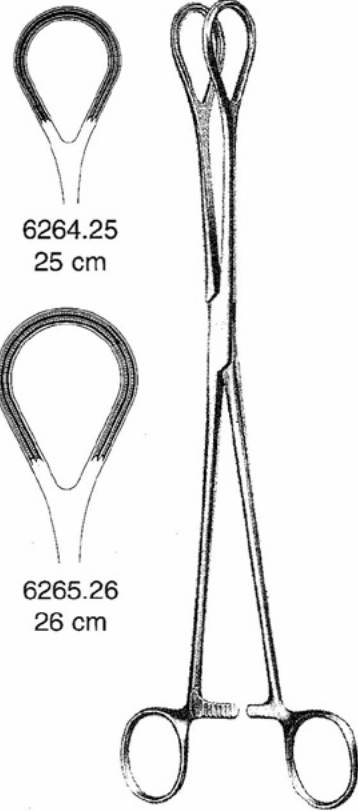
DARM, MAGEN
 INTESTINES AND STOMACH
 INTESTIN, ESTOMAC
 INTESTINES, ESTÓMAGO
 INTESTINI, STOMACO



Williams
 6261.16 16,5 cm



Brunner
 6262.24 24 cm

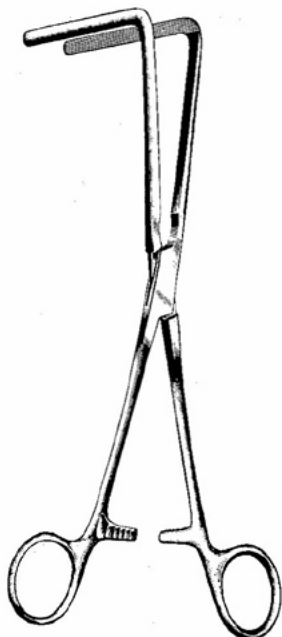
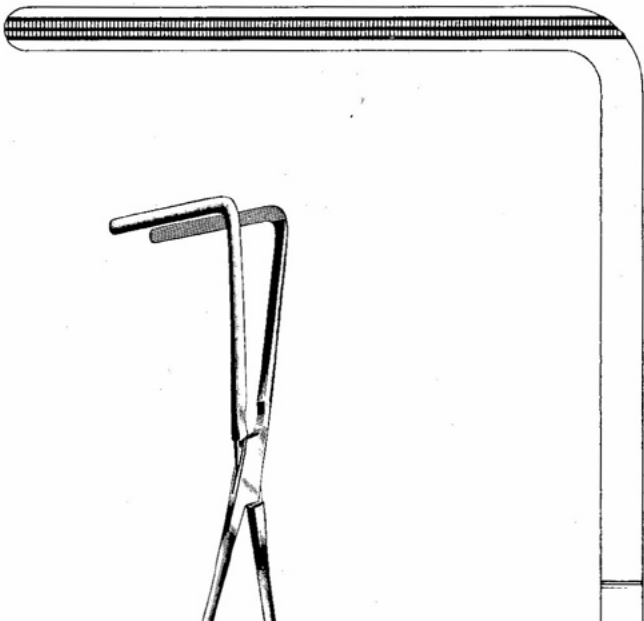


Atrauma

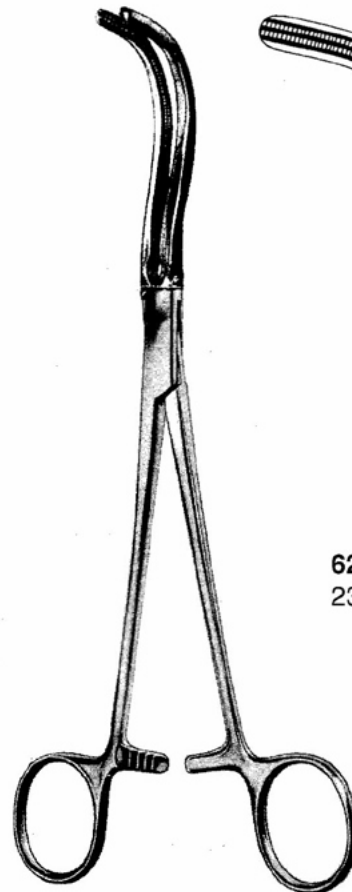
6264.25
 25 cm

6265.26
 26 cm

ATRAUMA



Fehland Atrauma
 23,5 cm 6270.24



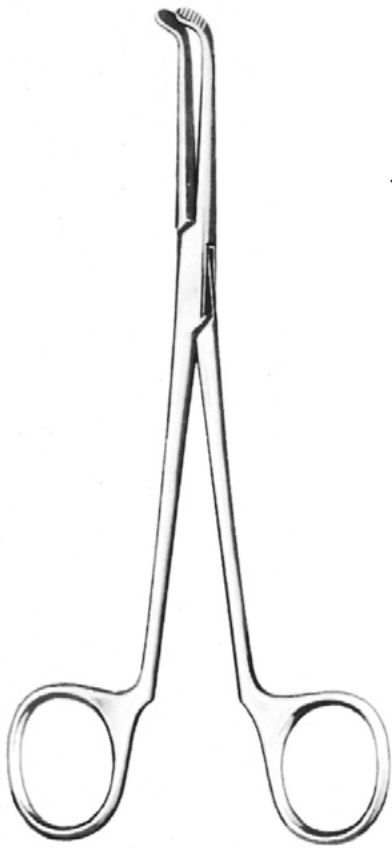
Guyon Atrauma

6275.23
 23,0 cm

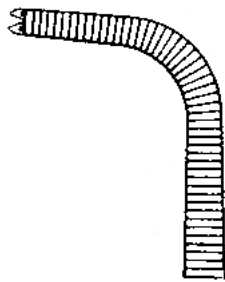
6275.24
 24,0 cm

MATTES

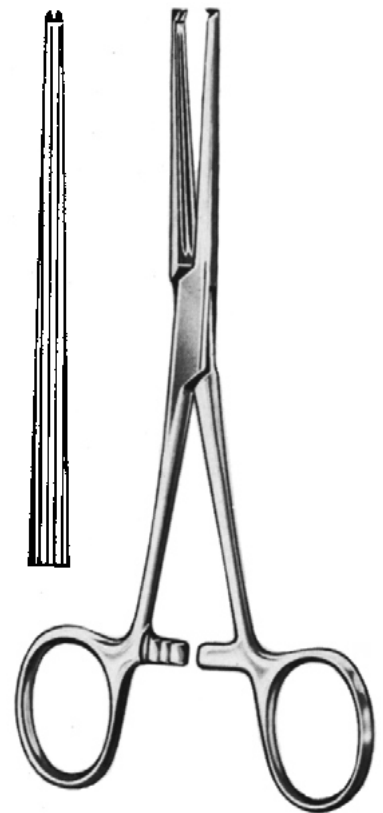
PYLORUSSPREIZER, BLINDDARMKLEMMEN
 PYLORUS SPREADER, BLINDGUT FORCEPS
 SEPARADOR PARA PÍLORO, PINZAS PARA APÉNDICE
 DIVARICATORI PER PÍLORO, PINZA PER APPÉNDICE



Benson
 6276.15 15,5 cm



Kleinschmidt
 6277.12 12 cm

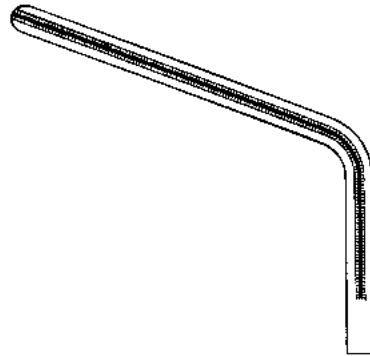


Allen
 6278.15 15 cm
 6278.20 20 cm

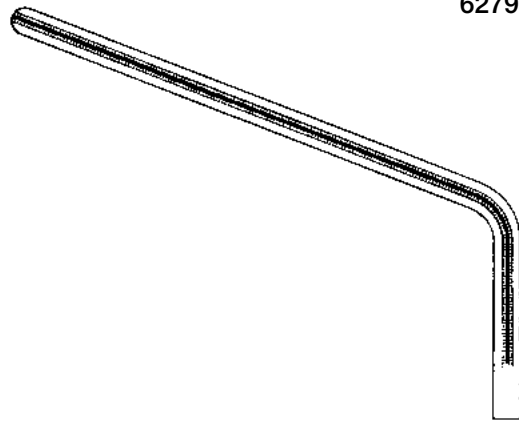
ATRAUMA REKTUM-ANASTOMOSENKLEMMEN, ANOSTOMOSENKLEMMEN
 ATRAUMA SIGMOID ANASTOMOSIS FORCEPS, ANASTOMOSIS CLAMP FORCEPS
 PINZAS PARA ANASTOMOSIS DEL RECTO ATRAUMÁTICAS, PINZAS CLAMPS PARA ANASTOMOSIS
 PINZE ATRAUMA PER ANASTOMOSI DEL RETTO, PINZE PER ANASTOMOSI



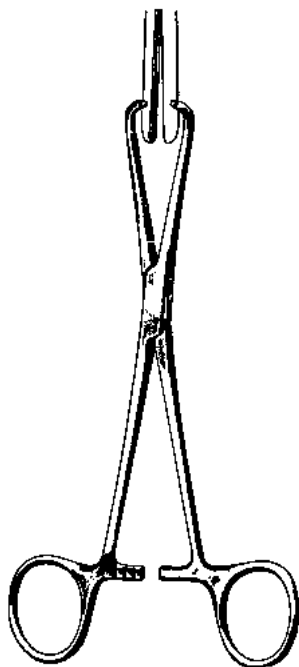
Hayes
 6279.26 26 cm
 6279.28 28 cm



6279.26 26 cm



6279.28 28 cm



Stone
 6301.15 15,5 cm

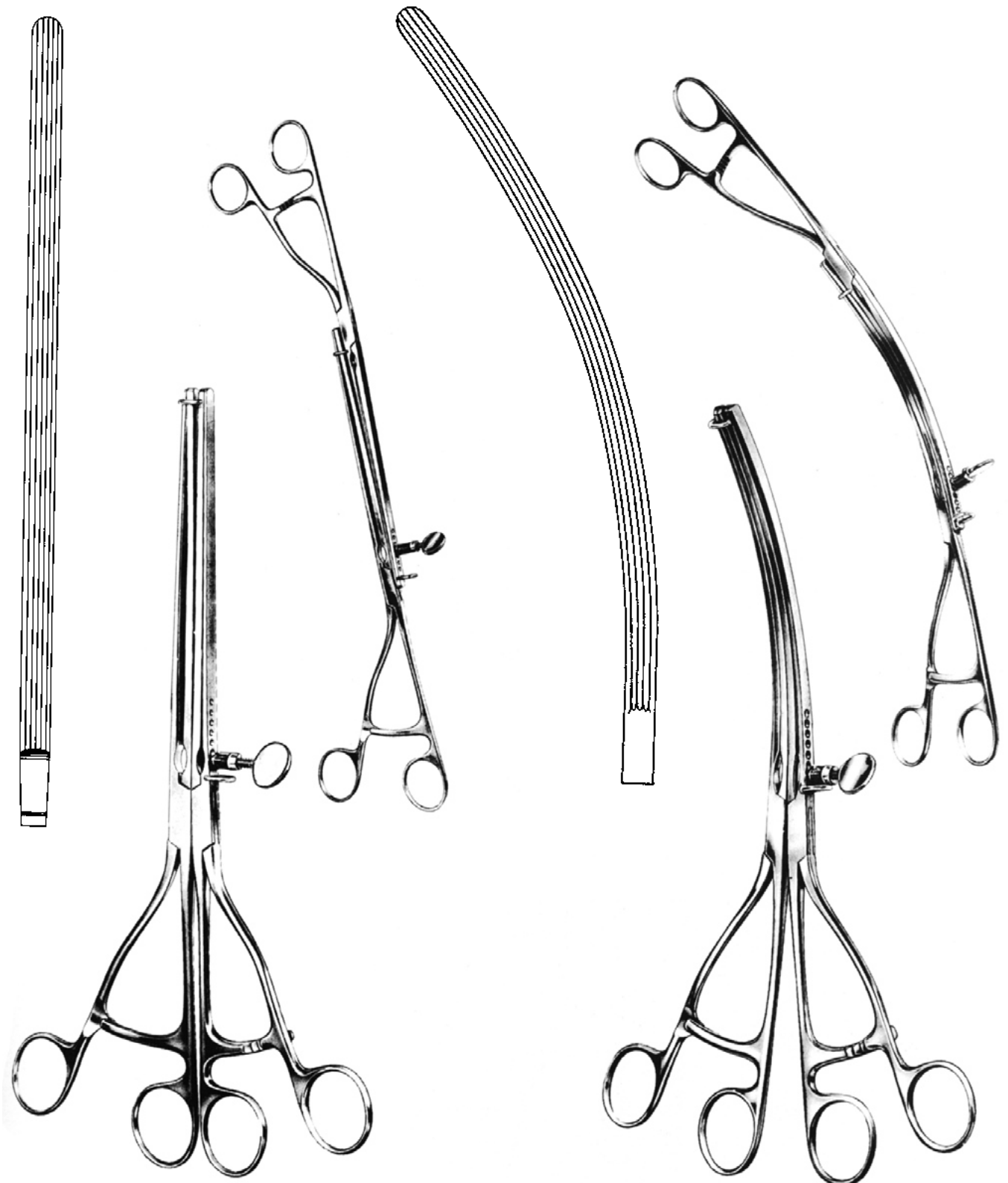


Stone-Watt
 6302.07 7,5 cm
 6302.10 10,5 cm



Stone-Watt
 6303.00

MAGENQUETSCHKLEMME
 STOMACH CLAMPS
 PINZAS-CLAMPS ESTOMACALES
 PINZE STOMACALI



Lane
 6310.30 30 cm

Lane
 6311.30 30 cm

MATTES

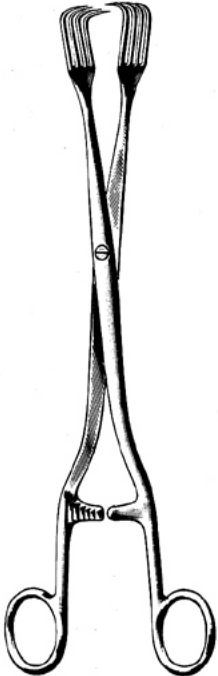
DARM-ORGANFASSZANGEN
BOWEL AND TISSUE GRASPING FORCEPS
PINZAS PARA COGER INTESTINOS Y TEJIDOS
PINZE PER AFFERRARE INTESTINI E TESSUTI



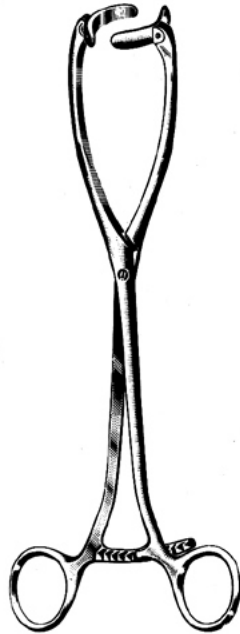
2x3 Zähne
2x3 teeth
2x3 dientes
2x3 denti

Littlewood
6312.18 18,5 cm

GYNÄKOLOGIE - UTERUS-FABZANGEN
GYNECOLOGY - UTERINE ELEVATING FORCEPS
GYNÉCOLOGIE - PINCES HYSTÉROLABES
GINECOLOGÍA - PINZAS PARA EL ÚTERO
GINECOLOGIA - PINZE PER AFFERRARE L'UTERO



Pratt
 28,0 cm/11"
 6280.28



Collin
 25,0 cm/10"
 6285.25

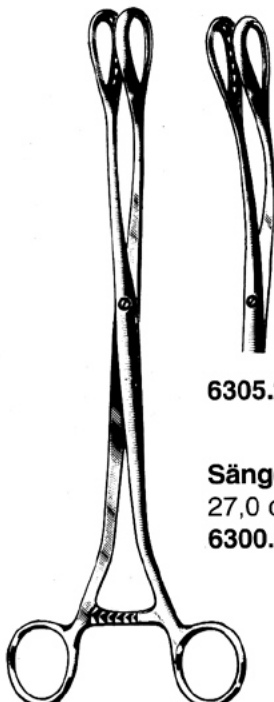


Dartiques
 27,0 cm
 6290.27



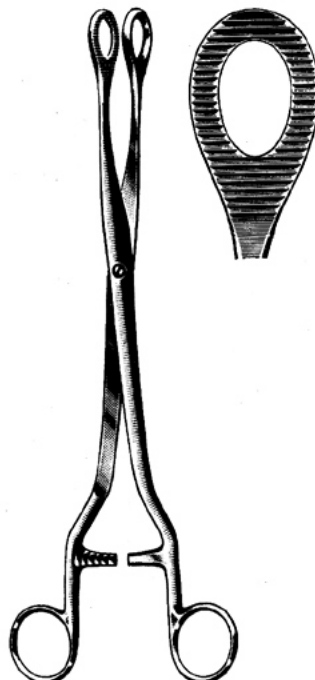
Sommer
 23,0 cm
 6295.23

UTERUS-POLYPENZANGEN
UTERINE POLYPUS FORCEPS
PINCES À POLYPES UTÉRINS
PINZAS PARA PÓLIPOS UTERINOS
PINZE PER POLIPI UTERINI

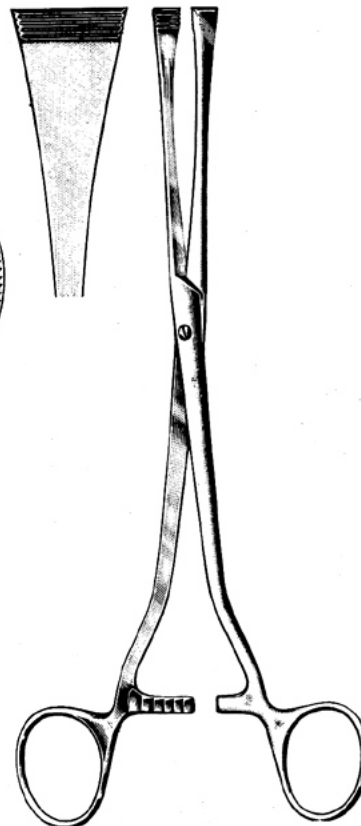


6305.27

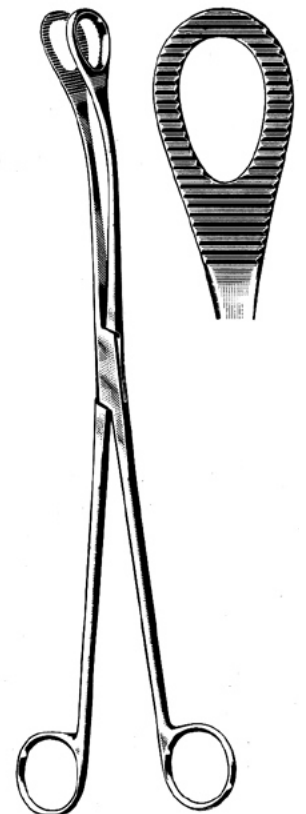
Sänger
 27,0 cm/11"
 6300.27



Noto
 6302.27 27 cm

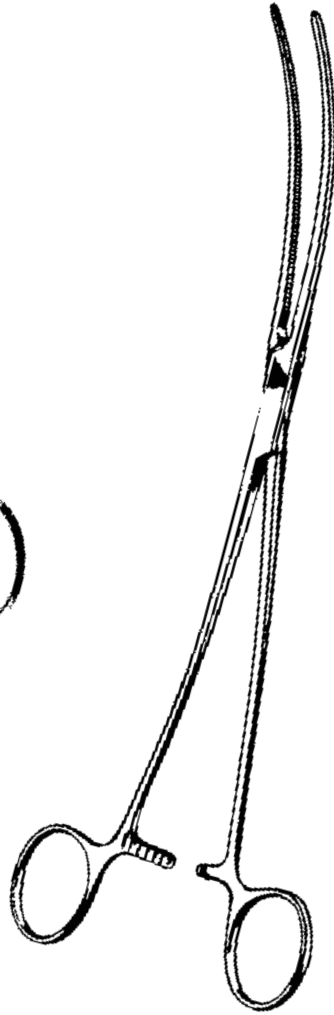
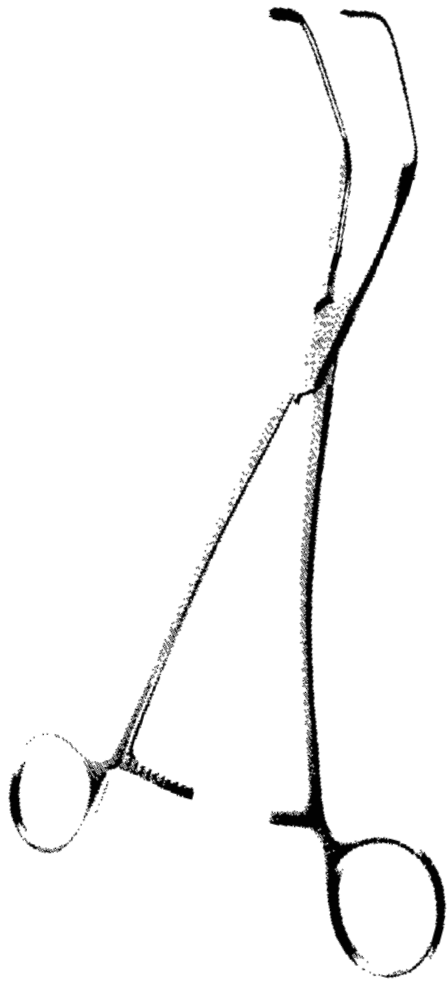


Green Armytage
 21,0 cm
 6306.21



Kelly
 32,0 cm
 6307.32

ATRAUMATISCHE KLEMMEN
ATRAUMA CARDIOVASCULAR FORCEPS
ATRAUMA PINZAS-CLAMPS CARDIOVASCULARES
PINZE ATRAUMATICHE PER CHIRURGIA VASCOLARE



MATTES

ATRAUMA-BULLDOGKLEMMEN
ATRAUMA BULLDOG CLAMPS
CLAMPS BULLDOG ATRAUMA
CLAMPS ATRAUMA BULLDOG
PINZE ATRAUMA BULLDOG



De Baakey



6320.07
7,5 cm



6320.08
8,5 cm



6320.10
10,5 cm



6320.12
12,0 cm

gerade - straight - rectas - rette



De Baakey



6325.07
7,0 cm



6325.08
8,0 cm



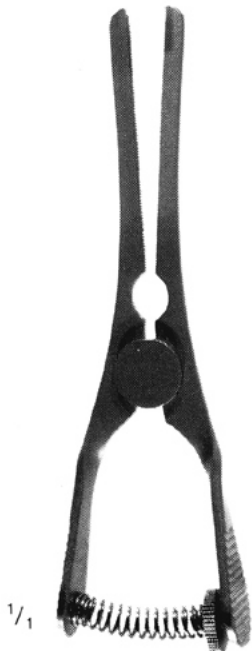
6325.10
10,0 cm



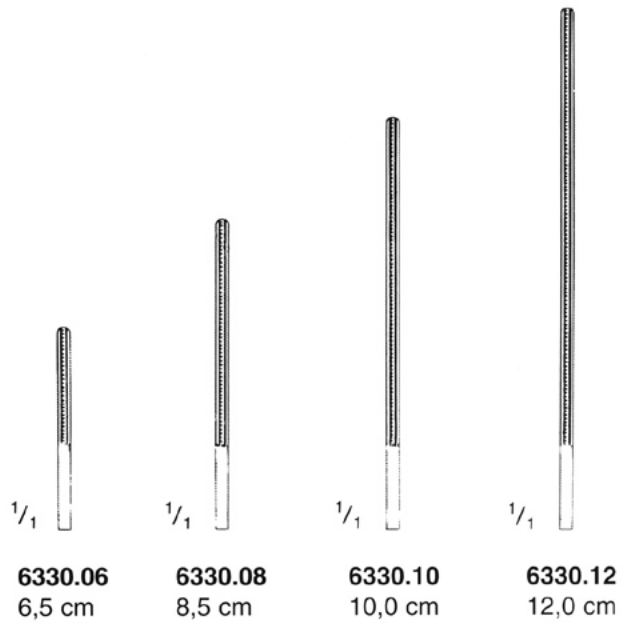
6325.12
11,5 cm

gebogen - curved - curvas - curva

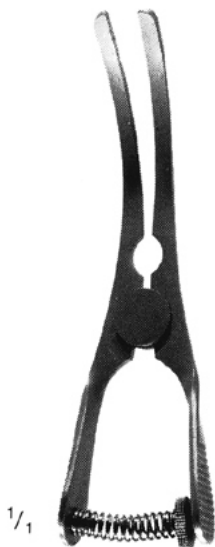
ATRAUMA-BULLDOGGKLEMMEN
ATRAUMA BULLDOG CLAMPS
CLAMPS BULLDOG ATRAUMA
CLAMPS ATRAUMA BULLDOG
PINZE ATRAUMA BULLDOG



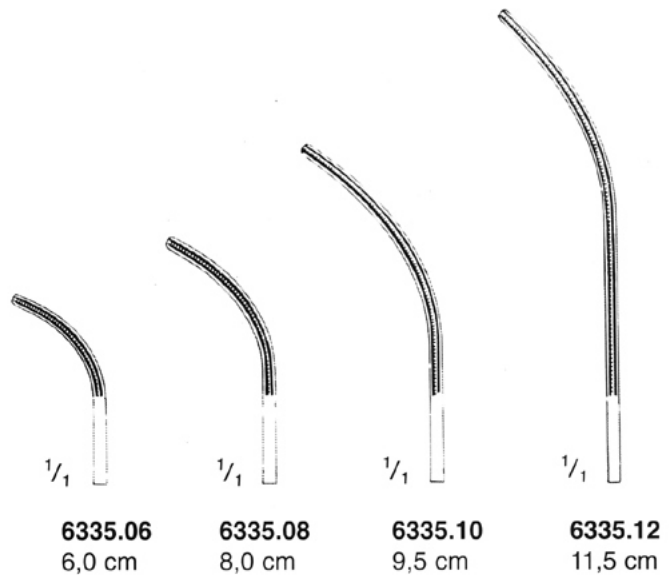
Glover



gerade - straight - rectas - rette



Glover



gebogen - curved - curvas - curve

MATTES

ATRAUMA-BULLDOGKLEMMEN
ATRAUMA BULLDOG CLAMPS
CLAMPS BULLDOG ATRAUMA

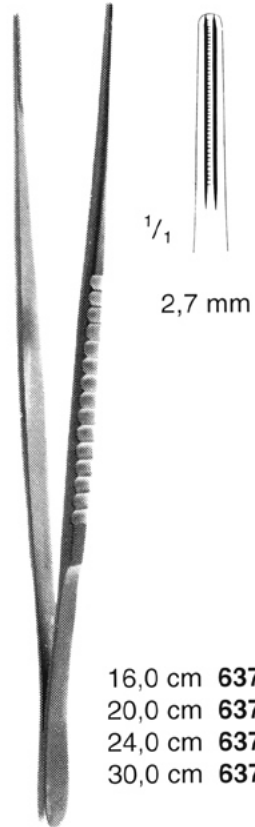


— 2,0 mm —



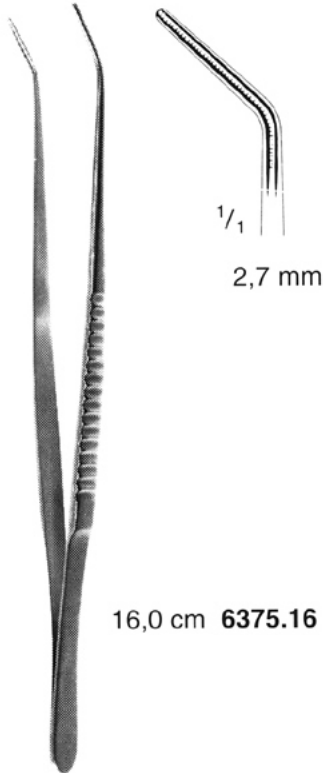
6354.20
20,0 cm

**ATRAUMATISCHE PINZETTEN
 ATRAUMATIC FORCEPS
 PINCES ATRAUMATIQUES
 PINZAS ATRAUMÁTICAS
 PINZE ATRAUMATICHE**



16,0 cm **6370.16**
 20,0 cm **6370.20**
 24,0 cm **6370.24**
 30,0 cm **6370.30**

De Bakey



16,0 cm **6375.16**

De Bakey



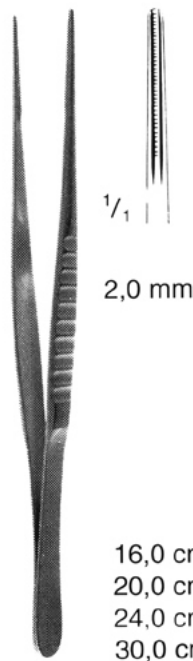
20,0 cm **6380.20**
 24,0 cm **6380.24**
 30,0 cm **6380.30**

De Bakey



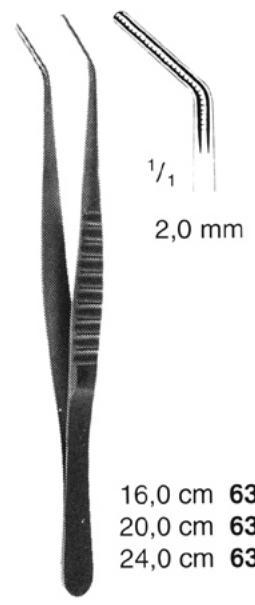
16,0 cm **6382.16**
 20,0 cm **6382.20**
 24,0 cm **6382.24**
 30,0 cm **6382.30**

De Bakey



16,0 cm **6384.16**
 20,0 cm **6384.20**
 24,0 cm **6384.24**
 30,0 cm **6384.30**

De Bakey

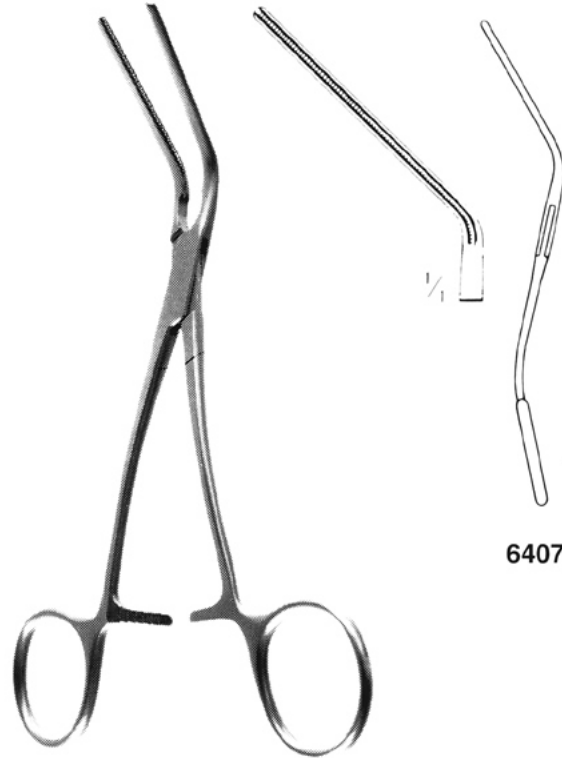


16,0 cm **6385.16**
 20,0 cm **6385.20**
 24,0 cm **6385.24**

De Bakey

MATTES

ATRAUMATISCHE KLEMMEN
ATRAUMA CARDIOVASCULAR FORCEPS
ATRAUMA PINZAS-CLAMPS CARDIOVASCULARES
PINZE ATRAUMATICHE PER CHIRURGIA VASCOLARE



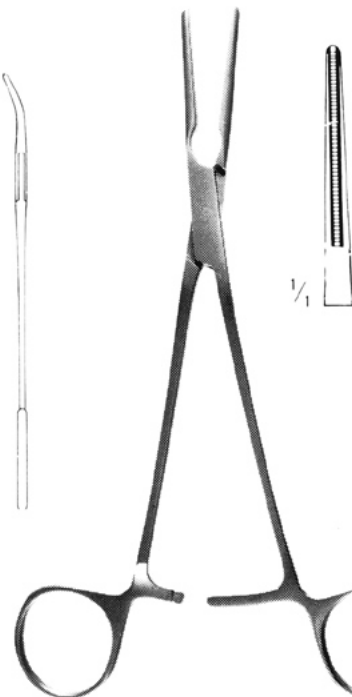
6407.13

De Bakey
 13,0 cm
 6407.13

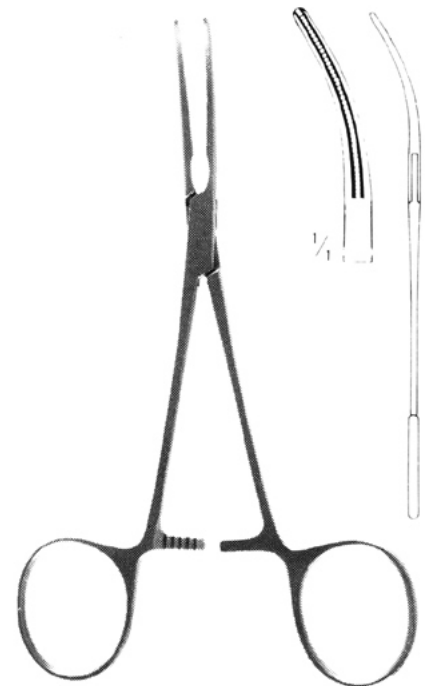


6411.12
 12,0 cm

Mosquito
 12,0 cm
 6410.12



Pean
 14,0 cm
 6412.14

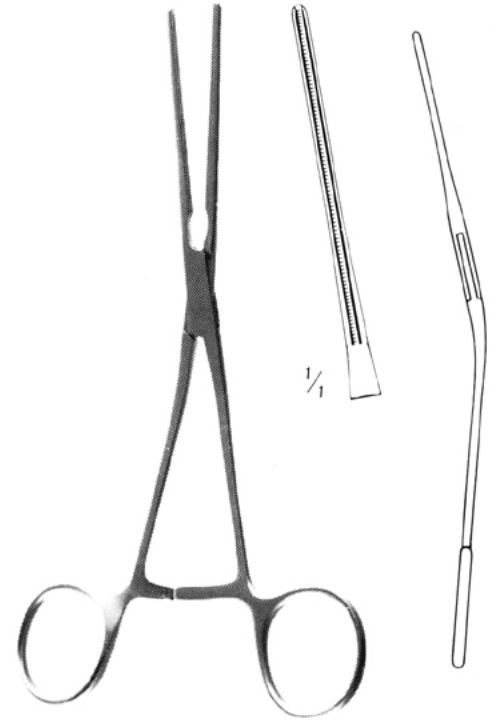


Pean
 14,0 cm
 6415.14

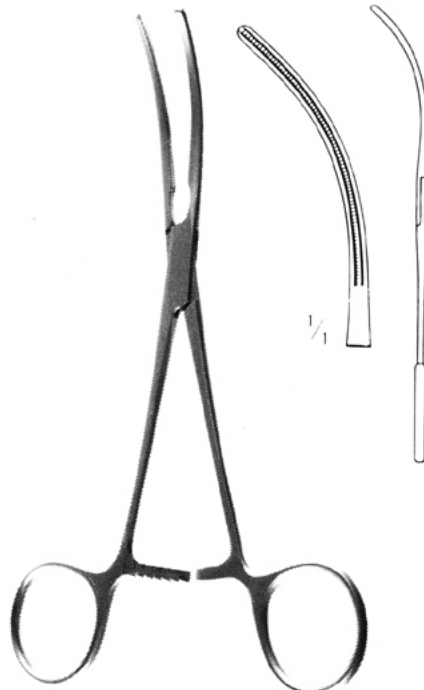
ATRAUMATISCHE KLEMMEN
ATRAUMA CARDIOVASCULAR FORCEPS
ATRAUMA PINZAS-CLAMPS CARDIOVASCULARES
PINZE ATRAUMATICHE PER CHIRURGIA VASCOLARE



De Bakey
 15,0 cm
 6417.15



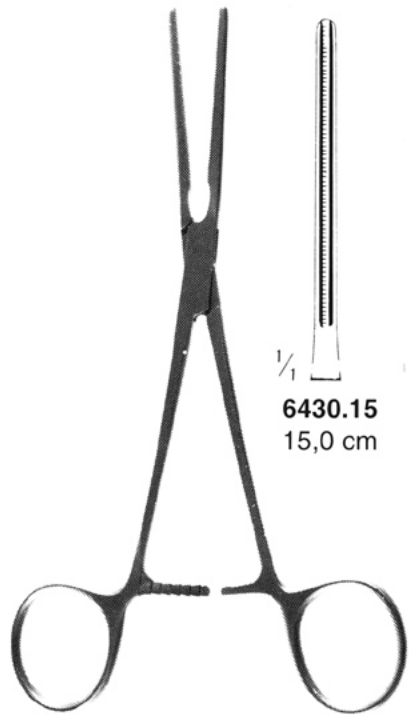
De Bakey
 17,0 cm
 6419.17



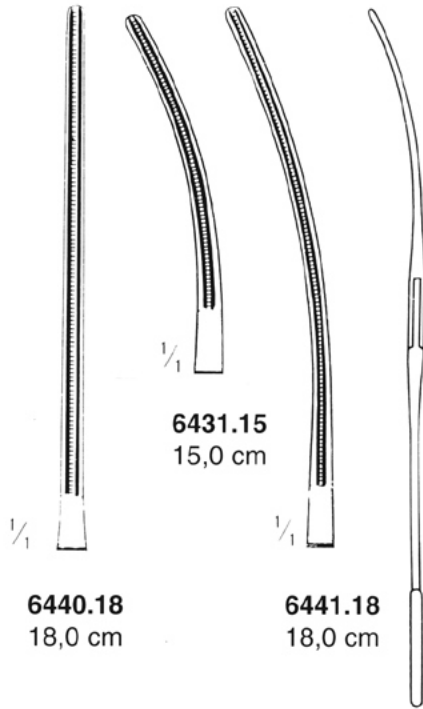
De Bakey
 11,0 cm
 6423.11

MATTES

ATRAUMATISCHE KLEMMEN
ATRAUMA CARDIOVASCULAR FORCEPS
ATRAUMA PINZAS-CLAMPS CARDIOVASCULARES
PINZE ATRAUMATICHE PER CHIRURGIA VASCOLARE



6430.15
15,0 cm

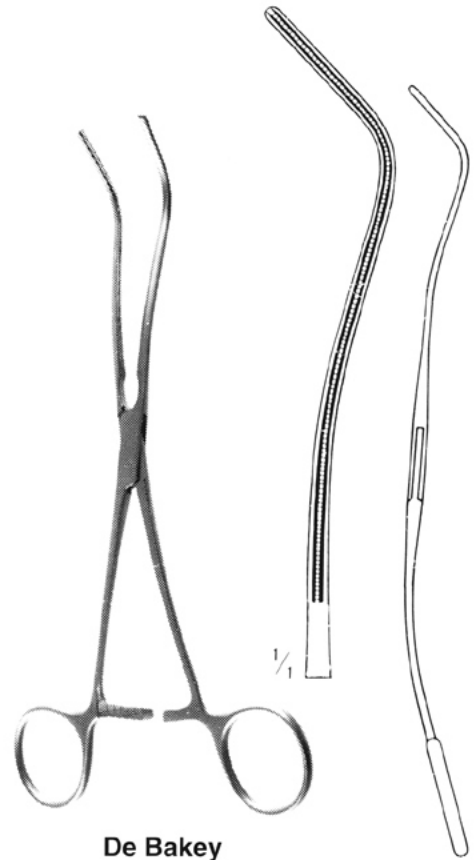


6440.18
18,0 cm

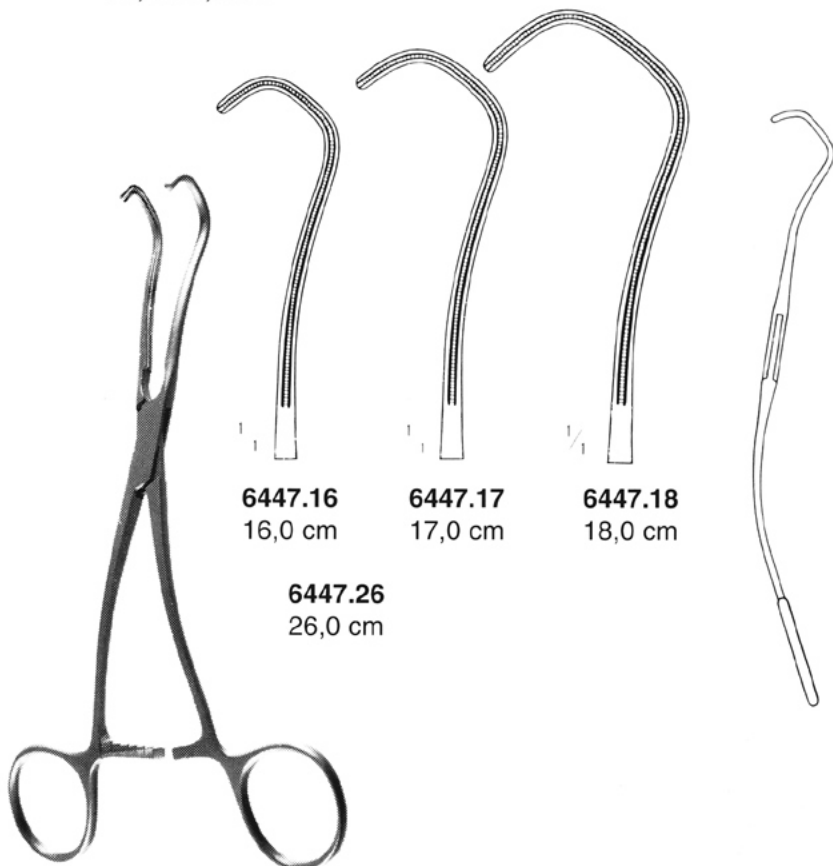
6431.15
15,0 cm

6441.18
18,0 cm

Bainbridge
15,0 / 18,0 cm



De Bakey
20,0 cm 6445.20



6447.16
16,0 cm

6447.17
17,0 cm

6447.18
18,0 cm

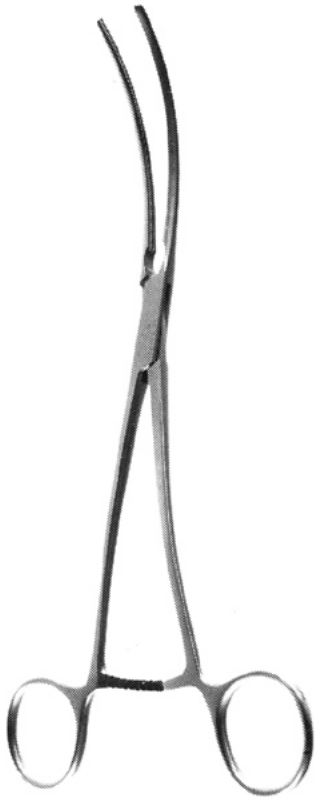
6447.26
26,0 cm

Derra

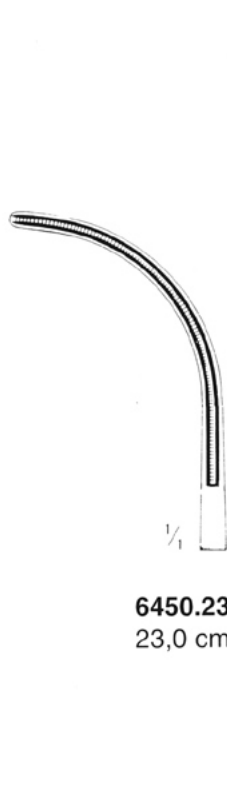


Beck
6449.17
17,0 cm

**ATRAUMATISCHE KLEMMEN
 ATRAUMA CARDIOVASCULAR FORCEPS
 ATRAUMA PINZAS-CLAMPS CARDIOVASCULARES
 PINZE ATRAUMATICHE PER CHIRURGIA VASCOLARE**



De Bakey



6450.23
23,0 cm



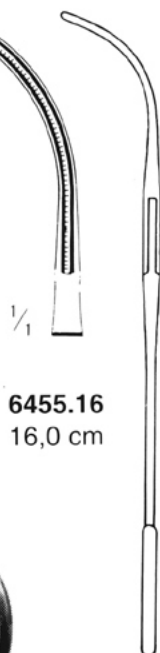
6450.24
24,0 cm



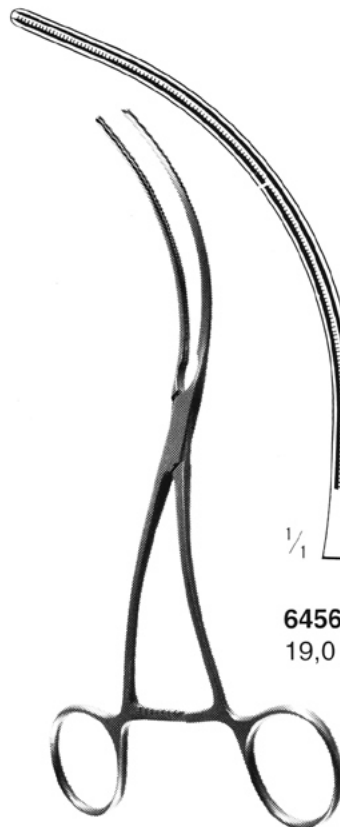
6450.25
25,0 cm



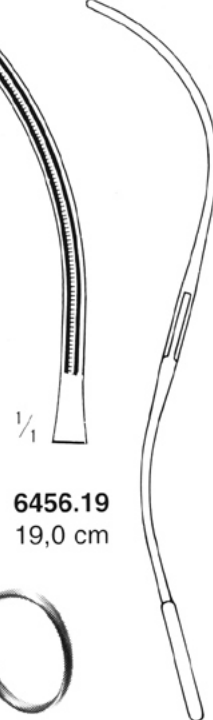
De Bakey



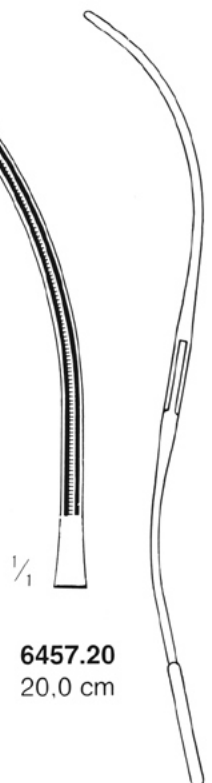
6455.16
16,0 cm



De Bakey



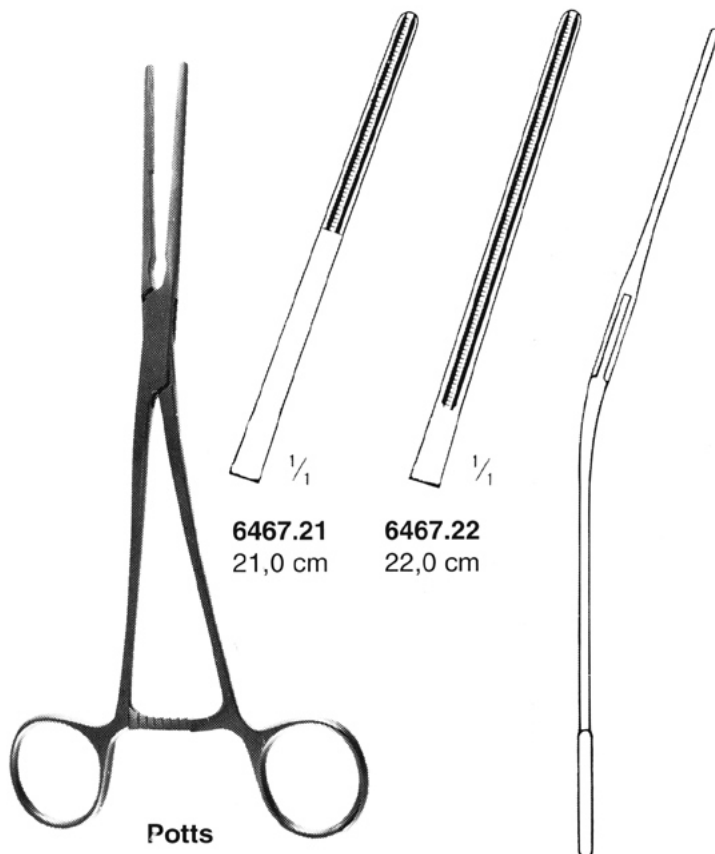
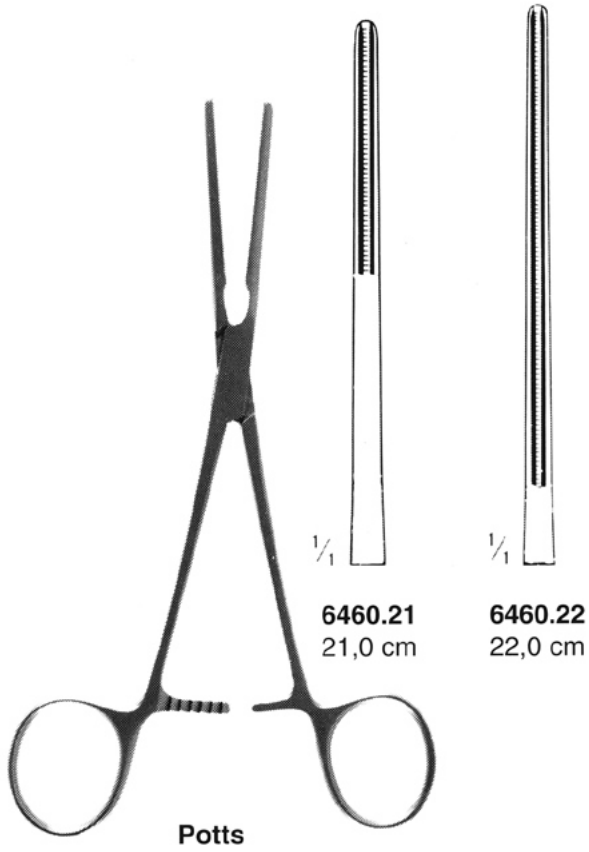
6456.19
19,0 cm



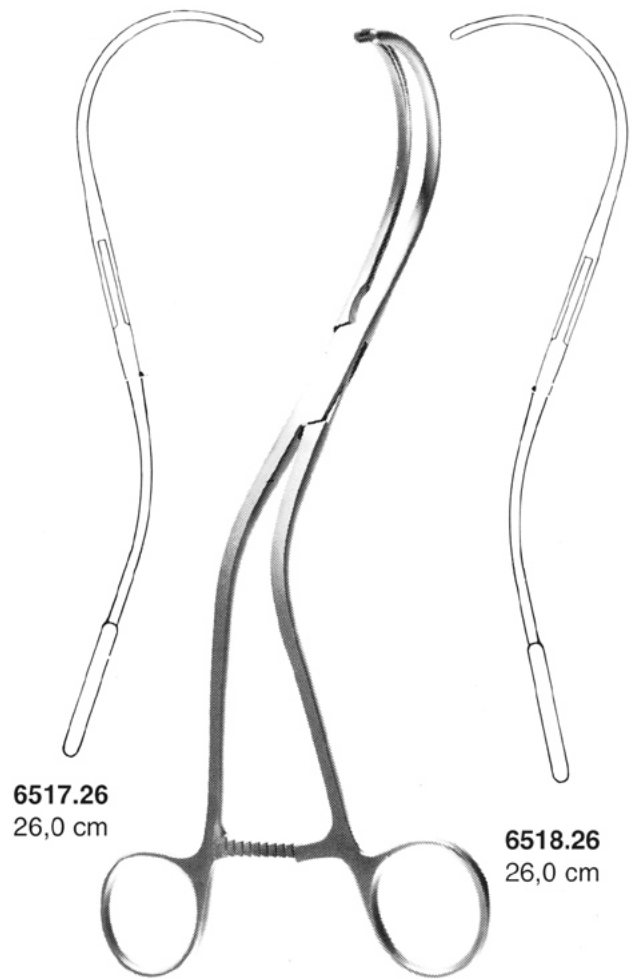
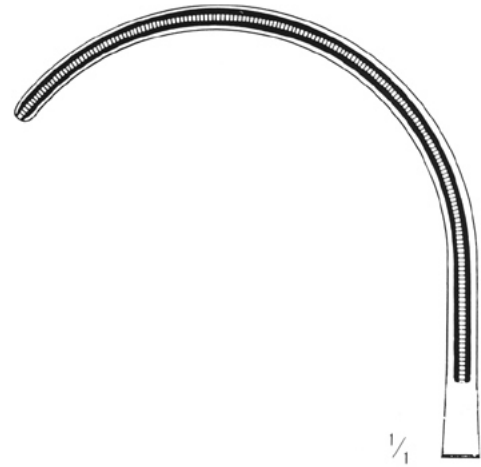
6457.20
20,0 cm

MATTES

ATRAUMATISCHE KLEMMEN
ATRAUMA CARDIOVASCULAR FORCEPS
ATRAUMA PINZAS-CLAMPS CARDIOVASCULARES
PINZE ATRAUMATICHE PER CHIRURGIA VASCOLARE



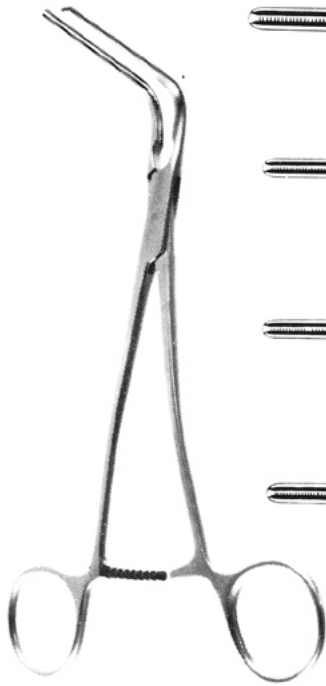
ATRAUMATISCHE KLEMMEN
ATRAUMA CARDIOVASCULAR FORCEPS
ATRAUMA PINZAS-CLAMPS CARDIOVASCULARES
PINZE ATRAUMATICHE PER CHIRURGIA VASCOLARE



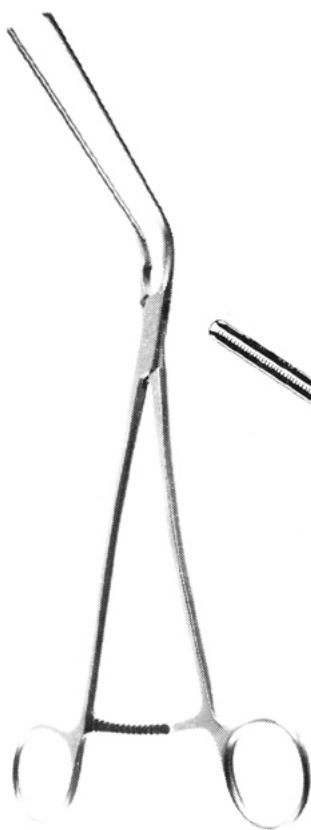
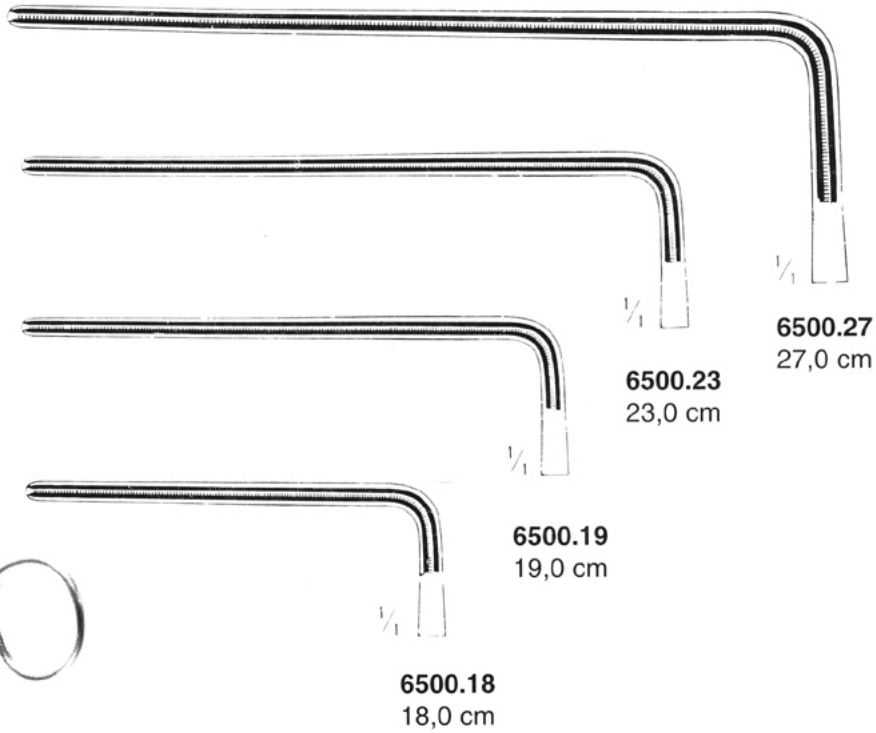
Weber

MATTES

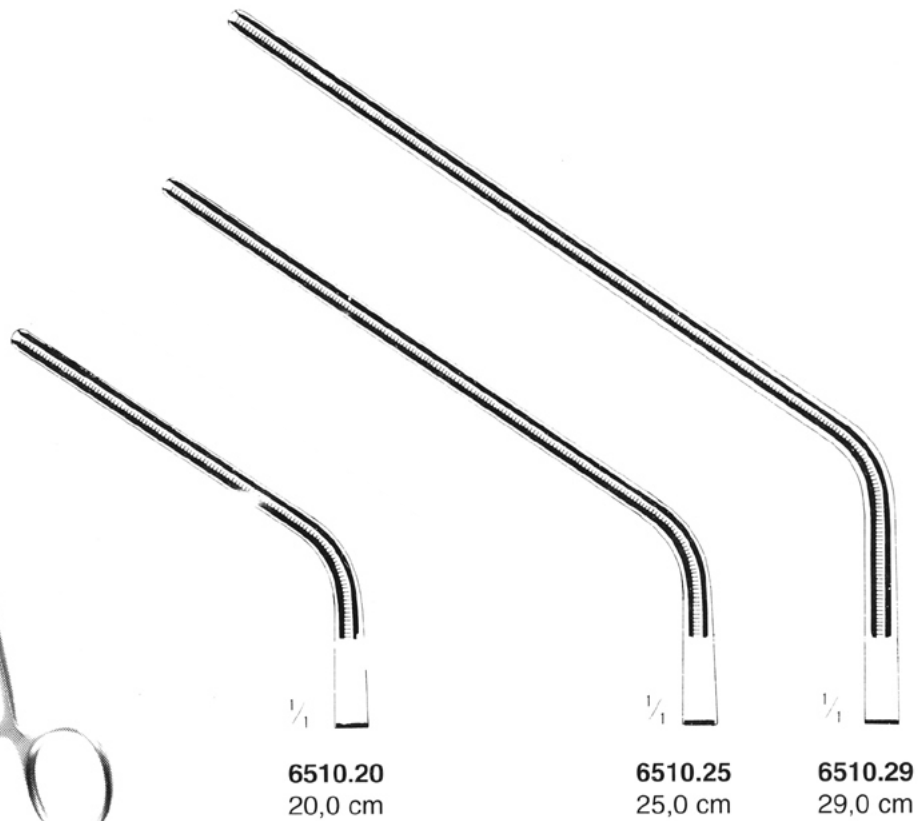
ATRAUMATISCHE KLEMMEN
ATRAUMA CARDIOVASCULAR FORCEPS
ATRAUMA PINZAS-CLAMPS CARDIOVASCULARES
PINZE ATRAUMATICHE PER CHIRURGIA VASCOLARE



De Bakey



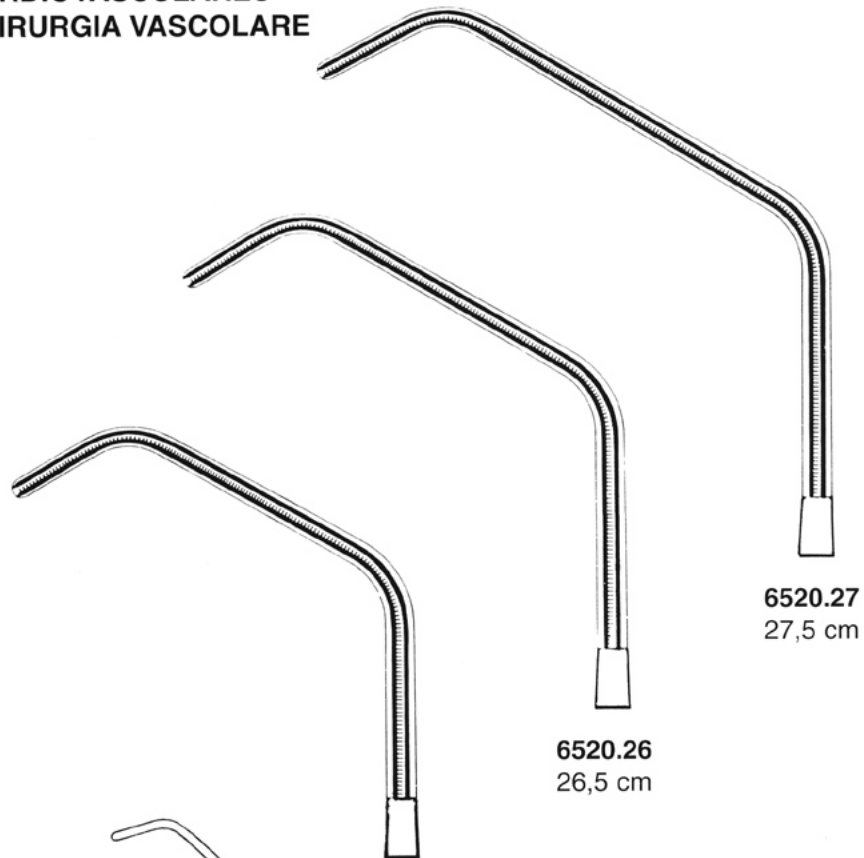
De Bakey



ATRAUMATISCHE KLEMMEN
ATRAUMA CARDIOVASCULAR FORCEPS
ATRAUMA PINZAS-CLAMPS CARDIOVASCULARES
PINZE ATRAUMATICHE PER CHIRURGIA VASCOLARE



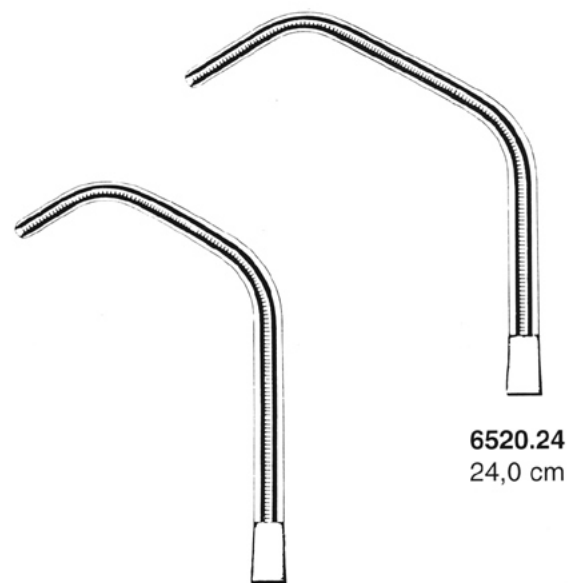
Satinsky



6520.25
25,0 cm

6520.26
26,5 cm

6520.27
27,5 cm



6520.20
20,5 cm

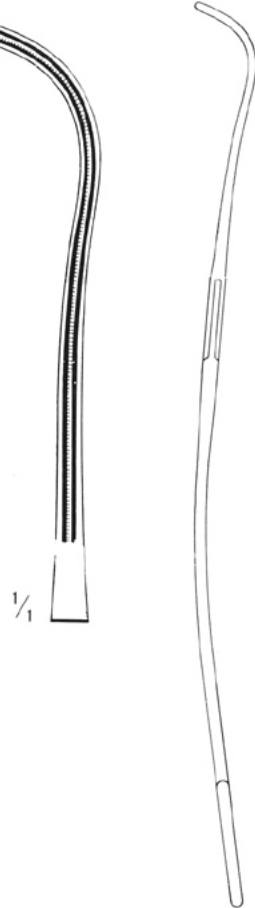
6520.24
24,0 cm

MATTES

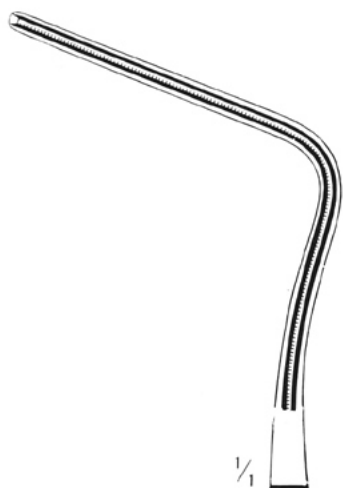
ATRAUMISCHE KLEMMEN
 ATRAUMA CARDIOVASCULAR FORCEPS
 ATRAUMA PINZAS-CLAMPS CARDIOVASCULARES
 PINZE ATRAUMATICHE PER CHIRURGIA VASCOLARE



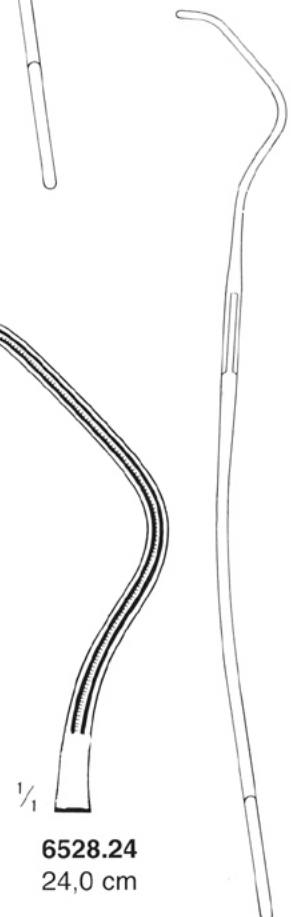
Harken
6523.24
 24,0 cm



6524.24
 24,0 cm



6526.24
 24,0 cm



6528.24
 24,0 cm

**ATRAUMATISCHE KLEMMEN
 ATRAUMA CARDIOVASCULAR FORCEPS
 ATRAUMA PINZAS-CLAMPS CARDIOVASCULARES
 PINZE ATRAUMATICHE PER CHIRURGIA VASCOLARE**



De Bakey



6530.23
23,0 cm



6530.27
27,0 cm



6530.31
31,5 cm



De Bakey



6535.21
21,5 cm



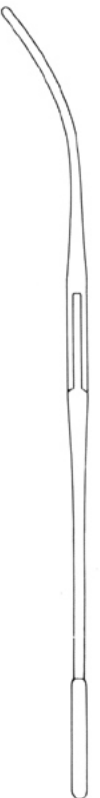
6535.23
23,0 cm



6535.27
27,0 cm

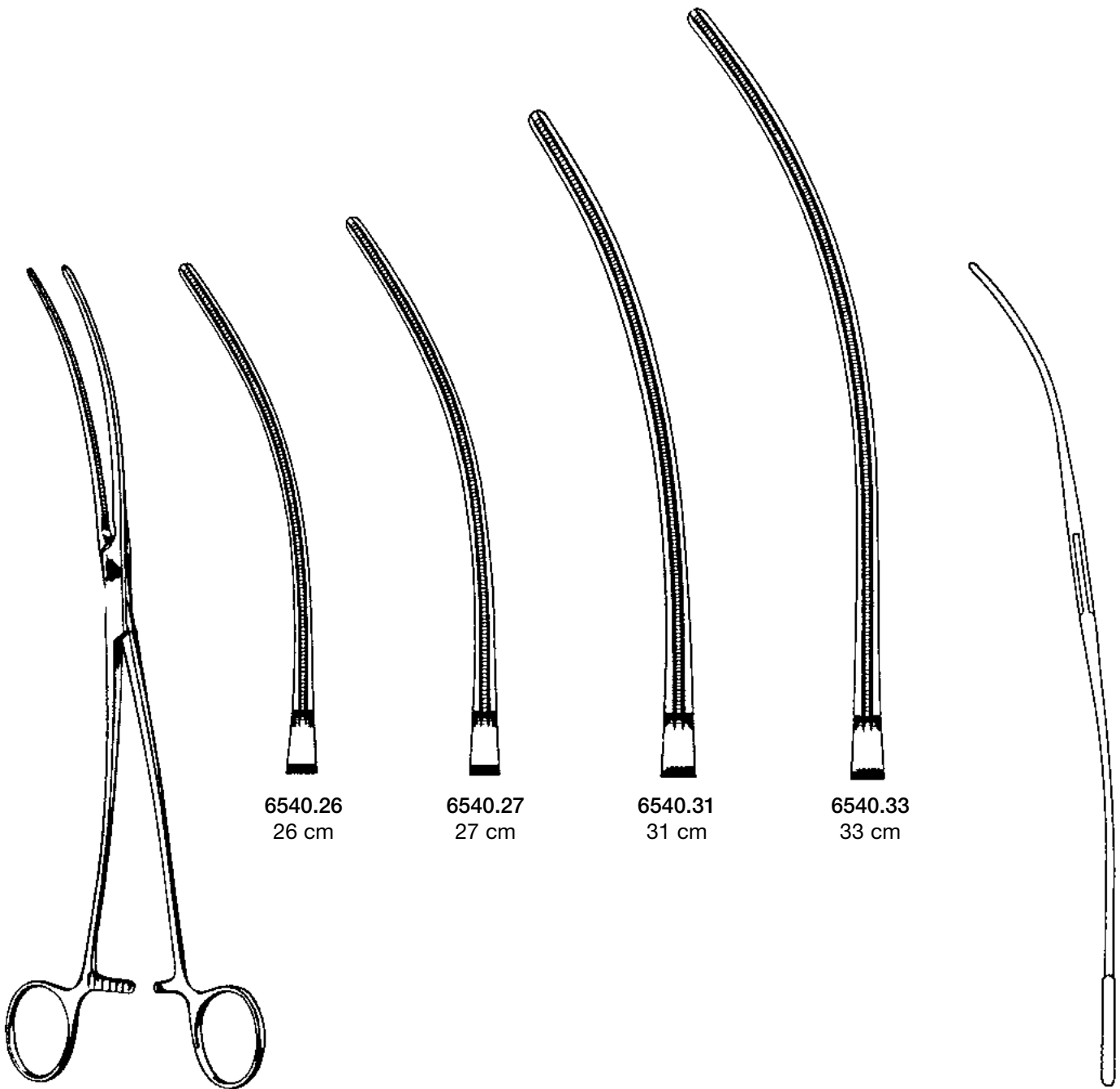


6535.31
31,0 cm



MATTES

AORTA-ANEURYSMAKLEMMEN
AORTIC ANEURYSM CLAMPS
PINZAS-CLAMPS PARA ANEURISMA DE LA AORTA
PINZE PER ANEURISMA DELL'ÀORTA



6540.26
26 cm

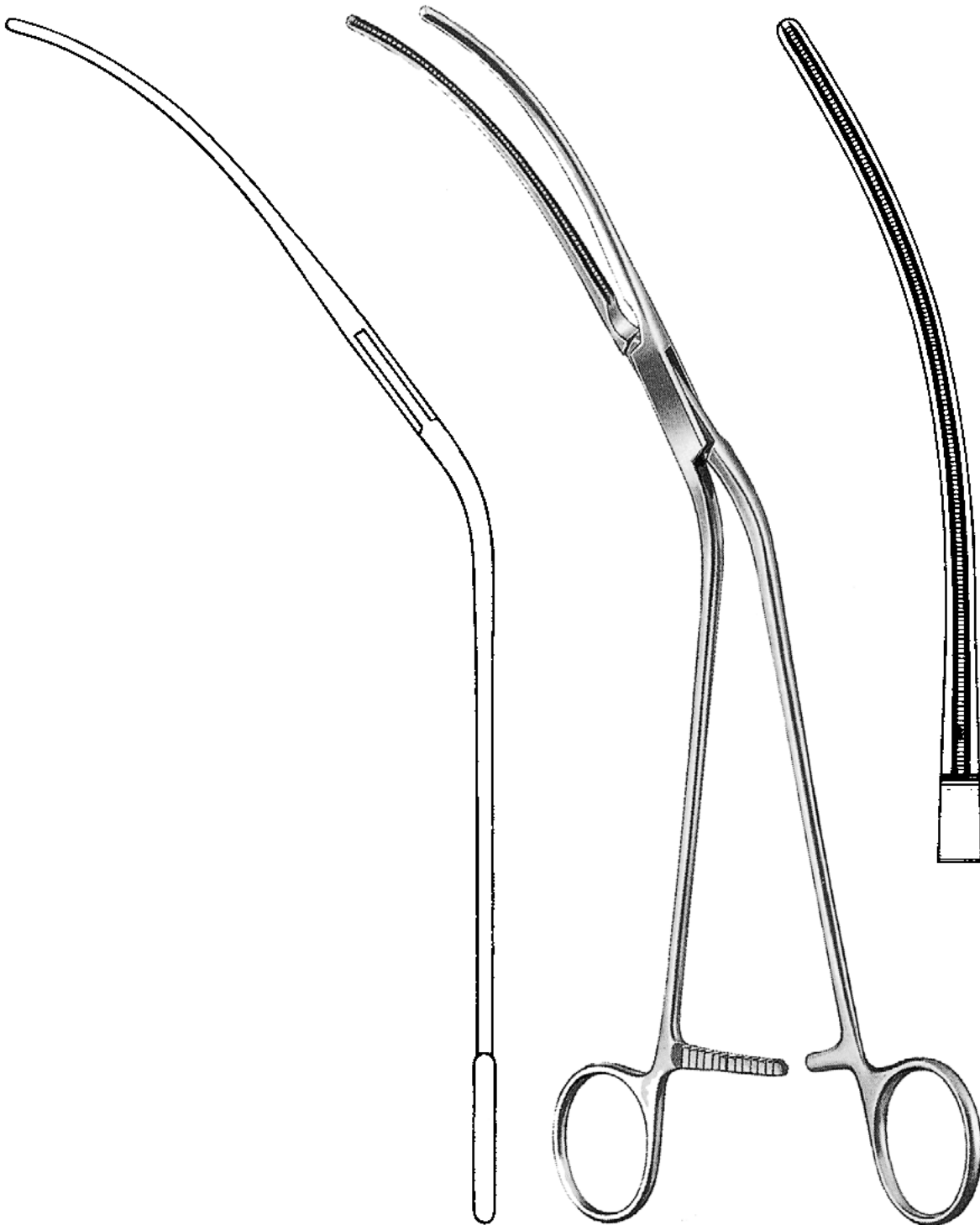
6540.27
27 cm

6540.31
31 cm

6540.33
33 cm

De Bakey
6540.26 - 6540.33

AORTA-ANEURYSMAKLEMMEN
AORTIC ANEURYSM CLAMPS
PINZAS-CLAMPS PARA ANEURISMA DE LA AORTA
PINZE PER ANEURISMA DELL'ÀORTA

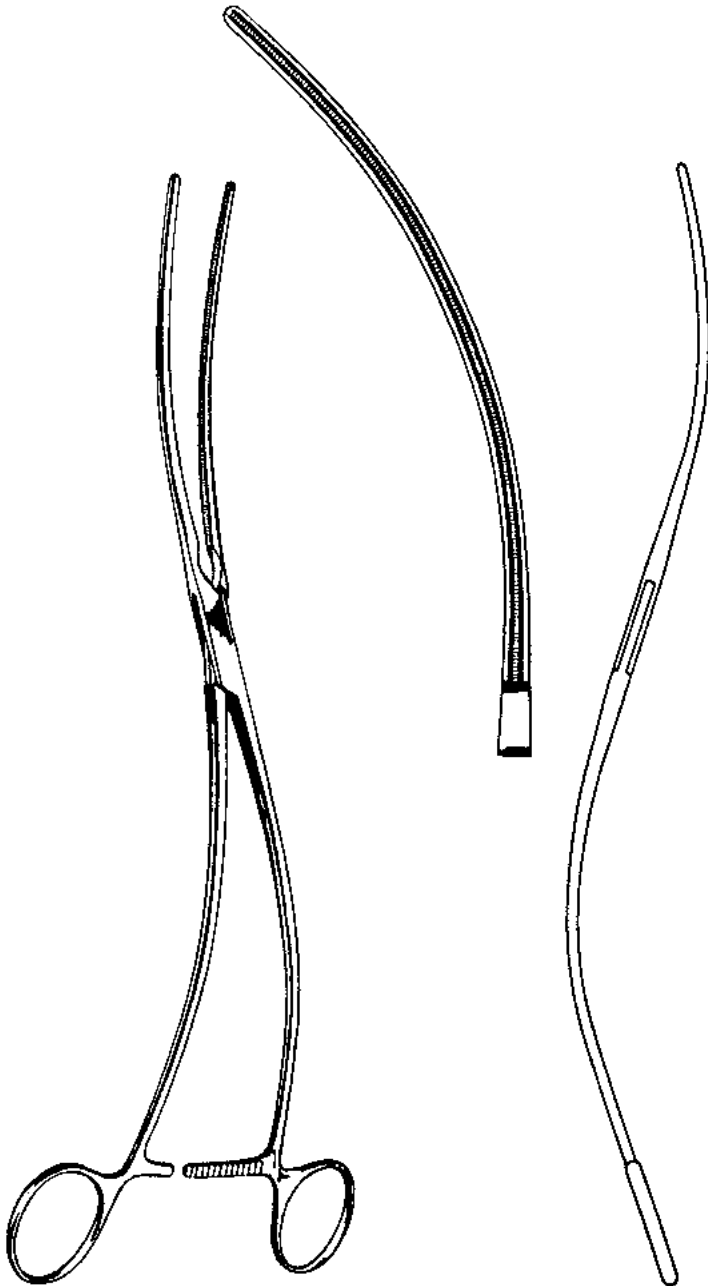


De Bakey
6548.28

MATTES

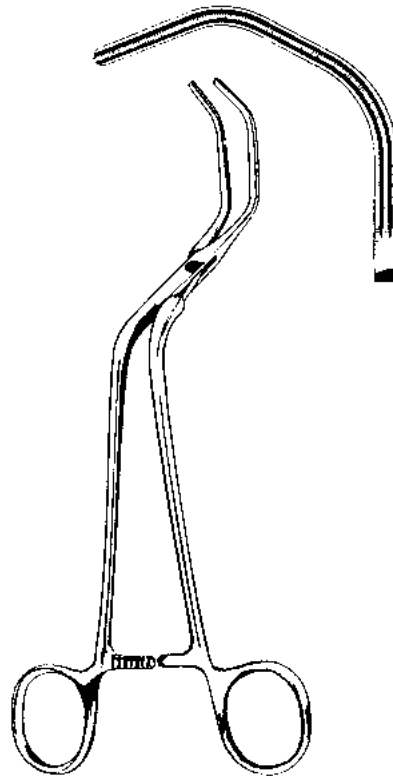
AORTA-ANEURYSMAKLEMMEN
AORTIC ANEURYSM CLAMPS
PINZAS-CLAMPS PARA ANEURISMA DE LA AORTA
PINZE PER ANEURISMA DELL'ÀORTA

Draufsicht
Top view
Vista de arriba
Vista da vicino

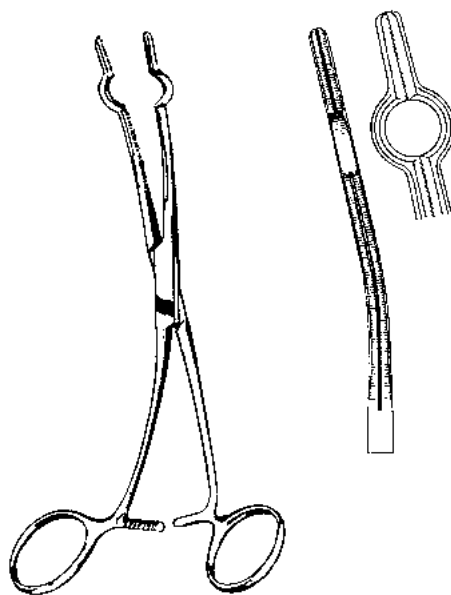


De Bakey
6549.30 30 cm

AORTAKLEMME, KAROTISKLEMMEN
 AORTIC CLAMPS, CAROTID CLAMPS
 PINZAS-CLAMPS PARA AORTA, PINZAS-CLAMPS PARA CAROTIS
 PINZE PER AORTA, PINZE PER LA CAROTIDE



Dietrich
 6555.21 21 cm



Cooley
 6560.01 - 6565.06

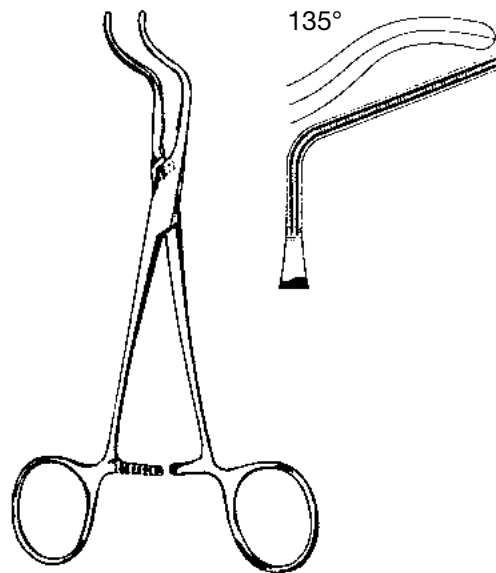
6560.01 - 6560.02
 für Kinder
 for children
 para niños
 per bambini

Charrière (French)	Länge Length Largo Lungo cm	
24	16	6560.01
26	16	6560.02
28	20	6561.03
30	20	6561.04
32	20	6565.05
36	20	6565.06

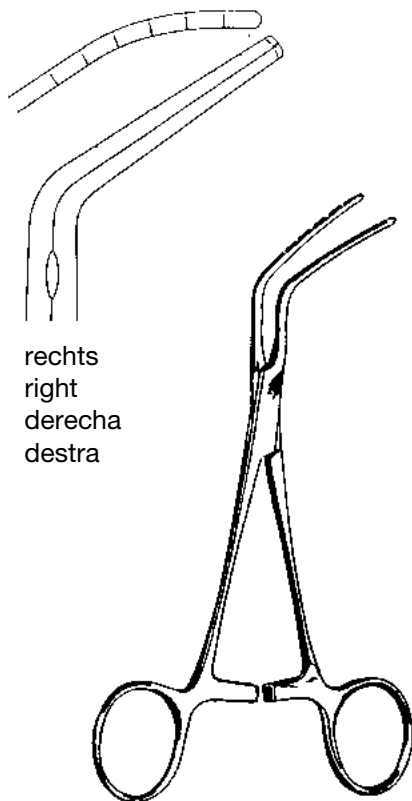
6561.03 - 6565.06
 für Erwachsene
 for adults
 para adultes
 per adulti

MATTES

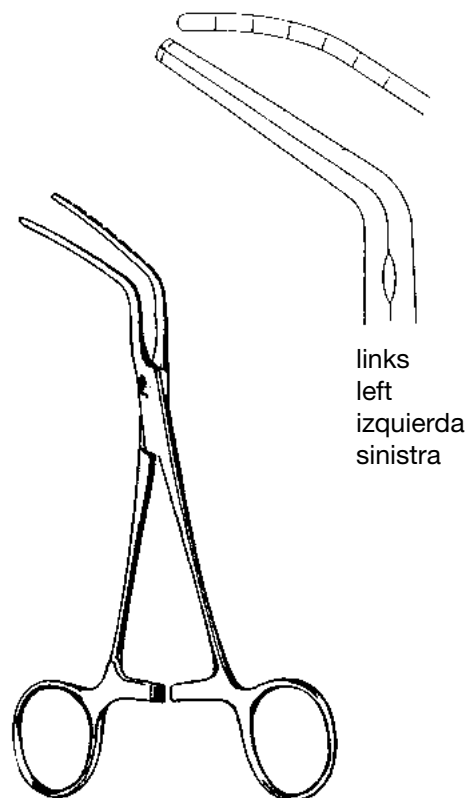
ATRAUMA CARDIOVASCULAR-KLEMMEN
 ATRAUMA CARDIOVASCULAR FORCEPS
 PINZAS-CLAMPS CARDIOVASCULARES ATRAUMÁTICAS
 PINZE ATRAUMATICHE PER CHIRURGIA VASCOLARE



Subramanian-Miniature
 6570.15 15 cm

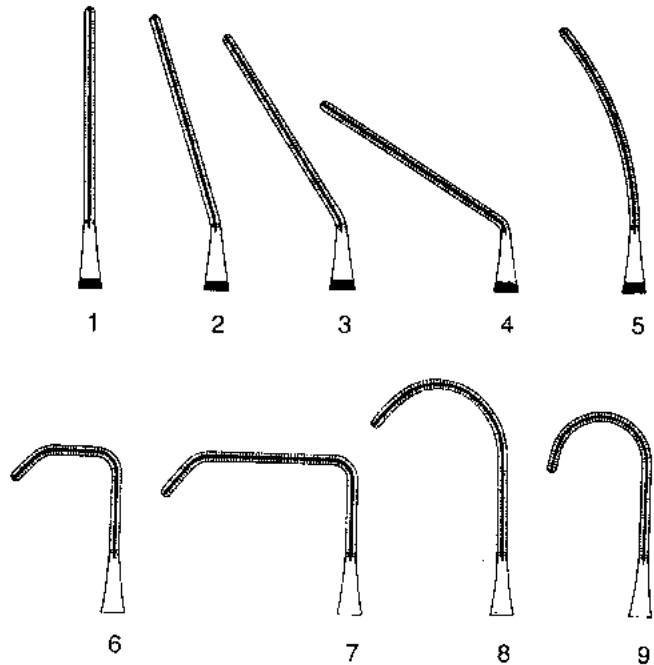
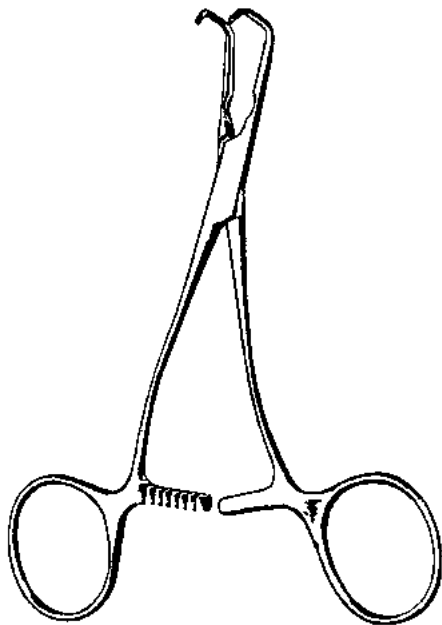


Subramanian
 6571.16 16 cm



Subramanian
 6572.16 16 cm

ATRAUMA NEONATAL-UND KINDERKLEMMEN
NEONATAL AND PEDIATRIC CLAMPS
PINZAS-CLAMPS PEDIÁTRICAS Y PARA RECIÉN-NACIDOS, ATRAUMÁTICAS
PINZE PER NEONATI E BAMBINI



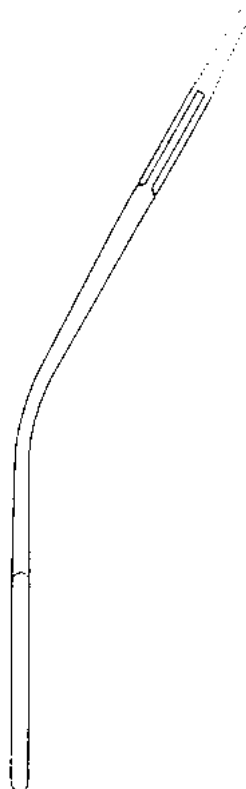
gerade
straight
rectas
rette

- Fig. 1 6582.01 14 cm
- 2 6582.02 14 cm
- 3 6582.03 14 cm
- 4 6582.04 13 cm
- 5 6582.05 14 cm
- 6 6582.06 13 cm
- 7 6582.07 13 cm
- 8 6582.08 14 cm
- 9 6582.09 13,5 cm



gebogen
curved
curvas
curve

- Fig. 1 6583.01 14 cm
- 2 6583.02 14 cm
- 3 6583.03 14 cm
- 4 6583.04 13 cm
- 5 6583.05 14 cm
- 6 6583.06 13 cm
- 7 6583.07 13 cm
- 8 6583.08 14 cm
- 9 6583.09 13,5 cm



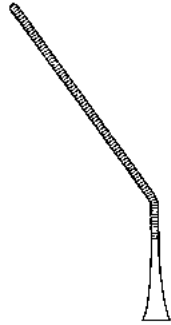
abgewinkelt
angled
acodadas
angolate

- Fig. 1 6584.01 14 cm
- 2 6584.02 14 cm
- 3 6584.03 14 cm
- 4 6584.04 13 cm
- 5 6584.05 14 cm
- 6 6584.06 13 cm
- 7 6584.07 13 cm
- 8 6584.08 14 cm
- 9 6584.09 13,5 cm

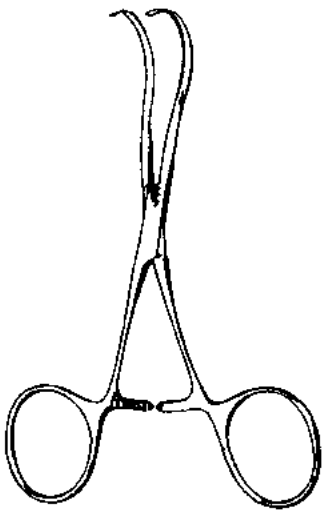


MATTES

NEONATAL-KLEMMEN
NEONATAL-CLAMPS
PINZAS-CLAMPS PARA RECIÉN-NACIDOS
PINZE PER NEONATI



6593.01
13 cm



Castaneda
6593.01
6595.03

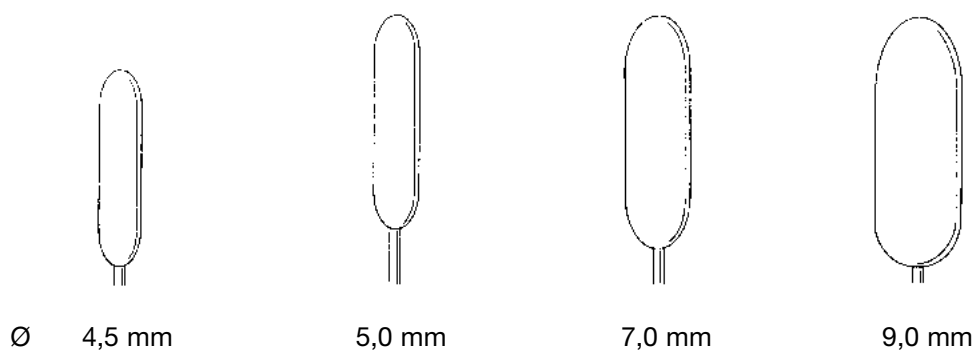
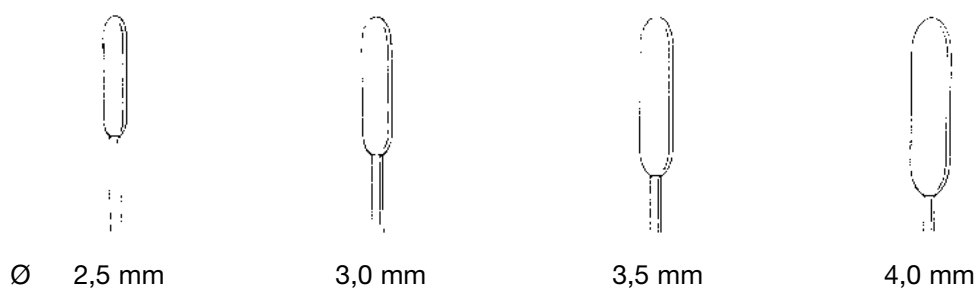
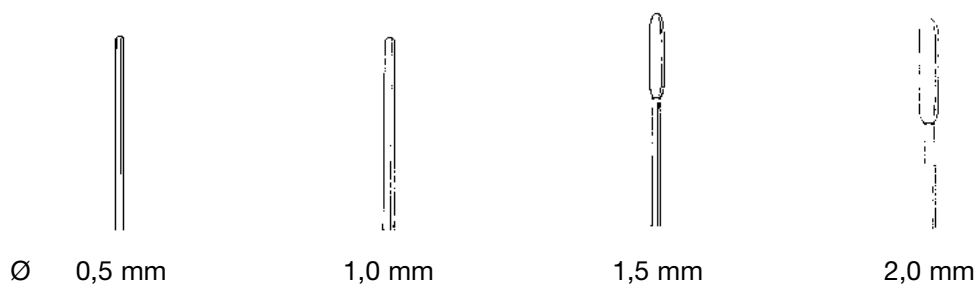


6595.03
12 cm

MATTES

GEFÄSS-DILATATOREN
VASCULAR DILATORS
DILATADORES VASCULARES
DILATATORI VASCOLARI

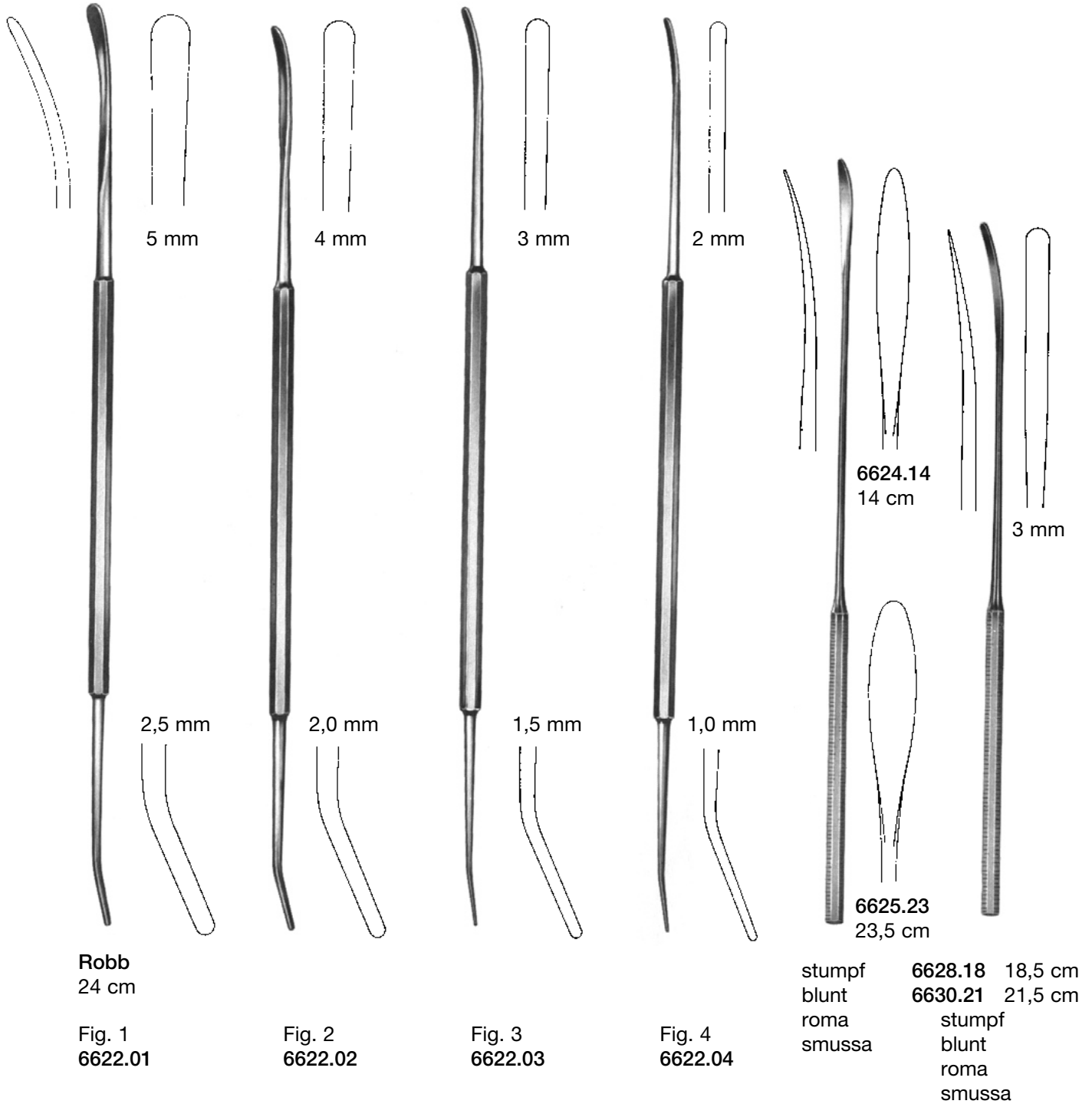
biegsam
malleable
maleables
malleabili



De Bakey

19 cm	Ø mm	35 cm
6610.05	0,5	6620.05
6610.10	1,0	6620.10
6610.15	1,5	6620.15
6610.20	2,0	6620.20
6610.25	2,5	6620.25
6610.30	3,0	6620.30
6610.35	3,5	6620.35
6610.40	4,0	6620.40
6610.45	4,5	6620.45
6610.50	5,0	6620.50
6610.70	7,0	6620.70
6610.90	9,0	6620.90

SPATEL
SPATULA
ESPÁTULAS
SPATOLA



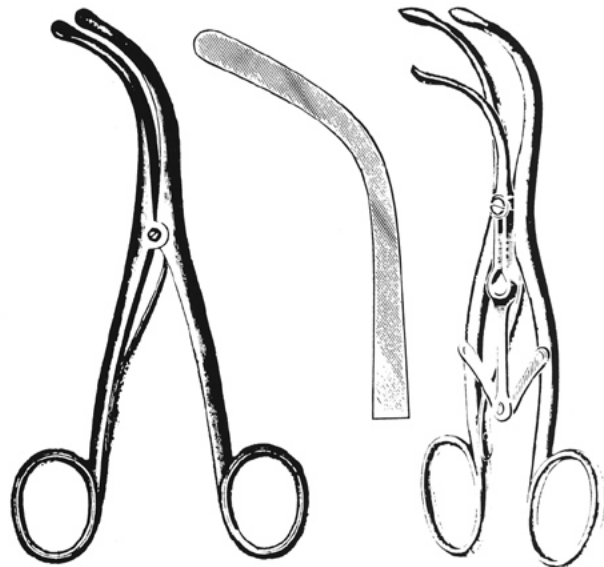
TRACHEOTOMIE
TRACHEOTOMY
TRACHÉOTOMIE
TRAQUEOTOMÍA
TRACHEOTOMIA



MATTES

TRACHEOTOMIE
 TRACHEOTOMY
 TRACHÉOTOMIE
 TRAQUEOTOMÍA
 TRACHEOTOMIA

Tracheal-Instrument - Tracheal Dilators
 Dilatateurs tracheaux - Dilatadores traqueales



Trousseau
7010.13

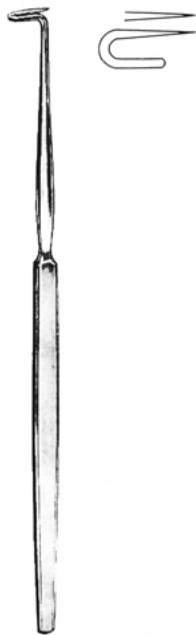
Laborde
7015.14



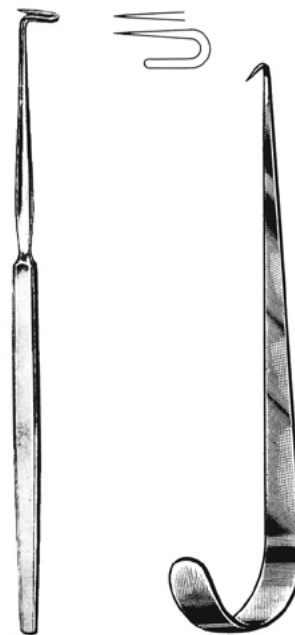
Iterson 16,0 cm

7020.16

7022.16

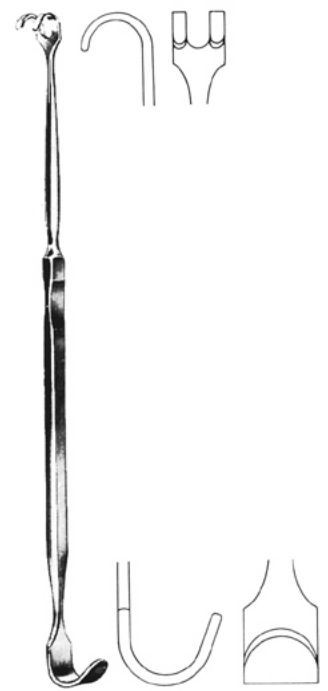


Bose
16,0 cm links
7025.16



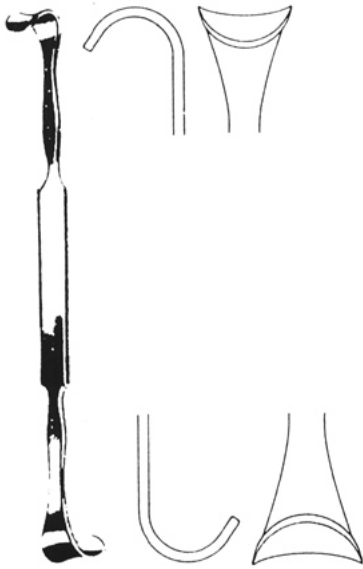
Bose
16,0 cm rechts
7027.16

Jackson
15,0 cm
7030.15



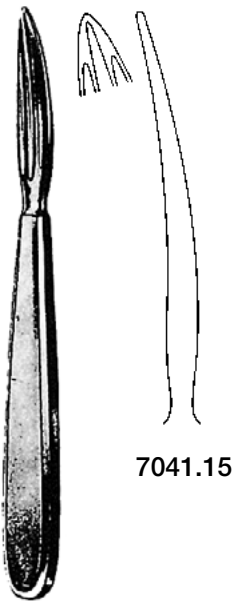
Jackson
17,0 cm
7033.17

TRACHEOTOMIE
TRACHEOTOMY
TRACHÉOTOMIE
TRAQUEOTOMÍA
TRACHEOTOMIA



13,0 cm 7035.13 Rose

SONDE, KROPFFASSZANGE, MUSKELKLEMME
 DIRECTORS-ENUCLEATORS, GOITRE SEIZING FORCEPS, MUSCULAR CLAMP
 SONDAS ACANALADAS, PINZA PARA COGER EL BOCIO, PINZA-CLAMP PARA MÚSCULOS

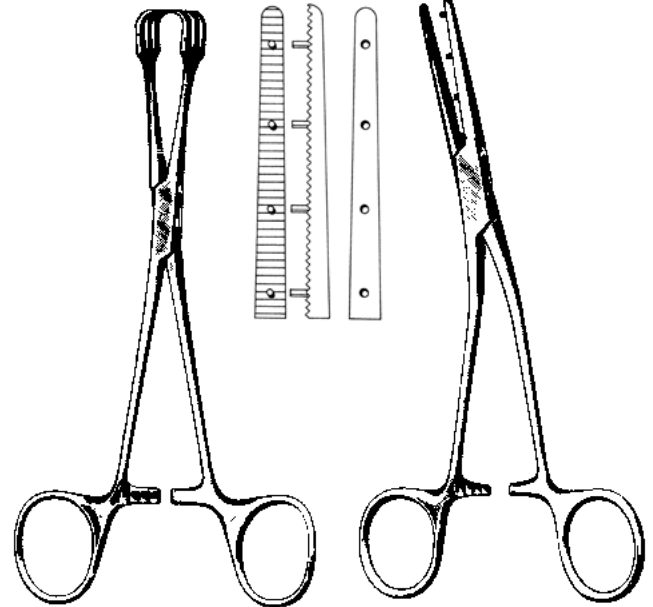


7041.15

Kocher
15 cm



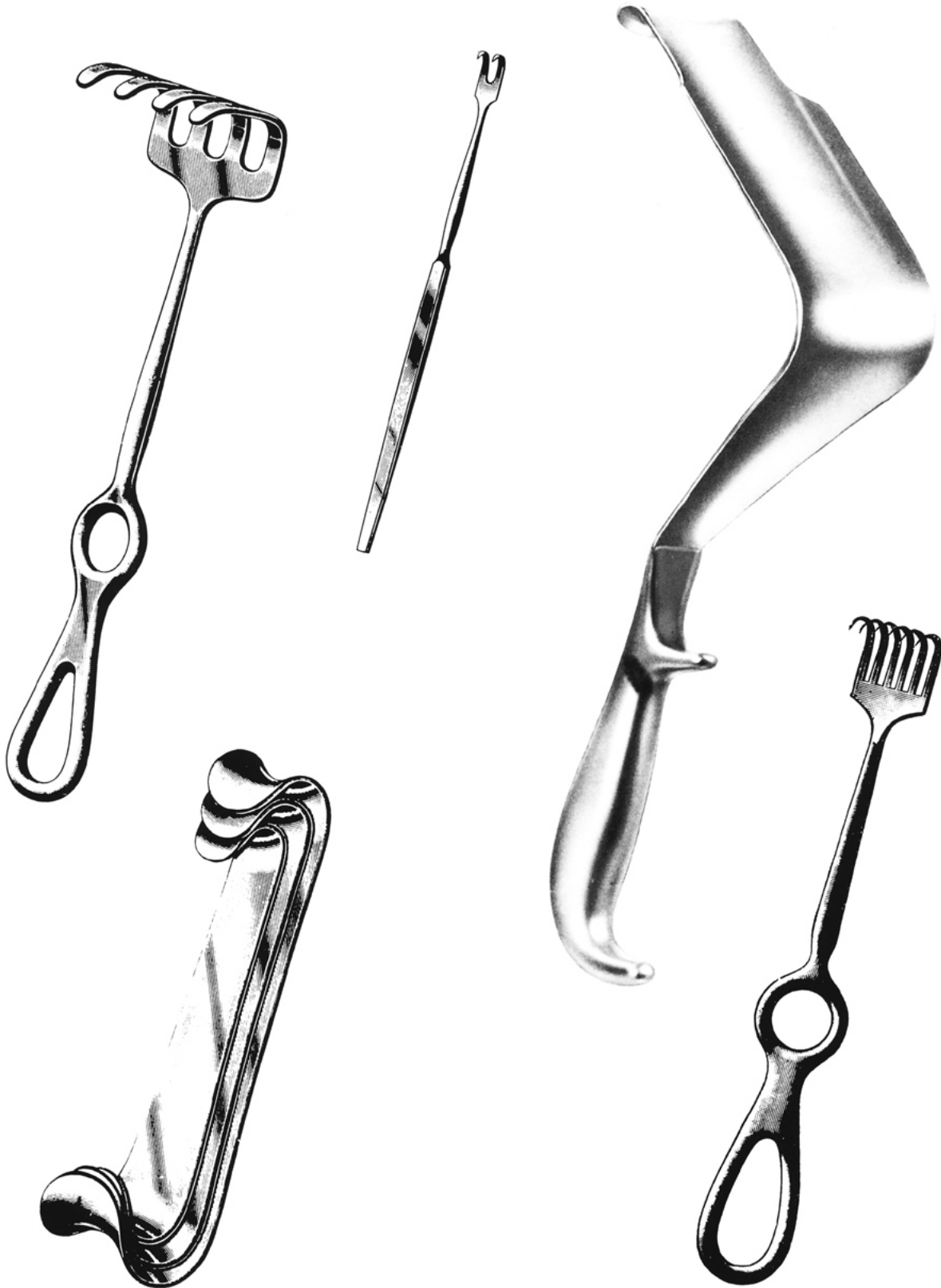
Schoenborn
7044.21
21 cm



Lahey
7046.15 15 cm
7046.20 20 cm

Mastin
7048.17 17 cm

WUNDHAKEN
RETRACTORS
ECARTEURS
SEPARADORES
DIVARICATORI



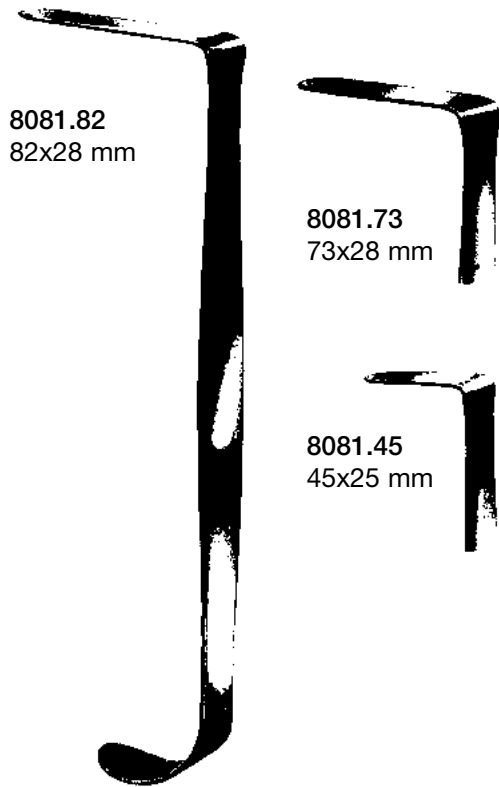
MATTES

**WUNDHAKEN
RETRACTORS
ECARTEURS
SEPARADORES
DIVARICATORI**

<p>1/2</p> <p>16,0 cm/6 1/4"</p>	scharf sharp	stumpf blunt	<p>16,0 cm/6 1/4"</p>	scharf sharp	stumpf blunt	<p>16,0 cm/6 1/4"</p>	<p>flexibel flexible</p>	<p>Guthrie 8036.16</p> <p>Guthrie 8037.16</p>
	8001.16	8011.16		8022.16	8032.16			
	8002.16	8012.16		8023.16	8033.16			
	8003.16	8013.16		8024.16	8034.16			
	8004.16	8014.16						

<p>Volkmann 22,0 cm/8 1/4"</p>	scharf sharp	stumpf blunt	<p>Joseph</p>	
	8041.22	8051.22		8058.01
	8042.22	8052.22		2 mm 8058.02
	8043.22	8053.22		5 mm 8058.05
	8044.22	8054.22		7 mm 8058.07
	8046.22	8056.22		10 mm 8058.10

WUNDHAKEN
RETRACTORS
SEPARADORES
DIVARICATORI



8081.82
82x28 mm

8081.73
73x28 mm

8081.45
45x25 mm

Heaney
8081.82 - 8081.45
27 cm



23 mm

scharf
sharp
agudo
acuto

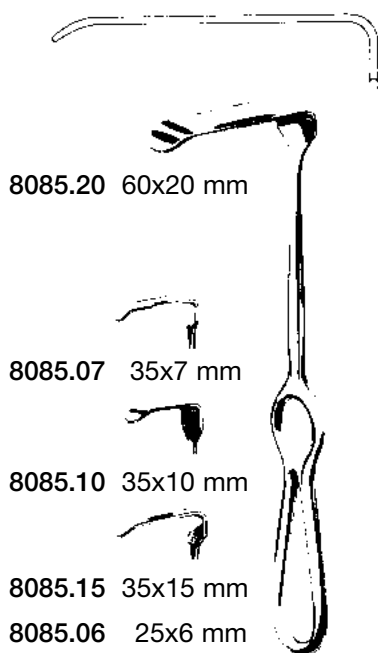
Volkmann
8083.01



23 mm

stumpf
blunt
romo
smusso

Volkmann
8084.01



8085.20 60x20 mm

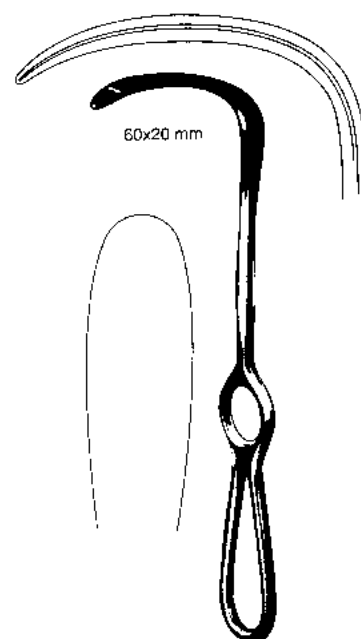
8085.07 35x7 mm

8085.10 35x10 mm

8085.15 35x15 mm

8085.06 25x6 mm

Langenbeck
8085.20 - 8085.06
21 cm



60x20 mm

Langenbeck
8086.21
21 cm

MATTES

WUNDHAKEN
RETRACTORS
ECARTEURS
SEPARADORES
DIVARICATORI



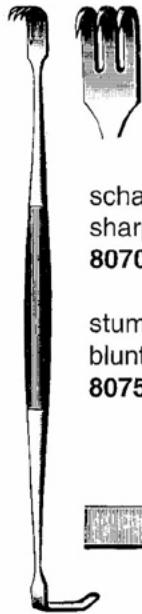
Senn-Green
16,0 cm



10 x 6 m
8060.10



8060.16
14 x 6 mm



Senn-Müller
16,0 cm/6¼"

scharf
sharp
8070.16

stumpf
blunt
8075.16



28 x 6mm

Lahey
19,5 cm/8"
8080.20



Little
20,0 cm/8"
8090.20



Kocher
22,0 cm/8¼"

scharf
sharp



8101.22



8102.22



8103.22



8104.22



8106.22

stumpf
blunt



8111.22



8112.22



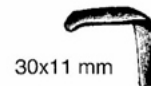
8113.22



8114.22

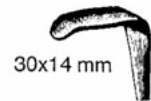


Fig. 1-4
8125.01 bis 04



30x11 mm

8125.01



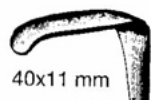
30x14 mm

8125.02



30x16 mm

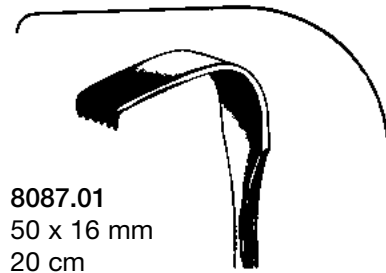
8125.03



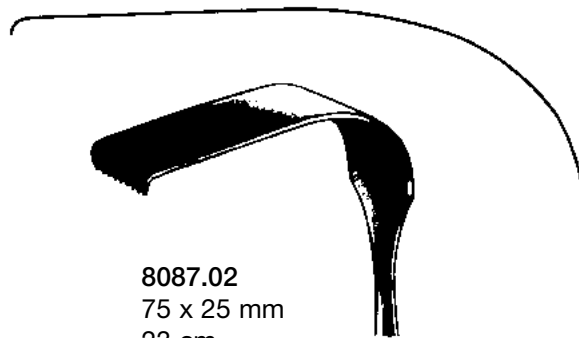
40x11 mm

8125.04

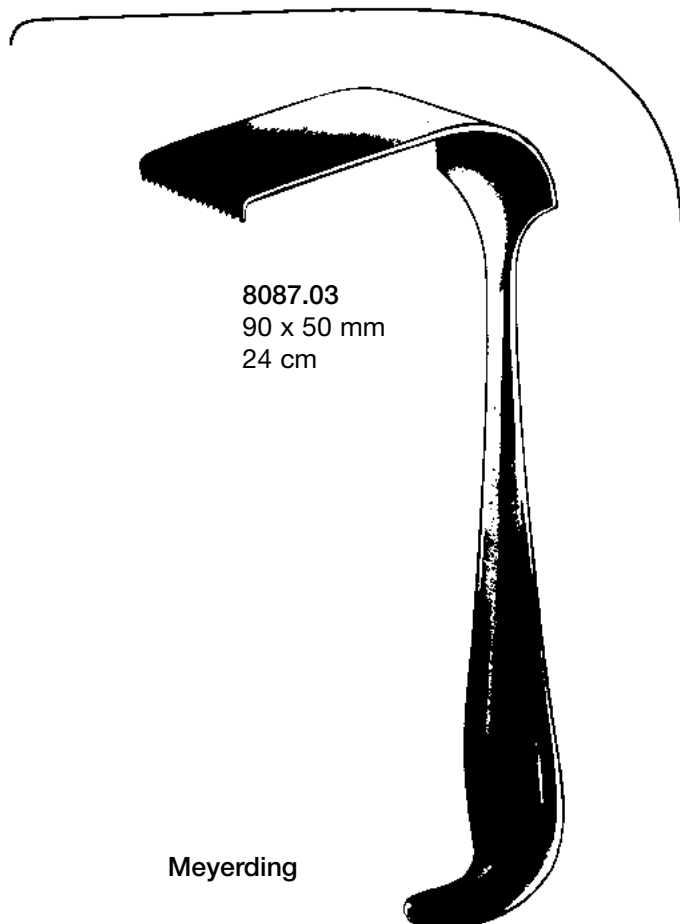
WUNDHAKEN
RETRACTORS
SEPARADORES
DIVARICATORI



8087.01
50 x 16 mm
20 cm



8087.02
75 x 25 mm
23 cm

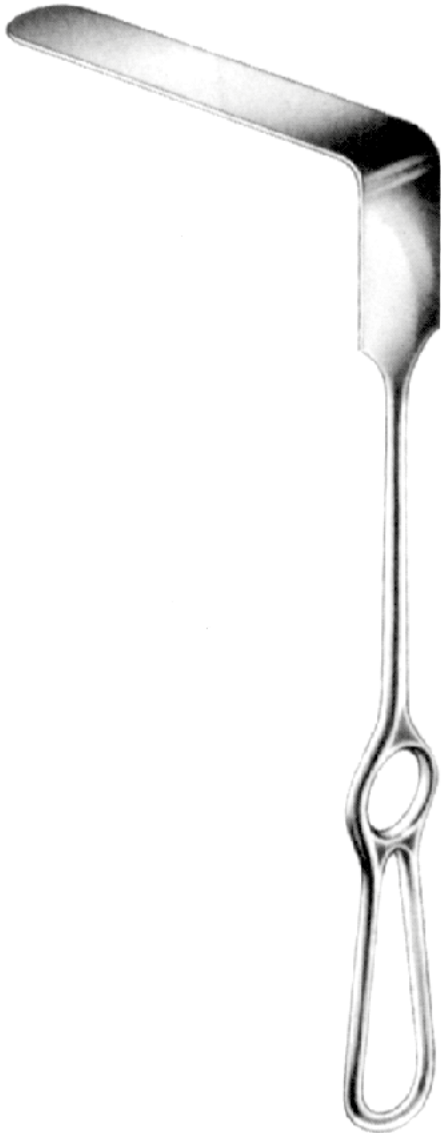


8087.03
90 x 50 mm
24 cm

Meyerding

MATTES

WUNDHAKEN
RETRACTORS
SEPARADORES
DIVARICATORI



Brunner
25 cm

8088.80	80 x 20 mm
8088.00	100 x 20 mm
8088.12	120 x 25 mm
8088.14	140 x 30 mm
8088.16	160 x 30 mm
8088.18	180 x 30 mm



Hösel
25 cm

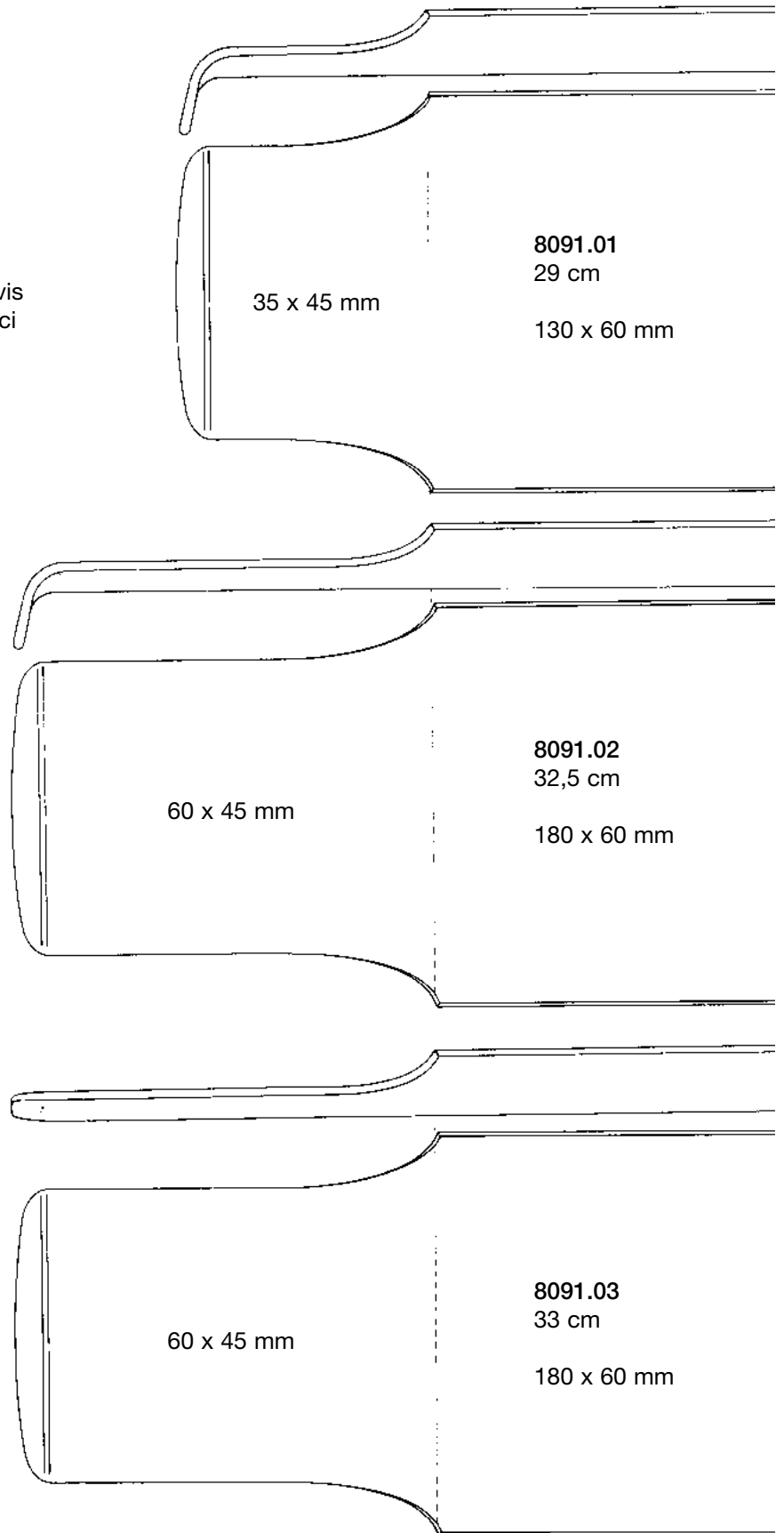
8089.60	60 x 20 mm
8089.80	80 x 30 mm
8089.00	100 x 30 mm
8089.12	120 x 30 mm
8089.14	140 x 30 mm

WUNDHAKEN
RETRACTORS
SEPARADORES
DIVARICATORI

Pelvis-Haken
Pelvis retractor
Retractor de pelvis
Divaricatori pelvici



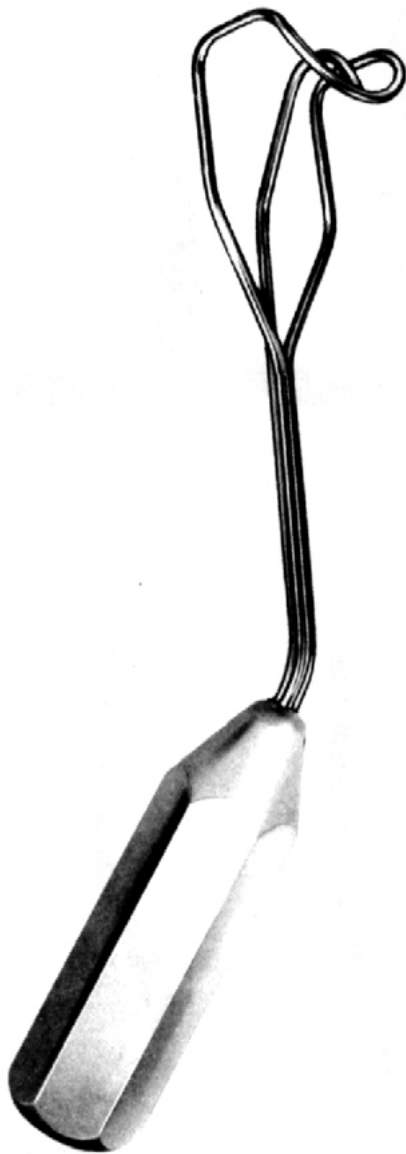
St. Marks
8091.01 - 8091.03



MATTES

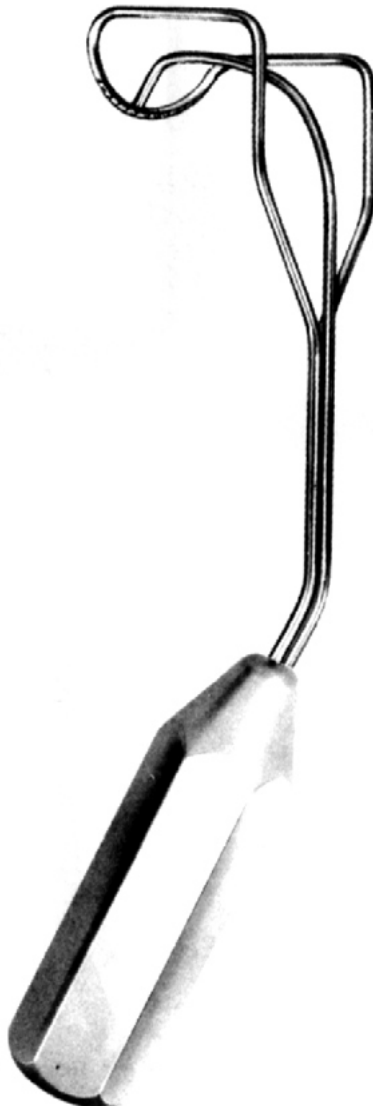
WUNDHAKEN
RETRACTORS
SEPARADORES
DIVARICATORI

rechts
right
a la derecha
a destra
(45 mm x 48 mm)



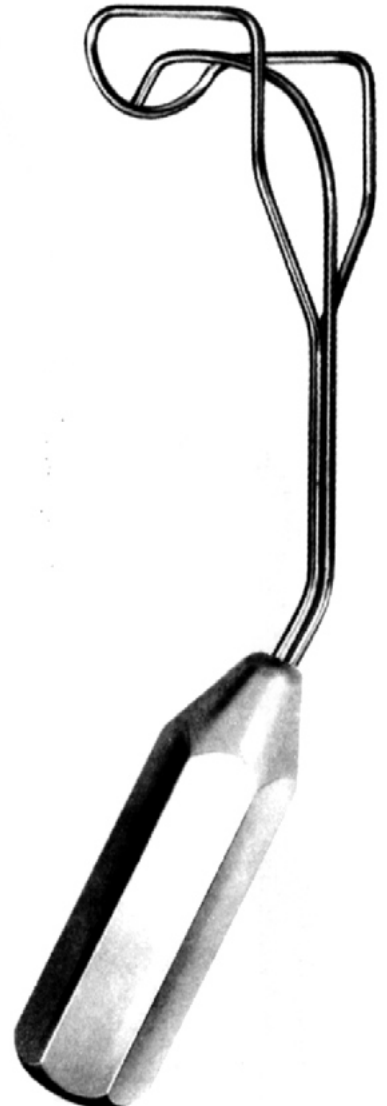
Cooley
8092.01
21,5 cm

rechts, gerieft
right serrated
a la derecha, estriado
a destra, zigrinada
(45 mm x 48 mm)



Cooley
8092.02
21,5 cm

links
left
a la izquierda
a sinistra
(45 mm x 48 mm)



Cooley
8092.03
23 cm

WUNDHAKEN
RETRACTORS
SEPARADORES
DIVARICATORI



35 x 8 mm

Zenker
8093.35
25 cm



60 x 12 mm

Zenker
8093.60
26 cm

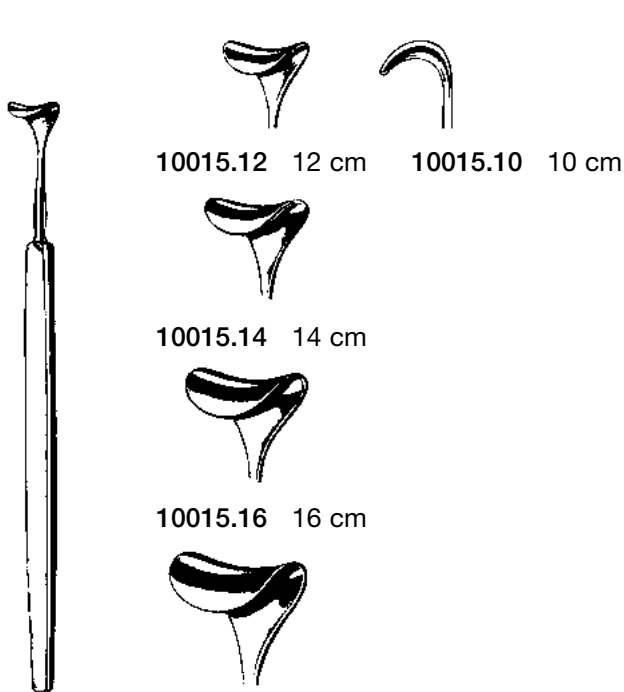


75 x 12 mm

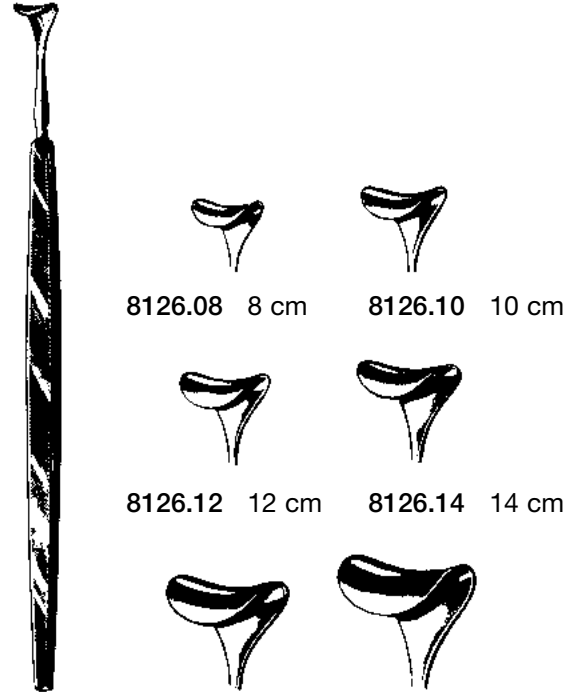
Zenker
8093.75
27,5 cm

MATTES

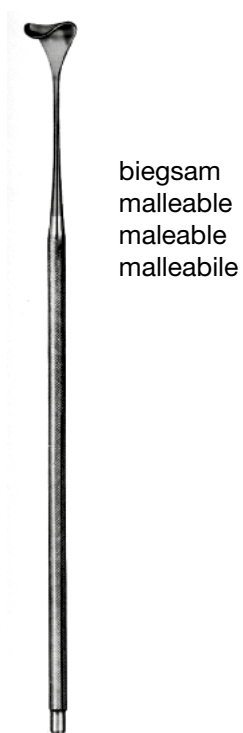
WUNDHAKEN
RETRACTORS
SEPARADORES
DIVARICATORI



Desmarres 10015.18 18 cm
16 cm



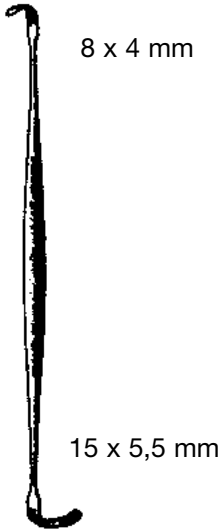
Cushing 8126.16 16 cm 8126.26 18 cm
20 cm



Gil-Vernet
8128.08 - 8128.23



WUNDHAKEN
RETRACTORS
SEPARADORES
DIVARICATORI



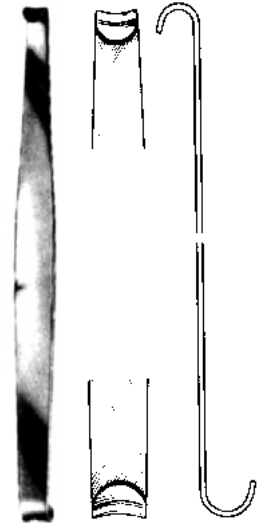
Ragnell
8131.14 14 cm



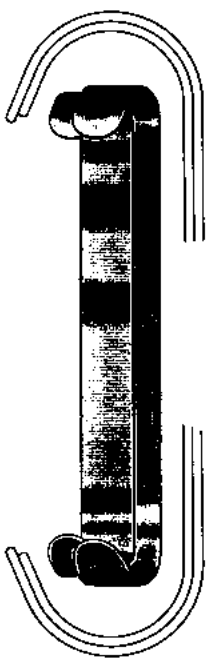
Crile
8132.11 11,5 cm



Roux Baby
8133.13 13 cm



Roux mini
8134.15 15 cm



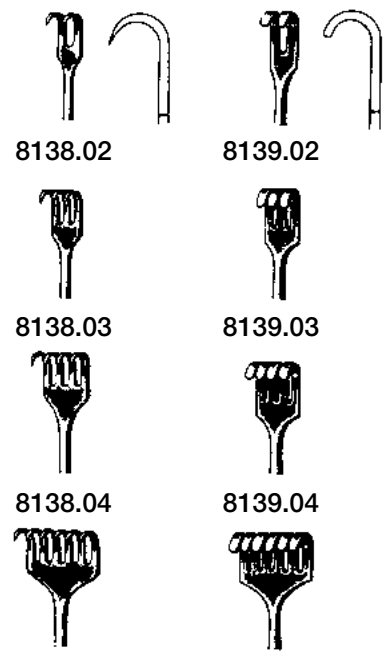
Parker
8135.13 13,5 cm



Goelet
8136.19 19 cm



Volkmann
11,5 cm



8138.02

8139.02

8138.03

8139.03

8138.04

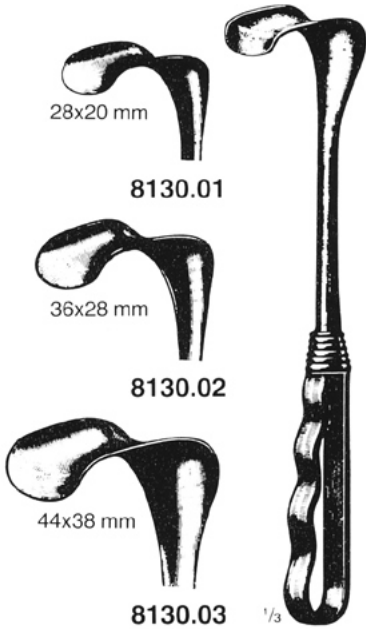
8139.04

8138.06

8139.06

MATTES

WUNDHAKEN
RETRACTORS
ECARTEURS
SEPARADORES
DIVARICATORI



28x20 mm

8130.01

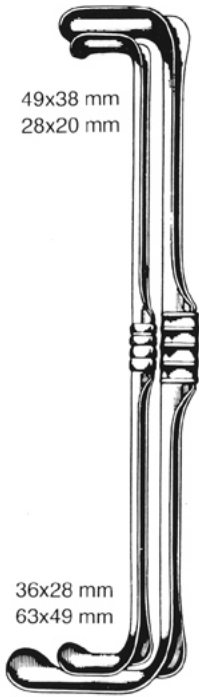
36x28 mm

8130.02

44x38 mm

8130.03

Richardson
24,0 cm/9½"



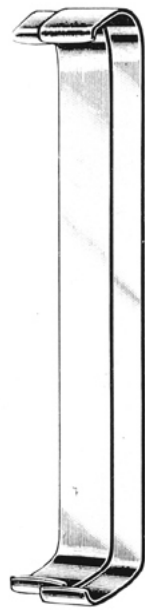
49x38 mm
28x20 mm

36x28 mm
63x49 mm

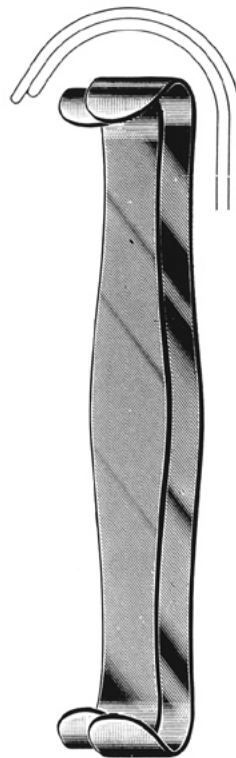
Richardson-Eastman
Satz - Set - Juego
8140.00



Mathieu
20,0 cm/8"
8160.00



Farabeuf
8170.00



Parker
16,0 cm/6¼"
8180.00



Farabeuf
12,0 cm/4¾"
8190.00



Roux Satz/Set/Juego
17,0 cm/6¾" **8200.00**
Fig.1 8201.01
Fig.2 8202.02
Fig.3 8203.03

Satz - Set - Juego

WUNDHAKEN
RETRACTORS
ECARTEURS
SEPARADORES
DIVARICATORI



Fritsch
24,0 cm/9½"

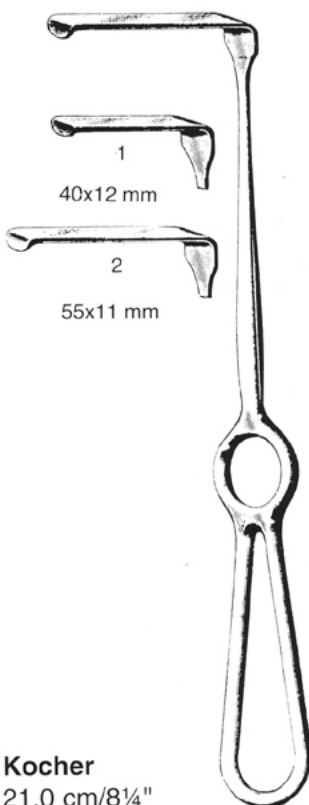
- Fig. 2 45x40 mm **8210.02**
- Fig. 3 45x50 mm **8210.03**
- Fig. 4 45x60 mm **8210.04**
- Fig. 5 45x75 mm **8210.05**



32x15 mm
28x15 mm

42x15 mm
47x15 mm

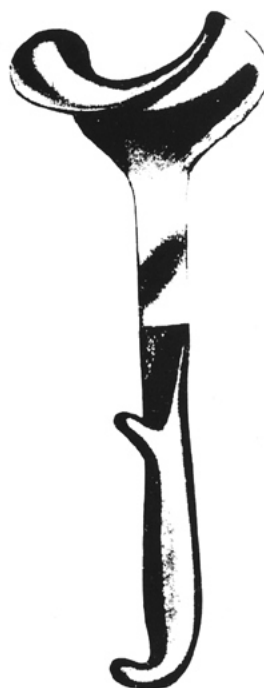
Satz/Set/Juego
USA Modell
21,0 cm/8¼"
8220.00



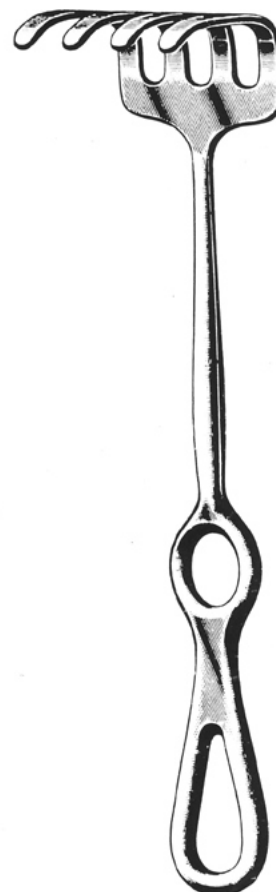
Kocher
21,0 cm/8¼"
Fig. 1 **8250.01**

1
40x12 mm

2
55x11 mm



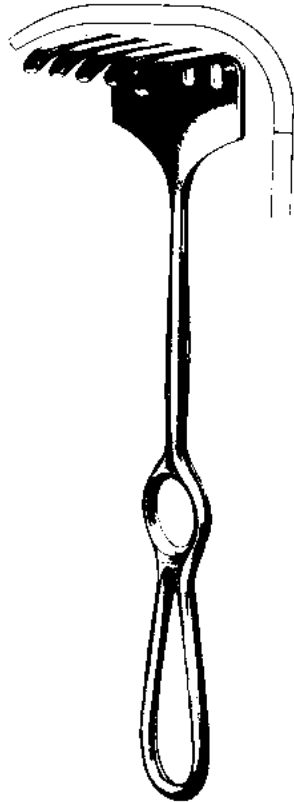
Doyen
25,0 cm/10" **8260.25**



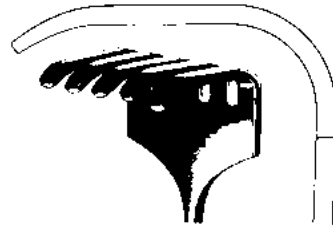
Ollier
22,5 cm/9" **8270.23**

MATTES

WUNDHAKEN
RETRACTORS
SEPARADORES
DIVARICATORI



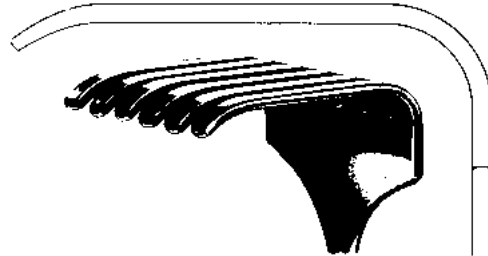
Israel
8271.40 40x40 mm
25 cm



8271.50 45x50 mm



8271.60 50x60 mm



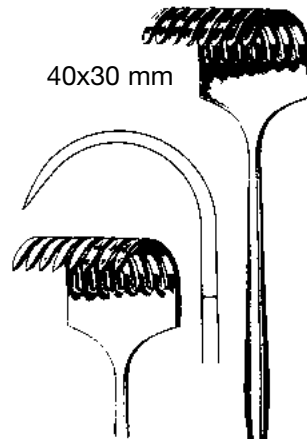
8271.70 70x70 mm



Cushing
8274.20 20 cm



Cushing
8275.21 21,5 cm



40x30 mm

spitz
sharp
agudo
acuto

8276.08

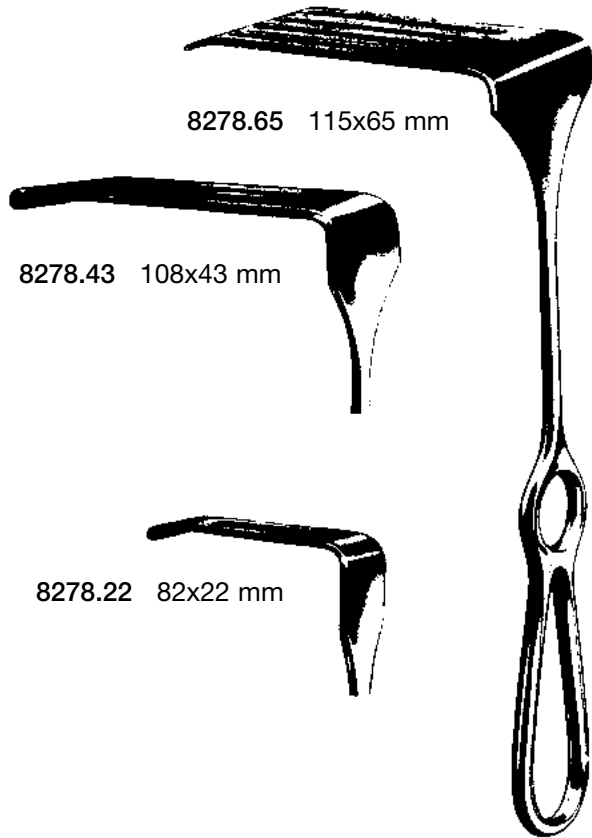


Koerte
23,5 cm

stumpf
blunt
romo
smusso

8277.08

WUNDHAKEN
RETRACTORS
SEPARADORES
DIVARICATORI

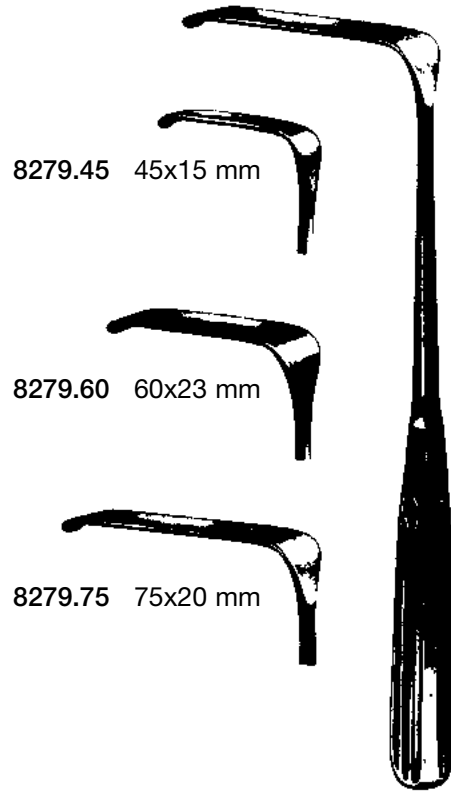


8278.65 115x65 mm

8278.43 108x43 mm

8278.22 82x22 mm

Coryllos (Thorax)
8278.22 - 8278.65
24 cm

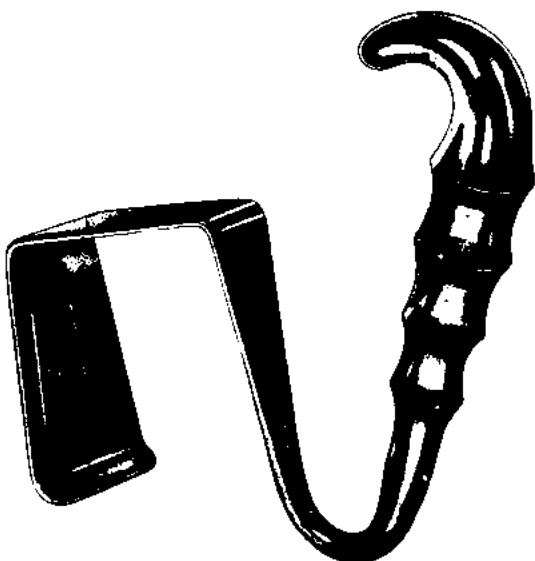


8279.45 45x15 mm

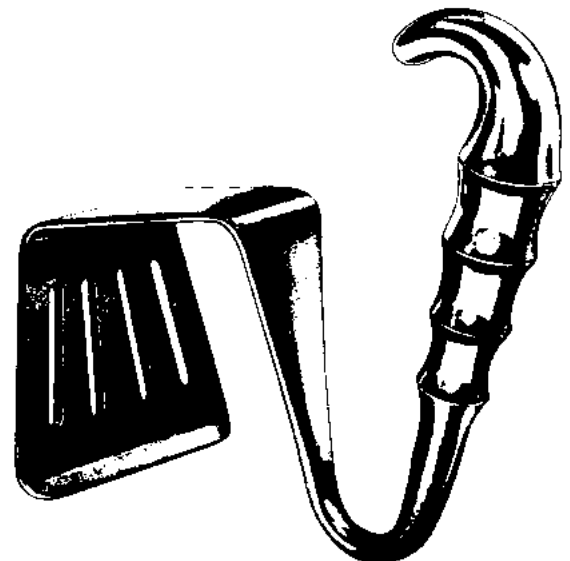
8279.60 60x23 mm

8279.75 75x20 mm

Sauerbruch
8279.45 - 8279.75
22,5 cm



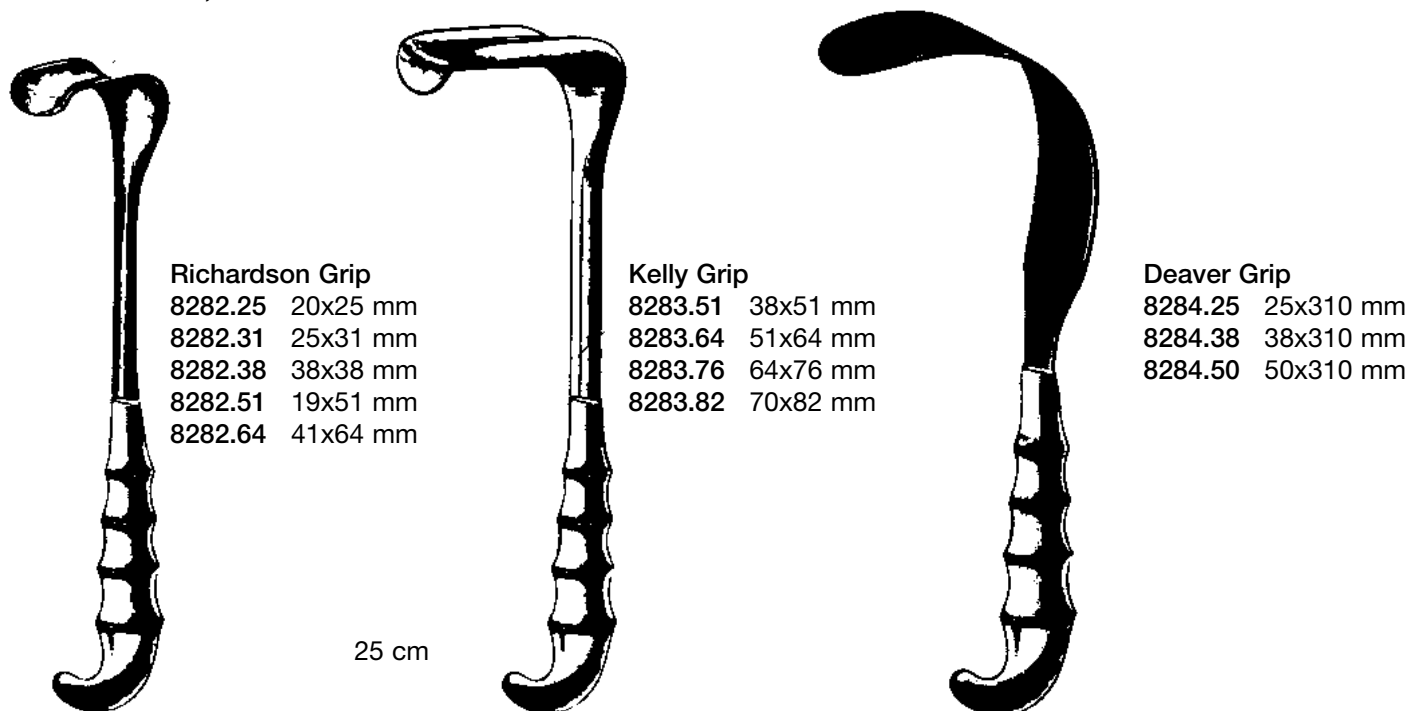
Davidson (Scapula)
8281.50 75x50 mm



Davidson (Scapula)
8281.90 75x90 mm

MATTES

WUNDHAKEN, LUNGENSEPATEL
RETRACTORS, LUNG SPATULA
SEPARADORES, ESPÁTULAS PULMONARES
DIVARICATORI, SPATOLE PER PALMONE



Richardson Grip

8282.25 20x25 mm
8282.31 25x31 mm
8282.38 38x38 mm
8282.51 19x51 mm
8282.64 41x64 mm

Kelly Grip

8283.51 38x51 mm
8283.64 51x64 mm
8283.76 64x76 mm
8283.82 70x82 mm

Deaver Grip

8284.25 25x310 mm
8284.38 38x310 mm
8284.50 50x310 mm

25 cm

DARMSPATEL - INTESTINAL SPATULAS ESPATULAS INTESTINALES - SPATOLE INTESTINALI

biegsam, malleable, maleables, malleabili



Ribbon

8286.06 6x200 mm
8286.10 10x200 mm
8286.12 12x200 mm
8286.17 17x200 mm
8286.20 20x200 mm
8286.25 25x200 mm



Ribbon

8287.20 20x330 mm
8287.25 25x330 mm
8287.40 40x330 mm
8287.50 50x330 mm
8287.76 76x330 mm



Haberer

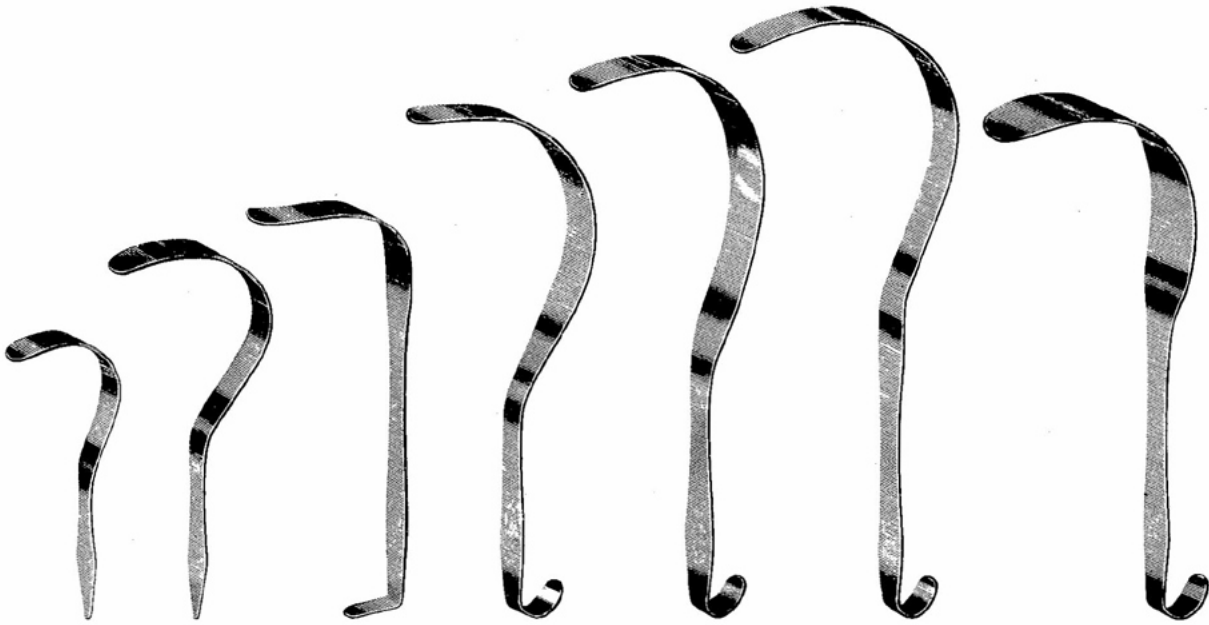
8288.17 17/25x200 mm
8288.25 25/30x280 mm
8288.37 37/45x300 mm
8288.40 40/50x300 mm



Reverdin

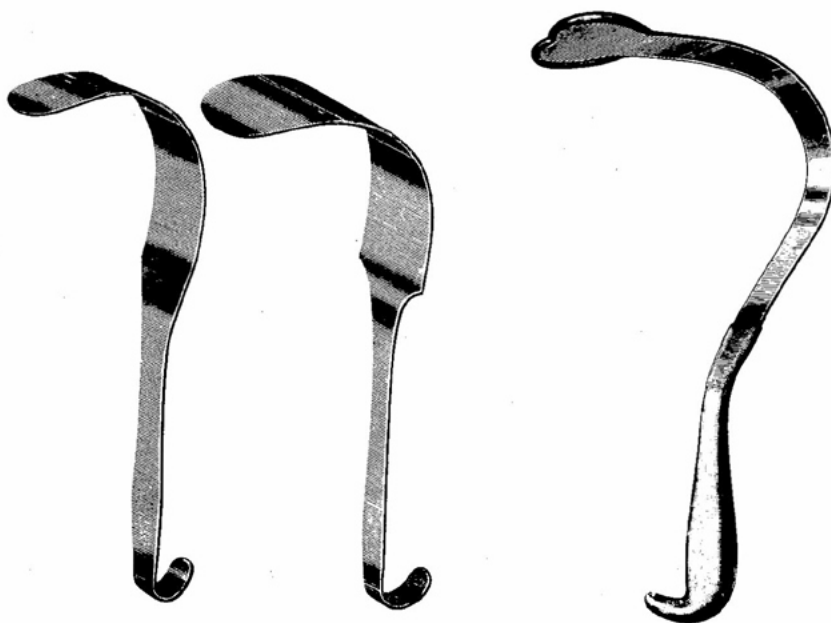
8289.28
28 mm

WUNDHAKEN
RETRACTORS
ECARTEURS
SEPARADORES
DIVARICATORI



Deaver

19x180mm	22x215mm	25x230mm	25x300mm	25x330mm	25x360mm	38x300mm
8280.01	8280.02	8280.03	8280.04	8280.05	8280.06	8280.07

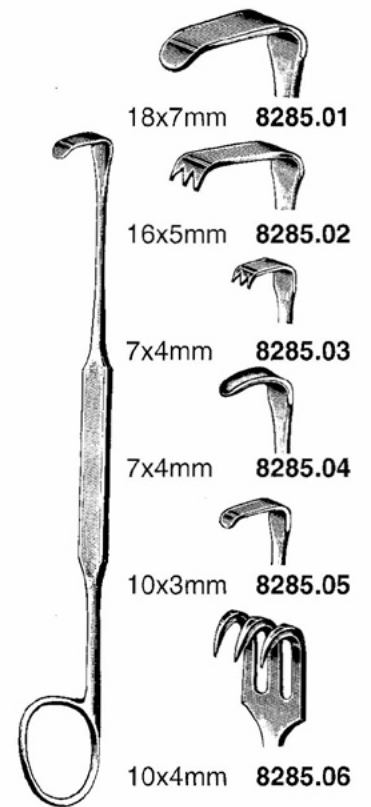


Deaver

50x300mm	75x300mm
8280.08	8280.09

Harrington

32,0 cm/12½"
Fig. 1 40mm 8290.01
Fig. 2 62mm 8290.02



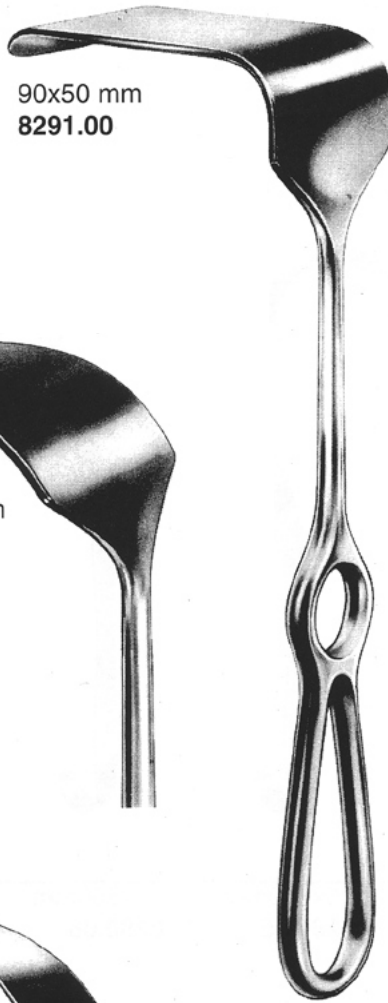
Meyerding

18,0 cm

18x7mm	8285.01
16x5mm	8285.02
7x4mm	8285.03
7x4mm	8285.04
10x3mm	8285.05
10x4mm	8285.06

MATTES

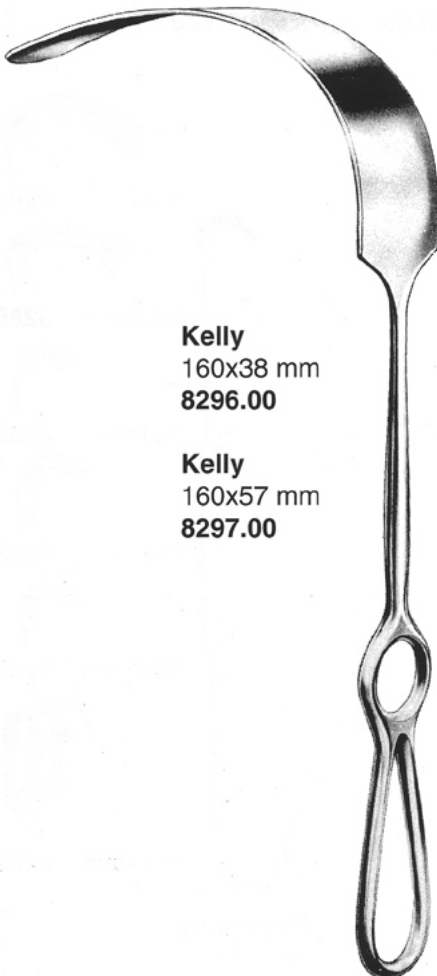
WUNDHAKEN
RETRACTORS
ECARTEURS
SEPARADORES
DIVARICATORI



90x50 mm
8291.00

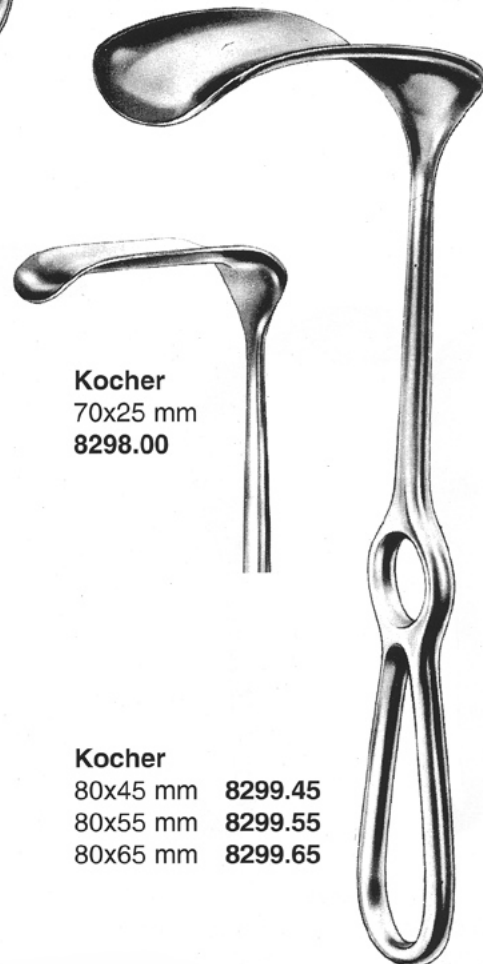


150x50 mm
8293.00



Kelly
160x38 mm
8296.00

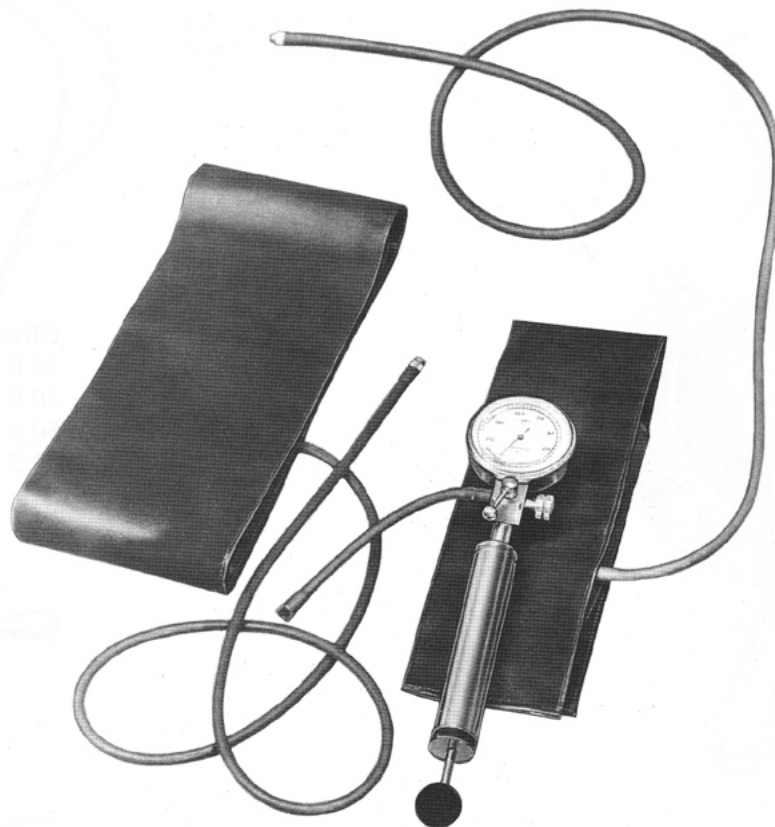
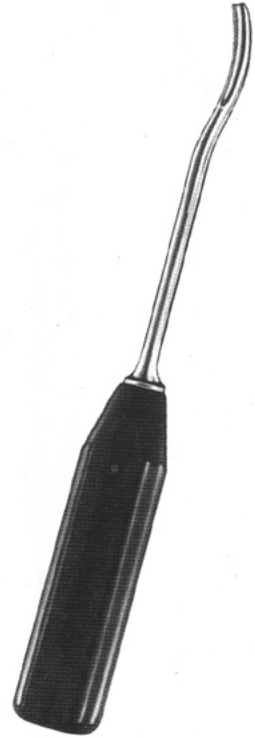
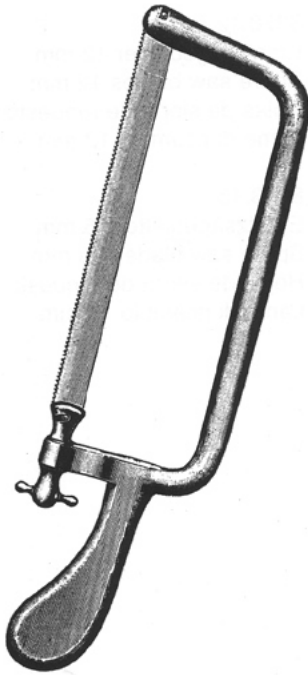
Kelly
160x57 mm
8297.00



Kocher
70x25 mm
8298.00

Kocher
80x45 mm 8299.45
80x55 mm 8299.55
80x65 mm 8299.65

OSTEOTOME, HOHLMEISSEL
CHISELS, GOUGES
CINCELES, GUBIAS
SCALPELLI, SGORBIE

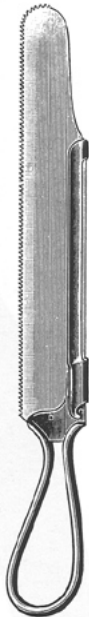


MATTES

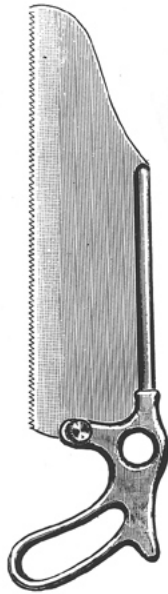
AMPUTATION
AMPUTATION
AMPUTATION
AMPUTACIÓN
AMPUTAZIONE



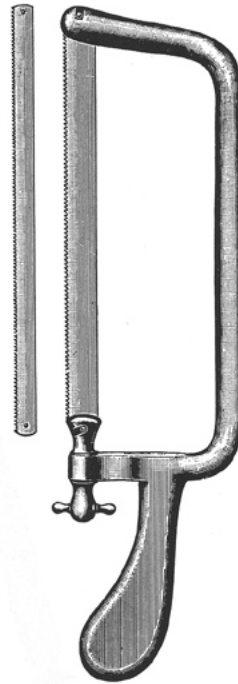
Langenbeck
8365.23



Charrière
8367.30



Satterlee
8370.31

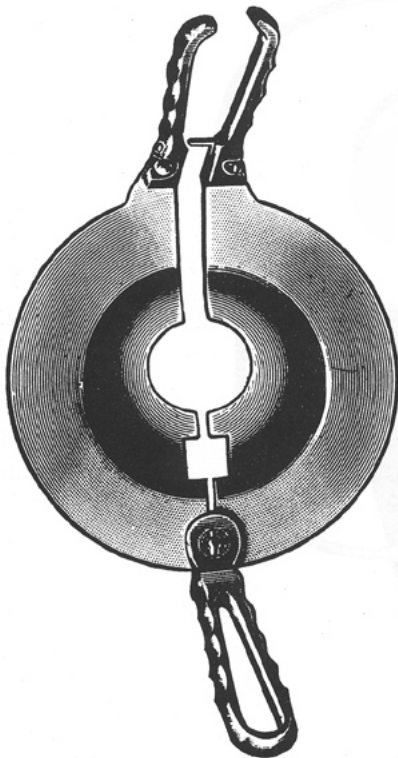


Charrière
8375.35

komplett mit 2 Blättern
complete with 2 blades
completo con 2 hojas
completa con 2 lame

8378.12
Ersatzsägeblätter 12 mm
Spare saw blades 12 mm
Hojas de sierra de repuesto 12 mm
Lame di ricambio 12 mm

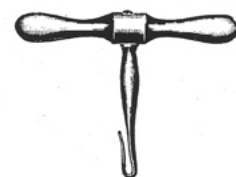
8378.15
Ersatzsägeblätter 15 mm
Spare saw blades 15 mm
Hojas de sierra de repuesto 15 mm
Lame di ricambio 15 mm



Percy
8369.00



Olivecrona
30,0 cm 8380.30
40,0 cm 8380.40
50,0 cm 8380.50
60,0 cm 8380.60
70,0 cm 8380.70



Gigli Sägegriff
8382.00 p. Stück

OSTEOTOME, HOHLMEISSEL MIT FERROZELL-GRIFF
CHISELS AND GOUGES WITH FERROZELL-HANDLE
GUBIAS CON MANGO DE FERROZELL
OSTEOTOMO, CON MANICO DI FERROZELL



Lexer-Mini
 4 mm **8300.04**
 6 mm **8300.06**
 8 mm **8300.08**
 10 mm **8300.10**
 12 mm **8300.12**



Lexer-Mini
 8305.04
 8305.06
 8305.08
 8305.10
 8305.12



- 7 mm
- 10 mm
- 15 mm
- 20 mm
- 25 mm
- 30 mm

10 mm
8310.10
 15 mm
8310.15
 20 mm

7 mm
8315.07
 10 mm
8315.10
 15 mm
8315.15
 20 mm
8315.20
 25 mm
8315.25
 30 mm
8315.30

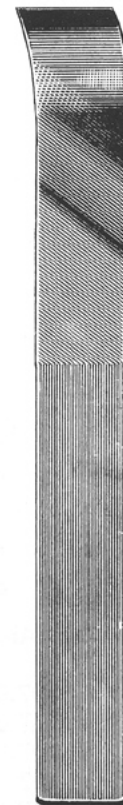
Lexer
 22,0 cm/8³/₄"



Lambotte
 25,0 cm/10"

4 mm **8330.04**
 6 mm **8330.06**
 8 mm **8330.08**
 10 mm **8330.10**
 13 mm **8330.13**

 20 mm **8330.20**
 25 mm **8330.25**
 30 mm **8330.30**
 38 mm **8330.38**
 44 mm **8330.44**
 50 mm **8330.50**

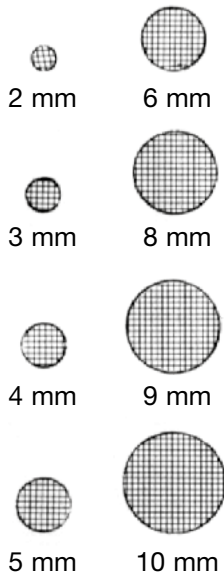
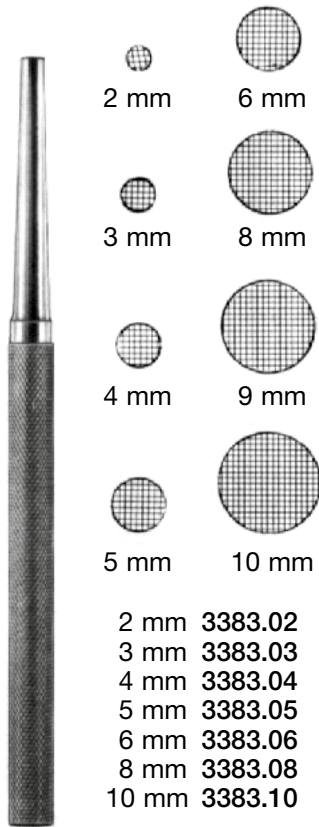


Lambotte
 25,0 cm/10"

4 mm **8335.04**
 6 mm **8335.06**
 8 mm **8335.08**
 10 mm **8335.10**
 13 mm **8335.13**
 16 mm **8335.16**
 18 mm **8335.18**
 20 mm **8335.20**
 25 mm **8335.25**
 30 mm **8335.30**
 38 mm **8335.38**
 44 mm **8335.44**
 50 mm **8335.50**

MATTES

STÖSSEL, FLACHMEISSEL, HOHLMEISSEL
 HEMOSTATS, CHISELS, GOUGES
 HEMOSTÁTICOS, CINCELES, GUBIAS
 PISTONI, SCALPELLI, SGORBIE



2 mm 3383.02
 3 mm 3383.03
 4 mm 3383.04
 5 mm 3383.05
 6 mm 3383.06
 8 mm 3383.08
 10 mm 3383.10

16 cm



13,5 cm

4 mm 3385.04
 6 mm 3385.06
 8 mm 3385.08
 10 mm 3385.10
 12 mm 3385.12
 14 mm 3385.14
 16 mm 3385.16



13,5 cm

3386.04
 3386.06
 3386.08
 3386.10
 3386.12
 3386.14
 3386.16



13,5 cm

3387.04
 3387.06
 3387.08
 3387.10
 3387.12
 3387.14
 3387.16



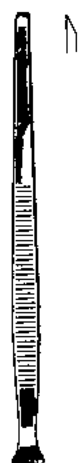
Alexander
 17 cm

8306.04 4 mm
 8306.06 6 mm
 8306.08 8 mm
 8306.10 10 mm
 8306.12 12 mm
 8306.14 14 mm



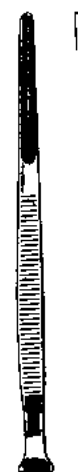
Alexander
 17 cm

8307.04 4 mm
 8307.06 6 mm
 8307.08 8 mm
 8307.10 10 mm
 8307.12 12 mm
 8307.14 14 mm



Partsch

13,5 cm	mm	17 cm
8308.02	2	8309.02
8308.03	3	8309.03
8308.04	4	8309.04
8308.05	5	8309.05
8308.06	6	8309.06
8308.07	7	8309.07
8308.08	8	8309.08



Partsch

mm	17 cm
2	8317.02
3	8317.03
4	8317.04
5	8317.05
6	8317.06
7	8317.07
8	8317.08

FLACHMEISSEL, HOHLMEISSEL
 CHISELS, GOUGES
 CINCELES, GUBIAS
 SCALPELLI, SGORBIE



Hoke
14 cm

8318.03	3 mm
8318.05	5 mm
8318.06	6 mm
8318.08	8 mm
8318.09	9 mm



Hibbs
24 cm

8321.06	6 mm
8321.09	9 mm
8321.13	13 mm
8321.19	19 mm
8321.25	25 mm
8321.32	32 mm



Hibbs
24 cm

8322.06	6 mm
8322.13	13 mm
8322.19	19 mm
8322.25	25 mm
8322.32	32 mm



Hibbs
24 cm

8323.06	6 mm
8323.09	9 mm
8323.13	13 mm
8323.19	19 mm
8323.25	25 mm
8323.32	32 mm



Hibbs
24 cm

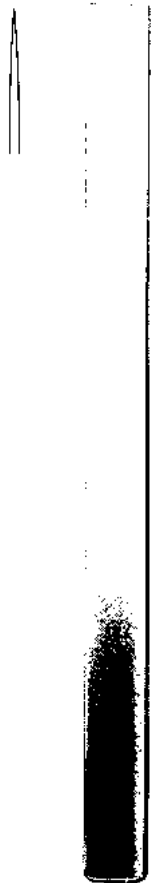
8324.06	6 mm
8324.13	13 mm
8324.19	19 mm
8324.25	25 mm
8324.32	32 mm



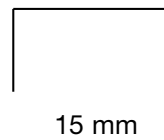
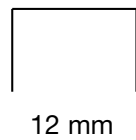
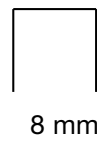
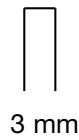
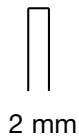
Hibbs
24 cm

8325.06	6 mm
8325.13	13 mm
8325.19	19 mm
8325.25	25 mm
8325.32	32 mm

OSTEOTOME, HOHLMEISSEL
 CHISELS, GOUGES
 CINCELES, GUBIAS
 SCALPELLI, SGORBIE



Mini-Lambotte



12,5 cm	mm	17 cm
8320.02	2	8339.02
8320.03	3	8339.03
8320.04	4	8339.04
8320.06	6	8339.06
8320.08	8	8339.08
8320.10	10	8339.10
8320.12	12	8339.12
	15	8339.15

HOHLMEISSEL MIT FERROZELLGRIFF
 GOUGES WITH FERROZELL-HANDLE
 GUBIAS CON MANGO DE FERROZELL
 SGORBIE CON MANICO DI FERROZELL

8 mm

8 mm

8 mm

8 mm



Cobb
 28 cm
 8341.28



Cobb
 28 cm
 8342.28



Cobb
 28 cm
 8343.28



Cobb
 28 cm
 8344.28

MATTES

FLACHMEISSEL
CHISELS
CINCELES
SCALPELLI

HOHLMEISSEL MIT NOVOTEX-GRIFF
GOUGES WITH NOVOTEX-HANDLE
GUBIAS CON MANGO DE NOVOTEX
SGORBIE CON MANICO DI NOVOTEX

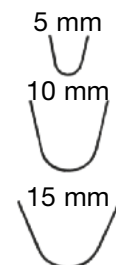


Zielke 23 cm
8348.55 5,5 mm
8348.90 9,0 mm



22 cm
8349.22

9 mm



25 cm
5 mm 8350.05
10 mm 8350.10
15 mm 8350.15

FLACHMEISSEL, HOHLMEISSEL
 CHISELS, GOUGES
 CINCELES, GUBIAS
 SCALPELLI, SGORBIE



Stille
 20 cm

- | | |
|---------|-------|
| 8390.06 | 6 mm |
| 8390.08 | 8 mm |
| 8390.10 | 10 mm |
| 8390.12 | 12 mm |
| 8390.15 | 15 mm |
| 8390.20 | 20 mm |
| 8390.25 | 25 mm |
| 8390.30 | 30 mm |



Stille
 20 cm

- | |
|---------|
| 8394.10 |
| 8394.12 |
| 8394.15 |
| 8394.20 |
| 8394.25 |



Stille
 20 cm

- | | |
|-------|---------|
| 6 mm | 8391.06 |
| 8 mm | 8391.08 |
| 10 mm | 8391.10 |
| 12 mm | 8391.12 |
| 15 mm | 8391.15 |
| 20 mm | 8391.20 |
| 25 mm | 8391.25 |
| 30 mm | 8391.30 |



Stille
 20 cm

- | |
|---------|
| 8392.08 |
| 8392.10 |
| 8392.12 |
| 8392.15 |
| 8392.20 |
| 8392.25 |

**KOMPRIMETER
PNEUMATIC TOURNIQUET
TORNIQUETE PNEUMÁTICO
APPARECCHIO DI COMPRESSIONE**



8340.00
compl.

Gerät zur Erzeugung von Blutleere in den Gliedmaßen
Compression Apparatus for producing blood vacuum in limbs
Aparato de compresión para producir el vacío de sangre en los miembros
Vacumentro per determinare vuoti di sangue nelle membra

8340.02

Pumpe
Air Pump
Bomba de aire
Pompa di aria

8340.03

Manometer
Manometer
Manómetro
Manometro

8340.04

Oberarmmanschette
Cuff for upper arm
Brazalete (brazo)
Bracciale

8340.05

Oberschenkelmanschette
Cuff (leg)
Brazalete (pierna)
Cosciale

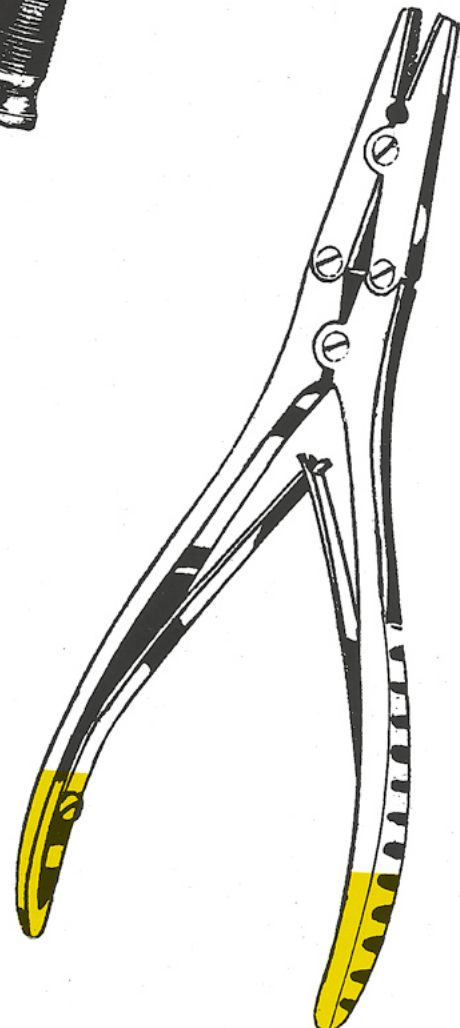
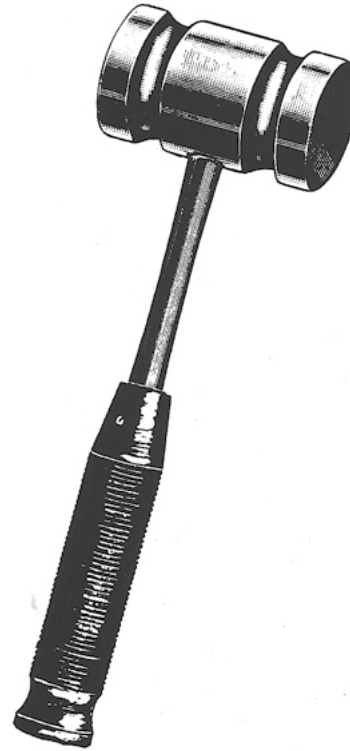
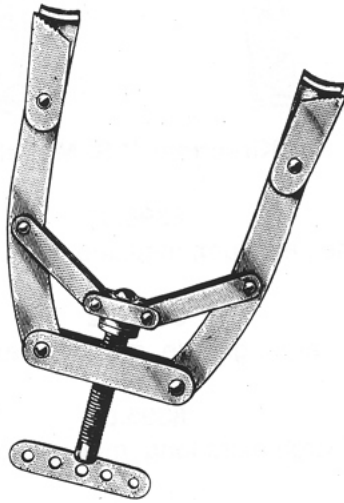
8340.06

Polster für Oberarmmanschette 46 x 6 cm
Bandage cuff for arm 46 x 6 cm
Brazalete para brazo 46 x 6 cm
Bracciale per braccio superiore 46 x 6 cm

8340.07

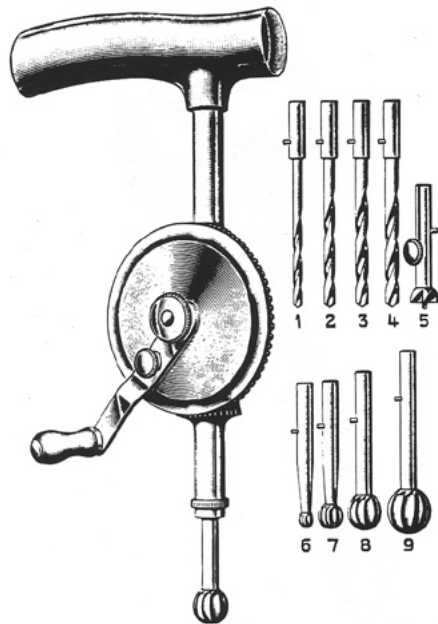
Polster für Oberschenkelmanschette 55 x 10 cm
Bandage cuff for leg 55 x 10 cm
Brazalete para el fémur 55 x 10 cm
Bracciale per coscia superiore 55 x 10 cm

KNOCHENCHIRURGIE
BONE SURGERY
CHIRURGIE OSSEUSE
CHIRURGÍA ÓSEA
CHIRURGIA OSSEA

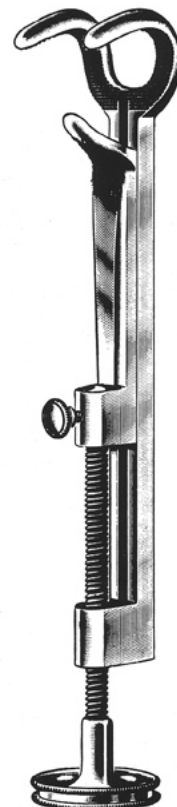


MATTES

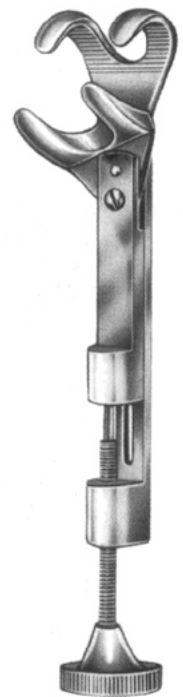
KNOCHENCHIRURGIE
BONE SURGERY
CHIRURGIE OSSEUSE
CHIRURGÍA ÓSEA
CHIRURGIA OSSEA



Stille
8395.00 Komplett mit Bohrer



Lowmann
18,0 cm 8399.18
20,0 cm 8399.20

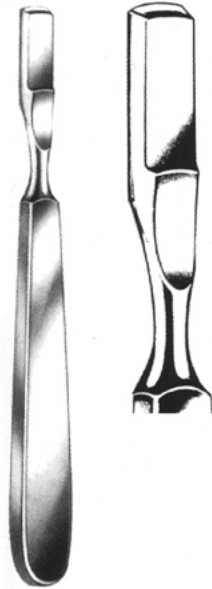


Lowman-Hoglund
8399.19 19 cm

KNOCHENCHIRURGIE
BONE SURGERY
CHIRURGIE OSSEUSE
CHIRURGÍA ÓSEA
CHIRURGIA OSSEA

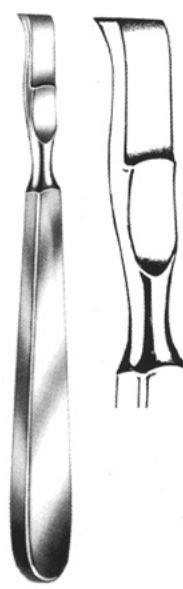
RASPATORIEN
PERIOSTEAL ELEVATORS
RUGINES-RASPATOIRES
PERIOSTÓTOMOS
PERIOSTOTOMI

11 mm

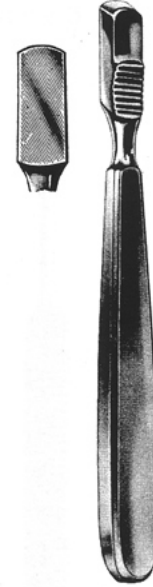


Farabeuf-Collin
8403.16 15,5 cm

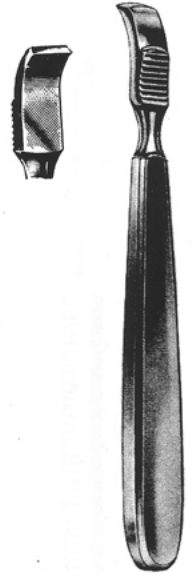
11 mm



Farabeuf-Collin
8404.16 15,5 cm

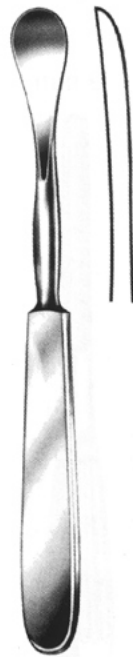


Farabeuf
8403.15



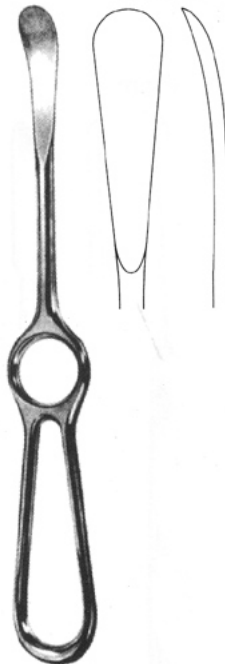
Farabeuf
8404.15

18 mm



Sedillot
8405.18
18 cm

15 mm



Sedillot
8405.21
21 cm

16 mm

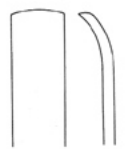


Langenbeck
8408.19
19 cm

14 mm



Langenbeck
8408.18
18 cm



Lambotte
21 cm
8408.05 5 mm
8408.10 10 mm
8408.15 15 mm
8408.20 20 mm
8408.25 25 mm



Langenbeck
8405.20 8 mm
8405.10 10 mm

MATTES

RASPATORIEN, ELEVATOREN
 RASPATORIES, ELEVATORS
 PERIOSTÓTOMOS, ELEVADORES
 PERIOSTOTOMI, ELEVATORI

4 mm



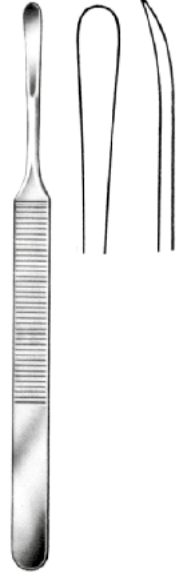
Williger
 8401.01
 16 cm

5,5 mm



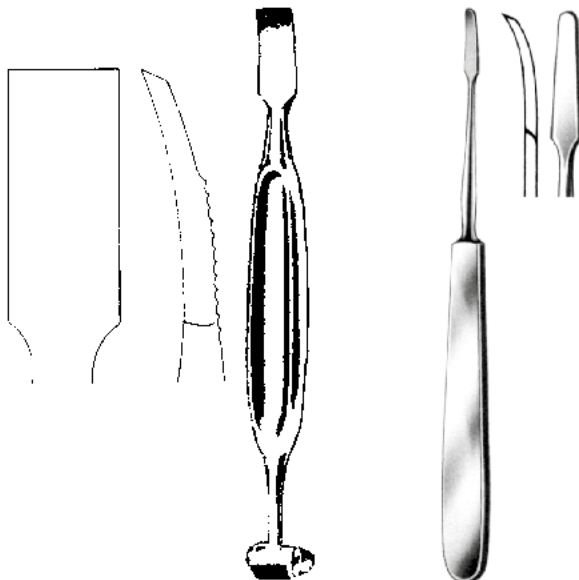
Williger
 8401.04
 17 cm

5 mm



König
 8401.05
 15,5 cm

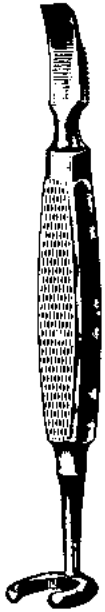
4 mm



Alexander
 8401.06
 20 cm

Joseph
 8401.07
 16 cm

ELEVATOREN, RASPATOREN
 ELEVATORS, RASPATORIES
 ELEVADORES, PERIOSTÓTOMOS
 ELEVATORI, PERIOSTOTOMI



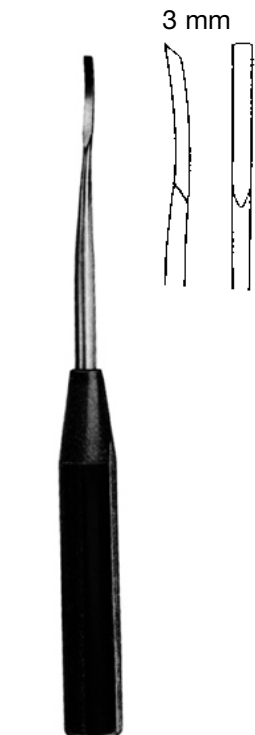
Matson-Alexander
 8401.11



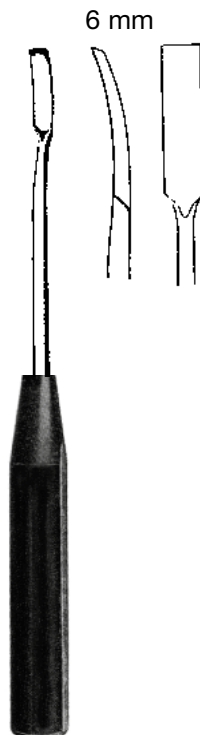
Matson
 8401.12 22 cm



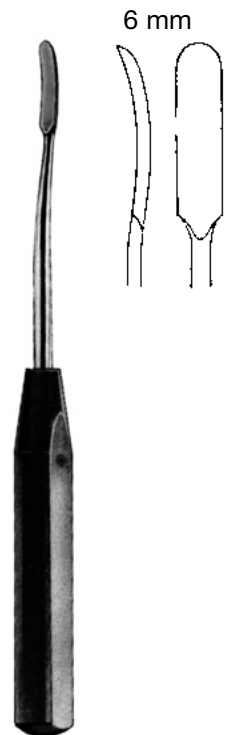
8401.16 19 cm



8401.17 18,5 cm



8401.18 18,5 cm



8401.19 18,5 cm

MATTES

RASPATORIEN, ELEVATOREN
 RASPATORIES, ELEVATORS
 PERIOSTÓTOMOS, ELEVADORES
 PERIOSTOTOMI, ELEVATORI



Doyen
17 cm



8406.17



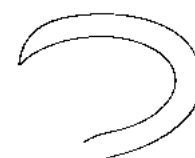
8406.15



Doyen
17 cm



8407.17



8407.15



Semb

12 mm



8402.01
17,5 cm

12 mm



8402.02
21 cm

12 mm



8402.03
17,5 cm

13 mm



8402.04
21 cm

15 mm

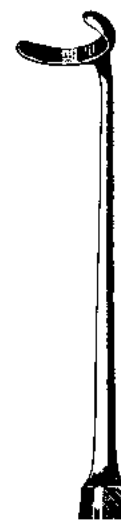


8402.05
20,5 cm

15 mm



8402.06
20,5 cm



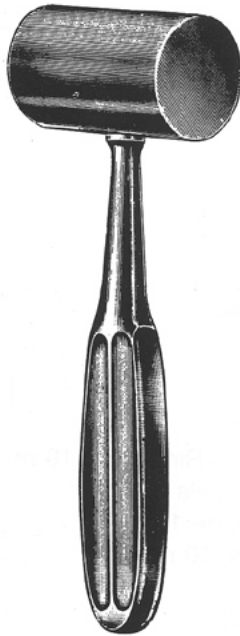
8402.07
22,5 cm

MATTES

HÄMMER
BONE HAMMERS AND MALLETS
MAILLETS
MARTILLOS Y MAZOS
MARTELLI



Gerzog
8410.25



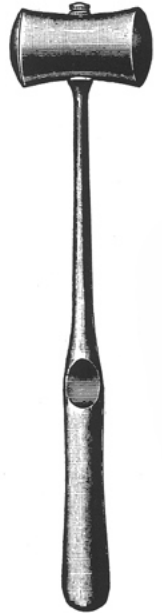
Kirk
8411.75



g
450 **8413.45**
900 **8413.90**
26,5 cm



Collin
8414.22
22,0 cm
220 g



Williger
8415.34
24,0 cm
340 g

8418.02
Paar Ersatzbacken
Pair of Spare Faces
Paire de faces de rechange
Pareja de tapas intercambiables
coppia di teste di ricambio



Lucae
8416.26
19,0 cm
260 g



Mead
8417.32
17,0 cm
320 g

8422.02
f. Kinder
child size
p. enfants
p. niños
p. bambini



8422.01
f. Erwachsene
adult size
p. adultes
p. adultos
p. adulti

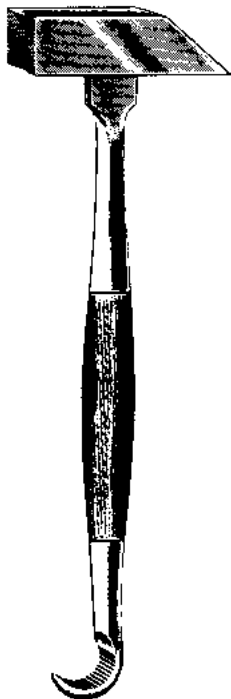
Bleihand

HÄMMER
 BONE HAMMERS AND MALLETS
 MARTILLOS Y MAZOS
 MARTELLI

Ø 22 mm



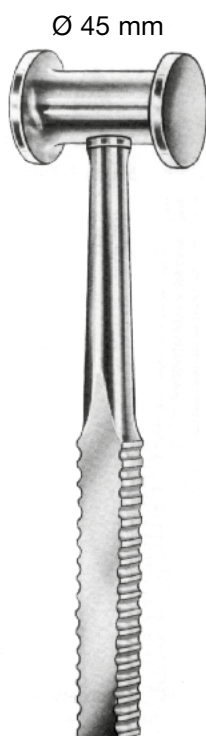
Partsch
 8418.18
 18 cm



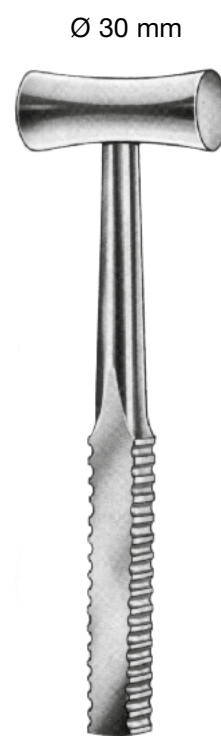
8421.23
 23,5 cm

MATTES

HÄMMER
BONE HAMMERS AND MALLETS
MARTILLOS Y MAZOS
MARTELLI



Bergmann
24 cm 300 g
8429.03



Bergmann
23 cm 300 g
8430.04

HÄMMER
 BONE HAMMERS AND MALLETS
 MARTILLOS Y MAZOS
 MARTELLI

Ø 30 mm



Cottle
 18 cm 240 g
 8431.05

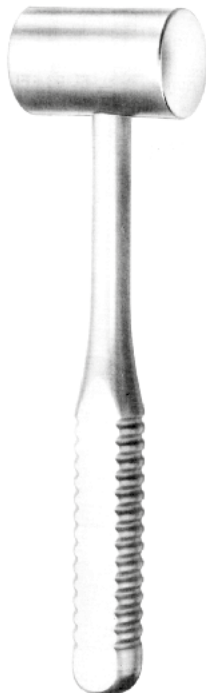
Ø 40 mm



mit Kupferfüllung
 copper filled head
 relleno de plomo
 rifieno in rame

Heath
 18 cm 700 g
 8432.06

Ø 40 mm



Ombredanne
 25 cm 550 g
 8433.07

Ø 27 mm

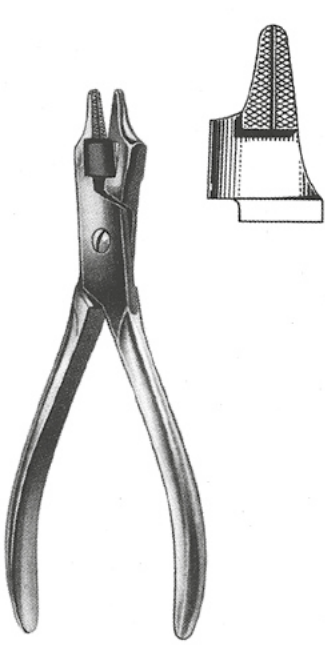


Hajek
 21 cm 140 g
 8434.08

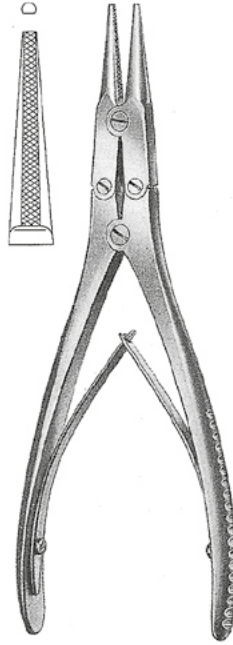
MATTES

FLACHZANGEN, DRAHTKNEIFZANGEN
 FLAT NOSE PLIERS, WIRE CUTTING PLIERS
 ALICATES PLANOS, ALICATES PARA CORTAR ALAMBRE
 TENAGLIE PIATTE, TENAGLIE TAGLIAFILFI

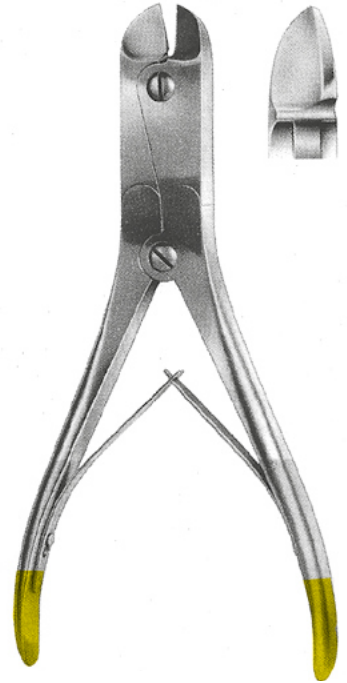
for soft wire 2,5 Ø
 for hard wire 2,2 Ø



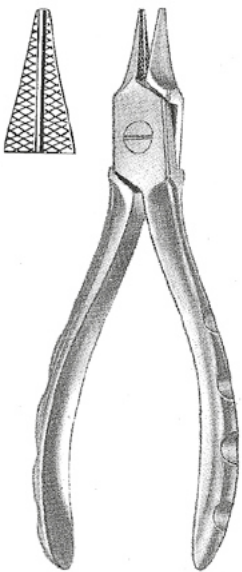
8429.15 15 cm



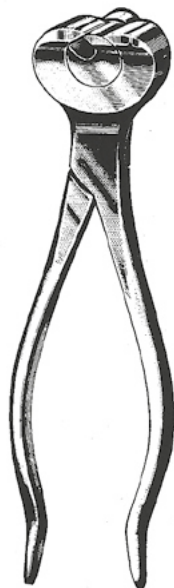
8430.18 18 cm



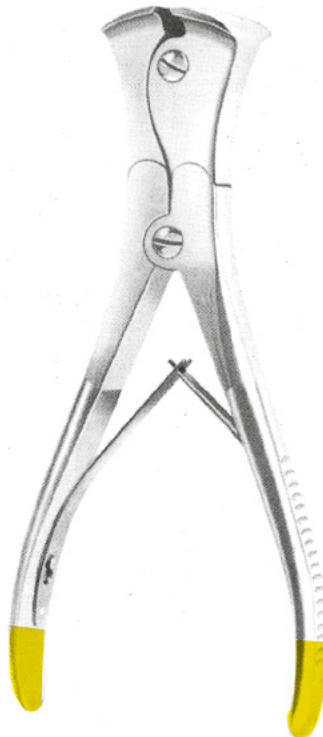
TC 8434.22 23 cm



8435.16 16 cm



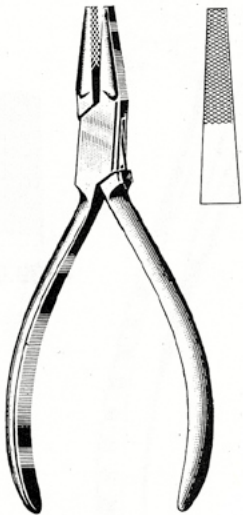
8438.16 16 cm
 Soft wire 2,0 mm
 hard wire 2,0 mm



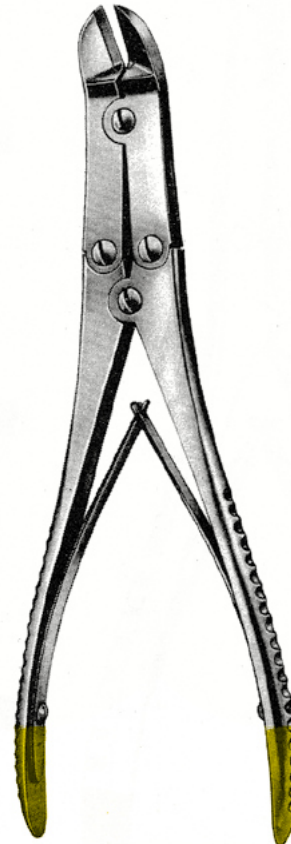
TC 8423.23 23 cm
 Soft wire 3,5 mm
 hard wire 1,5 mm

KNOCHENCHIRURGIE
 BONE SURGERY
 CHIRURGIE OSSEUSE
 CHIRURGÍA ÓSEA
 CHIRURGIA OSSEA

Drahtwickzangen



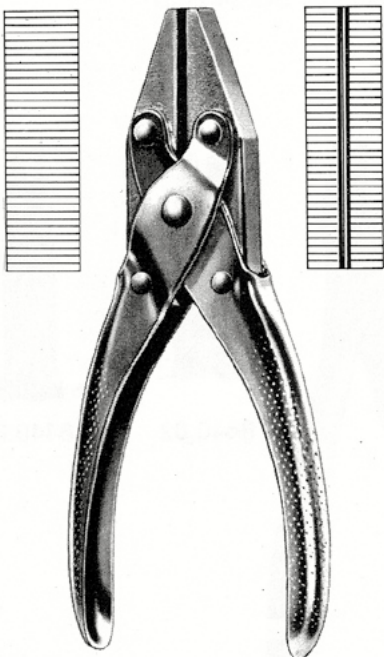
14,0 cm 8425.14



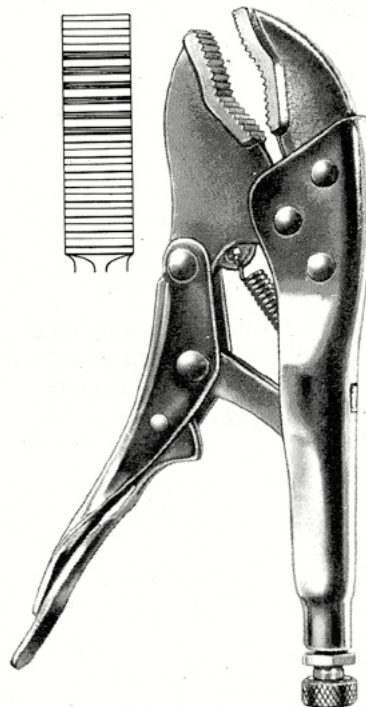
22,0 cm TC 8435.22



Bolzenschneider
 bis 6 mm Ø
 47,0 cm 8437.47



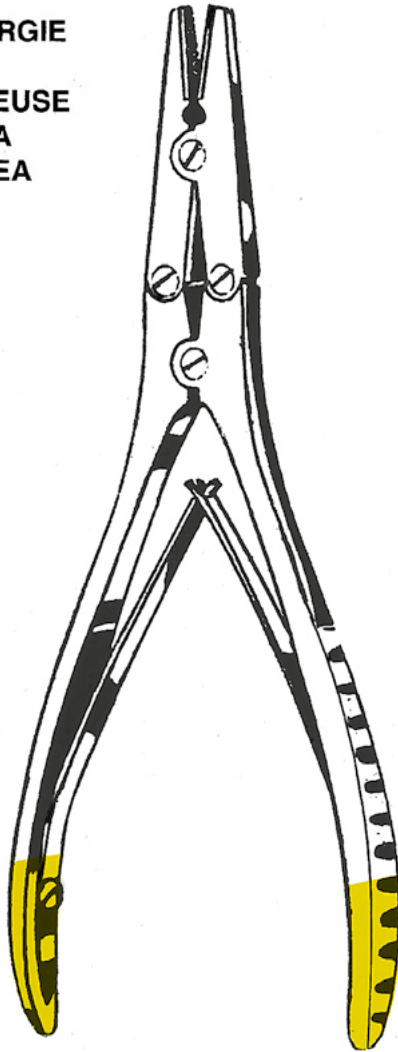
Parallelzange
 17,0 cm 8436.17



8345.18
 Grip Zange 18,0 cm

MATTES

KNOCHENCHIRURGIE
 BONE SURGERY
 CHIRURGIE OSSEUSE
 CHIRURGÍA ÓSEA
 CHIRURGIA OSSEA



18,0 cm
TC 8438.01 bis 8438.03



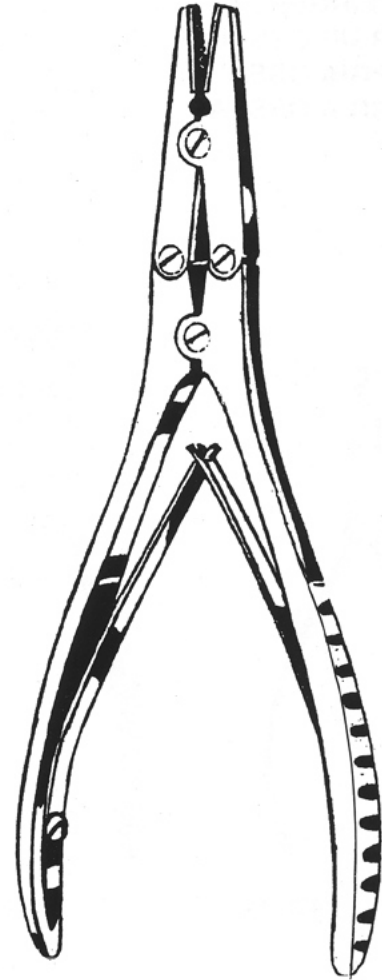
TC 8438.01



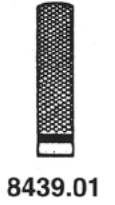
TC 8438.02



TC 8438.03



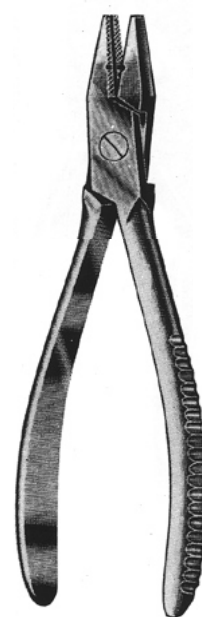
18,0 cm
8439.01 bis 8439.02



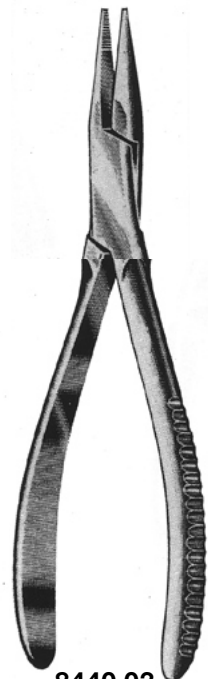
8439.01



8439.02



8440.02



8440.03

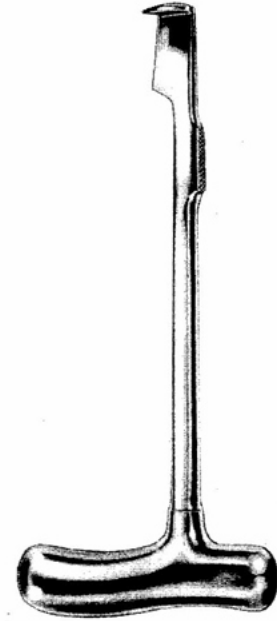
KNOCHENFEILEN UND RASPELN
BONE FILES
LIMES A OS
LIMAS PARA HUESOS ESCOFINAS
LIME PER OSSA



25,0 cm
 8442.25



8446.22
 22 cm



Sternummeißel Lebsche
 25,0 cm 8441.25



27,0 cm
 8443.27



30,0 cm
 8444.30



8447.28
 28 cm

MATTES

BOHRAPPARATE
BONE HAND DRILLS
PERFORADORES ÓSEOS MANUALES
PERFORATORI A MANO



8445.00
Griff allein
Handle only
Mango solo
Manico solo

Hudson
8445.27 27 cm
compl. incl.
8445.09, -14, -16, -22
8446.00



8445.09
9 mm



8445.14
14 mm



8445.16
16 mm



8445.22
22 mm



ø 2 mm
8445.20



Cushing
8446.14



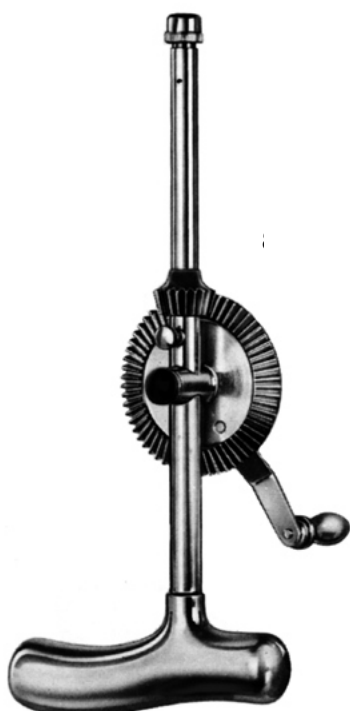
Errico
8446.17
ø 16 mm



Mc Kenzie
8446.13
ø 13 mm



8446.00
Verlängerungsstück
Extension piece
Pieza alargadera
Giunto di prolungamento

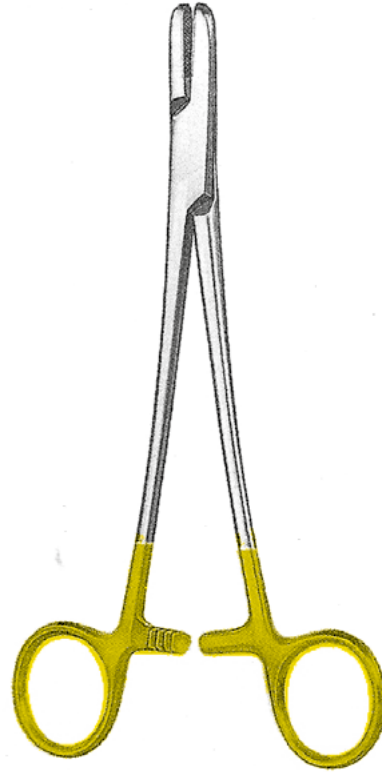


Stille-Sherman
8447.24 24 cm
compl. incl. 8447.25 - 8447.35



Moore
8448.28 28 cm
compl. incl. 8448.00

DRAHTZANGEN
WIRE TWISTING FORCEPS
PINZAS PARA TORCER HILOS
PINZA TORCIFILI



Berry

TC 8476.18 18,5 cm

MATTES

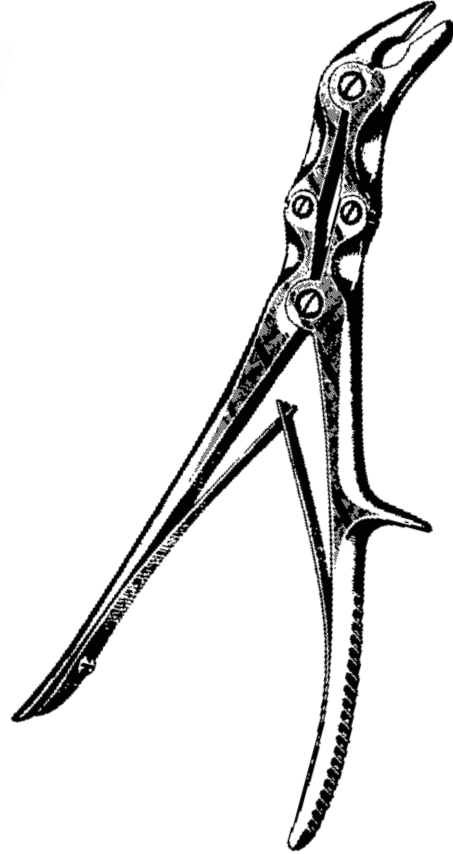
BOHRAPPARATE
BONE DRILLS
PERFORATEURS À OS
PERFORADORES PARA HUESOS
PERFORATORI PER OSSA



8482.00 Ralk

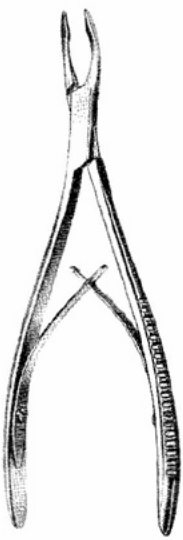
Hand Drill with light metal case and laterally angled handle, with three-jaw-chuck and key, opening up to 6,35 mm Ø

HOHLMEISSELZANGEN
BONE RONGEURS
PINCES GOUGES
PINZAS GUBIAS
PINZE SGORBIE



MATTES

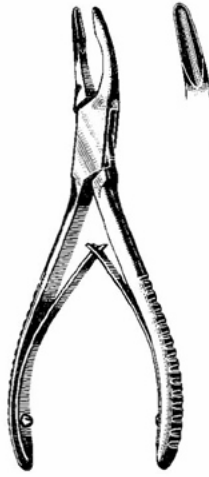
HOHLMEISSELZANGEN
BONE RONGEURS
PINCES GOUGES
PINZAS GUBIAS
PINZE SGORBIE



Friedman
8685.15
15,0 cm



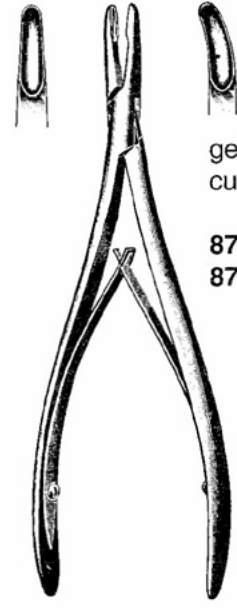
Friedman
8687.14
14,0 cm



Friedman Mini
8700.12
12,0 cm



Friedman
8705.14
14,0 cm



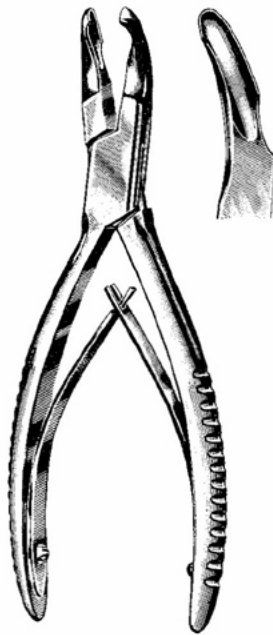
gebogen
curved

8715.16
8715.18

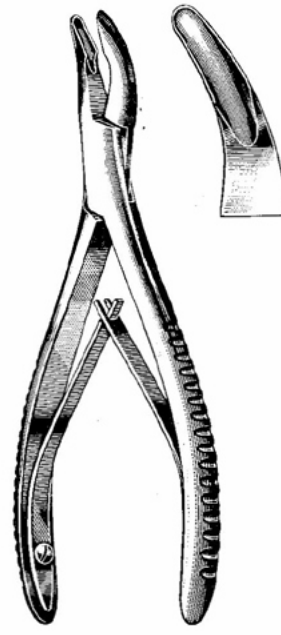
Lempert
8710.16 16,0 cm
8710.18 18,0 cm



Cleveland
8720.14
14,0 cm



Cleveland
8720.17
17,0 cm

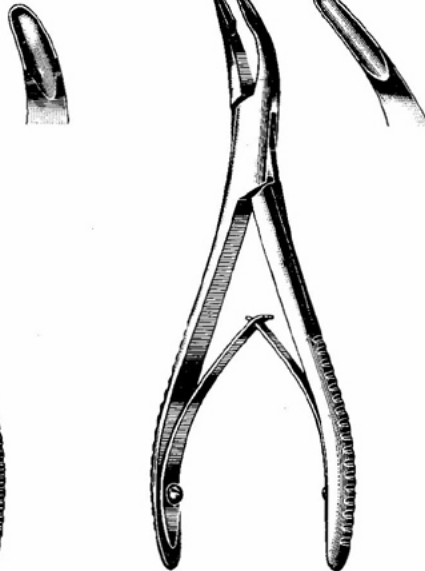


Mead
8725.16
16,0 cm

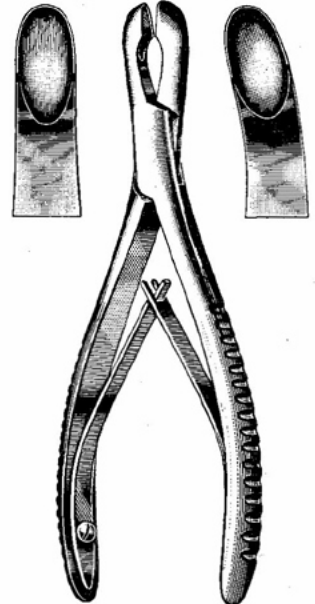
HOHLMEISSELZANGEN
 BONE RONGEURS
 PINCES GOUGES
 PINZAS GUBIAS
 PINZE SGORBIE



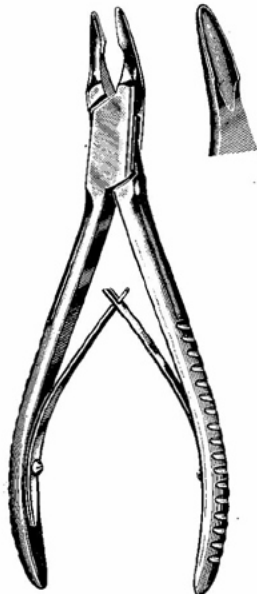
Luer
8730.15



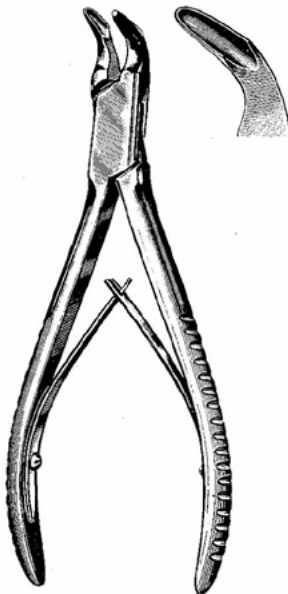
Luer
8735.15



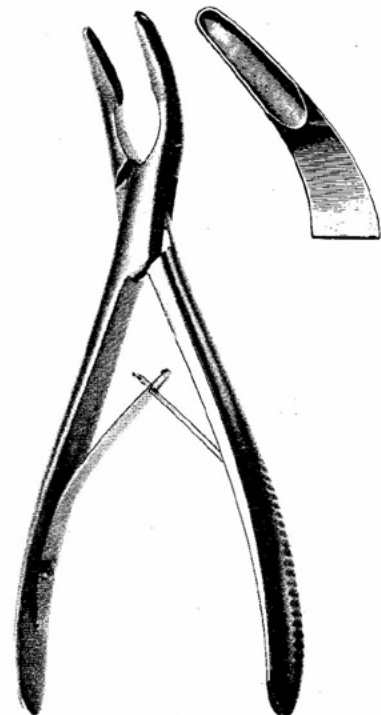
Luer
8740.17 8745.17



Blumenthal
8750.15



Blumenthal
8755.15



Olivecrona
8760.20

MATTES

HOHLMEISSELZANGEN
BONE RONGEURS
PINCES GOUGES
PINZAS GUBIAS
PINZE SGORBIE



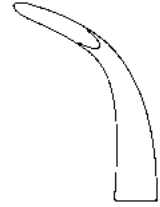
Bane-Hartmann
8761.18 17,5 cm



Stellbrink



8762.01
2 mm



8762.02
2 mm



Beyer
8763.18 18 cm

HOHLMEISSELZANGEN
 BONE RONGEURS
 PINCES GOUGES
 PINZAS GUBIAS
 PINZE SGORBIE



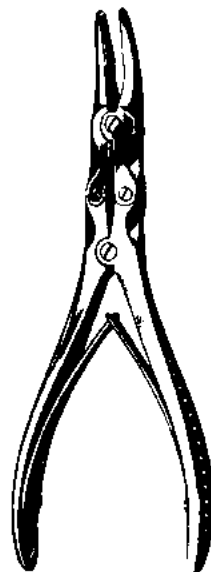
3 mm
 8765.03



3 mm
 8766.03



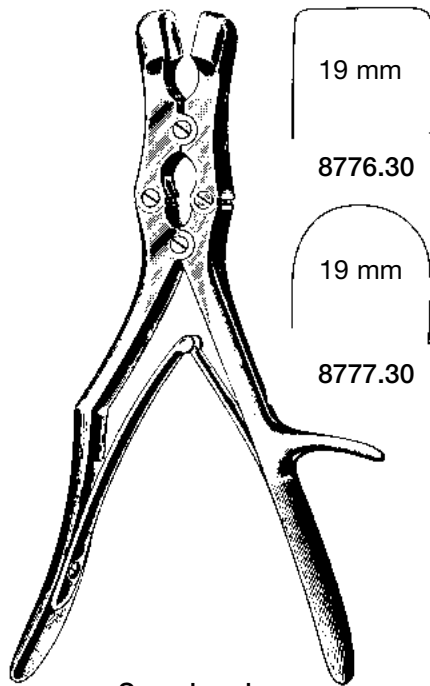
Smith-Petersen
 24 cm
 8765.03
 8766.03



— Böhler —
 straight 8768.15 15 cm 8769.15 curved

MATTES

HOHLMEISSELZANGEN
BONE RONGEURS
PINCES GOUGES
PINZAS GUBIAS
PINZE SGORBIE



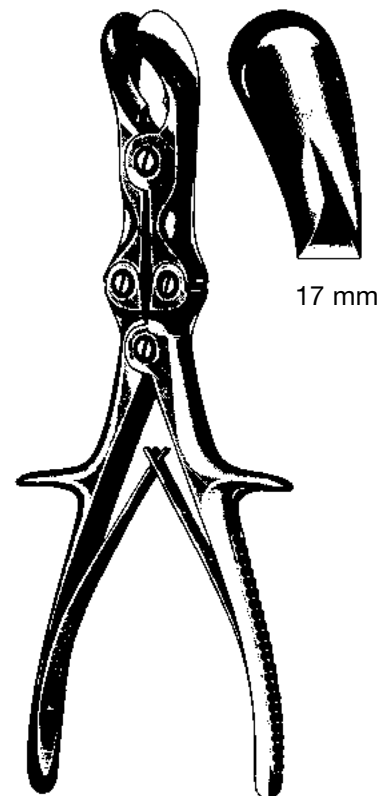
Sauerbruch
30 cm



Echlin
8787.23 23 cm

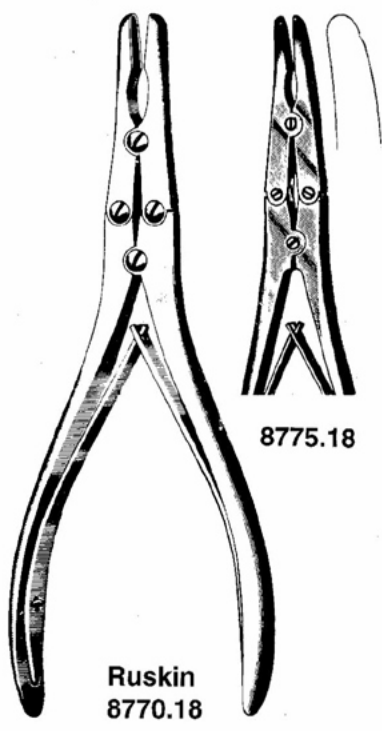


Frykholm
8788.24 24 cm



Semb
8789.22 22,5 cm

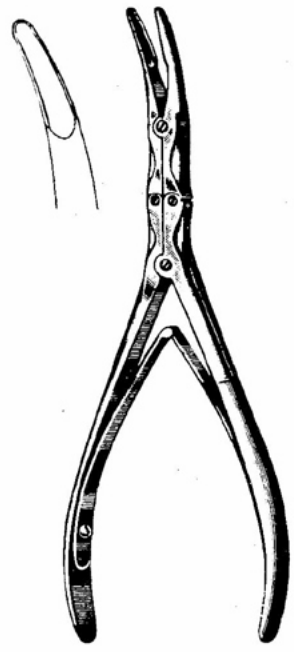
HOHLMEISSELZANGEN
 BONE RONGEURS
 PINCES GOUGES
 PINZAS GUBIAS
 PINZE SGORBIE



Ruskin
8770.18



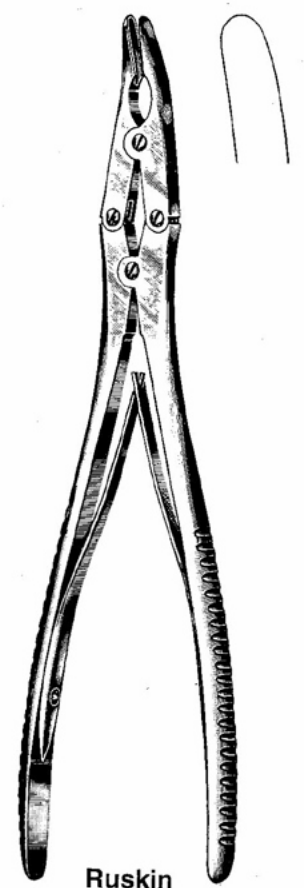
8775.18



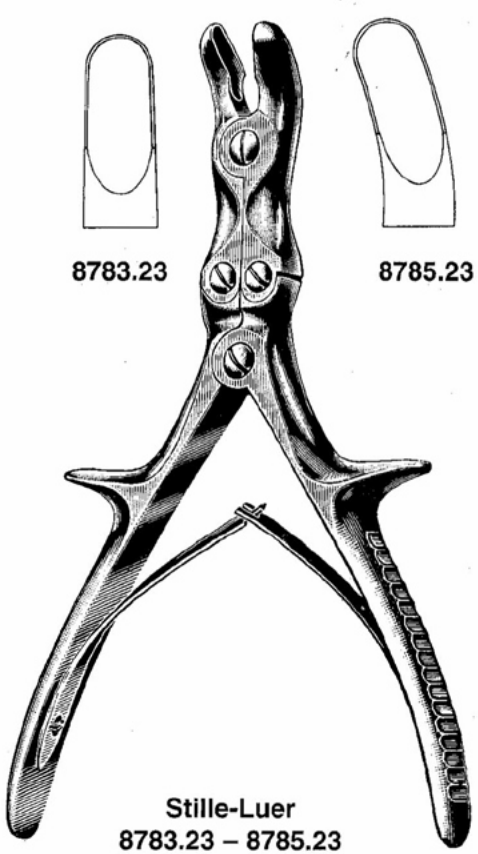
Beyer
8780.18



Zaufal-Jansen
8782.18



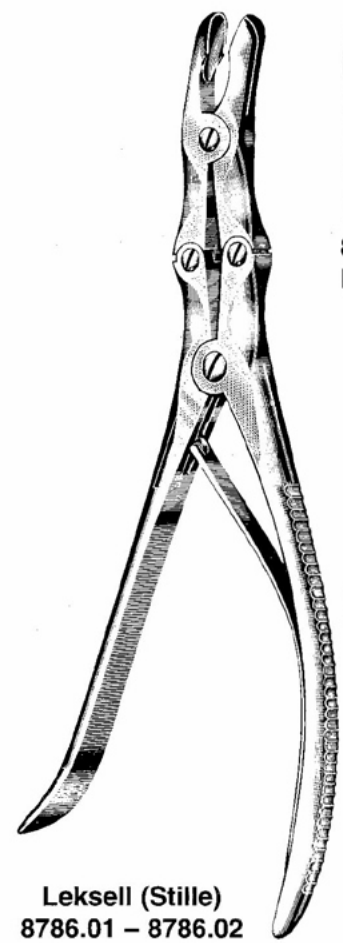
Ruskin
8793.23



8783.23

8785.23

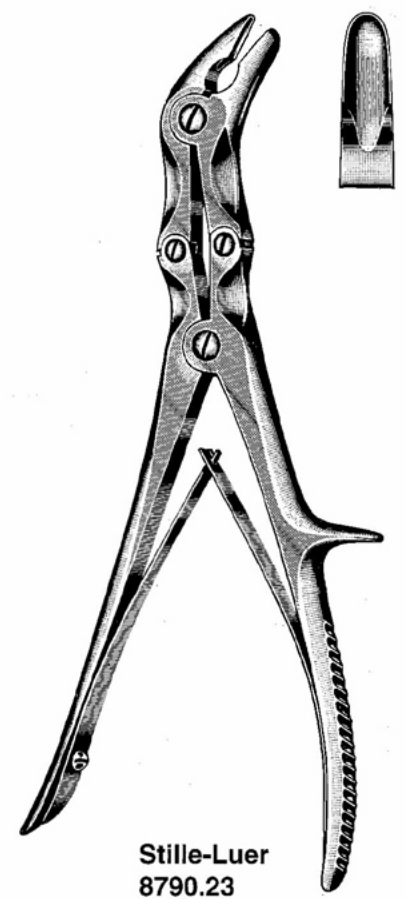
Stille-Luer
8783.23 - 8785.23



8786.01
Fig. 1

8786.02
Fig. 2

Leksell (Stille)
8786.01 - 8786.02



Stille-Luer
8790.23

KNOCHENSPLITTERZANGEN
BONE CUTTING FORCEPS
PINCES COUPANTES À OS
PINZAS CORTANTES PARA HUESOS
CESOIE PER OSSA



MATTES

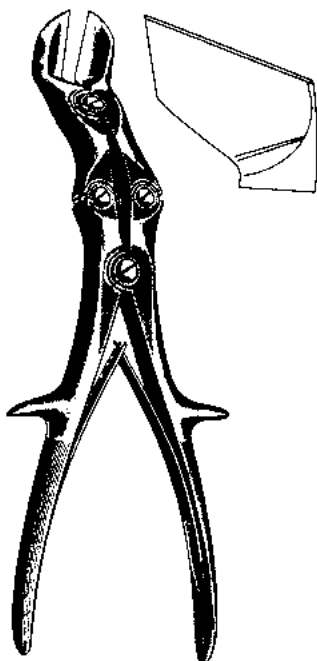
KNOCHENSPLITTERZANGEN
 BONE CUTTING FORCEPS
 PINZAS CONTANTES PARA HUESOS
 CESCOIE PER OSSA



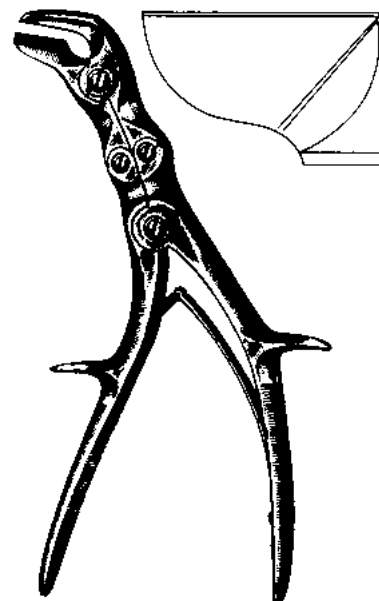
— Böhler —
 8795.15 15 cm 8797.15



Mc Indoe
 8796.17 17 cm

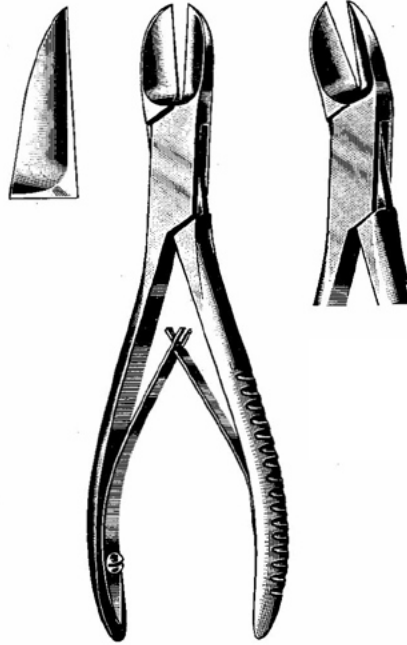


Stille-Horsley
 8798.27 27 cm



Semb
 8799.24 24 cm

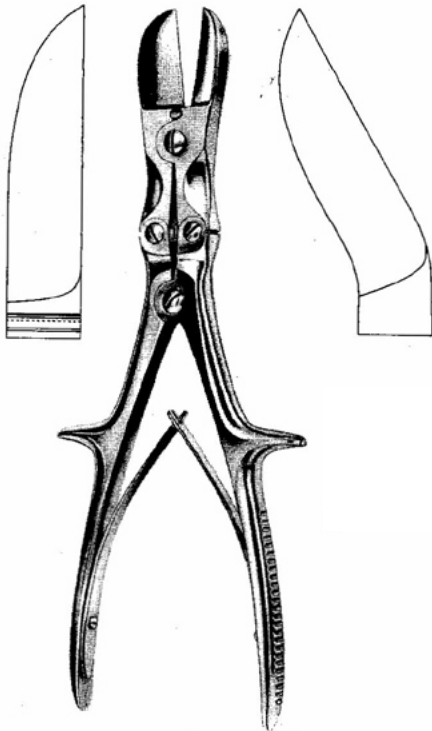
**KNOCHENSPLITTERZANGEN
BONE CUTTING FORCEPS
PINCES COUPANTES À OS
PINZAS CORTANTES PARA HUESOS
CESOIE PER OSSA**



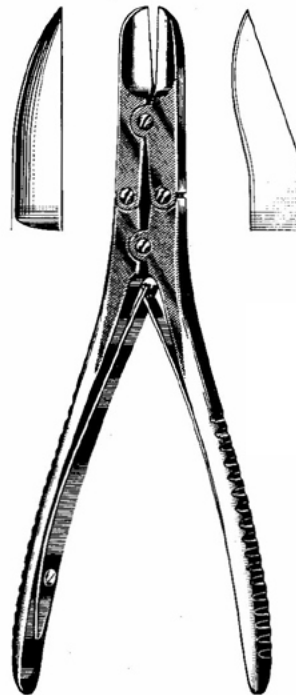
	Liston	
cm	8800.15	8801.15
14	8800.17	8801.17
17	8800.19	8801.19
19	8800.22	8801.22
22		



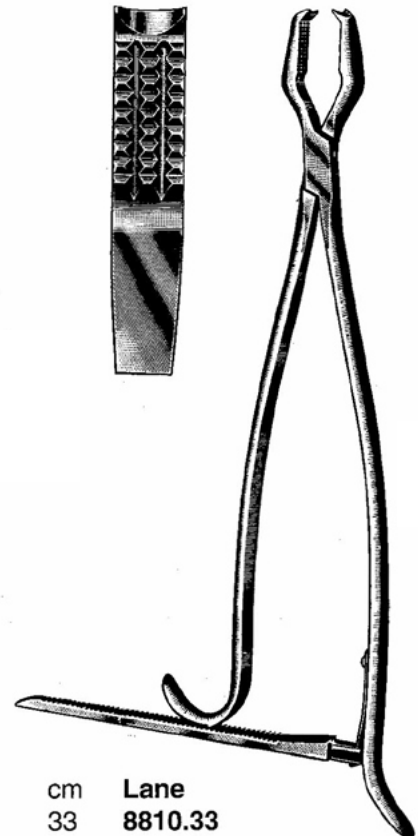
Cottle-Kazanjian
8803.19



Stille-Liston
8804.27 8805.27



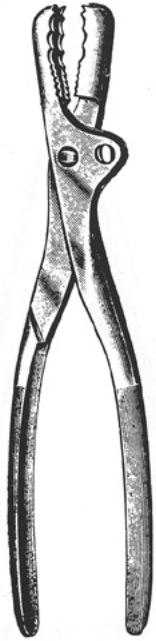
Ruskin-Liston
8806.18 8807.18



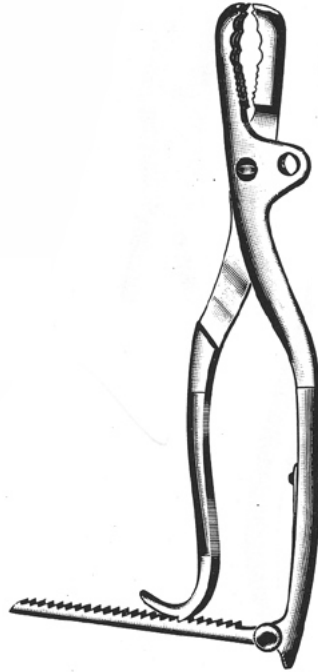
cm **Lane**
33 8810.33
45 8810.45

MATTES

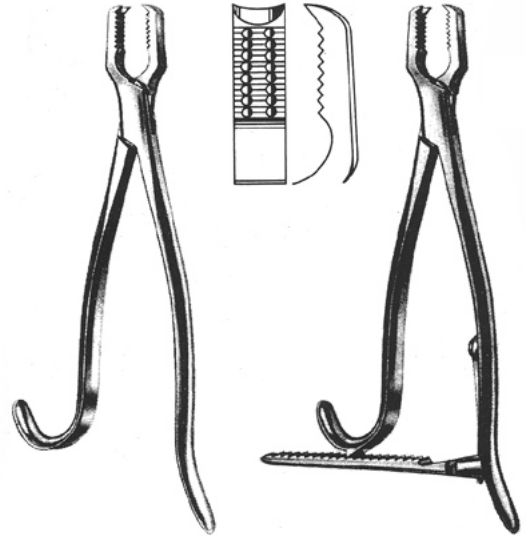
KNOCHENHALTEZANGEN
BONE HOLDING-FORCEPS
DAVIERS PORTE-OS
PINZAS PARA HUESOS
TENAGLIE PER OSSA



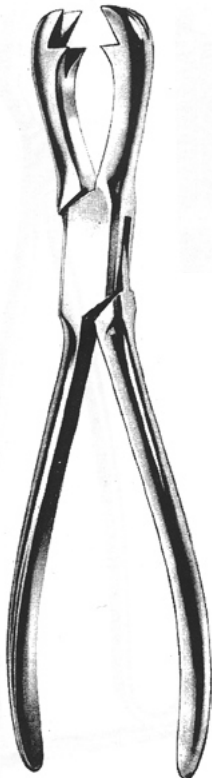
cm **Farabeuf**
23 **8811.23**
26 **8811.26**



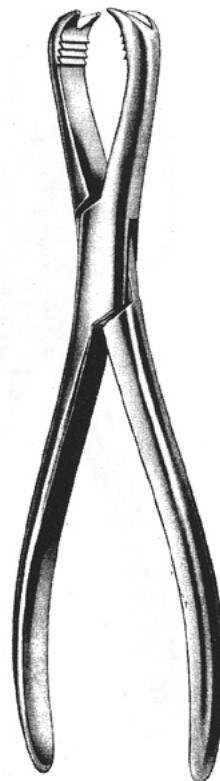
Farabeuf-Lambotte
8812.26



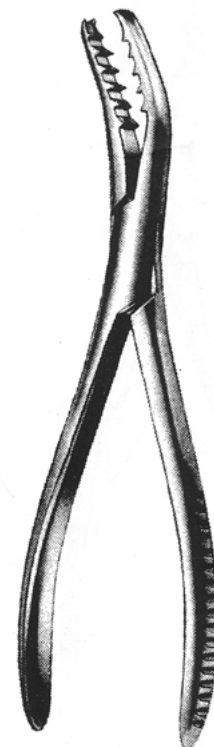
cm	Kern	
15	8815.15	8816.15
17	8815.17	8816.17
21	8815.21	8816.21



Fergusson
8818.21

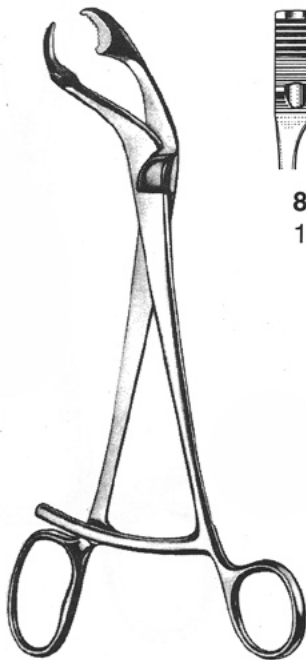


Langenbeck
8819.21



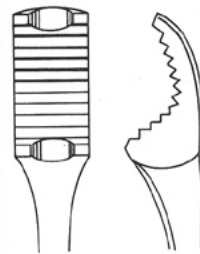
Semb
8820.19

KNOCHENHALTE-, SEQUESTERZANGEN
BONE HOLDING, SEQUESTER FORCEPS
PINCES À OS, SÉQUESTRES
PINZAS PARA HUESOS Y SECUESTROS
PINZE PER OSSA E SEQUESTRI

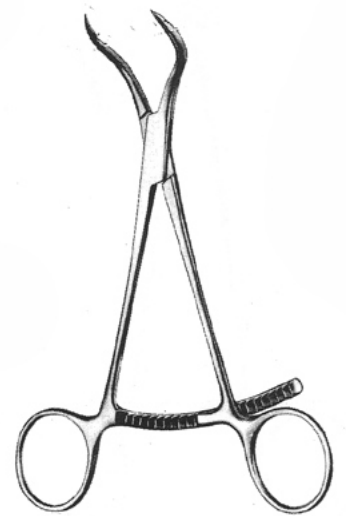


8825.17
17,5 cm

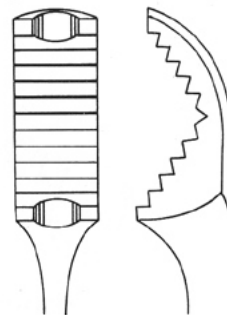
Verbrugge



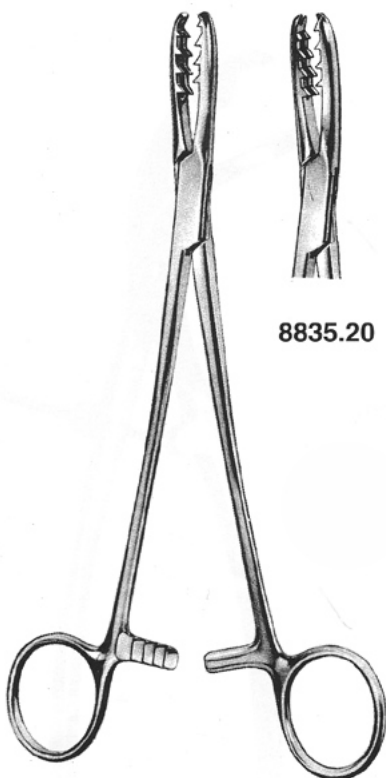
8825.25
25,0 cm



8828.13

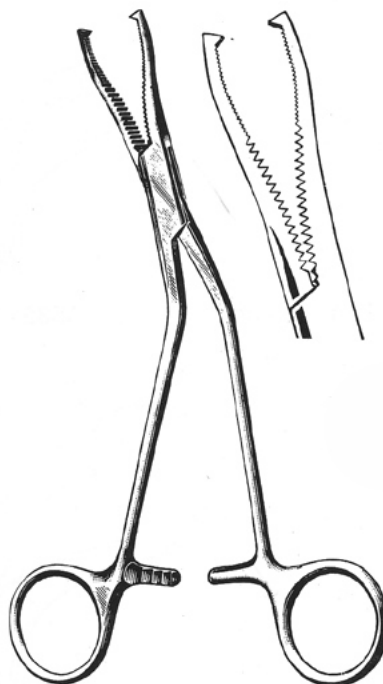


8825.27
27,0 cm

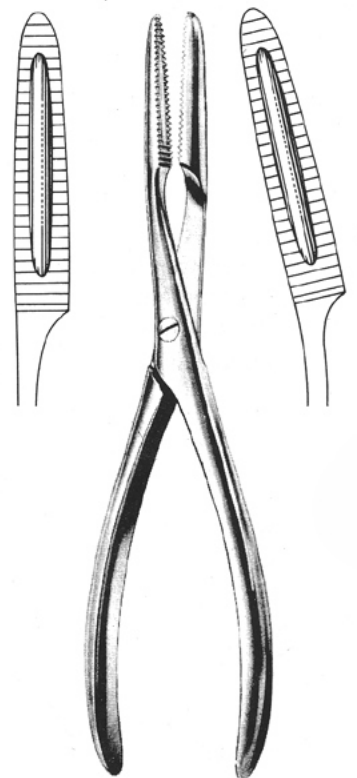


8835.20

Bircher-Ganske
8830.20



Dingmann
8838.19

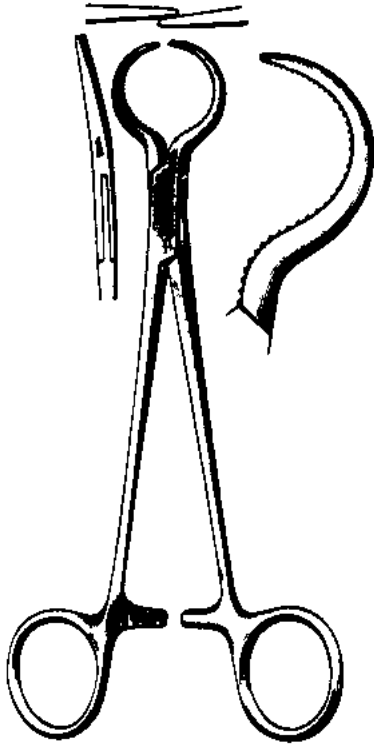


8840.20

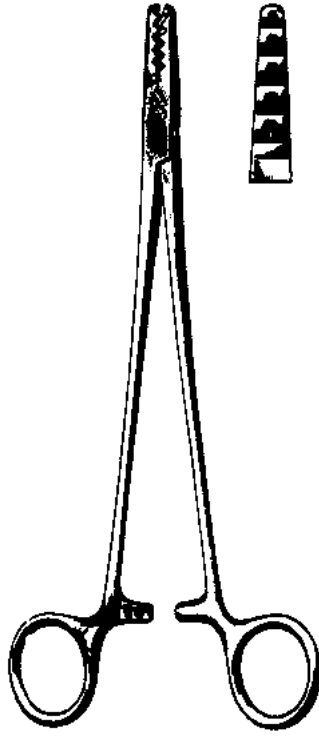
8845.20

MATTES

KNOCHENHALTEZANGEN
 BONE HOLDING FORCEPS
 PINZAS PARA HUESOS
 TENAGLIE PER OSSA



Lewin
 8821.17 17,5 cm



Martin
 8823.19 19 cm

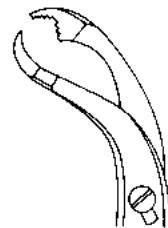


8822.20 20 cm

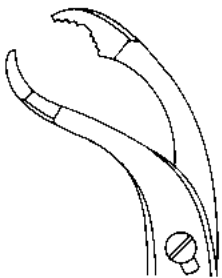
selbstzentrierend
 self-centering
 autocentrantes
 autocentranti



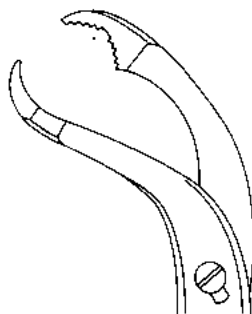
9580 15 cm



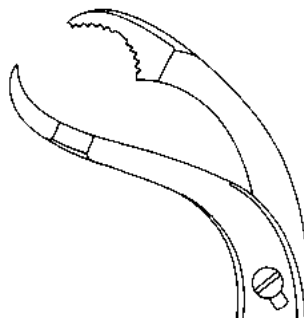
9582 19 cm



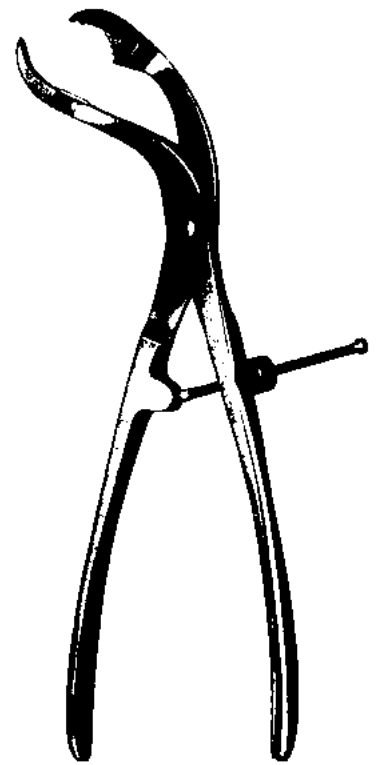
9584 24 cm



9586 26 cm



9588 28 cm

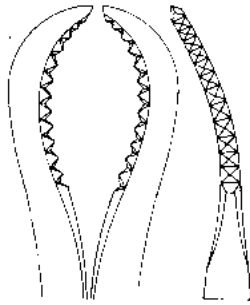


9580 - 9588

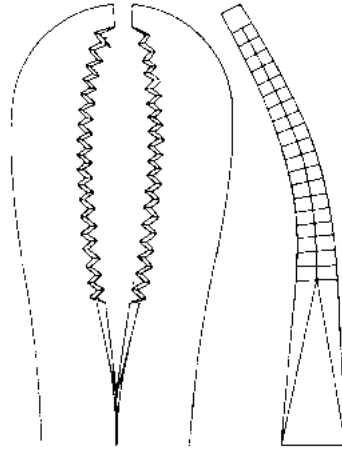
KNOCHENHALTEZANGEN
 BONE HOLDING FORCEPS
 PINZAS PARA HUESOS
 TENAGLIE PER OSSA



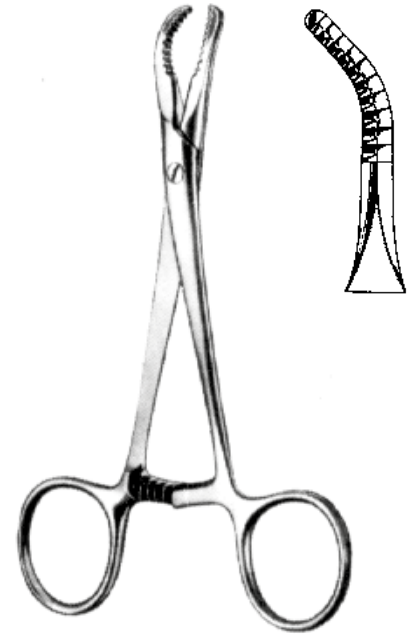
9562 - 9560



9562
 16 cm



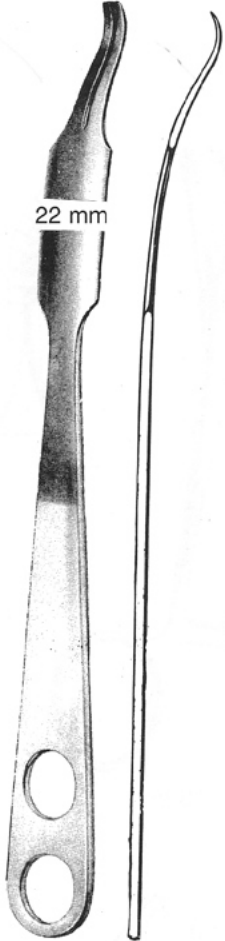
9560
 24 cm



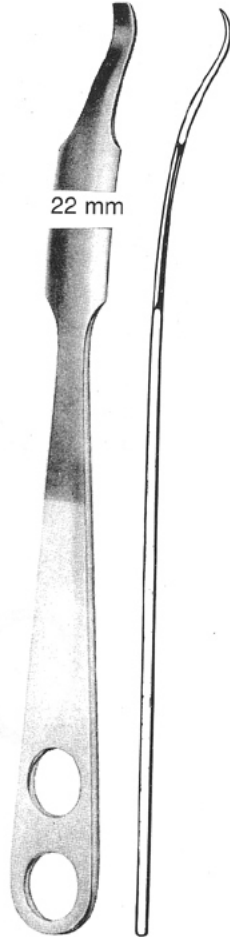
9600 16 cm

MATTES

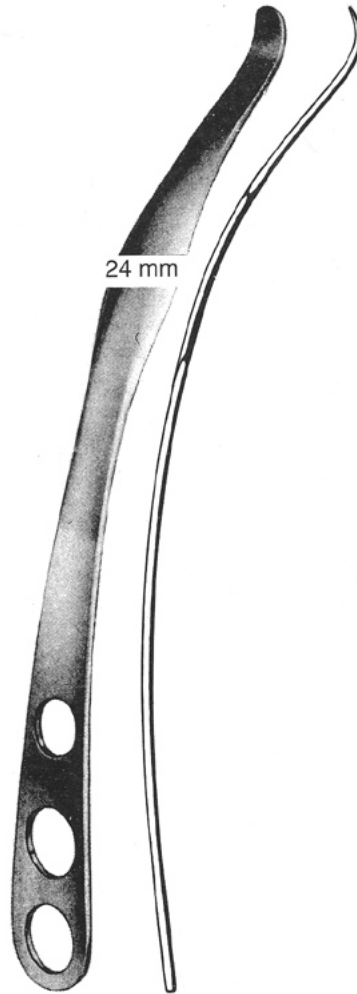
KNOCHENHEBEL
BONE LEVERS
LEVIERS À OS
ELEVADORES PARA HUESOS
ELEVATORI PER OSSA



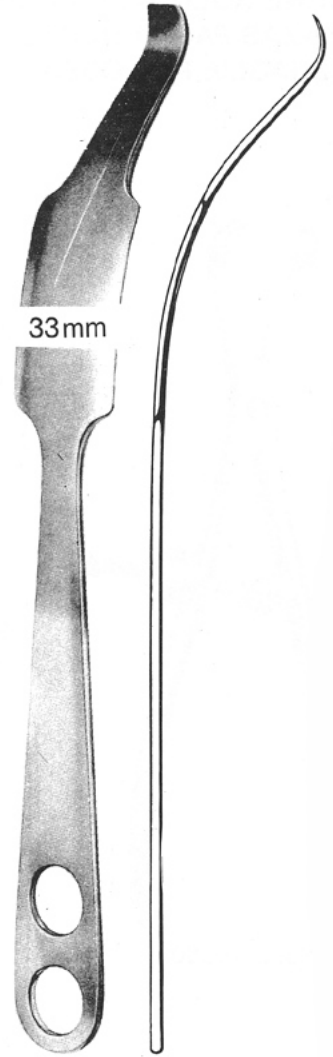
Hohmann
8850.22



Hohmann
8851.22



Hohmann
8852.24



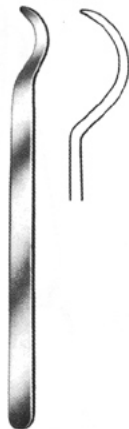
Hohmann
8853.33

2,8 mm



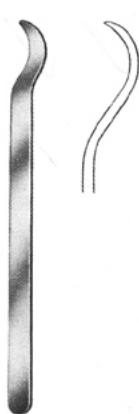
8854.28
14 cm

5 mm



8854.50
15 cm

6 mm



8854.70
15 cm



Hohmann mini
16,0 cm



8855.06
6 mm



8855.08
8 mm

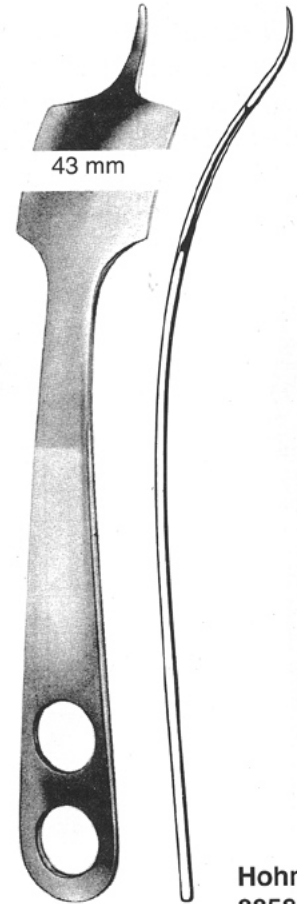
KNOCHENHEBEL
 BONE LEVERS
 LEVIERS À OS
 ELEVADORES PARA HUESOS
 ELEVATORI PER OSSA



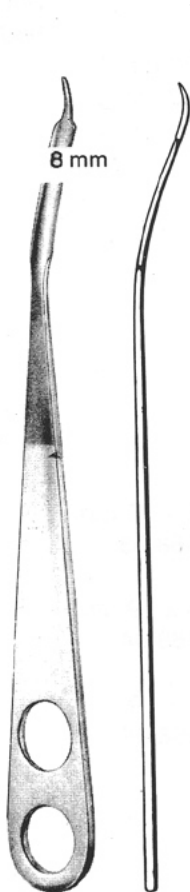
Bennett
8856.00



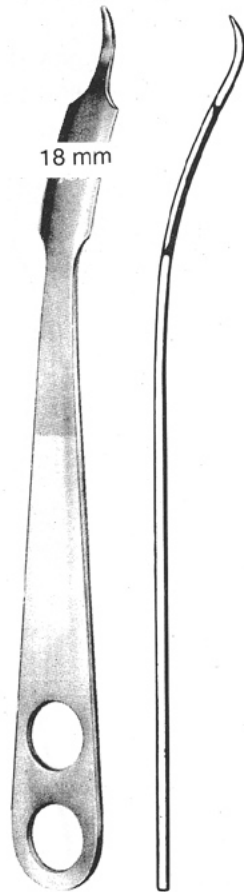
Bennett
8857.00



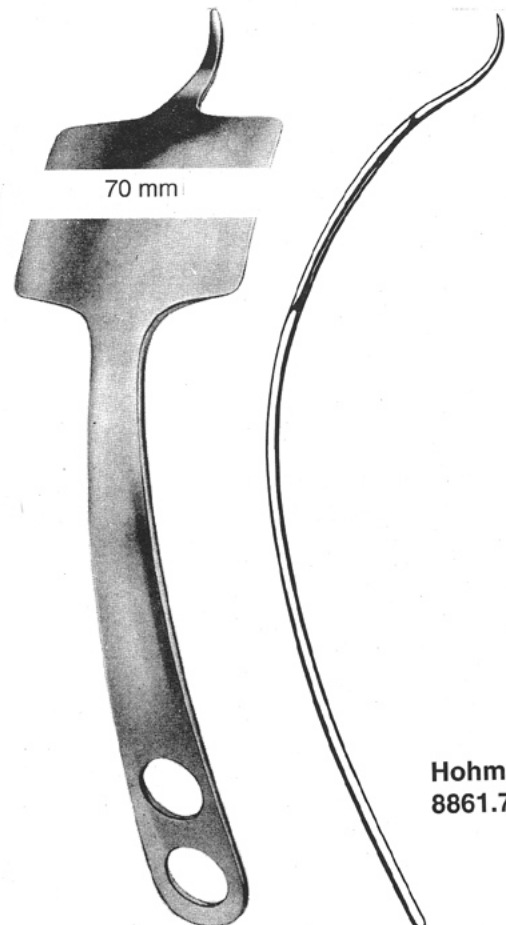
Hohmann
8858.43



Hohmann
8859.08



Hohmann
8860.18



Hohman
8861.70

MATTES

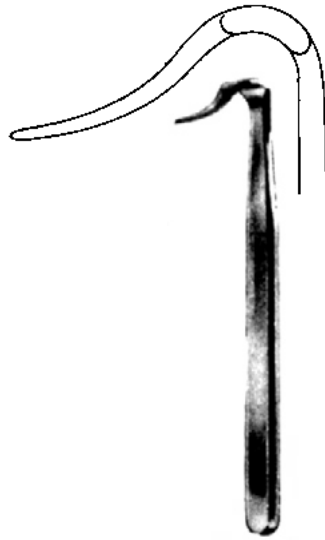
KNOCHENHEBEL, MENISKUSHAKEN
 BONE LEVERS, MENISCUS RETRACTORS
 ELEVADORES P. HUESOS, SEPARADORES PARA MENISCO
 ELEVATORI PER OSSA, DIVARICATORI PER IL MENISCO



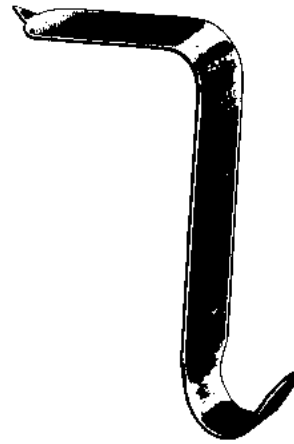
Blount
8862.26
26 cm



Blount
8863.26
26 cm



Blount
8864.18
17,5 cm



Taylor
16,5 cm
8865.16 75x30 mm
8866.16 100x30 mm



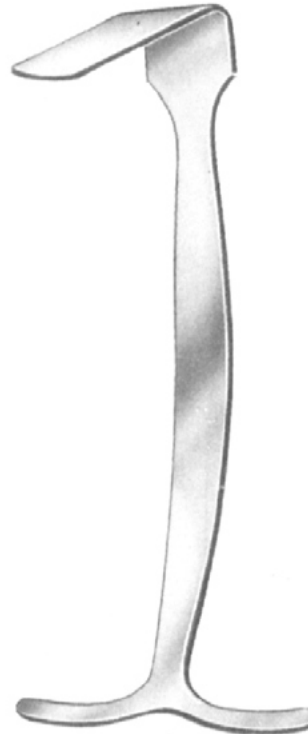
Murphy-Lane
8867.30
30 cm



12 x 13 mm
8868.01



52 x 13 mm
8868.02



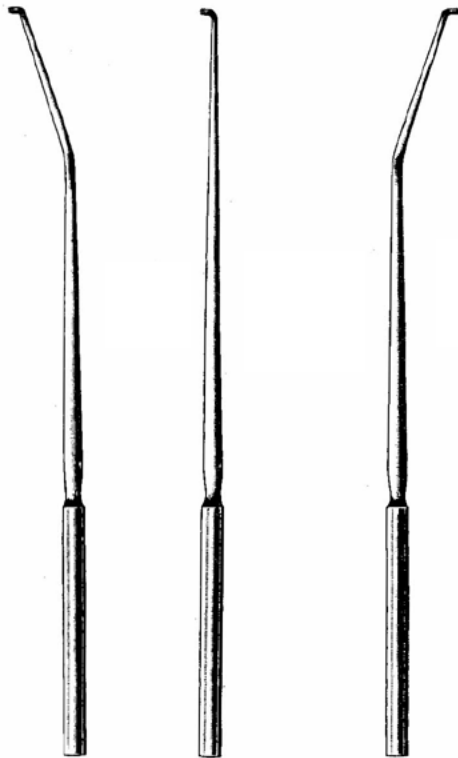
32 x 19 mm
8868.03

48 x 19 mm
8868.04

57 x 19 mm
8868.05

Smillie 14 cm

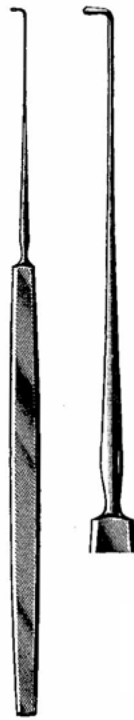
**NERVHAKEN
NERVE RETRACTORS
ECARTEURS À NERFS
SEPARADORES PARA NERVIOS
DIVARICATORI PER NERVI**



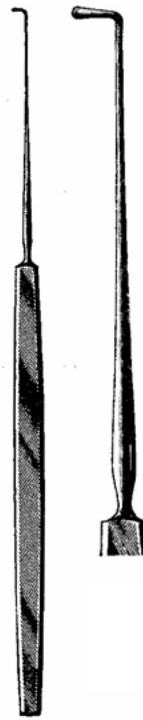
Dandy
8870.20

Dandy
8871.20

Dandy 20,0 cm
8872.20



Cushing
28,0 cm
8875.28



Cushing
28,0 cm
8876.28



Graham
16,0 cm
8877.16



Sachs
18,5 cm
8878.18



Adson 20,0 cm
8880.20



Adson 20,0 cm
8881.20



Smithwick 29,0 cm
8882.29



Love 19,0 cm
8885.19 – 8887.19



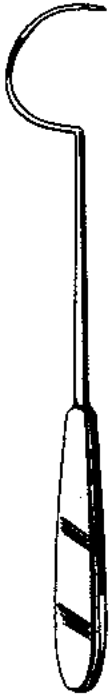
8885.19

8886.19

8887.19

MATTES

DRAHTUMFÜHRUNGSNADELN, DRAHTSPANNINSTRUMENTE
 BONE WIRE GUIDES, BONE WIRE TIGHTENERS
 AGUJAS PASA-HILOS, TENSOR CIERRA-HILOS
 AGHI PASSAFILI, STRUMENTI TENDIFILI



Demel
27 cm

- Fig. 1 8888.01
- Fig. 2 8888.02
- Fig. 3 8888.03

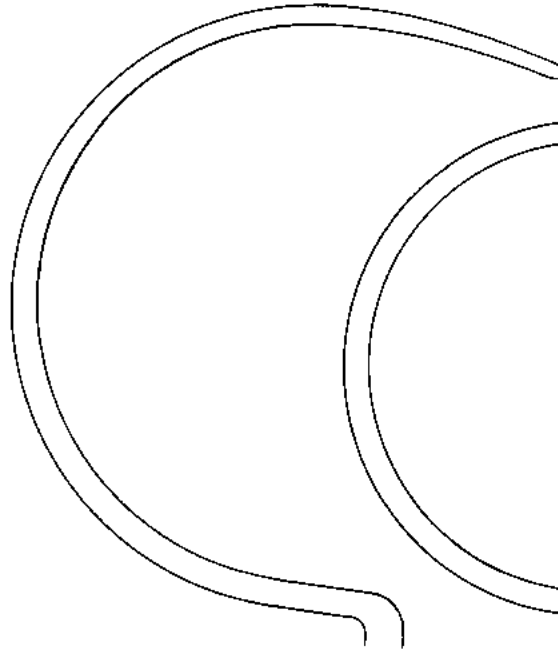


Fig. 1

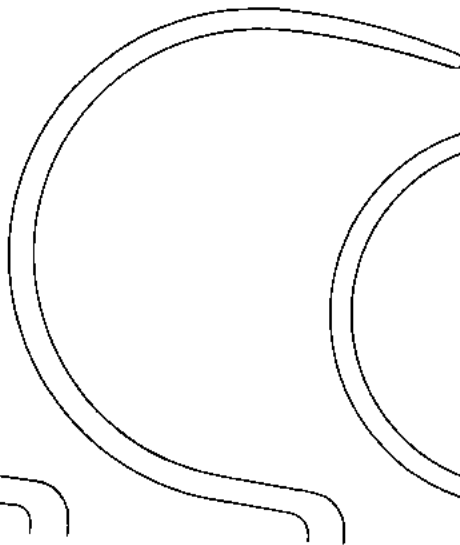


Fig. 2

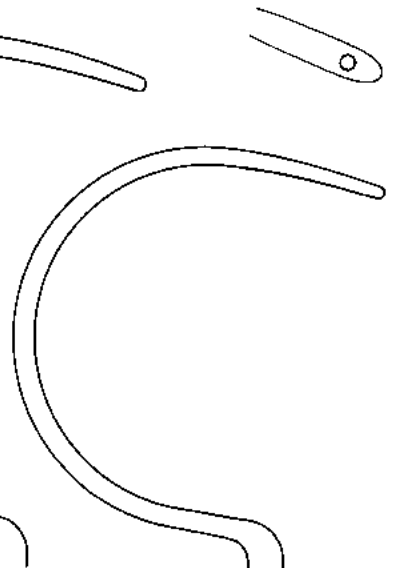
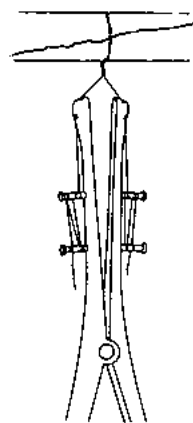
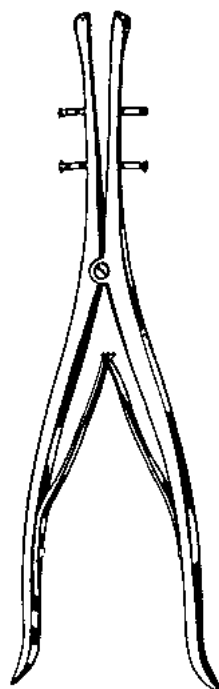
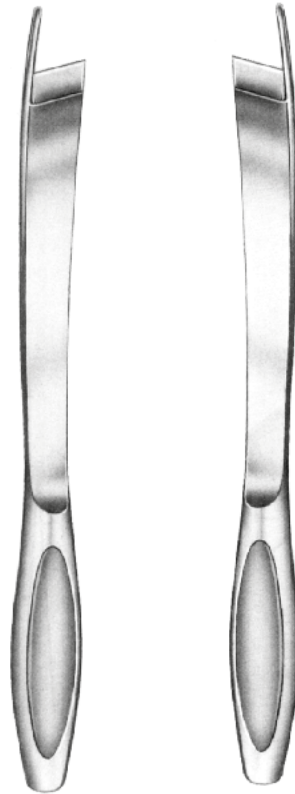


Fig. 3



Demel
8889.28 28 cm

MEISSEL, SEKTIONSNADELN
CHISELS, POST MORTEM NEEDLES
CINCELES, AGUJAS PARA AUTOPSIA
SCALPELLI, AGHI PER AUTOPSIA



Brunetti
28,5 cm

8890.11	8890.12
links	rechts
left	right
izquierdo	derecho
sinistra	destra

TROKARE
TROCARS
TRÓCARES
TREQUARTI

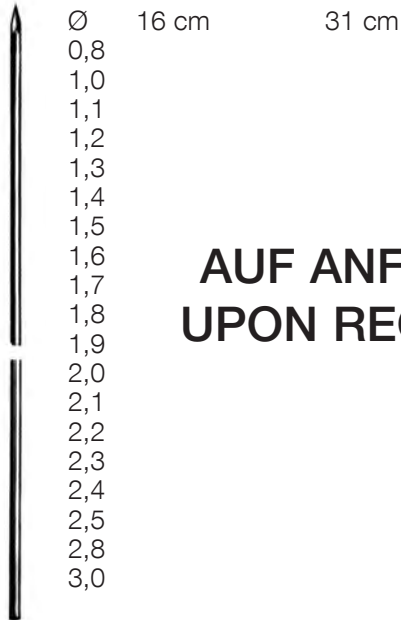


MATTES

BOHRDRÄHTE
DRILL WIRES
ALAMBRES
PERFORATORI FILIFORMI

lieferbar in Packungen à 10 Stück
 available in packages of 10 pieces
 disponible en paquetes de 10 unidades
 disponibili in confezioni da 10 pezzi

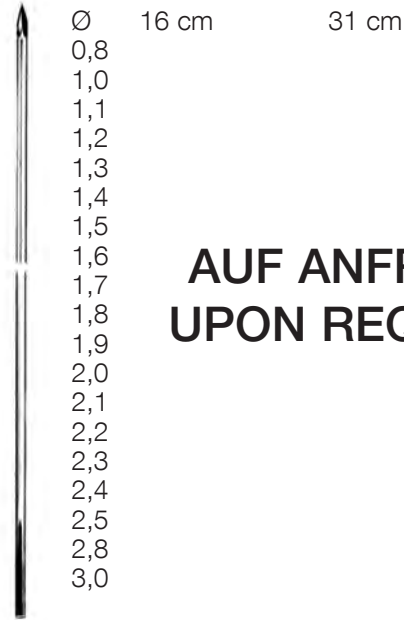
Trokarspitze / Trocar point
 Punta trocar / Punta trequarti



AUF ANFRAGE
UPON REQUEST

Kirschner
 mit rundem Ende / with round shaft
 con extremo redondo / con punta rotonda

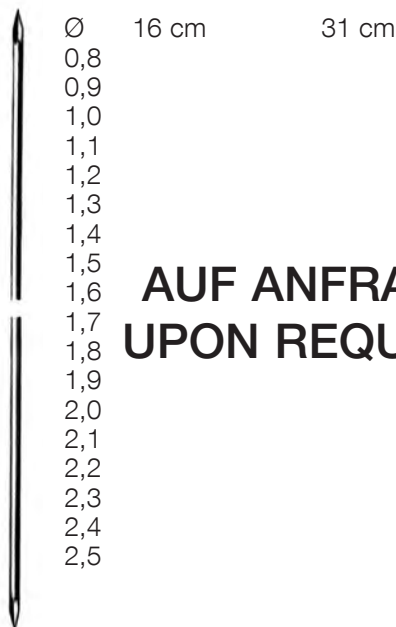
Trokarspitze / Trocar point
 Punta trocar / Punta trequarti



AUF ANFRAGE
UPON REQUEST

Kirschner
 mit flachem Ende / with flat shaft
 con extremo plano / con punta piano

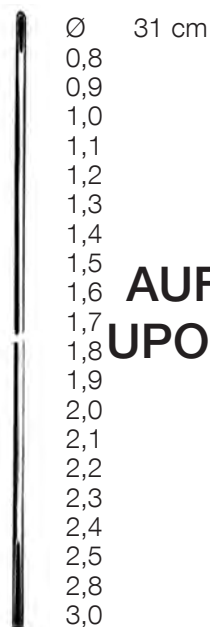
Trokarspitze / Trocar point
 Punta trocar / Punta trequarti



AUF ANFRAGE
UPON REQUEST

Kirschner
 Trokarende / Trocar shaft
 Punta trocar / Punta trequarti Bilaterali

Lanzenspitze / Lance point
 Punta lanceolar / Punta lanceolata



AUF ANFRAGE
UPON REQUEST

Kirschner
 mit flachem Ende / with flat shaft
 con extremo plano / con extremo piatto

Lanzenspitze / Lance point
 Punta lanceolar / Punta lanceolata



AUF ANFRAGE
UPON REQUEST

Kirschner
 mit rundem Ende / with round shaft
 con extremo redondo / con estremità rotonda

BOHRDRÄHTE, KNOCHENNÄGEL
DRILL WIRES, FRACTURE PINS
ALAMBRES, CLAVOS PARA HUESOS
PERFORATORI FILIFORMI, CHIODI PER OSSA

lieferbar in Packungen à 10 Stück
 available in packages of 10 pieces
 disponible en paquetes de 10 unidades
 disponibili in confezioni da 10 pezzi

Trokarspitze / Trocar point
 Punta trocar / Punte trequarti



Steinmann

mit rundem Ende / with round shaft
 con extremo redondo / con estremità rotonda

Trokarspitze / Trocar point
 Punta trocar / Punte trequarti



Steinmann

Trokarende / Trocar shaft
 Punta trocar / Punte trequarti Bilaterali

MATTES

KNOCHENNÄGEL
FRACTURE PINS
CLAVOS PARA HUESOS
CHIODI PER OSSA

lieferbar in Packungen à 10 Stück
 available in packages of 10 pieces
 disponible en paquetes de 10 unidades
 disponibili in confezioni da 10 pezzi

Trokarspitze / Trocar point
 Punta trocar / Punte trequarti



	Ø	Ø	Ø	Ø	Ø	Ø	Ø	Ø
	3,5 mm	4,0 mm	4,2 mm	4,5 mm	4,8 mm	5,0 mm	5,5 mm	6,0 mm
8 cm								
10 cm								
12 cm								
14 cm								
16 cm								
18 cm								
20 cm								
22 cm								
24 cm								
26 cm								
28 cm								
30 cm								

AUF ANFRAGE
UPON REQUEST

Steinmann

mit 3-kant-Ende / with triangular end
 con extremo triangular / con estremità triangolari

Trokarspitze / Trocar point
 Punta trocar / Punte trequarti

mit Gewinde
 threaded Wires
 con rosca
 con filetto



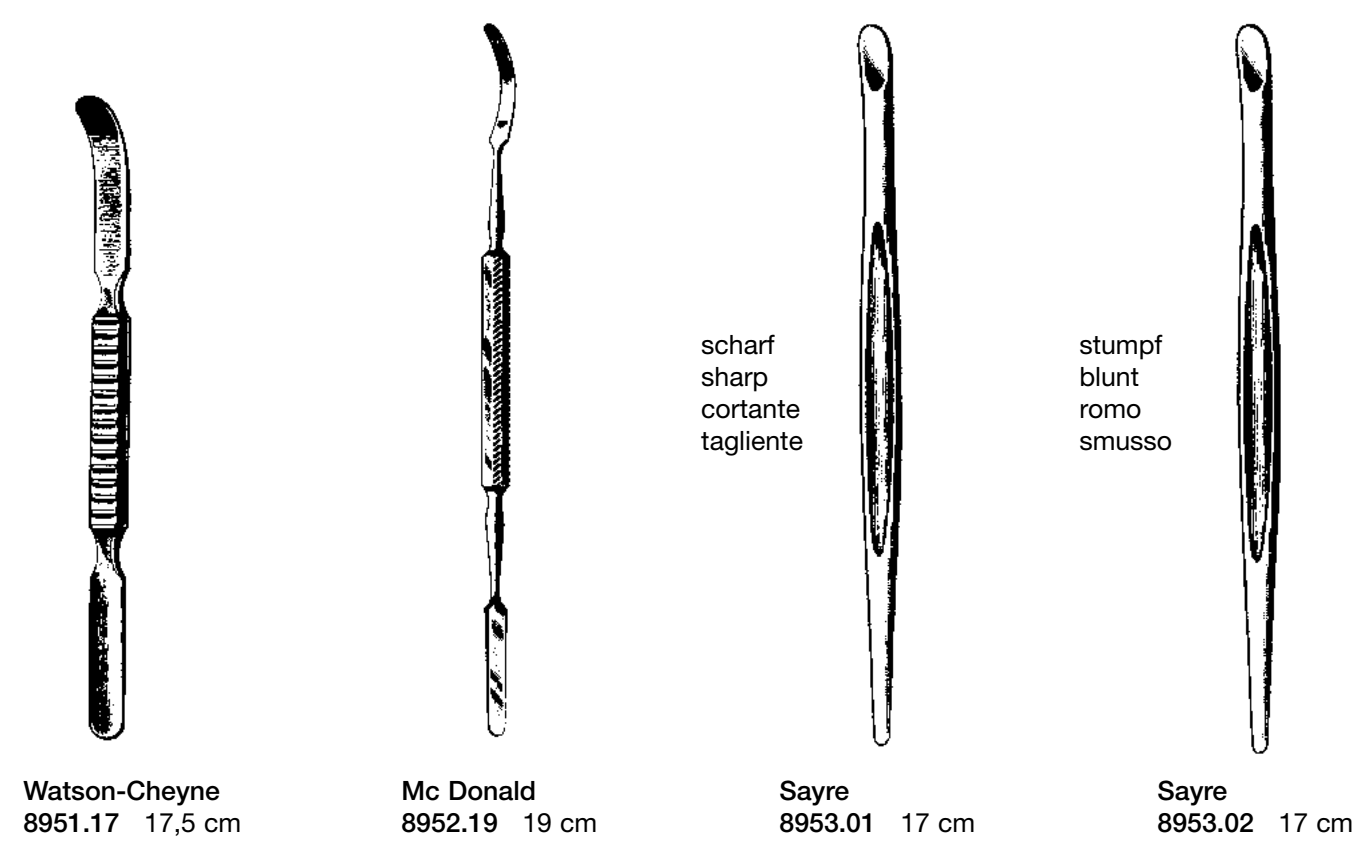
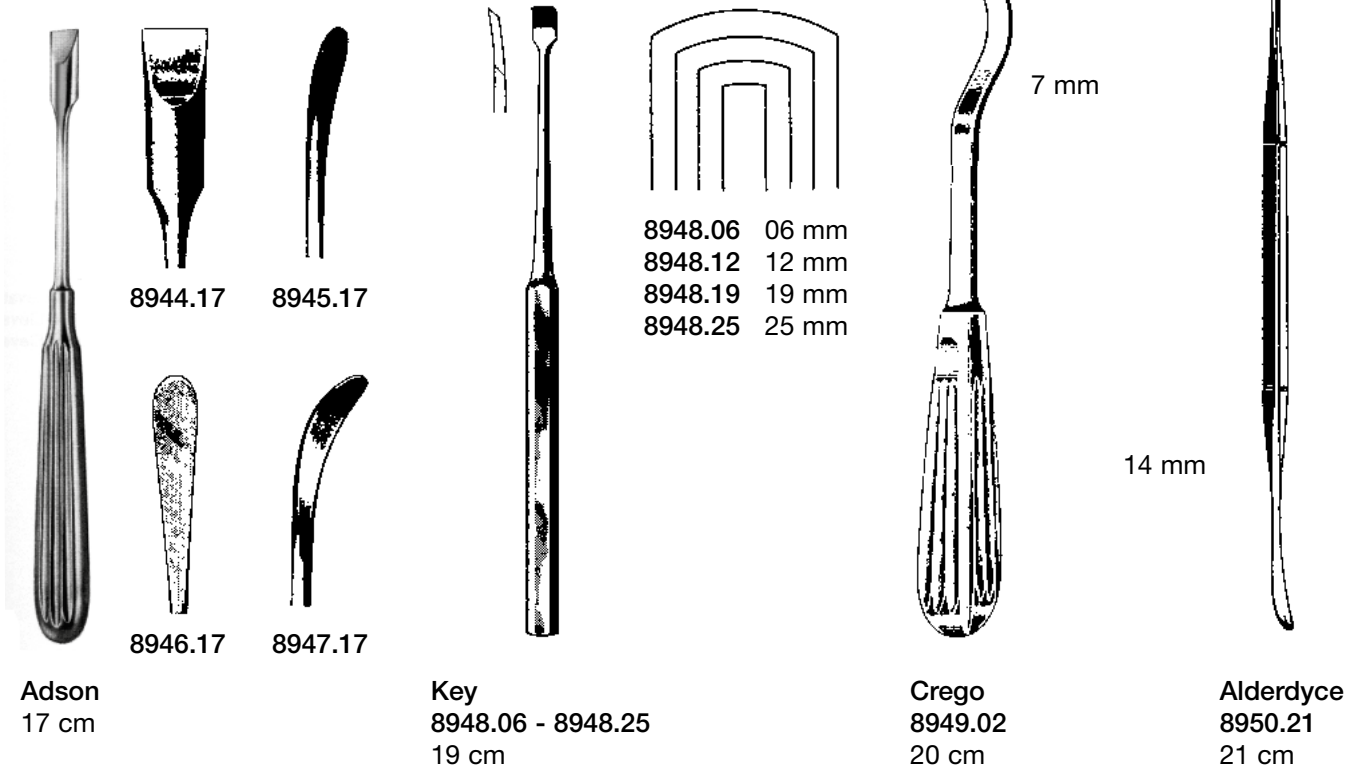
25 mm

	Ø	15 cm	18 cm	20 cm	23 cm	25 cm	31 cm
	1,2						
	1,4						
	1,6						
	1,8						
	2,0						
	2,4						
	2,5						
	2,8						
	3,0						
	3,2						
	3,5						

AUF ANFRAGE
UPON REQUEST

mit rundem Ende / with round shaft
 con extremo redondo / con estremità rotonda

ELEVATOREN
ELEVATORS
ELEVADORES
ELEVATORI



MATTES

NERVWURZELHAKEN, GALEA HAKEN
 NERVE ROOT RETRACTORS, GALEA HOOKS
 SEPARADORES DE RAIZ DE NERVIOS, GANCHO PARA GALEA
 UNCINI PER LE RADICI DEI NERVI, UNCINI GALEA

GALEAHAKEN
 GALEA HOOKS
 GANCHO P/GALEA
 GANCIO P/GALEA



DeMartel
8958.33 33 cm



Ø 7 mm

4 mm

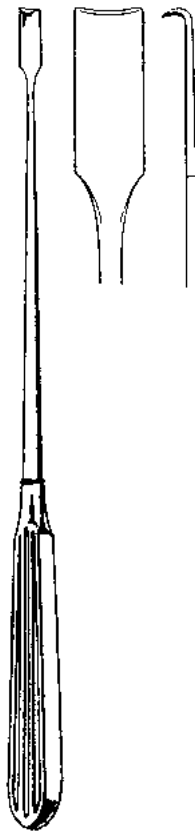
Yasargil
8959.31 31 cm



Ø 9 mm

6 mm

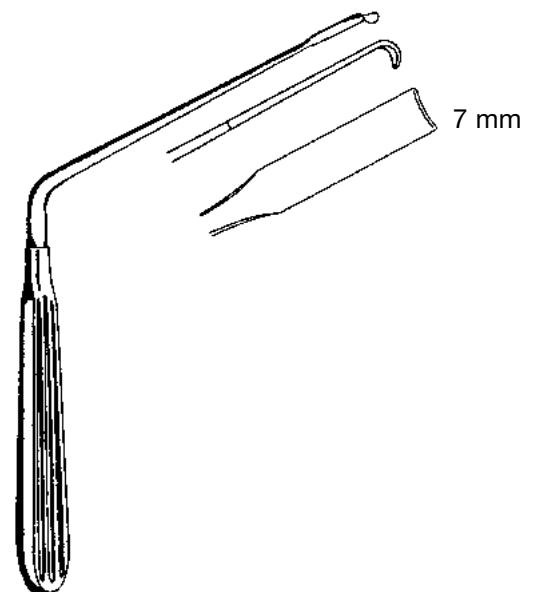
Yasargil
8960.41 41 cm



Scoville
8955.23 23 cm



Holsher
8956.24 24 cm



7 mm

Scoville
8957.20 20 cm

MENISKUSMESSER
 MENISCOTOMES
 MENISCÓTOMOS
 MENISCOTOMI



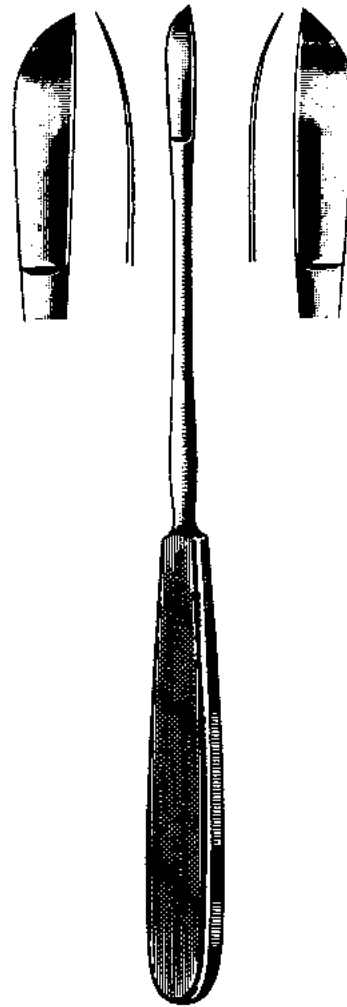
SMILLIE



8961.17
 17 cm



8962.17
 17 cm



Neff
 8963.22 - 8964.22
 22 cm

MATTES

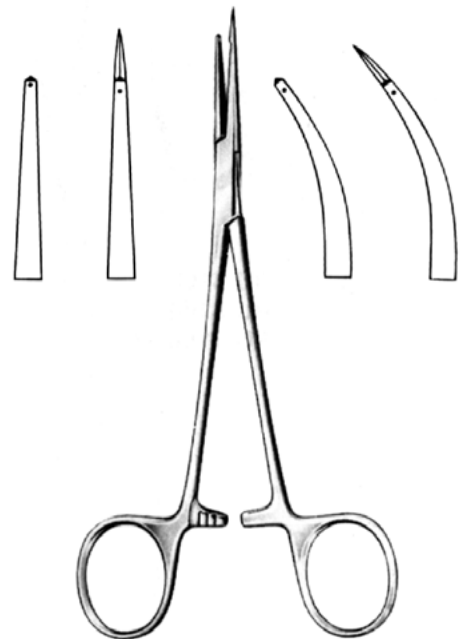
SEHNENFASSINSTRUMENTE, SEHNENSCHÄLER, SEHNENFÜHRER, SEHNENSTRIPPER
 TENDON SEIZING INSTRUMENTS, TENDON PASSING INSTR., TENDON STRIPPERS
 INSTRUMENTOS PARA COGER TENDONES, INSTRUMENTO P. EL TUNEL DEL TENDON
 STRUMENTI PER AFFERRARE TENDINI, GUIDA PER TENDINE, SCOLLATENDINI



Carroll
8965.11
11 cm



Kleinert-Kutz
8966.20
20 cm

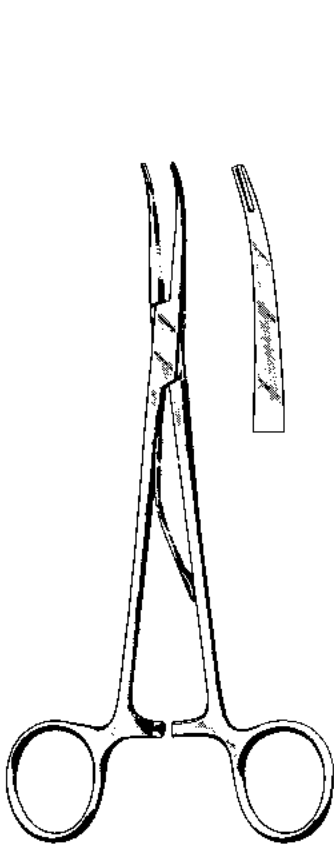


8971.15

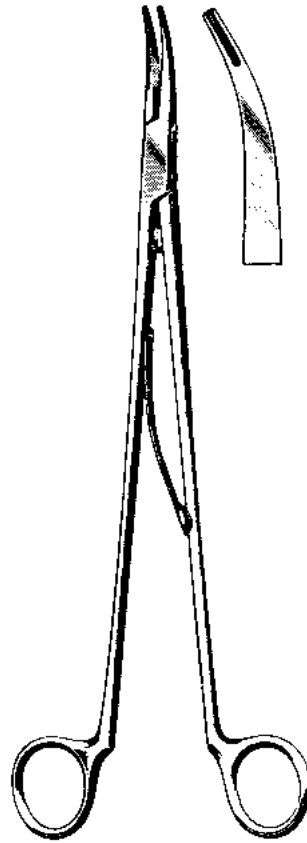
15 cm

8972.15

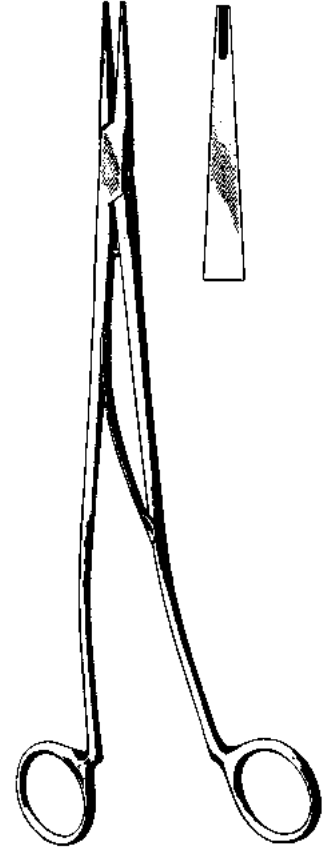
ANLEGEZANGEN, SILBERKLAMMERN
 APPLYING FCPS. CLIPS
 PINZAS APLICADORAS, GRAPAS
 PINZA PER APPLICARE, AGRAFE



McKenzie
 8975.15 15 cm
 8975.19 19 cm



Smithwick
 8976.23 23 cm
 8976.26 26 cm



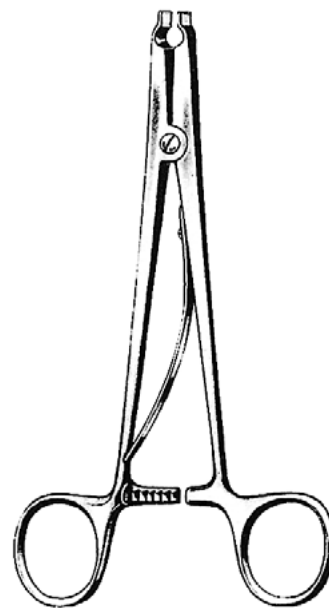
Sweet
 8977.23 23 cm
 8977.26 26 cm



Olivecrona-Toennis
 8978.14 14 cm

MATTES

SCHÄDELHALTER, KOPFHAUTKLAMMER, ANLEGEZANGE
CERVICAL TRACTION TONGS, CLIPS, APPLYING FORCEPS
PINZAS DE TRACCIÓN CRANIAL, CLIPS, PINZA PARA APLICAR CLIPS
PINZE PER TRAZIONE CRANIALE, PINZA PER APPLICARE



Raney
8988.00



DeVilbiss
8991.21 21 cm

DURA DISSEKTOREN
DURA DISSECTORS
ELEVADORES PARA LA DURAMADRE
SCOLLATORI PER DURAMADRE

MATTES

DURA DISSEKTOREN, MESSER
DURA DISSECTORS, KNIFE
ELEVADORES, BISTURÍ PARA DURAMADRE
SCOLLATORI, BISTURI PER DURAMADRE



Penfield
9002.01 17,5 cm



Penfield
9002.02 19,5 cm

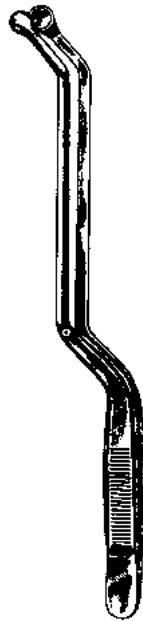


Penfield
9002.03 19,5 cm

HYPOPHYSE PINZETTEN, KÜRETTEN
 HYPOPHYSEAL FORCEPS, CURETTE
 PINZAS PARA HIPÓFISIS, CURETAS
 PINZE PER IPOFISI, CURETTE



Adson
9003.23



Adson
9004.23



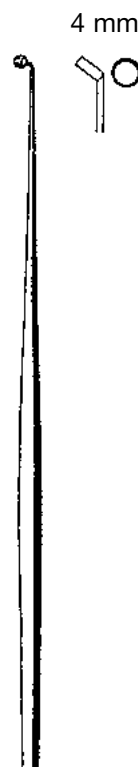
Adson
9005.23



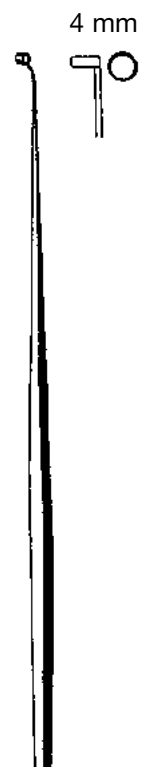
9006.00 19 cm



9007.00 19 cm



9008.00 19 cm



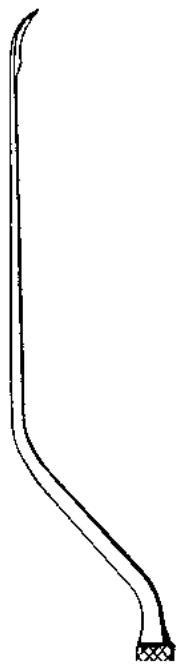
9009.00 19 cm

MATTES

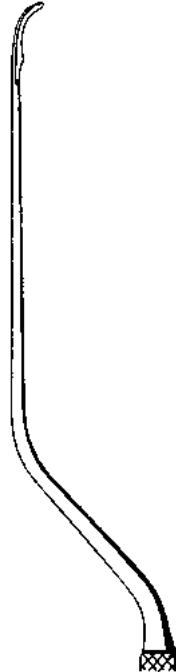
MESSER, HAKEN, SONDEN
 KNIVES, HOOKS, PROBES
 BISTURIES, GANCHOS, SONDAS
 BISTURI, UNCINO, SONDE



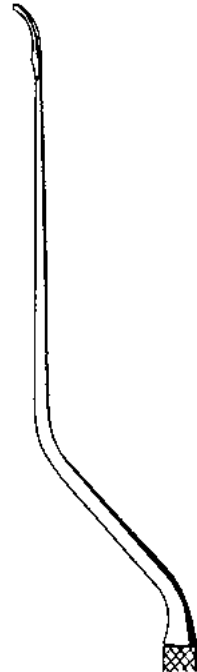
Jacobson
 9014.19 19 cm



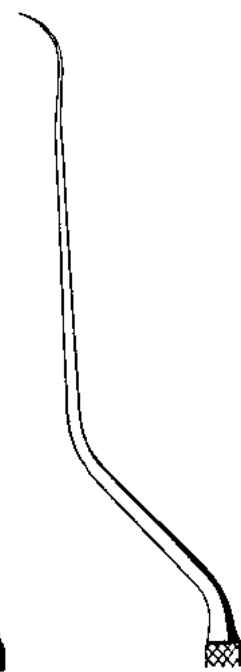
Koos
 9010.19 19 cm



Koos
 9011.19 19 cm



Koos
 9012.19 19 cm



Koos
 9013.19 19 cm



Fisch
 9016.19 19 cm

Feines Häkchen
 Delicate Hook
 Ganchito muy fino
 Uncino molto fino



Jacobson
 9017.19 19 cm

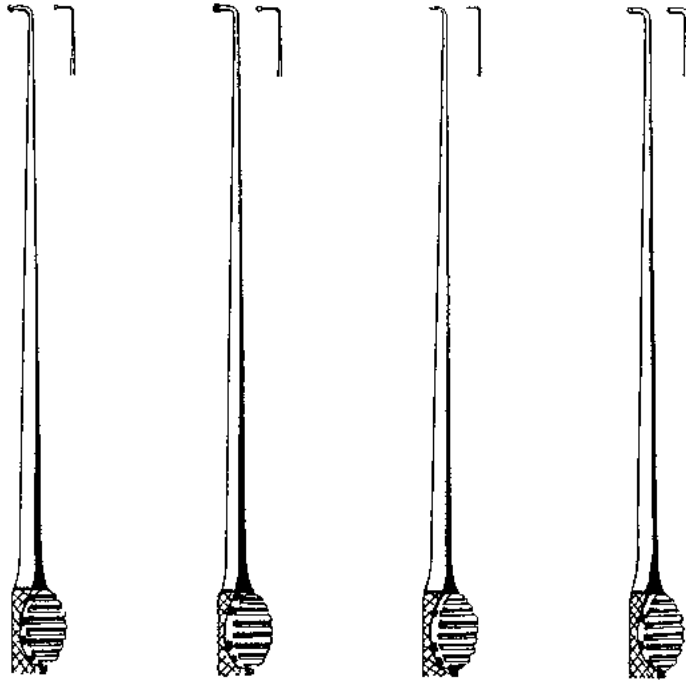
Knopfsonde
 Buttoned Probe
 Sonda abotonada
 Sonda bottonuta



Jacobson
 9018.19 19 cm

Doppelsonde
 Twin Probe
 Sonda doble
 Sonda doppia

NERVHÄKCHEN, HIRNSPATEL, SAUGROHRE
 NERVE HOOKS, BRAIN SPATULAS, SUCTION TUBES
 GANCHOS PARA NERVIOS, ESPATULAS CEREBRALES, TUBOS DE ASPIRACIÓN
 UNCINI PER NERVI, SPATOLE CEREBRALI, TUBI ASPIRAZIONI



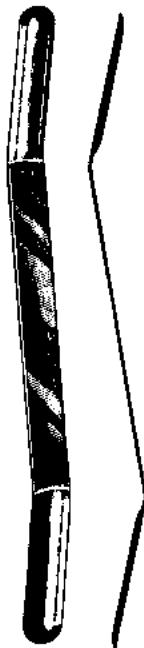
Krayenbühl

9019.19 19 cm 9020.19 19 cm 9021.19 19 cm 9022.19 19 cm



Cushing

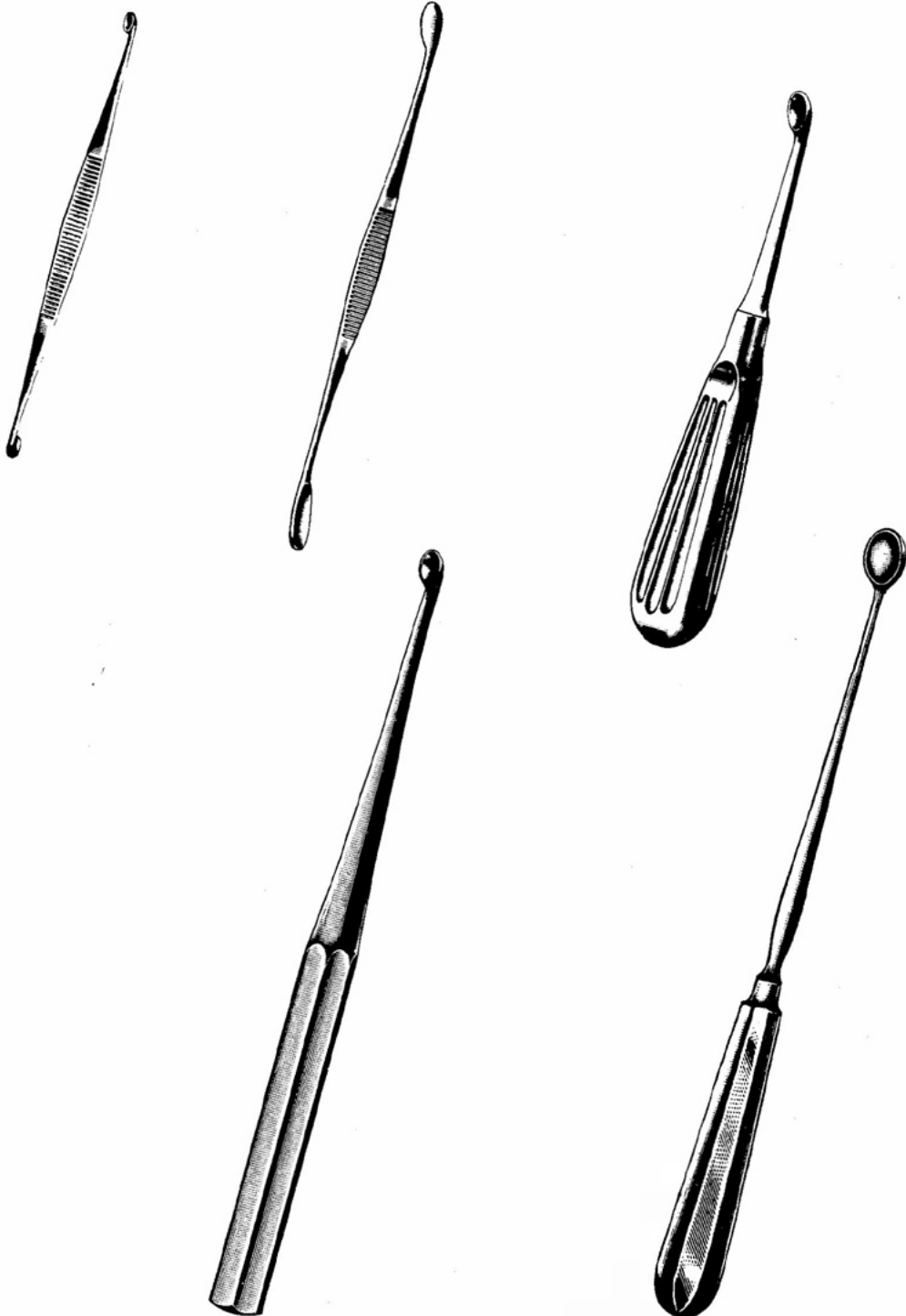
9025.11 8x10 mm
 9025.15 13x15 mm
 9025.18 16x18 mm



Olivecrona mm

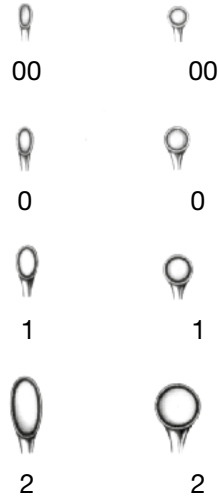
9026.07
 9026.11 11/13
 9026.15 15/18
 9026.18 18/22

SCHARFE LÖFFEL
BONE CURETTES
CURETTES À OS
CUCHARILLAS CORTANTES
CURETTE TAGLIENTI



MATTES

SCHARFE LÖFFEL
 BONE CURETTES
 CUCHARILLAS CORTANTES
 CURETTE TAGLIENTI



WILLIGER
 17,5 cm

Fig.	00	9071.99	9072.99
	0	9071.00	9072.00
	1	9071.01	9072.01
	2	9071.02	9072.02



Daubenspeck
 20 cm

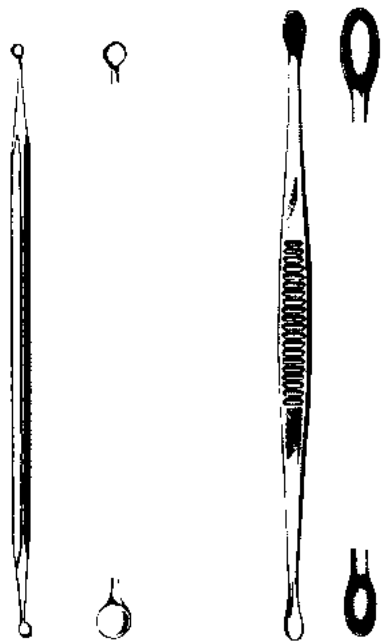
Fig.	00	9073.99
	0	9073.00



27 cm

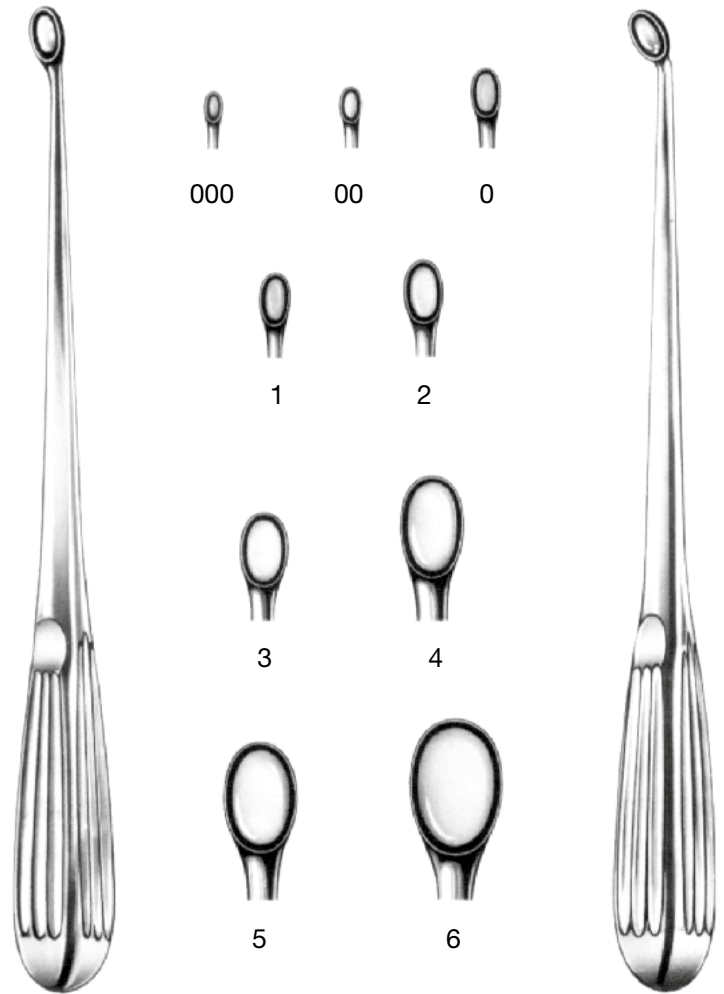
Fig.	0	9074.00
	1	9074.01
	2	9074.02
	3	9074.03

SCHARFE LÖFFEL
 BONE CURETTES
 CUCHARILLAS CORTANTES
 CURETTE TAGLIENTI



Jansen
 9075.16
 16 cm

Jacobson
 9076.13
 13 cm



Bruns
 23 cm

Bruns
 23 cm

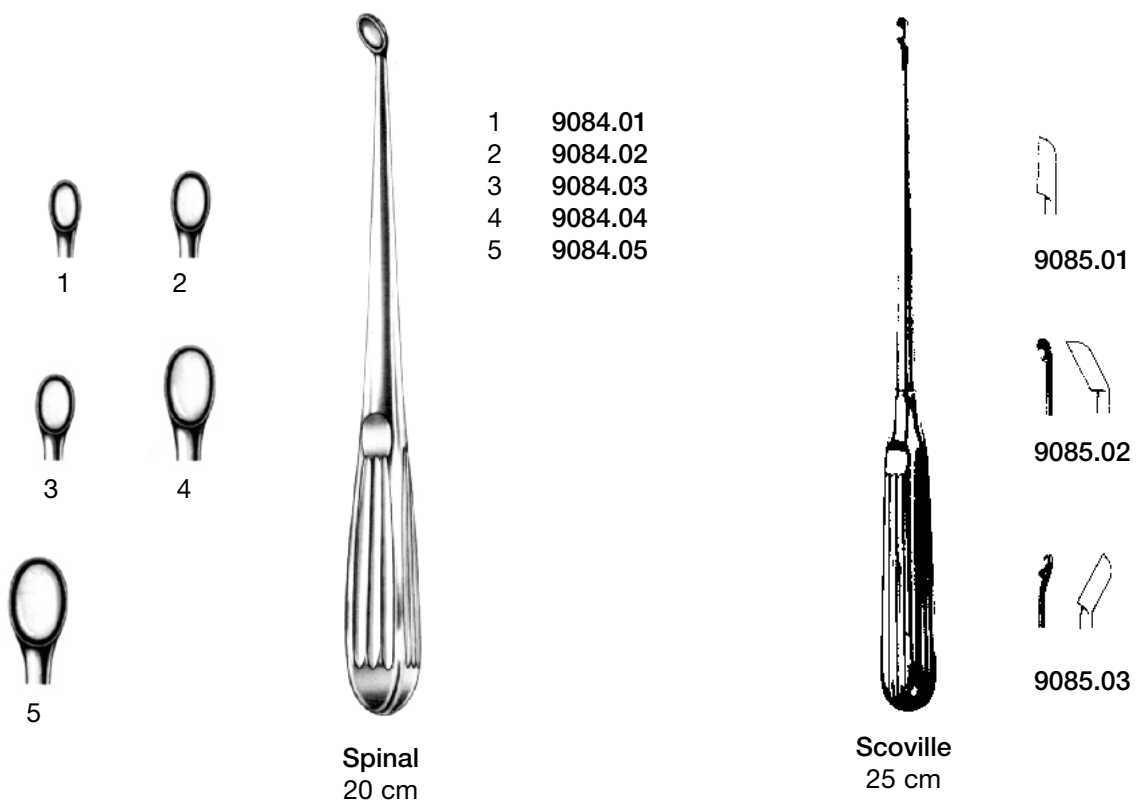
- 9077.97
- 9077.00
- 9077.01
- 9077.02
- 9077.03
- 9077.04
- 9077.05
- 9077.06

- Fig.
- 000
 - 0
 - 1
 - 2
 - 3
 - 4
 - 5
 - 6

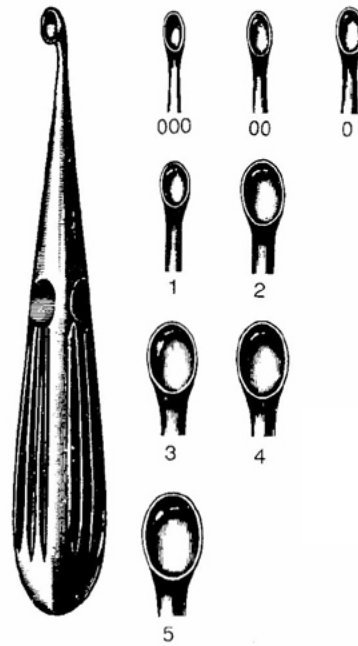
- 9078.97
- 9078.98
- 9078.00
- 9078.01
- 9078.02
- 9078.03
- 9078.04
- 9078.05
- 9078.06

MATTES

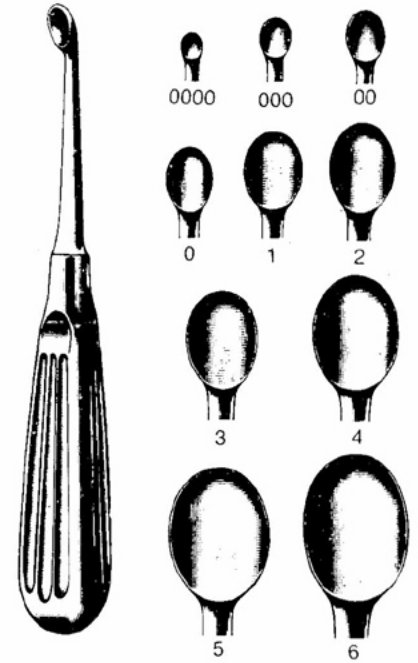
SCHARFE LÖFFEL
 BONE CURETTES
 CUCHARILLAS CORTANTES
 CURETTE TAGLIENTI



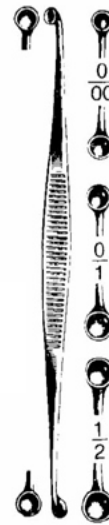
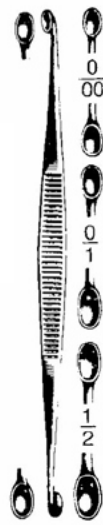
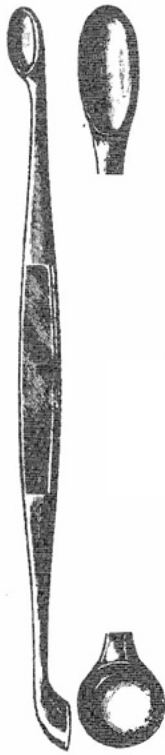
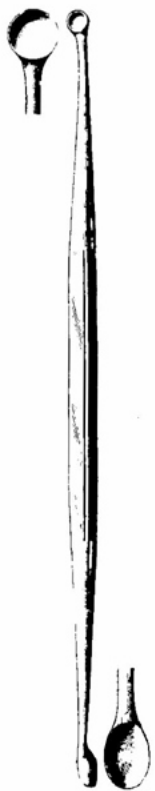
SCHARFE LÖFFEL
BONE CURETTES
CURETTES À OS
CUCHARILLAS CORTANTES
CURETTE TAGLIENTI



- Spratt**
Fig. 000 9100.30
Fig. 00 9100.20
Fig. 0 9100.10
Fig. 1 9100.01
Fig. 2 9100.02
Fig. 3 9100.03
Fig. 4 9100.04
Fig. 5 9100.05



- Volkmann**
Fig. 0000 9110.40
Fig. 000 9110.30
Fig. 00 9110.20
Fig. 0 9110.10
Fig. 1 9110.01
Fig. 2 9110.02
Fig. 3 9110.03
Fig. 4 9110.04
Fig. 5 9110.05
Fig. 6 9110.06



Volkmann

Williger

Martini

21,0 cm/8 1/4"
9112.21

13,0 cm 9115.13 13,0 cm 9117.13
14,5 cm 9117.14
17,0 cm 9117.17

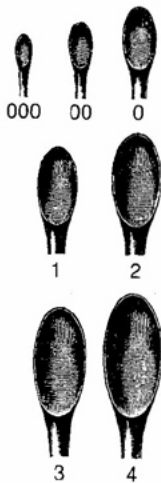
9118.00 Fig. 00/0 9119.00
9118.01 Fig. 0/1 9119.01
9118.02 Fig. 1/2 9119.02

MATTES

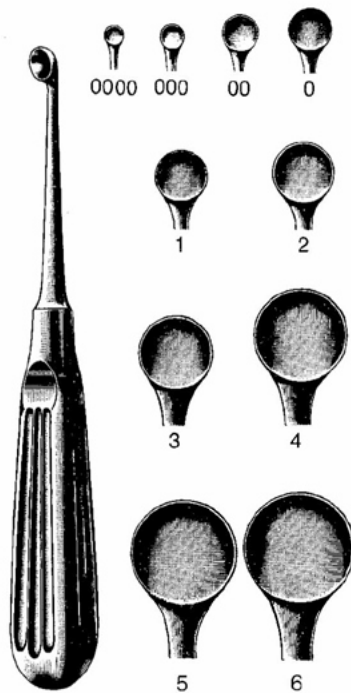
SCHARFE LÖFFEL
 BONE CURETTES
 CURETTES À OS
 CUCHARILLAS CORTANTES
 CURETTE TAGLIENTI



Schede



- | | |
|------|---------|
| Fig. | |
| 000 | 9120.30 |
| 00 | 9120.20 |
| 0 | 9120.10 |
| 1 | 9120.01 |
| 2 | 9120.02 |
| 3 | 9120.03 |
| 4 | 9120.04 |



Bruns

- | | |
|------|---------|
| Fig. | |
| 0000 | 9122.40 |
| 000 | 9122.30 |
| 00 | 9122.20 |
| 0 | 9122.10 |
| 1 | 9122.01 |
| 2 | 9122.02 |
| 3 | 9122.03 |
| 4 | 9122.04 |
| 5 | 9122.05 |
| 6 | 9122.06 |



Lempert

- | | |
|------------|---------|
| Fig. 0 | 9125.10 |
| Fig. 00 | 9125.20 |
| Fig. 000 | 9125.30 |
| Fig. 0000 | 9125.40 |
| Fig. 00000 | 9125.50 |



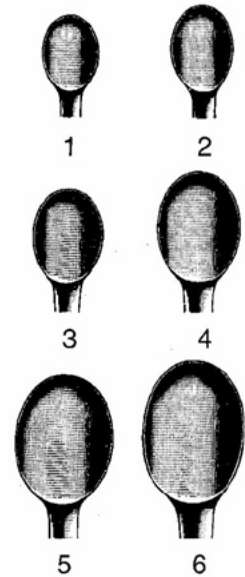
Bruns
23,0 cm

- | | |
|------|---------|
| Fig. | |
| 000 | 9126.30 |
| 00 | 9126.20 |
| 0 | 9126.10 |
| 1 | 9126.01 |
| 2 | 9126.02 |
| 3 | 9126.03 |
| 4 | 9126.04 |
| 5 | 9126.05 |
| 6 | 9126.06 |

scharf
sharp
cortante
tagliente

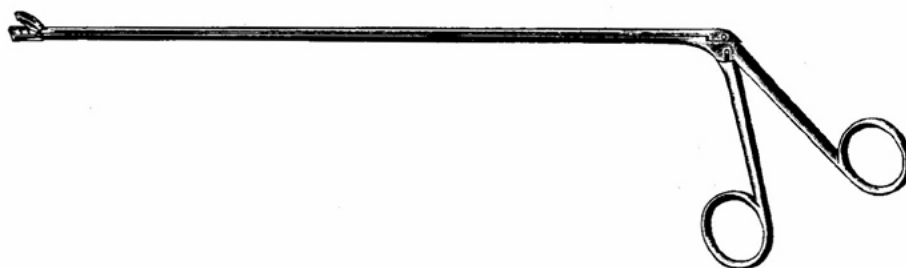
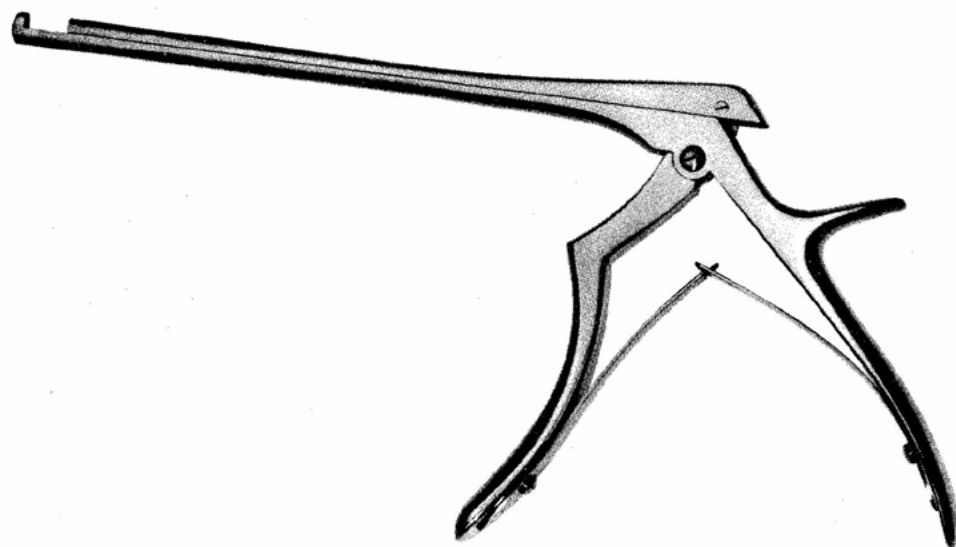


Simon
24,0 cm



- | | |
|------------|---------|
| Fig. Simon | |
| 1 | 9130.01 |
| 2 | 9130.02 |
| 3 | 9130.03 |
| 4 | 9130.04 |
| 5 | 9130.05 |
| 6 | 9130.06 |

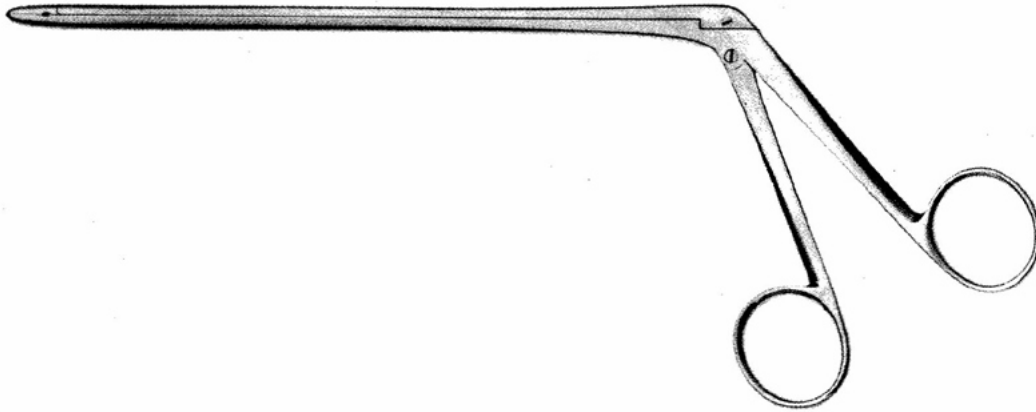
LAMINEKTOMIE
LAMINECTOMY
LAMINECTOMIE
LAMINECTOMÍA
LAMINECTOMIA



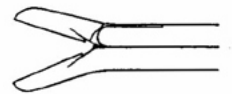
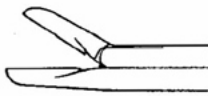
KEHLKOPF-ZANGEN
LARYNX
LARINGE

MATTES

LAMINEKTOMIE
LAMINECTOMY
LAMINECTOMIE
LAMINECTOMÍA
LAMINECTOMIA



Cushing 2 mm

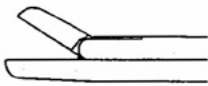


2 x 10 mm	L
9131.12	12,5 cm
9131.18	18,0 cm

2 x 10 mm/45°	L
9132.12	12,5 cm
9132.18	18,0 cm

2 x 10 mm/45°	L
9133.12	12,5 cm
9133.18	18,0 cm

Love-Gruenwald 3 mm

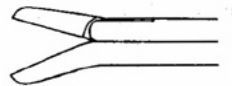
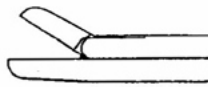


3 x 10 mm	L
9134.12	12,5 cm
9134.18	18,0 cm

3 x 10 mm/45°	L
9135.12	12,5 cm
9135.18	18,0 cm

3 x 10 mm/45°	L
9136.12	12,5 cm
9136.18	18,0 cm

Spurling 4 mm

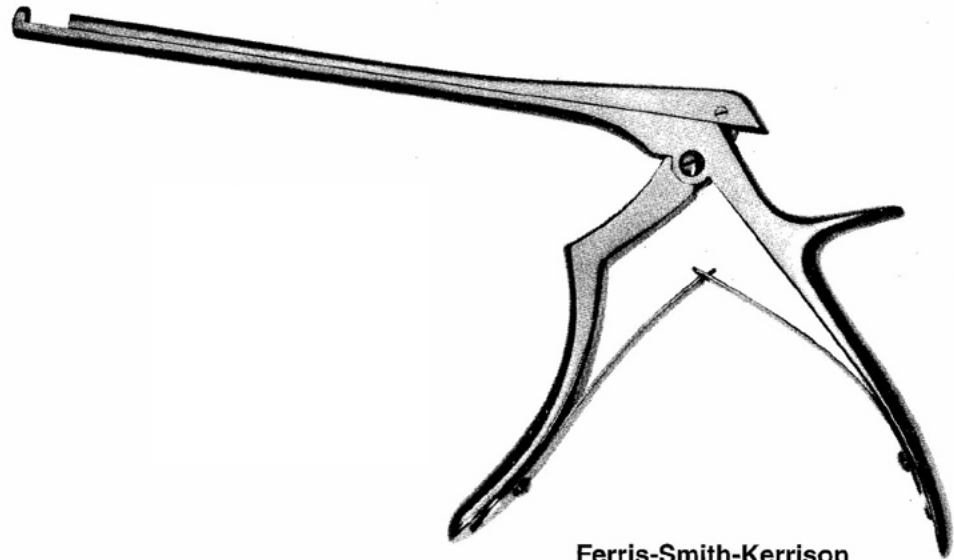


4 x 10 mm	L
9137.12	12,5 cm
9137.18	18,0 cm

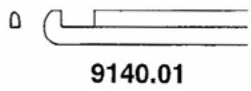
4 x 10 mm/45°	L
9138.12	12,5 cm
9138.18	18,0 cm

4 x 10 mm/45°	L
9139.12	12,5 cm
9139.18	18,0 cm

LAMINEKTOMIE
 LAMINECTOMY
 LAMINECTOMIE
 LAMINECTOMÍA
 LAMINECTOMIA

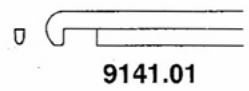


Ferris-Smith-Kerrison
 18,0 cm



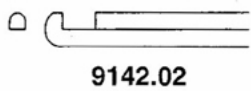
1 mm

9140.01



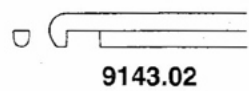
1 mm

9141.01



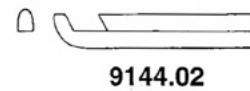
2 mm

9142.02



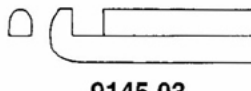
2 mm

9143.02



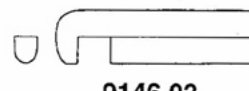
2 mm

9144.02



3 mm

9145.03



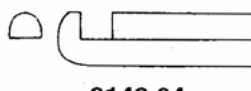
3 mm

9146.03



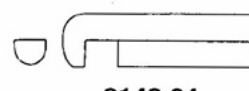
3 mm

9147.03



4 mm

9148.04



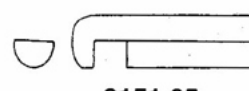
4 mm

9149.04



5 mm

9150.05



5 mm

9151.05

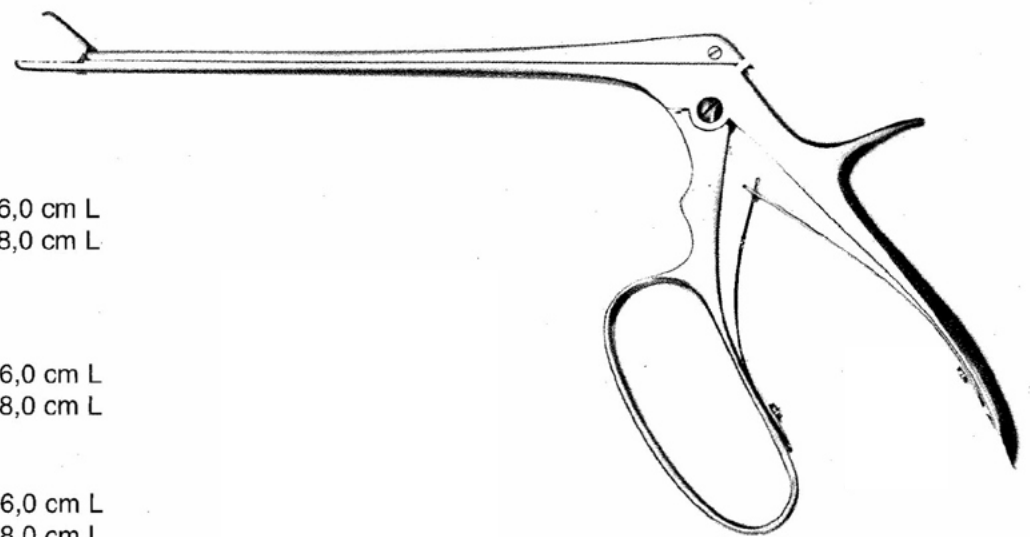
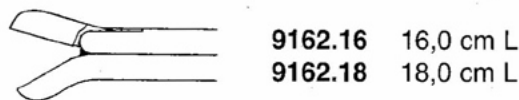
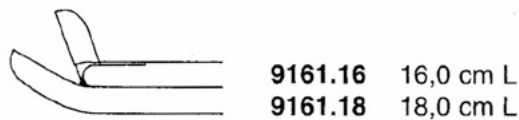
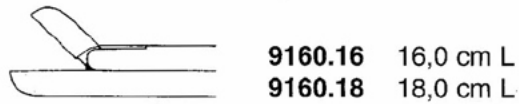
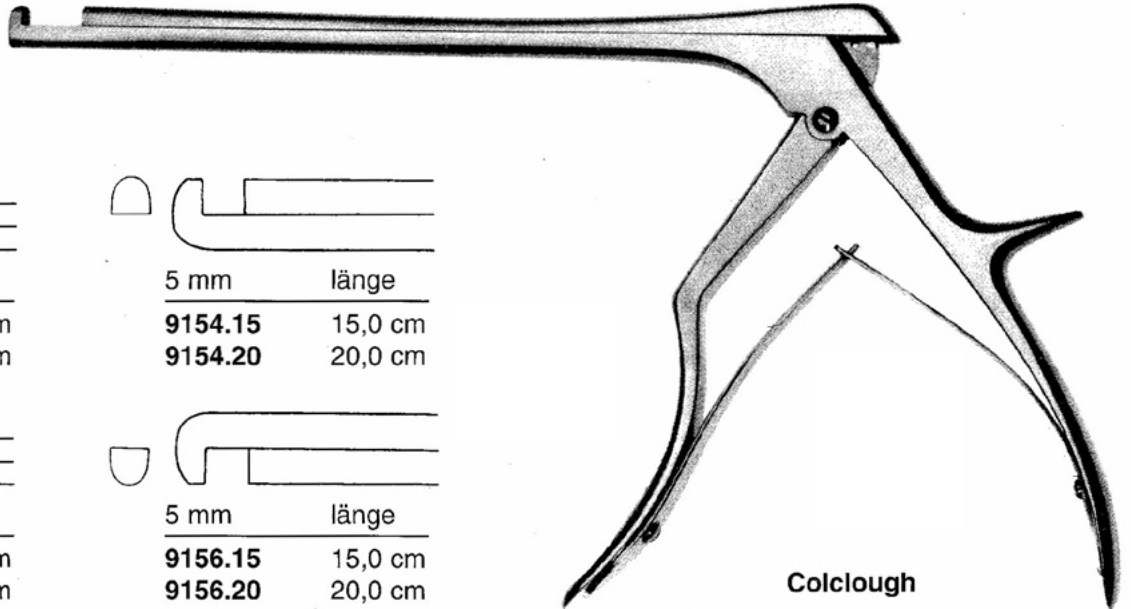
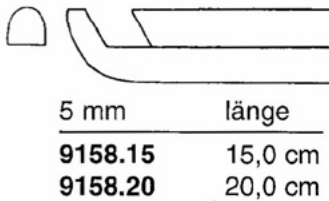
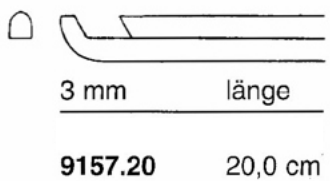
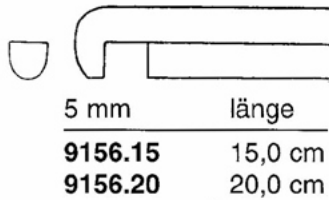
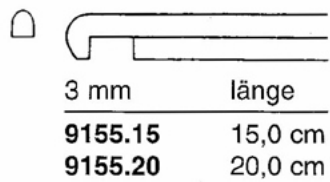
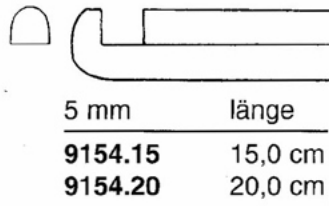
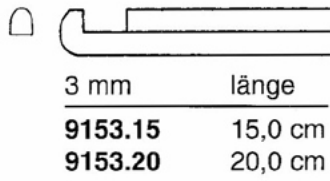


5 mm

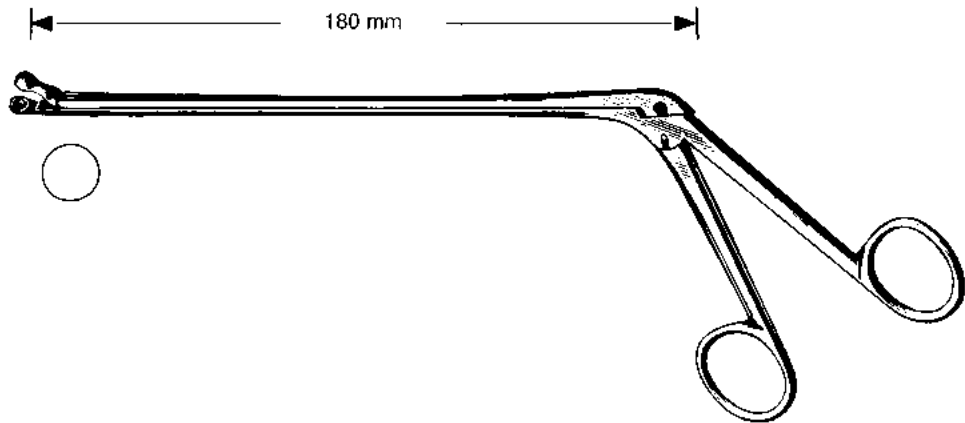
9152.05

MATTES

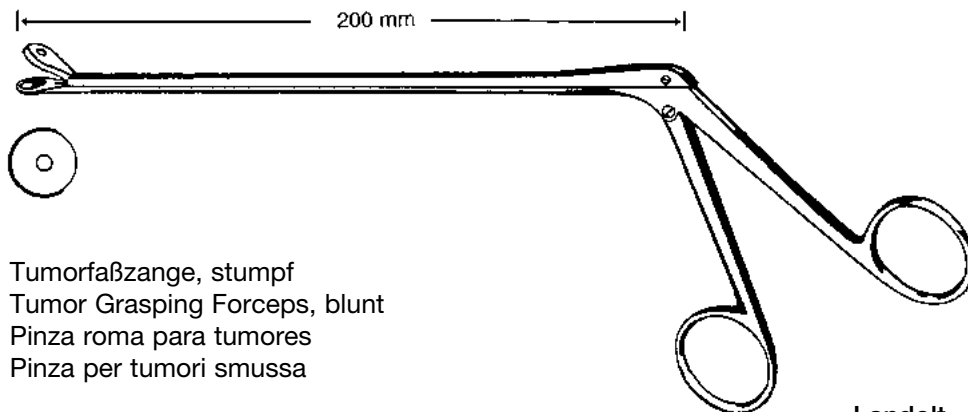
LAMINEKTOMIE
LAMINECTOMY
LAMINECTOMIE
LAMINECTOMÍA
LAMINECTOMIA



LAMINEKTOMIE ZANGEN
 LAMINECTOMY RONGEURS
 PINZAS CORTANTES PARA LAMINECTOMIA
 PINZE TAGLIENTI PER LAMINECTOMIA



Oldberg
 9163.25
 25 cm, Ø 7 mm

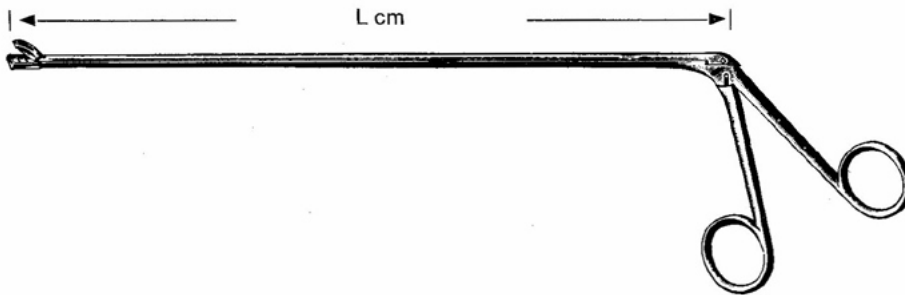


Tumorfaßzange, stumpf
 Tumor Grasping Forceps, blunt
 Pinza roma para tumores
 Pinza per tumori smussa

Landolt
 9164.27 27 cm

MATTES

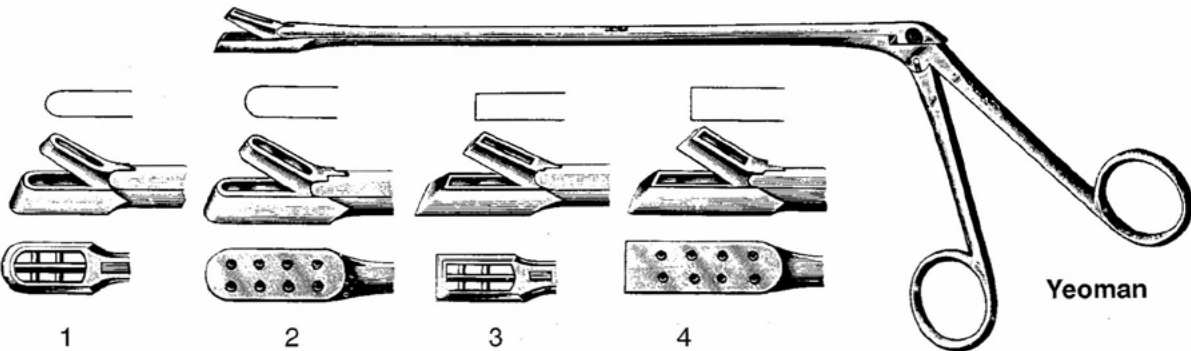
KEHLKOPF-ZANGEN LARYNX LARINGE



Chevalier Jackson
Fig. 1 – 7

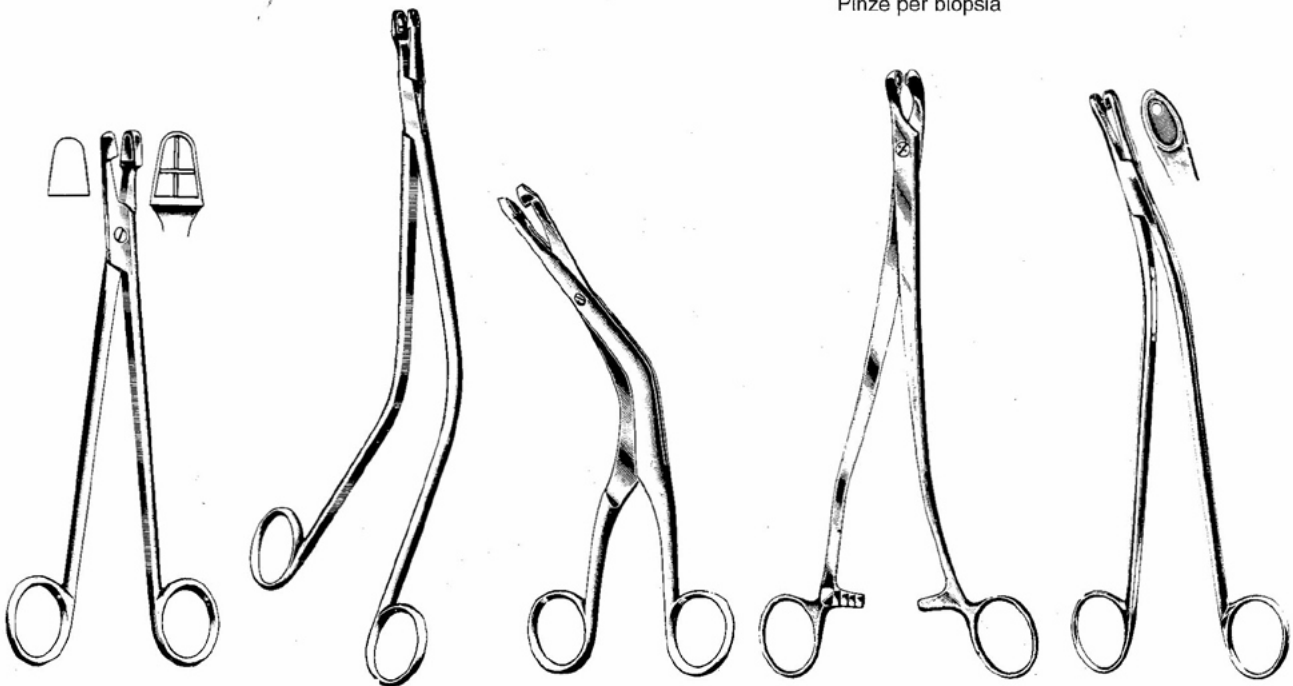


cm	Fig. 1	Fig. 2	Fig. 3	Fig. 4	Fig. 5	Fig. 6	Fig. 7
30	9165.01	9165.02		9165.04	9165.05	9165.06	9165.07
40	9166.01	9166.02	9166.03	9166.04	9166.05	9166.06	9166.07
50	9167.01	9167.02	9167.03	9167.04	9167.05	9167.06	9167.07
60	9168.01	9168.02	9168.03	9168.04	9168.05	9168.06	9168.07



Yeoman

cm	1	2	3	4	
28	9170.01	9170.02	9170.03	9170.04	Biopsie-Zangen
35	9171.01	9171.02	9171.03	9171.04	Biopsy Specimen Forceps
42	9172.01	9172.02	9172.03	9172.04	Pinces emporte-pièce à biopsie
					Pinzas sacabocado para biopsia
					Pinze per biopsia



	Schubert	Schubert	Faure	Thoms-Gaylor	Gellhorn
21,0 cm	9175.21	26,0 cm	21,0 cm	24,0 cm	24,0 cm
28,0 cm	9175.28	9176.26	9178.21	9179.24	9180.24

SEPTUM-SCHERE, KEHLKOPFPOLYPENZANGEN, DECKELHALTER
 SEPTUM-SCISSORS, LARYNGEAL POLYPUS FORCEPS, EPIGLOTTIS RETRACTOR
 TIJERAS PARA SEPTO, PINZAS PARA PÓLIPOS LARÍNGEOS, DEPRESOR PARA EPIGLOTIS
 FORBICE PER IL SETTO NASALE, PINZE PER POLIPI LARINGEI, DEPRESSORE PER EPIGLOTTIDE



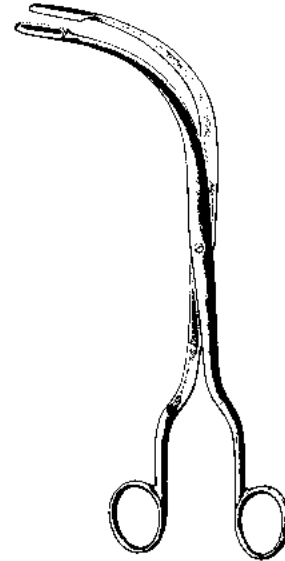
9169.01



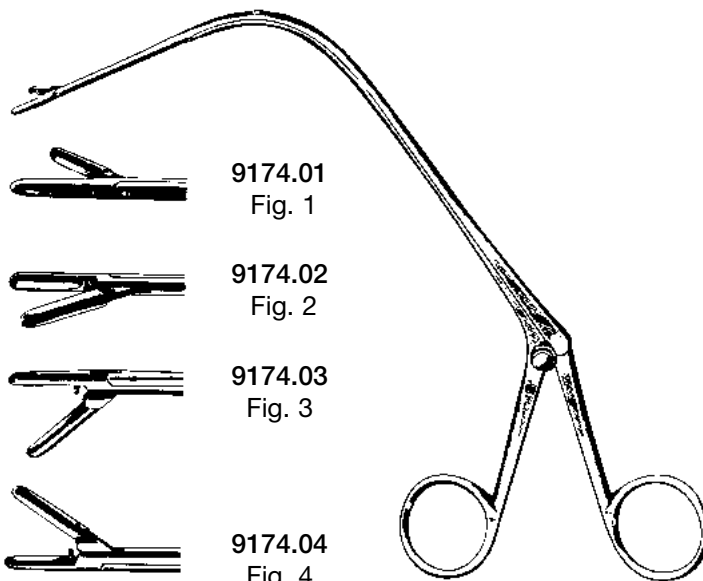
9169.02



Jackson
22 cm



Fraenkel
9177.18 18 cm



9174.01
Fig. 1

9174.02
Fig. 2

9174.03
Fig. 3

9174.04
Fig. 4

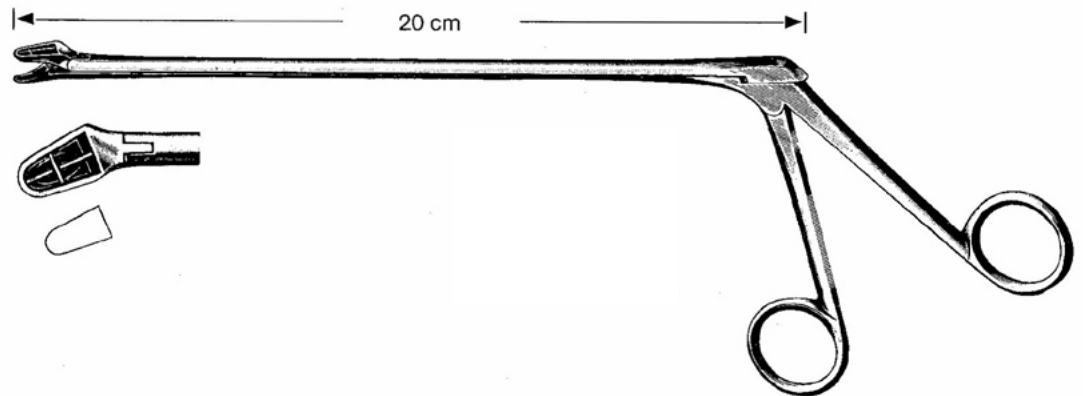
Jurasz
23 cm



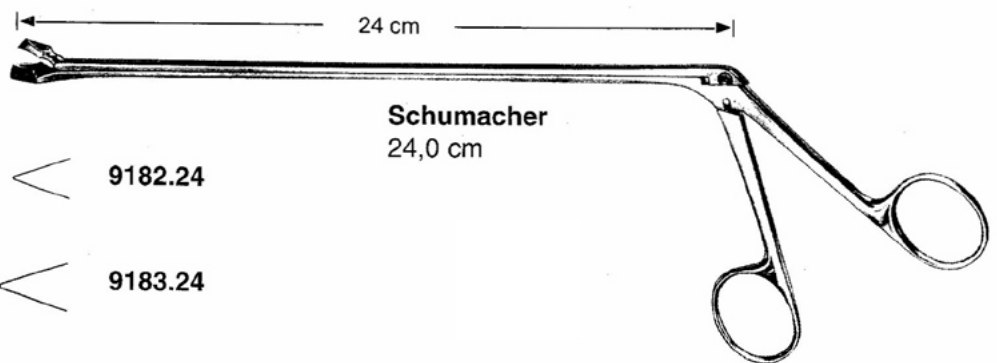
Reichert
9184.24 24 cm

MATTES

BIOPSIEZANGEN
BIOPSY SPECIMEN FORCEPS
PINCES À BIOPSIE
PINZAS SACABOCADO P. BIOPSIA
PINZE PER BIOPSIA



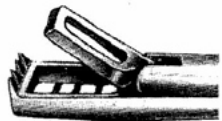
9181.28 Alexander 28,0 cm



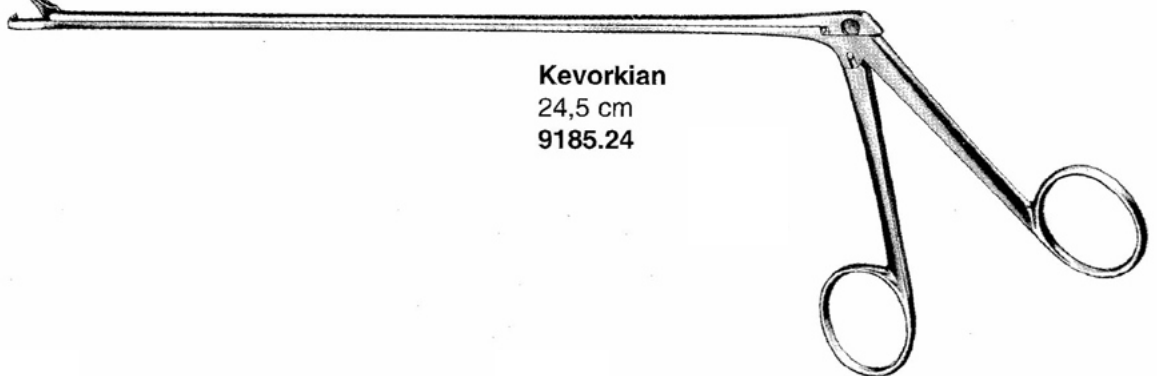
Schumacher
24,0 cm

Fig. 1  **9182.24**

Fig. 2  **9183.24**



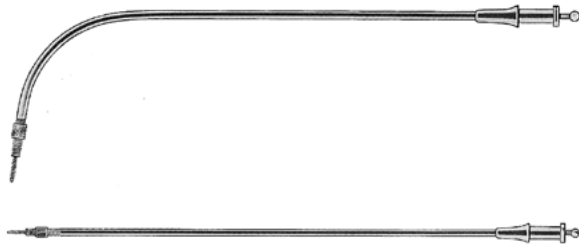
3x9,7 cm



Kevorkian
24,5 cm
9185.24

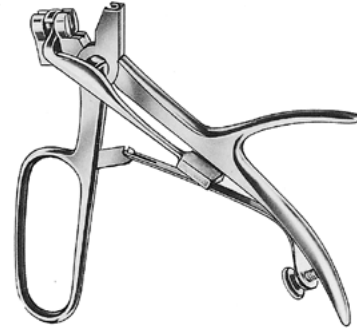
MATTES

UNIVERSALGRIFFE, VERLÄNGERUNGSRÖHRE
 UNIVERSAL HANDLES, INTERCHANGEABLE TIPS
 MANGOS UNIVERSALES Y TUBOS DE EXTENSION
 MANICI UNIVERSALI E TUBI-ALLUNGHI

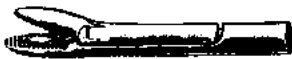


Bruenings

9220.20	20 cm	9220.50	50 cm
9220.30	30 cm	9220.60	60 cm
9220.40	40 cm		



Huber
9218.00



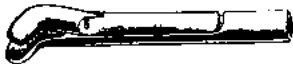
Fraenkel
9222.00



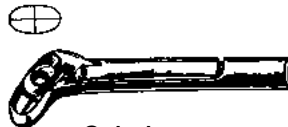
Seifert
9223.00



Fraenkel
9224.00



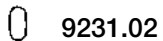
Scheinmann
9226.00



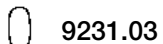
Scheinmann
9227.00



Bruenings
9228.02 - 9228.03



9231.02



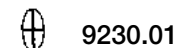
9231.03



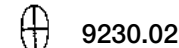
Bruenings
9231.02 - 9231.03



Lange
9229.00



9230.01



9230.02



Krause
9230.01 - 9230.02



Krause
9225.00



Schumacher
9232.00



9234.01

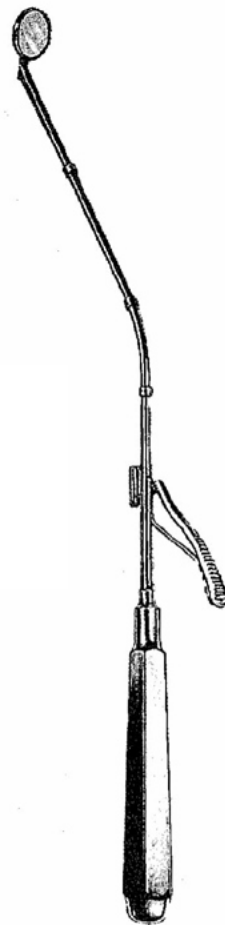


9234.02



Cordes
9234.01 - 9234.02

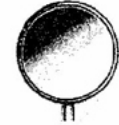
KEHLKOPF – LARYNX – SPIEGEL
LARINGE – MIRRORS



Michel
25 cm



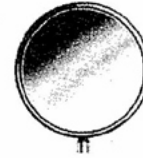
11565.12
12 mm



11565.14
14 mm

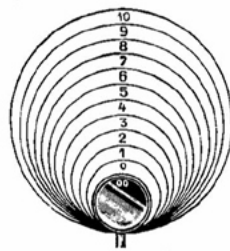


11565.16
16 mm



11565.18
18 mm

Spiegel und Griffe – Mirrors and Handles – Espejos y mangos

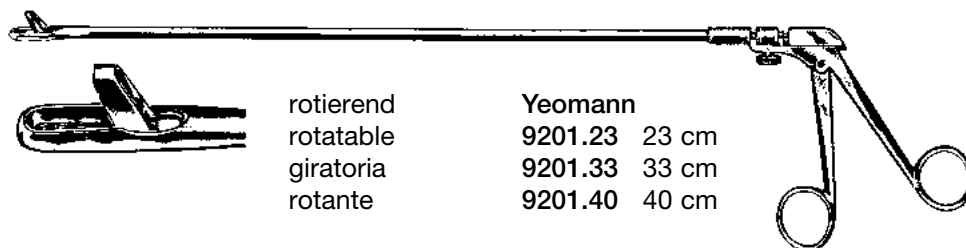


9298.10

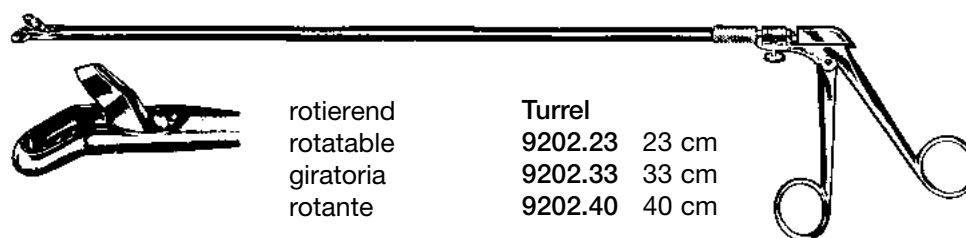
	Fig. = mm		
9295.20	00	8	9297.20
9295.10	0	10	9297.10
9295.01	1	12	9297.01
9295.02	2	14	9297.02
9295.03	3	16	9297.03
9295.04	4	18	9297.04
9295.05	5	20	9297.05
9295.06	6	22	9297.06
9295.07	7	24	9297.07
9295.08	8	26	9297.08
9295.09	9	28	9297.09
9295.11	10	30	9297.11

MATTES

MASTDARM-BIOPSIEZANGEN ROTIEREND, HÄMORRHOIDALZANGE
 RECTAL BIOPSY SPECIMEN FORCEPS ROTATABLE, HAEMORRHOIDAL FORCEPS
 PINZAS PARA BIOPSIA RECTAL, GIRATORIA, PINZAS-CLAMPS HEMORROIDALES
 PINZE TAGLIENTI PER BIOPSIA RETTALE, ROTANTE, PINZE PER EMORROIDI

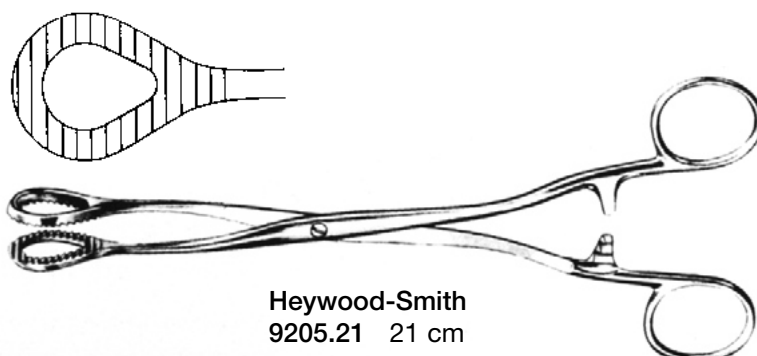


rotierend	Yeomann	
rotatable	9201.23	23 cm
giratoria	9201.33	33 cm
rotante	9201.40	40 cm



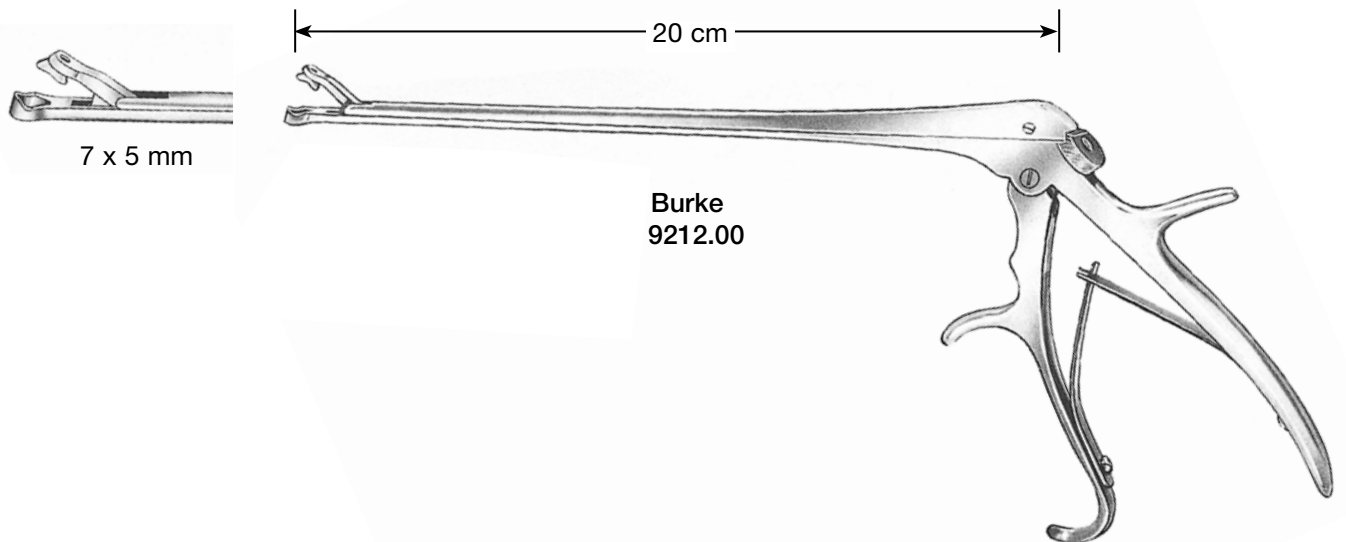
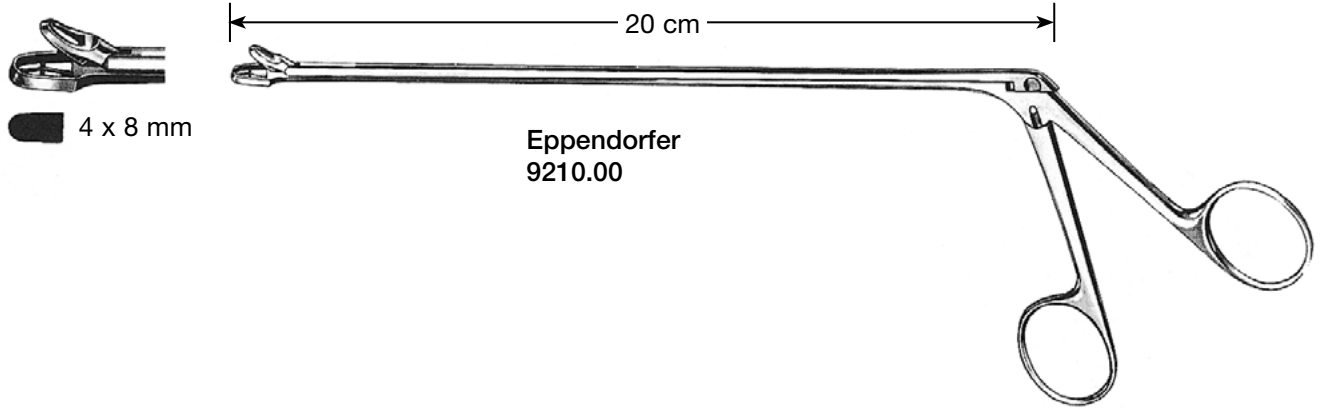
rotierend	Turrel	
rotatable	9202.23	23 cm
giratoria	9202.33	33 cm
rotante	9202.40	40 cm

REKTAL ABSAUGROHR, REKTALSCHNÜRER, MASTDARMBIOPSIEZANGEN
 RECTAL ASPIRATION CANULA, RECTAL SNARE, RECTAL BIOPSY SPECIMEN FORCEPS
 CÁNULA DE ASPIRACIÓN RECTAL, CIERRA-NUDO RECTAL, PINZAS PARA BIOPSIA RECTAL
 CANNULA D'ASPIRAZIONE RETTALE, SERRANODI, PINZE TAGLIENTI PER BIOPSIA RETTALE

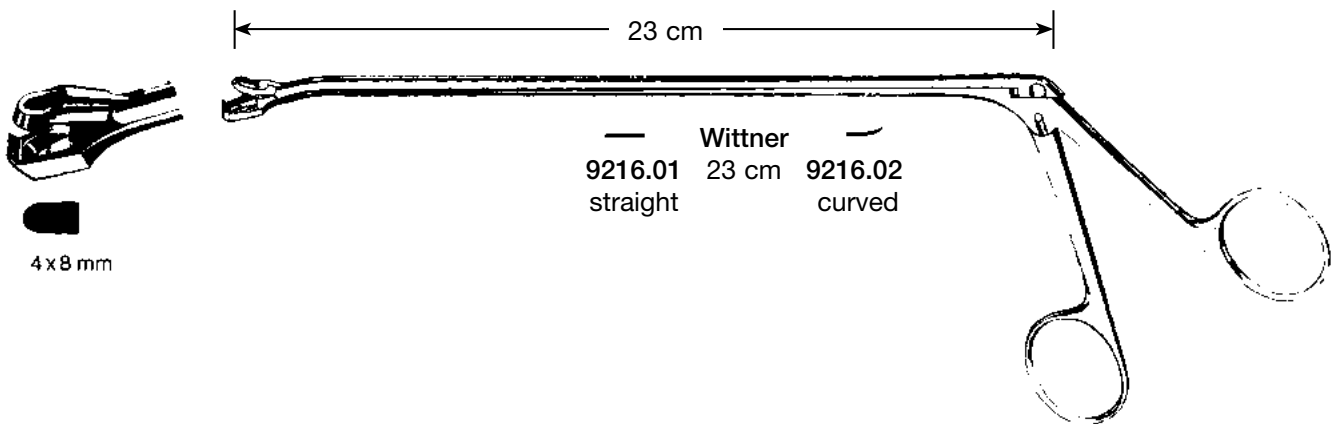


Heywood-Smith
 9205.21 21 cm

UTERUS BIOPSIEZANGEN
BIOPSY SPECIMEN FORCEPS
PINZAS SACABOCADO P. BIOPSIA
PINZE PER BIOPSIA

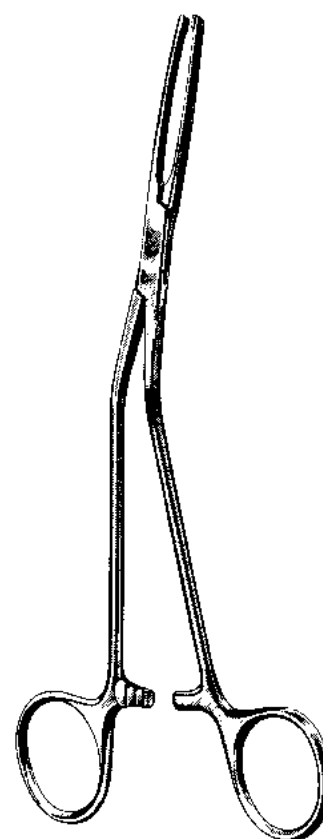


BIOPSIEZANGEN
BIOPSY FORCEPS
PINZAS PARA BIOPSIA
PINZE TAGLIENTI PER BIOPSIA



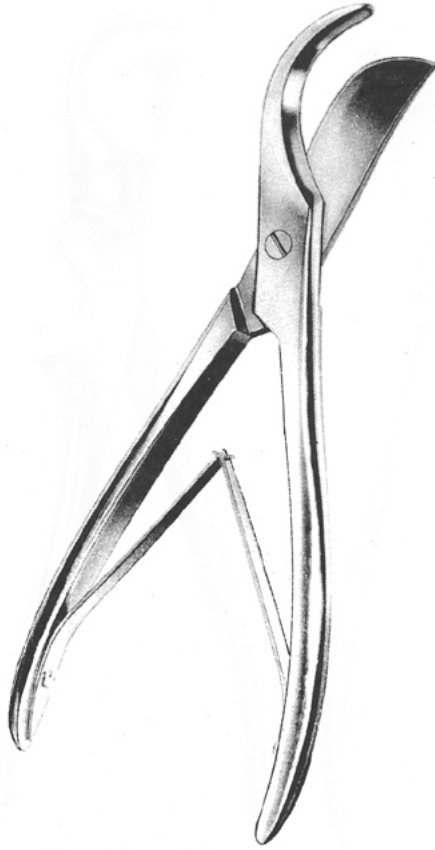
MATTES

HÄMORRHOIDAL-LIGATOREN, HÄMORRHOIDALZANGEN
HAEMORRHOIDAL LIGATORS, HAEMORRHOIDAL FORCEPS
LIGADORES PARA HEMORROIDES, PINZAS-CLAMPS PARA HEMORROIDES
LEGATORI EMORROIDALI, PINZE PER EMORROIDI



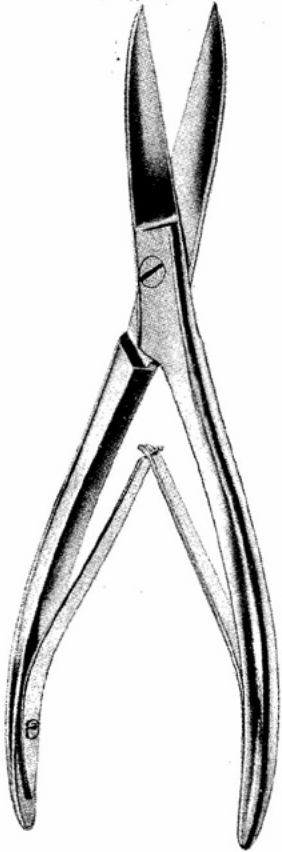
Mc Givney
9209.00
19 cm

RIPPENSCHEREN
RIP SHEARS
COSTOTOMES
COSTÓTOMOS
COSTOTOMI

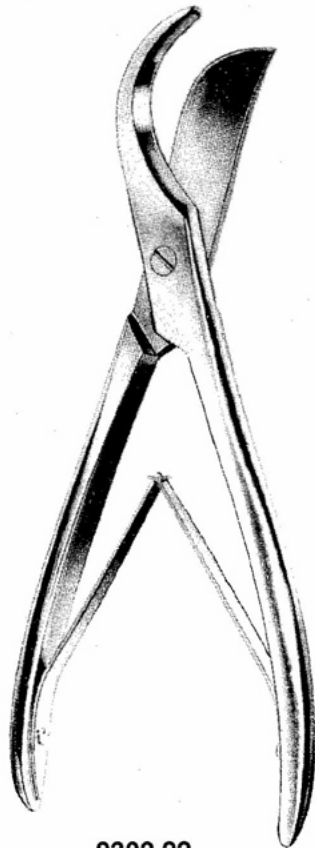


MATTES

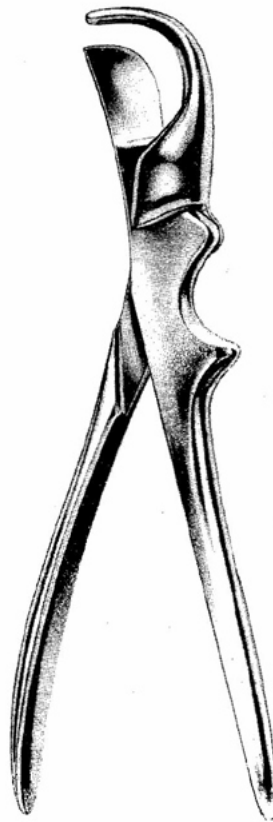
RIPPENSCHEREN
RIP SHEARS
COSTOTOMES
COSTÓTOMOS
COSTOTOMI



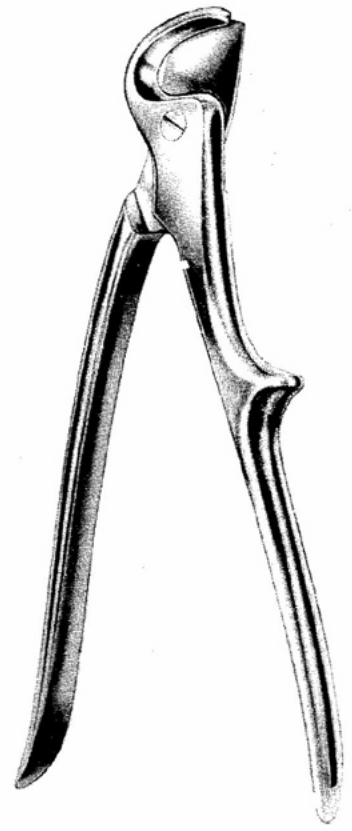
23,0 cm 9300.23



9302.22



Gluck 9303.23



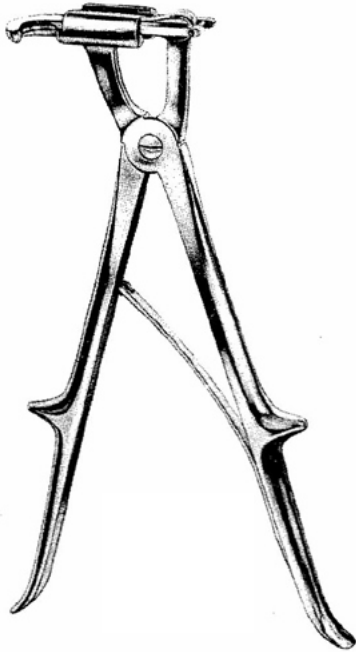
Stille 21,0 cm 9305.21

RIPPENSPERRER
RIB SPREADERS
ECARTEURS DES CÔTES
SEPARADORES COSTALES
DIVARICATORI COSTALI

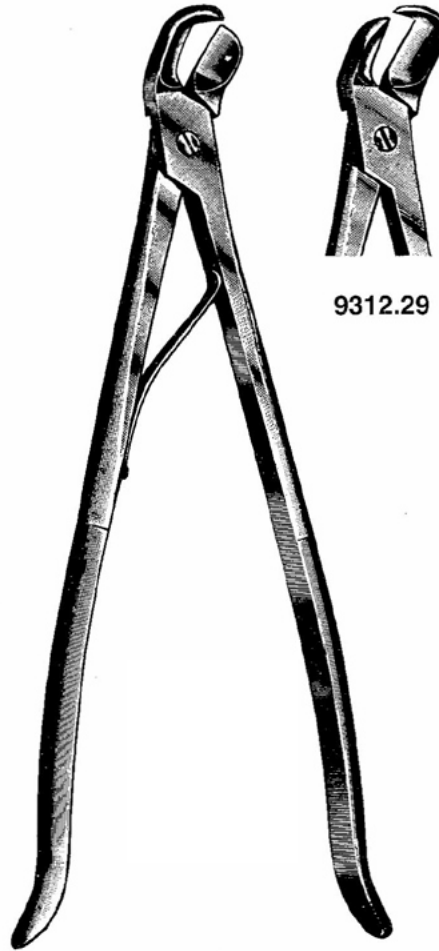


Allison
32,0 cm
9310.32

RIPPENSCHEREN
RIP SHEARS
COSTOTOMES
COSTÓTOMOS
COSTOTOMI

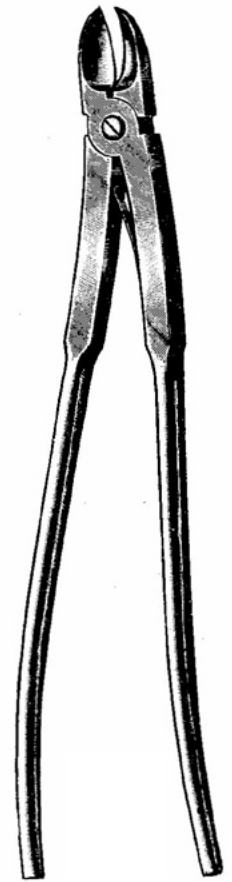


Sauerbruch 26,0 cm
9311.26

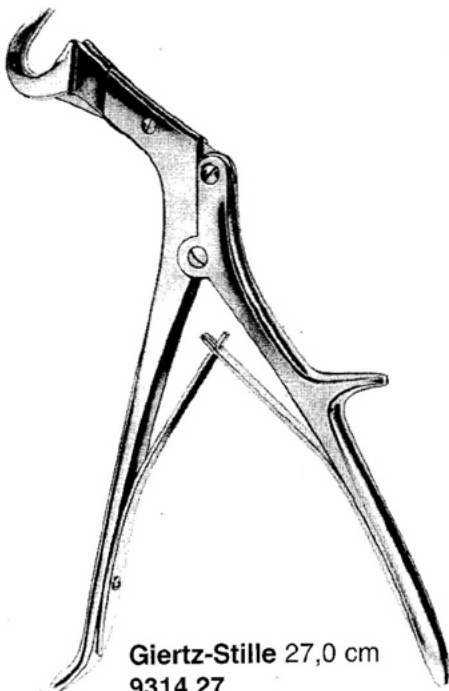


9312.29

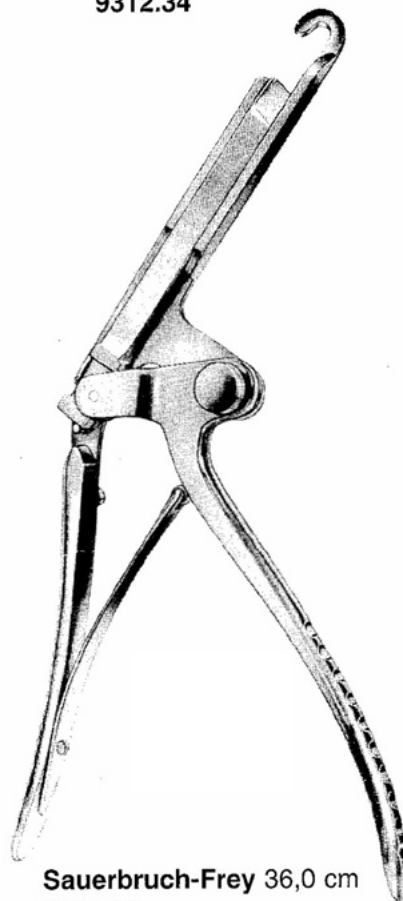
Coryllos 34,0 cm
9312.34



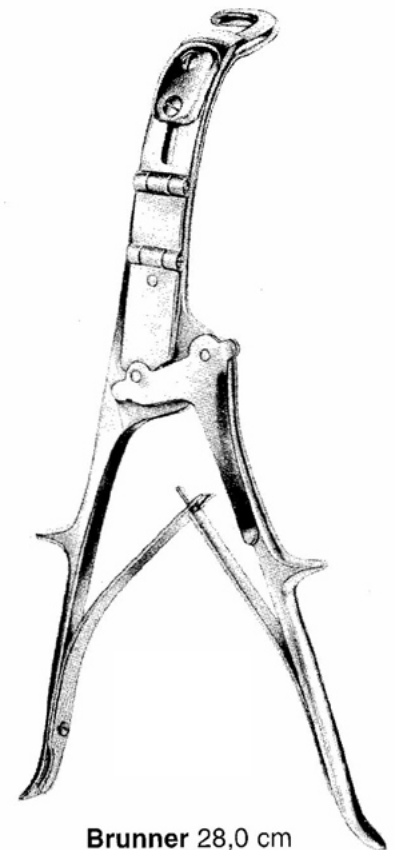
Bethune 35,0 cm
9313.35



Giertz-Stille 27,0 cm
9314.27



Sauerbruch-Frey 36,0 cm
9315.36



Brunner 28,0 cm
9316.28

UROLOGIE
UROLOGY
UROLOGIE
UROLOGÍA



MATTES

UROLOGIE
UROLOGY
UROLOGIE
UROLOGÍA

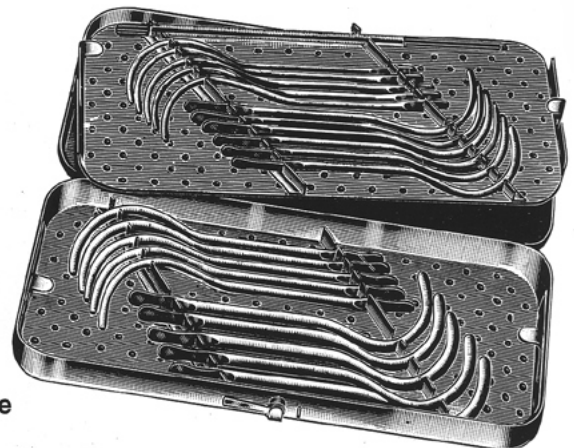
Dilatations-Bougies, Metall-Katheter
Dilating Bougies, Metal Catheters
Bougies dilatatrices, Sondes métalliques
Bujías dilatadoras, Sondas metálicas
Candelette dilatatrici, Sonde metalliche



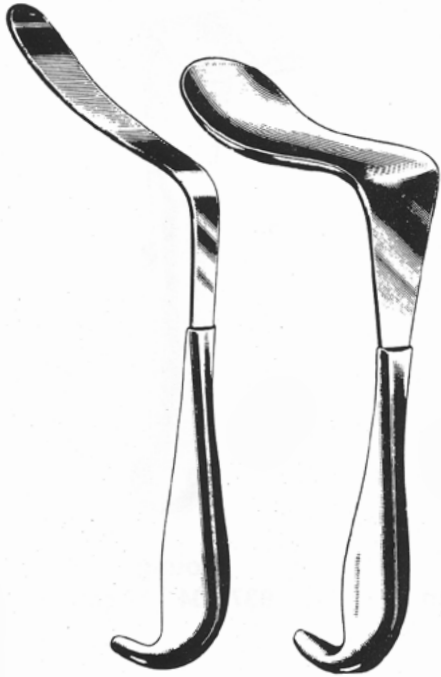
Charr./FG	van Buren	Guyon		
8	9350.08	9355.08	9360.08	9365.08
10	9350.10	9355.10	9360.10	9365.10
12	9350.12		9360.12	9365.12
14	9350.14	9355.14	9360.14	9365.14
16	9350.16	9355.16	9360.16	9365.16
18	9350.18	9355.18	9360.18	9365.18
20	9350.20	9355.20	9360.20	9365.20
22	9350.22		9360.22	9365.22
24	9350.24	9355.24	9360.24	9365.24
26	9350.26	9355.26		
28	9350.28	9355.28		
30		9355.30		
32		9355.32		
34	9350.34	9355.34		
36	9350.36	9355.36		

Set compl. 8-36
9352.00

Harnröhren-Dilatationsbesteck
Urethral Dilatation Set. Complete metal case
Guyon 9370.00



BLASENSPATEL, BLASENSPERRE
BLADDER RETRACTORS, SPREAD
SPATULES, ECARTEURS VÉSICAU
ESPÁTULAS, SEPARADORES VESI
SPATOLE, DIVARICATORI VESCICA



Legueu

27,0 cm/10 $\frac{1}{2}$ "
9320.27

Kocher

27,0 cm/10 $\frac{1}{2}$ "
9322.27

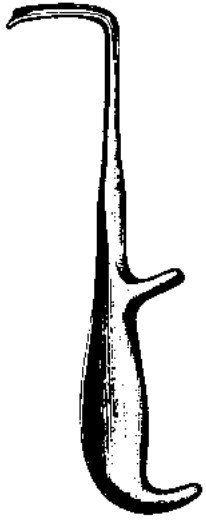
MATTES

PROSTATAHAKEN, KAPSELFASSZANGE, PROSTATAFASSZANGEN

PROSTATIC RETRACTORS, GRASPING FORCEPS FOR THE CAPSULE - ANTERIOR LOBE - AND LIGATURE CARRIER

SEPARADORES, PINZA PARA LA PRÓSTATA, PARA LA CÁPSULA, PARA LOBO ANTERIOR, PORTA-LIGADURAS

DIVARICATORI, PINZA PER AFFERRARE LA PROSTATA - PER LA CAPSULA, PER LOBO ANTERIORE, PORTAFILO



Young
9371.01 21 cm



Young
9371.02 22 cm



Young
9371.03 21 cm



9373.23



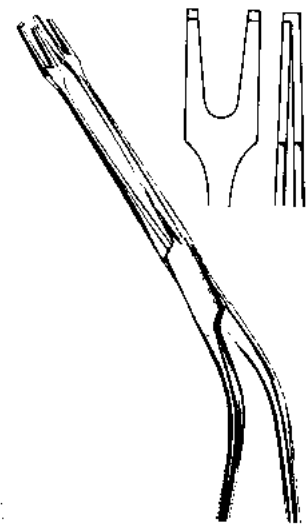
Young
9372.20 20 cm



Millin
9373.23 23 cm

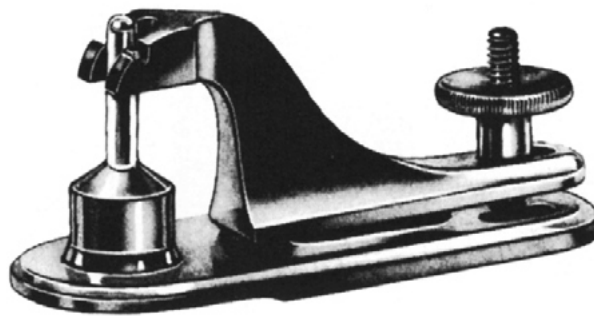


Millin
9374.23 23 cm



Millin
9375.24 24 cm

FREMDKÖRPERZANGE, PENISKLEMMEN, CIRCUMCISIONSGERÄT
 FOREIGN BODY FORCEPS, PENIS SEIZING FORCEPS, CIRCUMCISION INSTRUMENT
 PINZAS PARA CUERPOS EXTRAÑOS, COMPRESORES URETRALES, INSTRUMENTOS PARA CIRCUNCISIÓN
 PINZE PER CORPI ESTRANEI, SERRAPENE, STRUMENTI PER CIRCONCISONE

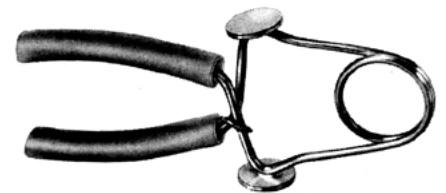


- 9379.08 8 mm Ø
- 9379.11 11 mm Ø
- 9379.13 13 mm Ø
- 9379.16 16 mm Ø
- 9379.21 21 mm Ø
- 9379.26 26 mm Ø
- 9379.32 32 mm Ø

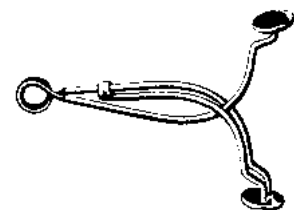
9379.08 - 9379.32



Mathieu
 9381.20 20 cm
 9381.28 28 cm

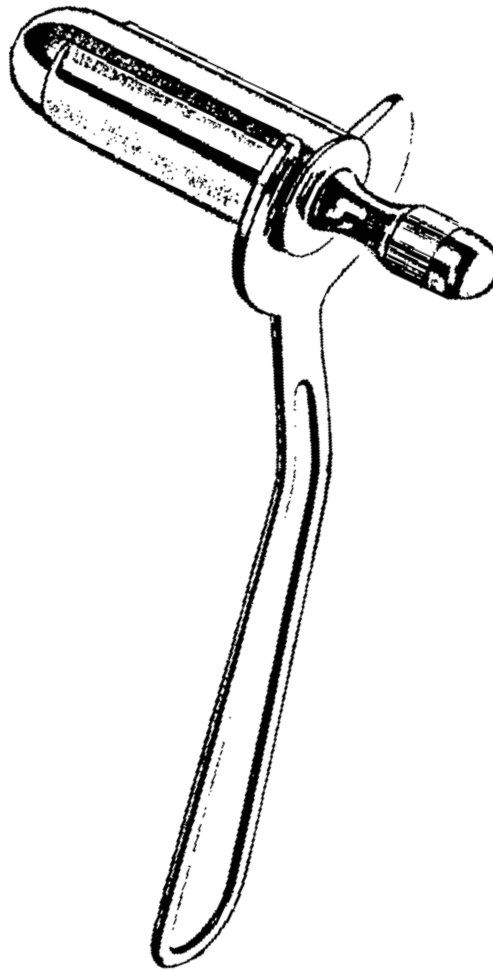


Strauss
 9342.00



Stockmann
 9345.00

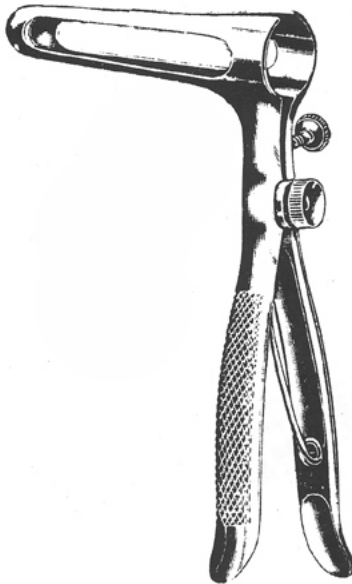
MASTDARM
RECTUM
RECTUM
RECTO
RETTO



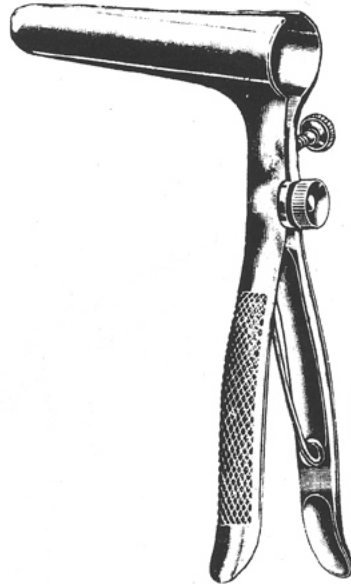
MATTES

MASTDARM
RECTUM
RECTUM
RECTO
RETTO

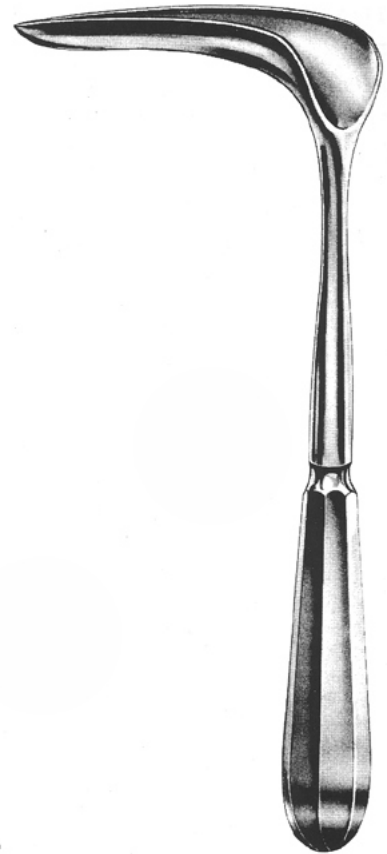
Mastdarm-Spekula
Rectal Specula
Spéculums rectaux
Espéculos rectales
Specoli rettali



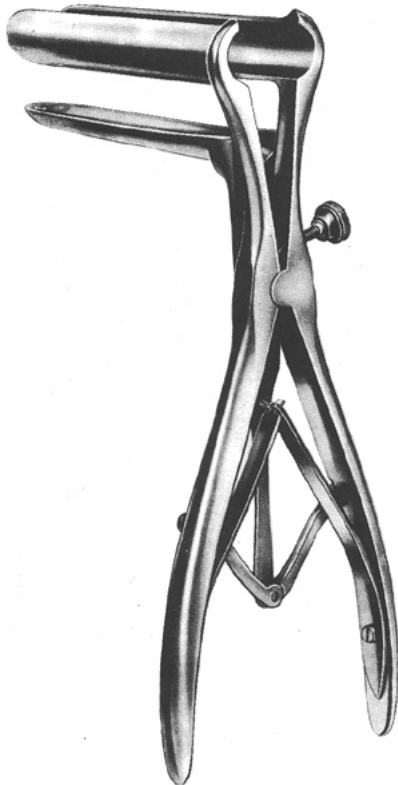
Sims gefenstert 15,0 cm
9380.15



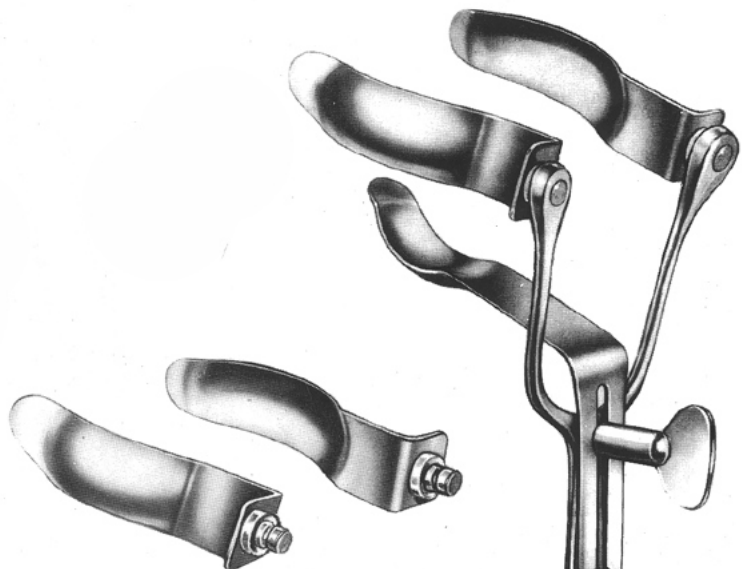
**Bodenhammer,
Valve voll**
9382.15 15 cm



Czerny 22,0 cm
9385.22



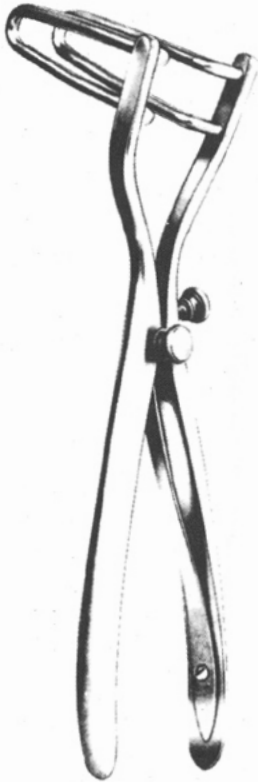
Mathieu 19,0 cm
9390.19



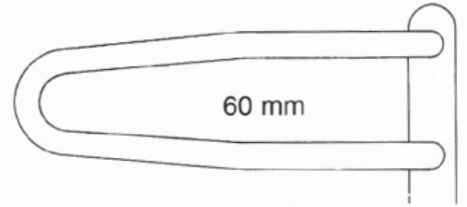
Mastdarm-Speizer
Anal Retractors
Dilatateurs p. anus et rectum
Separadores rectales
Dilatatori per l'ano e il retto

Allan Parks compl. 13,5 cm
9395.00

**MASTDARM-SPEKULA
RECTAL SPECULA
ESPÉCULOS RECTALES
SPECOLI RETTALI**

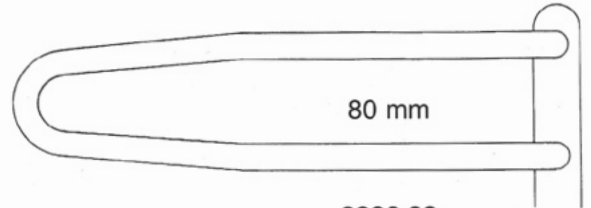


Schulze-Bergmann
9386.06 - 9386.12



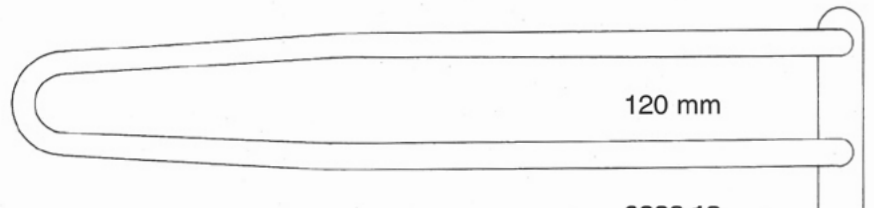
60 mm

9386.06



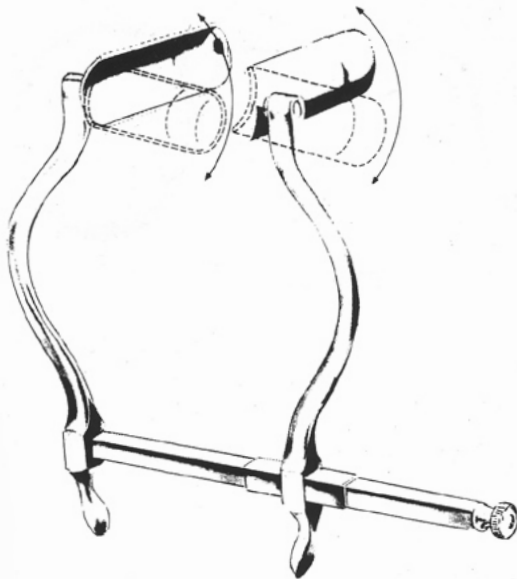
80 mm

9386.08

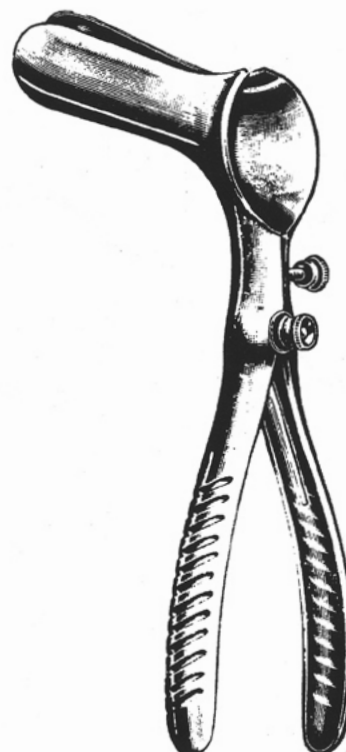


120 mm

9386.12



Smith-Buie
9387.15 15 cm
75x23 cm



Pratt
9388.19 19 cm



70x22 mm

Barr
9389.17 17 cm

MATTES

VASEKTOMIE-KLEMME
VASECTOMY FORCEPS
PINZA PARA VASECTOMIA
PINZA PER VASECTOMIA



3 mm

9394.14

MATTES

ANUSKOPE, PROKTOSKOPE, FISTELSONDE
 ANOSCOPES, PROCTOSCOPES, FISTULA PROBE
 ANOSCOPIOS, PROCTOSCOPIOS, SONDAS PARA FISTULAS
 ANOSCOPI, PROTOSCOPI, SONDE PER FISTOLE



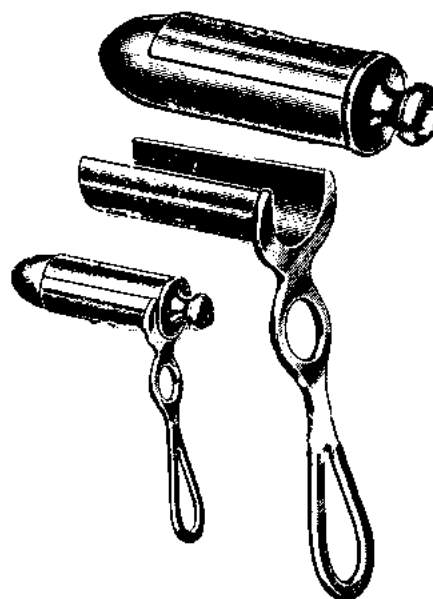
Ives-Fansler
 9397.22 22 mm Ø
 L=80 mm

Ø mm Hirschmann
 19 9402.19
 22 9402.22
 L=65 mm

mm	Kelly
ØxL	
22x 50	9400.05
22x100	9400.10
22x140	9400.14
22x200	9400.20



Ø mm Kelly
 21 9405.21
 27 9405.27
 L=50 mm



Ø mm Chelsea-Eaton
 22 x 65 9398.22
 30 x 65 9398.30

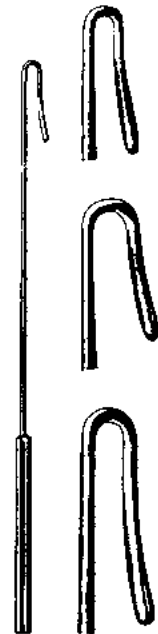


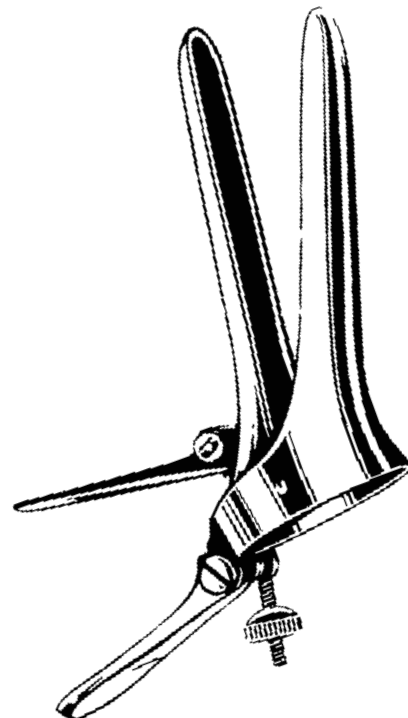
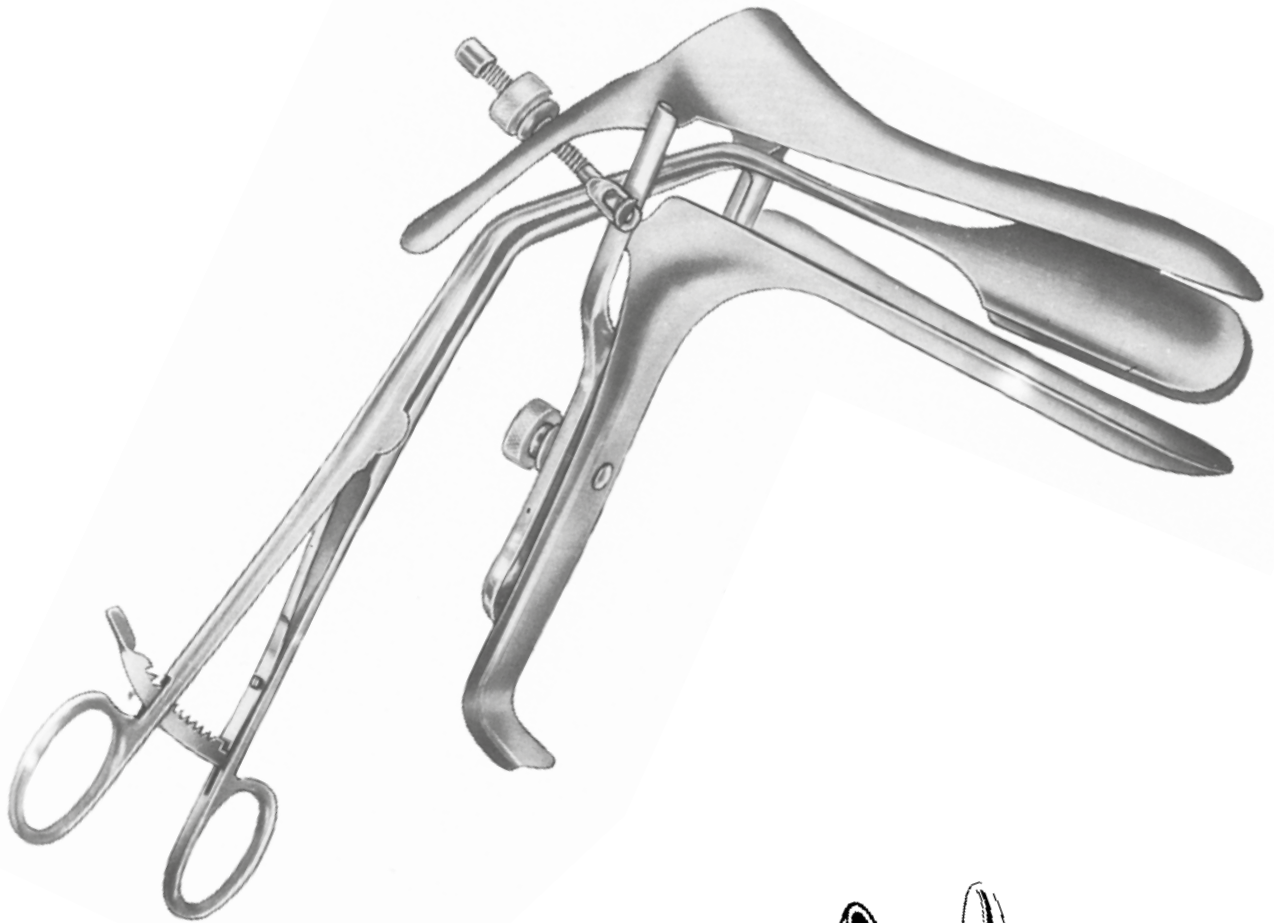
Fig. 1
 9399.01

Fig. 2
 9399.02

Fig. 3
 9399.03

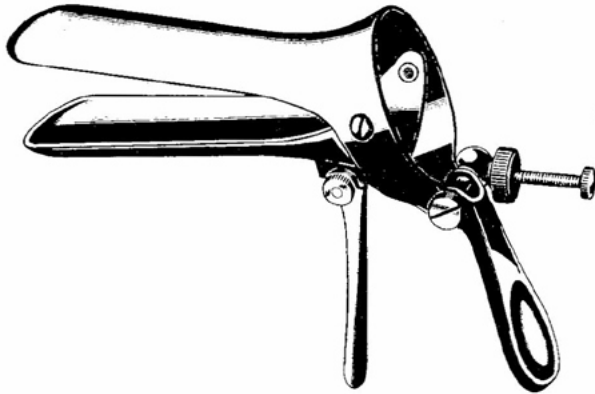
Pratt

GYNÄKOLOGIE
GYNECOLOGY
GYNÉCOLOGIE
GINECOLOGÍA
GINECOLOGIA

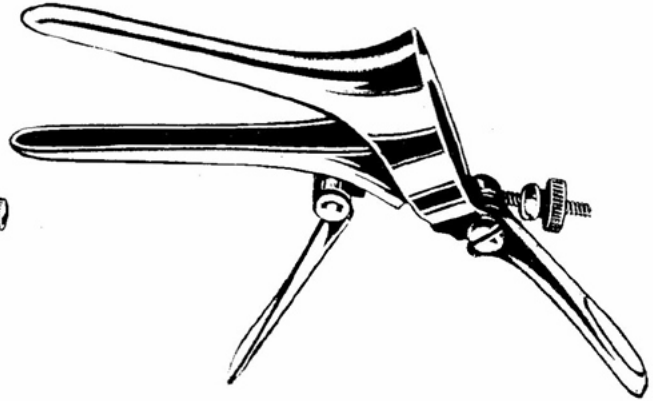


GYNÄKOLOGIE
GYNECOLOGY
GYNÉCOLOGIE
GINECOLOGÍA
GINECOLOGIA

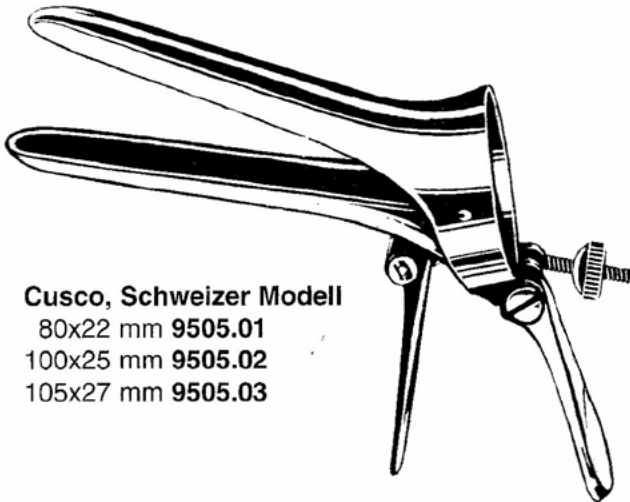
Scheiden-Spekula
Vaginal Specula
Spéculums vaginaux
Espéculos vaginales
Specoli vaginali



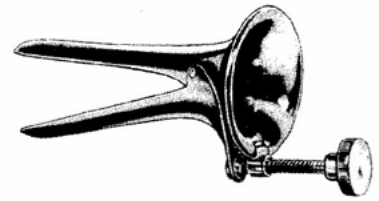
Cusco
75x32 mm 9500.01
85x35 mm 9500.02
100x35 mm 9500.03



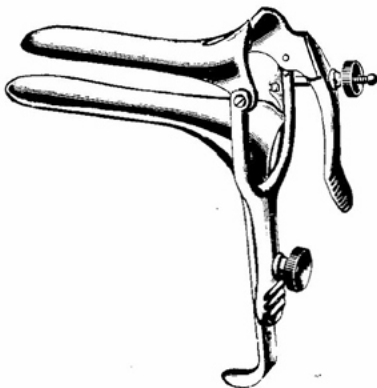
Jungfrauen-Cusco
85x17 mm 9501.00



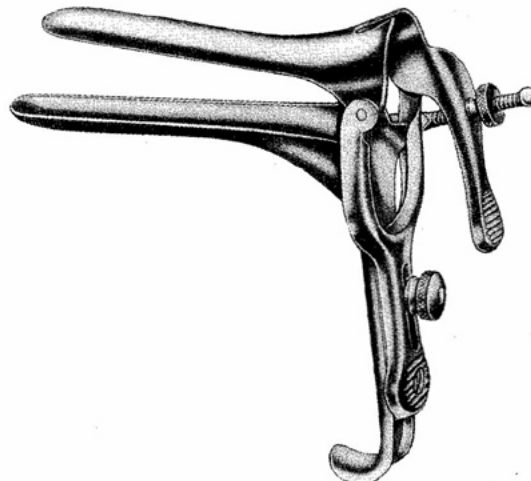
Cusco, Schweizer Modell
80x22 mm 9505.01
100x25 mm 9505.02
105x27 mm 9505.03



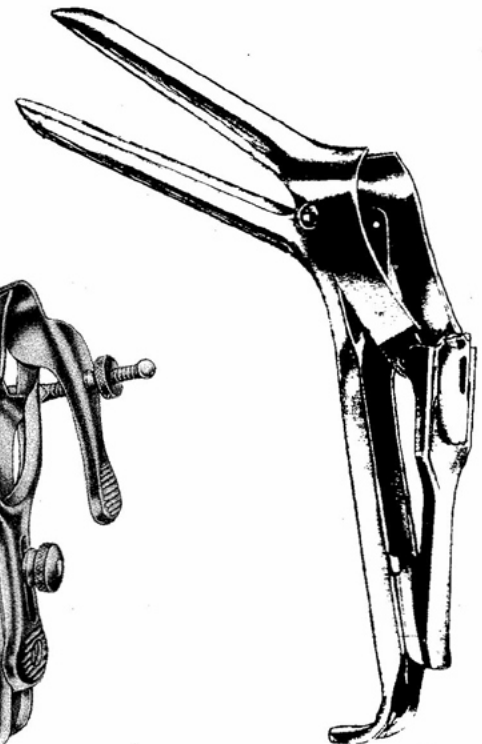
Collin 65x10 mm
9506.00



Grave
Fig. 1 75x20 mm 9507.01
Fig. 2 100x30 mm 9507.02
Fig. 3 120x35 mm 9507.03



Pederson
75x13 mm 9508.01
100x22 mm 9508.02
120x25 mm 9508.03



Semm
100x17/20 mm 9510.01
100x25/30 mm 9510.02

MATTES

GYNÄKOLOGIE
GYNECOLOGY
GYNÉCOLOGIE
GINECOLOGÍA
GINECOLOGIA

SCHEIDEN-SPEKULA
VAGINAL SPECULA
SPÉCULUMS VAGINAUX
ESPÉCULOS VAGINALES
SPECOLI VAGINALI

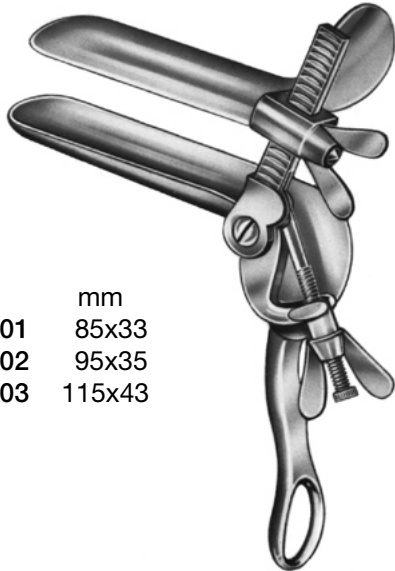
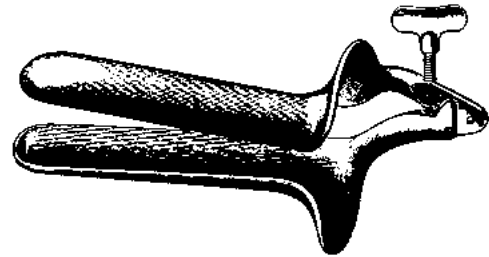


Fig.	Trélat	mm
1	9502.01	85x33
2	9502.02	95x35
3	9502.03	115x43



Collin
9503.00 - 9503.03

85 x 30 mm	9503.01
100 x 35 mm	9503.02
110 x 40 mm	9503.03

SCHEIDEN-SPEKULA
 VAGINAL SPECULA
 ESPÉCULOS VAGINALES
 SPECOLI VAGINALI

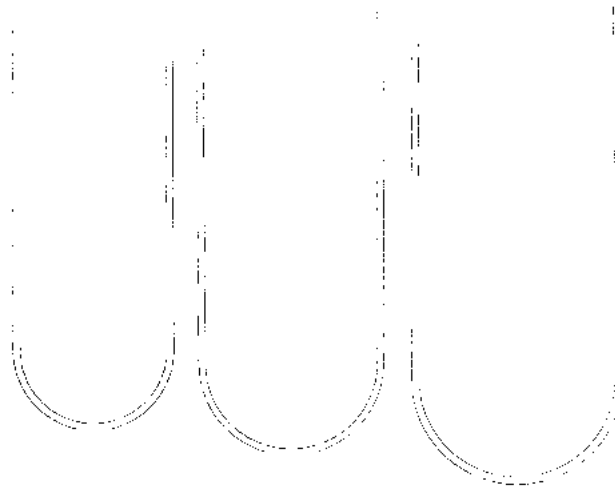


9515.01 - 9515.03

9515.01
 80 x 30 mm

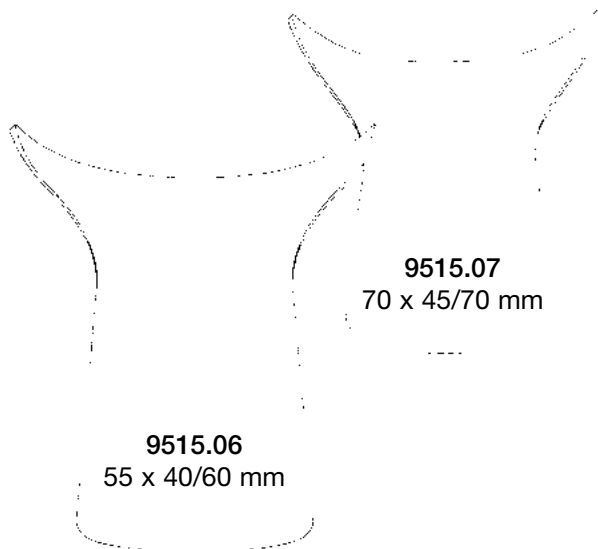
9515.02
 85 x 35 mm

9515.03
 90 x 40 mm



9515.04
 Gewicht 400 gr
 weight 400 grs
 pesa 400 grs
 peso 400 grs

9515.05
 Gewicht 800 gr
 weight 800 grs
 pasà 800 grs
 peso 800 grs



9515.06
 55 x 40/60 mm

9515.07
 70 x 45/70 mm

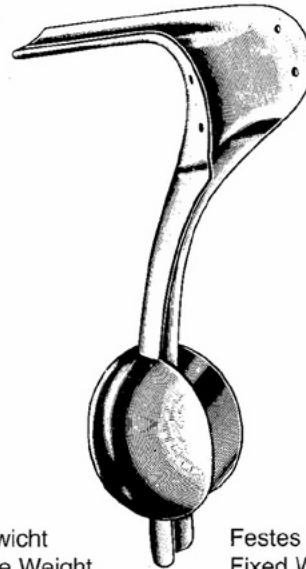
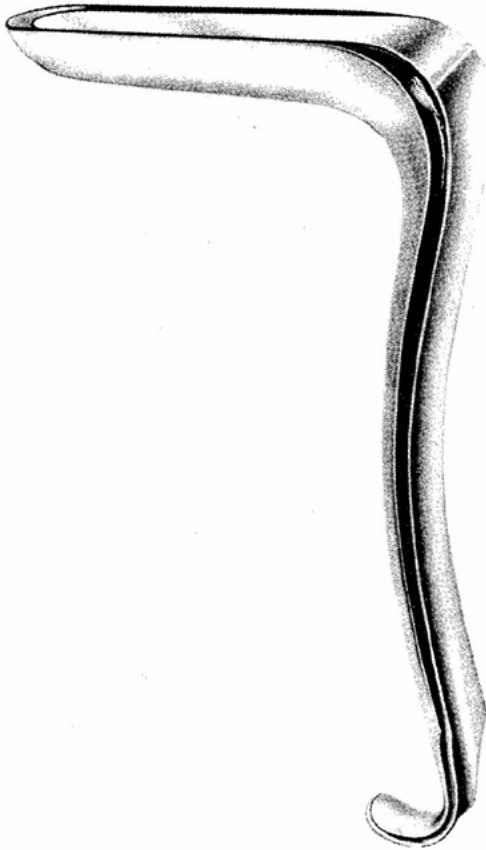
Scherbak
 9515.00
 Set komplett
 complete set
 juego completo
 set completo



9515.08
 Griff, handle,
 mango, manico

GYNÄKOLOGIE
 GYNECOLOGY
 GYNÉCOLOGIE
 GINECOLOGÍA
 GINECOLOGIA

Scheiden-Spekula
 Vaginal Specula
 Spéculums vaginaux
 Espéculos vaginales
 Specoli vaginali



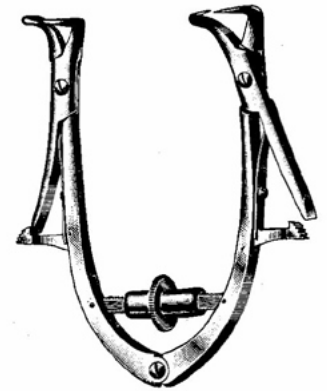
Loses Gewicht
 Detachable Weight
 Poids démontable
 Pesa desmontable
 Peso smontabile

Auvard

9540.00

Festes Gewicht
 Fixed Weight
 Poids fixe
 Pesa fija
 Peso fisso

9545.00



Friedmann 10,0 cm
 9547.10

Kristeller 9550.00 110x18 mm Fig. 00
 9550.10 110x21 mm Fig. 0
Satz - set - 9550.01 110x27 mm Fig. 1
 9550.02 110x30 mm Fig. 2
 9550.03 110x36 mm Fig. 3



Fig.	Sims	mm
1	9556.01	60x25+30
2	9556.02	70x30+35
3	9556.03	80x35+40
Set	9556.00	

MATTES

**GYNÄKOLOGIE
GYNECOLOGY
GYNÉCOLOGIE
GINECOLOGÍA
GINECOLOGIA**



mm **Landau**
100x28 9555.28
100x38 9555.38



mm **Breisky**
100x20 9557.20
100x25 9557.25
100x30 9557.30
100x35 9557.35
100x40 9557.40
130x20 9558.20
130x25 9558.25
130x30 9558.30

1 mm	9564.01	130x40	9558.40
2 mm	9564.02	155x40	9558.55
3 mm	9564.03		
4 mm	9564.04		
5 mm	9564.05		
6 mm	9564.06		
7 mm	9564.07		
8 mm	9564.08		
9 mm	9564.09		
10 mm	9564.10		
11 mm	9564.11		
12 mm	9564.12	1,5 mm	9565.01
13 mm	9564.13	2,5 mm	9565.02
14 mm	9564.14	3,5 mm	9565.03
15 mm	9564.15	4,5 mm	9565.04
16 mm	9564.16	5,5 mm	9565.05
17 mm	9564.17	6,5 mm	9565.06
18 mm	9564.18	7,5 mm	9565.07
19 mm	9564.19	8,5 mm	9565.08
20 mm	9564.20	9,5 mm	9565.09
21 mm	9564.21	10,5 mm	9565.10
22 mm	9564.22	11,5 mm	9565.11
23 mm	9564.23	12,5 mm	9565.12
24 mm	9564.24	13,5 mm	9565.13
25 mm	9564.25	14,5 mm	9565.14
26 mm	9564.26	15,5 mm	9565.15
27 mm	9564.27	16,5 mm	9565.16
28 mm	9564.28	17,5 mm	9565.17
29 mm	9564.29	18,5 mm	9565.18
30 mm	9564.30	19,5 mm	9565.19

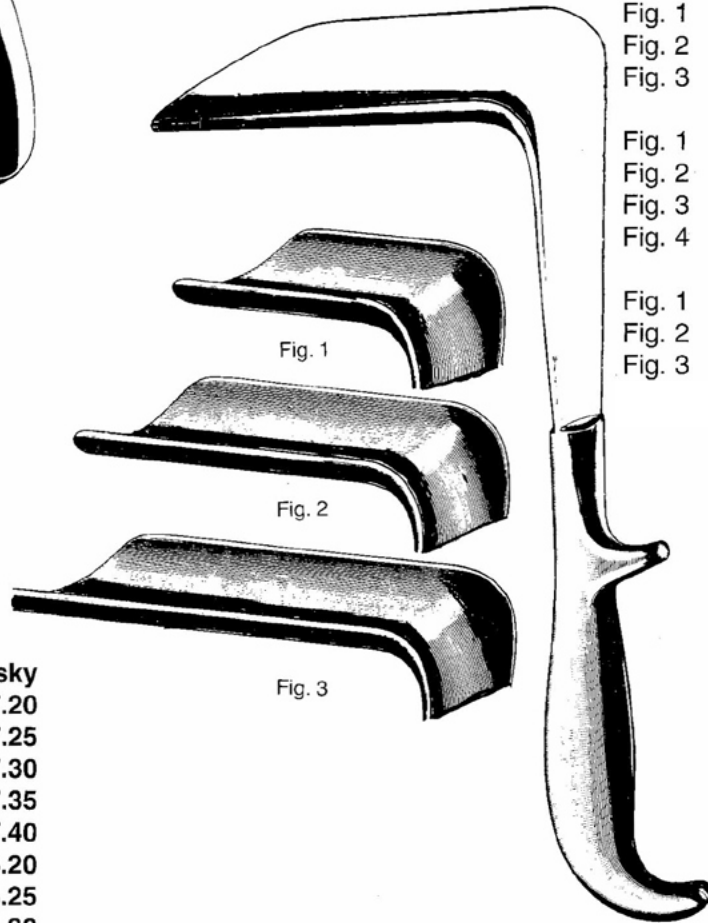


Fig. 1 55x35 mm 9559.01
Fig. 2 85x35 mm 9559.02
Fig. 3 115x35 mm 9559.03

Fig. 1 55x45 mm 9560.01
Fig. 2 85x45 mm 9560.02
Fig. 3 115x45 mm 9560.03
Fig. 4 160x45 mm 9560.04

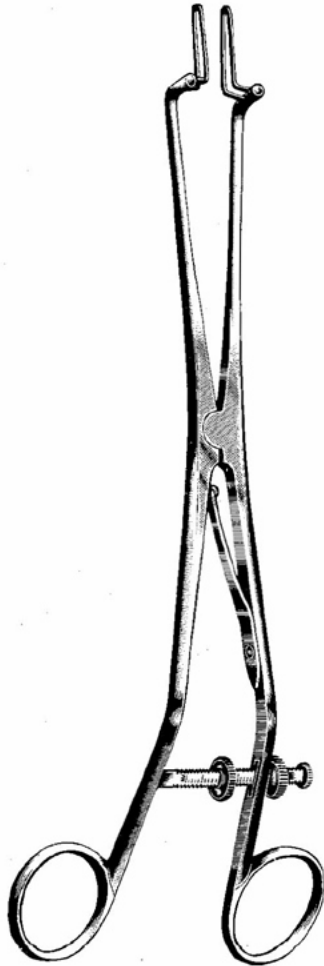
Fig. 1 55x60 mm 9561.01
Fig. 2 85x60 mm 9561.02
Fig. 3 115x60 mm 9561.03

Doyen
leichthohl - slightly concave

Uterus-Dilatatoren
Uterine Dilators
Dilatateurs utérins
Dilatadores uterinos
Dilatatori uterini

GYNÄKOLOGIE
GYNECOLOGY
GYNÉCOLOGIE
GINECOLOGÍA
GINECOLOGIA

Uterus-Sonden
Uterine Sounds
Hystéromètres
Histerómetros
Isterometri

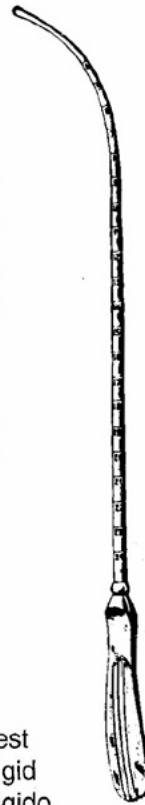


Kogan
9571.03 3 mm 24 cm
9571.04 4 mm 24 cm
9571.05 5 mm 24 cm



Hegar

- 1/2 mm 9572.01
- 3/4 mm 9572.03
- 5/6 mm 9572.05
- 7/8 mm 9572.07
- 9/10 mm 9572.09
- 11/12 mm 9572.11
- 13/14 mm 9572.13
- 15/16 mm 9572.15
- 17/18 mm 9572.17
- 19/20 mm 9572.19
- 21/22 mm 9572.21
- 23/24 mm 9572.23
- 25/26 mm 9572.25



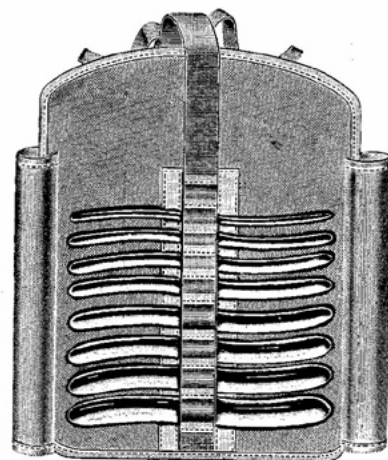
fest
rigid
rigido
rigida

Sims
32 cm

biegsam
malleable
maleable
malleabile

9577.32

Schlauchklemmen
Pinchcock Clamps
Press tubes
Porta tubes

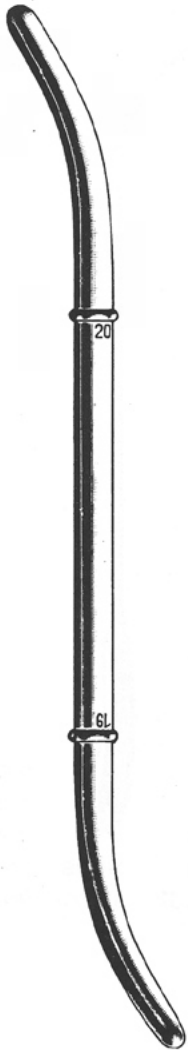


mm **Hegar**
3/4 - 17/18 **9584.08** 8 St./pces./pzas./pezzi

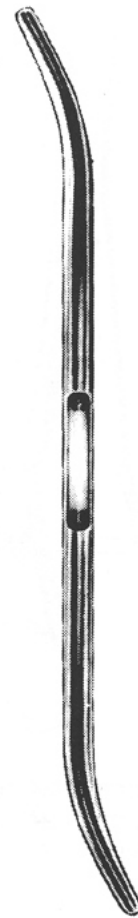
in Stofftasche, in khaki roll,
en bolsa de tela, in busta di tela

MATTES

UTERUS DILATATOREN
 UTERINE DILATORS
 DILATADORES UTERINOS
 DILATATORI UTERINI

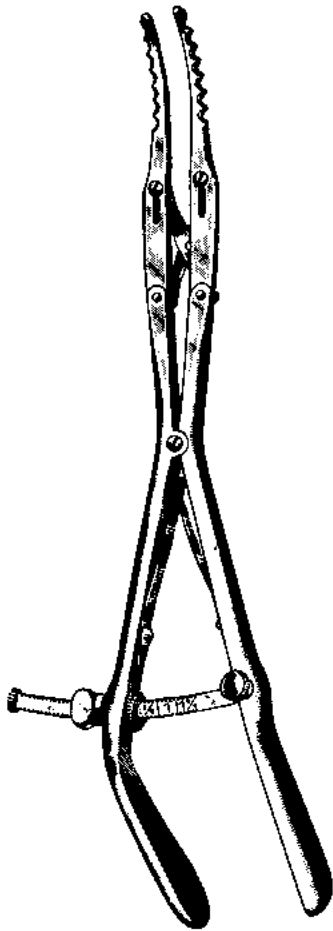


mm	Hank	Fig./U.S.
4,5/ 5	9586.10	9/10
5,5/ 6	9586.12	11/12
6,5/ 7	9586.14	13/14
7,5/ 8	9586.16	15/16
8,5/ 9	9586.18	17/18
9,5/10	9586.20	19/20

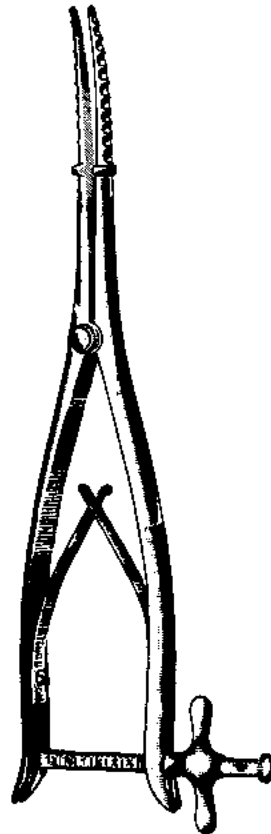


Pratt 9589.00		
Satz, Set, Juego, Set = 8		
	size	mm
9588.13	13-15	4,5/ 8,0
9588.17	17-19	5,6/ 6,3
9588.21	21-23	7,0/ 7,6
9588.25	25-27	8,3/ 9,0
9588.29	29-32	9,6/10,3
9588.33	33-35	11,0/11,6
9588.37	37-39	12,3/13,0
9588.41	41-43	13,6/14,3

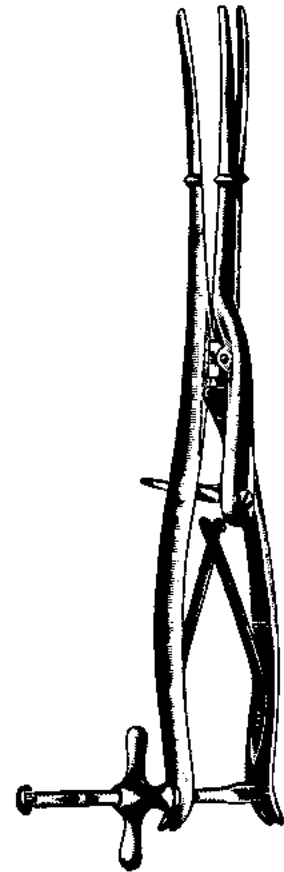
UTERUS DILATATOREN
 UTERINE DILATORS
 DILATADORES UTERINOS
 DILATATORI UTERINI



Goodell
 9591.34
 34 cm

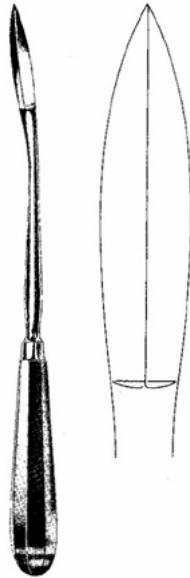


Wylie
 9593.29
 29 cm



Sims
 9595.29
 29 cm

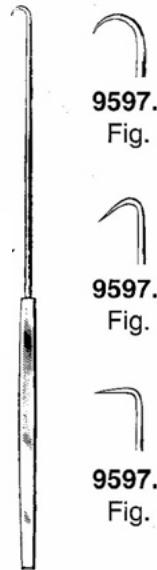
GYNÄKOLOGIE
GYNECOLOGY
GYNÉCOLOGIE
GINECOLOGÍA
GINECOLOGIA



Segond 27,0 cm
9592.27

Myomesser
Myoma Knife
Bistouri à fibromes
Bisturí para fibromas
Busturi per fibromi

Fistelhäkchen
Fistula Hook



9597.01
Fig. 1

9597.02
Fig. 2

9597.03
Fig. 3

Emmet
22 cm



9598.40
ohne Korb
without basket
sin cesto
senza cestino



9599.40
mit Korb
with basket
con cesto
con cestino



Kevorkian
4,0 mm
30 cm

MATTES

GYNÄKOLOGIE
GYNECOLOGY
GYNÉCOLOGIE
GINECOLOGÍA
GINECOLOGIA

Beckenzirkel
Pelvimeters
Compas pelvimètres
Pelvimetros
Pelvimetri



Martin
33,0 cm 9600.33



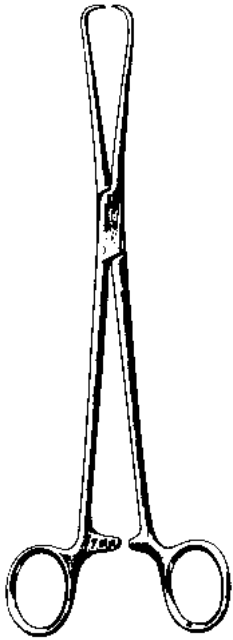
Collin
33,0 cm 9602.33

scharf/stumpf
sharp/blunt
cortante/roma
tagliente/smussa

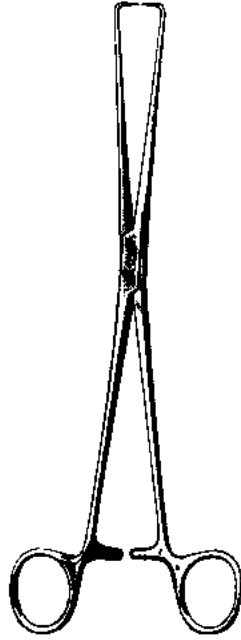


Blake
9614.27 27 cm

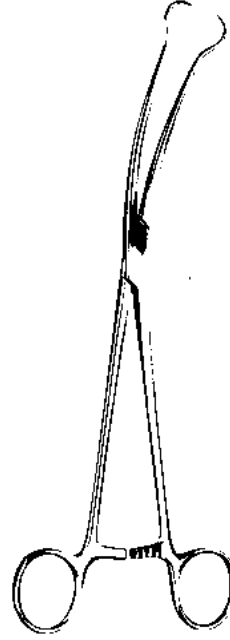
HAKENZANGEN
 TENACULUM FORCEPS
 PINZAS PARA COGER EL CUELLO DEL ÚTERO
 PINZE PER ABBASSARE IL COLLO DELL'UTERO



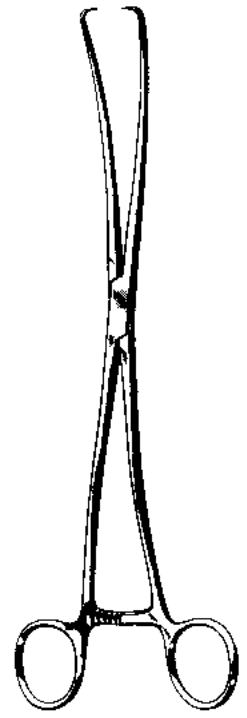
Schröder (Pozzi)
 6180.24 24 cm



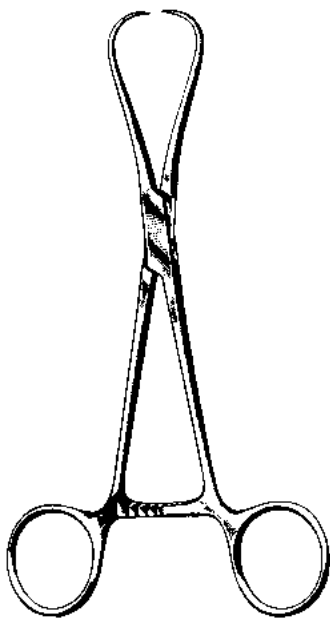
Braun
 6181.25 25 cm



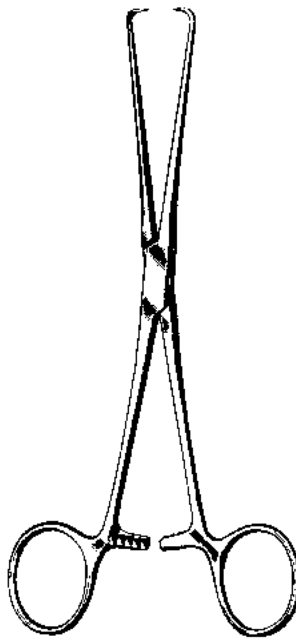
Skene
 6171.24 24 cm



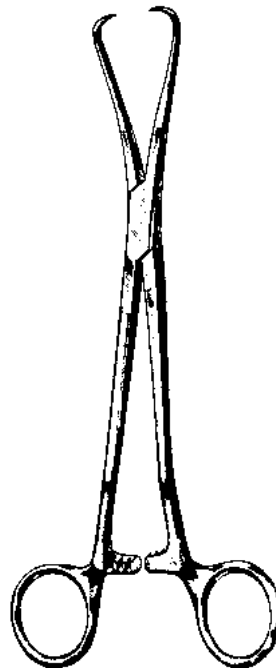
Duplay
 6170.28 28 cm



Staude-Moore
 6182.17 17 cm



Barrett
 6183.18 18 cm



Jarcho
 6184.20 20 cm

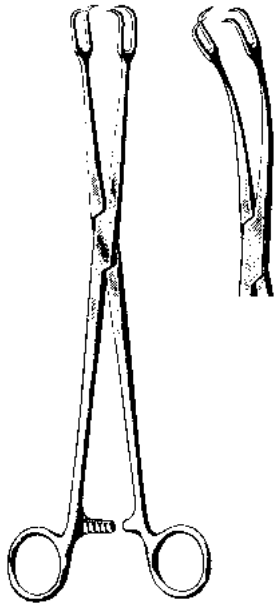
MATTES

HAKENZANGEN

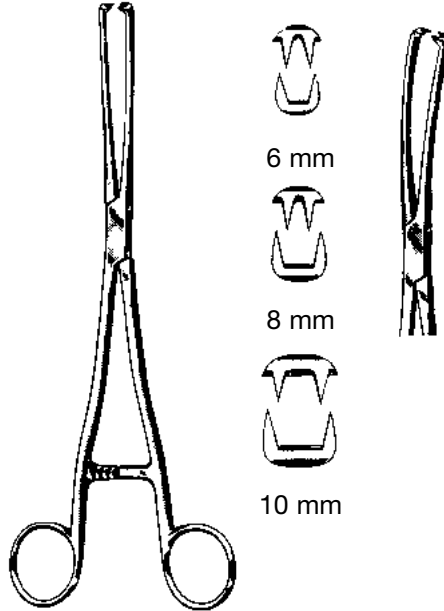
TENACULUM FORCEPS

PINZAS PARA COGER EL CUELLO DEL ÚTERO

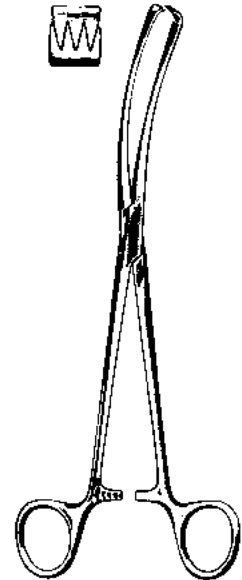
PINZE PER ABBASSARE IL COLLO DELL'UTERO



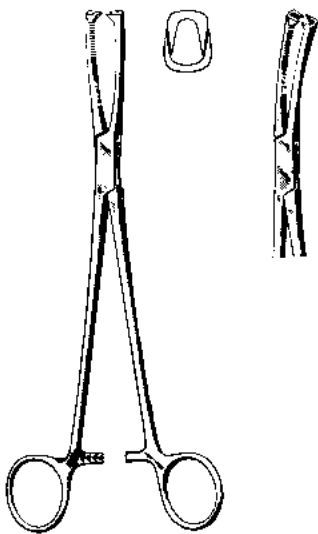
Schroeder
6185.24 24 cm 6186.24



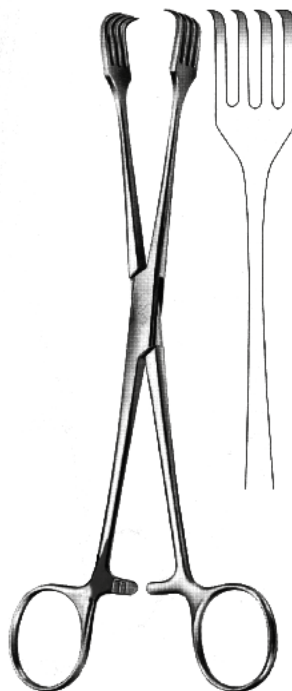
Museux
6187.06 6 mm 6188.06
6187.08 8 mm 6188.08
6187.10 10 mm 6188.10
24 cm



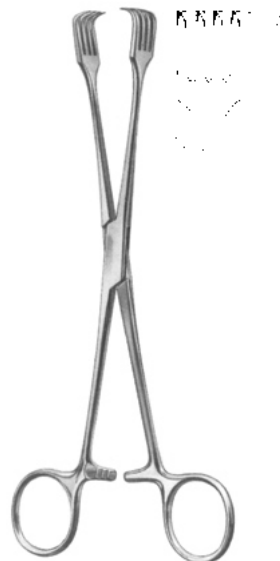
Teale
6190.23 23 cm



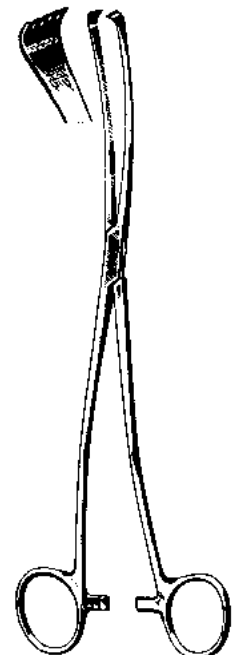
Jacobs
6264.21 21 cm 6265.21



Pratt
6280.28 28 cm

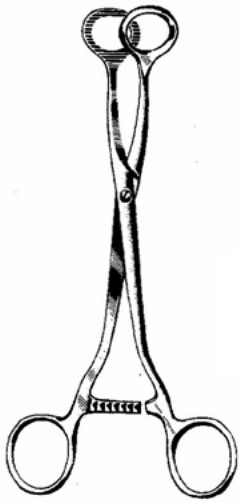


Czerny
6266.21 20 cm

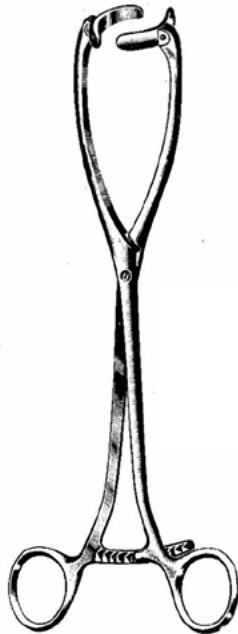


Iova
6267.26 26 cm

GYNÄKOLOGIE - UTERUS-FABZANGEN
 GYNECOLOGY - UTERINE ELEVATING FORCEPS
 GYNÉCOLOGIE - PINCES HYSTÉROLABES
 GINECOLOGÍA - PINZAS PARA EL ÚTERO
 GINECOLOGIA - PINZE PER AFFERRARE L'UTERO



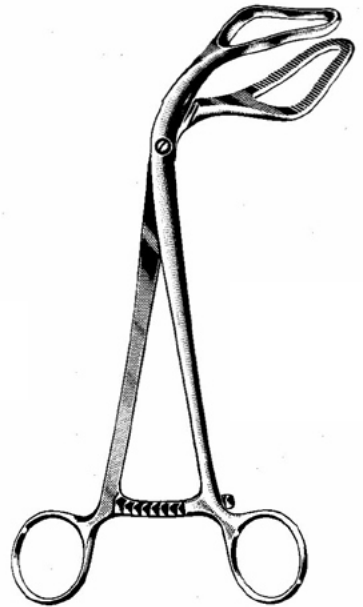
Doyen
 6282.20 20 cm



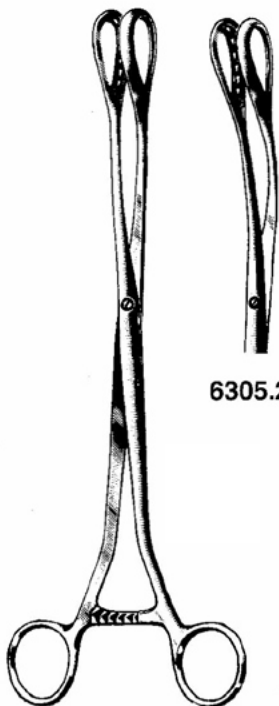
Collin
 25,0 cm/10"
 6285.25



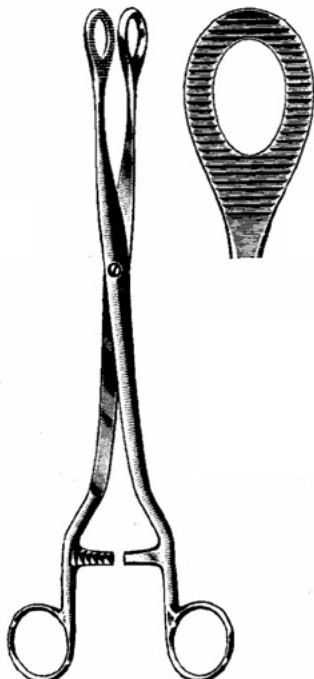
Dartiques
 27,0 cm
 6290.27



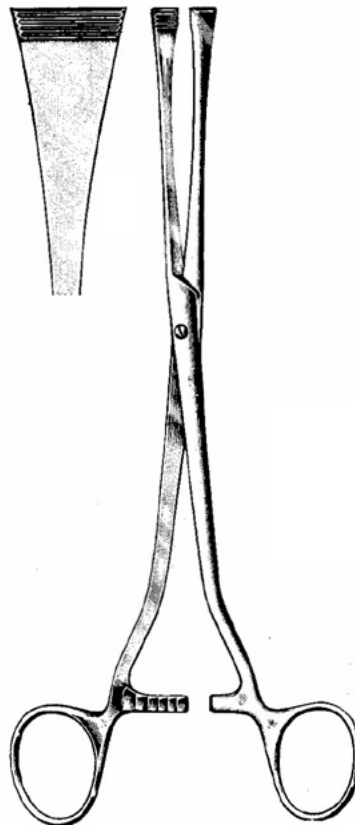
Sommer
 23,0 cm
 6295.23



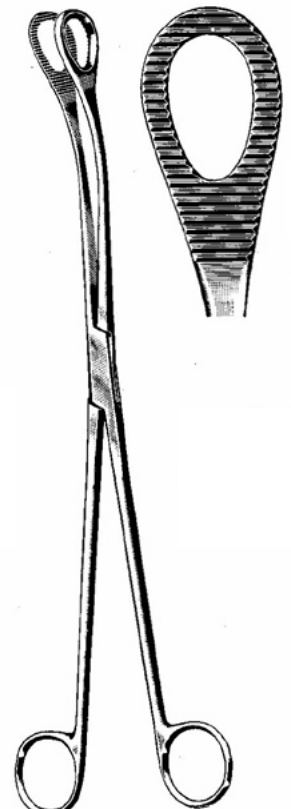
Säger
 27,0 cm/11"
 6300.27



Noto
 6302.27 27 cm



Green Armytage
 21,0 cm
 6306.21



Kelly
 32,0 cm
 6307.32

MATTES

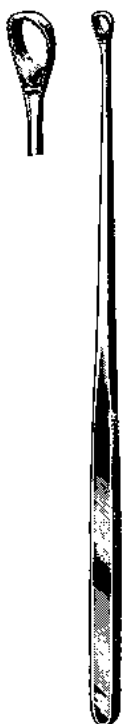
AMNIOTOM, UTERUS DEPRESSOREN, UTERUS-SONDEN
 AMNIOTOME, UTERINE DEPRESSORS, UTERINE SOUNDS
 AMNIÓTOMO, DEPRESORES UTERINOS, HISTERÓMETROS
 AMNIOTOMO, DEPRESSORI UTERINI, ISTEROMETRI



Braun
9616.28 28 cm



Sims
9617.26 26 cm



Heany
9618.00 22,5 cm



Collin
9621.28 28 cm



Valleix
9622.25 25 cm

MATTES

UTERUS-KÜRETTEN UTERINE CURETTES CURETAS UTERINAS CURETTE UTERINE



Sims
28 cm

	scharf sharp cort. tagl.	Fig.	mm	stumpf blunt roma smussa
fest	9645.99	00	5,0	9646.99
rig.	9645.00	0	6,0	9646.00
	9645.01	1	7,5	9646.01
	9645.02	2	8,5	9646.02
	9645.03	3	10,0	9646.03
	9645.04	4	11,5	9646.04
	9645.05	5	13,5	9646.05
	9645.06	6	14,5	9646.06

flexibel	9640.99	00	5,0	9641.99
flexible	9640.00	0	6,0	9641.00
fless.	9640.01	1	7,5	9641.01
	9640.02	2	8,5	9641.02
	9640.03	3	10,0	9641.03
	9640.04	4	11,5	9641.04
	9640.05	5	13,5	9641.05
	9640.06	6	14,5	9641.06



Recamier
31 cm

	scharf sharp cort. tagl.	Fig.	mm	stumpf blunt roma smussa
fest	9637.99	00	5,0	9638.99
rig.	9637.00	0	6,0	
	9637.01	1	7,0	9638.01
	9637.02	2	8,0	9638.02
	9637.03	3	9,0	9638.03
	9637.04	4	11,0	9638.04
	9637.05	5	12,0	9638.05
	9637.06	6	14,0	9638.06
	9637.07	7	15,0	9638.07
	9637.08	8	16,0	9638.08
	9637.09	9	19,0	9638.09
	9637.10	10	20,0	9638.10

flexibel	9635.99	00	5,0	9636.99
flexible	9635.00	0	6,0	9636.00
fless.	9635.01	1	7,0	9636.01
	9635.02	2	8,0	9636.02
	9635.03	3	9,0	9636.03
	9635.04	4	11,0	9636.04
	9635.05	5	12,0	9636.05
	9635.06	6	14,0	9636.06
	9635.07	7	15,0	9636.07
	9635.08	8	16,0	9636.08
	9635.09	9	19,0	9636.09
	9635.10	10	20,0	9636.10



Bumm
34 cm

	scharf sharp cort. tagl.	Fig.	stumpf blunt roma smussa
fest	9639.30	14	9647.30
rig.	9639.35	15	9647.35
	9639.40	16	9647.40

flexibel	9648.30	14	9649.30
flexible	9648.35	15	9649.35
		16	9649.40

UTERUS-KÜRETTEN
 UTERINE CURETTES
 CURETAS UTERINAS
 CURETTE UTERINE

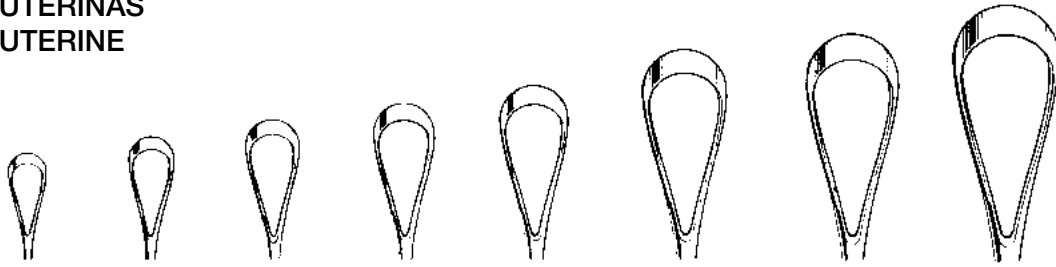


Fig.	00	0	1	2	3	4	5	6
mm	5	6	7	8	9	11	12	14

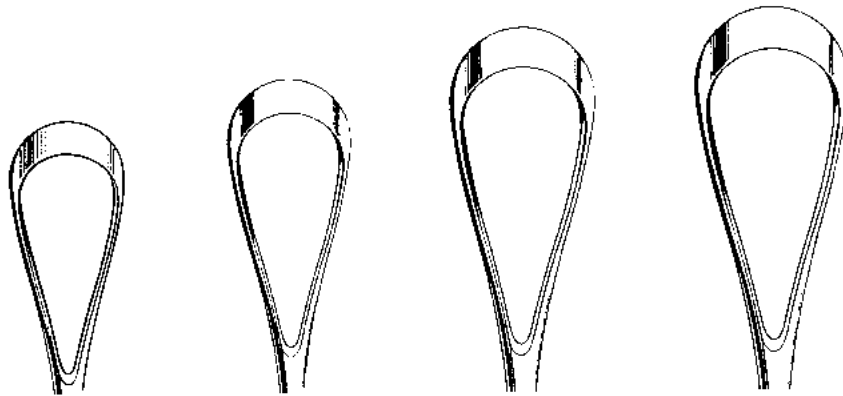


Fig.	7	8	9	10
mm	15	16	19	20

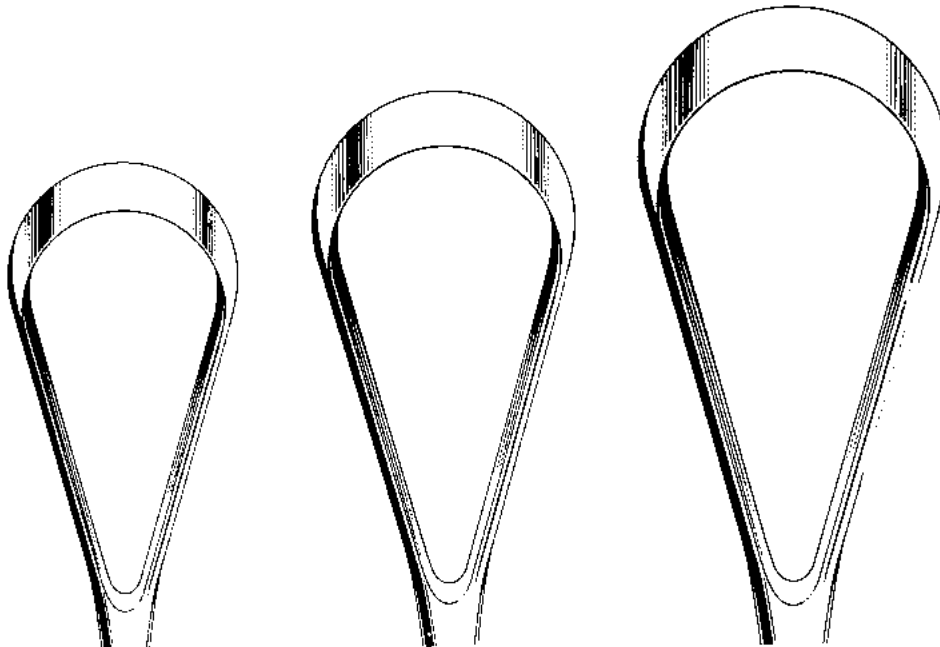


Fig.	14	15	16
mm	30	35	40

Sims
 Recamier
 Bumm
 9635.99 - 9649.40

MATTES

UTERUS-KÜRETTEN
 UTERINE CURETTES
 CURETAS UTERINAS
 CURETTE UTERINE



Thomas
28 cm

stumpf
 blunt
 roma
 smussa



Fig.1

7 mm
9642.01

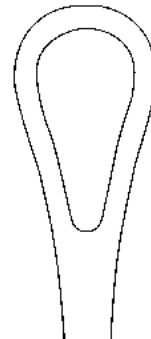


Fig.2

8 mm
9642.02



Fig.3

9 mm
9642.03

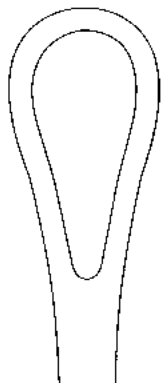


Fig. 4

10 mm
9642.04

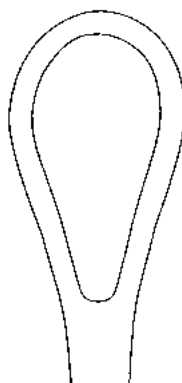


Fig. 5

11 mm
9642.05

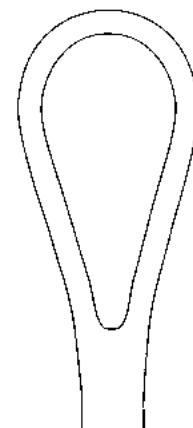


Fig. 6

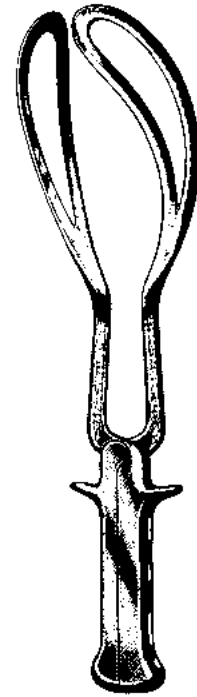
12 mm
9642.06

MATTES

GEBURTSZANGEN
OBSTETRICAL FORCEPS
FORCEPS OBSTÉTRICOS

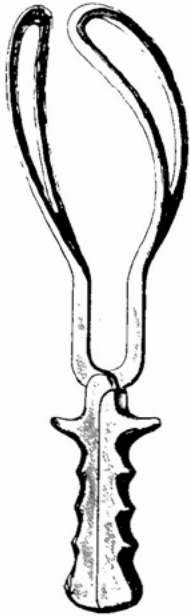


McLean-Luikart
9652.39 39 cm



De Lee
9654.36 36 cm
9654.39 39 cm

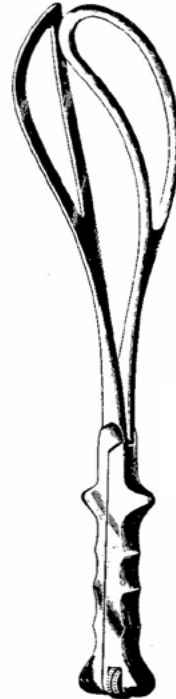
GYNÄKOLOGIE
 GYNECOLOGY
 GYNÉCOLOGIE
 GINECOLOGÍA
 GINECOLOGIA



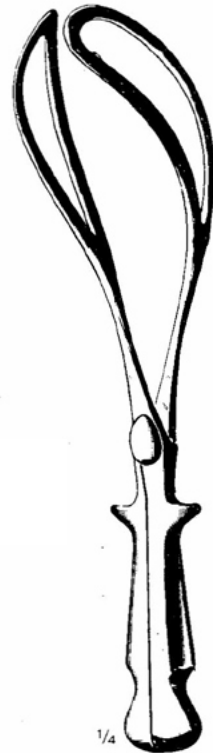
Simpson-Braun
 36,0 cm/14¹/₄" 9650.36



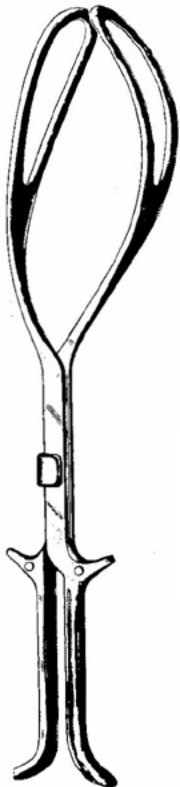
Simpson
 30,0 cm/12" 9655.30



Elliot
 32,0 cm/12³/₄" 9660.32
 38,0 cm/15¹/₄" 9660.38



Naegele
 36,0 cm/14" 9665.36
 40,0 cm/16" 9665.40



Kieland
 41,0 cm/16" 9670.41



Kieland-Luikart
 40,0 cm/16" 9675.40



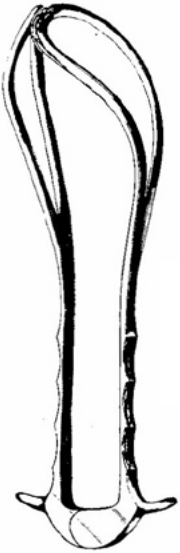
Luikart
 40,0 cm/16" 9680.40



Simpson-Luikart
 36,0 cm/14" 9685.36

MATTES

GYNÄKOLOGIE
GYNECOLOGY
GYNÉCOLOGIE
GINECOLOGÍA
GINECOLOGIA



Boerma
29,0 cm/11 $\frac{1}{2}$ " 9690.29



Barton
36,0 cm/14" 9695.36



Mc Lean
36,0 cm/14" 9700.36



Piper
44,0 cm/18" 9705.44

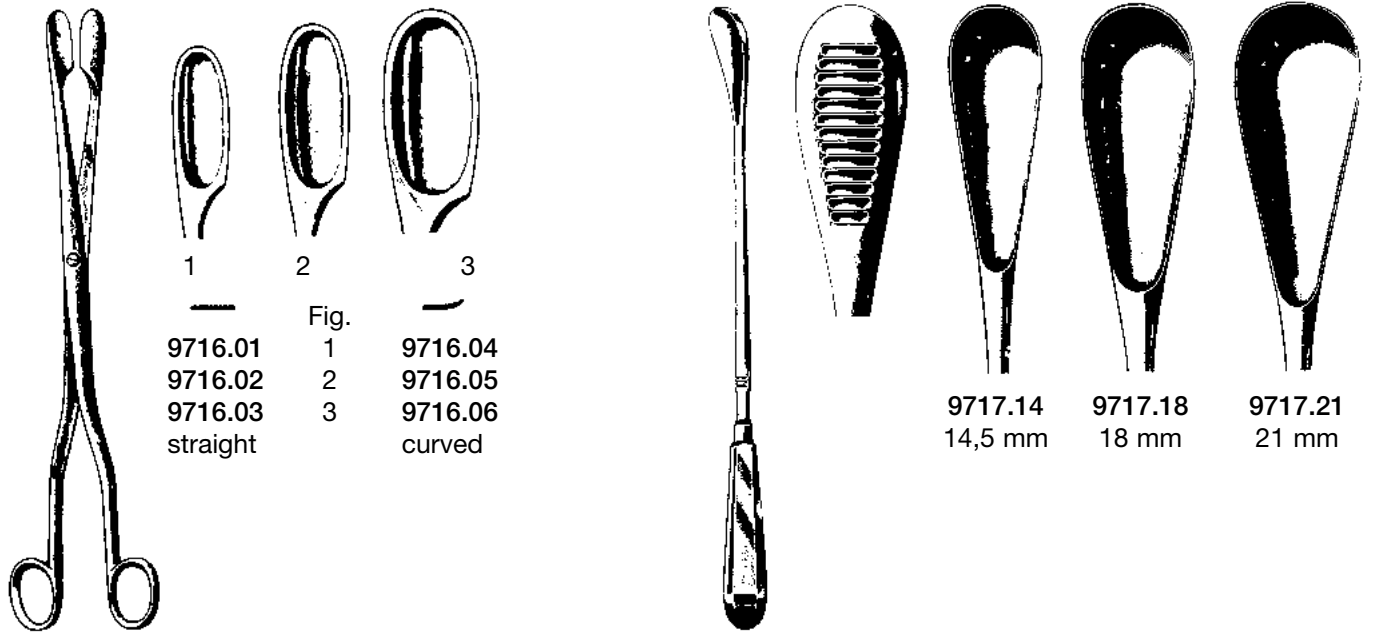


Mc Lean-Tucker
39,0 cm/16" 9710.39



Mc Lean-Tucker-Luikart
40,0 cm/16" 9715.40

ABORTUSZANGEN, ABORTUSLÖFFEL
 OVUM FORCEPS, ABORTION SCOOPS
 PINZAS PARA ABORTO, CUCHARILLAS PARA ABORTO
 OSTETRICIA, CURETTE PER ABORTO



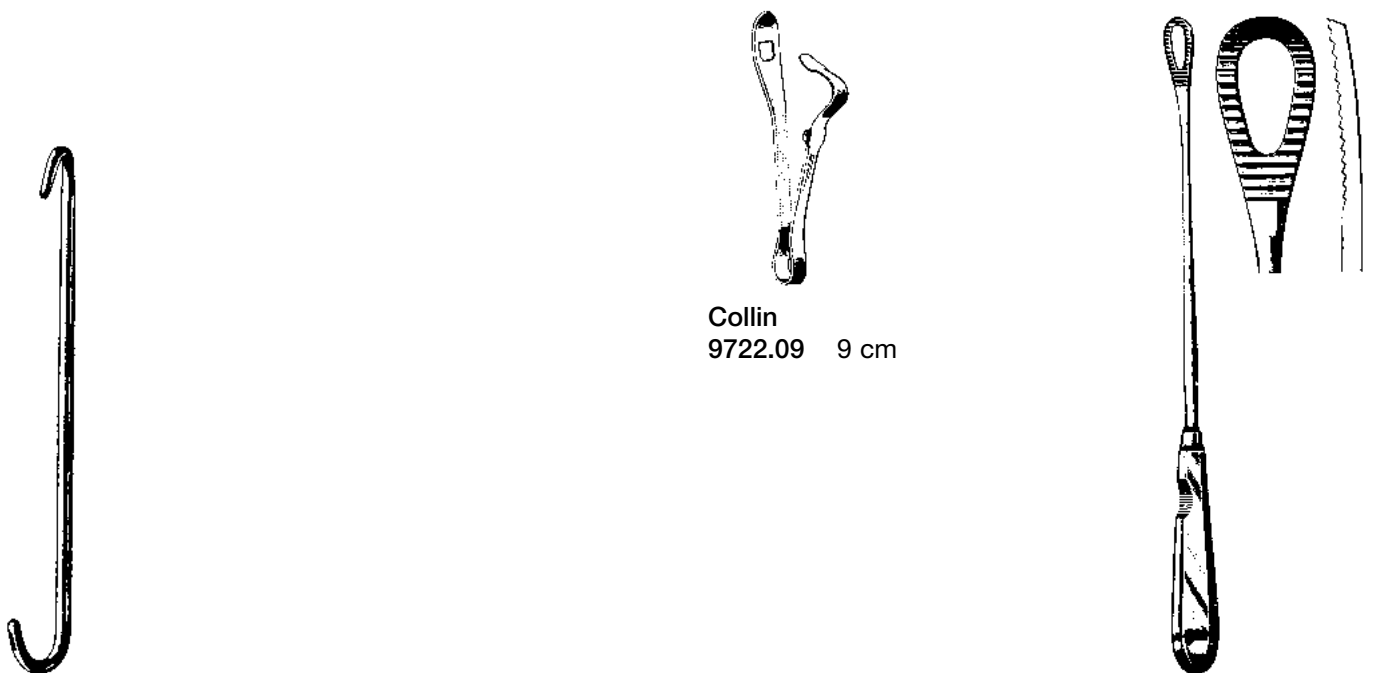
1	Fig.	3
9716.01	1	9716.04
9716.02	2	9716.05
9716.03	3	9716.06
straight		curved

Winter
 9716.01 - 9716.06
 28 cm

Cuzzi
 30 cm

9717.14	9717.18	9717.21
14,5 mm	18 mm	21 mm

HAKEN, KOPFSCHWARTENZANGEN, UTERUS-KLEMMZANGE, NABELSCHNURKLEMMEN
 SCALP FLAP FORCEPS, UTERINE HAEMOSTATIC FORCEPS, UMBILICAL CORD CLAMPS
 PINZAS PARA CUERO CABELLUDO, PINZAS-CLAMPS UTERINAS PARA HEMÓSTASIS, CLAMP UMBILICAL
 PINZA PER IL CUIO CAPELLUTO, PINZA UTERINE, PINZA OMBELICALE



Collin
 9722.09 9 cm

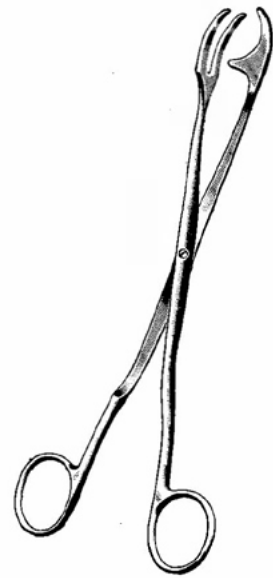
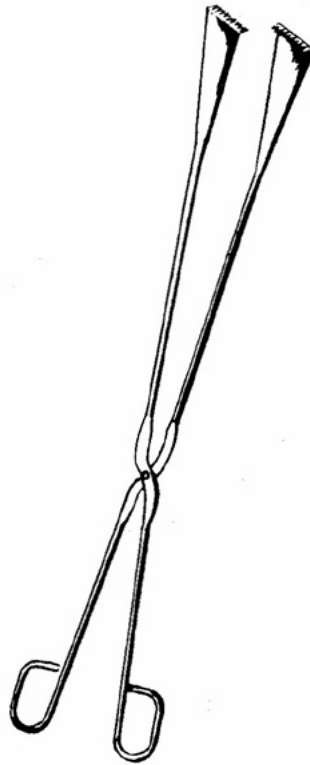
Smellie
 9719.33 33 cm

Pestaloza
 9718.30 30 cm

DERMATOLOGIE
DERMATOLOGY
DERMATOLOGIE
DERMATOLOGÍA
DERMATOLOGIA

STERILISATIONS
STERILIZATIONS
STERILIZZAZIONE

HYGIENE
HYGIENE
HYGIÈNE
HIGIENE
IGIENE



MATTES

DERMATOLOGIE
 DERMATOLOGY
 DERMATOLOGIE
 DERMATOLOGÍA
 DERMATOLOGIA



Saalfeld
 10,0 cm
 9730.10



Schamberg
 10,0 cm
 9732.10



Unna
 14,0 cm
 9737.14

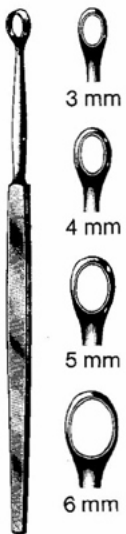


Walton
 14,0 cm
 9739.14



Kilner
 15,0 cm
 9740.15

Lupus-Curette



mm	Fox
3	9742.03
4	9742.04
5	9742.05
6	9742.06

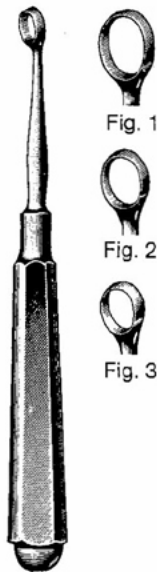
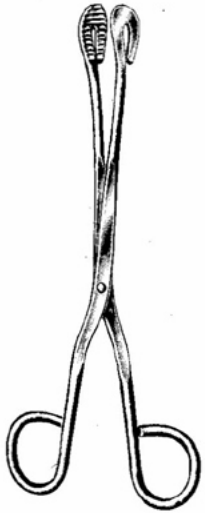
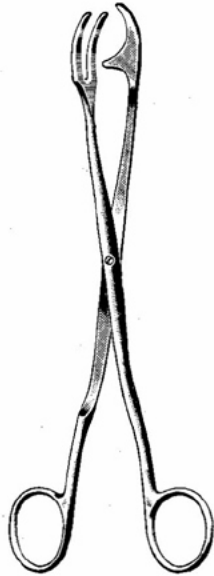


Fig.	Piffard
1	9743.01
2	9743.02
3	9743.03

STERILISATIONS INSTRUMENTE
 STERILIZATIONS-INSTRUMENTS
 STRUMENTI PER LA STERILIZZAZIONE



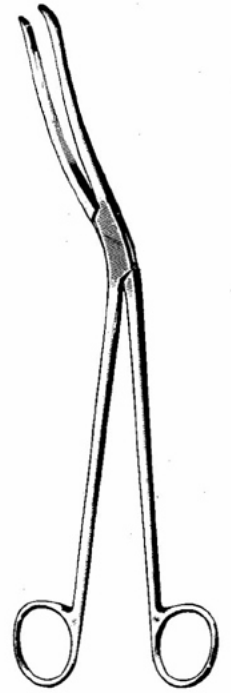
Universal 20,0 u. 28,0 cm
 9750.20 9755.20
 9750.28 9755.28
 gerade gebogen
 straight curved



Rogge 23,0 cm
 9752.23



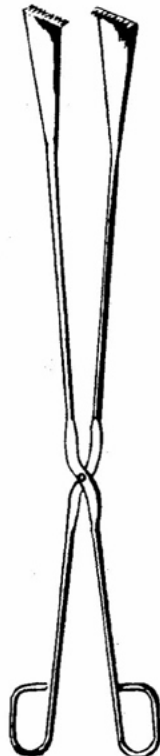
cm	Davis
16	2095.16
20	2095.20
24	2095.24



Cheatle 27,0 cm
 9755.27



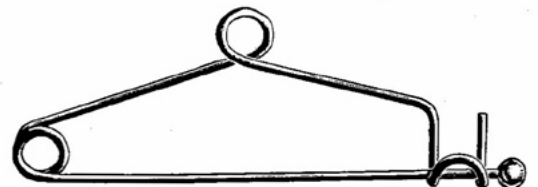
cm	
20	9760.20
30	9760.30



Sauerbruch
 9761.55 55 cm



Bunt 12,0 cm
 9757.12



Mayo 14,0 cm
 9758.14

MATTES

HYGIENE
HYGIENE
HYGIÈNE
HIGIENE
IGIENE



cm **Saphir**
12 9765.12
17 9765.17



12,0 cm
9767.12



10,0 cm
9768.10 gerade
9769.10 gebogen



14,5 cm
9770.14



13,0 cm
9772.13



Turnbull
14,0 cm
9775.14



Kopfschneider
14,0 cm
9780.14

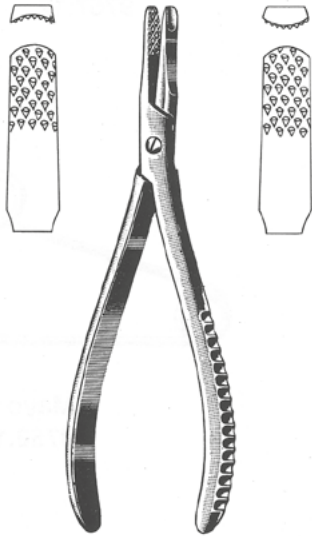


9783.12



Schwesternset
9790.00 komplett

HYGIENE
HYGIENE
HYGIÈNE
HIGIENE
IGIENE



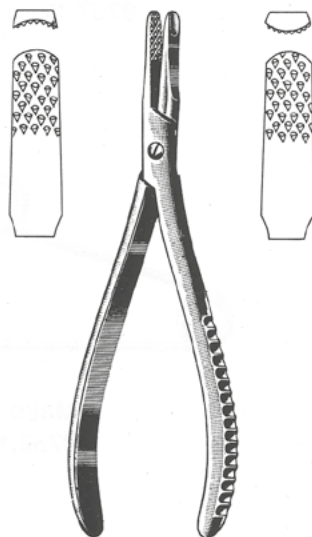
Radolf 14,0 cm
9784.14



Fingerringsäge
9785.17



Feldheim
9793.10 10 cm



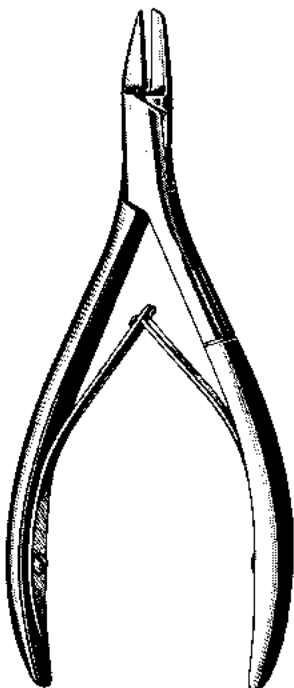
Radolf 13,5 cm
9784.14



Fingerringsäge
9785.17

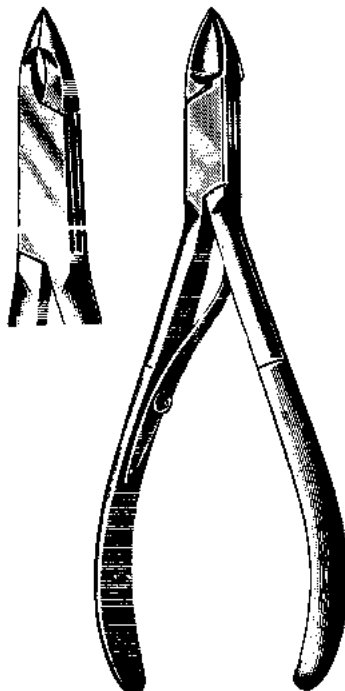
NAGELZANGEN
 NAIL NIPPERS
 ALICATES CORTA-UÑAS
 TRONCHESINI PER UNGHIE

stainless steel



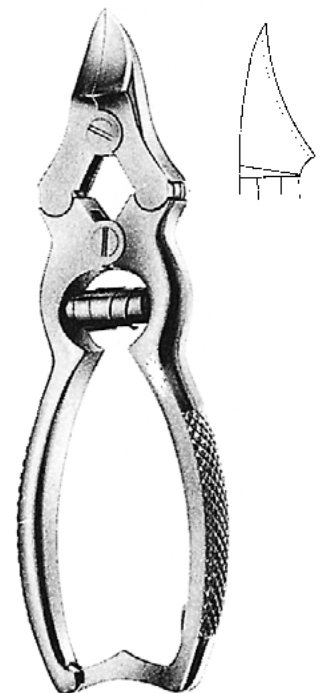
Anvil
 9794.13 13 cm

stainless steel



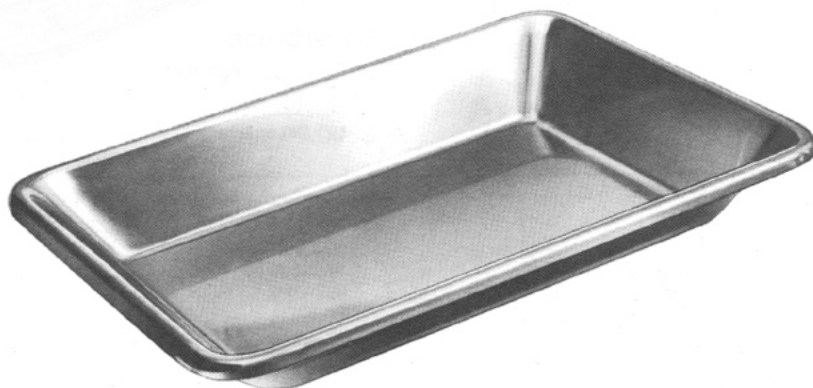
9795.10
 10 cm

stainless steel



9796.15
 15,5 cm

VERSCHIEDENE BEHÄLTER
DIFFERENT CONTAINERS
BOÎTES DIVERSES
CONTENEDORES VARIOS
VASSOI DIVERSI



MATTES

VERSCHIEDENE BEHÄLTER
DIFFERENT CONTAINERS
BOÎTES DIVERSES
CONTENEDORES VARIOS
VASSOI DIVERSI

18/10

Edelstahl rostfrei
Stainless Steel
Acier inoxydable
Acero inoxidable
Acciaio inossidabile



65x15 mm
9802.65



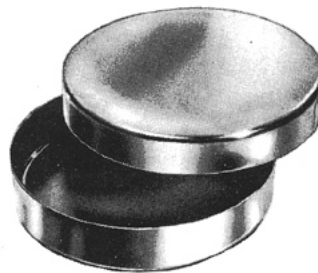
Innendose allein
9804.55



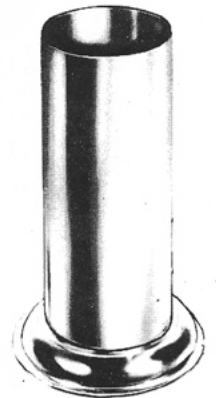
150x95x13 mm 7-teilig
9806.07

VERSCHIEDENE BEHÄLTER
DIFFERENT CONTAINERS
BOÎTES DIVERSES
CONTENEDORES VARIOS
VASSOI DIVERSI

18/10
Edelstahl rostfrei
Stainless Steel
Acier inoxydable
Acero inoxidable
Acciaio inossidabile

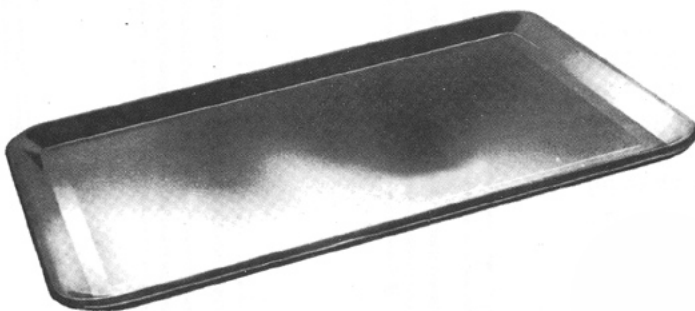


100x20 mm
9822.10



mm	Standzylinder
30x90	9825.01
50x100	9825.02
50x130	9825.03
50x175	9825.04*
75x100	9825.05
75x130	9825.06
75x175	9825.07
100x175	9825.08
100x200	9825.09

* Standard



9830.21

l x b x h
210 x 160 x 10 mm



9835.23

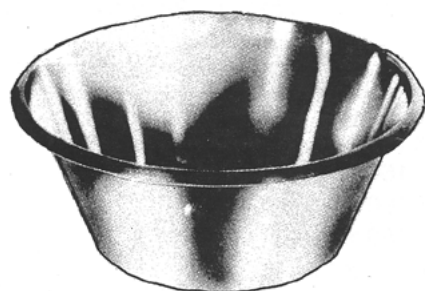
l x b x h
230 x 155 x 30 mm

MATTES

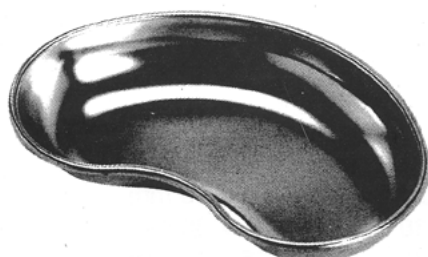
VERSCHIEDENE BEHÄLTER
DIFFERENT CONTAINERS
BOÎTES DIVERSES
CONTENEDORES VARIOS
VASSOI DIVERSI



Abmessungen sizes in mm Tamaños en mm misura in mm Ø x h	Inhalt capacity capacidad cabida l	
40 x 19	0,05	9842.04
61 x 30	0,07	9842.06
80 x 40	0,14	9842.08
116 x 50	0,35	9842.10
128 x 55	0,45	9842.12
150 x 65	0,70	9842.15

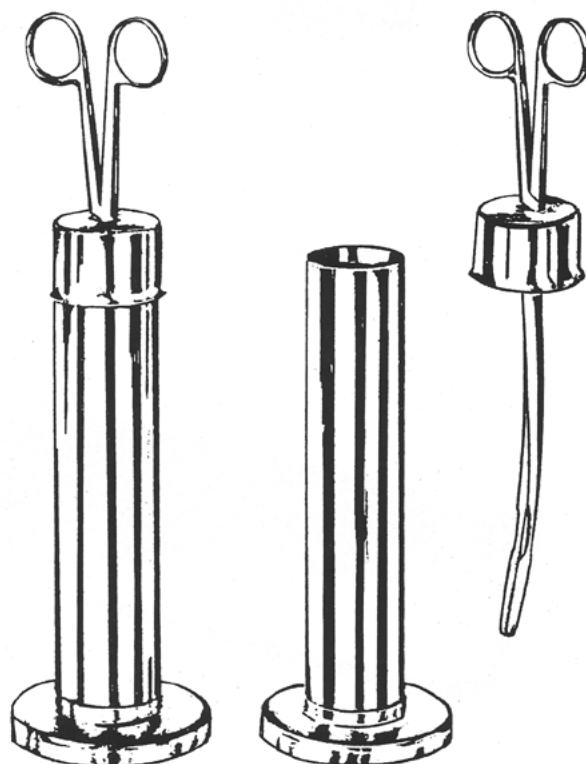


mm	Ltr.	
165 x 60	0,75	9845.16
175 x 70	1,0	9845.17
240 x 110	3,0	9845.24



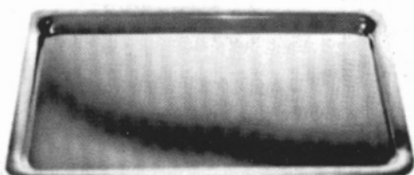
cm	
17	9850.17
25	9850.25*
27	9850.27

* Standard



Kappenzange mit Kappe
und Standgefäß und
Kornzange gebogen

cm	komplett
25	9855.25
32	9855.32



Instrumententablett - Tray

Art-Nr.	Länge length longeur	Breite width largeur	Höhe height hauteur
9856.30	29,5 cm	20 cm	1,8 cm

MEDIZINLÖFFEL-, BECHER
MEDICINE SPOON- AND CUPS
CUCHARA GRADUADA, VASOS GRADUADOS
CUCCHIAIO PER MEDICINALI, BICCHIERI PER MEDICINALI

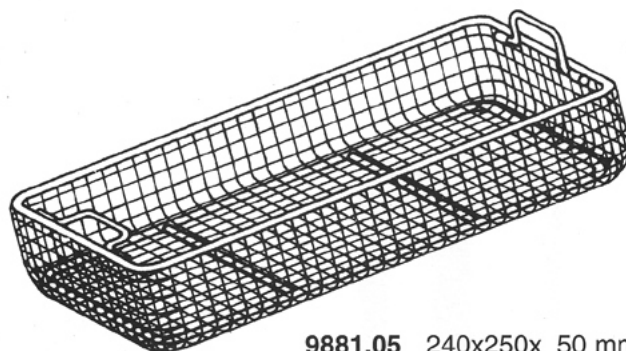


Laborschale

		Ø cm diameter diamètre	Volumen capacity capacité	Höhe height hauteur
9849.02	B2	6,0	0,06 l	3,0 cm
9849.04	B4	8,5	0,16 l	4,0 cm

MATTES

STERILISIERTRÖMMELN
STERILIZING DRUMS
TAMBOURS À STÉRILISATION
TAMBORES P. ESTERILIZACIÓN
TAMBORI P. STERILIZZAZIONE

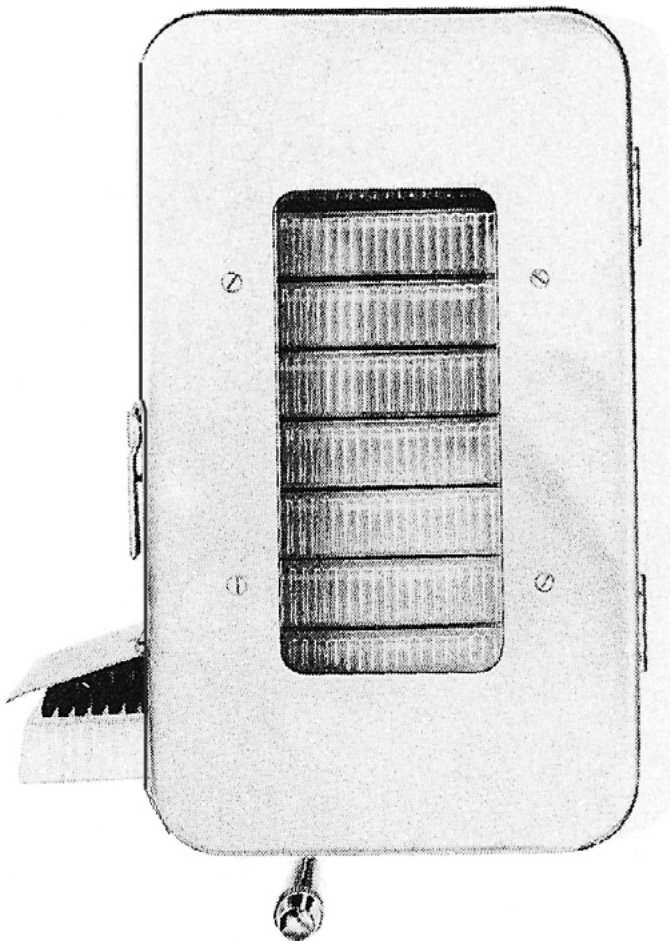


9881.05 240x250x 50 mm
9881.07 240x250x 70 mm

9883.05 480x250x 50 mm
9883.07 480x250x 70 mm
9883.10 480x250x100 mm

9885.05 510x254x 50 mm

BÜRSTENSPENDER, HANDWASCHBÜRSTEN
BRUSH DISPENSOR, NAILBRUSHES
DISTRIBUIDORES DE CEPILLOS, CEPILLO PARA UNAS
DISTRIBUTORE DI SPAZZOLE, SPAZZOLE PER UNGHIE



9886.02

Bürstenspender für 20 Bürsten

Brush dispenser for 20 brushes

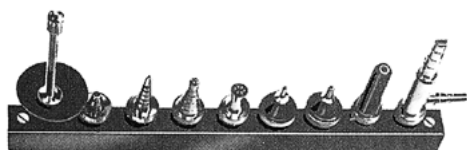
Distribuidor de cepillos para 20 cepillos

Distributore per spazzolini da 20

**REINIGUNGSPISTOLE
WATER JET PISTOL
PISTOLA-LAVATORA
PISTOLA LAVATRICE**



9888.00
komplett mit 9 Aufsätzen
complete with 9 tips
con 9 toberas
completa con 9 raccordi



9888.01
Reinigungsaufsatz für Flaschen
Cleansing Tip for bottles
Tobera para botellas
Raccordo di lavaggio per bottiglie



9888.02
Reinigungsaufsatz für Recordspritzen-Konen
Cleansing Tip for Cones of Record Syringes
Tobera para conos de jeringas Record
Raccordo per coni di siringhe Record



9888.03
Reinigungsaufsatz für Katheter
Cleansing Tip for Catheters
Tobera para catéteres
Raccordo di lavaggio per cateteri



9888.04
Reinigungsaufsatz für Drainageschläuche
Cleansing Tip for Drainage Tubings
Tobera para tubos de drenaje
Raccordo di lavaggio per tubi di drenaggio



9888.05
Reinigungsaufsatz für Hohlgefäße (Brause)
Cleansing Tip for Receptacles (Shower)
Tobera para recipientes (ducha)
Raccordo di lavaggio per recipienti (doc-
cia)



9888.06
Reinigungsaufsatz für Kanülen mit Recordkonus
Cleansing Tip for hypodermic needles with Record
Cone
Tobera para agujas de inyección con cono Record
Raccordo di lavaggio per aghi ipodermici con cono
Record



9888.07
Reinigungsaufsatz für Kanülen mit Luerkonus
Cleansing Tip for hypodermic needles with Luer Cone
Tobera para agujas de inyección con cono Luer
Raccordo di lavaggio per aghi ipodermici con cono Luer



9888.08
Reinigungsaufsatz für Meß- und Vollpipetten
Cleansing Tip for Meas. and Volumetric Pipettes
Tobera para pipetas de medida y volumétricas
Raccordo di lavaggio per pipette comuni e graduate



9888.09
Reinigungsaufsatz für feine Pipetten
Cleansing Tip for fine pipettes
Tobera para pipetas finas
Raccordo di lavaggio per pipette fine



9888.10
Reinigungsaufsatz 31 cm gerade
Cleansing Tip 31 cm straight
Tobera 31 cm recta
Raccordo 31 cm rette



9888.11
Reinigungsaufsatz 30 cm aufgebogen
Cleansing Tip 30 cm curved
Tobera 30 cm curva
Raccordo di lavaggio 30 cm curvo



9889.01 / 9889.02 / 9889.03
Überwurfmutter zum Anschluß an Gewindehähne
Couplings for connection to water tap
Tuercas-hembras para conexión al grifo de agua
Dadi premistoppa per connessione ai rubinetti filettati

MATTES

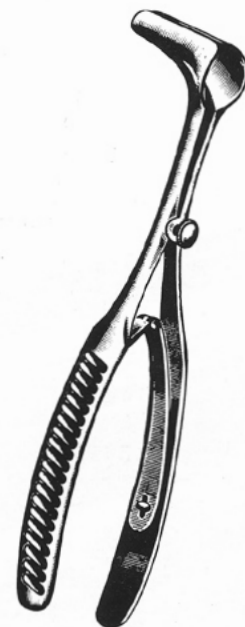
OPHTHALMOLOGIE
OPHTHALMOLOGY
OPHTALMOLOGIE
OFTALMOLOGÍA



STIMMGABELN
TUNING FORKS
DIAPASONS
DIAPASONES
DIAPASON



RHINOLOGIE
RHINOLOGY
RHINOLOGIE
RINOLOGÍA
RINOLOGIA



MUND UND ZUNGE
MOUTH AND TONGUE
BOUCHE ET LANGUE
BOCA Y LENGUA
BOCCA E LINGUA



TONSILLEN
TONSILS
AMYGDALES
AMÍGDALAS
TONSILLE



GASTROSKOPIE
GASTROSCOPY
GASTROSCOPIE
GASTROSCOPIA
GASTROSCOPIA





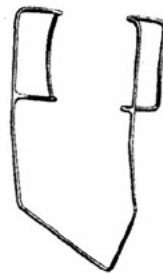
	Schiötz	
	10000.00	10001.00
Skala	gerade	schräg
Skale	straight	oblique
Escala	recta	oblicua

MATTES

OPHTHALMOLOGIE
OPHTHALMOLOGY
OPHTALMOLOGIE
OFTALMOLOGÍA

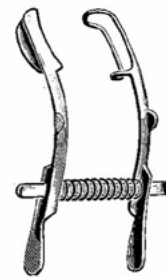
Sperrelevatoren
 Eye Specula
 Blépharostats
 Blefarostatos
 Blefarostati

Tonometer
 Tonómetro
 Tonomètre



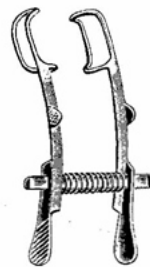
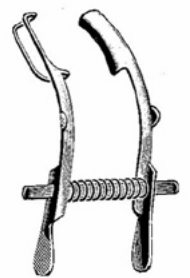
Barraquer (Colibri)

10003.03 3 cm für Kinder / children / niños / bambini
 10003.04 4 cm für Erwachsene / adults / adultos / adulti



Mellinger-Axenfeld

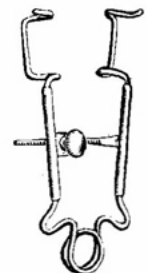
7 cm 10004.07 10005.07



Mellinger
 7,0 cm
 10006.07



Bowmann
 7,0 cm
 10007.07



Critchett
 6,0 cm
 10008.07

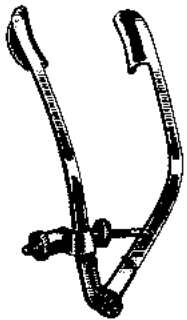


cm	Gräfe
7	10010.07
9	10010.09

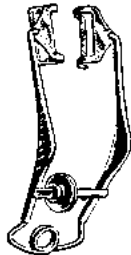


Clark
 8,0 cm
 10012.08

LIDSPERRER, LIDPLATTE, STARMESSER
 EYE SPECULA, LID PLATE, CATARACT KNIVES
 BLEFARÓSTATOS, PLACE PARA PÁRPADOS, CUCHILLOS PARA CATARATA
 BLEFORASTATI, PLACCA PER PALPEBRE, COLTELLI PER CATARATTA



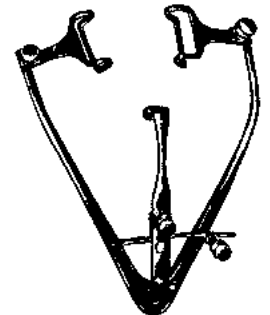
Lancaster
 10002.07 7 cm



Ziegler
 10009.07 7 cm



Castroviejo
 10002.08 8 cm



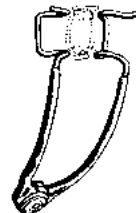
Park
 10009.08 8 cm



Mueller
 10002.01 7 cm



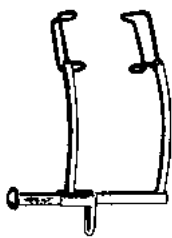
Stevenson
 10002.02 7 cm



Smith
 10002.03 5 cm



Jaeger
 10011.11 11 cm



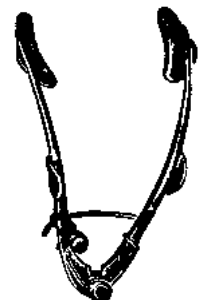
Murdock
 10002.04 5 cm



Week
 10002.05 8 cm



Lister-Burch
 10002.06 8 cm

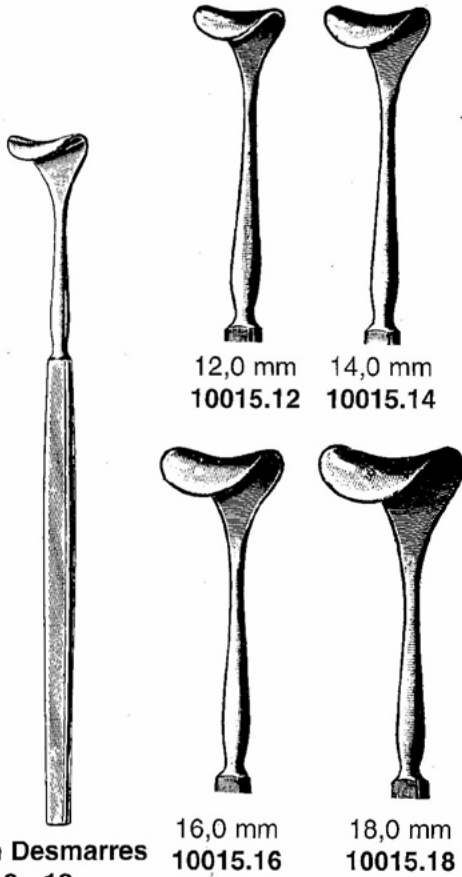


Williams
 10002.09 8 cm

MATTES

OPHTHALMOLOGIE
OPHTHALMOLOGY
OPHTHALMOLOGIE
OFTALMOLOGÍA

Starmesser – Augenmesser
Cataract knives – Eye knives
Coitelli per cataratta – Cotelli per oculistica



12,0 mm
10015.12

14,0 mm
10015.14

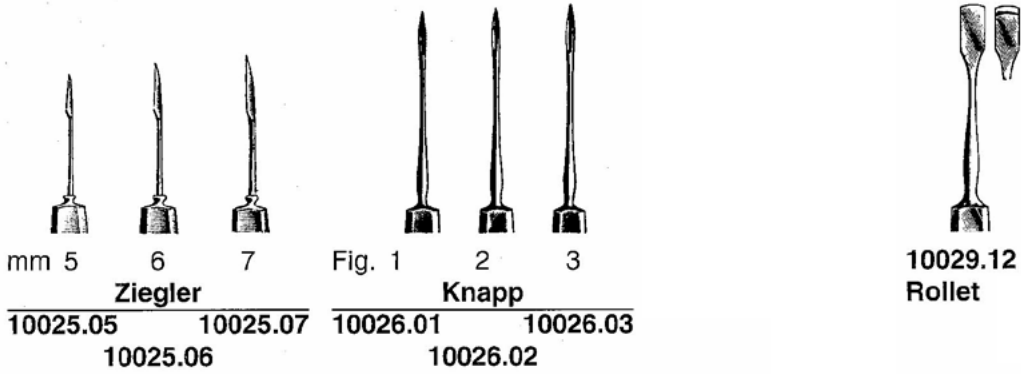
16,0 mm
10015.16

18,0 mm
10015.18

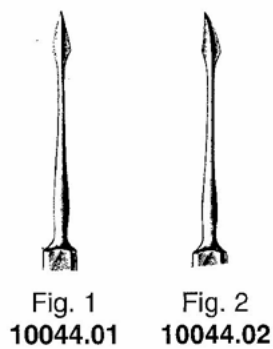
13,0 cm **Desmarres**
10015.12 - 18

OPHTHALMOLOGIE
 OPHTHALMOLOGY
 OPHTHALMOLOGIE
 OFTALMOLOGÍA

Augenmesser
 Couteaux oculaires
 Coltelli per oculistica



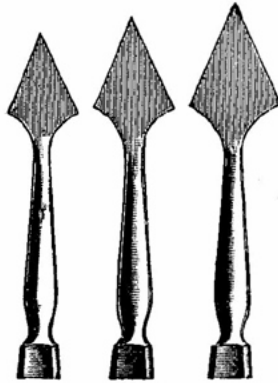
Fremdkörpernadeln
 Foreign Body Removers
 Instruments pour corps étranger
 Agujas para Cuerpos extraños



OPHTHALMOLOGIE
OPHTHALMOLOGY
OPHTALMOLOGIE
OFTALMOLOGÍA

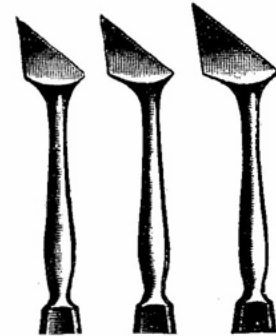


Starmesser – Augenmesser
Cataract knives – Eye knives
Coltelli per cataratta – Cotelli per oculistica



Jaeger

Fig. 1 2 3
10050.01 10050.02 10050.03



Jaeger 45°

Fig. 1 2 3
10051.01 10051.02 10051.03

Nachstarlanze – Keratomy knives
Couteaux lancéolaires
Cuchillos de ceratología



Castroviejo
10053.13

OPHTHALMOLOGIE – SCHIELHÄKCHEN
OPHTHALMOLOGY
OPHTALMOLOGIE
OFTALMOLOGÍA



Graefe
10055.12



Jameson
10058.13



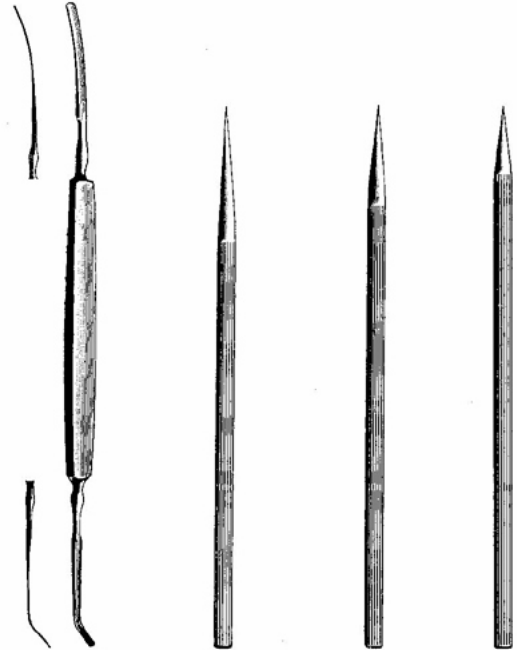
Guthrie
10059.12



Rollett
10061.13

Irisspateln
Iris Spatula
Espatulas p/iris

OPHTHALMOLOGIE
OPHTHALMOLOGY
OPHTHALMOLOGIE
OFTALMOLOGÍA



Wheeler
10078.12

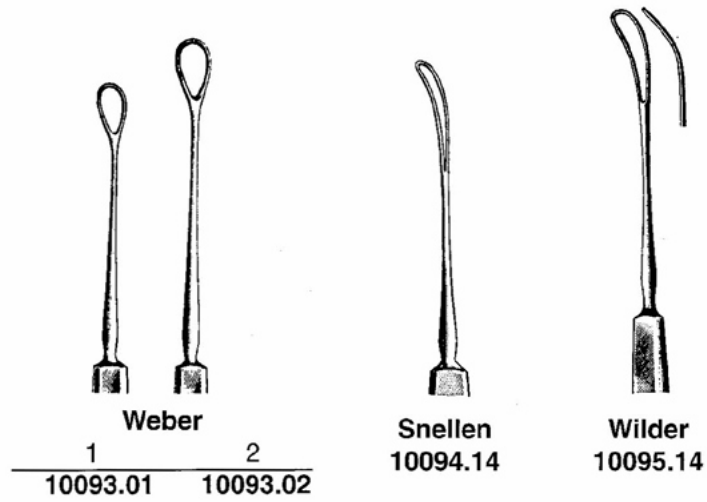
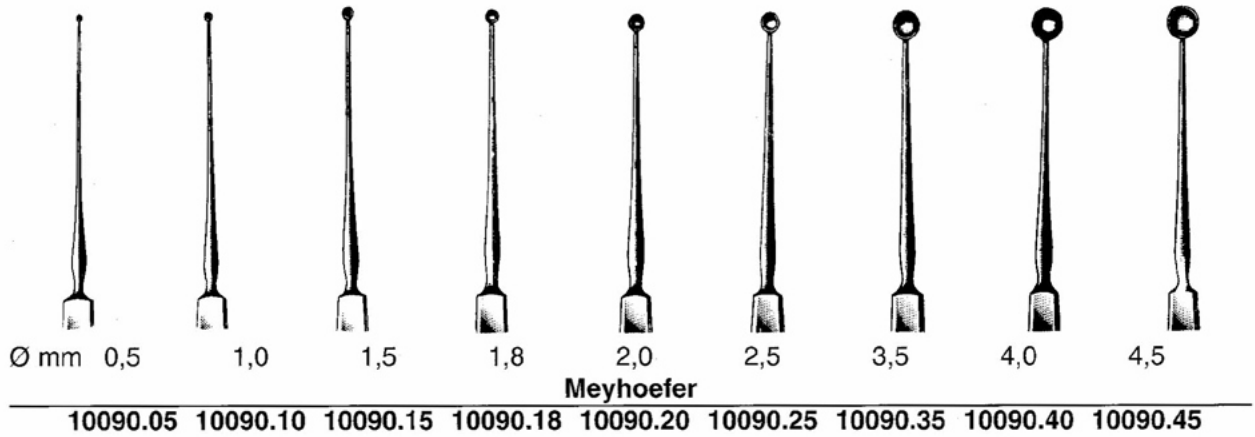
Wilde
10079.01 10079.02 10079.03

Doppelinstrumente – Double-ended Instruments
Instrumentos dobles

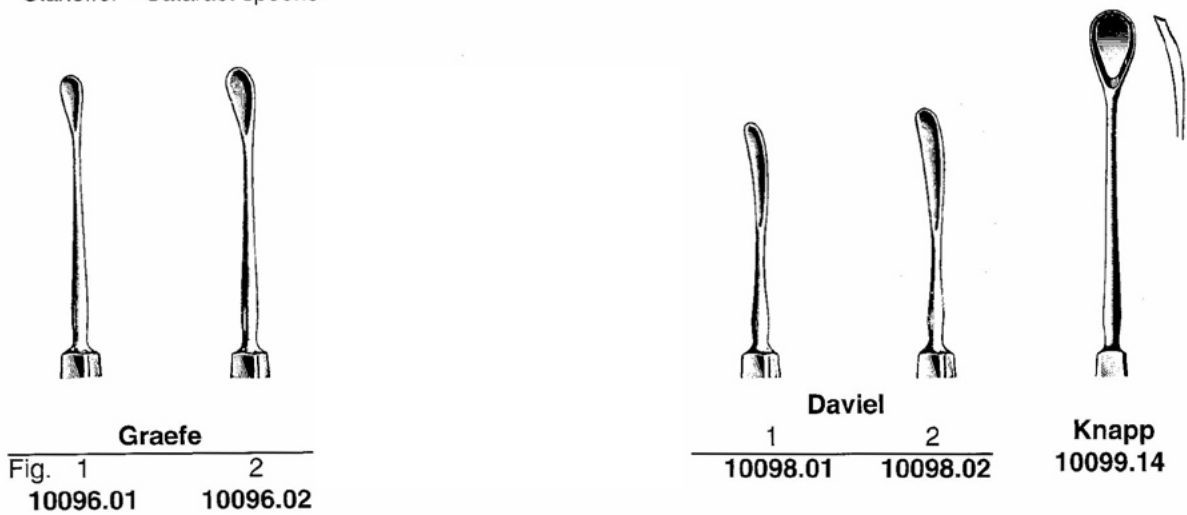


Dix flach
10084.13

OPHTHALMOLOGIE
 OPHTHALMOLOGY – CHALAZIONS-LÖFFEL
 OFTALMOLOGÍA SCOOPS AND CURETTES FOR CHALAZIO

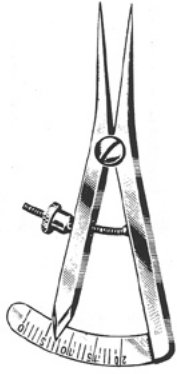


Starlöffel – Cataract spoons

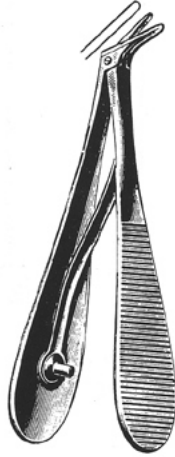


MATTES

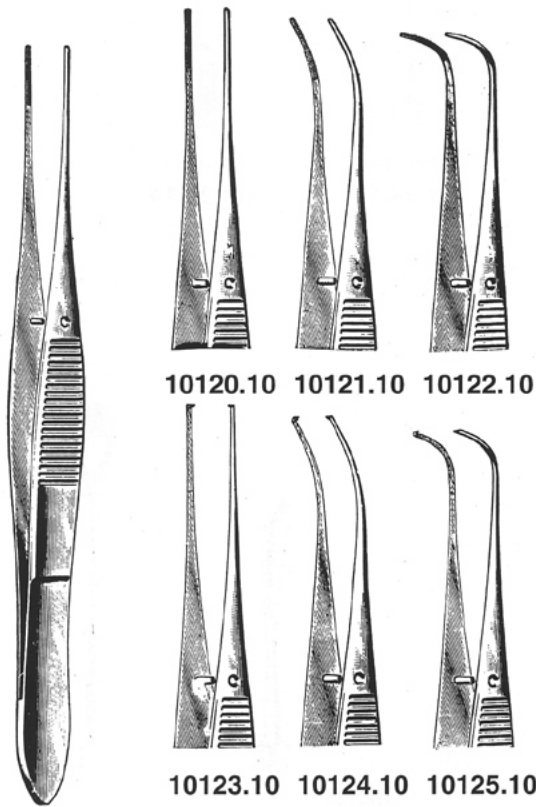
OPHTHALMOLOGIE – ZIRKEL-KAPSELSTANZE-SAUGER
 OPHTHALMOLOGY MARKER-PUNCH
 OFTALMOLOGÍA



Castroviejo 0-20 mm
 10110.07



Holth
 10112.09



10120.10 10121.10 10122.10

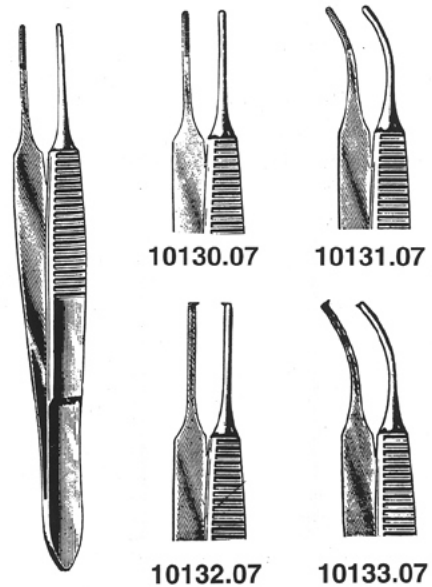
10123.10 10124.10 10125.10

Graefe 10,0 cm



Stevens 11,0 cm
 10128.11

Iris-Pinzetten
 Iris Forceps
 Pinces à iris
 Pinzas para iris
 Pinze per iride



10130.07

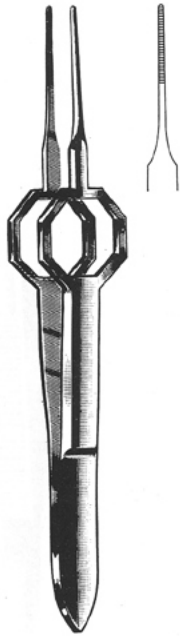
10131.07

10132.07

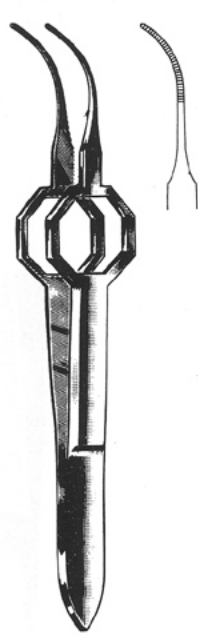
10133.07

Graefe 7,0 cm/1 mm

IRIS-PINZETTE
 IRIS FORCEPS
 PINCES A IRIS
 PINZAS PARA IRIS
 PINZE PER IRIDE



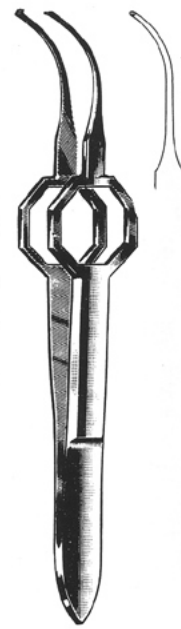
Förster
 10140.06



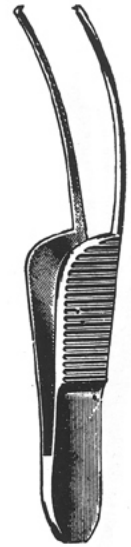
Förster
 10141.06



Förster
 10142.06



Förster
 10143.06



Fischer
 10144.08

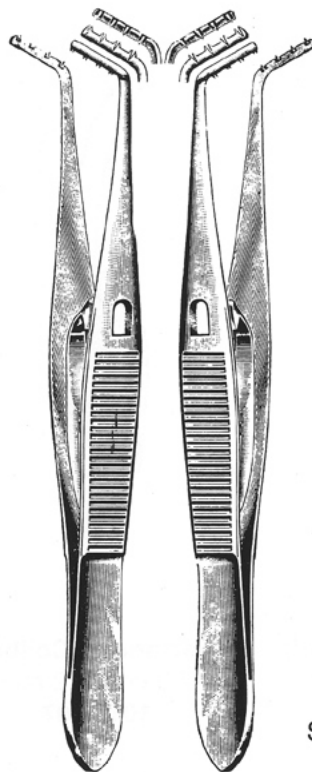


Fig. 1 2
 Prince
 10150.01 10150.02

mit
 Schloss



Knapp
 10152.12

MATTES

OPHTHALMOLOGIE
OPHTHALMOLOGY
OPHTALMOLOGIE
OFTALMOLOGÍA
OFTALMOLOGIA

Strabismus-Pinzetten
Strabismus Forceps
Pinces à strabisme
Pinzas para estrabismo
Pinze per strabismo



8,5 cm/0,5 mm
10155.08



8,5 cm/0,8 mm
10156.08



8,5 cm/0,5 mm
10157.08



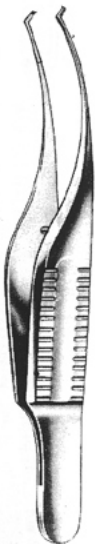
Bishop-Harman
8,5 cm/0,8 mm
10158.08



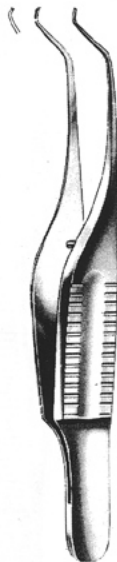
Mod. Bonn
7,0 cm/0,12 mm
10159.07



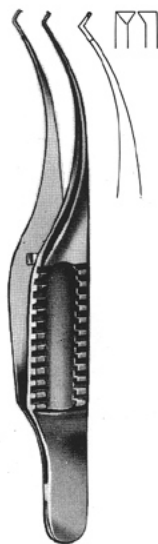
Mod. Bonn
7,0 cm/0,12 mm
10160.07



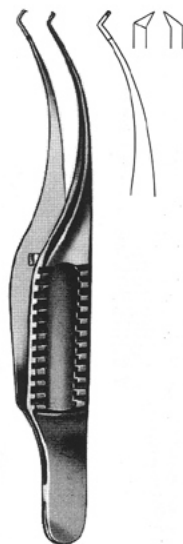
Barraquer-Katzin
7,0 cm/0,4 mm
10161.07



Troutman (Colibri)
7,0 cm/0,12 mm
10162.07

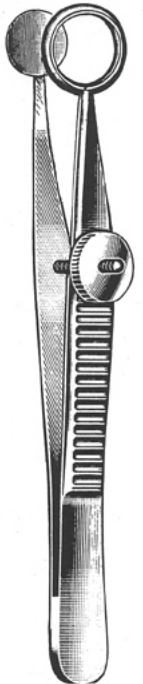


Barraquer (Colibri)
7,0 cm/0,12 mm
10163.07



Barraquer (Colibri)
7,0 cm/0,12 mm
10164.07

OPHTHALMOLOGIE
 OPHTHALMOLOGY
 OPHTALMOLOGIE
 OFTALMOLOGÍA
 OFTALMOLOGIA

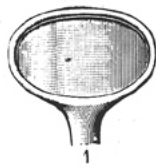


10173.09
 Ayer 9,0 crr

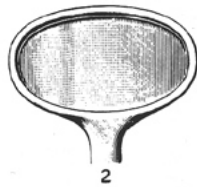
Pinzetten für Chalazion, Entropium, Trachom
 Forceps for Chalazio, Entropium, Trachoma
 Pinzes à chalazion, à entropion, à granulations du trachome
 Pinzas de chalazión, de entropión y para tracoma
 Pinze per calazio, per entropio e per trichiasi



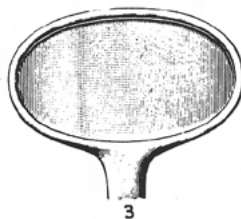
Desmarres
 9,0 cm
 10175.01 - 03



10175.01



10175.02



10175.03

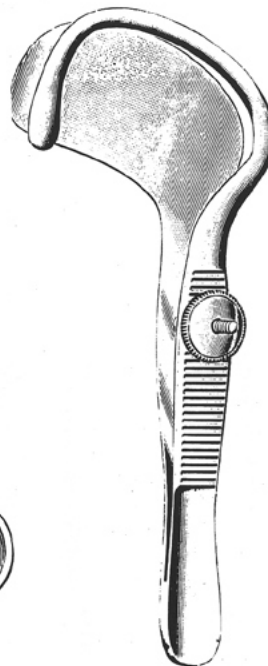
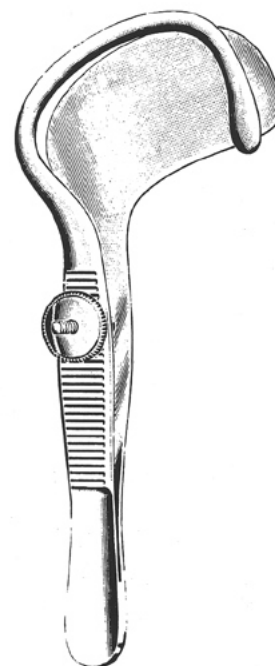


Fig. 1
 10176.01

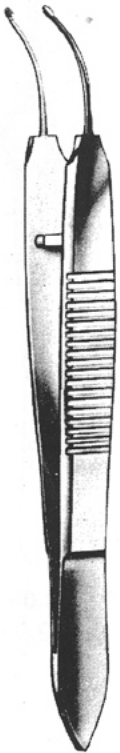


Snellen 2
 10176.02

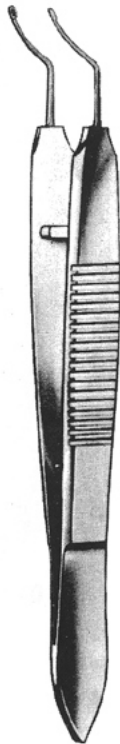
MATTES

OPHTHALMOLOGIE
OPHTHALMOLOGY
OPHTALMOLOGIE
OFTALMOLOGÍA
OFTALMOLOGIA

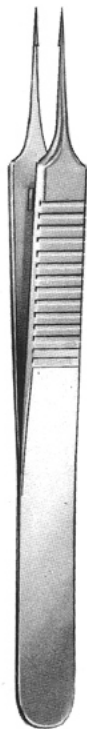
Iris-, Muskel-Pinzetten
Iris, Muscle Forceps
Pincès à iris, musculaires
Pinzas para iris, musculares
Pinze per iride, muscolari



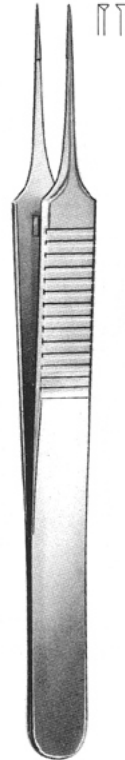
Arruga 10,0 cm
10180.10



Arruga
10181.10

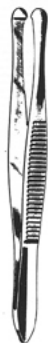


Mod. Tübingen
10182.10



Mod. Bonn 10,0 cm
10183.10

Cilienpinzetten
Cilia Forceps
Pincès à épiler les cils
Pinzas depilatorias



Beer
9,0 cm
10186.09



Douglas
9,0 cm
10187.09



Littauer
8,5 cm
10188.08



9,0 cm
10189.09



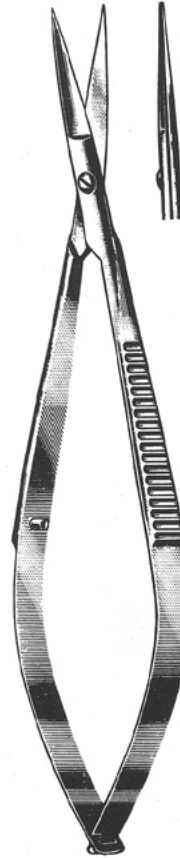
AUGEN-SCHEREN
OPHTHALMIC SCISSORS
CISEAUX OCULAIRES
TIJERAS OCULARES
FORBICI OCULISTICHE



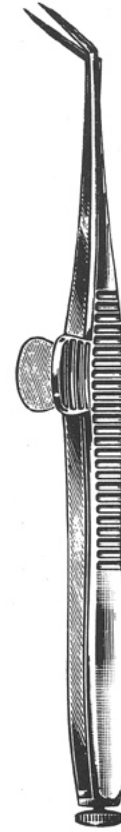
Castroviejo
10,0 cm
10195.10



Castroviejo
10,0 cm
10196.10



Noyes
12,0 cm
10197.12



Wecker
11,0 cm
10198.01 - 03



Fig. 1
10198.01



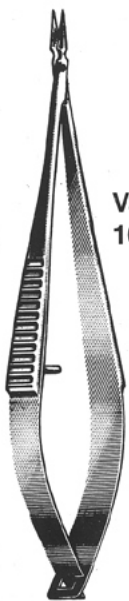
Fig. 2
10198.02



Fig. 3
10198.03



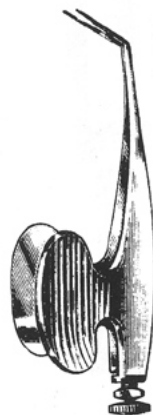
McGuire
10,0 cm
10199.10



Vannas
8,0 cm
10200.08



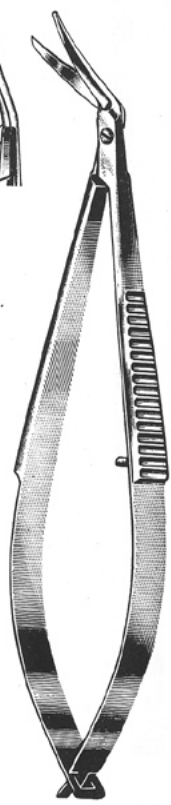
Vannas curved
10201.08



Barraquer
(Colibri) 5,5 cm/10 mm
10202.10



Castroviejo
11,0 cm
10203.11

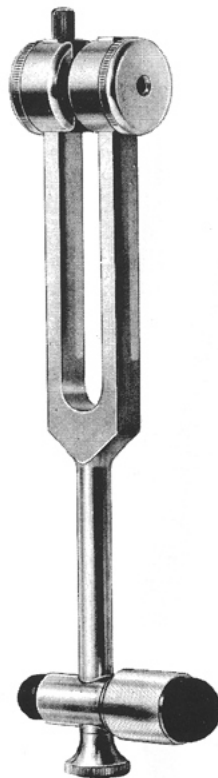


Castroviejo
11,0 cm
10204.11

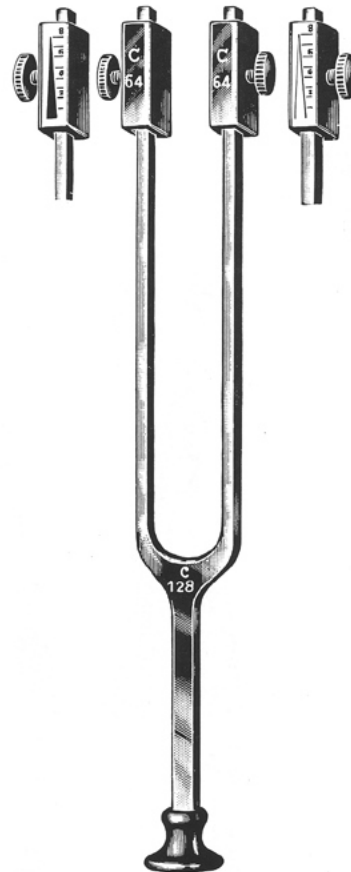
MATTES

STIMMGABELN
TUNING FORKS
DIAPASONS
DIAPASONES
DIAPASON

Lucae
10225.01
c 128
verschiebbar bis h
variable jusqu'a h
variabile fino a h



Neurologie
10227.00
Alu



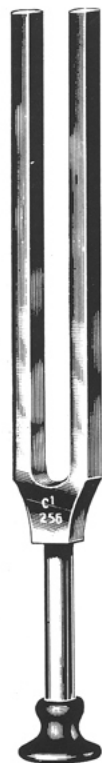
Rydel-Seiffer
10230.00
c 64/c 128



Hartmann
10232.01
c¹ 256



Lucae
10234.00
c 128



Lucae
10235.01
c¹ 256



Lucae
10236.02
c² 512



Lucae
10237.03
c³ 1024



Lucae
10238.04
c⁴ 2048



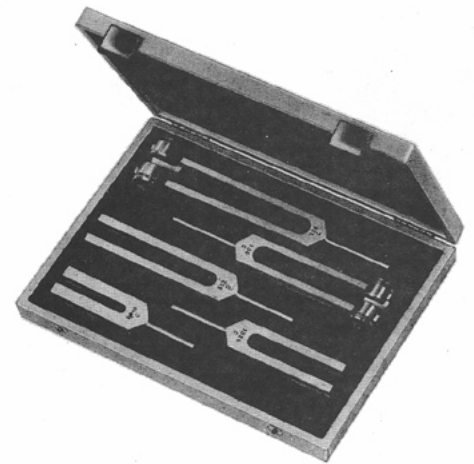
Lucae
10239.05
c⁵ 4096

STIMMGABELN
TUNING FORKS
DIAPASONS
DIAPASONES
DIAPASON

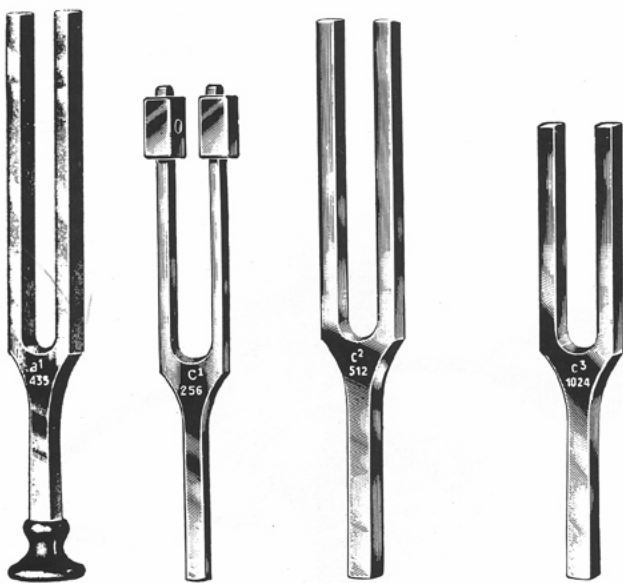


Alu

c 128 10240.00	c ¹ 256 10241.01	c ² 512 10242.02	c ³ 1024 10243.03	c ⁴ 2048 10244.04
-------------------	--------------------------------	--------------------------------	---------------------------------	---------------------------------



Alu
compl.
10245.00



Hartmann

a ¹ 440 10248.00	c ¹ 256 10249.01	c ² 512 10250.02	c ³ 1024 10251.03
--------------------------------	--------------------------------	--------------------------------	---------------------------------



Hartmann
compl.
10255.00

MATTES

OTOLOGIE
OTOLOGY
OTOLOGIE
OTOLOGÍA
OTOLOGIA

Ohr-Spekula
Ear Specula
Spéculums auriculaires
Espéculos auriculares
Specoli auricolari

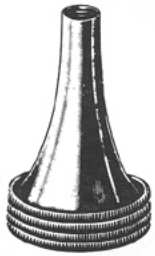
mm Ø
⑥ = 3
10260.03

① = 4,5
10260.04

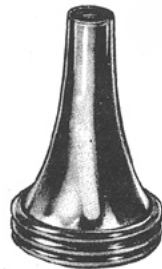
② = 5,5
10260.05

③ = 6,5
10260.06

④ = 7,5
10260.07



Hartmann
10260.00
Set = 4

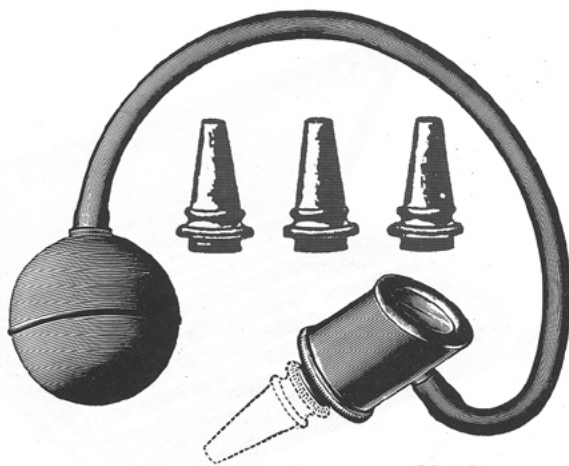


Toynbee
10262.00
Set = 3

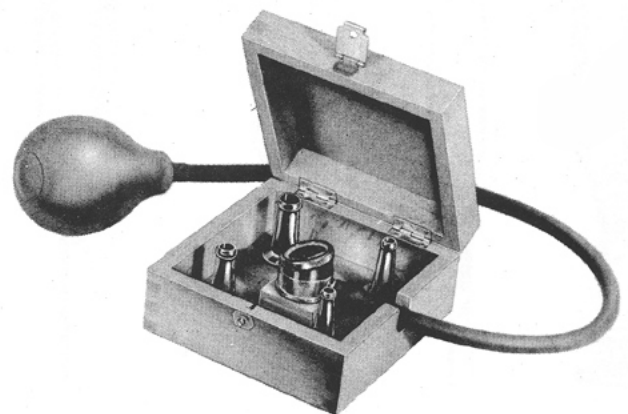
mm Ø
② = 5,5
10262.05

③ = 6,5
10262.06

④ = 7,5
10262.07



Siegle
10274.00 komplett



Bruenings
10275.00
komplett

①
6,5

②
7

③
8 mm Ø

OTOLOGIE
OTOLOGY
OTOLOGIE
OTOLOGÍA
OTOLOGIA

Parazentesenadeln
Paracentesis Needles
Aiguilles à paracentèse
Aguja para paracentesis
Aghi per paracentesi

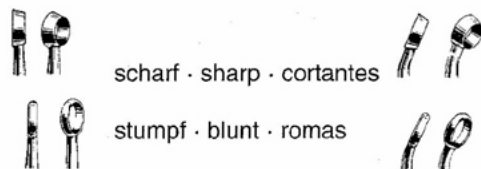
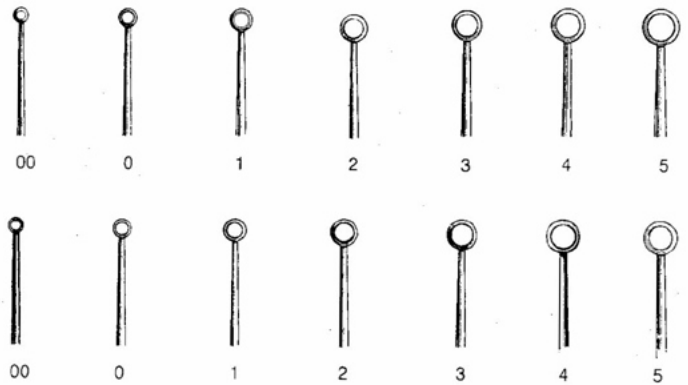
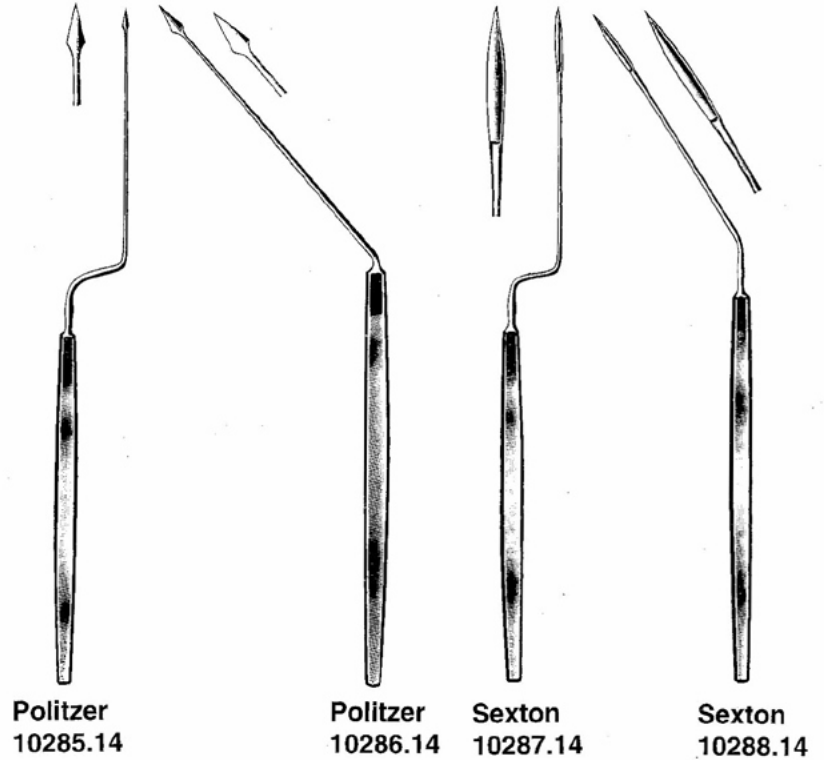


Fig. 1 **Lucae** 10290.01
2 10290.02
3 10290.03

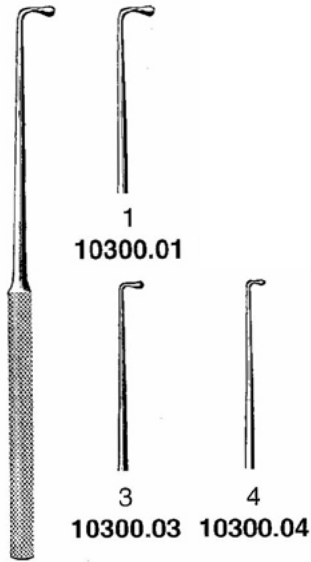
Billeau 10292.01
10292.02
10292.03

Buck
Küretten
Curettes
Curetas
Curette

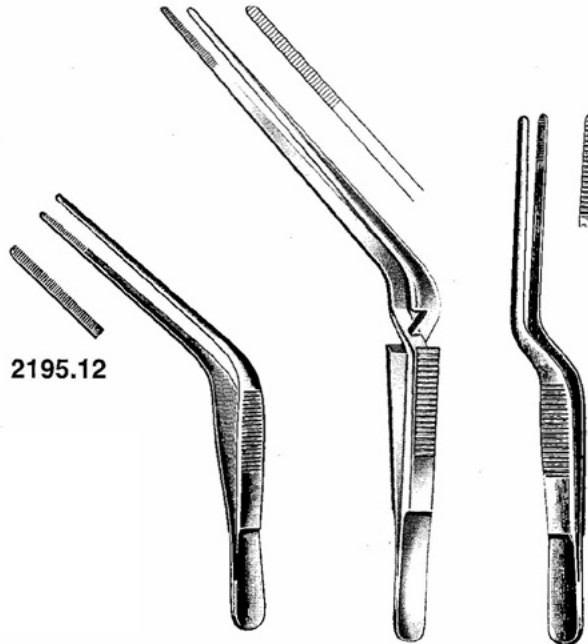
gerade/straight rectas	gebogen/angled angulada	gerade/straight rectas	gebogen/angled angulada
10295.00 00	10296.00 00	10298.00 00	10299.00 00
10295.10 0	10296.10 0	10298.10 0	10299.10 0
10295.01 1	10296.01 1	10298.01 1	10299.01 1
10295.02 2	10296.02 2	10298.02 2	10299.02 2
10295.03 3	10296.03 3	10298.03 3	10299.03 3
10295.04 4	10296.04 4	10298.04 4	10299.04 4
10295.05 5	10296.05 5	10298.05 5	10299.05 5
scharf/sharp	scharf/sharp	stumpf/blunt	stumpf/blunt

MATTES

OTOLOGIE
OTOLOGY
OTOLOGIE
OTOLOGÍA
OTOLOGIA



Wagner

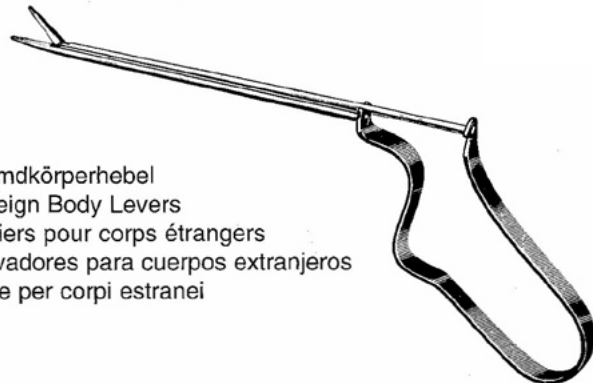


Tröltzsch
12,0 cm

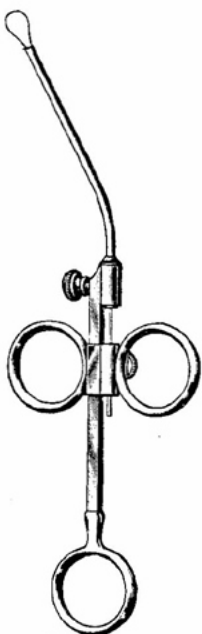
Tröltzsch
14,0 cm
10303.14

Lucae
14,0 cm
2196.14

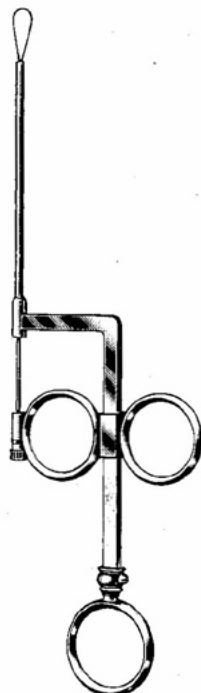
Fremdkörperheber
Foreign Body Levers
Leviers pour corps étrangers
Elevadores para cuerpos extranjeros
Leve per corpi estranei



Buck
11,0 cm
10310.11



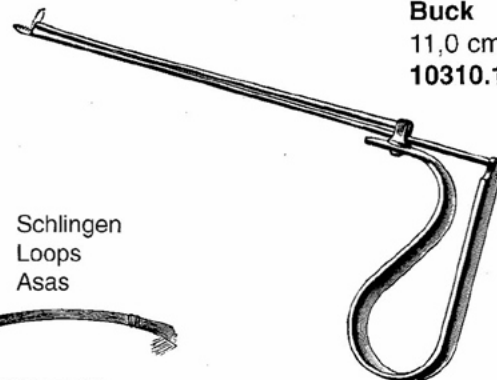
Krause 16,0 cm
10313.16



Wilde 17,0 cm
10314.17

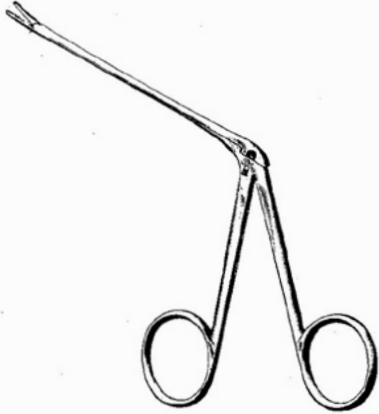


Schlingen
Loops
Asas
10315.12
12 Stück
12 pieces
12 piezas



Quire
10311.10

**OHRZÄNGCHEN
EAR FORCEPS
PINCES AURICULAIRES
PINZAS AURICULARES
PINZE AURICOLARI**



cm	Hartmann
8,5	10320.08
14,0	10320.14
16,0	10320.16



Hartmann-Wullstein
10321.08



Hartmann-Wullstein
10322.08



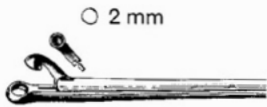
Ø mm	Hartmann
2,0	10325.20
2,5	10325.25
3,0	10325.30
8,5 cm	



cm	Hartmann
8,5	10326.08
14,0	10326.14

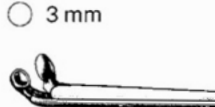


Hartmann
10327.08



○ 2 mm

Hartmann-Hoffmann
10330.08



○ 3 mm

Hartmann
10331.08



Struempel
10332.08

**MIKRO-OHRZÄNGCHEN
MICRO EAR FORCEPS
PINCES AURICULAIRES MICRO
PINZAS AURICULARES MICRO
PINZE AURICOLARI MICRO**



10340.04
4,5 mm



10341.04
4,5 mm



10342.04
4,5 mm



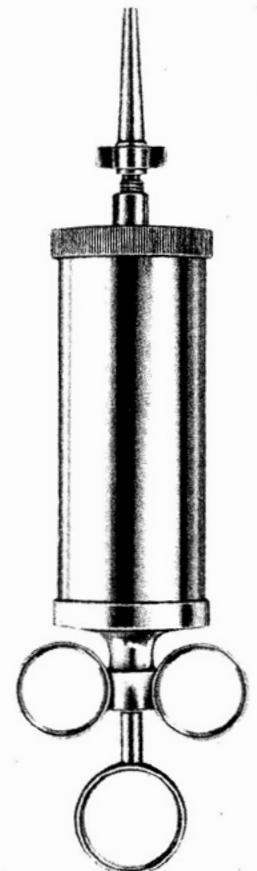
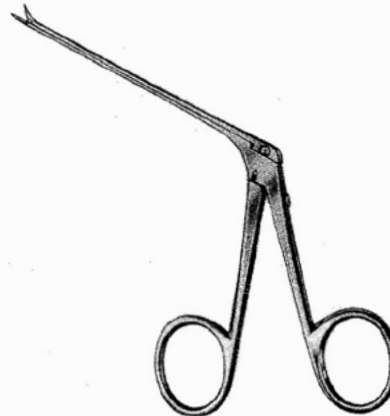
10344.50
5,0 mm



10345.50
5,0 mm



Mc Gee
10347.40
0,8x4,0 mm



ml	Reiner Ohrspritze
50	10350.50
75	10350.75
100	10350.10
150	10350.15

MATTES

OTOLOGIE Mikro-Ohrzängchen
OTOLOGY Micro Ear Forceps
OTOLOGIE Pincés auriculaires micro
OTOLOGÍA Pinzas auriculares micro
OTOLOGIA Pinze auricolari micro



10355.40
4,0 mm



10356.70
7,0 mm



10357.40
4,0 mm



10358.60
6,0 mm



10359.60
6,0 mm

Mikro-Ohrscherchen
 Micro Ear Scissors
 Ciseaux auriculaires micro
 Tijeras auriculares micro
 Forbici auricolari micro



Bellucci
10365.40
4,0 mm



Bellucci
10366.55
5,5 mm



Bellucci
10367.55
5,5 mm



Bellucci
10368.55
5,5 mm



Bellucci
10369.55
5,5 mm



Shea
10372.70
7,0 mm

OTOLOGIE
OTOLOGY
OTOLOGIE
OTOLOGÍA
OTOLOGIA



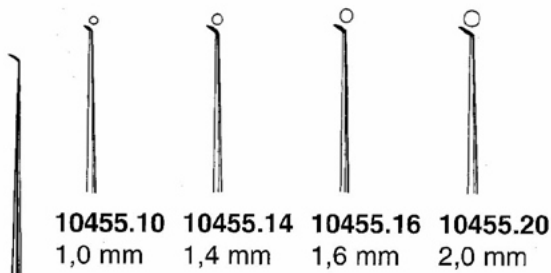
Schuknecht
10450.15
15,5 cm



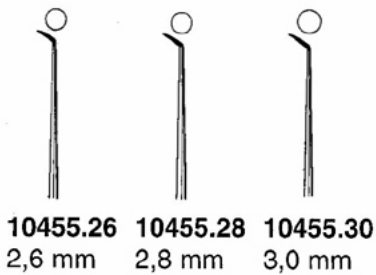
Wullstein
10451.15
15,5 cm



Plester
10453.15
15,5 cm/
3,5 mm Ø

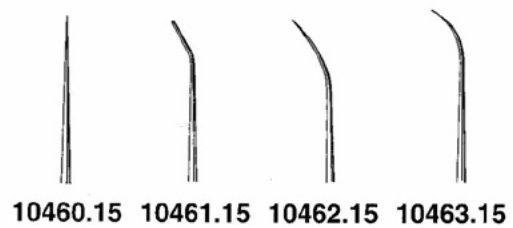


10455.10 10455.14 10455.16 10455.20
1,0 mm 1,4 mm 1,6 mm 2,0 mm

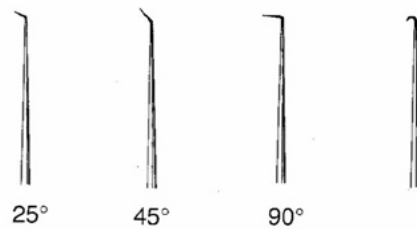


10455.26 10455.28 10455.30
2,6 mm 2,8 mm 3,0 mm

Rosen-Messer



10460.15 10461.15 10462.15 10463.15















mm

0,3	10465.03	10467.03	10469.03	10470.05 = 0,5 mm
0,6	10465.06	10467.06	10469.06	10470.10 = 1,0 mm
1,0	10465.10	10467.10	10469.10	
		10467.12	10469.12	
1,5		10467.15	10469.15	
2,0		10467.20	10469.20	





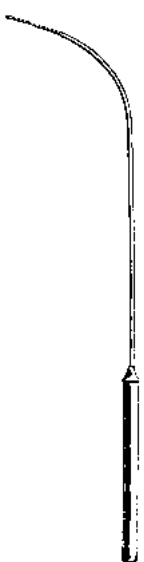
Rosen-Sonde

MATTES

WATTETRÄGER
 SPATULAS, COTTON APPLICATORS
 ESPÁTULAS, PORTA-ALGODONES
 SPATOLE, PORTACOTONE

											
Farrell								1,5	1,5		
10454.12	12,0 cm	10456.12	12,0 cm	10471.12	12,0 cm	10472.12	12,0 cm				
10454.14	14,0 cm	10456.14	14,0 cm	10471.14	14,0 cm	10472.14	14,0 cm				
10454.16	16,5 cm	10456.16	16,5 cm	10471.16	16,0 cm	10472.16	16,0 cm				
10454.18	18,0 cm	10456.18	18,0 cm	10471.18	18,0 cm	10472.18	18,0 cm				

Spatel
 Plaster spatula
 Espátula
 Spatole

				
10464.14 14,5 cm	Uckermann 10466.15 15 cm	Jobson-Horne 10457.12 12 cm 10457.18 18 cm		Tobold 10459.25 25 cm

OTOLOGIE
OTOLOGY
OTOLOGIE
OTOLOGÍA
OTOLOGIA



mm	90°	90°
0,3	10475.03	10476.03
0,6	10475.06	10476.06
1,0	10475.10	10476.10

mm	McGee	McGee	Barbara
0,5	10478.05	10479.05	10480.05
1,0	10478.10	10479.10	15,5 cm

Rosen
10482.15
15,5 cm

mm	25°	25°	45°	45°
0,3	10484.03	10485.03	10486.03	10487.03
0,6	10484.06	10485.06	10486.06	10487.06
1,0	10484.10	10485.10	10486.10	10487.10



mm **Passow**
2 x 2 10490.02
3 x 3 10490.03



Muck 13,0 cm
10491.13



House

mm	
1,0/1,2	10492.01
1,5/1,8	10492.02

mm	
1,0/1,2	10494.01
1,5/1,8	10494.02

MATTES

RHINOLOGIE
RHINOLOGY
RHINOLOGIE
RINOLOGÍA
RINOLOGIA

Nasenspekula
Nasal Specula
Spéculums nasaux
Espéculos nasales
Specoli nasali



Fig. 1

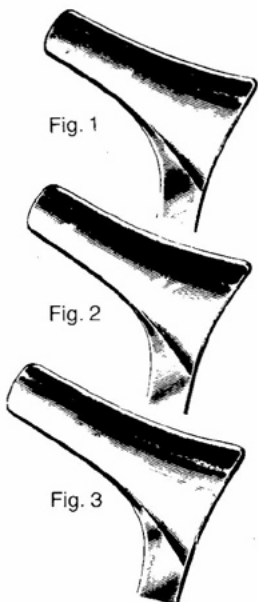


Fig. 2

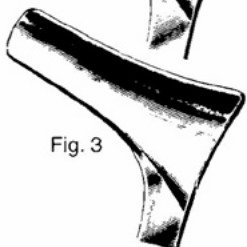
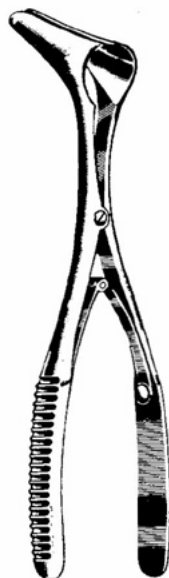


Fig. 3

Hartmann

Fig. 1 15,0 cm 11500.01
Fig. 2 15,0 cm 11500.02
Fig. 3 15,0 cm 11500.03



Vienna

11510.01 Kleinkinder/infant/infante
11510.02 Kinder/child/niños
11510.03 Erwachsene/adult/adultes



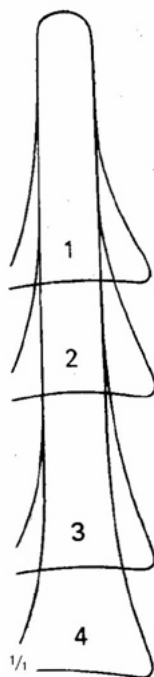
Tieck-Halle

13,5 cm 11515.01



Kilian

13,0 cm
Fig. 1 37 mm 11520.01
Fig. 2 52 mm 11520.02
Fig. 3 75 mm 11520.03
Fig. 4 90 mm 11520.04



1/1

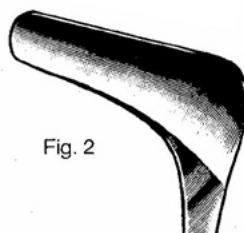


Fig. 2



Sonnenschein
Fig. 2

11530.02

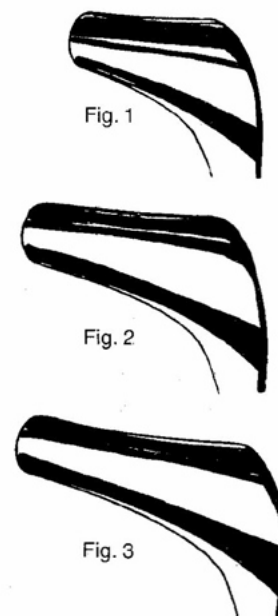


Fig. 1

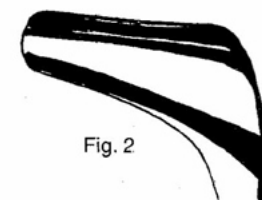


Fig. 2

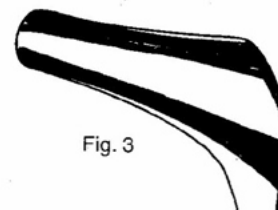


Fig. 3

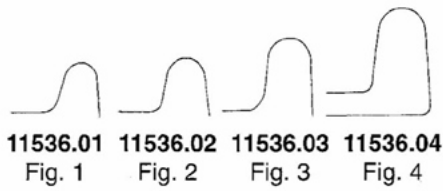
Hartmann-Halle

11535.01
11535.02
11535.03

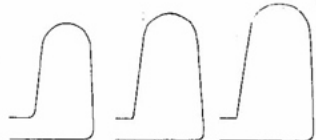
RHINOLOGIE
RHINOLOGY
RHINOLOGIE
RINOLOGÍA
RINOLOGIA



Thudichum
11536.01 - 11536.07



11536.01 11536.02 11536.03 11536.04
Fig. 1 Fig. 2 Fig. 3 Fig. 4



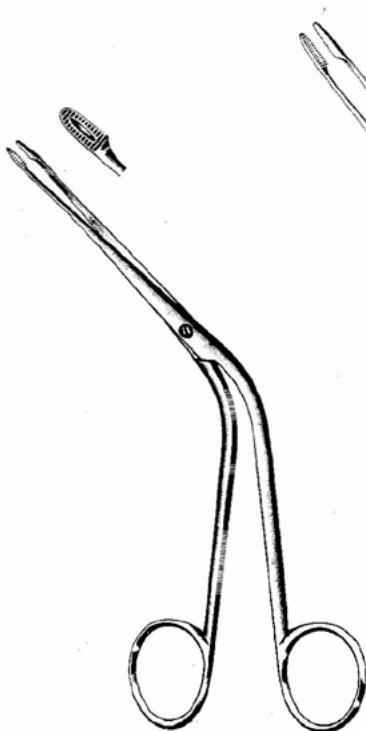
11536.05 11536.06 11536.07
Fig. 5 Fig. 6 Fig. 7



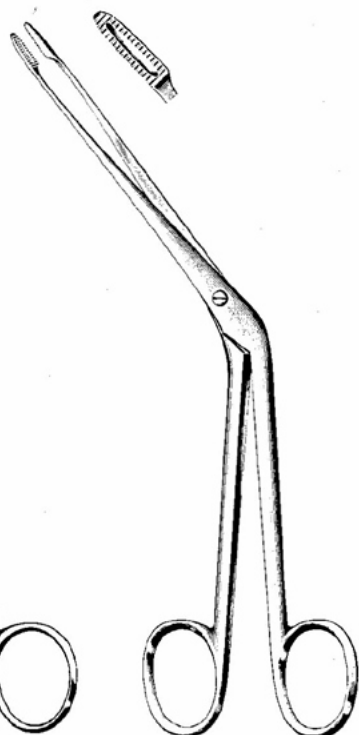
Voltolini
11537.01 - 11537.03



11537.01
11537.02
11537.03



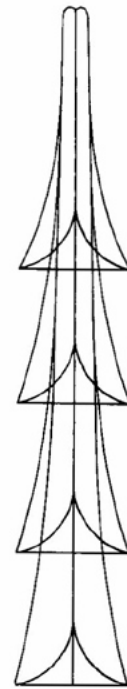
Hartmann 16,0 cm
11560.16



Hartmann 20,0 cm
11561.20



Cottle 14,0 cm
11540.35 - 11540.90



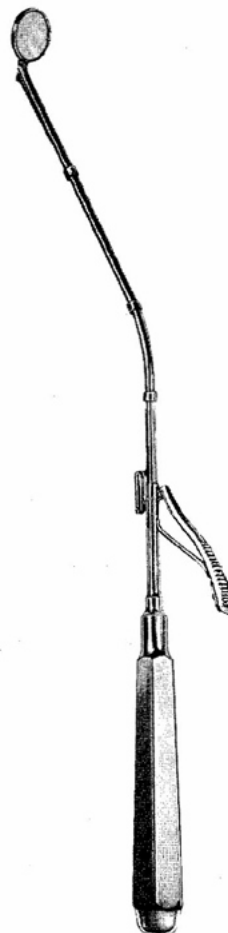
11540.35
11545.35

11540.50
11545.50

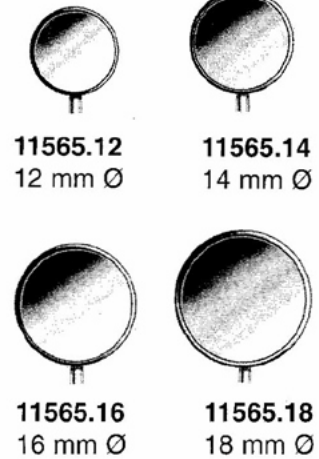
11540.75
11545.75

11540.90
11545.90

Cottle 14,0 cm
schwarz/black/noirs/negros/neri
11545.35 - 11545.90



Michel 25,0 cm
11565.12 - 11565.18



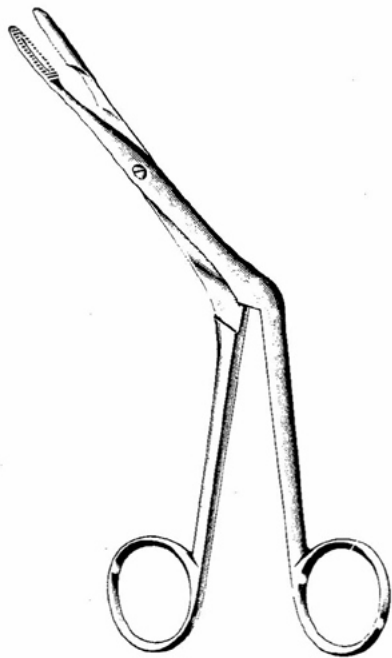
11565.12 11565.14
12 mm Ø 14 mm Ø

11565.16 11565.18
16 mm Ø 18 mm Ø

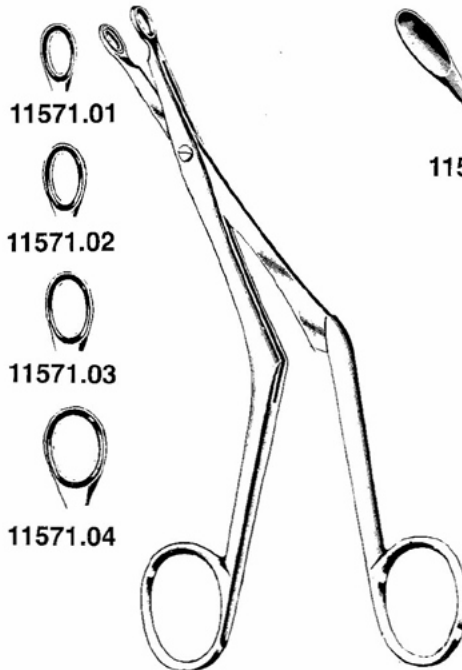
MATTES

RHINOLOGIE
RHINOLOGY
RHINOLOGIE
RINOLOGÍA
RINOLOGIA

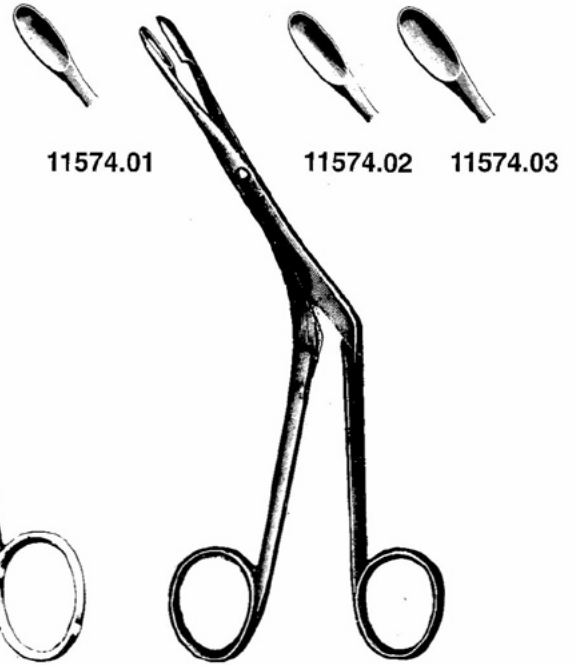
Scharfe Nasenzangen
 Nasal Cutting Forceps
 Pinces coupantes nasales
 Pinzas cortantes nasales
 Pinze taglianti nasali



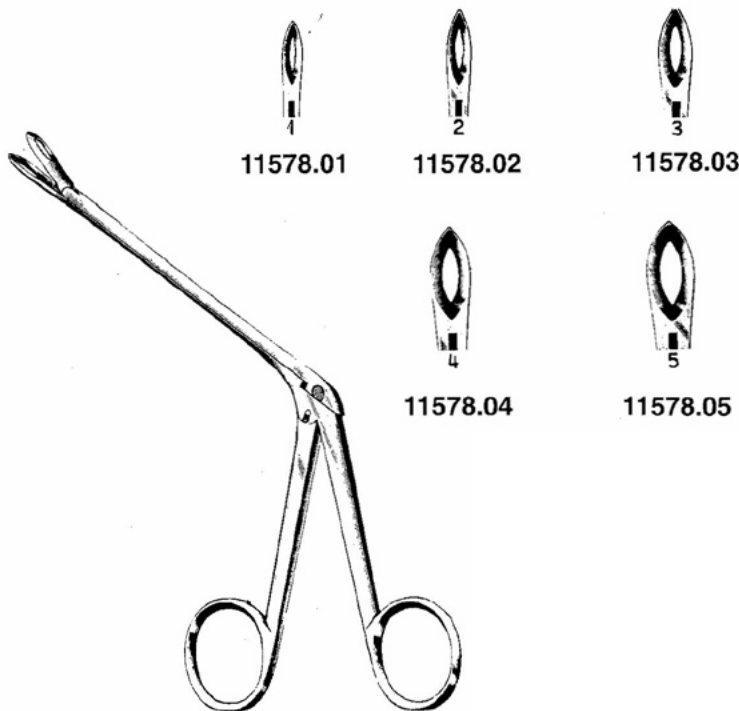
Heymann knight 18,0 cm
11570.18



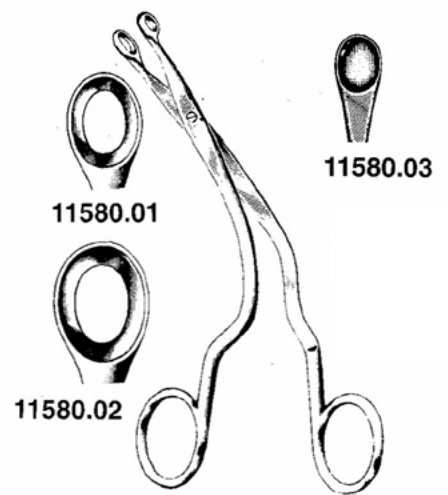
Brünings 19,0 cm Fig. 1-4
11571.01 – 11571.04



Heymann 18,0 cm Fig. 1-3
11574.01 – 11574.03

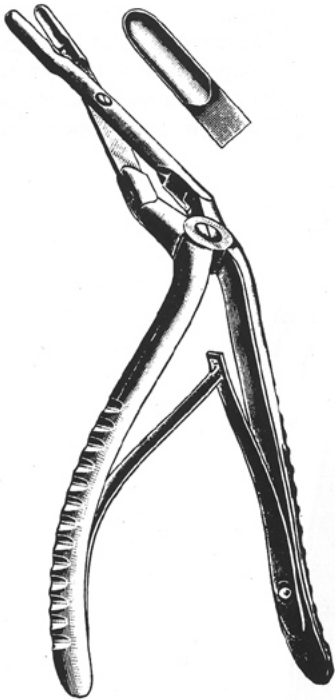


Weil Blakesley 19,0 cm Fig. 1-5
11578.01 – 11578.05



Luc 19,0 cm Fig. 1-4
11580.01 – 11580.03

KNOCHENSTANZE, SEPTUMZANGEN
PUNCHES, SEPTUM FORCEPS
PINZAS OSTEÓTOMOS, PINZAS PARA EL TABIQUE NASAL
PINZE OSTEOTOMI, PINZE PER IL SETTO NASALE

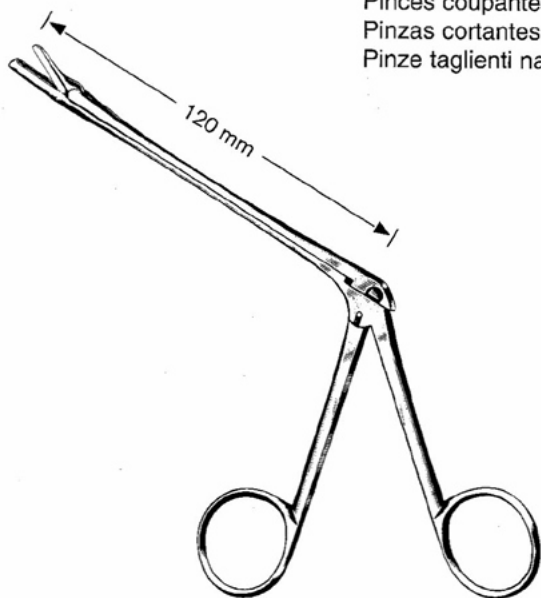


Middleton-Jansen
11587.19
19 cm

MATTES

RHINOLOGIE
RHINOLOGY
RHINOLOGIE
RINOLOGÍA
RINOLOGIA

Scharfe Nasenzangen
Nasal Cutting Forceps
Pincès coupantes nasales
Pinzas cortantes nasales
Pinze taglianti nasali

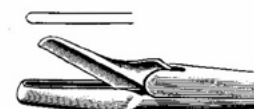


11590.01 - 02
Struycken
19,0 cm

11592.05 - 09
Myles
19,0 cm



Struycken Fig. 1
11590.01



Struycken Fig. 2
11590.02

5 mm 11595.05

7 mm 11595.07

9 mm 11595.09

11 mm 11595.11

5 mm 11592.05

7 mm 11592.07

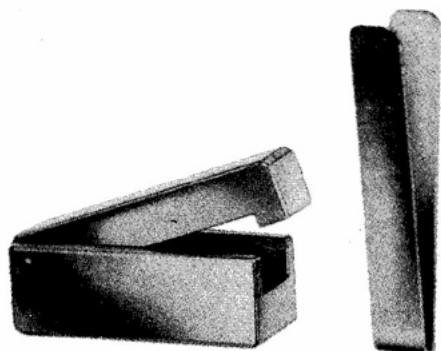
9 mm 11592.09



Hartmann



Myles



Knorpelquetsche Kottle
11597.00



Septum-Quetschzange
Septum Crushing Forceps
Pince à écraser la cloison
Pinza para magullar tabique
Pinza per ammaccare il setto

Rubin 21,0 cm
11598.21

RHINOLOGIE
RHINOLOGY
RHINOLOGIE
RINOLOGÍA
RINOLOGIA

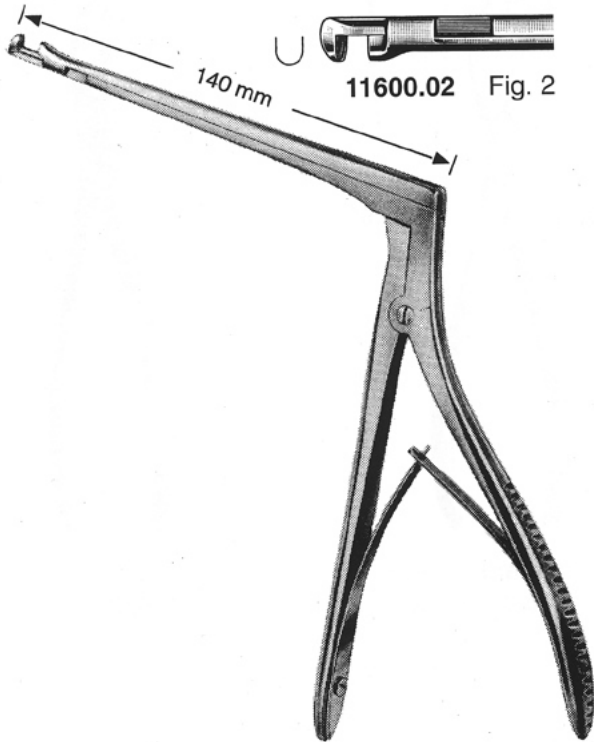
Scharfe Nasenzangen
Nasal Cutting Forceps
Pincas coupantes nasales
Pinzas cortantes nasales
Pinze taglienti nasali



11600.01 Fig. 1



11600.02 Fig. 2



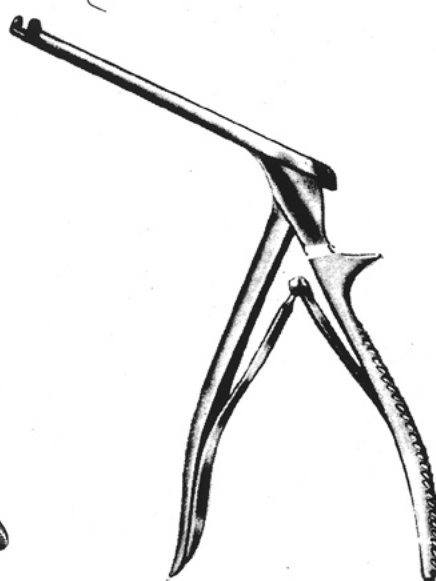
Hajek-Kofler 11600.01 - 02



mm x mm	Kerrison	17,0 cm
3 x 3	11603.03	
4 x 4	11603.04	
5 x 5	11603.05	
6 x 6	11603.06	



Middleton-Jansen 19,0 cm
11605.19

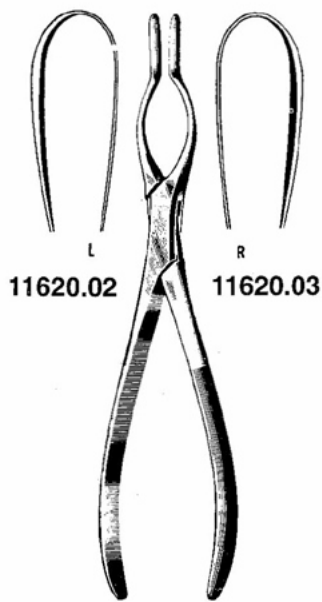


Beyer 2,0 mm
11607.20

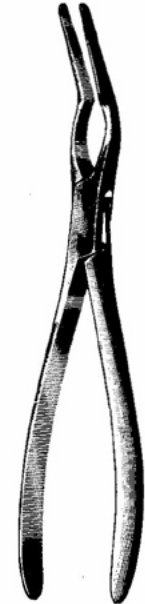


mm	Citelli
1,0	11609.10
2,5	11609.25
4,0	11609.40

RHINOLOGIE
RHINOLOGY
RHINOLOGIE
RINOLOGÍA
RINOLOGIA

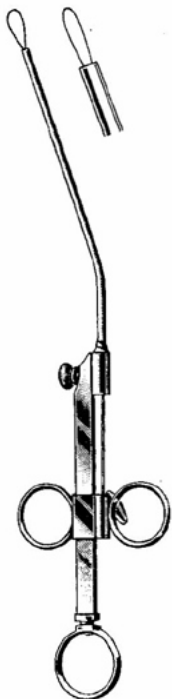


Walsham gerade
11620.01 straight

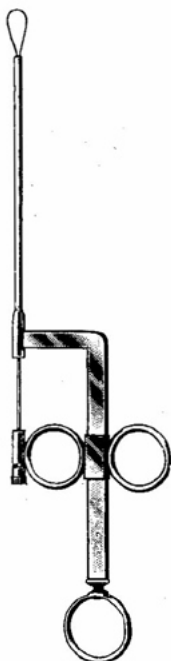


Asch
11622.21

Tonsillenschnürer – Snare



Krause 26,0 cm
11625.26

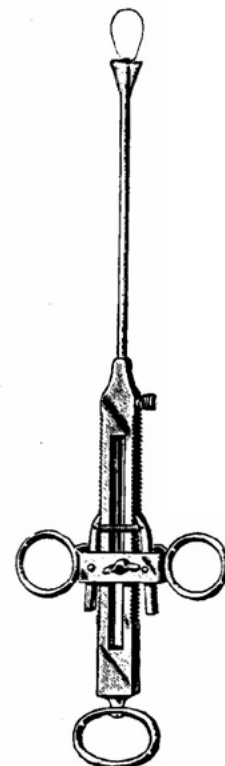


Wilde 24,0 cm
11627.24



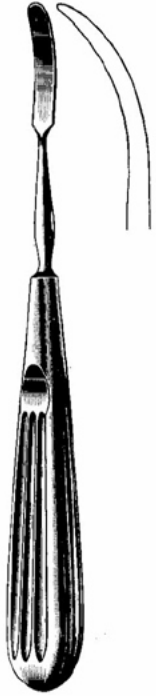
0,3 mm

12 Stück
12 pieces
11628.03



Brünings 28,0 cm
11630.28

RHINOLOGIE
RHINOLOGY
RHINOLOGIE
RINOLOGÍA
RINOLOGIA



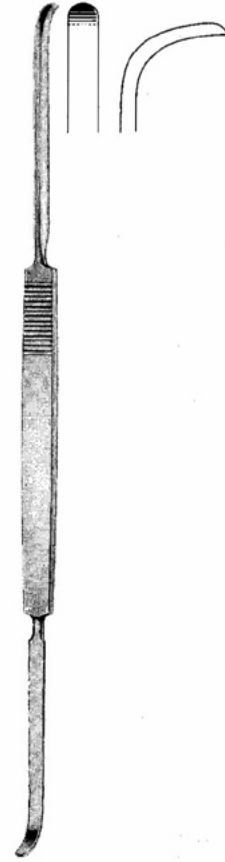
Joseph 16,0 cm
11640.16



Cottle 19,0 cm
11642.19



Killian 22,0 cm
11646.22



Cottle 23,0 cm
11648.23



Cottle 22,0 cm
11650.22



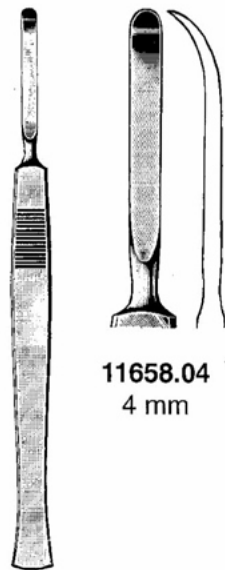
Ballenger
22,0 cm
11652.22



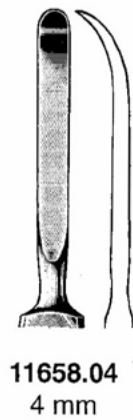
Freer
4 mm
11654.04



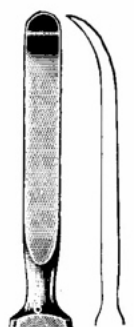
Freer
4 mm
11656.04



McKenty
15,0 cm



11658.04
4 mm



11658.05
5 mm

RHINOLOGIE
RHINOLOGY
RHINOLOGIE
RINOLOGÍA
RINOLOGIA

Septum-Messer
Septum Knives
Couteaux pour la cloison
Cuchillos para tabique
Coltelli per setto



Ballenger 20,0 cm



11660.03
3 mm



11660.04
4 mm



11660.05
5 mm



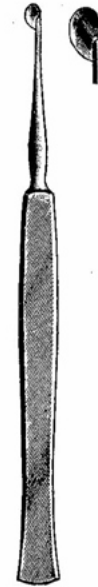
11665.03
3 mm



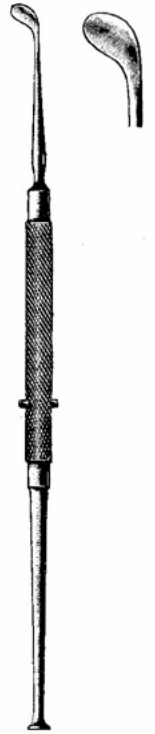
11665.04
4 mm



11665.05
5 mm

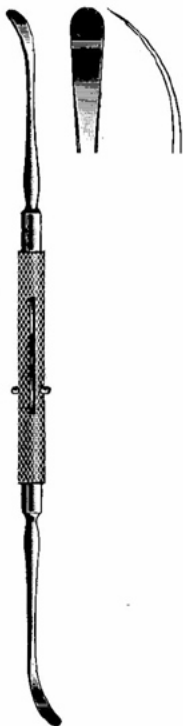


Freer
15,0 cm
11669.15

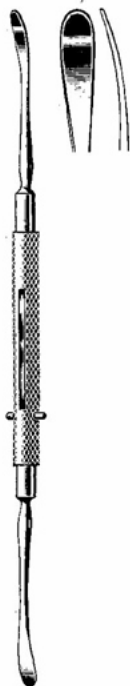


Freer
19,0 cm
11670.19

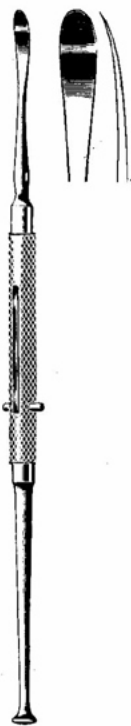
Septum-Elevatorien
Septum Elevators
Elévateurs pour la cloison nasale
Elevadores para tabique
Elevatori per setto



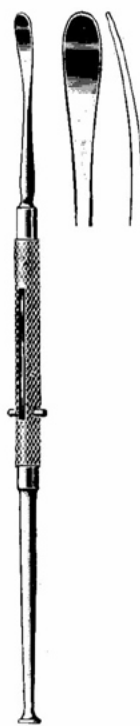
Roger
19,0 cm
11672.19



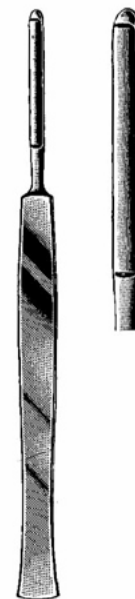
Freer
18,0 cm
11673.18



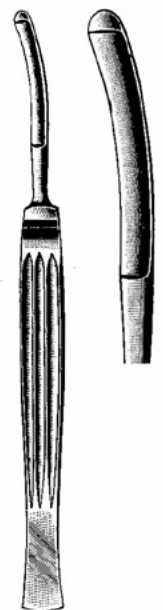
Freer
19,0 cm
11674.19



Freer
19,0 cm
11675.19



Joseph
16,0 cm
11677.16

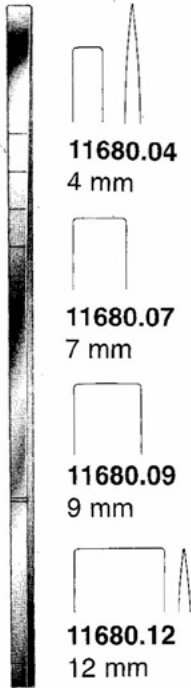


Converse
16,0 cm
11679.16

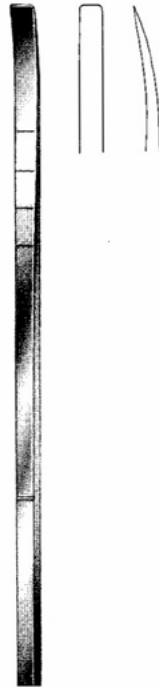
MATTES

RHINOLOGIE
RHINOLOGY
RHINOLOGIE
RINOLOGÍA
RINOLOGIA

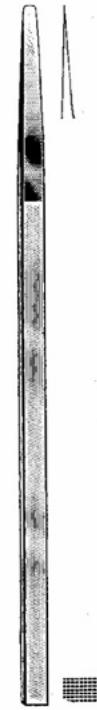
Nasenplastik-Meißel
 Rhinoplastic Chisels
 Ciseaux-burins pour la plastique nasale
 Cinceles para la plástica nasal
 Scalpelli per plastica nasale



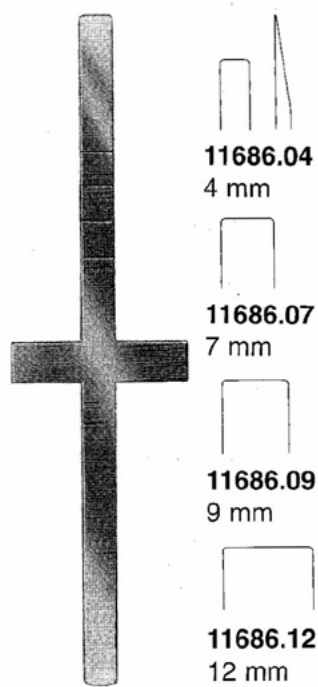
Cottle 18,0 cm
11680.04 - 12



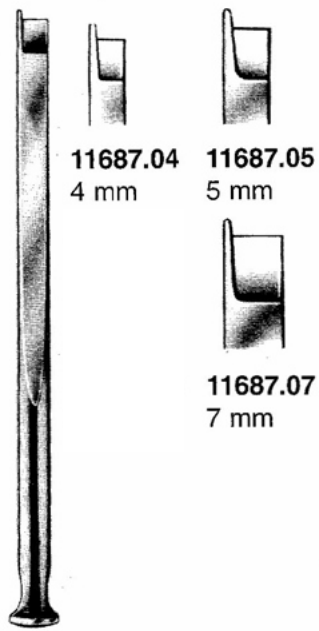
Cottle 18,0 cm/6 mm
11682.06



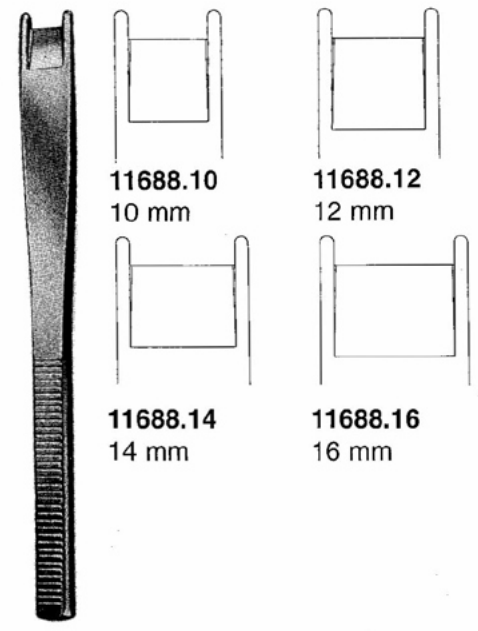
11684.04
 4 mm
11684.07
 7 mm
11684.12
 12 mm
Cottle 18,0 cm
11684.04 - 12



Cottle 18,0 cm



Fomon 17,0 cm



Cinelli 16,0 cm

RHINOLOGIE
RHINOLOGY
RHINOLOGIE
RINOLOGÍA
RINOLOGIA



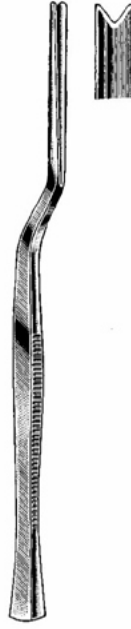
West
16,0 cm
11690.16



West
16,0 cm
11692.16



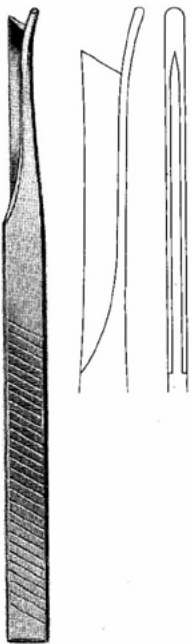
Freer
16,0 mm/6 mm
11693.06



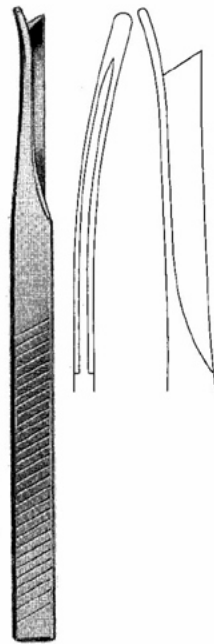
Killian-Claus
5 mm
11694.17



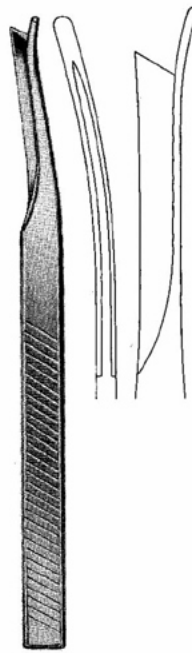
mm	Hajek
4	11695.04
6	11695.06
8	11695.08



Silver
18,0 cm
11697.01



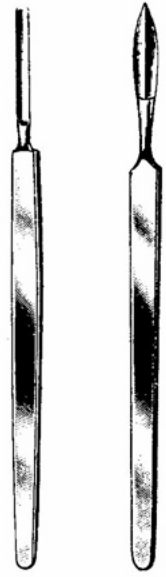
Silver
18,0 cm
11697.02



Silver
18,0 cm
11697.03



Cottle
15,0 cm
11698.15



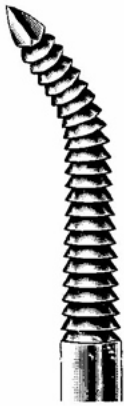
Cottle 15,0 cm
11699.15 11700.15

MATTES

RHINOLOGIE
RHINOLOGY
RHINOLOGIE
RINOLOGÍA
RINOLOGIA



Lewis
18,0 cm



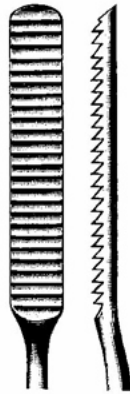
11710.01



11710.02



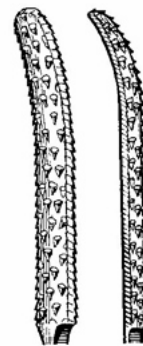
Maltz
21,0 cm
11712.21



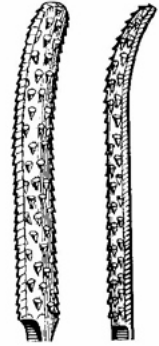
11714.01
Fig. 1



Gallaher
16,0 cm
11714.01 - 03



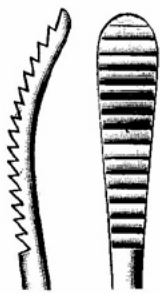
11714.02
Fig. 2



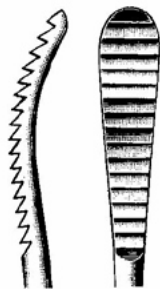
11714.03
Fig. 3



Wiener 21,0 cm



11716.01
Fig. 1



11716.02
Fig. 2



Fomon
Hartmetall
Tungsten carbide



TC 8445.01



TC 8445.02



TC 8445.03



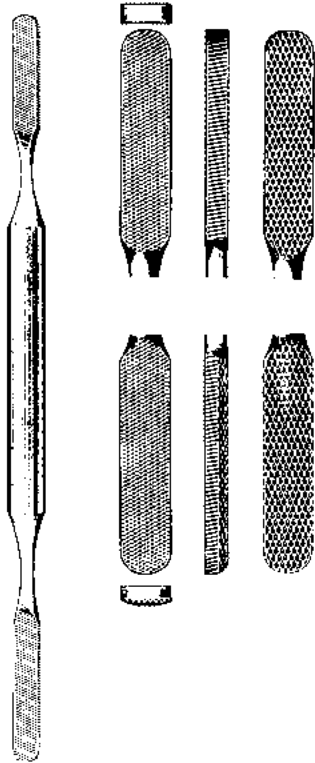
TC 8445.04



TC 8445.05



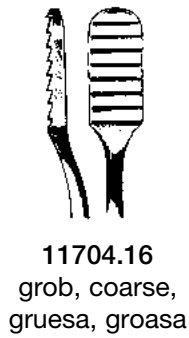
NASENRASPELN
NASAL RASPS
ESCOFINAS NASALES
RASPA NASALE



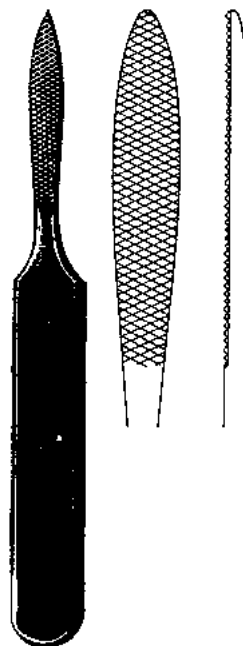
Fomon
11701.21 21 cm



11703.16
 fein, fino
 fine, fina



11704.16
 grob, coarse,
 gruesa, groasa

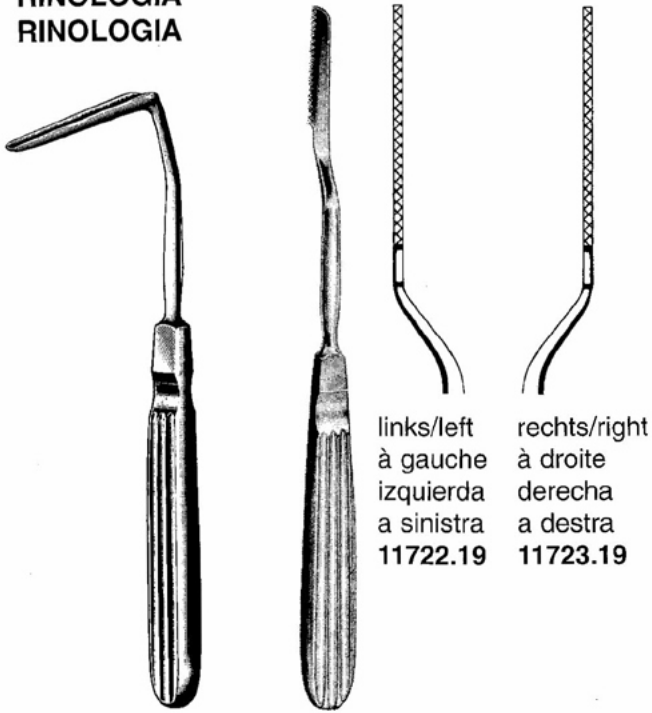


Joseph
11705.16
 16 cm

Joseph (Lewis)
11703.16 - 11704.16
 18 cm

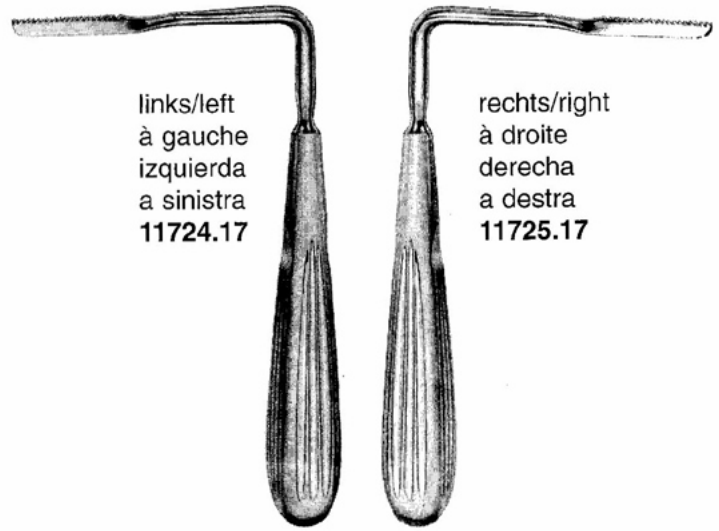
MATTES

RHINOLOGIE
RHINOLOGY
RHINOLOGIE
RINOLOGÍA
RINOLOGIA



Aufricht
16,0 cm
11720.16

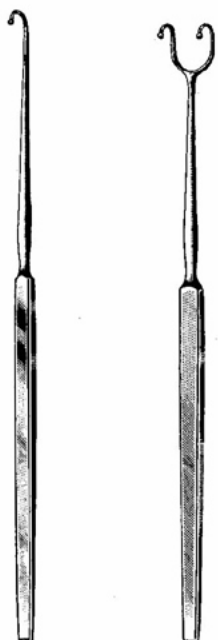
Joseph
19,0 cm
11722.19 – 11723.19



links/left
à gauche
izquierda
a sinistra
11724.17

rechts/right
à droite
derecha
a destra
11725.17

Joseph 17,0 cm
11724.17 – 11725.17



Fomon
17,0 cm
11728.17

Fomon
16,0 cm
11729.16



Cottle-Neivert
11730.20

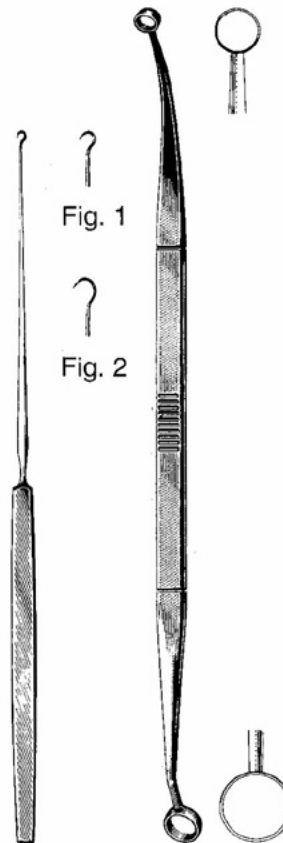
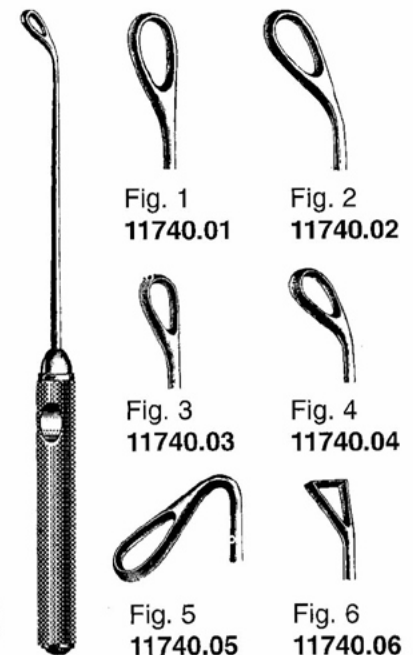


Fig. 1 **Gillies**
1 11735.01
2 11735.02

Faulkner
11737.21



Coakley
17,0 cm
11740.01 – 06

RHINOLOGIE
RHINOLOGY
RHINOLOGIE
RINOLOGÍA
RINOLOGIA



Barnhill
21,0 cm



Fig. 1
11750.01



Fig. 2
11750.02



Fig. 3
11750.03



Fig. 4
11750.04



Fig. 1
11755.01

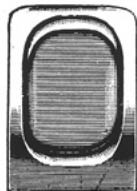


Fig. 2
11755.02

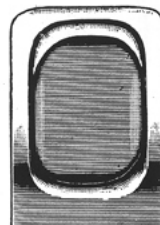
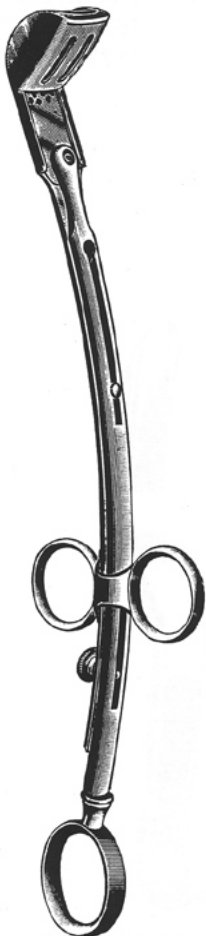
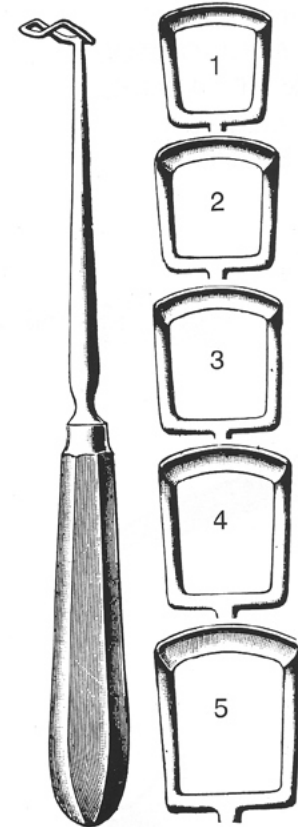


Fig. 3
11755.03



La Force
25,0 cm

Tonsillenmesser
Pharynx-Tonsillotome
Adenotomes
Adenotomes
Adenotomos



Beckmann
22,0 cm
11752.01 – 11752.05

1

11752.01

2

11752.02

3

11752.03

4

11752.04

5

11752.05



Fig. 1
11758.01



Fig. 2
11758.02



Fig. 3
11758.03



Fig. 4
11758.04



St. Clair-Thomson 21,0 cm

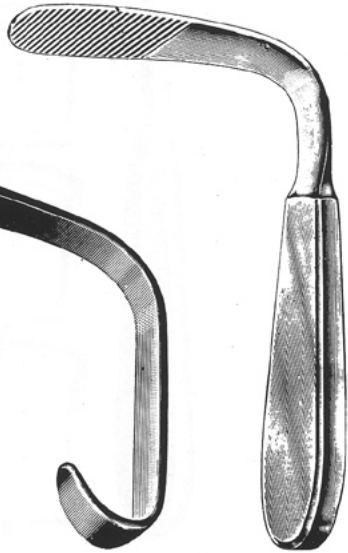
MATTES

MUND UND ZUNGE
MOUTH AND TONGUE
BOUCHE ET LANGUE
BOCA Y LENGUA
BOCCA E LINGUA

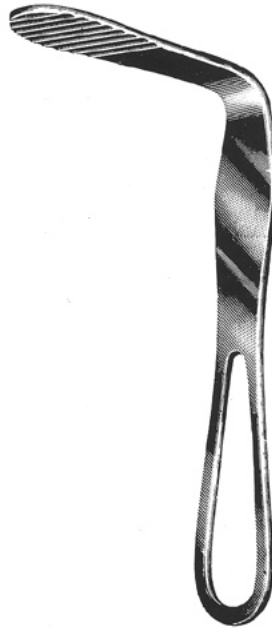
Zungenspatel, Lippenhalter
 Tongue Depressors, Lip Retractors
 Abaisse-langue, écarteurs des lèvres
 Abajalengua, Separadores de labios
 Abbassalingua, Divaricatori di labbra



Andrew
 11,0 cm
 11770.11



Tobold
 14,5 cm
 11771.14



Hartmann
 15,0 cm
 11772.15



Brünings
 19,0 cm
 11775.19



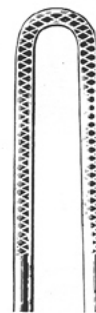
Buchwald
 19,0 cm
 11776.19



cm **Sternberg**
 14 11779.14
 16 11779.16



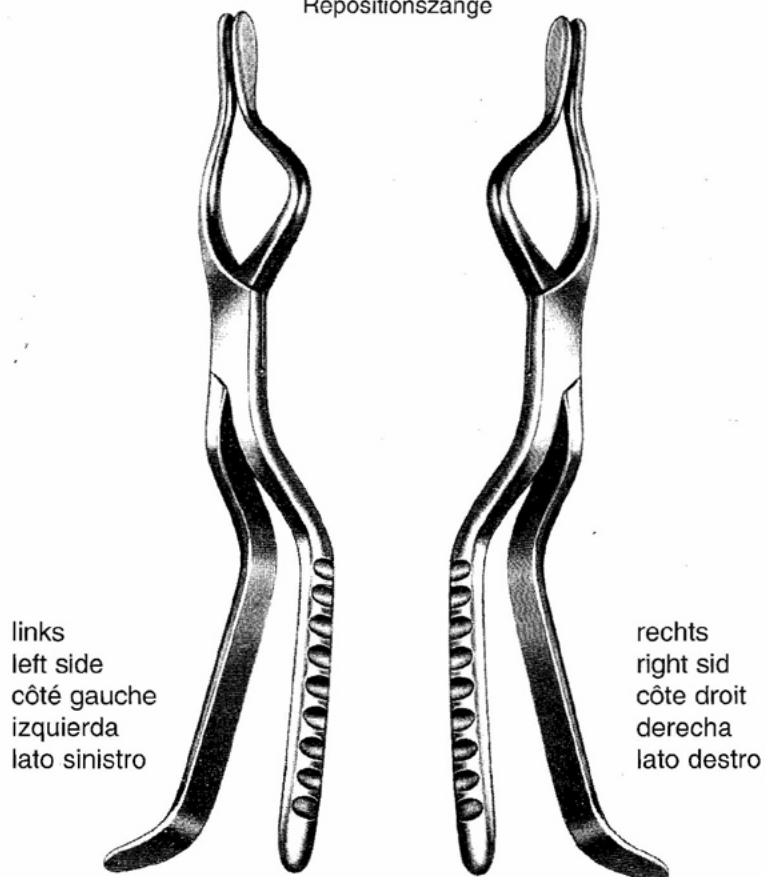
Frenzel
 16,0 cm
 11780.16



Mundwinkel-Halter
 16,0 cm
 11782.16

MUND
MOUTH
BOUCHE
BOCA
BOCCA

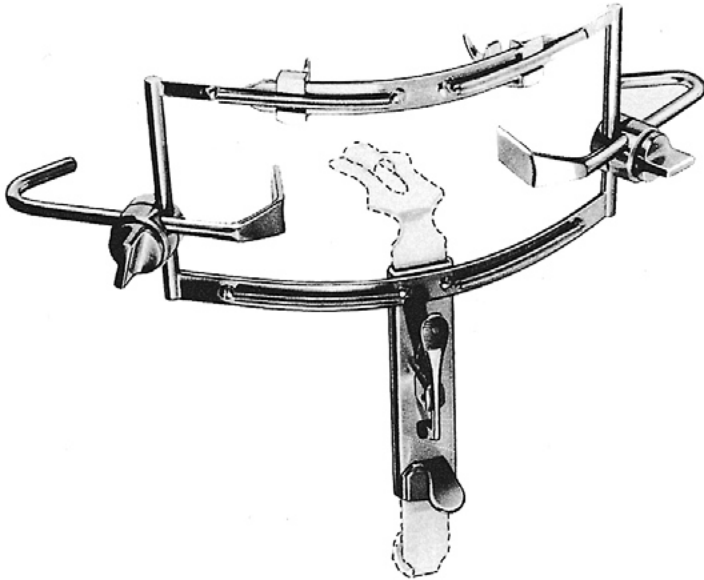
Repositionszange



cm	Rowe	Rowe	
22,5	12005.22	12007.22	Säugling/baby/bébé/bebé/lattante
23,5	12005.23	12007.23	Kinder/child/enfant/niño/bambino
24,0	12005.24	12007.24	Erwachsene/adult

MATTES

**MUNDSPERRER
MOUTH GAGS
ABRE-BOCAS
APRIBOCCA**



**Dingmann
12008.10**
Sperrer allein, Gag only
Abre-boca solo, Apribocca solo

12008.00 komplett
mit 3 auswechselbaren Zungendrucker,
2 seitliche Wangenhaken und 2 Zahnhaken

with 3 interchangeable tongue depressors,
2 rotating cheek holders
2 movable tooth hooks and thread guide

con 3 baja lenguas intercambiables,
2 valvulas giratorias p. las labios,
2 ganchos graduables

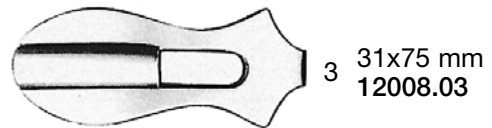
con 3 depressori intercambiabili,
2 valve laterali rotative
2 uncini a denti mobile e guida dentale



1 24x62 mm
12008.01



2 28x65 mm
12008.02



3 31x75 mm
12008.03

**ZUNGENSPATEL, WANGEN- UND LIPPENHALTER
TONGUE DEPRESSORS, CHEEK AND LIP RETRACTORS
BAJA-LENGUAS, SEPARADORES PARA LABIOS Y MEJILLAS
ABBASSALINGUA, DIVARICATORI PER GUANCE E LABBRA**



**Mayo
12009.17** 17 cm



**Kroenig
12010.15** 15 cm



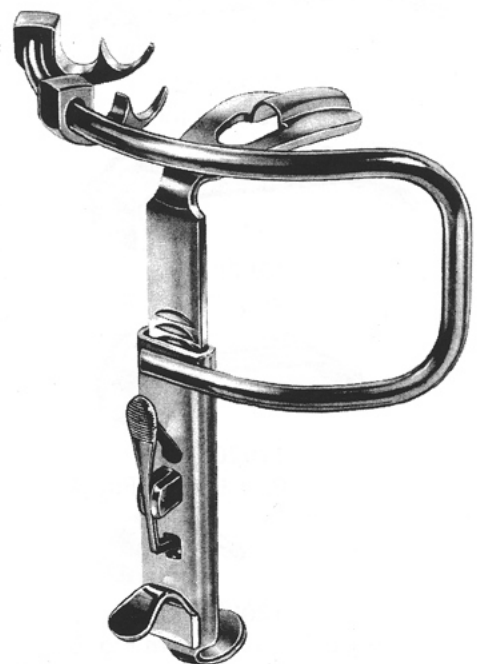
12011.15
14,5 cm



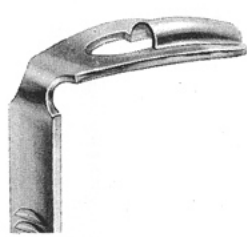
12012.15
14,5 cm

MUND UND ZUNGE
MOUTH AND TONGUE
BOUCHE ET LANGUE
BOCA Y LENGUA
BOCCA E LINGUA

Mundsperrer
Mouth Gags
Ouvre-bouche
Abrebocas
Apribocca



Killner Doughty komplett
12015.10



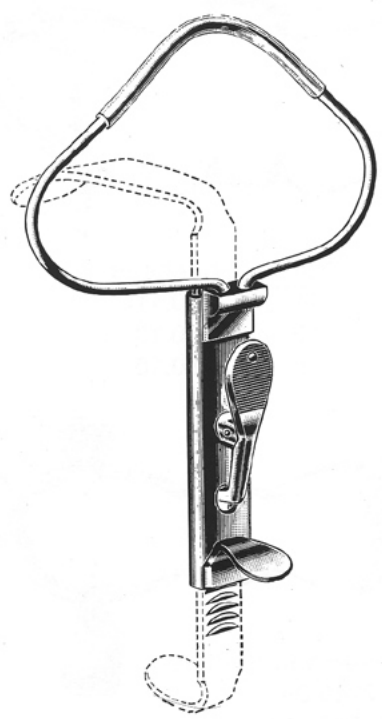
12015.01
Fig. 1



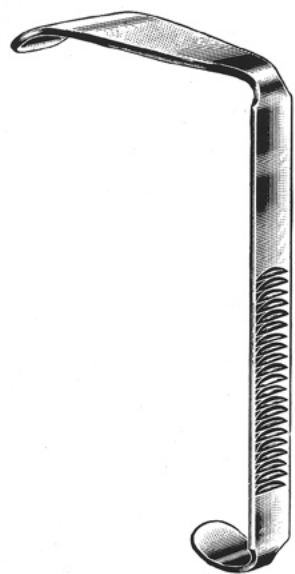
12015.02
Fig. 2



12015.03
Fig. 3



Mc Ivor komplett
12017.10



12017.01
27 x 95 mm
Fig. 1



12017.02
22 x 85 mm
Fig. 2

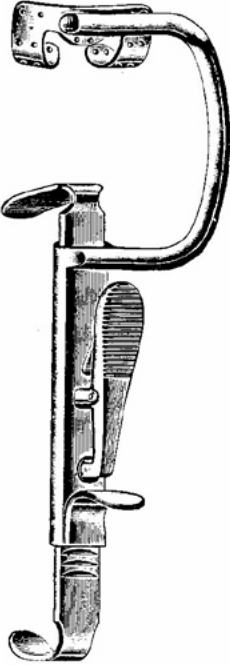


12017.03
22 x 70 mm
Fig. 3

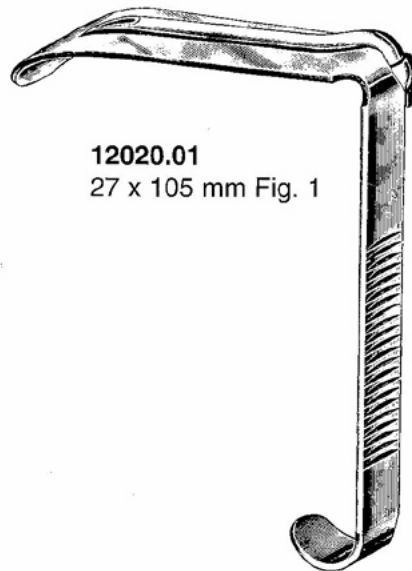
MATTES

MUND UND ZUNGE
MOUTH AND TONGUE
BOUCHE ET LANGUE
BOCA Y LENGUA
BOCCA E LINGUA

Mundsperrer
Mouth Gags
Ouvre-bouche
Abrebocas
Apribocca



Davis Boyle komplett
12020.10



12020.01
27 x 105 mm Fig. 1



12020.02
25 x 90 mm Fig. 2



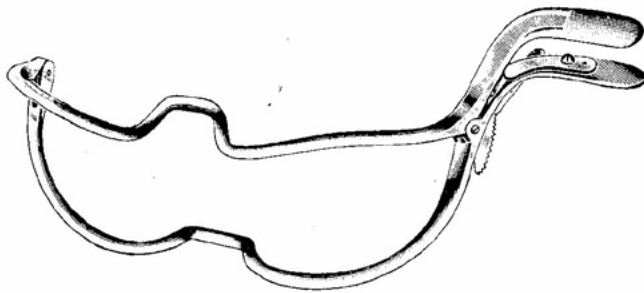
12020.03
25 x 75 mm Fig. 3



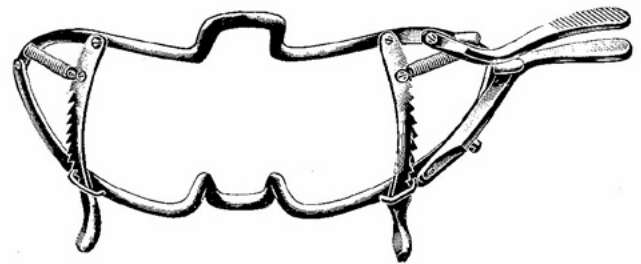
12020.04
22 x 60 mm Fig. 4



12020.05
20 x 25 mm Fig. 5



cm	Jennings
9	12300.09
11	12300.11
13	12300.13
15	12300.15

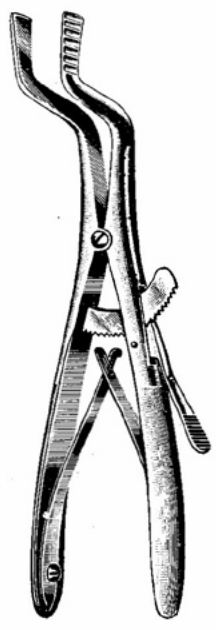


cm	Whitehead
11	12280.11
13	12280.13
15	12280.15

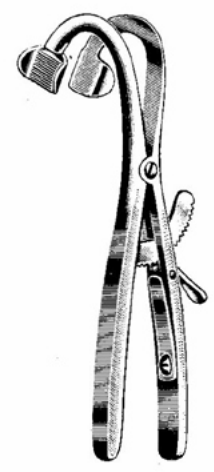
MUND UND ZUNGE
MOUTH AND TONGUE
BOUCHE ET LANGUE
BOCA Y LENGUA
BOCCA E LINGUA



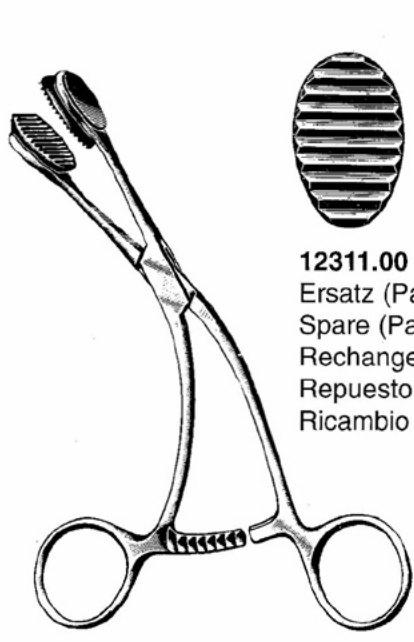
Zungendrucker
Moritz Schmidt
19,0 cm
12250.19



Roser König
cm
16 12270.16
19 12270.19

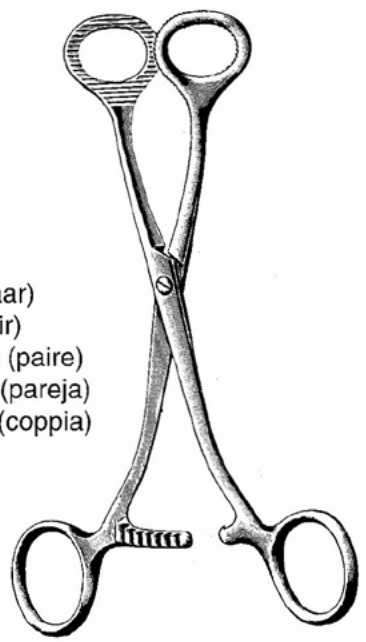


Denhart
12,0 cm
12272.12



12311.00
Ersatz (Paar)
Spare (Pair)
Rechange (paire)
Repuesto (pareja)
Ricambio (coppia)

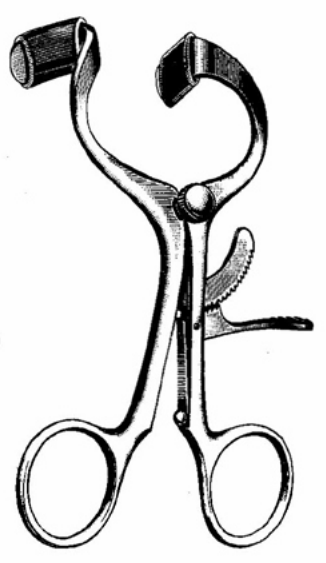
Young 17,0 cm
12310.17



cm Collin
16 12320.16
19 12320.19



Doyen Jansen 12,0 cm
12330.13



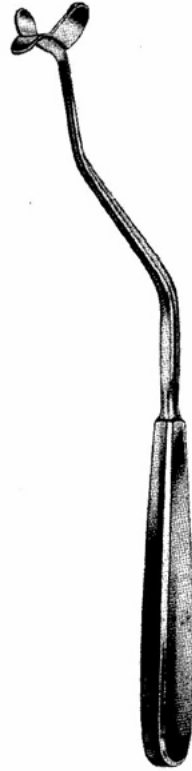
14,0 cm
12335.14

MATTES

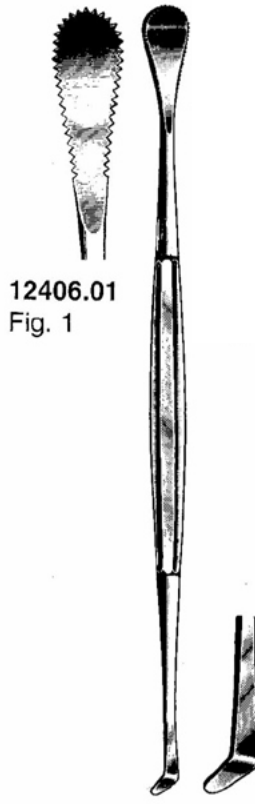
TONSILLEN
TONSILS
AMYGDALES
AMÍGDALAS
TONSILLE



Nager 23,0 cm
12400.23

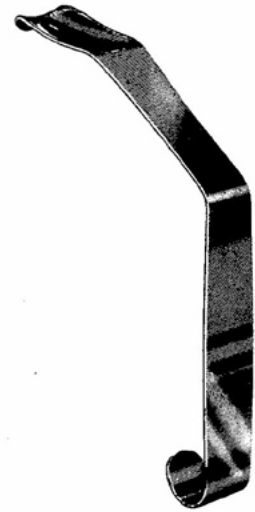


Hofer 24,0 cm
12402.24



12406.01
Fig. 1

Henke 23,0 cm
12406.01



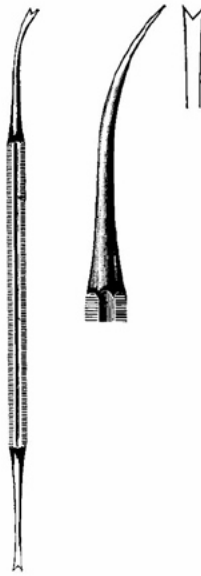
cm	Love
18	12408.18
20	12408.20
22	12408.22



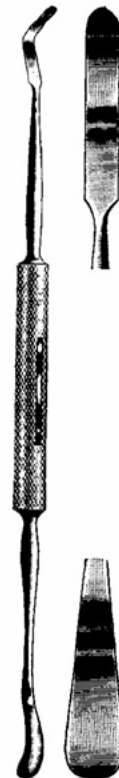
Hurd 22,0 cm
12410.22 – 12412.22

12410.22
gezahnt/serrated
dentelé/dentado
dentellato
22,0 cm

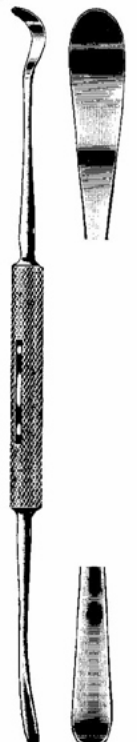
12412.22
glatt/smooth/lisse
liso/liscio
22,0 cm



Luniatschek 19,0 cm
12414.19

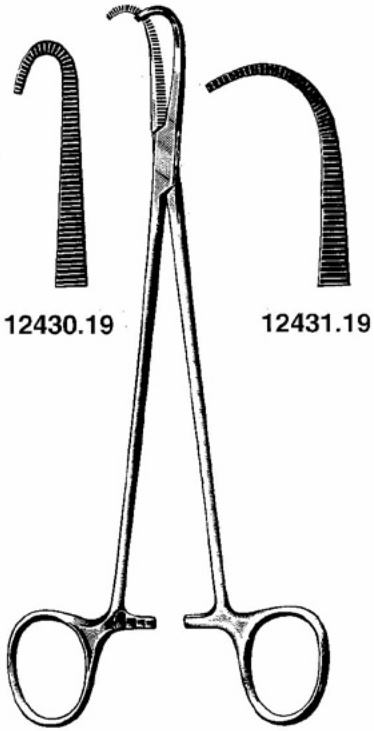


12416.24



Carpenter 24,0 cm
12418.24

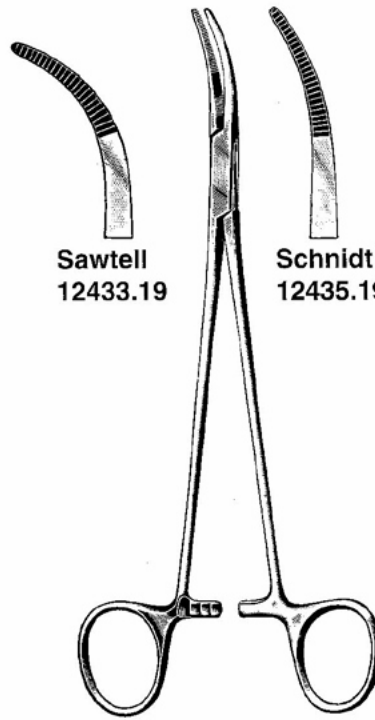
TONSILLEN
TONSILS
AMYGDALES
AMÍGDALAS
TONSILLE



12430.19

12431.19

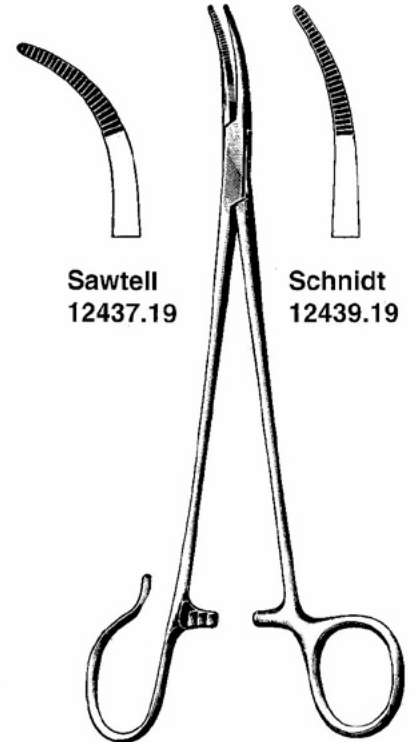
Negus 19,0 cm
12430.19 – 12431.19



Sawtell
12433.19

Schnidt
12435.19

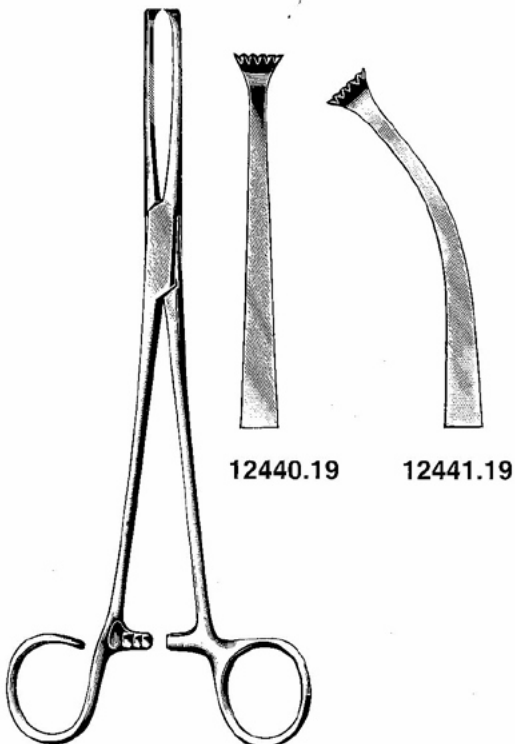
Sawtel-Schnidt 19,0 cm
12433.19 – 12435.19



Sawtell
12437.19

Schnidt
12439.19

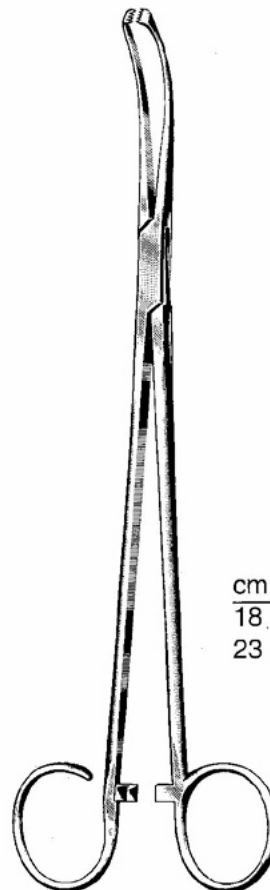
mit offenem Ring – open ring
12437.19 – 12439.19



12440.19

12441.19

Colver 19,0 cm

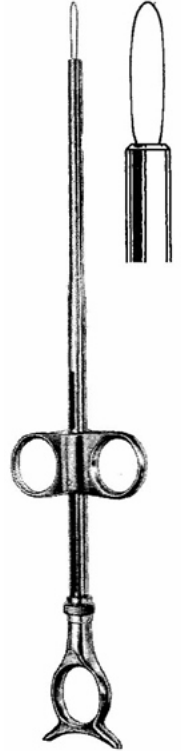


cm	
18	12445.18
23	12445.23

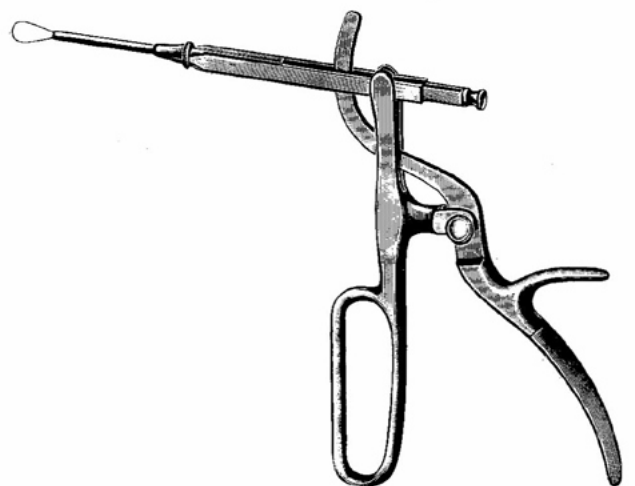
White

MATTES

TONSILLEN
 TONSILS
 AMYGDALES
 AMÍGDALAS
 TONSILLE



Eves 28,0 cm
 12468.28



Tyding
 12475.00
 mit 1 geraden Aufsatz
 with 1 straight tip
 à 1 embout droit
 con 1 punta recta
 con 1 punta retta

TONSILLEN-NADEL, TONSILLEN-MESSER
TONSIL NEEDLES, TONSIL-KNIVES
AGUJAS PARA SUTURAS DE AMÍGDALAS, BISTURIES PARA AMÍGDALAS
AGHI PER TONSILLE, COLTELLI PER TONSILLE



Nager
12479.24
 24 cm



Claus
12480.23
 23 cm



Dupuy-Weiss
12482.22 **12483.22**
 22 cm



Fisher
12485.22
 22 cm



Abraham
12487.21
 21 cm



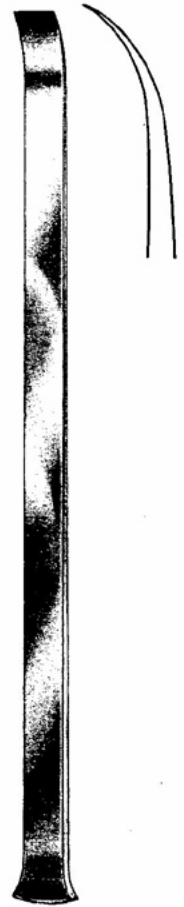
Sluder-Ballenger
12490.00
 mit 3 Aufsätzen
 with 3 blades
 avec 3 lames
 con 3 hojas
 con 3 lame

MATTES

RASPATORIES, AWLS, RETRACTORS FOR MOUTH-, JAW- AND FACE SURGERY
PERIOSTÓMOS, AGUJAS, SEPARADORES PARA CIRUGÍA PLÁSTICA
PERIOSTOTOMI, AGHI, DIVARICATORI PER CHIRURGIA PLASTICA



Obwegeser 23,0 cm
12604.23



Obwegeser 23,0 cm
12606.10

RASPATORIES FOR MOUTH-, JAW- AND FACE SURGERY
 PERIOSTÓMOS PARA CIRUGÍA PLÁSTICA
 PERIOSTOTOMI PER CHIRURGIA PLASTICA



Obwegeser
 17,5 cm
 12630.06 – 12630.11

6 mm



12630.06

7 mm



12630.07

9 mm



12630.09

11 mm



12630.11



Obwegeser 17,5 cm
 12635.17

5 mm



12640.05

7 mm



12640.07

9mm



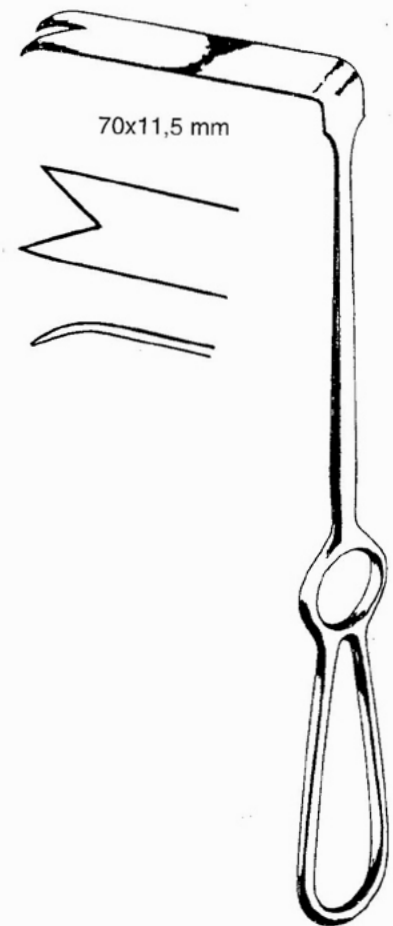
12640.09



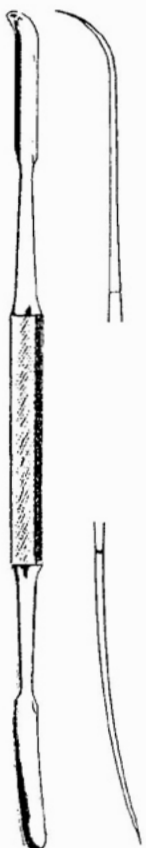
Obwegeser 20,0 cm
 12640.05 – 12640.09

MATTES

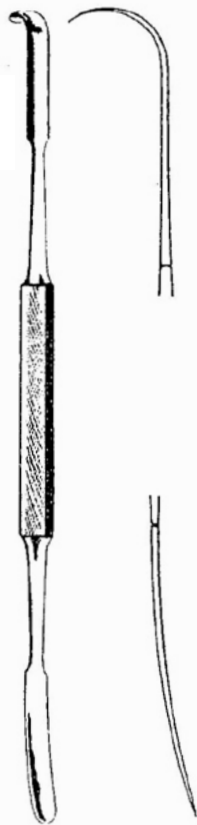
RETRACTOR, RASPATORIES FOR MOUTH-, JAW- AND FACE SURGERY
 SEPARADORES, PERIOSTÓMOS PARA CIRUGÍA PLÁSTICA
 DIVARICATORI, PERIOSTOTOMI PER CHIRURGIA PLASTICA



Ramus 22,0 cm
12652.22



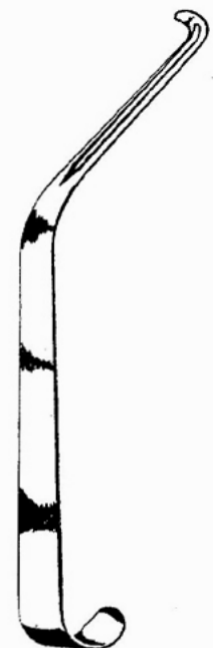
Obwegeser
21,0 cm
12655.21



Obwegeser
20,5 cm
12657.20

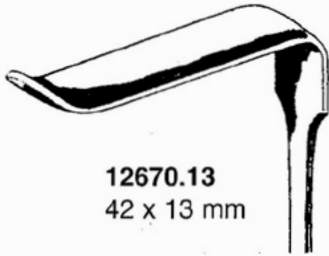


Obwegeser
15,5 cm
12659.15

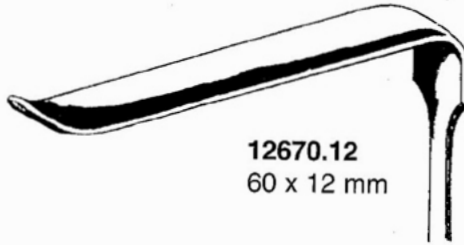


Obwegeser
16,0 cm
12660.16

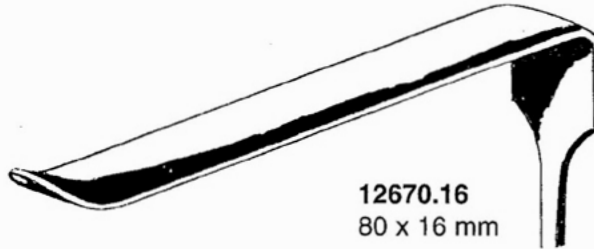
RETRACTORS FOR MOUTH-, JAW- AND FACE SURGERY
SEPARADORES PARA CIRUGÍA PLÁSTICA
DIVARICATORI PER CHIRURGIA PLASTICA



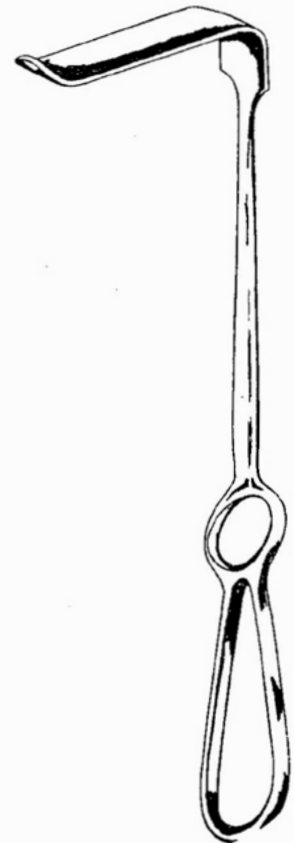
12670.13
42 x 13 mm



12670.12
60 x 12 mm



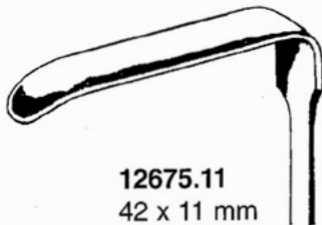
12670.16
80 x 16 mm



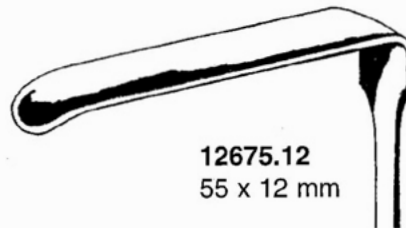
Obwegeser 22,0 cm
12670.12 – 12670.16



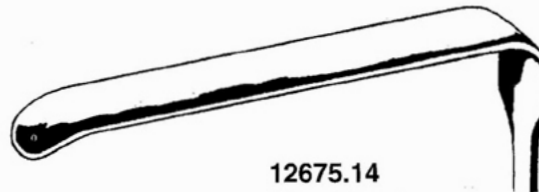
12675.10
31 x 10 mm



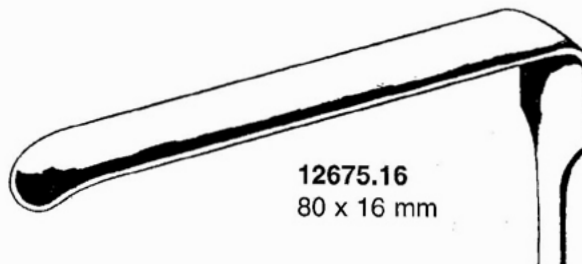
12675.11
42 x 11 mm



12675.12
55 x 12 mm



12675.14
70 x 14 mm

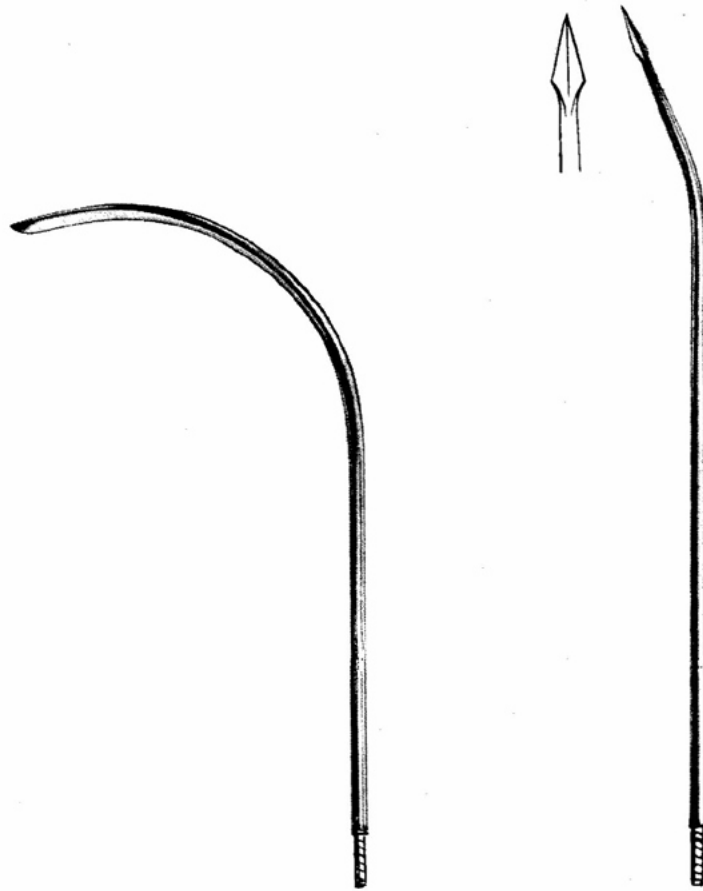


12675.16
80 x 16 mm



Obwegeser 22,0 cm
12675.10 – 12675.16

REDON NADELN
REDON NEEDLES



Charriere

- 8
- 10
- 12
- 14
- 16
- 18

- 13710.08
- 13710.10
- 13710.12
- 13710.14
- 13710.16
- 13710.18

- 13720.08
- 13720.12
- 13720.16
- 13720.18

Messerspitze geballt,
halbgebogen

Lanzettspitze

Gewindeansatz

A		Anuskop IVES-FANSLER		Atraumaklemme BAINBRIDGE	
Abfallzange SAUERBRUCH	369	ANVIL Nagelzange	371	Atraumaklemme BECK	148
Abortuskürette PESTALOZZA	365	Aorta Dilator COOLEY	165	Atraumaklemme COOLEY	161
Abortuslöffel CUZZI	365	Aorta Dilator TUBBS	165	Atraumaklemme COOLEY-DERRA	148
Abortuslöffel WALLICH	366	Aortaklemme DIETRICH	143	Atraumaklemme DE BAKEY	140-144
Abortuszange SAENGER	137	Aortaklemme WEBER	153	Atraumaklemme DE BAKEY	147
Abortuszange WINTER	365	Approximator BIEMER	469	Atraumaklemme DE BAKEY	149
ABRAHAM Tonsillen-Messer	439	Approximatoren BIEMER-MUELLER	468	Atraumaklemme DE BAKEY	151
Absaugkürette	361	Approximatoren MUELLER	467	Atraumaklemme DE BAKEY	152
ADSON anatomische Pinzette	44,45	ARCHER Splitterzange	47	Atraumaklemme DE BAKEY	154
ADSON Arterienklemme	106	ARRUGA Extraktionshaken	393	Atraumaklemme DE BAKEY	157
ADSON chirurgische Pinzette	44	ARRUGA Kapselpinzette	399	Atraumaklemme DE BAKEY	158,159
ADSON Durahaken	261	ARRUGA Lidsperrerr	388	Atraumaklemme DE BAKEY	160
ADSON Hypophyse-Pinzette	277	ARRUGA Nadelhalter	90	Atraumaklemme DE BAKEY	153
ADSON Raspator	269	Arterienklemme ADSON	106	Atraumaklemme DE BAKEY-MOSQUITO	146
ADSON Saugrohr	279	Arterienklemme ADSON-BABY	106	Atraumaklemme DE BAKEY-PEAN	146
ADSON Wundspreizer	226	Arterienklemme BAINBRIDGE	108	Atraumaklemme DERRA	148
ADSON Wundspreizer	227	Arterienklemme CRAFOORD	109	Atraumaklemme GLOVER	141,151
ADSON-BABY Arterienklemme	106	Arterienklemme CRAFOORD-SELLORS	110	Atraumaklemme neonatal	163-164
ADSON-BABY Wundspreizer	226	Arterienklemme CRILE	104	Atraumaklemme POTTS	150
ADSON-BROWN chirurgische Pinzette	45,50	Arterienklemme CRILE-RANKIN	104	Atraumaklemme POTTS	152
Ahle OBWEGESER	440	Arterienklemme DANDY	107	Atraumaklemme SUBRAMANIAN	162
ALAN-PARKS Mastdarm-Spekula	328	Arterienklemme DESJARDINS	112	Atraumatische Pinzette DE BAKEX	144-145
ALEXANDER Biopsiezange	298	Arterienklemme GEMINI	109	AUFRICHT Nasenhaken	428
ALEXANDER Flachmeissel	196	Arterienklemme GRAY	112	Aufsatz BARACANI	302
ALEXANDER Hohlmeissel	196	Arterienklemme GUYON	113	Aufsatz BRUENINGS	302
ALEXANDER Raspator	206	Arterienklemme HALSTED-MOSQUITO	106	Aufsatz CORDES	302
ALLEN Blinddarmklemme	132	Arterienklemme HARTMANN	103,104	Aufsatz FLATAU	302
ALLIS Darmfasszange	121	Arterienklemme HEISS	117	Aufsatz FRAENKEL	302
ALLIS Darmfasszange atrauma	121	Arterienklemme JOHNS-HOPKINS	111	Aufsatz KRAUSE	302
ALLIS-ADAIR Darmfasszange	121	Arterienklemme KELLY	103	Aufsatz LANGE	302
ALLIS-BABY Darmfasszange	121	Arterienklemme KELLY-RANKIN	104	Aufsatz SCHEINMANN	302
ALLISON Lungenspatel	310	Arterienklemme KOCHER	103,105	Aufsatz SCHUMACHER	302
ALM Wundhaken	229	Arterienklemme LAHEY	117	Aufsatz SEIFERT	302
Amniotom BEACHAM	350	Arterienklemme LAWRENCE	111	Augenmagnet	400
Amputationsmesser CATLIN	10,12	Arterienklemme LERICHE	107	Augenschere BARRAQUER	401
Amputationsmesser LANGENBECK	10,12	Arterienklemme LOVELACE	107	Augenschere NOYES	401
Amputationsmesser LISTON	10,12	Arterienklemme LOWER	117	Augenschere VANNAS	401
Amputationsmesser CHARRIERE	194	Arterienklemme MAYO-GUYON	113	Augenschere WECKER	401
Amputationssäge SATTERLEE	194	Arterienklemme MEEKER	111	Augenschere WESTCOTT	67
Anast.Klemme DE MARTEL-WOLFSON	134	Arterienklemme MICRO-HARTMANN	103,104	AUVARD Scheidenspekula	339
anatomische Pinzette	44	Arterienklemme MIXTER	111	AYER Chalazionspinzette	399
anatomische Pinzette ADSON	44	Arterienklemme MIXTER	112		
anatomische Pinzette BONNEY	45,85	Arterienklemme MIXTER-BABY	106	B	
anatomische Pinzette CUSHING	85	Arterienklemme MOYNIHAN	112	BABCOCK Darmfasszange	121
anatomische Pinzette GERALD	85	Arterienklemme O'SHAUGNESS	111	BABINSKY Perkussionshämmer	15
anatomische Pinzette INDOE	44	Arterienklemme OVERHOLT GEISSEND	108	BABY-TISCHLER Biopsiezange	351
anatomische Pinzette MC INDOE	44	Arterienklemme PEAN	103,105	BABY-YANKAUER Saugrohr 21cm	17
anatomische Pinzette POTTS-SMITH	44	Arterienklemme PEAN	102	BACKHAUS Tuchklemme	127
anatomische Pinzette SEMKEN	44	Arterienklemme PEAN	105	BAILEY Rippenkontraktor	310
anatomische Pinzette USA	44	Arterienklemme PENNINGTON	107	BAILEY-BABY Rippenkontraktor	310
ANDERSON-ADSON Wundspreizer	226	Arterienklemme PROVIDENCE-HOSPITAL	103	BAINBRIDGE Arterienklemme	108
ANDREW Zungendrücker	430	Arterienklemme ROBERTS	108	BAKES Gallengangdilatoren	122
Aneurysmen Gefäßclip YASARGIL	452	Arterienklemme ROCHESTER-CARMALT	107	BALFOUR Bauchdeckenhalter	235,240
Anlegepinzette BIEMER	466	Arterienklemme ROCHESTER-OCHSNER	105	BALLENGER Schwingmesser	423
Anlegepinzette BIEMER	467	Arterienklemme RUMEL	108	BALLENGER Septum Elevator	421
Anlegepinzette BIEMER	469	Arterienklemme SAROT	109	BALLENGER Tonsillenzange	438
Anlegepinzette MEHDORN	465	Arterienklemme SPENCER-WELLS	103	Bandscheibenstanze COLGLOUGH	294
Anlegepinzette BIEMER	464	Arterienklemme STILLE	113	BARACANI Aufsatz	302
Anlegezange f. Aneurysmen Clips	460	Arterienklemme TOENNIS	110	BARANY Lärmtrommel	404
Anlegezange JOHNS-HOPKINS	48	Arterienklemme ZENKER	109	BARBARA Hähchen	413
Anlegezange MC KENZIE	273	Arthroskopiezangen	446	BARBARA Nadel	413
Anlegezange OLIVECRONA-TOENNIS	273	ASCH Septumrichtzange	420	BARNHILL Ringmesser	429
Anlegezange RANEY	274	Atrauma Bulldogklemme	140-142	BARON Saugrohr	279
Anlegezange SMITHWICK	273	Atrauma Bulldogklemme DE BAKEY	140	BARR Mastdarm-Spekula	329
Anlegezange SWEET	273	Atrauma Bulldogklemme GLOVER	141	BARRAQUER Augenschere	401
Antrum Kürette COAKLEY	428	Atrauma Darmfasszange	131	BARRAQUER Irispinzette	398
Antrum Raspel GALLAHER	426	Atrauma Darmfasszange ALLIS	121	BARRAQUER Lidsperrerr	388
Antrum Raspel LEWIS	426	Atrauma Gewebefasszange	131	BARRAQUER Mikro-Nadelhalter	90
Anuskop HIRSCHMANN	332	Atrauma Kardiovaskular-Klemme	161,162	BARRAQUER-KATZIN Irispinzette	398
				BARRET Hakenzange	347
				BARTON Geburtszange	364

BARTON Zughebel	364	Blasenwundspreizer LEGUE	323	BUNT Sterilisierklammer	369
Batteriegriff für Laryngoscope	26	Blasenwundspreizer MILLIN	323	BUNT Sterilisierklammer	369
Batterieladegerät für Laryngoscope	26	Blasenwundspreizer THOMSON-WALKER	323	BUREN Knochenhaltezange VAN	255
Bauchdeckenhalter BALFOUR	235,240	Bleihand für Erwachsene	210	BURKE Biopsiezange	305
Bauchdeckenhalter COLLIN	232	Bleihand für Kinder	210	Bürstenspender	379
Bauchdeckenhalter COLLIN-LOKTITE	238	Blinndarmklemme ALLEN	132	BUSCH Nabelschnurschere	61
Bauchdeckenhalter DENIS-BROWN	242	Blinndarmklemme KLEINSCHMIDT	132		
Bauchdeckenhalter DOYEN	236	BLOHMKE Tonsillenzange	438		
Bauchdeckenhalter FRAZIER	239	BLOUNT Knochenheber	260	C	
Bauchdeckenhalter GOSSET	239	BLOUNT Meniskushaken	260	CAROLL Sehnenfassinstrument	272
Bauchdeckenhalter KIRSCHNER	241	BLUMENTHAL Hohlmeißelzange	245	CARPENTER Tonsillen Messer	436
Bauchdeckenhalter O'SULLIVAN-O'CONN.	239	BODENHAMMER Mastdarm-Spekula	328	CASPAR Wundspreizer	231
Bauchdeckenhalter RICARD	237,238	BOEHLER Extensionsbügel	205	CASPAR Wundspreizer	233
Bauchdeckenhalter ROCHARD	236	BOEHLER Hohlmeißelzange	247	CASTANEDA Neonatal-Klemme	163,164
Bauchspatel HABERER	120	BOEHLER Knochensplitterzange	252	CASTROVIEJO Diszisionsmesser	392
Bauchspatel REVERDIN	190	BOERMA Geburtszange	364	CASTROVIEJO Hornhautschere	401
Bauchspatel RIBBON	190	BOETTCHER Tonsillenschere	56	CASTROVIEJO Klingenbrecher	41
BAUMGARTNER Nadelhalter	89,94	Bohrapparat elektrisch	224	CASTROVIEJO Messzirkel	396
BAYHA Klängen + Griffe	37	Bohrapparat STILLE-SHERMAN	204,218	CASTROVIEJO Nadelhalter	88+95
BEACHAM Amniotom	350	Bohrdraht KIRSCHNER	266-268	CATLIN Amputationsmesser	10
Beckenzirkel COLLIN	346	Bohrer	204,220	Chalazionskürette MEYHOEFER	395
Beckenzirkel MARTIN	346	BOIS Elevator	206	Chalazionskürette AYER	399
BECKMANN Ringmesser	429	BOLZEN Schneider	215	Chalazionskürette DESMARRÉS	399
BECKMANN Wundspreizer	227	BONNEY chirurgische Pinzette	45	CHAPUT Gewebefasszange	102
BECKMANN-EATON Wundspreizer	227	BOSE Trachealhaken	170	CHARRIERE Amputationssäge	194
BEEBEE Kronenschere	59	BOWMAN Lidsperrer	388	CHEATLE Sterilisierzange	369
BEER Cilienpinzette	400	BOWMAN Tränenkanalsonde	394	CHELSEA-EATON Proktoskop	332
BELLUCCI Mikro Ohrschere	408	Box PETRI	375	CHERON Tamponzange	120
BENNETT Knochenheber	259	BOZEMANN Tamponzange	119	CHERRY Laminektomie-Sperrer	318
BENSON Polyrusspreizer	132	BRAND Sehnenfassinstrument	272	CHILDE Wundklammerzange	97
BERGER Biopsiezange	306	BRAND Sehenschäler	272	Chirurg. Schere IRIS	56
BERGMANN Hammer	211	BRAUN Dekapitationshaken	366	Chirurg. Schere JOSEPH	58
BERGMANN Verbandschere	72	BRAUN Hakenzange	347	Chirurg. Schere KILNER	56
BERRY Drahtkneifzange	223	BRAUN Kranioclast	366	Chirurg. Schere REYNOLDS	58
BETHUNE Rippenschere	311	BRAUN Uterus Depressor	350	Chirurg. Schere METZENBAUM	55,57
BEYER Hohlmeißelzange	249	BRAUN-STADLER Episiotomie Schere	72	Chirurgische -Scheren standard-	54-62
BEYER Hohlmeißelzange	246	BREISKY Scheidenspekula	340	Chirurg. Pinzette	45
BIEMER Anlegepinzette	469	Broncho-Zange CHEVALIER-JACKSON	296	Chirurg. Pinzette	46
BIEMER Anlegepinzette	467	Bronchusklemme FINOCCHIETTO	128	Chirurg. Pinzette	85
BIEMER Anlegepinzette	469	Bronchusklemme HARRINGTON	128	Chirurg. Pinzette ADSON	45
BIEMER Anlegezange	464	Bronchusklemme PRICE-THOMAS	128	Chirurg. Pinzette ADSON-BROWN	45
BIEMER Approximator	469	Bronchusklemme SEMB	129	Chirurg. Pinzette BONNEY	45
BIEMER-MUELLER Approximatoren	466	BRUENINGS Aufsatz	302	Chirurg. Pinzette FERRIS-SMITH	46
BILLEAU Ohrschlinge	405	BRUENINGS Ohrspekula	404	Chirurg. Pinzette GERALD	45
Biopsiekürette HEANY	350	BRUENINGS Septumzange	416	Chirurg. Pinzette LANE	46
Biopsiekürette MÜNCHEN	350	BRUENINGS Tonsillen Messer	423,439	Chirurg. Pinzette OEHLER	84
Biopsiekürette NOVAK	344	BRUENINGS Verlängerungsrohr	302	Chirurg. Pinzette POTTS-SMITH	45
Biopsiekürette RANDALL	344	BRUENINGS Zungenspatel	430	Chirurg. Pinzette SEMKEN	45
Biopsie- und Absaugkürette	361	BRUNETTI Meissel	263	Chirurg. Pinzette TAYLOR	46
Biopsiezange ALEXANDER	7,298	BRUENINGS Tonsillenschnürer	420	Chirurg. Pinzette USA	46
Biopsiezange BURKE	305	BRUNNER Führungshohlsonde	100	Cilienpinzette BEER	400
Biopsiezange EPPENDORFER	305	BRUNNER Magen-Darmklemme	131	Cilienpinzette DOUGLAS	400
Biopsiezange FAURE	296	BRUNNER Rippenschere	311	Cilienpinzette LITTAUER	400
Biopsiezange KEVORKIAN	298	BRUNNER Wundhaken	180-187	CINELLI Septum Meissel	424
Biopsiezange SCHUBERT	296	BRUNS Löffel	287	Circumcisionsgerät	325
Biopsiezange SCHUHMACHER	298	BRUNS Scharfe Löffel	290	Circumflex Schere	66
Biopsiezange THOMAS-GAYLOR	296	BRUNS Verbandschere	72	CITELLI Stanze	419
Biopsiezange TISCHLER	1,351,307	BRYANT Tupferzange	120	CLAR Stirnlampe	16
Biopsiezange TISCHLER-MORGAN	1,351	BUCHWALD Zungenspatel	430	CLARK Lidsperrer	388
Biopsiezange TOWNSEND	1,351	BUCK Fremdkörperheber	406	CLEVELAND Hohlmeißelzange	244
Biopsiezange TOWNSEND-MINI	1,351	BUCK Ohrkürette	405	CLOWARD Laminektomie Zange	299
Biopsiezange VAN-DOREN	298	BUCK Perkussionshämmer	15	CLOWARD Wirbelkoerperspreizer	282
Biopsiezange WITTNER	307	BUIE Rektal Absaugrohr	304	CLOWARD Wundsperrer	230
Bipolare Kabel	386	Bulldogklemme Atrauma DEBAKEY	140	COAKLEY Antrum Kürette	428
Bipolare Pinzette	384-386	Bulldogklemme Atrauma GLOVER	141	COAKLEY Kieferhöhlentriakar	284
BISHOP-HARMAN Irispinzette	398	Bulldogklemme DEBAKEY DIETRICH	143	COBB Flachmeissel	199
BLAKE Gallensteinzange	123	Bulldogklemme DIETRICH	143	COBB Hohlmeissel	199
BLAKE Uteruskürette	346	Bulldogklemme JOHNS-HOPKINS	48	COLCLOUGH Bandscheibenstanze	294
Blasenhalssperrer MILLIN	323	BUMM Uteruskürette	358	COLLIN Bauchdeckenhalter	232,238
Blasenspatel KOCHER	323	BUMM Uteruskürette	358	COLLIN Beckenzirkel	346
Blasenspatel LEGUEU	323	BUNELL Handbohrapparat	224		
Blasenwundspreizer JUDD-MASSON	323	BUNELL Sehnenführer	272		

Dura Dissektor HOEN	276
Dura Dissektor HOLLISLEY	276
Dura Dissektor MORGAN	275
Dura Dissektor OLIVECRONA	275
Dura Dissektor PENFIELD	276
Dura Dissektor SACHS	275
Dura Dissektor TOENNIS	275
Dura Haken JACOBSON	278
Dura Messer KOOS	278
Durahaken	278
DURANTE Fasspinzette	45
DUVAL Darmfasszange	130
DUVAL Fasspinzette	46

E

ECHLIN Hohlmeißelzange	248
elektrische Gipssäge	73
elektrischer Bohrrapparat	224
Elektrodenbandschlinge	383
Elektrodenrahtschlinge	383
Elektrodenlanzette	383
Elektrodenmesser	383
Elektrodennadel	382
Elektrodenschlinge	383
Elevator ADLERDYCE	269
Elevator BOIES	206
Elevator COTTLE	421
Elevator CREGO	269
Elevator GORNEY	206
Elevator KEY	269
Elevator LEMPERT	413
Elevator MC DONALD	269
Elevator SAYRE	269
Elevator Septum	421-423
Elevator Septum BALLENGER	421-423
Elevator Septum COTTLE	421
Elevator Septum FREER	421
Elevator Septum JOSEPH	421
Elevator Septum KILLIAN	425
Elevator Septum McKenty	421
Elevator Tonsillen HENKE	436
Elevator WATSON-CHEYNE	269
ELLIOT Geburtszange	363
ELSAESSER Nierenfistelzange	123
ELSCHNIG Fixationspinzette	397
ELSCHNIG Hornhautmesser	390
ELSCHNIG Zykliodialysepädel	393
EMMET Fistelhäkchen	344
Endospekula KOGAN	341
ENGEL Gipssäge	74
Entropiumpinzette SNELLEN	399
Episiotomieschere BRAUN-STADLER	72
Episiotomieschere WALDMANN	60
EPPENDORFER Biopsiezange	305
ESMARCH Gipsmesser	74
ESMARCH Verbandschere	72
EVES Tonsillenschnürer	438
Extensionsbügel BOEHLER	205
Extensionsbügel KIRSCHNER	204
Extensionsbügel KIRSCHNER US	204
Extraktionshaken ARRUGA	393

F

Fadenpinzette MC PHERSON	400
Fadenpinzette TUEBINGEN	400
Fadenschere LITTAUER	58
Fadenschere SPENCER	58
FANSLER Proktoskop	331

FARABEUF Knochenhaltezange	254
FARABEUF Raspator	205
FARABEUF Wundhaken	186
FARABEUF-COLLIN Raspator	205
FARRELL Watteträger	412
Fasspinzette COLLIN-DUVAL	46
Fasspinzette DURANTE	45
Fasspinzette DUVAL	46
Fasspinzette russisches Modell	45
Fasszange MARTEL	102
Fasszange PRATT	102
Fasszange WILLER-MARTEL	102
FAULKNER Kürette	428
FAURE Biopsiezange	296
FAURE Peritoneumklemme	126
FAVALORO Gefäßschere	64
FEHLAND Darmklemme	131
FEILCHENFELD Splitterpinzette	44
FELDHEIM Finger-Blutleere	371
FERGUSSON Gallensteinloeffel	124
FERRIS-SMITH-KERRISON Stanze	293,294
Fingernagelbohrer	370
Fingerringssäge	370
Fingersäge LANGENBECK	194
Fingerschützer LANGENBECK	431
FINOCCHIETTO Bronchusklemme	128
FINOCCHIETTO Nadelhalter	89
FINOCCHIETTO Rippensperrer	312-314
FINSEN Wundhaken	229
FISCH Häkchen	278
FISCHER Irispinzette	399
FISH Sonde	15
FISHER Tonsillen Messer	439
Fistelhäkchen EMMET	344
Fistelzange PRATT	332
Fixationspinzette ELSCHNIG	397
Fixierpinzette GRAEFE	399
Fixiervorrichtung ROCHARD	236
Flachmeißel	195-201
Flachmeißel ALEXANDER	196
Flachmeißel COBB	199
Flachmeißel HIBBS	197
Flachmeißel HOKE	197
Flachmeißel LEXER-MINI	195
Flachmeißel MINI-LAMBOTTE	195,199
Flachmeißel PARTSCH	196
Flachmeißel SMITH-PETERSEN	198
Flachmeißel STILLE	201
Flachmeißel ZIELKE	200
Flachzange	214-216
FOERSTER Irispinzette	399
FOERSTER Schwammzange	119,120
FOMON Hauthäkchen	428
FOMON Meißel	424
FOMON Nasenraspel	426,427
FOMON Nasenschere	62
FOMON Raspator	206
FOREGGER Laryngoskop	23
FOX Lupuskürette	368
FRAENKEL Aufsatz	302
FRAENKEL Kehlkopfpolypenzange	297
FRAZIER Bauchdeckenhalter	239
FRAZIER Dura Dissektor	276
FRAZIER Punktionskanüle	279
FRAZIER Saugrohr	17
FREER Hauthäkchen	176
FREER Meißel	425
FREER Meißel	423
FREER Septum Elevator	423
FREER Septum Meißel	423
FREER Septum Messer	423
Fremdkörperflachmeißel DIX	394

Fremdkörperhebel BUCK	406
Fremdkörperhebel QUIRE	406
Fremdkörperhohlmeißel WALTON	391
Fremdkörperinstrument DIX	394
Fremdkörpernadel	391
Fremdkörperzängchen HARTMANN	407
Fremdkörperzängchen STRUEMPEL	407
Fremdkörperzängchen WULLSTEIN	407
Fremdkörperzange HARTMANN	407
Fremdkörperzange MATHIEU	325
FRENZEL Zungenspatel	430
FRIEDMAN Hohlmeißelzange	244
FRIEDMAN-MINI Hohlmeißelzange	244
FRIEDMAN Spekula	339
FRITSCH Wundhaken	187
FRYKHOLM Hohlmeißelzange	248
Führungshohlsonde SCHMIEDEN-PAYR	99
Führungshohlsonde BRUNNER	100
Führungshohlsonde KIRSCHNER	99
Führungshohlsonde KOENIG	99
Führungshohlsonde PAYR	100
Führungshohlsonde SCHMIEDEN	99
Führungsnadel REDON	447

G

Galeahaken YASARGIL	270
GALLAHER Antrum Raspel	426
Gallenblasenschere THOREK	62
Gallengangdilatoren BAKES	122
Gallensteinlöffel DESJARDINS	125
Gallensteinlöffel FERGUSSON	124
Gallensteinlöffel LUER-KOERTE	124
Gallensteinlöffel MAYO	125
Gallensteinsonde DESJARDINS	125
Gallensteinzange BLAKE	123
Gallensteinzange DESJARDINS	122
Gallensteinzange MAYO-BLAKE	123
Gallensteinzange MIXTER	123
Gastroskopiezangen	445
GAUSS Kopfschwanzzange	365
Geburtslöffel SELLHEIM	366
Geburtszange BARTON	364
Geburtszange BOERMA	364
Geburtszange ELLIOT	363
Geburtszange KIELLAND	363
Geburtszange KIELLAND-LUIKART	363
Geburtszange LUIKART	363
Geburtszange MC LEAN	364
Geburtszange MC LEAN-LUIKART	364
Geburtszange MC LEAN-TUCKER	364
Geburtszange NAEGELE	363
Geburtszange PIPER	364
Geburtszange SIMPSON	363
Geburtszange SIMPSON-BRAUN	363
Geburtszange SIMPSON-LUIKART	363
Geburtszange TARNIER	364
Gefäß Dilatator DE BAKEY	166
Gefäßclip	464
Gefäßclip Aneurysmen YASARGIL	447-464
Gefäßclip MEHDORN	465
Gefäßclip MUELLER	468
Gefäßklemme DIEFFENBACH	48
Gefäßklemme SATINSKY	129
Gefäßpinzette WANGENSTEEN	85
Gefäßschere DEBAKEY	63
Gefäßschere DEBAKEY	64,81
Gefäßschere DIETRICH	64
Gefäßschere FAVALORO	64
Gefäßschere KLINKENBERG-LOTH	62
Gefäßschere Parametrium	64,65

Gefäßschere POTTS-SMITH	63,81	Haemorrhoid Ligator	308	HARTMANN Spülkanüle	422
Gefäßschere SATINSKY	62	Haemorrhoidalklemme FERGUSSON	107	HARTMANN Stimmgabel	402,403
GELPI Wundspreizer	232	HAGLUND-STILLE Gipsspreizer	74	HARTMANN Zungendrucker	430
GEMINI Arterienklemme	109	HAIGHT Rippensperrer	317	HARTMANN-HALLE Nasenspekula	414
GERALD anatomische Pinzette	44	HAJEK Nasenzange	419	Hauthäkchen Tracheal	176
GERALD chirurgische Pinzette	45	HAJEK Hammer	213	Hauthäkchen COTTLE	428
GERSTER Knochenhalteklammer	204	HAJEK Meißel	425	Hauthäkchen COTTLE-NEIVERT	428
GERZOG Hammer	210	HAJEK-KOFLER Stanze	417	Hauthäkchen FEMON	428
Gewebefasszange ATRAUMA	131	Häkchen	176	Hauthäkchen FREER	176
Gewebefasszange CHAPUT	102	Häkchen BARBARA	413	Hauthäkchen GILLIES	428
Gewebefasszange COLLIN	102	Häkchen FISCH	278	Hauthäkchen GUTHRIE	176
Gewebefasszange TUFFIER	102	Häkchen MC GEE	413	Hauthäkchen JOSEPH	176
GIERTZ-STILLE Rippenschere	311	Häkchen mit Knopf WAGENER	406	Hauthäkchen KILNER	368
GIGLI Griff	194	Haken JAKOBSON	278	Haut-Trephine KEYES	368
GILL Irispinzette	398	Haken SCOVILLE	234	HAYES Atrauma Reklmumklemme	133
GILL-HESS Irispinzette	398	Haken SMELLIE	365	HEANEY Hysterektomieklammer	115
GILLIES chirurgische Pinzette	45	Hakenzange BARRET	347	HEANEY Nadelhalter	89
GILLIES Hauthäkchen	428	Hakenzange BRAUN	347	HEANEY Wundhaken	177
GILLIES Nadelhalter	88	Hakenzange DUPLAY	127,347	HEANEY Biopsiekürette	350
GIL-VERNET Wundhaken	184	Hakenzange HULKA	127,347	HEATH Hammer	213
Gipsabreisszange WOLFF	74	Hakenzange IOWA	348	HEGAR Uterus Dilatator	340-341
Gipsmesser ESMARCH	74	Hakenzange JACOBS	348	HEISS Arterienklemme	117
Gipsmesser HOPKINS	74	Hakenzange JARCHO	347	HEISTER Mundsperrer	435
Gipsmesser REINER	74	Hakenzange MUSEUX	348	HENKE Tonsillen Elevator	436
Gipsmesser WIGMORE	74	Hakenzange PRATT	348	HENLEY Wundspreizer	228
Gipssäge elektrisch	73	Hakenzange SCHROEDER	127,348	HENNIG Gipsspreizer	74
Gipssäge ENGEL	74	Hakenzange SCHROEDER (POZZI)	347	HEPP-SCHUIDEL Mikroschere	68
Gipssäge STILLE	74	Hakenzange SKENE	127,348	HERKULES Drahtkneifzange	216
Gipsspreizer für Hand	74	Hakenzange STAUDE-MOORE	347	HERRICK Nierenstielklemme	114
Gipsspreizer HAGLUND-STILLE	74	Hakenzange TEALE	127,347	HESS Irispinzette	398
Gipsspreizer HENNIG	74	HALLE Löffel	288	HESS Kapselpinzette	398
GLOVER Atrauma Bulldogklemme	141	HALSEY Nadelhalter	94	HEYMANN Nasenschere	56
GLOVER Atraumaklemme	151	Halter KALLMORGEN	339	HEYMANN Septumzange	416
GLUCK Rippenschere	310	Halter KRISTELLER	339	HEYWOOD-SMITH Hämorrhoidalzange	304
GOELET Wundhaken doppelt	185	Halterahmen ROCHARD	236	HIBBS Flachmeißel	197
GOLDMAN-FOX Zahnfleischschere	59	Hammer	210-213	HBBS Hohlmeißel	197
GOMEL Mikrochirurgie Pinzette	50	Hammer BERGMANN	211	Hirnmesser	11
GOMEL Mikroschere	69	Hammer COLLIN	210	Hirnspatel CUSHING	279
GOOD Tonsillenschere	56	Hammer COTTLE flach/convex	211,213	Hirnspatel OLIVECRONA	279
GOODELL Uterus Dilatator	343	Hammer GERZOG	210	HIRSCHMANN Anuskop	332
GORNEY Elevator	206	Hammer HAJEK	213	HOEN Dura Dissektor	276
GOSSET Bauchdeckenhalter	239	Hammer Hartholz bleigefüllt	211	HOESEL Nadelhalter	91
graduiert Messbecher	377	Hammer HEATH	213	HOESEL Wundhaken	180
GRAEFE Cystotom	391,393	Hammer KIRK	210	HOFER Wundhaken	436
GRAEFE Diszisionsmesser	390	Hammer LUCAE	210	HOFFMANN Schlauchklemme	341
GRAEFE Fixationspinzette	399	Hammer m. Plastik-Griff	211	Hohlmeißel	196-201
GRAEFE Hauthäkchen	393	Hammer m. auswechselb. Backen	211,212	Hohlmeißel ALEXANDER	196
GRAEFE Irispinzette	396	Hammer MEAD	210	Hohlmeißel COBB	199
GRAEFE Lidsperrer	388	Hammer OMBREDANNE	213	Hohlmeißel HIBBS	197
GRAEFE Schielhaken	393	Hammer PARTSCH	211	Hohlmeißel LEXER	195
GRAEFE Startlöffel	395	Hammer WILLIGER	210	Hohlmeißel LEXER-MINI	195
GRAEFE Starmesser	390	Hämorrhoidal Ligator MC GIVNEY	308	Hohlmeißel SMITH-PETERSEN	198
GRAHAM Nervhaken	261	Hämorrhoidal Ligator RUDD	308	Hohlmeißel STILLE	201
GRAVE Scheidenspekula	335	Hämorrhoidalzange HEYWOOD-SMITH	304	Hohlmeißelzange BEYER	246
GRAY Arterienklemme	112	Hämorrhoidalzange MC GIVNEY	308	Hohlmeißelzange BEYER	249
GREVEN Mikro Ohrzängchen	407	Handbohrapparat MOORE	218	Hohlmeißelzange BLUMENTHAL	245
Griff GIGLI	194	Handbohrapparat BUNELL	224	Hohlmeißelzange BOEHLER	247
Griff Kehlkopfspiegel	303	Handbohrapparat HUDSON	218	Hohlmeißelzange CLEVELAND	244
Griff mit 2 Haken De VILBIS	275	Handbohrapparat RALK	224	Hohlmeißelzange ECHLIN	248
GROSS-MAIER Kornzange	119	Handbohrapparat STILLE	204	Hohlmeißelzange FRIEDMAN	244
GUTHRIE Hauthäkchen	176,393	Handwaschbürste	379	Hohlmeißelzange FRIEDMAN-MINI	244
GUYON Arterienklemme	113,131	HANK Uterus Dilatator	342	Hohlmeißelzange FRYKHOLM	248
GUYON Dilatationsbougie	322	HARKEN Aurikelklemme	156	Hohlmeißelzange KLEINERT-KUTZ	246
Gynäkologische Schere KELLY	60	HARRINGTON Bronchusklemme	128	Hohlmeißelzange LEKSELL-STILLE	249
Gynäkologische Schere SIMS	60	HARRINGTON Wundhaken	191	Hohlmeißelzange LEMPERT	244
Gynäkologische Schere WERTHEIM	61	HARTMANN Nasenzange	418	Hohlmeißelzange LUER	245
Gynäkologische Schere Laparoskopie	3,353	HARTMANN Arterienklemme	103,104	Hohlmeißelzange MEAD	244
		HARTMANN Fremdkörperzängchen	407	Hohlmeißelzange OLIVECRONA	245
		HARTMANN Ohrkatheter	405	Hohlmeißelzange RUSKIN	249
		HARTMANN Ohrspekula	404	Hohlmeißelzange SAUERBRUCH	248
		HARTMANN Ohrzängchen	407	Hohlmeißelzange SCAGLIETTI	248
		HARTMANN Polypenzängchen	407	Hohlmeißelzange SEMB	248
H					
HABERER Bauchspatel	190				

Knochensplitterzange STILLE-LISTON..	253
Knopfsonde JACOBSON	278
Knopfsonden.....	15
Knorpelmesser LANGENBECK.....	10
KNOWLES Verbandschere	72
Koagulationselektrode.....	381-386
KOCHER Arterienklemme	105
KOCHER Blasenspatel	323
KOCHER Darmklemme.....	130
KOCHER Darmklemme atrauma.....	130
KOCHER Kropfsonde	173
KOCHER Wundhaken	178,186,187
KOCHER Wundhaken	192
KOENIG Führungshohlsonde	99
KOENIG Raspator.....	206
KOERTE Wundhaken	188
KOGAN Endospekula	341
Komedonenquetscher SAALFELD	368
Komedonenquetscher SCHAMBERG....	368
Komedonenquetscher WALTON.....	368
Kompressor Tonsillen CROWIN	439
Komprimeter komplett	202
KOOS Dura Messer.....	278
Kopfhautklammer RANEY.....	274
Kopfschwartzange GAUSS.....	365
Kornzange GROSS-MAIER	119
Kornzange LISTER (SINUS)	120
Kornzange ULRICH.....	119
Krampfaderbesteck NABATOFF	232
Kranioclast BRAUN.....	366
Kranioclast TARNIER	364
KRAUSE Aufsatz	302
KRAUSE Polypenschnürer	406
KRAUSE Polypenschnürer	420
KRAYENBUEHL Nervhäkchen	279
KRISTELLER Halter	339
KRISTELLER Scheidenspekula	339
KRISTELLER Spekula	339
KROENIG Zungenspatel	432
KRONECKER Unterbindungsnadel....	100
Kronenschere BEEBEE	54
Kropffasszange LAHEY.....	173
Kropfsonde KOCHER	173
KUHNT Hornhautschaber	391
Kürette Antrum COAKLEY	428
Kürette HOUSE	413
Kürette Hypophyse	277
Kürette FAULKNER.....	428
L	
Laborschale	377
LABORD Tracheal Dilator.....	170
LAVORCE Ersatzklingen	429
LAVORCE Ringmesser	429
LAHEY Arterienklemme.....	117
LAHEY Kropffasszange	173
LAHEY Wundhaken	178
LAMBOTTE Knochenhaltezange.....	254
LAMBOTTE Osteotom.....	195
LAMBOTTE Raspator	205
Laminektomie Sperrer.....	233-234
Laminektomie Sperrer CHERRY.....	318
Laminektomie Zange CLOWARD	299
Laminektomie Zange CUSHING	292
Laminektomie Zange FERRIS-SMITH. .	293,294
Laminektomie Zange OLDBERG.....	295
Laminektomie Zange SCHLESINGER....	299
Laminektomie Zange SPURLING	292
Laminektomie Zange LOVE-GRUENW. .	292
Laminektomie SCOVILLE	234
LANDAU Scheidenspekula	340
LANDOLT Tumorfasszange	295
LANE chirurgische Pinzette	46
LANE Knochenhaltezange.....	253
LANE Magenquetschklemme	135
LANGE Aufsatz	302
LANGENBECK Amputationsmesser....	10
LANGENBECK Fingersäge	194
LANGENBECK Fingerschützer	431
LANGENBECK Knochenhaltezange	254
LANGENBECK Knorpelmesser.....	12
LANGENBECK Nadelhalter.....	91
LANGENBECK Raspator.....	205
Lärmtrommel BARANY	404
Laryngoskop FOREGGER.....	23
Laryngoskop HOLINGER	34
Laryngoskop	19-36
Laryngoskop MC INTOSH	20,21
LAWRENCE Arterienklemme.....	111
LEBSCHE Sternummeißel.....	217
LEGUE Blasenwundspreizer	323
LEGUE Blasenpatel	323
LEMPERT Elevator	413
LEMPERT Hohlimeißelzange	244
LEMPERT Löffel	290
LERCHE Fasspinzette.....	46
LERCHE Arterienklemme	107
LEWIN Knochenhaltezange	256
LEWIS Antrum Raspel.....	426
LEWIS Nasenraspel JOSEPH	427
LEXER Hohlimeißel	195
LEXER Präparierschere	60
LEXER-BABY Präparierschere	57
LEXER-MINI Flachmeißel	195
LEXER-MINI Hohlmeißel	195
LICHTWITZ Trokar	284
Lidhalter DESMARRÉS	184
Lidplatte JAEGER	389
Lidsperrer ARRUGA	388
Lidsperrer BARRAQUER.....	388
Lidsperrer BOWMAN.....	388
Lidsperrer CASTROVIEJO.....	389
Lidsperrer CLARK.....	388
Lidsperrer CRITCHETT	388
Lidsperrer GRAEFE.....	388
Lidsperrer LANCASTER	389
Lidsperrer LISTER-BURCH	389
Lidsperrer MELLINGER.....	388
Lidsperrer MELLINGER-AXENFELD....	388
Lidsperrer MUELLER.....	389
Lidsperrer MURDOCK.....	389
Lidsperrer PARK	389
Lidsperrer SMITH	389
Lidsperrer STEVENSON	389
Lidsperrer WEEK.....	389
Lidsperrer WILLIAMS	389
Lidsperrer ZIEGLER	389
Lippenhalter	430
LISTER Kornzange (SINUS)	120
LISTER Verbandschere	72
LISTER-BURCH Lidsperrer.....	389
LISTON Amputationsmesser.....	10
LISTON Knochenplitterzange	253
LITTAUER Cilienpinzette.....	400
LITTAUER Fadenschere	58
LITTLEWOOD Darmfaßzange	136
Löffel BRUNS	287
Löffel BRUNS	290
Löffel DAUBENSPECK	286
Löffel HALLE	288
Löffel JACOBSON.....	287
Löffel JANSEN.....	287
Löffel MARTINI	289
Löffel Scharfe HALLE	288
Löffel Scharfe SCOVILLE	288
Löffel Scharfe SPINAL.....	288
Löffel SCHEDE	290
Löffel SCOVILLE	288
Löffel SPINAL	288
Löffel SPRATT.....	289
Löffel VOLKMANN.....	289
Löffel WILLIGER	286
Löffel WILLIGER	289
LORNA Tuchklemme.....	127
LOUTE Drahtspanninstrument	204
LOVE Nervwurzelhaken.....	261
LOVE Wundhaken	436
LOVELACE Arterienklemme	107
LOVELACE Lungenfasszange.....	128
LOWER Arterienklemme	117
LOWMAN Knochenhalteklammer	204
LUC Septumzange	416
LUCAE Hammer	210
LUCAE Ohrpinzette	47,406
LUCAE Parazentese Nadel.....	405
LUCAE Stimmgabel	402
LUER Hohlmeißelzange.....	245
LUER Trachealkanüle	171
Luftdusche POLITZER.....	404
LUIKART Geburtszange	364
Lungenfasszange LOVELACE.....	128
Lungenschere CRAVOORD.....	62
Lungenspatel ALLISON.....	310
Lupuskürette FOX.....	368
Lupuskürette PIFFARD	368
M	
Magen-Darmklemme BRUNNER	131
Magenquetschklemme LANE	135
MAGILL-Kathetereinführungszange ...	17
MALTZ Nasenraspel (COTTLE)....	426,427
MARTEL Fasszange	102
MARTEL Fasszange WILLET	102
MARTIN Beckenzirkel	346
MARTIN Knochenhaltezange	256
MARTIN Uterus Sonde	341
MARTINI Löffel	289
Maßband aus Metall	14
MASSON Nadelhalter	89
Maßstab aus Metall	14
Mastdarmbiopsiezange TURREL	304
Mastdarmbiopsiezange YEOMAN	304
Mastdarmbiopsiezange YEOMAN	296
Mastdarm-Spekula BARR.....	329
Mastdarm-Spekula BODENHAMMER ..	328
Mastdarm-Spekula CZERNY	328
Mastdarm-Spekula MATHIEU.....	328
Mastdarm-Spekula PRATT.....	329
Mastdarm-Spekula SCHULZE-BERGM .	329
Mastdarm-Spekula SIMS	328
MASTIN Muselklemme	173
MATHIEU Fremdkörperzange	325
MATHIEU Mastdarm-Spekula	328
MATHIEU Nadelhalter	91
MATHIEU Wundhaken doppelt.....	186
MATHIEU-OLSEN Nadelhalter	94
MATSON Raspator	207
MATSON-ALEXANDER Raspator.....	207
MATZENAUER Scheidenspekula	338
MAUNDER Mundkeil.....	431
MAYO Gallensteinloeffel	125
MAYO Nierensteinsonde.....	125

MAYO Präparierschere	56	MICHEL Wundklammerpinzette	97	Nabelschnurklemme COLLIN	365
MAYO Sterilisierklammer	369	MICHEL Wundklammerzange	97	Nabelschnurklemme KANE	365
MAYO Zungenspatel	432	Mikro Nadelhalter BARRAQUER	90	Nabelschnurschere BUSCH	61
MAYO-BLAKE Gallensteinzange	123	Mikro Ohrscherer BELLUCCI	408	Nabelschnurschere SCHUMACHER	61
MAYO-GUYON Arterienklemme	113	Mikro Ohrscherer SHEA	408	Nabelschnurschere USA	61
MAYO-HEGAR Nadelhalter	94	Mikro Ohrzängchen	408	Nadel BARBARA	413
MAYO-STILLE Präparierschere	56	Mikro Ohrzängchen COS	407	Nadel für Sektio	263
MC DONALD Elevator	269	Mikro Ohrzängchen GREVEN	407	Nadel Parazentese LUCAE	405
MC GEE Häkchen	413	Mikro Ohrzängchen JUERS	407	Nadel Parazentese POLITZER	405
MC GIVNEY Hämorrhoidal Ligator	308	Mikro Ohrzängchen McGEE	407	Nadel ROSEN	411
MC GIVNEY Hämorrhoidalzange	308	Mikro Ohrzängchen oval	407	Nadel Tonsillen DUPUY-WEISS	439
MC INDOE Knochensplitterzange	252	Mikro Rohrschaftschere	410	Nadeldose	374
MC INTOSH Laryngoskop	19-34	Mikro Rohrschaftzange	409	Nadelhalter ARRUGA	90
MC IVOR Mundsperrler	433	Mikrochirurgie Pinzette	49	Nadelhalter BARRAQUER	90
MC KIENZIE Anlegezange	273	Mikrochirurgie Pinzette GOMEL	50	Nadelhalter BAUMGARTNER	89,94
MC LEAN Geburtszange	364	Mikrochirurgie Pinzette ADSON-BROWN	50	Nadelhalter CASTROV.-MICRO	88,95
MC LEAN-LUIKART Geburtszange	364	Mikrochirurg. Pinzette VICKERS	51	Nadelhalter CATSTROVIEJO	88
MC LEAN-TUCKER Geburtszange	364	Mikropinzette Intraokulare	409	Nadelhalter CRILE-WOOD	89,94
MC GEE Mikro Ohrzängchen	407	Mikroschere	63-70	Nadelhalter DE-BAKEY	88
MC KENTY Septum Elevator	421	Mikroschere HEPP-SCHMIDT	68	Nadelhalter DERF	89,94
MEAD Hammer	210	Mikroschere GOMEL	69	Nadelhalter FINOCCHIETTO	89
MEAD Hohlmeißelzange	244	MIKULICZ Peritoneumklemme	126	Nadelhalter GILLIES	88
Medizinbecher	375-376	MIKULICZ Wundhaken	192	Nadelhalter HALSEY	89
Medizinbecher	377	MILLIGAN Dura Dissektor	275	Nadelhalter HEANEY	89
Medizinloeffel	377	MILLIN Blasenhalssperrler	323	Nadelhalter HOESEL	91
MEEKER Arterienklemme	111	MILLIN Blasenwundsperrler	323	Nadelhalter JACOBSON	89
MEHDORN Anlegepinzette	465	MILLIN Kapselzange	324	Nadelhalter KILNER	88
MEHDORN Gefäßclip	465	MILLER Nasenraspel	427	Nadelhalter LANGENBECK	91
Mehrweckschale	373-376	MILLIN Prostatafzange	324	Nadelhalter LICHTENBERG	91
Meißel BRUNETTI	263	MINI-LAMBOTTE Flachmeißel	199	Nadelhalter MASSON	89,94
Meißel COTTLE	424	MIXTER Arterienklemme	111,112	Nadelhalter MATHIEU	91,94
Meißel flach	424	MIXTER-BABY Arterienklemme	106	Nadelhalter MATHIEU-OLSEN	91
Meißel FOMON	424	MOELTGEN Meßinstrument	14	Nadelhalter MAYO-HEGAR	94,88
Meißel FREER	423	MOLLISON Wundsperrler	230	Nadelhalter OLSEN-HEGAR	91
Meißel HAJEK	425	MOLT Mundsperrler DOYEN	435	Nadelhalter RYDER	88
Meißel KILLIAN-CLAUS	425	MORITZ-SCHMIDT Zungenspatel	435	Nadelhalter TC	88-91
Meißel Septum CINELLI	424	MOORE Handbohrapparat	218	Nadeln REVERDIN	96
Meißel Septum COTTLE	425	MORSE Rippensperrler	312	Nadeln YOUNG-BOOMERANG	96
Meißel Septum FREER	425	MORSE-FAVALORO Rippensperrler	312	NAEGELE Geburtszange	363
Meißel Septum SILVER	425	MOYNIHAN Arterienklemme	112	Nagelausreißzange RADOLF	370,371
MELLINGER Lidsperrler	388	MUCK Messer	413	Nagelfeile	370,371
MELLINGER-AXENFELD Lidsperrler	388	MUELLER Approximatoren	467	Nagelschere	370,371
Meniskushaken BLOUNT	260	MUELLER Gefäßclip	468	Nagelzange	370,371
Meniskusmesser NEFF	271	MUELLER Lidsperrler	389	Nagelzange TURNBULL	370
Meniskusmesser SMILLIE	271	MÜNCHEN Biopsiekürette	350	NAGER Wundhaken	436
MERCEDES Thoraxsperrler	319	Mund-Zunge	430-435	Nahtbesteck	97-98
Messbecher graduert	375	Mundkeil MAUNDER	431	Nahtpinzette CATROVIEJO	88-95
Messer Dura KOOS	278	Mundsperrler DAVIS-BOYLE	434	Nasenhaken AUFRICHT	428
Messer FREER	423	Mundsperrler DENAHRT	435	Nasenhaken COTTLE	428
Messer MUCK	413	Mundsperrler DINGMANN	432	Nasenmeißel WEST	425
Messer PLESTER	411	Mundsperrler DOYEN-JANSEN	435	Nasenmesser COTTLE	425
Messer ROSEN	411	Mundsperrler HEISTER	435	Nasenmesser JOSEPH	425
Messer SCHUKNECHT	411	Mundsperrler JENNINGS	434	Nasenolive	404
Messer TABB	411	Mundsperrler KILNER-DOUGHT	433	Nasenraspel AUFRICHT	428
Messer Tonsillen ABRAHAM	439	Mundsperrler MC IVOR	433	Nasenraspel FOMON	426,427
Messer Tonsillen BRUENINGS	423,439	Mundsperrler MOLT	435	Nasenraspel JOSEPH	427
Messer Tonsillen CARPENTER	436	Mundsperrler ROSER-KOENIG	435	Nasenraspel JOSEPH (LEWIS)	427
Messer Tonsillen FISHER	439	MURDOCK Lidsperrler	389	Nasenraspel MALTZ (COTTLE)	426
Messer WULLSTEIN	411	MURPHY LANE Elevator	260	Nasenraspel WIENER	426
Messinstrument	14	MUSEUX Hakenzange	348	Nasensäge JOSEPH	428
Messinstrument COLLIN	14	Musekelhaken	238	Nasenschere COTTLE	63
Messinstrument MOELTGEN	14	Muskelklemme MASTIN	173	Nasenschere FOMON	59
Messinstrument WARTENBERG	14	Muskelpinzette PRINCE	397	Nasenschere HEYMANN	56
Messzirkel CATROVIEJO	396	MYLES Nasenzange	418	Nasenspekula COTTLE	415
Metallhatheter	322	Myomheber DOYEN	344	Nasenspekula HARTMANN-HALLE	414
METZENBAUM Präparierschere	55	Myommesser SEGOND	344	Nasenspekula KILLIAN	414
MEYERDING Wundhaken	179	Myrtenblattsonde	15	Nasenspekula	414-415
MEYERDING Wundhaken	191			Nasenspekula THUDICHUM	415
MEYERDING Wundsperrler	233			Nasenspekula TIECK-HALLE	414
MEYERHOFER Chalazionskürette	395			Nasenspekula VIENNA	414
MICHEL Kehlkopf Spiegel	303,415			Nasenspekula VOLTOLINI	415
MICHEL Wundklammer	97			Nasenzange HAJEK	419
		N			
		NABATOFF Krampfadlerbesteck	232		

Nasenzange HARTMANN	415,418
Nasenzange MYLES	418
Nasenzange STRUYCKEN	418
Nasenzange WEIL-BLAKESLEY	416
NEFF Meniskusmesser	271
NEGUS Tonsillenzange	437
NELATON Hohlsonde	15
NELSON Gefäßspinzette	46
NELSON Trokar	283,284
NELSON Unterbindungsnadeln	100
Neonatal Atraumaklemme	163,164
Neonatal-Klemme CASTANEDA	163,164
Nervhäkchen KRAYENBUEHL	279
Nervhaken CUSHING	261
Nervhaken DANDY	261
Nervhaken GRAHAM	261
Nervhaken SACHS	261
Nervhaken SMITHWICK	261
Nervwurzelhaken HOSHER	270
Nervwurzelhaken LOVE	261
Nervwurzelhaken SCOVILLE	270
Neurochirurgische Schere	62
Neurochirurgische Schere STRULLY	62
NEWS Trachealhaken	171
Nierenfistelzange ELSAESSER	123
Nierenschale	376
Nierensteinsonde MAYO	125
Nierensteinzange RANDALL	122
Nierenstielklemme HERRICK	114
Nierenstielklemme WERTHEIM-CULLEN	126
NOTO Uterus Polypenzange	137,349
NOVAK Biopsiekürette	344
NOYES Augenschere	401

O

Obduktions-Besteck	75
OBWEGESER Ahle	440
OBWEGESER Raspator	440
OBWEGESER Raspator	441,442
OBWEGESER Wundhaken	440-443
OBWEGESER Wundhaken f. Kiefer	440-443
OCHSNER Trokar	283
OEHLER chirurgische Pinzette	84
Ohrenolive	404
Ohrkatheter HARTMANN	405
Ohrkürette BUCK	405
Ohrmesser POLITZER	405
Ohrmesser SEXTON	405
Ohrzange HEYMANN-KNIGHT	416
Ohrpinzette JANSEN	47,406
Ohrpinzette LUCAE	47,406
Ohrpinzette TROELTSCH	406
Ohrpinzette WILDE (TROELTSCH)	406
Ohrschere Mikro BELLUCCI	408
Ohrschere Mikro SHEA	408
Ohrschlinge BILLEAU	405
Ohrsonde STACKE	15
Ohrspekula HARTMANN	404
Ohrspekula SIEGLE	404
Ohrspekula TOYNBEE	404
Ohrspritze REINER	407
Ohrzängchen HARTMANN	407
Ohrzängchen mikro	407
Ohrzängchen Mikro COS	407
Ohrzängchen Mikro GEVEN	407
Ohrzängchen Mikro HAUGH	407
Ohrzängchen Mikro JUERS	407
Ohrzängchen Mikro McGEE	407
Ohrzängchen Mikro oval	407
OLDBERG Laminektomie Zange	295

OLIVECRONA Drahtsäge	194
OLIVECRONA Dura Dissektor	275
OLIVECRONA Hirnspatel	279
OLIVECRONA Hohlmeißelzange	245
OLLIER Wundhaken	187
OLSEN-HEGAR Nadelhalter	91
OMBREDANNE Hammer	213
OPHTHALMOLOGIE	388-401
OPHTHAL	57,388-401
Organmesser	9,11
O'SULLIVAN; O'CONNOR Spekula	336
OTOLOGIE	402-413
Osteotom	195-201
Osteotom LAMBOTTE	195,199
OSTROEM Stanze	417
OVERHOLT Raspator	207

P

Parallel-Zange	215
Parametrium Gefäßschere	64
Parazentese Nadel LUCAE	405
Parazentese Nadel POLITZER	405
PARK Lidsperrer	389
PARKER Wundhaken	185,186
PARTSCH Flachmeißel	196
PARTSCH Hammer	211
PAYR Darmquetschklemme	130
PAYR Führungshohlsonde	100
PEAN Arterienklemme	102-105
PEDERSON Scheidenspekula	335
PEERS Tuchklemme	127
PEET Splitterzange	47
PELKMANN Tamponzange	122
Pelvis-Haken ST. MARKS	181
PENFIELD Dissektor	276
PENFIELD Dura Dissektor	276
Penisklemme STOCKMANN	325
Penisklemme STRAUSS	325
PENNIGTON Arterienklemme	107
PERCY Retraktor	194
Perforatorie SMELLIE	366
Peritoneumklemme FAURE	126
Peritoneumklemme MIKULICZ	126
Peritoneumklemme PHANEUF	114
Perkussionshämmer BABINSKY	15
Perkussionshämmer BUCK	15
Perkussionshämmer DEJERINE	15
Perkussionshämmer TAYLOR	15
Perkussionshämmer TROEMNER	15
PESTALOZZA Abortuskürette	365
PETRI Box	380
Phalangenmesser	10
PHANEUF Peritoneumklemme	114
PIERCE Kieferhöhlentrokare	284
PIFFARD Lupuskürette	368
PINARD Stethoskop Alu	14
PINARD Stethoskop Holz	14
Pinzette anatomisch POTTS-SMITH	44
Pinzette anatomische	44
Pinzette anatomische ADSON	44
Pinzette anatomische BONNEY	45
Pinzette anatomische GERALD	44
Pinzette anatomische MC INDOE	44
Pinzette anatomische SEMKEN	44
Pinzette anatomische USA	44
Pinzette bipolar	384-386
Pinzette chirurgische	45
Pinzette chirurgische ADSON	45
Pinzette chirurgische ADSON-BROWN	45
Pinzette chirurgische BONNEY	45

Pinzette chirurgische FERRIS SMITH	46
Pinzette chirurgische GERALD	45
Pinzette chirurgische GILLIES	45
Pinzette chirurgische LANE	46
Pinzette chirurgische OEHLER	84
Pinzette chirurgische POTTS-SMITH	45
Pinzette chirurgische SEMKEN	45
Pinzette chirurgische TAYLOR	46
Pinzette chirurgische USA	46
Pinzette Columella KNAPP	397
Pinzette Mikrochir. VICKERS	51
Pinzette Mikrochirurgie	49-51
Pinzette Mikrochirurgie GOMEL	50
PIPER Geburtszange	364
PLESTER Messer	411
PLESTER Saugrohr	17,281
PLESTER Wundspreizer	228
POLITZER Luftdusche	404
POLITZER Ohrmesser	405
POLITZER Parazentese Nadel	405
Polypenschnürer KRAUSE	406
Polypenschnürer WILDE	406
Polypenzängchen HARTMANN	407
Polypenzange DOYEN Uterus	349
Polypenzange KELLY Uterus	349
Polypenzange Uterus NOTO	349
Polyrusspreizer BENSON	132
POOLE Saugrohr	17
POTTS Atraumaklemme	150,152
POTTS-SMITH anatomische Pinzette	44
POTTS-SMITH chirurgische Pinzette	45
POTTS-SMITH Gefäßschere	63
POZZI Hakenzange SCHROEDER	347
Präparierschere JORGENSEN	57
Präparierschere LEXER	57
Präparierschere LEXER-BABY	57
Präparierschere MAYO	56
Präparierschere MAYO-STILLE	56
Präparierschere METZENBAUM	55,57
Präparierschere TOENNIS-ADSON	62
PRATT Fasszange	102
PRATT Fistelzange	332
PRATT Hakenzange	348
PRATT Mastdarm-Spekula	329
PRATT Uterus Dilatator	342
PRICE-THOMAS Bronchusklemme	128
PRINCE Muskelpinzette	397
Protoskop CHELSEA-EATON	332
Protoskop FANSLER	331
Protoskop KELLY	332
Prostatafasszange MILLIN	324
Prostatahaken YOUNG	324
Pulverbläser KABIERSKE	404
PUTTI Raspel	217

Q

QUIRE Fremdkörperhebel	406
----------------------------------	-----

R

RADOLF Nagelausreisszange	370
RAGNELL Wundhaken	185
RALK Handbohrapparat	224
RAMPLEY Schwammzange	119
RAMUS Wundhaken	442
RANDALL Biopsiekürette	344
RANDALL Nierensteinzange	122
RANEY Clip-Anlegezange	274
RANEY Kopfhautklammer	274

Rasierklingen	41	Rippensperrer TUFFIER	317	Scheidenspekula AUVARD	339
Rasiermesser	41	RITTER-HALLE Spülkanüle	422	Scheidenspekula BREISKY	340
Raspator	205-206	ROBB Spatel	167	Scheidenspekula COLLIN	335,336
Raspator ADSON	269	ROBERTS Arterienklemme	108	Scheidenspekula CUSCO	335
Raspator ALEXANDER	206	ROCHARD Bauchdeckenhalter	236	Scheidenspekula DOYEN	340
Raspator DINGMANN	440	ROCHARD Fixiervorrichtung	236	Scheidenspekula GRAVE	335
Raspator DOYEN	208	ROCHARD Halterahmen	236	Scheidenspekula KALLMORGEN	339
Raspator FARABEUF	205	ROCHESTER PEAN Arterienklemme	105	Scheidenspekula KRISTELLER	339
Raspator FARABEUF-COLLIN	205	ROCHESTER-OCHSNER Arterienklemm.	105	Scheidenspekula LANDAU	340
Raspator FOMON	206	ROGER Septum Elevator	423	Scheidenspekula MATZENAUER	338
Raspator JOSEPH	206,421	ROGERS Hysterektomieklamme	115	Scheidenspekula PEDERSON	335
Raspator KOENIG	206	ROGGE Sterilisierungszange	369	Scheidenspekula SCHERBAK	337
Raspator LAMBOTTE	205	Rohrschaftschere Mikro	300	Scheidenspekula SEMM	335
Raspator LANGENBECK	205	Rohrschaftzange Mikro	300	Scheidenspekula SIMS	339
Raspator MATSON	207	ROLLET Tränensackhäkchen	393	Scheidenspekula TRELAT	336
Raspator MATSON-ALEXANDER	207	ROSEN Messer	411	Scheidenspekula VU-MOORE	334
Raspator mit Ferrozellgriff	207	ROSEN Nadel	413	SCH EINMANN Aufsatz	302
Raspator OBWEGESER	440-442	ROSEN Saugrohr	281	SCHERBAK Scheidenspekula	337
Raspator OVERHOLT	207	ROSER-KOENIG Mundsperrer	435	Schere gynäkologische DOYEN	72
Raspator SEDILLOT	205	ROUX Wundhaken	186	Schere gynäkologische KELLY	60
Raspator SEMB	208	ROUX-BABY Wundhaken	185	Schere gynäkologische SIMS	60
Raspator WILLIGER	206	ROUX-MINI Wundhaken	185	Schere gynäkologische WERTHEIM	61
Raspel	217	ROWE Repositionszange	431	Schere neurochirurgische	62
Raspel Antrum GALLAHER	426	RUBIN Septumzange	418	Schere Ophtal. STEVENS	59
Raspel Antrum LEWIS	426	RUDD Hämligat	308	Scheren-chirurgische standard	54-62
Raspel PUTTI	217	RUMEL Arterienklemme	108	Scheren Ophtal	59
RECAMIER Uteruskürette	358	RUMEL-BELMONT Torniquet	165	Schielhaken GRAEFE	393
REDON Führungsnadel	447	RUSKIN Hohlmeißelzange	249	Schielhaken JAMESON	393
REICHERT Deckelhalter	297	RYDEL-SEIFFERT Stimmgabel	402	Schilddrüsenhaken SCHOENBORN	173
REILL Knochenhalte-zange	257	RYDER Nadelhalter	88	SCHINK Dermatoma	12
REINER Gipsmesser	74			SCHIOTZ Tonometer	388
REINER Ohrspritze	407			Schlauchklemme	116-117
Reinigungspistole	380	S		Schlauchklemme BÜLOW-GUNAR-HEY	116
Rektalschnuer WESTON	304	SAALFELD Komedonenquetscher	368	Schlauchklemme HOFFMANN	341
Rektumklemme HAYES	133	SACHS Dura Dissektor	275	Schlauchklemme SIMPLEX	341
Repositionszange ROWE	431	SACHS Nervhaken	261	SCHLESINGER Laminektomie Zange	299
Resektionsmesser mit Metallheft	12	SAENGER Abortuszange	137	Schließzange DE MARTEL-WOLFSON	134
Retraktor PERCY	194	Sägeblätter	194	Schliesszange STONE	133
REVERDIN Nadeln	96	Salpingograph SCHULTZE	345	SCHMIEDEN Führungshohlsonden	99
REYNOLDS chirurg. Schere	58	SAROT Arterienklemme	109	SCHNIDT Tonsillenzange	437
Rhinoplastikschere FOMON	59	SATINSKY Gefäßklemme	129	SCHOENBORN Schilddrüsenhaken	173
RHINOLOGIE	414-429	SATINSKY Gefäßschere	62	SCHROEDER Hakenzange	347
RIBBON Bauchspatel	190	SATINSKY Tangentialklemm.	155	SCHROEDER Hakenzange (POZZI)	347
RICARD Bauchdeckenhalter	238	SATTERLEE Amputationssäge	194	SCHUBERT Biopsiezange	296
RICHARDSON Wundhaken	186,190	Sauerbruch Abfallzange	369	SCHUKNECHT Messer	411
RICHARDSON-EASTMAN Wundhaken	186	SAUERBRUCH Hohlmeißelzange	248	SCHULZE BERGMANN Mastdarmspek	329
RIGBY Wundspreizer	232	SAUERBRUCH Rippenschere	311	SCHULTZE Salpinograph	345
Ringmesser BARNHILL	429	SAUERBRUCH Wundhaken	189	SCHUMACHER Aufsatz	302
Ringmesser BECKMANN	429	SAUERBRUCH-FREY Rippenschere	311	SCHUMACHER Biopsiezange	298
Ringmesser LAVORCE	429	Saugrohr	279,280	SCHUMACHER Nabelschnurschere	61
Ringmesser ST. CLAIR-THOMSON	429	Saugrohr ADSON	279,280	Schwammzange FOERSTER	119
Rippenkontraktor BAILEY	310	Saugrohr BABY YANKAUER	17	Schwammzange RAMPLEY	119
Rippenkontraktor BAILEY-BABY	310	Saugrohr BARON	279	SCHWEIGGER Kapselpinzette	399
Rippenkontraktor BAILEY-GIBBON	310	Saugrohr COOLEY	17	Schwingmesser BALLENGER	423
Rippenschere	310	Saugrohr FRAZIER	17	SCOVILLE Haken	270
Rippenschere BETHUNE	311	Saugrohr PLESTER	17,281	SCOVILLE Löffel	288
Rippenschere BRUNNER	311	Saugrohr POOLE	17	SCOVILLE Nervwurzelhaken	270
Rippenschere CORYLLOS	311	Saugrohr ROSEN	281	SCOVILLE Valve	234
Rippenschere GIERTZ-STILLE	311	Saugrohr YANKAUER	17	SEGOND Myommesser	344
Rippenschere GLUCK	310	Saugrohr YASARGIL	280	Sehnenfassinstrument BRAND	272
Rippenschere SAUERBRUCH	311	Saugrohr ZÖLLNER	280	Sehnenfassinstrument CAROLL	272
Rippenschere SAUERBRUCH-FREY	311	Saugfahre HHOUSE	281	Sehnenfassinstrument KLEINERT-KUTZ	272
Rippenschere STILLE	310	SAWTELL Tonsillenzange	437	Sehnenfasszange	272
Rippensperrer COOLEY	315,317	SAYRE Elevator	269	Sehnenführer BUNELL	272
Rippensperrer COOLEY-NEONATAL	315	SCAGLIETTI Hohlmeißelzange	248	Sehnenführer BUNELL	272
Rippensperrer DE BAKEY	316	Schädelhalter CRUTCHFIELD	274	Sehnenführer BUNELL	272
Rippensperrer DE BOER	316	SCHAEDEL Tuchklemme	127	SEIFERT Aufsatz	302
Rippensperrer FINOCCHIETTO	312-314	Schale	375,377	Sektionsnadel	263
Rippensperrer HAIGHT	317	SCHAMBERG Komedonenquetscher	368	SELLHEIM Geburtslöffel	366
Rippensperrer MORSE	312	scharf Kürette FAULKNER	428	SEMB Bronchusklemme	129
Rippensperrer MORSE-FAVALORO	312	SCHEDE Löffel	290	SEMB Hohlmeißelzange	248
Rippensperrer RIENHOFF FINOCCH	316			SEMB Knochenhalte-zange	252

SEMB Knochensplitterzange	252	SNELLEN Starschlinge	395	STIEGLITZ Splitterzange	47
SEMB Raspator	208	SOMER Uterus-Fasszange	173,349	STILLE Arterienklemme	113
SEMKEN anatomische Pinzette	44	Sonde FISH	15	STILLE Flachmeißel	201
SEMKEN chirurgische Pinzette	45	Spatel	167	STILLE Gipsschere	74
SEMM Scheidenspekula	335	Spatel ROBB	167	STILLE Hohlmeißel	201
SENN-GREEN Wundhaken	178	Spekula FRIEDMANN	339	STILLE Rippenschere	310
SENN-MILLER Wundhaken	178	Spekula KALLMORGEN	339	STILLE-LUER Hohlmeißelzange	249
SEUTIN Verbandschere	61	Spekula KRISTELLER	339	STILLE-RUSKIN Hohlmeißelzange	249
Septum Elevator	421,423	Spekula O'SULLIVAN-O'CONNOR	336	STILLE-SHERMAN Bohraparat	204,218
Septum Elevator BALLENGER	421,423	Spekula SIMS	328,339	Stimmgabel f. Neurologie	402
Septum Elevator COTTLE	421	SPENCER Fadenschere	58	Stimmgabel HARTMANN	402
Septum Elevator COTTLE-JOSEPH	421	SPENCER-WELLS Arterienklemme	103	Stimmgabel LUCAE	402
Septum Elevator FREER	421	Sperrer DINGMANN	432	Stimmgabel alu	403
Septum Elevator JOSEPH	421	Sperrer KILNER-DOUGHTY	433	Stirnlampe CLAR	16
Septum Elevator KILLIAN	421,425	Spinal Haken TAYLOR	260	Stirnspiegel ZIEGLER	16
Septum Elevator McKENTY	421	SPINAL Löffel	288	Stirnstreifen für Stirnspiegel	16
Septum Meißel CINELLY	424	Spiralbohrer	220,221	STOCKMANN Penisklemme	325
Septum Meißel COTTLE	424	Splitterpinzette	44-48	STONE Schließzange	133
Septum Meißel FREER	425	Splitterpinzette CARMALT	48	STONE-WATT Darmklemme	133
Septum Meißel SILVER	425	Splitterpinzette FEILCHENFELD	44	Stößel	196
Septumbecher	376	Splitterpinzette HUNTER	47	STRAUSS Penisklemme	325
Septummesser FREER	423	Splitterpinzette mit Lupe 12 cm	47	STRUEMPPEL Fremdkörperzangchen	407
Septumrichtzange ASCH	420	Splitterzange ARCHER	47	STRULLY neurochirurgische Schere	62
Septumrichtzange WALSHAM	420	Splitterzange PEET	47	STRUYCKEN Nasenzange	418
Septumschere KILLIAN	297	Splitterzange STIEGLITZ	47	SUBRAMANIAN Atraumaklemme	162
Septumzange BRUENINGS	416	Splitterzange VIRTUS	47	SWEET Anlegezange	273
Septumzange HEYMANN	416	Splitterzange VIRTUS (RALK)	48		
Septumzange KNIGHT	416	SPRATT Löffel	289	T	
Septumzange LUC	416	Spülkanüle HARTMANN	422	TABB Messer	411
Septumzange MIDDLETON-JANSEN	419	Spülkanüle KILLIAN	420,422	Tablettenschale	375
Septumzange RUBIN	418	Spülkanüle RITTER-HALLE	422	Tamponpinzette JACKSON	297
SEXTON Ohrmesser	404	Spülkanüle SIEBENMANN	422	Tamponzange BOZEMANN	119
Seziernmesser VIRCHOW	11	Spülkanüle WATSON-WILLIAMS	422	Tamponzange BOZEMANN-DOUGLAS	119
SHEA Mikro Ohrschere	408	SPURLING Laminektomie Zange	292	Tamponzange CHERON	120
SIEBENMANN Spülkanüle	422	ST:CLAIR-THOMSON Ringmesser	429	Tamponzange COLLIN	120
Siebschale	378	ST:MARKS Pelvis-Haken	181	Tamponzange PELKMANN	122
SIEGLE Ohrspekula	404	STACKE Ohrsonde	15	Tangentialklemme SATINSKY	155
Silberklammern	273	Standgefäß	375,376	TARNIER Geburtszange	364
SILVER Septum Meißel	425	Stanze CITELLI	419	TARNIER Kranioclast	364
SIMON Uteruslöffel	290	Stanze HAJEK-KOFLER	417	TAYLOR chirurgische Pinzette	45
SIMON Wundhaken	192	Stanze HOLTH	396	TAYLOR Perkussionshämmer	15
SIMPLEX Schlauchklemme	341	Stanze KERRISON	419	TAYLOR Spinal Haken	260
SIMPSON Geburtsklemme	363	Stanze OSTROEM	417	TC Nadelhalter	88-91
SIMPSON-BRAUN Geburtszange	363	Starlöffel DAVIEL	395	TEALE Hakenzange	348
SIMPSON-LUIKART Geburtszange	368	Starlöffel GRAEFE	395	TESSIER Wundhaken	440
SIMS gynäkologische Schere	60	Starlöffel KNAPP	395	THOMAS Uteruskürette	360
SIMS Mastdarm-Spekula	328	Starmesser	390-392	THOMAS-GAYLOR Biopsiezange	296
SIMS Scheidenspekula	339	Starmesser DEUTSCHMANN	390	THOMS-ALLIS Darmfasszange	121
SIMS Spekula doppelendig	339	Starmesser gebogen	391-392	Thoraxsperrer MERCEDES	319
SIMS Uterus Depressor	350	Starmesser gerade	391-392	THOREK Gallenblasenschere	62
SIMS Uterus Dilator	343	Starmesser GRAEFE	390	THUDICHUM Nasenspekula	415
SIMS Uteruskürette	358	Starschlinge SNELLEN	395	THIECK-HALLE Nasenspekula	414
SIMS Uterus-Sonde	341	Starschlinge WEBER	395	TISCHLER Biopsiezange	1,351,307
Sinoskopie Trokar	283	Starschlinge WILDER	395	TOBOLD Watteträger	412
SINUS Kornzange LISTER	120	STEINMANN Knochennägel	267,268,	TOBOLD Zungendrucker	430
Skalpelle mit Metallheft	37-40	Sterilisier Container	374-378	TOENNIS Arterienklemme	110
Skalpelle steril	38-39	Sterilisierklammer BUNT	369	TOENNIS Dura Dissektor	275
Skalpellgriffe	37-38	Sterilisierklammer MAYO	369	TOENNIS-ADSON Präparierschere	62
Skalpellklingen steril	37-38	Sterilisierpinzette DAVIS	44,369	TOHOKU Tuchklemme	127
SKENE Hakenzange	347	Sterilisiersiebschale	373	Tonometer SCHIOETZ	388
SLUDER-BALLENGER Tonsillotom	439	Sterilisierzange	369	TONSILLEN	436-439
SMELLIE Haken	365	Sterilisierzange CHEATLE	369	Tonsillen Dissektor HURD	436
SMELLIE Perforatorie	366	Sterilisierzange ROGGE	369	Tonsillen Elevator HENKE	436
SMILLIE Knochenheber	260	Sterilisierzange UNIVERSAL	369	Tonsillen Elevator LUNIATSCHEK	436
SMILLIE Meniskusmesser	271	Sterilisationcontainer	374,378	Tonsillen Kompressor CORWIN	439
SMITH Lidsperrer	389	STERNBERG Wangenhalter	430	Tonsillen Messer ABRAHAM	439
SMITH Verbandschere	61	Sternummeißel LEBSCHE	217	Tonsillen Messer BRUENINGS	439
SMITH-PETERSEN Nagel	198	Stethoskop Holz PINARD	14	Tonsillen Messer CARPENTER	436
SMITH-BUIE Analspreizer	329	Stethoskop PINARD	14	Tonsillen Messer FISHER	439
SMITHWICK Anlegezange	273	STEVENS Irispinzette	396	Tonsillen Nadel DUBUY-WEISS	439
SMITHWICK Nervhaken	261	STEVENS Ophtal. Schere	59		
SNELLEN Entropiumpinzette	399	STEVENSON Lidsperrer	389		

Tonsillennadel	439
Tonsillenschere	63
Tonsillenschere BOETTCHER	56
Tonsillenschere DEAN	63
Tonsillenschere GOOD	56
Tonsillenschnürer BRÜNINGS	420
Tonsillenschnürer EVES	438
Tonsillenspritze	438
Tonsillenzange BALLENGER	437
Tonsillenzange BLOHMKE	437
Tonsillenzange COLVER	437
Tonsillenzange NEGUS	437
Tonsillenzange SAWTELL	437
Tonsillenzange SCHNIDT	437
Tonsillenzange TYDING	438
Tonsillenzange WHITE	437
Tonsillotom SLUDER-BALLENGER	439
Tonsillotom TYDING	438
Torniquet RUMEL-BELMONT	165
TOYNBEE Ohrspekula	404
Tracheal Dilator LABORDE	170
Tracheal Dilator TROUSSEAU	170
Trachealhaken BOSE	170
Trachealhaken ITERSON	170
Trachealhaken JACKSON	170
Trachealhaken NEWS	171
Trachealhaken CHEVALIER-JACKSON	171
Trachealkanüle LUER	171
Trachealkanüle WAGENER-MOSHER	171
Trachealtrokar UCKERMANN	170
Tracheotomie-Besteck	172
Trachompinzette KNAPP-LUER	397
Tränenkanaldilatator WILDE	394
Tränenkanalsonde BOWMAN	394
Tränensackhäkchen ROLLET	393
Transformator	16
TRELAT Scheidenspekula	336
Trephine KEYES	368
TROELTSCH Ohrpinzette	47
TROELTSCH Ohrpinzette WILDE	47
TROEMNER Perkussionshämmer	15
Trokar LICHTWITZ	284
Trokar NELSON	283
Trokar OCHSNER	283
Trokar UNIVERSAL	284
TROUSSEAU Tracheal Dilator	170
TROUTMAN-CHRIS Klängenbrecher	41
TUBBS Aorta Dilator	165
Tuchklemme	127
Tuchklemme BACKHAUS	127
Tuchklemme BACKHAUS-CLIP	127
Tuchklemme BALL AND SOCKET	127
Tuchklemme JONES	127
Tuchklemme JONES-CLIP	127
Tuchklemme LORNA	127
Tuchklemme PEERS	127
Tuchklemme SCHAEDEL	127
Tuchklemme TOHOKU	127
TUEBINGEN Fadenpinzette	400
TUEBINGEN Irispinzette	400
TUFFIER Gewebefasszange	102
TUFFIER Rippensperr	317
Tumorfasszange LANDOLT	295
Tumorphinzette YASARGIL	52
Tupferzange BRYANT	120
TURREL Mastdarmbiopsiezange	304
TYDING Tonsillenzange	438

U

UHRMACHER Pinzette	48
--------------------	----

UCKERMANN Trachealtrokar	170
UCKERMANN Watteträger	412
ULRICH Knochenhaltezange	257
ULRICH Kornzange	119
UNIVERSAL Drahtschere	58
UNIVERSAL Sterilisierzange	369
UNIVERSAL Trokar	284
UNIVERSAL Verbandschere	72
Universalgriff HUBER	302
UNNA Komedonenquetscher	368
Unterbindungsnadeln COOPER	100
Unterbindungsnadeln DESCHAMPS	99
Unterbindungsnadeln KRONECKER	100
Unterbindungsnadeln NELSON	100
USA anatomische Pinzette	44
USA chirurgische Pinzette	46
USA Nabelschnurschere	61
US-ARMY Wundhaken	187
Uterus Depressor BRAUN	350
Uterus Depressor SIMS	350
Uterus Dilatoratator GOODELL	343
Uterus Dilatoratator HANK	342
Uterus Dilatoratator HEGAR	340
Uterus Dilatoratator PRATT	342
Uterus Dilatoratator SIMS	343
Uterus Dilatoratator WYLIE	343
Uterus Fasszange COLLIN	137,349
Uterus Fasszange DARTIGUES	137,349
Uterus Fasszange SOMER	137,349
Uterus Klemmzange GREEN-ARMY	137,349
Uterus Polypenzange DOYEN	137,349
Uterus Polypenzange KELLY	137,349
Uterus Polypenzange NOTO	137,349
Uterus Sonde COLLIN	350
Uterus Sonde MARTIN	341
Uterus Sonde SIMS	341
Uteruskürette BLAKE	346
Uteruskürette BUMM	358
Uteruskürette RECAMIER	358
Uteruskürette SIMS	358
Uteruskürette THOMAS	360
Uteruslöffel SIMON	290

V

VALLEIX Uterussonde	350
VAN BUREN Dilatationsbougie	322
VAN DOREN Biopsiezange	298
VAN Knochenhaltezange BUREN	255
VANNAS Augenschere	401
Vasektomie Klemme	330
Verbandschere BERGMANN	72
Verbandschere BRUNS	72
Verbandschere ESMARCH	72
Verbandschere KNOWLES	72
Verbandschere LISTER	72
Verbandschere SEUTIN	61
Verbandschere SMITH USARMY	61
Verbandschere UNIVERSAL	72
Verbandstoffrommel SCHIMMELBUSCH	378
VERBRUGGE Knochenhaltezange	255
Verlängerungsrohr BRUENINGS	302
VICKERS Mikrochirurgie Pinzette	51
VIENNA Nasenspekula	414
VIRCHOW Seziermesser	11
VIRTUS Splitterzange (RALK)	48
VOLKMANN Löffel	289
VOLKMANN Wundhaken	176,177
VOLKMANN Wundhaken	185
VOLTOLINI Nasenspekula	415
VU-MOORE Scheidenspekula	334

W

WAGENER MOSHER Trachealkanüle	171
WAGENER Hähchen	406
WAGNER Zahnfleischschere	60
WALDMANN Episiotomieschere	60
WALLICH Abortuslöffel	366
WALSHAM Septumrichtzange	420
WALTON Komedonenquetscher	368
Wangenhalter STERNBERG	430
WANGENSTEEN Gefäßpinzette	85
WARTENBERG Meßinstrument	14
WATSON-CHEYNE Elevator	269
WATSON-WILLIAMS Spülkanüle	422
Watteträger	412
Watteträger FARRELL	412
Watteträger JOBSON-HORNE	412
Watteträger TOBOLD	412
Watteträger UCKERMANN	412
WEBER Aortaklemme	153
WEBER Starschlinge	395
WECKER Augenschere	401
WECKER Irisspachtel	393
WEEK Lidsperr	389
WEIL-BLAKESLEY	416
WEITLANER Wundspreizer	229
WERTHEIM Klemmzange	126
WEST Nasenmeißel	425
WESTCOTT Augenschere	61
WESTON Rektalschnuerer	304
WHEELER Zyklodialysespatel	394
WHITE Tonsillenzange	437
WIENER Nasenraspel	426
WIGMORE Gipsmesser	74
WILDE Ohrpinzette (TROELTSCH)	406
WILDE Polypenschnürer	406,420
WILDER Starschlinge	395
WILDE Tränenkanaldilatator	394
WILLET Fasszange MARTEL	102
WILLIAMS Darmfasszange	131
WILLIAMS Lidsperr	389
WILLIGER Hammer	210
WILLIGER Löffel	286,289
WILLIGER Raspator	206
WINTER Abortuszange	365
Wirbelkoerperspreizer CLOWARD	282
Wirbelkoerperspreizer INGE	282
WITTNER Biopsiezange	307
WOLFF Gipsabreisszange	74
WULLSTEIN Fremdkörperzängchen	407
WULLSTEIN Mikro-Kanüle	405
Wundhaken	176-192
Wundhaken ALM	229
Wundhaken BRUNNER	180,187
Wundhaken COOLEY	182
Wundhaken CORYLLOS	189
Wundhaken CRILE	185
Wundhaken CUSHING	184,188
Wundhaken DESMARRS	184
Wundhaken DAVIDSON (Skapula)	189
Wundhaken DEAVER	190,191
Wundhaken DINGMANN	432
Wundhaken DOYEN	187
Wundhaken FARABEUF	186
Wundhaken FINSEN	229
Wundhaken FRITSCH	187
Wundhaken GIL-VERNET	184
Wundhaken GOELET	185
Wundhaken GREEN	178
Wundhaken HARRINGTON	191
Wundhaken HEANEY	177
Wundhaken HOESEL	180
Wundhaken HOFER	436

Wundhaken ISRAEL	188
Wundhaken JANSEN	229
Wundhaken KELLY	190,192
Wundhaken Kiefer OBWEGESER	440,443
Wundhaken KOCHER	178,186
Wundhaken KOCHER	187,192
Wundhaken KOERTE	188
Wundhaken LAHEY	178
Wundhaken LITTLE	178
Wundhaken LOVE	436
Wundhaken MATHIEU	186
Wundhaken MEYERDING	179,191
Wundhaken MIKULICZ	192
Wundhaken NAGER	436
Wundhaken OBWEGESER	442,443
Wundhaken OLLIER	187
Wundhaken PARKER	185,186
Wundhaken RAGNELL	185
Wundhaken RAMUS	440-443
Wundhaken RICHARDSON	186,190
Wundhaken RICHARDSON-EASTMAN	186
Wundhaken ROUX	186
Wundhaken ROUX-BABY	185
Wundhaken ROUX-MINI	185
Wundhaken SAUERBRUCH	189
Wundhaken SENN-GREEN	178
Wundhaken SENN-MILLER	178
Wundhaken SIMON	192
Wundhaken TESSIER	440
Wundhaken US-ARMY	187
Wundhaken VOLKMANN	176,177
Wundhaken VOLKMANN	185
Wundhaken ZENKER	183
Wundklammern MICHEL	97
Wundklammerpinzange MICHEL	97
Wundklammerpinzange WACHENFELDT	97
Wundklammerpinzette HEGENBARTH	97
Wundklammerzange CHILDE	97
Wundklammerzange COLLIN	97
Wundklammerzange MICHEL	97
Wundklammerzange RICHTER-HEATH	97
Wundnahtbesteck	97,98
Wundsperrer DARLING	230
Wundspreizer ADSON	226,227
Wundspreizer ADSON-BABY	226
Wundspreizer ANDERSON-ADSON	226
Wundspreizer BECKMANN	227
Wundspreizer BECKMANN-EATON	227
Wundspreizer CASPAR	231,233
Wundspreizer GELPI	232
Wundspreizer HENLEY	228
Wundspreizer MEYERDING	233
Wundspreizer MOLLISON	230
Wundspreizer PLESTER	228
Wundspreizer RIGBY	232
Wundspreizer WEITLANER	229
WYLIE Uterus Dilatator	343

Y

YANKAUER Saugrohr	17
YASARGIL Aneurysmen Gefäßclip	448,470
YASARGIL Galeahaken	270
YASARGIL Saugrohr	280
YASARGIL Tumorpinzette	52
YEOMAN Mastdarmbiopsiezange	296,304
YOUNG Kapsel Fasszange	324
YOUNG Prostatahaken	324
YOUNG Zungenzange	435

Z

Zahnfleischschere GOLDMAN-FOX	59
Zahnfleischschere WAGNER	60
ZAUFAL-JANSEN Hohlmeißelzange	249
Zecken-Pinzette	48
ZENKER Arterienklemme	109
ZENKER Wundhaken	183
ZIEGLER Irismesser	391
ZIEGLER Lidsperrer	389
ZIEGLER Stirnspiegel	16
ZIELKE Flachmeißel	200
ZÖLLNER Saugrohr	280
Zugendrücken ANDREW	430
Zugendrücken DINGMANN	432
Zugendrücken HARTMANN	430
Zugendrücken KILNER-DOUGHTY	433
Zugendrücken TOBOLD	430
Zungenspatel	430-432
Zungenspatel BRUENINGS	430
Zungenspatel BUCHWALD	430
Zungenspatel FRENZEL	430
Zungenspatel KROENIG	432
Zungenspatel MAYO	432
Zungenspatel MORITZ-SCHMIDT	435
Zungenzange COLLIN	435
Zungenzange YOUNG	435
Zwischenknochenmesser	10
Zyklodialysespatel ELSCHNIG	393
Zyklodialysespatel WHEELER	394

A

abdominal retractor BALFOUR	235,240
abdominal retractor COLLIN	232
abdominal retractor COLLIN-LOKTITE	238
abdominal retractor DENIS-BROWN	242
abdominal retractor DOYEN	236
abdominal retractor FRAZIER	239
abdominal retractor GOSSET	239
abdominal retractor KIRSCHNER	241
abdominal retractor O'SULLIVAN O'CONN	239
abdominal retractor RICARD	237,238
abdominal retractor ROCHARD	236
abortion scoop CUZZI	365
abortion scoop WALLICH	366
ABRAHAM tonsil knife	439
ADLERDYCE elevator	269
ADSON dressing forceps	44-45
ADSON dura hook	261
ADSON elevator	269
ADSON hemostatic forceps	106
ADSON hypophyseal forceps	277
ADSON retractor	226,227
ADSON suction	279
ADSON tissue forceps	44
ADSON-BABY hemostatic forceps	106
ADSON-BABY retractor	226
ADSON-BROWN tissue forceps	45,50
air bag POLITZER	404
ALAN-PARKS anal retractor	328
ALEXANDER biopsy forceps	298
ALEXANDER chissel	196
ALEXANDER elevator	206
ALEXANDER gouges	196
ALLEN blingut forceps	132
ALLIS bowel and tissue grasping forceps	121
ALLIS bowel and tissue grasping forceps atrauma	121
ALLIS-ADAIR bowel and tissue grasping forceps	121
ALLIS-BABY bowel and tissue grasping forceps	121
ALLISON lung spatula	310
ALM retractor	229
amniotome BEACHAM	350
amputation knife CATLIN	10
amputation knife LANGENBECK	10
amputation knife LISTON	10,12
amputation saw CHARRIERE	194
amputation saw SATTERLEE	194
anal retractor BARR	329
anal retractor BODENHAMMER	328
anal retractor CZERNY	328
anal retractor MATHIEU	328
anal retractor PRATT	329
anal retractor SCHULZE-BERGMANN	329
anal retractor SIMS	328
anal spreader SMITH-BUIE	329
anastomosis clamp DE MARTEL WOLFSON	134
anastomosis clamp STONE	133
ANDERSON-ADSON retractor	226
ANDREW tongue depressor	430
Aneurysm vessel clip YASARGIL	448,470
anoscope HIRSCHMANN	332
anoscope IVES-FANSLER	332
antrum rasp. GALLAHER	426
antrum rasp. LEWIS	426
aortic clamps DIETRICH	161
aortic clamps WEBER	153
aortic dilators COOLEY	165
aortic dilators TUBBS	165

applying forceps BIEMER	464
applying forceps BIEMER	467,469
applying forceps JOHNS-HOPKINS	48
applying forceps MC KENZIE	273
applying forceps MEHDORN	465
applying forceps OLIVECRONA-TOENNIS	273
applying forceps RANEY	274
applying forceps SMITHWICK	273
applying forceps SWEET	273
approximator BIEMER	469
approximator BIEMER-MUELLER	469
approximator MUELLER	467
ARCHER splinter forceps	47
Arthroskopie-forceps	446
ARRUGA capsular forceps	399
ARRUGA extraction hook	393
ARRUGA eye protectors	388
ARRUGA eye specula	388
ARRUGA needle holder	90
ASCH septum straightening forceps	420
hemostatic forceps CRAFOORD	109
hemostatic forceps CRAFOORD-SELLORS	110
aspirating curette	361
atrauma bowel and tissue grasping forceps	131
atrauma bowel and tissue grasping forceps ALLIS	121
atrauma bulldog clamps	140-143
atrauma bulldog clamps DE BAKEY	140
atrauma bulldog clamps GLOVER	141
atrauma forceps BAINBRIDGE	148
atrauma forceps BECK	148
atrauma forceps COOLEY	161
atrauma forceps COOLEY-DERRA	148
atrauma forceps DE BAKEY	140-149
atrauma forceps DE BAKEY	151-154
atrauma forceps DE BAKEY	157-158
atrauma forceps DE BAKEY-MOSQUITO	146
atrauma forceps DE BAKEY-PEAN	146
atrauma forceps DERRA	148
atrauma forceps GLOVER	141,151
atrauma forceps neonatal	163-164
atrauma forceps POTTS	150,152
atrauma forceps SATINSKY	155
atrauma forceps SUBRAMANIAN	162
atrauma hemostatic forceps	144-145
AUFRIEHT nasal retractor	428
auricle clamp HARKEN	156
AUVARD vaginal specula	339
awl	440
awl OBWEGESER	440
AYER chalazion forceps	399

B

BABCOCK bowel and tissue grasping forceps	121
BABINSKY percussions hammer	15
BABY-TISCHLER biopsy forceps	351
BABY-YANKAUER suction cannula	17
BACKHAUS towel forceps	127
BAILEY rib contractor	310
BAILEY-BABY rib contractor	310
BAINBRIDGE atrauma forceps	148
BAINBRIDGE hemostatic forceps	108
BAKES bile duct dilators	122
BALFOUR abdominal retractor	235,24
BALLENGER septum elevator	423
BALLENGER septum swivel knife	423
BALLENGER tonsil forceps	438

bandage scissors BERGMANN	72
bandage scissors BRUNS	72
bandage scissors ESMARCH	72
bandage scissors KNOWLES	72
bandage scissors LISTER	72
bandage scissors SEUTIN	72
bandage scissors SMITH USARMY	61
bandage scissors UNIVERSAL	72
bandage sterilizing drum SCHIMMELBUSCH	378
BARACANI tip	302
BARANY noise apparatus	404
BARBARA hooks	413
BARBARA needle	413
BARNHILL ring knife	429
BARON suction	279
BARR anal retractor	329
BARRAQUER eye scissors	401
BARRAQUER eye specula	388
BARRAQUER iris forceps	398
BARRAQUER micro needle holder	90
BARRAQUER-KATZIN iris forceps	398
BARRET tenaculum forceps	347
BARTON obstetrical forceps	364
BARTON traction handle	364
BAUMGARTNER needle holder	89,94
BEACHAM amniotome	350
BECK atrauma forceps	148
BECKMANN retractor	227
BECKMANN ring knife	429
BECKMANN-EATON retractor	227
BEEBEE crown scissors	59
BEER cilia forceps	400
BELLUCCI micro ear scissors	408
BENNETT bone lever	259
BENSON polyrus spreader	132
BERGMANN bandage scissors	72
BERGMANN hammer	211
BERRY pin cutter	223
BETHUNE rip scissors	311
BEYER bone rongeur	246,249
BIEMER applying forceps	467,469
BIEMER applying forceps	464
BIEMER approximator	469
BIEMER-MUELLER approximator	466
BILLEAU ear loop	405
biopsy and suction currettes	361
biopsy currettes HEANY	350
biopsy currettes MÜNCHEN	350
biopsy currettes NOVAK	344
biopsy currettes RANDALL	344
biopsy forceps ALEXANDER	7,298
biopsy forceps BURKE	305
biopsy forceps EPPENDORFER	305
biopsy forceps FAURE	296
biopsy forceps KEVORKIAN	1,351
biopsy forceps KEVORKIAN	298
biopsy forceps MINI-TOWNSEND-UP	1,351
biopsy forceps SCHUBERT	296
biopsy forceps SCHUMACHER	298
biopsy forceps THOMAS-GAYLOR	296
biopsy forceps TISCHLER	1,351
biopsy forceps TISCHLER-MORGAN	1,351
biopsy forceps TOWNSEND	1,351
biopsy forceps TONWSEND-MINI	1,351
biopsy forceps VAN DOREN	298
biopsy forceps WITTNER	307
bipolar cable	386
bipolar forceps	384-386
BISHOP-HARMAN iris forceps	398
bladder neck spreader MILLIN	323
bladder retractor JUDD-MASSON	323
bladder retractor LEGUE	323

bladder retractor MILLIN	323	bone rongeur MEAD	244	BRUENINGS tongue depressor	430
bladder retractor THOMSON-WALKER	323	bone rongeur OLIVECRONA	245	BRUENINGS tonsil knife	423,439
bladder spatula KOCHER	323	bone rongeur RUSKIN	249	BRUNETTI chissel	263
bladder spatula LEGUEU	323	bone rongeur SAUERBRUCH	248	BRUNINGS tonsil snare	420
blade breakers CASTROVIEJO	41	bone rongeur SCAGLIETTI	248	BRUNNER intestinal and stomach forceps	131
blade breakers	41	bone rongeur SEMB	248	BRUNNER ligature conductor	100
blade breakers TROUTMAN	41	bone rongeur SMITH-PETERSEN	247	BRUNNER retracor	180-187
BLAKE gall stone forceps	123	bone rongeur STILLE-LUER	249	BRUNNER rib shears	311
BLAKE uterine curettes	346	bone rongeur STILLE-RUSKIN	249	BRUNS bandage scissors	72
blindgut forceps ALLEN	132	bone rongeur ZAUFAL-JANSEN	249	BRUNS spoon	290
blindgut forceps KLEINSCHMIDT	132	bone splinter forceps BOEHLER	252	brush dispenser	379
BLOHMKE tonsil forceps	438	bone splinter forceps COTTLE- KAZANJIAN	253	brush for cleaning	379
BLOUNT bone lever	260	bone splinter forceps LISTON	253	BRYANT dressing forceps	120
BLOUNT meniscus retractor	260	bone splinter forceps MC INDOE	252	BUCHWALD tongue depressor	430
BLUMENTHAL bone rongeur	245	bone splinter forceps RUSKIN-LISTON	253	BUCK ear curettes	405
BODENHAMMER anal retractor	328	bone splinter forceps SEMB	252	BUCK foreign body lever	406
BOEHLER bone rongeur	247	bone splinter forceps STILLE-HORSLEY	252	BUCK percussions hammer	15
BOEHLER bone splinter forceps	252	bone splinter forceps STILLE-LISTON	253	bulldog clamps atrauma DEBAKEY	140
BOEHLER extension bows	205	bone wire	209	bulldog clamps atrauma GLOVER	141
BOERMA obstetrical forceps	364	bone wire guides	262	bulldog clamps DEBAKEY DIETHRICH	143
BOETTCHER tonsil scissors	56	bone wire guides DEMEL	262	bulldog clamps DIETHRICH	143
BOIES elevator	206	bone wire KIRSCHNER	209	bulldog clamps JOHNS-HOPKINS	48
bone drill	224	bone wire tighteners DEMEL	262	BUMM uterine curettes	358
bone drill BUNELL	224	bone wire tighteners LOUTE	204	BUNELL bone drill	224
bone drill CUSHING	218	BONNEY tissue forceps	45	BUNELL tendon passing instrument	272
bone drill HUDSON	218	BOSE tracheal hook	170	BUNT safety pins	369
bone drill RALK	224	bowel and tissue grasping forceps ALLIS 121		BURKE biopsy forceps	305
bone drill STILLE-SHERMAN	218	bowel and tissue grasping forceps ALLIS-ADAIR	121	BUSCH umbelical scissors	61
bone file	217	bowel and tissue grasping forceps ALLIS-BABY	121		
bone holding forceps	254-255	bowel and tissue grasping forceps atrauma	121		
bone holding forceps BIRCHER- GANSKE	255	bowel and tissue grasping forceps atrauma ALLIS	121		
bone holding forceps DINGMANN	255	bowel and tissue grasping forceps BABCOCK	121		
bone holding forceps FARABEUF	254	bowel and tissue grasping forceps BOYEN	130		
bone holding forceps FARABEUF-LAMB 254		bowel and tissue grasping forceps DUVAL	130		
bone holding forceps FELDHHEIM	371	bowel and tissue grasping forceps JUDD-ALLIS	121		
bone holding forceps GERSTER	204	bowel and tissue grasping forceps THOMS-ALLIS	121		
bone holding forceps KERN	254	bowel and tissue grasping forceps WILLIAMS	131		
bone holding forceps LAMBOTTE	254	BOWMAN eye specula	388		
bone holding forceps LANE	253	BOWMAN lachrymal dilators	394		
bone holding forceps LANGENBECK	254	box PETRI	375		
bone holding forceps LEWIN	256	BOZEMANN dressing forceps	119		
bone holding forceps LOWMAN	204	brain clip RANEY	274		
bone holding forceps MARTIN	256	brain knife VIRCHOW	11		
bone holding forceps SEMB	254	brain spatula CUSHING	279		
bone holding forceps	257	brain spatula OLIVECRONA	279		
bone holding forceps REIL	257	BRAND tendon seizing instrument	272		
bone holding forceps	255,256	BRAUN cranioclast	366		
bone holding forceps ULRICH	257	BRAUN decapitating hook	366		
bone holding forceps VAN BUREN	255	BRAUN tenaculum forceps	347		
bone holding forceps VERBRUGGE	255	BRAUN uterine Depressor	350		
bone lever	259-260	BRAUN-STADLER episiotomy scissors	72		
bone lever BENNETT	259	BREISKY vaginal specula	340		
bone lever BLOUNT	260	broncho-forceps CHEVALIER- JACKSON	296		
bone lever HOHMANN	258,259	bronchus forceps FINOCCHIETTO	128		
bone lever HOHMANN-MINI	258	bronchus forceps HARRINGTON	128		
bone lever SMILLIE	260	bronchus forceps PRICE-THOMAS	128		
bone lever TAYLOR	260	bronchus forceps SEMB	129		
bone nail STEINMANN	267,268	BRUENINGS ear specula	404		
bone rongeur BEYER	246,249	BRUENINGS septum forceps	416		
bone rongeur BLUMENTHAL	245	BRUENINGS tip	302		
bone rongeur BOEHLER	247				
bone rongeur CLEVELAND	244				
bone rongeur ECHLIN	248				
bone rongeur FRIEDMAN	244				
bone rongeur FRIEDMAN-MINI	244				
bone rongeur FRYKHOLM	248				
bone rongeur KLEINERT-KUTZ	246				
bone rongeur LEKSELL-STILLE	249				
bone rongeur LEMPERT	244				
bone rongeur LUER	245				

C

cable bipolar	386
cannula WULLSTEIN	405
capsular forceps ARRUGA	399
capsular forceps HESS	398
capsular forceps SCHWEIGGER	399
cardiovascular clamps	162
CAROLL tendon seizing instrument	272
CARPENTER tonsil knife	436
cartilage knife LANGENBECK	10
CASPAR retractor	231,233
CASTANEDA neonatal-forceps	163-164
CASTROVIEJO blade breakers	41
CASTROVIEJO knife	392
CASTROVIEJO iridectomy scissors	401
CASTROVIEJO marker	396
CASTROVIEJO needle holder	88,95
catheter	322
catheter forceps MAGILL	17
catheter introducer GUYON	322
CATLIN amputation knife	10
cervical traction clamp CRUTCHFIELD	274
chalazion curettes MEYHOEFER	395
chalazion forceps AYER	399
chalazion forceps DESMARRES	399
CHAPUT hemostatic forceps	102
CHARRIERE amputation saw	194
CHEATLE sterilisation forceps	369
Cheek and lip retractor STERNBERG	430
CHELSEA-EATON proctoscope	332
CHERON dressing forceps	120
CHERRY laminectomy retractor	318
CHILDE clip forceps	97
chissel	195-201
chissel LEBSCHE	217
chissel ALEXANDER	196
chissel BRUNETTI	263
chissel COBB	199
chissel COTTLE	424
chissel FOMON	424
chissel FREER	423

dressing forceps INDOE	85	elevator KEY	269	eye specula WILLIAMS	389
dressing forceps MC INDOE	85	elevator KOENIG	206	eye specula ZIEGLER	389
dressing forceps POTTS-SMITH	84	elevator LAMBOTTE	205		
dressing forceps SEMKEN	84,85	elevator LANGENBECK	205	F	
DUPLAY tenaculum forceps	127	elevator LEMPERS	413	FANSLER proctoscope	331
DUPUY-WEISS tonsil needle	439	elevator MATSON	207	FARABEUF bone holding forceps	254
dura dissector	275	elevator MATSON-ALEXANDER	207	FARABEUF elevator	205
dura dissector DAVIS	275	elevator MC DONALD	269	FARABEUF retractor	186
dura dissector FRAZIER	276	elevator OBWEGESER	440	FARABEUF-COLLIN elevator	205
dura dissector HOEN	276	elevator OVERHOLT	207	FARRELL cotton applicator	412
dura dissector HORSLEY	276	elevator SAYRE	269	FAULKNER curette	428
dura dissector MILLIGAN	275	elevator SEDILLOT	205	FAURE biopsy forceps	296
dura dissector OLIVECRONA	275	elevator SEMB	208	FAURE peritoneum forceps	126
dura dissector PENFIELD	276	elevator septum	421,423	FAVALORO scissors	64
dura dissector SACHS	275	elevator septum BALLENGER	421,423	FEHLAND intestinal forceps	431
dura dissector TOENNIS	275	elevator septum COTTLE	421	FEILCHENFELD splinter forceps	44
dura hook ADSON	261	elevator septum FREER	421	FERGUSON gall stone scoop	124
dura hook JACOBSON	278	elevator septum JOSEPH	421	FERRIS-SMITH-KERRISON punch	293,294
dura knife KOOS	278	elevator septum KILLIAN	421,425	finger nail drill	370
DURANTE forceps	45	elevator septum MCKENTY	421	finger protector LANGENBECK	431
DUVAL bowel and tissue grasping		elevator septum COTTLE-JOSEPH	424	finger ring saw LANGENBECK	194
forceps	130	elevator tonsil HENKE	436	finger ring saw	370
DUVAL forceps	46	elevator WATSON-CHEYNE	269	FINOCCHIETTO bronchus forceps	128
		elevator WILLIGER	206	FINOCCHIETTO needle holder	89
E		ELLIOT obstetrical forceps	363	FINOCCHIETTO rib spreader	314
ear catheter HARTMANN	405	ELSAESSER nephrostomy forceps	123	FINSEN retractor	229
ear curettes BUCK	405	ELSCHNIG cycldialysis spatula	393	FISCH hooks	278
ear forceps HEYMANN-KNIGHT	416	ELSCHNIG forceps	397	FISCHER iris forceps	399
ear forceps JANSEN	47,406	ELSCHNIG knife	390	FISH sound	15
ear forceps LUCAE	47,406	EMMET hooks	344	FISHER tonsil knife	439
ear forceps micro	407	endospecula KOGAN	341	fistula hook EMMET	344
ear forceps micro COS	407	ENGEL plaster saw	74	fistula sound PRATT	332
ear forceps micro GREVEN	407	enterotomy scissors	59	fixation forceps ELSCHNIG	397
ear forceps micro HAUGH	407	entropium forceps SNELLEN	399	fixation forceps GRAEFE	399
ear forceps micro JUERS	407	epiglottis retractor REICHERT	297	FOERSTER iris forceps	399
ear forceps micro MCGEE	407	episiotomy scissors BRAUN-STADLER	72	FOERSTER sponge holding forceps	119,120
ear forceps micro oval	407	episiotomy scissors WALDMANN	60	FOMON chissel	424
ear forceps TROELTSCH	406	EPENDORFER biopsy forceps	305	FOMON elevator	206
ear forceps WILDE (TROELTSCH)	406	erisophakes DASTOOR	396	FOMON hook	428
ear knife POLITZER	405	ESMARCH bandage scissors	72	FOMON nasal rasp	426
ear knife SEXTON	405	ESMARCH plaster knife	74	FOMON nasal scissors	62
ear loop BILLEAU	405	EVES tonsil snare	438	FOMON scissors	59
ear polypus forceps DOYEN uterine	137,349	extension bows BOEHLER	205	forceps bipolar	385-386
ear polypus forceps KELLY uterine	137,349	extension bows KIRSCHNER	204	forceps POTTS-SMITH	44
ear polypus forceps uterine NOTO	137,349	extension bows KIRSCHNER US	204	FOREGGER laryngoscope	19-36
ear scissors micro BELLUCCI	408	extraction hook ARRUGA	393	foreign body chissel DIX	394
ear scissors micro SHEA	408	extraction hook ROLLET	393	foreign body forceps HARTMANN	407
ear snare KRAUSE	406	eye hook GRAEFE	393	foreign body forceps HARTMANN-	
ear snare WILDE	406	eye magnet	400	HOFFMAN	407
ear sound STACKE	15	eye protectors ARRUGA	401	foreign body forceps HARTMANN-	
ear specula HARTMANN	404	eye scissors BARRAQUER	401	WULLST	407
ear specula SIEGLE	404	eye scissors NOYES	401	foreign body forceps MATHIEU	325
ear specula TOYNBEE	404	eye scissors VANNAS	401	foreign body forceps STRUEMPEL	407
ear syringe REINER	407	eye scissors WECKER	401	foreign body forceps WULLSTEIN	407
ECHLIN bone rongeur	248	eye scissors WESTCOTT	67	foreign body gouges WALTON	391
elevating spoon SELLHEIM	366	eye specula ARRUGA	388	foreign body instrument DIX	394
elevator	205-208	eye specula BARRAQUER	388	foreign body lever BUCK	406
elevator ADLERDYCE	269	eye specula BOWMAN	388	foreign body lever QUIRE	406
elevator ADSON	269	eye specula CASTROVIEJO	389	FOX curettes	368
elevator ALEXANDER	206	eye specula CLARK	388	FRAENKEL layngeal polypus forceps	297
elevator BOIES	206	eye specula CRITCHETT	388	FRAENKEL tip	302
elevator COTTLE	421	eye specula GRAEFE	388	FRAZIER abdominal retractor	239
elevator CREGO	269	eye specula LANCASTER	389	FRAZIER cannula	17
elevator DINGMANN	440	eye specula LISTER-BURCH	389	FRAZIER dura dissector	276
elevator DOYEN	208	eye specula MELLINGER	388	FRAZIER suction tube	17
elevator FARABEUF	205	eye specula MELLINGER-AXENFELD	388	FREER chissel	425
elevator FARABEUF-COLLIN	205	eye specula MUELLER	389	FREER hook	176
elevator FOMON	206	eye specula MURDOCK	389	FREER knife	423
elevator GORNEY	206	eye specula PARK	389	FREER septum chissel	423
elevator JOSEPH	206	eye specula SMITH	389	FREER septum elevator	423
		eye specula STEVENSON	389		
		eye specula WEEK	389		

FREER septum knife	423
FRENZEL tongue depressor	430
FRIEDMANN bone rongeur	244
FRIEDMANN specula	339
FRITSCH retractor	187
FRYKHOLM bone rongeur	248

G

Gastroskopie	445
galea hook YASARGIL	270
gall stone forceps BLAKE	123
gall stone forceps DESJARDINS	122
gall stone forceps MAYO-BLAKE	123
gall stone forceps MIXTER	123
gall stone probes DESJARDINS	125
gall stone scoop DESJARDINS	125
gall stone scoop FERGUSON	124
gall stone scoop LUER-KOERTE	124
gall stone scoop MAYO	125
gall stone sound MAYO	125
GALLHER nasal rasps	426
gallbladder scissors THOREK	62
GAUSS forceps	365
GELPI retractor	232
GEMINI hemostatic forceps	109
GERALD dressing forceps	44
GERALD tissue forceps	45
GERSTER bone holding forceps	204
GERZOG hammer	210
GIERTZ-STILLE rib shears	311
GIGLI handle	194
GILL iris forceps	398
GILL-HESS iris forceps	398
GILLIES needle holder	88
GILLIES skin hooks	428
GILLIES tissue forceps	45
GIL-VERNET retractor	184
GLOVER atrauma bulldog clamps	141
GLOVER atrauma forceps	151
GLUCK rib shears	310
GOELET retractor	185
goitre seizing forceps LAHEY	173
goitre sound KOCHER	173
GOLDMAN-FOX gum scissors	59
GOMEL micro forceps	50
GOMEL micro scissors	69
GOOD tonsil scissors	343
GOODELL uterine dilator	343
GORNEY elevator	206
GOSSET abdominal retractor	239
gouges	196-201
gouges ALEXANDER	196
gouges COBB	199
gouges HIBBS	197
gouges LEXER	195
gouges LEXER-MINI	195
gouges SMITH-PETERSEN	198
gouges STILLE	201
GRAEFE discision knife	390
GRAEFE eye specula	388
GRAEFE fixation forceps	399
GRAEFE hook	393
GRAEFE iris forceps	396
GRAEFE skin hooks	393
GRAEFE starbismus hook	393
GRAEFE starbismus knife	390
GRAEFE starbismus scoob	395
GRAEFE fixation forceps	399
GRAHAM nerve hook	261
GRAVE vaginal specula	335

GRAY hemostatic forceps	112
GREVEN micro ear forceps	407
GROSS-MAIER dressing forceps	119
guide needle REDON	447
gum scissors GOLDMAN-FOX	59
gum scissors WAGNER	60
GUTHRIE skin hooks	176,393
GUYON dilating bougies	322
GUYON hemostatic forceps	113,131
gynecological scissors KELLY	60
gynecological scissors SIMS	60
gynecological scissors WERTHEIM	126
gynecological scissors Laparoskopie	1,353

H

HABERER intestinal spatula	190
haemorrhoidal ligator MC GIVNEY	308
haemorrhoidal ligator RUDD	308
haemorrhoidal forceps HEYWOOD-SMITH	304
haemorrhoidal forceps MC GIVNEY	308
HAGLUND-STILLE plaster cast spreader	74
HAIGHT rib spreader	317
HAJEK nasal forceps	419
HAJEK chissel	425
HAJEK hammer	213
HAJEK-KOFLER punch	417
HALLE spoon	288
HALSEY needle holder	94
hammer	210-213
hammer BERGMAN	211
hammer COLLIN	210
hammer COTTLE	211,213
hammer GERZOG	210
hammer HAJEK	213
hammer HEATH	213
hammer KIRK	210
hammer LUCAE	210
hammer MEAD	210
hammer OMBREDANNE	213
hammer PARTSCH	211
hammer WILLIGER	210
Hand bone drill MOORE	218
handle DeVILBIS	275
handle for laryngeal mirror	303
handle GIGLI	194
handle HUBER	302
HANK uterine dilators	342
HARKEN auricle clamp	156
HARRINGTON bronchus forceps	128
HARRINGTON retractor	191
HARTMANN nasal forceps	418
HARTMANN ear forceps	407
HARTMANN ear catheter	405
HARTMANN ear polypus forceps	407
HARTMANN ear specula	404
HARTMANN foreign body forceps	407
HARTMANN hemostatic forceps	103,104
HARTMANN tongue depressor	430
HARTMANN tuning fork	402,403
HARTMANN-HALLE nasal specula	414
HAYES atrauma sigmoid anastomosis forc	133
head band for head mirror	16
head light CLAR	16
head mirror ZIEGLER	16
HEANEY hysterectomy forceps	126
HEANEY needle holder	89
HEANEY retractor	177

HEANY biopsy curettes	350
HEATH hammer	213
HEGAR uterine dilators	340-341
HEISS hemostatic forceps	117
HEISTER mouth gag	435
hemostatic forceps ADSON	106
hemostatic forceps ADSON-BABY	106
hemostatic forceps atrauma	121,131
hemostatic forceps atrauma	133
hemostatic forceps atrauma	140-164
hemostatic forceps BAINBRIDGE	108
hemostatic forceps CHAPUT	102
hemostatic forceps COLLIN	102
hemostatic forceps CRILE	103,104
hemostatic forceps CRILE-RANKIN	104
hemostatic forceps DANDY	107
hemostatic forceps DESJARDINS	112
hemostatic forceps DIEFFENBACH	48
hemostatic forceps FERGUSON	107
hemostatic forceps GEMINI	109
hemostatic forceps GRAY	112
hemostatic forceps GUYON	113
hemostatic forceps HALSTED-MOSQUITO	106
hemostatic forceps HARTMANN	103,104
hemostatic forceps HEISS	117
hemostatic forceps JOHNS-HOPKINS	111
hemostatic forceps KELLY	103
hemostatic forceps KELLY-RANKIN	104
hemostatic forceps KOCHER	103
hemostatic forceps LAHEY	117
hemostatic forceps LAWRENCE	111
hemostatic forceps LERICHE	107
hemostatic forceps LOVELACE	107
hemostatic forceps LOWER	117
hemostatic forceps MAYO-GUYON	113
hemostatic forceps MEEKER	111
hemostatic forceps MICR-HARTMANN	103
hemostatic forceps MIXTER	111,112
hemostatic forceps MISTER-BABY	111
hemostatic forceps MOYNIHAN	112
hemostatic forceps NELSON	46
hemostatic forceps O'SHAUGNESS	111
hemostatic forc. OVERHOLT-GEISSENDORF	108
hemostatic forceps PEAN	102,103
hemostatic forceps PEAN	105
hemostatic forceps PENNINGTON	107
hemostatic forceps PROVIDENCE HOSPITAL	103
hemostatic forceps ROBERTS	108
hemostatic forceps ROCHESTER CARMALT	107
hemostatic forceps ROCHESTER OCHSNER	105
hemostatic forceps RUMEL	108
hemostatic forceps SAROT	109
hemostatic forceps SPENCER-WELLS	103
hemostatic forceps STILLE	113
hemostatic forceps TOENNIS	110
hemostatic forceps TUFFIER	102
hemostatic forceps WANGENSTEEN	85
hemostatic forceps ZENKER	109
hemostatic clamp SATINSKY	129
HENKE tonsil elevator	436
HENLEY retractor	228
HENNIG plaster cast spreader	74
HEPP-SCHIEDL micro scissors	68
HERCULES pin cutter	216
HERRICK hysterectomy forceps	114
HESS capsular forceps	398
HESS iris forceps	398

HEYMANN nasal scissors	56	iris forceps GILL	398	KEYES skin punch	368
HEYMANN septum forceps	416	iris forceps GILL-HESS	398	kidney stone forceps RANDALL	122
HEYWOOD-SMITH haemorrhoidal forceps	304	iris forceps GRAEFE	399	KIELLAND obstetrical forceps	363
HIBBS chissel	197	iris forceps HESS	398	KIELLAND-LUIKART obstetrical forceps	363
HIBBS gouges	197	iris forceps STEVENS	396	KILLIAN irrigation cannula	420
HIRSCHMANN anoscope	332	iris forceps TUEBINGEN	400	KILLIAN nasal specula	414
HOEN dura dissector	276	iris knife KNAPP	391	KILLIAN septum elevator	421
HOESEL needle holder	91	iris knife ZIEGLER	391	KILLIAN septum scissors	297
HOESEL retractor	180	iris spatula CULLER	393	KILLIAN-CLAUS chissel	425
HOFER retractor	436	iris spatula WECKER	393	KILNER needle holder	88
HOFFMANN tubing forceps	341	irrigation cannula KILLIAN	420,422	KILNER operating scissors	56
HOHMANN bone lever	258,259	irrigation cannula RITTER-HALLE	422	KILNER skin hooks	368
HOHMANN-MINI bone lever	258	irrigation cannula SIEBENMANN	422	KILNER-DOUGHTY mouth gag	433
HOKE chissel	197	ISRAEL retractor	188	KIRSCHNER abdominal retractor	241
HOLINGER laryngoscope	34	ITERSON tracheal hook	170	KIRSCHNER bone wire	266
HOLINGER light guide	34	IVES-FANSLER anoscope	332	KIRSCHNER extension bows	204
HOLSHER nerve root retractor	270	IUD forceps	306	KLEINERT-KUTZ bone rongeur	246
HOLTH punch	396			KLEINERT-KUTZ tendon seizing instrument	272
hook SMELLIE	365	J		KLEINSCHMIDT blindgut forceps	132
hooks	413	JACKSON laryngeal ploypus forceps	297	KNAPP extraction hook	394
hooks BARBARA	413	JACKSON tracheal hook	170,171	KNAPP iris knife	391
hooks FISCH	278	JACOBS tenaculum forceps	348	KNAPP starbismus scoop	395
hooks MC GEE	413	JACOBSON dura hook	278	KNAPP-LUER trachoma forceps	397
hooks mit Knopf WAGENER	406	JACOBSON needle holder	90	knife dura KOOS	278
HOPKINS plaster cast	74	JACOBSON sound	278	knife FREER	423
HORSLEY dura dissector	276	JACOBSON spoon	287	knife MUCK	413
HOUSE curettes	413	JAEGER discision knife	392	knife PLESTER	411
HOUSE suction cannula	281	JAEGER lid plate	389	knife ROSEN	411
HUBER handle	302	JAMESON starbismus hook	393	knife SCHUKNECHT	411
HUDSON t-handle	218,219	JANSEN ear forceps	47,406	knife TABB	411
HULKA tenaculum forceps	127	JANSEN retractor	229	knife tonsil ABRAHAM	439
HUMBY dermatome	12	JANSEN spoon	287	knife tonsil BRUENINGS	439
HUNTER splinter forceps	47	JARCHO tenaculum forceps	347	knife tonsil CARPENTER	436
HURD tonsil dissector	436	JENNINS mouth gag	434	knife tonsil FISHER	439
hypophyseal curettes	277	JOBSON cotton applicator	412	KNIGHT septum forceps	416
hypophyseal forceps ADSON	277	JOHNS-HOPKINS applying forceps	48	KNOWLES bandage scissors	72
hysterectomy forceps BALLENTINE	115	JOHNS-HOPKINS bulldog clamps	48	KOCHER bladder spatula	323
hysterectomy forceps FAURE	126	JOHNS-HOPKINS hemostatic forceps	111	KOCHER goitre directors	173
hysterectomy forceps HEANEY	115	JONES towel forceps	127	KOCHER hemostatic forceps	105
hysterectomy forceps HEANY	115	JORGENSEN dissecting scissors	57	KOCHER intestinal forceps	130
BALLENTINE	115	JOSEPH elevator	206,421	KOCHER intestinal forceps atrauma	130
hysterectomy forceps HERRICK	114	JOSEPH nasal knife	423	KOCHER retractor	178,186
hysterectomy forceps PHANEUF	114	JOSEPH nasal rasp	427	KOCHER retractor	187,192
hysterectomy forceps ROGERS	115	JOSEPH nasal rasp (LEWIS)	426	KOENIG elevator	206
hysterectomy forceps WERTHEIM	114	JOSEPH nasal saw	428	KOENIG ligature conductor	99
hysterectomy forceps WERTHEIM- CULLEN	114	JOSEPH opreating scissors	58	KOERTE retractor	188
		JOSEPH skin hooks	176	KOGAN vaginal specula	341
I		JUDD-ALLIS bowel and tissue grasping forc	121	KOOS dura knife	278
INDOE dressing forceps	44	JUERS micro ear forceps	407	KRAUSE ear snare	406,420
INGE lamina spreader	282	JURASZ laryngeal ear polypus forceps	297	KRAUSE tip	302
instrument box table	374-375	Jrrigator	377	KRAYENBUEHL nerve hooks	279
intestinal and stomach forceps		K		KRISTELLER vaginal specula	339
BRUNNER	131	KABIERSKE powder blower	404	KROENIG tongue depressor	432
intestinal clamps PAYR	130	KALLMORGEN vaginal specula	339	KRONECKER ligature needles	100
intestinal forceps FEHLAND	131	KALT-ARRUGA needle holder	90	KUHNT skin dissector	391
intestinal forceps KOCHER	130	KANE umbilical forceps	365		
intestinal forceps LITTLEWOOD	136	KELLY gynecological scissors	60	L	
intestinal forceps STONE-WATT	133	KELLY hemostatic forceps	103	LABOR bowel	377
intestinal spatula HABERER	190	KELLY proctoscope	332	LABORD tracheal dilators	170
intestinal spatula REVERDIN	190	KELLY retractor	190,192	lacrymal dilators WILDE	394
intestinal spatula RIBBON	190	KELLY-RANKIN hemostatic forceps	104	lacrymal probe BOWMAN	394
IOWA tenaculum forceps	348	KERN bone holding forceps	254	LAFORCE blades	429
iris forceps BARRAQUER	398	KERRISON punch	419	LAFORCE ring knife	429
iris forceps BARRAQUER-KATZIN	398	KEVORKIAN biopsy curettes	298	LAHEY goitre seizing forceps	173
iris forceps BISHOP-HARMAN	398	KEVORKIAN biopsy forceps	1,351,298	LAHEY hemostatic forceps	117
iris forceps BONN	398,400	KEY elevator	269	LAHEY retractor	178
iris forceps FISCHER	397,399			LAMBOTTE bone holding forceps	254
iris forceps FOERSTER	397,399			LAMBOTTE elevator	205
				LAMBOTTE osteotome	195,199

lamina spreader CLOWARD	282	LISTER bandage scissors	72	measuring instrument	14
lamina spreader INGE	282	LISTER dressing forceps (SINUS)	120	measuring instrument COLLIN	14
laminectomy forceps CLOWARD	299	LISTER-BURCH eye specula	389	measuring instrument MOELTGEN	14
laminectomy forceps CUSHING	292	LISTON amputation knife	10	measuring instrument WARTENBERG	14
laminectomy forceps FERRIS- SMITH	293,294	LISTON bone splinter forceps	253	MEEKER hemostatic forceps	111
laminectomy forceps LOVE- GRUENWALD	292	LITTAUER cilia forceps	400	MEHDORN applying forceps	465
laminectomy forceps OLDBERG	295	LITTAUER ligature scissors	58	MEHDORN vessel clip	465
laminectomy forceps SCHLESINGER	299	LITTLE retractor	178	MELLINGER eye specula	388
laminectomy forceps SPURLING	292	LITTLEWOOD intestinal forceps	136	MELLINGER-AXENFELD eye specula	388
laminectomy retractor	233,234	LORNA towel forceps	127	meniscus knife NEFF	271
laminectomy retractor SCOVILLE	234	LOUTE bone wire tighteners	204	meniscus retractor BLOUNT	260
LANDAU vaginal specula	340	LOVE nerve root retractor	261	meniscus knife SMILLIE	271
LANDOLT forceps	295	LOVE retractor	436	MERCEDES thorax retractor	319
LANE bone holding forceps	253	LOVELACE hemostatic forceps	107	METZENBAUM dissecting scissors	55
LANE tissue forceps	46	LOWER hemostatic forceps	117	MEYERDING retractor	179,191
LANGE tip	302	LOWMAN bone holding forceps	204	MEYERDING retractor	233
LANGENBECK amputations knife	194	LUC septum forceps	416	MEYHOEFER chalazion curettes	395
LANGENBECK bone holding forceps	254	LUCAE hammer	210	MICHEL laryngeal mirror	303,415
LANGENBECK elevator	205	LUCAE paracentesis needle	405	MICHEL suturing clip	97
LANGENBECK saw	194	LUCAE tuning fork	402	MICHEL suturing clip forceps	97
LANGENBECK finger protector	431	LUER bone rongeur	245	micro ear forceps	408
LANGENBECK cartilage knife	12	LUER tracheal cannula	171	micro ear forceps	410
LANGENBECK needle holder	91	LUIKART obstetrical forceps	364	micro ear forceps COS	407
laryngeal ear polypus forceps FRAENKEL	297	lung grasping forceps LAVELACE	128	micro ear forceps GREVEN	407
laryngeal ear polypus forceps JURASZ	297	lung scissors CRAFOORD	62	micro ear forceps JUERS	407
laryngeal mirror	303	lung spatula ALLISON	310	micro ear forceps McGEE	407
laryngeal mirror MICHEL	303			micro ear forceps oval	407
laryngeal polypus forceps JACKSON	297	M		micro ear scissors	410
laryngeal FOREGGER	19-36	MAGILL catheter introducing forceps	17	micro ear scissors BELLUCCI	408
laryngoscope HOLINGER	34	MALTZ nasal rasp (COTTLE)	426	micro ear scissors SHEA	408
laryngoscope MC INTOSH	19-21	MARTEL hemostatic forceps	102	micro forceps	49-51
laryngoscope operation	19-36	MARTIN bone holding forceps	256	micro forceps ADSON-BROWN	50
LAWRENCE hemostatic forceps	111	MARTIN pelvimeters	346	micro forceps GOMEL	50
lead hand	210	MARTIN uterine sound	341	micro forceps intraocular	409
LEBSCHKE chissel	217	MARTINI spoon	289	micro forceps VICKERS	51
LEGUE bladder retractor	323	MASSON needle holder	89	micro needle holder BARRAQUER	90
LEGUE bladder spatula	323	MASTIN forceps	173	micro scissors	63-70
LEMPERT bone rogeur	244	MATHIEU anal retractor	328	micro scissors HEPP-SCHEIDEL	68
LEMPERT elevator	413	MATHIEU foreign body forceps	325	micro scissors GOMEL	69
LEMPERT spoon	290	MATHIEU needle holder	91	MIKULICZ hyterectomy forceps	126
lens loop SNELLEN	395	MATHIEU retractor	186	MIKULICZ retractor	192
lens loop WEBER	395	MATHIEU-OLSEN needle holder	94	MILLIGAN dura dissector	275
lens loop WILDE	394	MATSON elevator	207	MILLIN bladder neck spreader	323
LERCHE forceps	46	MATSON-ALEXANDER elevator	207	MILLIN bladder retractor	323
LERICHE hemostatic forceps	107	MATZENAUER speculum	338	MILLIN capsule grasping forceps	324
LEWIN bone holding forceps	256	MAUNDER oral wedges	431	MINI-LAMBOTTE chissel	199
LEWIS nasal rasp JOSEPH	426	MAYO dissecting scissors	56	mirror for head light	16
LEWIS nasal rasps	426	MAYO gall stone scoop	125	MIXTER gall stone forceps	123
LEXER dissecting scissors	57,60	MAYO safety pins	369	MIXTER hemostatic forceps	111-112
LEXER gouges	195	MAYO tongue depressor	432	MIXTER-BABY hemostatic forceps	106
LEXER-MINI chissel	195	MAYO-BLAKE gall stone forceps	123	MOELTGEN measuring instrument	14
LEXER-MINI gouges	195	MAYO-GUYON hemostatic forceps	113	MOLLISON retractor	230
LICHTWITZ trocar	284	MAYO-HEGAR needle holder	94	MOLT mouth gag	435
lid plate JAEGER	389	MAYO-STILLE dissecting scissors	56	MOORE bone drill	218
lid plate DESMARRS	184	MC DONALD elevator	269	MORSE rib spreader	312
ligature conductor BRUNNER	100	MC GEE hooks	413	MORSE-FAVALORO rib spreader	312
ligature conductor KIRSCHNER	99	MC GEE micro ear forceps	407	mouth gag DAVIS-BOYLE	434
ligature conductor KOENIG	99	MC GIVNEY haemorrhoidal forceps	308	mouth gag DENHART	435
ligature conductor PAYR	100	MC INDOE bone splinter forceps	252	mouth gag DINGMANN	432
ligature conductor	99-100	MC INDOE scissors	62	mouth gag DOYEN-JANSEN	435
ligature conductor SCHMIEDEN-PAYR	99	MC INTOSH laryngoscope	19-21	mouth gag HEISTER	435
ligature forceps CASTROVIEJO	88-95	MC IVOR mouth gag	433	mouth gag JENNINGS	434
ligature needles COOPER	100	MC KENTY septum elevator	421	mouth gag KILNER-DOUGHTY	433
ligature needles DESCHAMPS	99	MC KENZIE applying forceps	273	mouth gag MC IVOR	433
ligature needles KRONECKER	100	MC LEAN obstetrical forceps	364	mouth gag MOLT	435
ligature needles NELSON	100	MC LEAN-LUIKART obstetrical forceps	364	mouth gag ROSER-KOENIG	435
ligature scissors LITTAUER	58	MC LEAN-TUCKER obstetrical forceps	364	MAYNIHAN hemostatic forceps	112
ligature scissors SPENCER	58	MEAD bone rongeur	244	MUCK knife	413
lip retractor	430	MEAD hammer	210	MUELLER approximator	467
		measures, graduated	14	MUELLER eye specula	389
				MUELLER vessel clip	468
				MÜNCHEN biopsy curettes	350

MURDOCK eye specula	389
MURPHY-LANE elevator	260
muscle forceps MASTIN	173
muscle forceps PRINCE	397
muscle hook	238
MUSEUX tenaculum forceps	348
MYLES nasal forceps	418
myoma knife SEGOND	344
myoma screw DOYEN	344
Myrtenblade probe	15

N

NABATOFF varicose vein probe set	232
NAEGELE obstetrical forceps	363
nail extracting forceps RADOLF	370
nail file	370
nail nipper	370
nail nipper TURNBULL	370
nail scissors	370
nasal chisel WEST	425
nasal forceps HAJEK	419
nasal forceps HARTMANN	415
nasal forceps MYLES	418
nasal forceps STRUYCKEN	418
nasal forceps WEIL-BLAKESLEY	416
nasal hook AUFRICHT	428
nasal hook COTTLE	428
nasal knife COTTLE	425
nasal knife JOSEPH	425
nasal rasp AUFRICHT	428
nasal rasp FOMON	426
nasal rasp. JOSEPH (LEWIS)	426
nasal rasp. MALTZ (COTTLE)	426
nasal rasp WIENER	426
nasal rasps GALLAHER	426
nasal rasps LEWIS	426
nasal saw JOSEPH	428
nasal scissors COTTLE	63
nasal scissors FOMON	59
nasal scissors HEYMANN	56
nasal specula COTTLE	415
nasal specula HARTMANN-HALLE	414
nasal specula KILLIAN	414
nasal specula THUDICHUM	415
nasal specula TIECK-HALLE	414
nasal specula VIENNA	414
nasal specula VOLTOLINI	415
needle BARBARA	413
needle box	374
needle for post mortem	263
needle holder	87-92
needle holder ARRUGA	90
needle holder BARRAQUER	90
needle holder BARRAQUER-TROUTMAN	90
needle holder BAUMGARTNER	94
needle holder CASTROV.-MICRO	88,95
needle holder CASTROVIEJO	88
needle holder CRILE	89
needle holder CRILE-WOOD	94
needle holder DE-BAKEY	88
needle holder DERF	94
needle holder FINOCCHIETTO	89
needle holder GILLIES	88
needle holder HALSEY	89
needle holder HEANEY	89
needle holder HOESEL	91
needle holder JACOBSON	90
needle holder KILNER	88
needle holder LANGENBECK	91

needle holder LICHTENBERG	91
needle holder MASSON	94
needle holder MATHIEU	91-94
needle holder MAYO-HEGAR	94
needle holder OLSEN-HEGAR	91
needle holder RYDER	88
needle paracentesis LUCAE	405
needle paracentesis POLITZER	405
needle REVERDIN	96
needle ROSEN	411
needle tonsil	439,440
needle tonsil DUPUY-WEISS	439
needle YOUNG-BOOMERANG	96
NEFF meniscus knife	271
NEGUS tonsil forceps	437
NELATON probe	15
NELSON forceps	46
NELSON ligature needles	100
NELSON trocar	283,284
neonatal atrauma forceps	163,164
neonatal forceps CASTANEDA	164
nephrostomy forceps ELSAESSER	123
nerve hook CUSHING	261
nerve hook DANDY	261
nerve hook GRAHAM	261
nerve hook KRAYENBUEHL	279
nerve hook SACHS	261
nerve hook SMITHWICK	261
nerve root retractor HOLSHER	270
nerve root retractor LOVE	261
nerve root retractor SCOVILLE	270
neurosurgery scissors	62
neurosurgery scissors STRULLY	62
NEWS tracheal hook	171
noise apparatus BARANY	404
NOTO uterine ear polypus forceps	137,349
NOVAK biopsy curettes	344
NOYES ear polypus forceps	401
NOYES eye scissors	401

O

OBDUCTIONS-CASE	75
obstetrical forceps BARTON	364
obstetrical forceps BOERMA	364
obstetrical forceps ELLIOT	363
obstetrical forceps KIELLAND	363
obstetrical forceps KIELLAND-LUIKART	363
obstetrical forceps LUIKART	363
obstetrical forceps MC LEAN	364
obstetrical forceps MC LEAN-LUIKART	364
obstetrical forceps MC LEAN-TUCKER	364
obstetrical forceps NAEGELE	363
obstetrical forceps PIPER	364
obstetrical forceps SIMPSON	363
obstetrical forceps SIMPSON-BRAUN	363
obstetrical forceps SIMPSON-LUIKART	363
obstetrical forceps TARNIER	364
OBWEGESER awl	440
OBWEGESER elevator	440
OBWEGESER retractor	441-442
OCHSNER trocar	283
OEHLER tissue forceps	84
OLDBERG laminectomy forceps	295
OLIVECRONA bone rongeur	245
OLIVECRONA brain spatula	279
OLIVECRONA dura dissector	275
OLIVECRONA saw	194
OLLIER retractor	187
OLSEN-HEGAR needle holder	91
OMBREDANNE hammer	213

operating scissors	54-62
operating scissors FOMON	59
operating scissors SYSTRUNK	61
ophthalmologie Instrument	57
ophthalmologie Instrument	388-401
ophtal. Scissors STEVENS	59
opreating scissors IRIS	56
opreating scissors JOSEPH	58
opreating scissors KILNER	56
opreating scissors METZENBAUM	55,57
opreating scissors REYNOLDS	58
oral wedges MAUNDER	431
osteotome	195-201
osteotome LAMBOTTE	195,199
OSTROEM punch	417
OVERHOLT elevator	207
ovum forceps PESTALOZZA	365
ovum forceps SAENGER	137,349
ovum forceps WINTER	365

P

paracentesis needle LUCAE	405
paracentesis needle POLITZER	405
parametrium vascular scissors	64
PARK eye specula	389
PARKER retractor	185-186
PARTSCH chisel	196
PARTSCH hammer	211
PAYR intestinal and stomach clamp	130
PAYR ligature conducto	100
PEAN hemostatic forceps	102-105
PEDERSON vaginal specula	335
PEERS towel forceps	127
PEET splinter forceps	47
PELKMANN dressing forceps	122
pelvimeters COLLIN	346
pelvimeters MARTIN	346
pelvis hook ST. MARKS	181
PENFIELD dissector	276
PENFIELD dura dissector	276
penis seizing forceps STOCKMANN	325
penis seizing forceps STRAUSS	325
PENNIGTON hemostatic forceps	107
percussions hammer BABINSKY	15
percussions hammer BUCK	15
percussions hammer DEJERINE	15
percussions hammer TAYLOR	15
percussions hammer TROEMNER	15
PERCY retractor	194
perforators SMELLIE	366
PESTALOZZA abortion scoop	365
PETRI Box	380
Phalangenknife	10
PHANEUF hysterectomy forceps	114
PIERCE septum elevator	284
PIERCE trocar	284
PIFFARD curettes	368
pin cutter	214-216
pin cutter HERKULES	216
PINARD stethoscope alu	14
PINARD stethoscope wood	14
PIPER obstetrical forceps	364
plaster cast forceps WOLFF	74
plaster cast HOPKINS	74
plaster cast knife ESMARCH	74
plaster cast REINER	74
plaster cast spreader HAGLUND-STILLE	74
plaster cast spreader HENNIG	74
plaster cast WIGMORE	74
plaster of Paris shaers STILLE	74

plaster saw	73	blade breakers.	41	retractor SIMON	192
plaster saw ENGEL	74	REDON guide needle	447	retractor TESSIER	440
plaster saw oscillating	73	REICHERT epiglottis retractor	297	retractor US-ARMY	187
PLESTER knife	411	REILL bone holding forceps	257	retractor VOLKMAN	176,177
PLESTER retractor	228	REINER ear syringe	407	retractor VOLKMAN	185
PLESTER suction	17,281	REINER plaster cast	74	retractor WEITLANER	229
POLITZER air bag	404	resection knife.	12	retractor ZENKER	183
POLITZER ear knife.	405	retractor.	176-192	REVERDIN needle	96
POLITZER paracentesis needle	405	retractor abdominal ROCHARD	236	REYNOLDS operating scissors.	58
polyrus spreader BENSON	132	retractor ADSON	226,227	rib contractor BAILEY	310
POOLE suction	17	retractor ADSON-BABY	226	rib contractor BAILEY-BABY	310
post mortem knife.	11	retractor ALM	229	rib contractor BAILEY-GIBBON	310
post mortem needle	263	retractor ANDERSON-ADSON	226	rib shears.	310
post mortem set	75	retractor BECKMANN	227	rib shears BETHUNE	311
POTTS atrauma forceps	150,152	retractor BECKMANN-EATON	227	rib shears BRUNNER	311
POTTS-SMITH dressing forceps.	44	retractor BRUNNER	180-187	rib shears CORYLLOS	311
POTTS-SMITH tissue forceps.	45	retractor CASPAR	231	rib shears GIERTZ-STILLE	311
POTTS-SMITH vascular scissors	63	retractor COLLIN	232	rib shears GLUCK	311
POZZI tenaculum forceps SCHROEDER.	747	retractor COOLEY	182	rib shears SAUERBRUCH	311
PRATT anal retractor.	329	retractor CORYLLOS.	189	rib shears SAUERBRUCH-FREY	311
PRATT fistula probe	332	retractor CRILE	185	rib shears STILLE	310
PRATT hemostatic forceps	102	retractor CUSHING	184,188	rib spreader COOLEY	315,317
PRATT tenaculum forceps	348	retractor DARLING	230	rib spreader COOLEY-NEONATAL	315
PRATT uterine dilator	342	retractor DAVIDSON	189	rib spreader DE BAKEY	316
PRICE-THOMAS bronchus forceps	128	retractor DAVIDSON (Scapula)	188	rib spreaser DE BOER.	316
PRINCE muscle forceps	397	retractor DEAVER	190,191	rib spreader FINOCCHIETTO	312-314
probe	15	retractor DINGMANN	432	rib spreader HAIGHT	317
probe DOYEN.	15	retractor DOYEN	187	rib spreader MORSE	312
probe NELATION.	15	retractor FARABEUF	186	rib spreader MORSE-FAVALORO	312
proctoscope CHELSEA-EATON	332	retractor FINSEN	229	rib spreader RIENHOFF-	
proctoscope FANSLER	331	retractor FRITSCH.	187	FINOCCHIETTO	316
proctoscope KELLY	332	retractor GELPI	232	rib spreader TUFFIER	317
prostate forceps MILLIN	323	retractor GIL-VERNET.	184	RIBBON intestinal spatula.	190
prostate hook YOUNG	324	retractor GOELET	185	RICARD abdominal retractor	238
prostatic forceps MILLIN.	324	retractor GREEN	178	RICHARDSON retractor	186,190
prostatic forceps YOUNG	324	retractor HARRINGTON	191	RICHARDSON-EASTMAN retractor	186
punch CITELLI.	419	retractor HEANEY	177	RIGBY retractor	232
punch cutaneous KEYES	368	retractor HENLEY	228	ring knife BARNHILL	429
punch FERRIS-SMITH-KERRISON.	293,294	retractor HOESEL	180	ring knife BECKMANN	429
punch HAJEK-KOFLER.	417	retractor HOFER	436	ring knife LAFORCE	429
punch HOLTH	396	retractor ISRAEL	188	ring knife ST-CLAIR-THOMSON	429
punch KERRISON	419	retractor JANSEN	229	RING tongue depressor	435
punch OSTROEM	417	retractor KELLY.	190,192	RITTER-HALLE irrigation cannula.	422
PUTTI rasp	217	retractor OBWEGESER	442,443	ROBB spatula	167
		retractor KOCHER.	178,186	ROBERTS hemostatic forceps	108
		retractor KOCHER.	187,192	ROCHESTER-CARMALT hemostatic	
		retractor KOERTE	188	forceps	105
		retractor LAHEY	178	ROCHESTER-OCHSNER hemostatic	
		retractor LITTLE	178	forceps	105
		retractor LOVE.	436	ROGER septum elevator.	423
		retractor MATHIEU	186	ROGERS hysterectomy forceps	115
		retractor MEYERDING.	179,191	ROGGE sterilizing forceps	369
		retractor MEYERDING.	233	ROLLET extraction hook.	393
		retractor MIKULICZ.	192	ROSEN knife	411-413
		retractor MOLLISON	230	ROSEN needle	411-413
		retractor OBWEGESER	440-443	ROSEN suction	411-413
		retractor OLLIER	187	ROSEN-KOENIG mouth gag.	435
		retractor PARKER	185,186	ROUX retractor	186
		retractor PERCY	194	ROUX-BABY retractor.	185
		retractor PLESTER	228	ROUX-MINI retractor.	185
		retractor RAGNELL	185	ROWE disimpaction forceps.	431
		retractor RAMUS.	442	RUBIN septum forceps	418
		retractor RICHARDSON	186,19	RUMEL hemostatic forceps	108
		retractor RICHARDSON-EASTMAN	186	RUMEL-BELMONT tourniquet	165
		retractor RIGBY.	232	RUSKIN bone rongeur	249
		retractor ROCHARD	236	RYDEL-SEIFERT tuning fork.	402
		retractor ROUX	186	RYDER needle holder	88
		retractor ROUX-BABY.	185	RUDD haemorrhoidal ligator.	308
		retractor ROUX-MINI.	185		
		retractor SAUERBRUCH.	189		
		retractor SENN-GREEN	178		
		retractor SENN-MILLER	178		

Q				S	
QUIRE foreign body lever	406			SAALFELD comedone extractor.	368

R					
RADOLF naile xtracting forceps	370				
RAGNELL retractor	185				
RALK bone drill	224				
RAMPLEY sponge holding forceps	119				
RAMUS retractor.	442				
RANDALL biopsy curettes	344				
RANDALL gall stone forceps	122				
RANEY brain clip.	274				
RANEY clip-applying forceps	274				
rasp	217				
rasp PUTTI	217				
razor blades.	41				
razor knife	41				
RECAMIER uterine curettes	358				
rectal biopsy forceps TURREL	304				
rectal biopsy forceps YEOMAN	304				
rectal biopsy specimen forceps WESTON	304				
304					
rectal biopsy forceps YEOMAN	296				

SACHS dura dissector	275	septum elevator McKENTY.	421	SPENCER-WELLS hemostatic forceps .	103	
SACHS nerve hook	261	septum forceps BRUENINGS.	416	spinal hook TAYLOR.	260	
SAENGER abortion forceps	137,349	septum forceps HEYMANN	416	SPINAL spoon.	288	
safety pins BUNT	369	septum forceps KNIGHT.	416	splinter forceps	47-48	
safety pins MAYO	369	septum forceps LUC.	416	splinter forceps ARCHER	47	
salpingograph SCHULTZE	345	septum forceps MIDDLETON-JANSEN .	419	splinter forceps CARMALT	48	
SAROT hemostatic forceps.	109	septum forceps RUBIN	418	splinter forceps FEILCHENFELD	44	
SATINSKY atrauma forceps	129	septum knife FREER	423	splinter forceps HUNTER	47	
SATINSKY hemostatic forceps.	129	septum scissors KILLIAN	425	splinter forceps PEET	47	
SATINSKY vascular scissors	62	septum straightening forceps ASCH . .	420	splinter forceps STIEGLITZ.	47	
SATTERLEE amputation saw	194	septum straightening forceps WALSHAM	420	splinter forceps VIRTUS	47	
SAUERBRUCH bone rongeur.	248	420	septum straightening curette COAKLEY	428	splinter forceps VIRTUS (RALK)	48
SAUERBRUCH retractor.	189	septum swivel knife BALLENGER.	423	sponge holding forceps FOERSTER 119-120		
SAUERBRUCH rib shears.	311	SEXTON ear knife	404	sponge holding forceps RAMPLEY	119	
SAUERBRUCH waste forceps	369	SHEA micro ear scissors	408	spoon BRUNS.	287-290	
SAUERBRUCH-FREY rib shears	311	SIEBENMANN irrigation cannula	422	spoon DAUBENSPECK.	286	
saw OLIVECRONA	194	SIEGLE ear specula	404	spoon HALLE	288	
SAWTELL tonsil forceps	437	sigmoid anastomosis forceps HAYES . .	133	spoon JACOBSON	287	
SAYRE elevator.	269	SILVER septum chissel.	425	spoon JANSEN	287	
SCAGLIETTI bone rongeur	248	SIMON retractor	192	spoon MARTINI.	289	
scalpel blade	37-38	SIMON uterine spoon	290	spoon HALLE	288	
scalpel handle	37-38	SIMPLEX tubing forceps.	341	spoon SCOVILLE	288	
scalpels sterile.	37-39	SIMPSON obstetrical forceps.	363	spoon SPINAL.	288	
SCHAEDEL towel forceps.	127	SIMPSON-BRAUN obstetrical forceps. .	363	spoon SCHEDE.	290	
SCHAMBERG comedone extractor	368	SIMPSON-LUIKART obstetrical forceps. 363		spoon SPRATT	289	
SCHAEDEL towel forceps.	127	SIMS anal retractor	328	spoon VOLKMANN	289	
SCHAMBERG comedone extractor	368	SIMS gynecological scissors	60	spoon WILLIGER.	286,289	
SCHAEDEL towel forceps.	127	SIMS specula	339	SPURLING laminectomy forceps	292	
SCHAMBERG comedone extractor	368	SIMS uterine curettes	358	ST.CLAIR-THOMSON ring knife.	429	
SCHAEDEL towel forceps.	127	SIMS uterine Depressor	350	ST. MARKS pelvis hook	181	
SCHAMBERG comedone extractor	368	SIMS uterine dilators.	343	STACKE ear sound	15	
SCHAEDEL towel forceps.	127	SIMS uterine sound.	341	starbismus hook GRAEFE.	393	
SCHAMBERG comedone extractor	368	SIMS vaginal specula	339	starbismus hook JAMESON	393	
SCHAEDEL towel forceps.	127	SINUS dressing forceps LISTER.	120	starbismus knife	390-392	
SCHAMBERG comedone extractor	368	SKENE tenaculum forceps	127,347	starbismus knife DEUTSCHMANN	390	
SCHAEDEL towel forceps.	127	skin hooks	176	starbismus knife GRAEFE.	390	
SCHAMBERG comedone extractor	368	skin hooks COTTLE	428	starbismus scoop DAVIEL	395	
SCHAEDEL towel forceps.	127	skin hooks COTTLE-NEIVERT	428	starbismus scoop GRAEFE.	395	
SCHAMBERG comedone extractor	368	skin hooks FOMON.	428	starbismus scoop KNAPP.	395	
SCHAEDEL towel forceps.	127	skin hooks FREER.	176	STEINMANN bone nail	267,268	
SCHAMBERG comedone extractor	368	skin hooks GILLIES.	428	sterilizing container	374-378	
SCHAEDEL towel forceps.	127	skin hooks GUTHRIE.	176	sterilizing forceps	44	
SCHAMBERG comedone extractor	368	skin hooks JOSEPH	176	sterilizing forceps CHEATLE	369	
SCHAEDEL towel forceps.	127	skin hooks KILNER	368	sterilizing forceps DAVIS.	44,369	
SCHAMBERG comedone extractor	368	skin knife ELSCHNIG	390	sterilizing forceps ROGGE	369	
SCHAEDEL towel forceps.	127	skin scissors CASTROVIEJO	401	sterilizing forceps UNIVERSAL.	369	
SCHAMBERG comedone extractor	368	skull breaker	217	sterilizing tray	378	
SCHAEDEL towel forceps.	127	SLUDER-BALLENGER tonsillotome	439	STERNBERG cheek retractor.	430	
SCHAMBERG comedone extractor	368	SMELLIE hook.	365	Sternum chissel LEBSCH.	217	
SCHAEDEL towel forceps.	127	SMELLIE perforators.	366	stethoscope PINARD	14	
SCHAMBERG comedone extractor	368	SMILLIE bone lever.	260	stethoscope PINARD wood	14	
SCHAEDEL towel forceps.	127	SMILLIE meniskus knife	271	STEVENS iris forceps	396	
SCHAMBERG comedone extractor	368	SMITH eye specula	389	STEVENS ophtal. Scissors	59	
SCHAEDEL towel forceps.	127	SMITH-BUIE anal spreader	329	STEVENSON eye specula.	389	
SCHAMBERG comedone extractor	368	SMITHWICK applying forceps	273	STIEGLITZ splinter forceps.	47	
SCHAEDEL towel forceps.	127	SMITHWICK nerve hook.	261	STILLE chissel.	201	
SCHAMBERG comedone extractor	368	SNELLEN entropium forceps	399	STILLE gouges	201	
SCHAEDEL towel forceps.	127	SMITH-PETERSEN chissel	198	STILLE hemostatic forceps.	113	
SCHAMBERG comedone extractor	368	SNELLEN lens loop.	395	STILLE plaster scissors.	74	
SCHAEDEL towel forceps.	127	SOMER uterine elevating forceps. . . .	137,349	STILLE rib shears	310	
SCHAMBERG comedone extractor	368	sound.	15	STILLE-LUER bone rongeur	249	
SCHAEDEL towel forceps.	127	sound FISH	15	STILLE-RUSKIN bone rongeur	249	
SCHAMBERG comedone extractor	368	sound JACOBSON	278	STILLE-SHERMAN bone drill	204,218	
SCHAEDEL towel forceps.	127	spatula.	167	STOCKMANN penis seizing forceps. . . .	325	
SCHAMBERG comedone extractor	368	spatula ROBB	167	stomach forceps LANE	135	
SCHAEDEL towel forceps.	127	specula FRIEDMANN	339	STONE anastomosis clamp	133	
SCHAMBERG comedone extractor	368	specula KALLMORGEN	339	STONE-WATT intestinal forceps.	133	
SCHAEDEL towel forceps.	127	specula KIRSTELLER	339	STRAUSS penis forceps.	325	
SCHAMBERG comedone extractor	368	specula O'SULLIVAN-O'CONNOR	336	STRUEMPPEL foreign body forceps. . . .	407	
SCHAEDEL towel forceps.	127	specula SIMS	328,339	STRULLY neurosurgery scissors	62	
SCHAMBERG comedone extractor	368	SPENCER ligature scissors.	58	STRUYCKEN nasal forceps	418	
SCHAEDEL towel forceps.	127			SUBRAMANIAN atrauma forceps.	162	
SCHAMBERG comedone extractor	368			suction cannula BABY YANKAUER	17	

suction cannula FRAZIER	17
suction cannula YANKAUER	17
suction tube COOLEY	17
suction tube HOUSE	281
suction tube PLESTER	17
suction tube ROSEN	281
suction tube YASARGIL	280
suction tube ZÖLLNER	280
suturing clip forceps CHILDE	97
suturing clip forceps COLLIN	97
suturing clip forceps HEGENBARTH	97
suturing clip forceps MICHEL	97
suturing clip forceps RICHTER-HEATH	97
suturing clip forceps WACHENFELDT	97
suturing clip MICHEL	97
suturing needles	96
SWEET applying forceps	273

T

TABB knife	411
TARNIER cranioclast	364
TARNIER obstetrical forceps	364
TAYLOR bone lever	260
TAYLOR percussions hammer	15
TAYLOR tissue forceps	44
TEALE tenaculum forceps	127
tenaculum forceps BARRET	347
tenaculum forceps BRAUN	347
tenaculum forceps DUPLAY	127
tenaculum forceps HULKA	127,347
tenaculum forceps IOWA	348
tenaculum forceps JACOBS	348
tenaculum forceps JARCHO	347
tenaculum forceps MUSEUX	348
tenaculum forceps PRATT	348
tenaculum forceps SCHROEDER	127
tenaculum forceps SCHROEDER (POZZI)	347
tenaculum forceps SKENE	127
tenaculum forceps STAUDE-MOORE	347
tenaculum forceps TEALE	127
tendon seizing instrument BRAND	272
tendon seizing instrument BUNELL	272
tendon seizing instrument CAROLL	272
tendon seizing instrument KLEINERT-KUTZ	272
TESSIER retractor	440
THOMAS uterine curettes	360
THOMAS -GAYLOR biopsy forceps	296
THOMS-ALLIS bowel and tissue grasping forceps	121
thorax retractor MERCEDES	319
THOREK scissors	62
THUDICHUM nasal specula	415
thyroid gland retractor SCHOENBORN	173
TIECK-HALLE nasal specula	414
tip BARACANI	302
tip BRUENINGS	302
tip CORDES	302
tip FLATAU	302
tip FRAENKEL	302
tip KRAUSE	302
tip LANGE	302
tip SCHEINMANN	302
tip SCHUMACHER	302
tip SEIFERT	302
TISCHLER biopsy forceps	1,351
tissue forceps	45
tissue forceps ADSON	45

tissue forceps ADSON-BROWN	45,50
tissue forceps BONNEY	45,85
tissue forceps BROWN	45
tissue forceps CUSHING	84,85
tissue forceps DURANTE	45
tissue forceps DUVAL	46
tissue forceps FERRIS SMITH	46
tissue forceps GERALD	45
tissue forceps GILLIES	45,85
tissue forceps LANE	46
tissue forceps LERCHE	46
tissue forceps OEHLER	84
tissue forceps POTTS-SMITH	45,84
tissue forceps russian model	45
tissue forceps SEMKEN	45,85
tissue forceps TAYLOR	46,84
tissue forceps USA	46
tissue forceps WILLET MARTEL	102
TOBOLD cotton applicator	412
TOBOLD tongue depressor	430
TOENNIS dura dissector	275
TOENNIS hemostatic forceps	110
TOENNIS-ADSON dissecting scissors	62
TOHOKU towel forceps	127
tongue depressor	430
tongue depressor ANDREW	430
tongue depressor BRUENINGS	430
tongue depressor BUCHWALD	430
tongue depressor DINGMANN	432
tongue depressor FRENZEL	430
tongue depressor HARTMANN	430
tongue depressor KILNER-DOUGHTY	433
tongue depressor MAYO	432
tongue depressor MORTITZ-SCHMIDT	435
tongue depressor TOBOLD	430
tongue forceps COLLIN	435
tongue forceps YOUNG	435
tonometer SCHIOETZ	388
tonsil compressor CORWIN	439
tonsil dissector HURD	436
tonsil elevator HENKE	436
tonsil elevator LUNIATSCHEK	436
tonsil forceps BALLENGER	437
tonsil forceps BLOHMKE	437
tonsil forceps COLVER	437
tonsil forceps NEGUS	437
tonsil forceps SAWTELL	437
tonsil forceps SCHNIDT	437
tonsil forceps TYDING	438
tonsil forceps WHITE	437
tonsil knife ABRAHAM	439
tonsil knife BRUENINGS	439
tonsil knife CARPENTER	436
tonsil knife FISHER	439
tonsil needle	439
tonsil needle DUPUY-WEISS	439
tonsil scissors BOETTCHER	56
tonsil scissors DEAN	63
tonsil scissors GOOD	56
tonsil snare BRÜNING	420
tonsil snare EVES	438
tonsil syringe	438
tonsillotome SLUDER-BALLENGER	439
tonsillotome TYDING	438
torniquet RUMEL-BELMONT	165
towel forceps	127
towel forceps BACKHAUS	127
towel forceps BACKHAUS-CLIP	127
towel forceps BALL AND SOCKET	127
towel forceps JONES	127
towel forceps JONES-CLIP	127
towel forceps LORNA	127

towel forceps PEERS	127
towel forceps SCHAEDEL	127
towel forceps TOHOKU	127
TOYNBEE ear specula	404
tracheal dilators LABORD	170
tracheal dilators TROUSSEAU	170
tracheal hook BOSE	170
tracheal hook ITERSON	170
tracheal hook JACKSON	170
tracheal hook NEWS	171
tracheal hook WAGENER-MOSHER	171
tracheal trocar UCKERMANN	170
tracheal tube CHEVALIER-JACKSON	171
tracheal tube LUER	171
tracheotomy set	172
trachoma forceps KNAPP-LUER	397
tray-kidney shape	375-377
tray perforated	375-377
TRELAT vaginal specula	336
trephine punch KEYES	368
trocar COAKLEY	284
trocar DOUGLAS	284
trocar LICHTWITZ	284
trocar NELSON	283
trocar OCHSNER	283
trocar PIERCE	284
trocar UNIVERSAL	284
TROELTSCH ear forceps	47
TROELTSCH WILDE ear forceps	47
TROEMNER percussions hammer	15
TROUSSEAU tracheal dilators	170
TROUTMAN blade breakers	41
TUBBS aortic dilators	165
tubing forceps	116-117
tubing forceps BÜLOW-GUNAR-HEY	116
tubing forceps HOFFMANN	341
tubing forceps SIMPLEX	341
TUEBINGEN iris forceps	400
TUEBINGEN ligature forceps	400
TUFFIER hemostatic forceps	102
TUFFIER rib spreader	317
tumor forceps YASARGIL	52
tumor grasping forceps LANDOLT	295
tuning fork for neurology	402
tuning fork HARTMANN	402
tuning fork LUKAE	402
tuning fork alu	403
TURREL rectal biopsy forceps	304
TYDING tonsil forceps	438

U

UCKERMANN trocar	170
ULRICH bone holding forceps	257
ULRICH dressing forceps	119
umbilical forceps COLLIN	365
umbilical forceps KANE	365
umbilical scissor BUSCH	61
umbilical scissor SCHUMACHER	61
umbilical scissors USA	61
UNIVERSAL bandage scissors	72
UNIVERSAL wire scissors	58
UNIVERSAL sterilizing forceps	369
UNIVERSAL trocar	284
UNNA comedone extractor	368
USA dressing forceps	44
USA tissue forceps	46
USA umbilical scissors	61
US-ARMY retractor	187
uterine curettes BLAKE	346

uterine currettes BUMM	358
uterine currettes RECAMIER	358
uterine currettes SIMS	358
uterine currettes THOMAS	360
uterine depressor BRAUN	350
uterine depressor SIMS	350
uterine dilators GOODELL	343
uterine dilators HANK	342
uterine dilators HEGAR	340
uterine dilators PRATT	342
uterine dilators SIMS	343
uterine dilators WYLIE	343
uterine ear polypus forceps DOYEN	137
uterine ear polypus forceps KELLY	137
uterine ear polypus forceps NOTO	349
uterine grasping forceps COLLIN	137,349
uterine grasping forceps DARTIGUES	137,349
uterine grasping forceps SOMER	137,349
uterine hemostatic forceps GREEN-ARMYTAGE	137,349
uterine sound COLLIN	350
uterine sound MARTIN	341
uterine sound SIMS	341
uterine spoon SIMON	290

V

vaginal specula AUWARD	339
vaginal specula BREISKY	340
vaginal specula COLLIN	335,336
vaginal specula CUSCO	335
vaginal specula DOYEN	340
vaginal specula GRAVE	335
vaginal specula KALLMORGEN	339
vaginal specula KRISTELLER	339
vaginal specula LANDAU	340
vaginal specula MATZENAUER	338
vaginal specula PEDERSON	335
vaginal specula SCHERBAK	337
vaginal specula SEMM	335
vaginal specula SIMS	339
vaginal specula TRELAT	336
vaginal specula VU-MOORE	334
VAN BUREN bone holding forceps	255
VAN BUREN dilating bougies	322
VAN DOREN biopsy forceps	298
VANNAS eye scissors	401
vascular scissors DEBAKEY	63,64
vascular scissors DIETRICH	64
vascular scissors FAVALORO	64
vascular scissors KLINKENBERG-LOTH	62
vascular scissors parametrium	64
vascular scissors POTTS-SMITH	63
vascular scissors SATINSKY	62
vasectomy forceps	330
vein probe set NABATOFF	232
VERBRUGGE bone holding forceps	255
vessel clip	450-464
vessel clip aneurism YASARGIL	450
vessel clip MEHDORN	465
vessel clip MUELLER	469
vessel dilators DE BAKEY	166
VICKERS micro forceps	51
VIENNA ligature conductor	100
VIENNA nasal specula	414
VIRCHOW autopsy knife	11
VIRTUS RALK splinter forceps	48
VOLKMANN retractor	176-177
VOLKMANN retractor	185
VOLKMANN spoon	289

VOLTOLINI nasal specula	415
VU-MOORE vaginal specula	334

W

WAGENER hook	406
WAGENER-MOSHER tracheal cannula	171
WAGNER gum scissors	60
WALDMANN episiotomy scissors	60
WALLICH abortion spoon	366
WALSHAM septum straightening forceps	420
WALTON comedone extractor	368
WANGENSTEEN forceps	85
WARTENBERG measuring instrument	14
waste forceps SAUERBRUCH	369
water jet pistol	380
WATSON-CHEYNE elevator	269
WATSON-WILLIAMS irrigation cannula	422
WEBER aortic clamps	153
WEBER lens loop	395
WECKER eye scissors	401
WECKER iris spatula	393
WEEK eye specula	389
WEIL-BLAKESLEY nasal forceps	416
WEITLANER retractor	229
WERTHEIM hysterectomy forceps	126
WEST nasal chissel	425
WESTCOTT eye scissors	61
WESTON rectal snare	304
WHEELER cyclodialysis spatula	394
WHITE tonsil forceps	437
WIENER nasal rasp	426
WIGMORE plaster cast	74
WILDE ear snare	406,420
WILDE TROELTSCH ear forceps	406
WILDE lacrymal dilators	394
WILDE lens loop	395
WILLET MARTEL grasping forceps	102
WILLIAMS bowel and tissue grasping forc	131
WILLIAMS eye specula	389
WILLIGER elevator	206
WILLIGER hammer	210
WILLIGER spoon	286,289
WINTER abortion forceps	365
wire forceps CORWIN-HEGAR	223
wire forceps MAYO-HEBERISSER	223
wire scissors UNIVERSAL	59
wire seizing forceps	222
WITTNER biopsy forceps	307
WOLFF plaster cast forceps	74
WULLSTEIN foreign body forceps	407
WULLSTEIN micro-cannula	405
WYLIE uterine dilators	343

Y

YANKAUER suction tube	17
YASARGIL aneurysm clips	448-470
YASARGIL galea hook	270
YASARGIL suction hook	280
YASARGIL tumor forceps	52
YEOMAN rectal biopsy forceps	296,304
YOUNG forceps	324
YOUNG prostata retractor	324
YOUNG tongue forceps	435

Z

ZAUFAL-JANSEN bone rongeur	249
ZENKER homostatic forceps	109
ZENKER retractor	183
ZIEGLER eye specula	389
ZIEGLER head mirror	16
ZIEGLER iris knife	391
ZIELKE chissel	200
ZÖLLNER suction	280

A

abaja-lenguas	430-435
abaja-lenguas ANDREW	430
abaja-lenguas BRUENINGS	430
abaja-lenguas BUCHWALD	430
abaja-lenguas DAVIS-BOYLE	434
abaja-lenguas DINGMANN	432
abaja-lenguas FRENZEL	430
abaja-lenguas HARTMANN	430
abaja-lenguas KILNER-DOUGHTY	433
abaja-lenguas KROENIG	432
abaja-lenguas MAYO	432
abaja-lenguas MORTIZ-SCHMIDT	435
abaja-lenguas RING	435
abaja-lenguas TOBOLD	430
ABRAHAM bisturios p. amígdalas	439
abre-bocas DENHART	435
abre-bocas DOYEN-JANSEN	435
abre-bocas HEISTER	435
abre-bocas JENNINGS	434
abre-bocas MAUNDER	432
abre-bocas MC IVOR	433
abre-bocas ROSER-KOENIG	435
ADLERDYCE elevadores	269
ADSON BROWN pinza p. microcirugía	45
ADSON elevadores	269
ADSON ganchos p. dura-madre	261
ADSON pinza	44,45
ADSON pinza de disección	44,45
ADSON pinza hemostática	106
ADSON pinza p. hipofisis	277
ADSON separadores	226,227
ADSON tubos de aspiración	279
ADSON-BABY pinza hemostática	106
ADSON-BABY separadores	226
agrafes MICHEL	97
aguja de guía REDON	447
aguja p. ligaduras COOPER	100
aguja p. ligaduras DESCHAMPS	99
aguja p. ligaduras KRONECKER	100
aguja p. ligaduras REVERDIN	96
aguja p. ligaduras YOUNG-BOOMERANG	96
aguja p. paracentesis LUCAE	405
aguja p. paracentesis POLITZER	405
aguja p. ligaduras NELSON	100
agujas BARBARA	413
agujas OBWEGESER	441,442
agujas p. amígdalas NAGER	439
agujas p. amígdalas CLAUS	439
agujas p. amígdalas CLAUS-EICKEN	439
agujas p. amígdalas DUPUY-WEISS	439
agujas p. autopsia	263
agujas p. discisión BOWMAN	391
agujas ROSEN	413
ALAN-PARKS separadores suelto	328
ALEXANDER cinceles	196
ALEXANDER periostótomos	206
alicates p. cortar alambre	222,215
alicates planos	214-216
ALLEN pinza p. apéndice	132
ALLIS pinza p. coger intestino	121
ALLIS-BABY pinza p. coger intestino	121
ALLISON espátulas pulmonares	310
ALM separadores	229
alu separadores FINOCCHIETTO	313,314
amigdalótomos SLUDER-BALLENGER	439
amigdalótomos TYDING	438
amniótomo BEACHAM	350
ANDERSON-ADSON separadores	226
ANDREW abaja-lenguas	430

anillos sierras p. abrir	370
anoscopio HIRSCHMANN	332
anoscopio IVES-FANSLER	331
aproximadores BAILEY-BABY	310
aproximadores BAILEY-GIBBON	310
aproximadores BIEMER	469
aproximadores BIEMER-MUELLER	466
aproximadores MUELLER	467
aproximadores p. cost. BAILEY	310
ARCHER pinza de disección	47
ARRUGA blefarostatos	388
ARRUGA ganchos p. extracción	393
ARRUGA pinza capsulares	399
ARRUGA porta-agujas	90
asas BILLEAU	405
asas SNELLEN	395
asas WEBER	395
ASCH pinza p. enderezar el tabique	420
atrauma clamps bulldog DE BAKEY	140
atrauma clamps bulldog GLOVER	141
atrauma pinza clamp DE BAKEY	133
ATRAUMA pinza hemostática	144,145
AUFRICT retractores nasales	428
auriculares tijera micro GREVEN	407
AUVARD espéculos vaginales	339
AYER pinza dechalazón	399

B

BABCOCK pinza p. coger tejidos	121
BABINSKY martillo de percusión	15
baby separadores double ROUX	186
BABY-GOSSET separadores abdominales	239
BABY-TISCHLER pinza p. biopsia	351
BABY-YANKAUER tubo de aspiración	17
BACKHAUS pinza de campos	127
BAILEY aproximadores p. cost.	310
BAINBRIDGE pinza hemostática	108
BAKES dilatadores	122
BALFOUR separadorabdominales	235,240
BALLENGER bisturios	423
BALLENGER pinza p.coge	438
BARANY ensordecedor	404
BARBARA agujas	413
BARBARA ganchos	413
BARNHILL cuchillos adenoides	429
BARON tubos de aspiración	279
BARR especulos rectales	329
BARRAQUER blefarostatos	388
BARRAQUER pinza o. iris	398
BARRAQUER porta-agujas	90
BARRAQUER tijera p. oculares	401
BARRET pinza p. coger el cuello del útero	347
BARTON forceps obstétricos	364
BARTON tiradores	364
basos	375
basos graduados	377
BAUMGARTNER portq-agujas	89,94
BE BAKEY porta-agujas	88
BEACHAM amniótomo	350
BECKMANN cuchillos adenoides	429
BECKMANN separadores	227
BECKMANN-EATON separadores	227
BEEBEE tijera p. coronas	59
BEER pinza deiplatorias	400
BEESON separadores de yesos	132
BENNETT elevadores p. huesos	259
BENSON separador p. piloro	132
BERMANN martillo	211

BERMANN tijera p. vendajes	72
BERRY wire twisting forceps	223
BETHUNE costotomos	311
BEYER pinza-gubias	246,249
BIEMER aproximadores	469
BIEMER clips p. vasos	464
BIEMER-MUELLER aproximadores	469
BILLEAU asas	405
BISHOP-HARMAN pinza p. iris	398
bisturios BALLENGER	423
bisturios de mango metalico	37-40
bisturios KOOS	278
bisturios nasales CONVERSE	423
bisturios nasales FREER	423
bisturios nasales JOSEPH	423
bisturios p. amígdalas ABRAHAM	439
bisturios p. amígdalas BRUENINGS	439
bisturios p. amígdalas CARPENTER	436
bisturios p. amígdalas FISHER	439
bisturios de uso único	37-39
BLAKE curetas uterinas	346
blefarostatos ARRUGA	388
blefarostatos BARRAQUER	388
blefarostatos BOWMAN	388
blefarostatos CASTROVIEJO	389
blefarostatos CLARK	388
blefarostatos CRITCHETT	388
blefarostatos GRAEFE	388
blefarostatos LANCASTER	389
blefarostatos LISTER-BURCH	389
blefarostatos MELLINGER	388
blefarostatos MELLINGER-AXENFELD	388
blefarostatos MUELLER	389
blefarostatos MURDOCK	389
blefarostatos PARK	389
blefarostatos SMITH	389
blefarostatos STEVENSON	389
blefarostatos WEEK	389
blefarostatos WILLIAMS	389
blefarostatos ZIEGLER	389
BLOHMKE pinza p. coger	438
BLOUNT elevadores p. huesos	260
BLUMENTHAL pinza-gubias	245
BOEHLER estribos p. extensión	205
BOEHLER pinza cont. p. huesos	252
BOEHLER pinza-gubias	247
BOERMA forceps obstétricos	364
BOETTCHEER tijera p. amígdalas	56
BOIES periostótomos	206
BONNEY pinza de disección	45
BOSE ganchos p. traqueotomía	170
BOWMAN blefarostatos	388
BOWMAN estiletes lacrimal	394
BOZEMANN pinza p. tapones	119
BRAND enucleadores	272
BRAUN cranioclasto	366
BRAUN depresores uterinos	350
BRAUN gancho p. decapitación	366
BRAUN pinza p. coger el cuello del útero	347
BRAUN STADLER tijera	72
BREISKY espéculos vaginales	340
BROWN pinza de disección	45
BRUENINGS abajo-lenguas	430
BRUENINGS especulos auriculares	404
BRUNETTI cinceles	263
BRUNNER costotomos	311
BRUNNER pinza clamp intestin	131
BRUNNER separadores	180-187
BRUNNER sonda conductora	100
BRUNS cucharillas cortantes	290
BRUNS cucharillas cortantes	287

BRUNS tijera p. vendajes	72	cinceles PARTSCH	196	costotomos CORYLLOS	311
BRYANT pinza p. esponjas	120	cinceles SMITH-PETERSEN	198	costotomos GIERTZ-STILLE	311
BUCHWALD abaja-lenguas	430	cinceles STILLE	201	costotomos GLUCK	310
BUCK curetas	405	CINELLI cinceles p. plastica	424	costotomos SAUERBRUCH	311
BUCK martillo de percusión	15	circumflex tijera	66	costotomos SAUERBRUCH-FREY	311
BUIE cánula de aspiración	304	cistotomos GRAEFE	391,393	costotomos STILLE	311
bulldog clamps	140	CITELLI pinza osteotomos	419	COTTLE cinceles p. plastica	424
bulldog clamps DIEFFENBACH	48	cizallas p. vendajes STILLE	74	COTTLE elevadores	421
bulldog clamps JOHN-HOPKINS	48	clamp GREEN-ARMYTAGE	137	COTTLE elevadores p. tabique	421
BUMM curetas uterinas	358	clamp pinza estomacales LANE	135	COTTLE especulos nasales	415
BUNELL perforadores óseo manuales	224	clamp pinza intest. PAYR-BABY	130	COTTLE gancho nasales	428
BUNNELL enucleadores detende	272	clamp umbilical COLLIN	365	COTTLE gancho nasales	428
BUNT cadres de esterilización	369	clamp umbilical KANE	365	COTTLE martillo	211,213
BURKE pinza p. biopsia	305	clamps BULLDOG	48	COTTLE tijera nasal	63
BUSCH tjera umbilicales	61	clamps bulldog DIEFFENBACH	48	COTTLE-NEIVERT gancho	428
		clamps bulldog JOHN-HOPKINS	48	CRAFOORD pinza hemostática	110
		clamps pinza hemor. MC GIVNEY	308	CRAFOORD tijera p. lobectomia	62
		CLAR lamp. Frontal	16	cranioclasto BRAUN	366
		CLARK blefarostatos	388	cranioclasto TARNIER	364
		CLAUS agujas p. amigdalas	439	CREDO	371
		CLAUS-EICKEN agulas p. amigdalas	439	CREGO elevadores	269
		clavos p. huesos STEINMANN	267,268	CRILE pinza hemostáticas	104
		CLEVELAND pinza-gubias	244	CRILE porta-agujas	89
		clips p. aneurisma YASARGIL	450	CRILE RANKIN pinza hemostáticas	104
		clips p. vasos BIEMER	464	CRILE separadores	185
		clips p. vasos MUELLER	467	CRILE-WOOD porta-agujas	89,94
		clips vasculares	464	CRITCHETT blefarostatos	388
		clips vasculares MEHDORN	465	CRUTCHFIELD pinza de tracción craneal	274
		CLOWARD pinza p. laminectomia	299	cuchara	377
		CLOWARD separadores	230,282	cucharillas cortantes BRUNS	287,290
		COAKLEY curetas antrum	428	cucharillas cortantes DAUBENSPECK	286
		COAKLEY trócares	284	cucharillas cortantes JACOBSON	287
		COBB gubias	199	cucharillas cortantes JANSEN	287
		COLCLOUGH pinza p. laminectomia	294	cucharillas cortantes LEMPERS	290
		COLLIER pelvimetros	346	cucharillas cortantes MARTINI	289
		COLLIN clamp umbilical	365	cucharillas cortantes SCHEDE	290
		COLLIN dinamómetro	14	cucharillas cortantes SPRATT	289
		COLLIN espéculos vaginales	335,336	cucharillas cortantes VOLKMANN	289
		COLLIN histerómetros	341	cucharillas cortantes WILLIGER	286,289
		COLLIN martillo	210	cucharillas p. aborto CUZZI	365
		COLLIN pelvimetros	365	cucharillas p. aborto PESTALOZZA	365
		COLLIN pinza hemostática	102,435	cucharillas p. aborto SELLHEIM	366
		COLLIN pinza p. agrafes	97	cucharillas p. aborto WALLICH	366
		COLLIN pinza p. el útero	137,349	cucharillas p. catarata DAVIEL	395
		COLLIN pinza p. tapones	120	cucharillas p. catarata GRAEFE	395
		COLLIN pinza tira-lenguas	102,435	cucharillas p. catarata KNAPP	395
		COLLIN separadores abdominales	232	cucharillas p. coger cálculos bil.	122
		COLVER pinza p. coger	437	DESJRDINS	122
		compersores p. amigalas CORWIN	439	cucharillas p. coger cálculos bil.	124
		compresores uretrales STOCKMAN	325	FERGUSSON	124
		compresores uretrales STRAUSS	325	cucharillas p. coger cálculos bil.	124
		conductores DE MARTEL	134,270	LUER-KOERT	124
		conduct. Pinza KLEINERT-KUTZ	272	cucharillas p. coger cálculos bil. MAYO	125
		CONVERSE bisturios nasales	423	cuchillo p. amputación LANGENBECK	10,12
		COOLEY dilatadores de aorta	165	cuchillo p. amputación LISTON	10
		COOLEY pinza clamp atrauma	161	cuchillo p. organos	11
		COOLEY separadores	182,316	cuchillo o. resección LANGENBECK	10
		COOLEY separadores	317	cuchillo o. resección VIRCHOW	11
		COOLEY-NEONATAL separadores	315	cuchillos adenoides BARNHILL	429
		COOPER agujas p. ligaduras	100	cuchillos adenoides BECKMANN	429
		copas	377	cuchillos adenoides LA FORCE	429
		corneales legtras KUHN	391	cuchillos auriculares SEXTON	404
		corta-unas alicates	370	cuchillos auriculares POLITZER	405
		corta-unas alicates stainless	371	cuchillos lanceol. GRAEFE	391
		corta-unas alicates TURNBULL	371	cuchillos lanceol. JAEGER	392
		CORWIN compersoes p. amigdalas	439	cuchillos lanceol. WHEELER	390
		CORYLLOS costotomos	311	cuchillos lanceol. ZIEGLER	391
		CORYLLOS separadores thorax	189	cuchillos lanceol. CASTROVIEJO	392
		COS tijera auriculares micro	407	cuchillos MUCK	413
		costotomos	310,311	cuchillos p. amputación CATLIN	10
		costotomos BETHUNE	311	cuchillos p. catarata DEUTSCHMANN	390
		costotomos BRUNNER	311	cuchillos p. catarata GRAEFE	390
C					
cadres de esterilización BUNT	369				
cadres de esterilización MAYO	369				
cajas p. instrumentos	374				
canúla de aspiración BUIE	304				
canúla CHEVALIER-JACKSON	171				
canúla de inyección p. laringoscopios	33				
canúla de succión o. laringoscopios	33				
canúla KILLIAN	420,422				
canúla LICHTWITZ	284				
canúla RITTER-HALLE	422				
canúla SIEBENMANN	422				
canúla traqueales LUER	171				
canúla WATSON-WILLIAMS	422				
CARPENTER bisturios p. amigdalas	436				
CASPAR separadores	231				
CASTANEDA pinza clamp nacidos	163,164				
CASTROV.-MIICRO porta-agujas	88,95				
CASTROVIEJO porta-agujas	88,95				
CASTROVIEJO rompe-hoja	41				
cateteres HARTMANN	405				
CATLIN cuchillo p. amputación	10				
CHAPUT pinza hemostática	102				
CHARRIERE sierra p. amputación	194				
CHEATLE pinza p. esterilización	369				
CHELSEA-EATON proctoscopios	332				
CHERON pinza p. tapones	120				
CHEVALIER-JACKSON canúlas	171				
CHEVALIER-JACKSON pinza	297				
CHILDE pinza p. agrafes	97				
cierranudos KRAUSE	406				
cierranudos p. amigdalas EVES	438				
cierranudos WILDE	406				
cierranudos rectal WESTON	304				
cinceles	195-201				
cinceles ALEXANDER	196				
cinceles BRUNETTI	263				
cinceles COTTLE	424				
cinceles FOMON	424				
cinceles HAJEK	425				
cinceles HIBBS	197				
cinceles HOKE	197				
cinceles KILLIAN-CLAUS	425				
cinceles LAMBOTTE	195				
cinceles LEBSCHKE	217				
cinceles LEXER	195				
cinceles LEXER-MINI	195				
cinceles MINI-LAMBOTTE	199				
cinceles nasales FREER	423				
cinceles nasales WEST	425				
cinceles p. plastica CINELLI	424				
cinceles p. plastica COTTLE	421				
cinceles p. plastica FREER	425				
cinceles p. plastica SILVER	425				

cuchillos p. cornea ELSCHNIG	390
cuchillos p. discisión DEAN	391
cuchillos p. discisión KNAPP	391
cuchillos p. discisión ZIEGLER	391
cuchillos p. yesos ESMARCH	74
cuchillos p. yesos HOPKINS	74
cuchillos p. yesos REINER	74
cuchillos PLESTER	411
cuchillos ROSEN	411
cuchillos SCHUKNECHT	411
cuchillos ST. CLAIR-THOMSON	429
cuchillos TABB	411
CULLER espátulas	393
curetas antrum COAKLEY	428
curetas aspiradoras HEANY	350
curetas aspiradoras KEVORKIAN	298
curetas aspiradoras MÜNCHEN	350
curetas aspiradoras NOVAK	344
curetas aspiradoras RANDALL	344
curetas BUCK	405
curetas FAULKNER	428
curetas HOUSE	413
curetas p. chalazión MEYHOEFER	395
curetas p. lupus FOX	368
curetas p. lupus PIFFARD	368
curetas uterinas BLAKE	346
curetas uterinas BUMM	358
curetas uterinas RECAMIER	358
curetas uterinas SIMON	290
curetas uterinas SIMS	358
curetas uterinas THOMAS	360
CUSCO espéculos vaginales	335
CUSHING espátulas cerebr	279
CUSHING ganchos p. nervios	261
CUSHING pinza p. laminectomía	292
CUSHING separadores	184,188
cutáneos ganchos KILNER	368
cutáneos trpanos KEYES	368
CUZZI cucharillas p. aborto	365
CZERNY especulos rectales	328

D

DANDY ganchos p. nervios	261
DANDY pinza hemostática	107
DARLING separadores	230
DARTIGUES pinza p. el útero	137,349
DASTOOR erisifacos	396
DAUBENSPECK cucharillas cortantes	286
DAVIDSON separadores scapula	189
DAVIEL cucharillas p. catarata	395
DAVIS descoladores	275
DAVIS pinza p. esterilización	44,369
DAVIS-BOYLE abaja-lenguas	434
DAVIS-BOYLE abre-bocas solo	434
DE BAKEY dilataores vasculares	166
DE BAKEY pinza clamp atrauma	147
DE BAKEY separadores	316
DE BAKEY tijera	63,64
DE BAKEY-MOSQUITO pinza clamp atrauma	146
DE BOER separadores	316
DE MARTEL conductores	134,270
DEAN tijera p. amígdalas	63
DEAVER separadores	190-191
DEBAKEY pinza atraumaticas	143
dedales LANGENBECK	431
DEJERINE marillo de percusión	15
DEMEL agujas pasa-hilos	262
DEMEL tensor cierra-hilos	262
DENHART abre-bocas	435

DENIS-BROWN separadores abdominales	242
despresor p. epiglotis REICHERT	297
despresores uterinos BRAUN	350
despresores uterinos SIMS	350
DERF porta-agujas	89,94
dermatomo HUMBY	12
dermatomo SCHINK	12
DERRA pinza clamp atrauma	148
DESCHAMPS agujas p. ligaduras	99
descoladores	275,276
descoladores DAVIS	275
descoladores FRAZIER	276
descoladores HOEN	276
descoladores HORSLEY	276
descoladores MILLIGAN	275
descoladores OLIVECRONA	275
descoladores PENFIELD	276
descoladores SACHS	275
descoladores TOENNIS	275
DESJARDINS exploradores	125
DESJARDINS pinza hemostática	112
DESJARDINS pinza p. calculos	125
DESMARRES pinza dechalazión	399
DESMARRES separadores	184,390
DEUTSCHMANN cuchillos p. catarata	390
DeVILBIS	275
diapasones alu	403
diapasones HARTMANN	403
diapasones LUCAE	402
diapasones RYDEL-SEIFFERT	402
DIEFFENBACH clamps bulldog	48
DIETRICH pinza clamp o. aorta	161
DIETRICH tijera vasculares	64
dilatadoras bujias GUYON	322
dilatadoras bujias VAN BUREN	322
dilatadores BAKES	122
dilatadores de aorta COOLEY	165
dilatadores de aorta TUBBS	165
dilatadores lacrimal WILDER	394
dilatadores p. traquetomía	170
dilatadores uterino HEGAR	340
dilatadores uterinos HANK	342
dilatadores uterinos PRATT	342
dilatadores uterinos SIMS	343
dilatadores uterinos WYLIE	343
dilatadores vasculares DE BAKEY	166
dinamómetro COLLIN	14
DINGMANN abaja-lenguas	432
DINGMANN periostótomos	440
DINGMANN pincas p. huesos	255
dissector PENFIELD	276
distribuidor de cepillos	379
DITTEL bujias dilataadoras	322
DIX instrumentos doble	394
COLLIN separadores abdominales	232,238
DOUGLAS bisturios p. amígdalas	439
DOUGLAS pinza deiplatorias	400
DOUGLAS trócares	284
DOYEN espéculos vaginales	340
DOYEN periostótomos	208
DOYEN pinza intestinales	130
DOYEN pinza p. polipos útero	137,349
DOYEN separadores abdominales	187
DOYEN sondas	15
DOYEN tirabuzón p. fibromas	344
DUPLAY pinza p. coger el cuello del útero	127
DUPUY-WEISS agujas p. amígdalas	439
DURANTE pinza de disección	45
DUVAL pinza de disección	46
DUVAL pinza p. coger tejidos	130

E

ECHLIN pinza-gubias	248
electrocirugía	382-386
elevadores	207
elevadores ADLERDYCE	269
elevadores ADSON	269
elevadores COTTLE	421
elevadores CREGO	269
elevadores HENKE	436
elevadores KEY	269
elevadores LEMPERT	413
elevadores MC DONALD	269
elevadores MURPH-LANE	260
elevadores p. amígdalas HOFER	436
elevadores p. amígdalas HURD	436
elevadores p. amígdalas LOVE	436
elevadores p. amígdalas NAGER	436
elevadores p. amígdalas YANKAUER	436
elevadores p. cuerpos extr. BUCK	406
elevadores p. cuerpos extr. QUIRE	406
elevadores p. huesos	258
elevadores p. huesos BENNETT	259
elevadores p. huesos BLOUNT	260
elevadores p. huesos HOHMANN	258,259
elevadores p. huesos HOHMANN-MINI	258
elevadores p. huesos SMILLIE	260
elevadores p. tabique	423
elevadores p. tabique BALLENGER	423
elevadores p. tabique COTTLE	421
elevadores p. tabique FREER	423
elevadores p. tabique KILLIAN	421
elevadores p. tabique McKENTY	421
elevadores p. tabique ROGER	423
elevadores SAYRE	269
elevadores WATSON-CHEYNE	269
ELLIOT forceps obstétricos	363
ELSÄSSER pinza p. nefrostomía	123
ELSCHNIG cuchillos p. cornea	390
ELSCHNIG espátulas p. ciclode	393
ELSCHNIG pinza p. fijación	397
EMMET ganchos p. fistulas	344
endospéculo KOGAN	341
ENGEL sierras p. yesos	74
ensordecador BARANY	404
enucleadores BRAND	272
enucleadores BUNNELL	272
EPPENDORFER pinza p. biopsia	305
erisifacos DASTOOR	396
escofina nasal AUFRICHT	428
escofina nasal FOMON	426,427
escofina nasal GALLAHER	426
escofina nasal JOSEPH	427
escofina nasal LEWIS	426
escofina nasal MALTZ	426,427
escofina nasal WIENER	426
escofinas	217
escofinas PUTTI	217
escupidera	377
ESMARCH cuchillos p. yesos	74
ESMARCH tijera p. vendajes	72
espatole KOCHER	323
espatole LEGUEU	323
espatulas cerebr. CUSHING	279
espatulas cerebr. OLIVECRONA	279
espatulas CULLER	393
espatulas p. ciclode ELSCHNIG	393
espatulas p. ciclode WHEELER	394
espatulas p. la íntima	167
espatulas pulmonares ALLISON	310
espatulas ROBB	167
espatulas WECKER	393

- espécúlo O’SULLIVAN-O’CONNOR 336
- espécúlo vaginales KALLMORGEN 339
- espécúlo vaginales SIMS 339
- especúlos auriculares BRUENINGS 404
- especúlos auriculares HARTMANN 404
- especúlos auriculares SIEGLE 404
- especúlos auriculares TOYNBEE 404
- especúlos nasales COTTLE 415
- especúlos nasales HARTMANN-HALLE 414
- especúlos nasales KILLIAN 414
- especúlos nasales TIECK-HALLE 414
- especúlos nasales VIENNA 414
- especúlos nasales THUDICHUM 415
- especúlos nasales VOLTOLINI 415
- especúlos rectales BARR 329
- especúlos rectales BODENHAMMER 328
- especúlos rectales CZERNY 328
- especúlos rectales MATHIEU 328
- especúlos rectales PRATT 329
- especúlos rectales SIMS 339
- especúlos SCHULZE-BERGMAN 329
- espécúlos vaginales AUVARD 339
- espécúlos vaginales BREISKY 340
- espécúlos vaginales COLLIN 335,336
- espécúlos vaginales CUSCO 335
- espécúlos vaginales DOYEN 340
- espécúlos vaginales FIEDMANN 339
- espécúlos vaginales GRAVE 335
- espécúlos vaginales KALMORGEN 339
- espécúlos vaginales KIRSTELLER 339
- espécúlos vaginales LANDAU 340
- espécúlos vaginales PEDERSON 335
- espécúlos vaginales SCHERBAK 337
- espécúlos vaginales SEMM 335
- espécúlos vaginales SIMS 339
- espécúlos vaginales TRELAT 336
- espécúlos vaginales VU MORE 334
- espejo frontal ZIEGLER 16
- espejos laringeos 16
- espejos laringeos MICHEL 303,415
- estetoscopio PINARD 14
- estiles 15
- estiletes lacrimal BOWMAN 394
- estomacales pinza clamp LANE 135
- estribos p. extensión BOEHLER 205
- estribos p. extensión KIRSCHNER 204
- estuche de bolsillo y de sutura 97
- estuche de autopsia 75
- estuche p. agujas 374
- EVES cierra-nudos p. amígdalas 438
- exploradores DESJARDINS 125

F

- FANSLER proctoscopio 331
- FARABEU perióstótomos 205
- FARABEU pinza p. huesos 254
- FARABEU separadores 186
- FARREL porta- algodons 412
- FAULKNER curetas 428
- FAURE pinza p. biopsia 296
- FAURE pinza p. peritoneo 126
- FAVALORO tijera vasculares 64
- FEHLAND pinza intestinales 131
- FELDHEIM pinza p. huesos 371
- FERGUSSON cucharillas p. coger cálgulos bil. 124
- FERRIS-SMITH pinza p. laminectomia 293
- FERRIS-SMITH-KERRISON pinza p. laminectomia 293,294
- filiformes taladros KIRSCHNER 266,267

- FINOCCHIETTO porta-agujas 89
- FINOCCHIETTO separadores 312,314
- FINSEN separadores 229
- FISCH ganchito muy fino 278
- FISCHER pinza p. iris 399
- FISH sondas 15
- FISHER bisturios p. amígdalas 439
- FOERSTER pinza p. esponjas 119,120
- FOERSTER pinza p. iris 399
- FOMON cinceles 424
- FOMON escofina nasal 426
- FOMON gancho nasales 428
- FOMON perióstótomos 206
- FOMON tubos de aspiración 59
- forceps obstétricos ELLIOT 363
- forceps obstétricos KIELLAND 363
- forceps obstétricos NAEGELE 363
- forceps obstétricos SIMPSON 363
- forceps obstétricos SIMPSON-BRAUN 363
- FOREGGER laringoscopia 19-36
- FOX curetas p. lupus 368
- FRAZIER descoladores 276
- FRAZIER separadores abdominales 239
- FRAZIER tubos de aspiración 279
- FREER bisturios nasales 423
- FREER cinceles nasales 425
- FREER cinceles p. plastica 423
- FREER elevadores p. tabique 423
- FRENZEL abaja-lenguas 430
- FRIEDMAN pinza-gubias 244
- FRIEDMAN -MINI pinza-gubias 244
- FRIEDMANN espécúlo vaginales 339
- FRIETSCH separadores 187
- FRYKHOLM pinza-gubias 248

G

- GALLAHER escofina nasal 426
- ganchito FISCH 278
- ganchito JOSEPH 176
- ganchitos p. saco lacr. KNAPP 394
- ganchitos p. saco lacr. ROLLET 393
- gancho nasales AUFRICHT 428
- gancho nasales COTTLE 428
- gancho nasales FOMON 428
- gancho nasales NEIVERT 428
- gancho p. decapitación BRAUN 366
- gancho p. la piel COTTLE 428
- gancho p. la piel FREER 176
- gancho p. la piel GILLIES 428
- gancho SMELLIE 365
- gancho YASARGIL 270
- ganchos 413
- ganchos BARBAR 413
- ganchos cutáneos KILNER 368
- ganchos McGEE 413
- ganchos musculares 238
- ganchos p. dura-madre ADSON 261
- ganchos p. dura-madre JACOBSON 278
- ganchos p. extracción ARRUGA 393
- ganchos p. fistulas EMMET 344
- ganchos p. nervios CUSHING 261
- ganchos p. nervios DANDY 261
- ganchos p. nervios GRAHAM 261
- ganchos p. nervios KRAYENBUEHL 279
- ganchos p. nervios SACHS 261
- ganchos p. nervios SMITHWICK 261
- ganchos p. strabismo GRAEFE 391,393
- ganchos p. strabismo JAMESON 393
- ganchos p. traquetomia BOSE 170
- ganchos p. traquetomia ITERSON 170

- ganchos p. traquetomia JACKSON 170,171
- ganchos p. traquetomia NEWS 171
- Gastroscopy forceps 445
- GAUSS pinza p. pericraneio 365
- GELPI separadores abdominales 232
- GEMINI pinza hemostática 109
- GERALD pinza de disección 44-45
- GERSTER pinza p. huesos 204
- GERZOG martillo 210
- GIERTZ-STILLE costotomos 311
- GIGLI mangos 194
- GILL pinza p. iris 398
- GILL-ARRUGA pinza capsulares 399
- GILL-HESS pinza p. iris 398
- GILLIE gancho p. la piel 428
- GILLIES pinza de disección 44-45
- GILLIES porta-agujas 88
- GIL-VERNET separadores 184
- GLOVER pinza clamp atrauma 151
- GLUCK costotomos 310
- GOLETT separadores 185
- GOLDMAN-FOX tijera p. encias 59
- GOMEL pinza p. microcirugia 50
- GOMEL tijera micro 69
- goniómetro MOELTGEN 14
- GOOD tijera p. amígdalas 56
- GOODELL dilataores uterinos 343
- GORNEY perióstótomos 206
- GOSSET separadores abdominales 239
- GRAEFE blefarostatos 388
- GRAEFE cistotomos 391,393
- GRAEFE cucharillas p. catarata 395
- GRAEFE cuchillos lanceol 390
- GRAEFE cuchillos p. catarata 390
- GRAEFE ganchos p. strabismo 393
- GRAEFE pinza fijación 399
- GRAEFE pinza p. iris 396
- GRAEFE separadores 393
- GRAHAM ganchos p. nervios 261
- GRASPER pinza p. biopsia 306
- GRAVE espécúlos vaginales 335
- GRAY pinza hemostática 112
- GREVEN tijera auriculares micro 407
- GRIP separadores DEEVER 190
- GROSS-MAIER pinza p. tapones 119
- gubias 195-201
- gubias COBB 199
- gubias LEXER 195
- gubias p. cuerpos extr. WALTON 391
- gubias PARTSCH 196
- gubias SMITH-PETERSEN 198
- gubias STILLE 201
- gubias ZIELKE 200
- GUTHRIE separadores 176,393
- GUYON bujias dilatadoras 322
- GUYON pinza hemostática 113,131

H

- HABERER separadores 190
- HAIGHT separadores 317
- HAJEK cinceles 425
- HAJEK martillo 213
- HAJEK-BALLENGER elevadores 421
- HAJEK-KOFLER pinza osteotomos 417
- HALLE cucharillas cortantes 298
- HALSEY porta-agujas 94
- HALSTED-MOSQUITO pinza hemostática 106
- HANK dilataores uterinos 342
- HARKEN pinza clamp p. auricula 156

HARRINGTON separadores	191
HARTMANN abaja-lenguas	430
HARTMANN cánulas lavadores	422
HARTMANN cateteres	405
HARTMANN diapasones	402,403
HARTMANN pinza	407
HARTMANN pinza auriculares	407
HARTMANN pinza hemostáticas	103,104
HARTMANN pinza p. polipos	407
HARTMANN pinze cortant. Nasales	418
HARTMANN-HALLE espejuelos nasales	414
HEANEY pinza p. histerectomía	126
HEANEY porta-aquias	89
HEANY curetas aspiradoras	350
HEANY separadores	177
HEATH martillo	213
HEGAR dilatadores uterino	340,341
HEGENBARTH pinza p. agrafes	97
HEISS pinza hemostática	117
HEISTER abre-bocas	435
hemost. ROCHESTER-KOCHNER pinza	105
hemost. CRAFOORD-SELLORS pinza	110
hemostática pinza GEMINI	109
hemostática pinza KOCHER	105
hemostática pinza PEAN	105
hemostáticos	101-115
HENKE elevadores	436
HENLEY separadores	228
HENNIG separadores p. yesos	74
HERKULEX pinza p. cortar alicates	216
HERRICK pinza p. pedunculo	114
HESS pinza capsulares	398
HESS pinza p. iris	398
HEYMANN tijera nasal	56
HEYWOOD-SMITH pinza-clamps	304
HIBBS cinceles	197
hilos p. huesos	209
HIRSCHMANN anoscopio	332
histerómetros COLLIN	341
histerómetros MARTIN	341
histerómetros SIMS	350
HOEN descoladores	276
HOESEL porta-agujas	91
HOESEL separadores	180
HOFER elevadores p. amígdalas	436
HOFFMANN pinza p. tubos	341
HOHMANN elevadores p. huesos	258,259
HOHMANN-MINI elevadores p. huesos	258
hoja de afeitar	41
hojas de bisturios	38
hojas de repuesto LA FORCE	429
HOKE cinceles	197
HOLINGER laringoscopio	34
HOLSHER separadores	270
HOLTH punzonadores p. capsulas	396
HOPKINS cuchillos p. yesos	74
HORSLEY descoladores	276
HOUSE curetas	413
HOUSE tubos de aspiración	281
HUBER mango universal	302
HUKLA pinza p. coger el cuello del útero	127,347
HUMBY dermatótopo	12
HUNTER pinza de disección	47
HURD elevadores p. amígdalas	436

I

INGE separadores	282
insuflador de aire POLITZER	404

interior caja suelta	374
introduccion de cateteres GUYON	322
IOWA pinza p. coger el cuello del útero	348
IRIS tijera	56
ISRAEL separadores	188
ITERSON ganchos p. traquetomía	170
IVES-FANSLER anoscopio	332
IUD grasper	306

J

JACKSON laringoscopio	34
JACKSON pinza p. pólipos	297
JACOBS pinza p. coger el cuello del útero	348
JACOBSON cucharillas cortantes	287
JACOBSON ganchos p. dura-madre	278
JACOBSON sonda abotonada	278
JAEGER cuchillos lanceol.	392
JAEGER placas p. parpados	389
JAMESON ganchos p. strabismo	393
JANSEN cucharillas cortantes	287
JANSEN pinza auriculares	47,406
JANSEN separadores	229
JARCHO pinza p. coger el cuello del útero	347
JENNINGS abre-bocas	434
jeringa REINER	407
JOHNS-HOPKINS pinza hemostática	48
JONES pinza de campos	127
JONES-CLIP pinza de campos	127
JORGENSEN tijera de disección	57
JOSEPH bisturios nasales	423
JOSEPH escofina nasal	426,427
JOSEPH ganchito	176
JOSEPH periostótopos	206
JOSEPH sierras nasales	428
JOSEPH tijera	58
juego p. traqueotomía	172
juego o. varices NABATOFF	232
JUERS tijera auriculares micro	407
JURASZ pinzas para pólipos laringeos	297

K

KABIERSKE lanzapolvo	404
KALLMORGEN espéculo vaginales	339
KALT-ARRUGA porta-agujas	90
KANE clamp umbilical	365
KELLY pinza hemostáticas	103
KELLY pinza p. polipos útero	349
KELLY proctoscopio	332
KELLY separadores	190,192
KELLY tijera ginecológicas	60
KERN pinza p. huesos	254
KERRISON pinza cortantes	419
KEVORKIAN curetas aspiradoras	298
KEVORKIAN pinza p. biopsia	1,351
KEY elevadores	269
KEYES trpanos cutáneos	368
KIELLAND forceps obstétricos	363
KILLIAN cánulas	420,422
KILLIAN elevadores p. tabique	421
KILLIAN espejuelos nasales	414
KILLIAN-CLAUS cinceles	425
KILNER ganchos cutáneos	368
KILNER porta-agujas	88
KILNER tijera	56
KILNER-DOUGHTY abaja-lenguas	433
KILNER-DOUGHTY abre-bocas	433

KIRK martillo	210
KIRSCHNER estribos p. extensión	204
KIRSCHNER separadores abdominales	241
KIRSCHNER sonda conductora	99
KIRSCHNER taladros filiformes	266-268
KLEINERT-KUTZ pinza conductg.	272
KLEINERT-KUTZ pinza-gubias	246
KLINKENBERG-LOTH tijera	62
KNAPP cucharillas p. catarata	395
KNAPP cuchillos p. discisión	391
KNAPP ganchitos p. saco lacr	394
KNAPP-LUER pinza de tracoma	397
KNOWLES tijera p. vendajes	72
KOCHER espatole	323
KOCHER pinza hemostática	105
KOCHER pinza intestinales	130
KOCHER separadores	178-186
KOCHER separadores	187,192
KOCHER sondas acanaladas	173
KOENIG periostótopos	206
KOENIG sonda conductora	99
KOERTE separadores	188
KOGAN endospéculo	341
KOOS bisturios	278
KRAUSE cierranudos	406
KRAUSE polipotomos	420
KRAYENBUEHL ganchos p. nercios	279
KRISTELLER espéculo vaginales	339
KROENIG abaja-lenguas	432
KRONECKER agujas p. ligaduras	100
KUHNT legras corneales	391

L

LA FORCE cuchillos adenoides	429
LAHEY pinza hemostática	117
LAHEY pinza p. coger el bocio	173
LAHEY separadores	178
LAMBOTTE cinceles	195
LAMBOTTE periostótopos	205
LAMBOTTE pinza p. huesos	254
lamp. Frontal CLAR	16
LANDAU espéculos vaginales	340
LANE pinza clamp estomacales	135
LANE pinza de disección	46
LANE pinza p. huesos	253
LANGENBECK cuchillo p. amputación	10
LANGENBECK cuchillo p. resección	12
LANGENBECK dedales	431
LANGENBECK periostótopos	205
LANGENBECK pinza p. huesos	254
LANGENBECK sierra p. amputación	194
lanzapolvo KABIERSKE	404
laringoscopio FOREGGER	19-36
laringoscopio HOLINGER	34
laringoscopio McINTOSH	19-21
laringoscopio	19-36
LAWRENCE pinza hemostática	111
LEBSCHÉ cinceles	217
LEGUEU espatole	323
LEGUEU separadores vesicales	323
LEKSELL pinza-gubias	249
LEMPERT cucharillas cortantes	290
LEMPERT elevadores	413
LEMPERT pinza-gubias	244
LERCHE pinza de disección	46
LERCHE pinza hemostática	107
LEWIN pinza p. huesos	256
LEWIS escofina nasal	426
LEXER cinceles	195
LEXER gubias	195

LEXER tijera de disección	60
LEXER-BABY tijera de disección	57
LEXER-MINI cinceles	195
LICHTENBERG porta-agujas	91
LICHTWITZ cánulas	284
ligadores hemorroidales RUDD	308
limas p. unas	370,371
LISTER tijera p. vendajes	72
LISTER-BURCH blefarostatos	389
LISTON cuchillo p. amputación	10
LISTON pinza cont. p. huesos	253
LITTAUER pinza deplatorias	400
LITTAUER tijera p. ligaduras	58
LITTLE separadores	178
LITTLEWOOD pinza p. coger intestino	136
lomas	217
LORNA pinza de campos	127
LOUTE tensor cierra-hilos	204
LOVE elevadores p. amígdalas	436
LOVE separadores nervios	261
LOVE-GRUENWALD pinza p. laminectomía	292
LOVELACE pinza hemostáticas	107
LOWER pinza hemostática	117
LOWMAN pinza p. huesos	204
LUC pinza p. el tabique nasal	416
hook, DeVILBIS skull forceps	275
LUCAE aguja p. paracentesis	47,406
LUCAE diapasones	402
LUCAE martillo	210
LUCAE pinza auricular	47
LUER cánulas traqueales	171
LUER pinza-gubias	245
LUICKART-BILL tiradores	364
LUNIATSCHKE elevadores p. amígdalas	436

M

MATZENAUER espéculo vaginales	338
MAGILL pinza p. cateter	17
MALTZ escofina nasal	426,427
mango de aspiración WULLSTEIN	405
mango universales HUBER	302
mangos de bisturios	38
mangos GIGLI	194
mano de plomo	210
MARTEL pinza hemostática	102
martillo	210-213
martillo BERGMANN	211
martillo COTTLE	210
martillo de percusión BABINSKY	15
martillo de percusión BUCK	15
martillo de percusión DEJERINE	15
martillo de percusión TAYLOR	15
martillo de percusión TROEMNER	15
martillo GERZOG	210
martillo HAJEK	213
martillo HEATH	213
martillo KIRK	210
martillo LUCAE	210
martillo mango plastico	211
martillo MEAD	210
martillo OMBREDANNE	213
martillo PARTSCH	211
martillo WILLIGER	210
MARTIN histerómetros	341
MARTIN pelvimetros	346
MARTIN pinza p. huesos	256
MARTINI cucharillas cortantes	289

MASSON porta-agujas	89
MASTIN pinza-clamp p. musculos	173
MATHIEU espejillos rectales	328
MATHIEU porta-agujas	91
MATHIEU separadores	186
MATSON periostótomos	207
MATSON-ALEXANDER periostotomo	207
MAUNDER abre-bocas	431
MAYO abaja-lenguas	432
MAYO cadres de esterilización	369
MAYO-BLAKE pinza p. calculos	123
MAYO-GUYON pinza hemostática	113
MAYO-HEGAR porta-agujas	94
MAYO-STILLE tijera de disección	56
MC DONALD elevadores	269
MC GIVNEY ligadores hemor	308
MC INDOE pinza cont p. huesos	252
MC IVOR abre-bocas	433
MC KENZIE pinza aplicadoras	273
MC LEAN forceps obstétricos	364
MC LEAN-LUICKART forceps obstétricos	364
McGEE ganchos	413
McGEE tijera auriculares micro	407
MCINDOE pinza de disección	44
McINTOSH laringoscopia	19-21
McKENTY elevadores p. tabique	421
MEAD martillo	210
MEAD pinza-gubias	244
MEEKER pinza hemostática	111
MEHDORN clips p. vasos	465
MEHDORN pinza p. poner clips	465
MELLINGER blefarostatos	388
meniscótomos NEFF	271
meniscótomos SMILLIE	271
MERCEDES separadores toracico	319
METZENBAUM tijera	55,57
METZENBAUM tijera de disección	55
MEYERDING separadores	179,191
MEYHOEFER curetas p. chalazión	395
MICHEL agrafes	97
MICHEL espejos laringeos	303
MICHEL pinza p. agrafes	97
micro tijera	64-69
micro tijera auriculares	407
micro tijera auriculares COS	407
micro tijera auriculares GREVEN	407
micro tijera auriculares ovale	407
micro tijera bajonett	66
micro tijera HEPP-SCHEIDEL	68
MIDDLETON-JANSEN pinza osteotomos	419
MIKULICZ pinza p. peritoneo	126
MIKULICZ separadores	192
MILLIGAN descoladores	275
MILLIN pinza p. coger prostata	324
MILLIN separadores vesicales	323
MINI-LAMBOTTE cinceles	199
MIXTER pinza hemostática	111
MIXTER-BABY pinza hemostática	106
MIXTER-O'SHAUGHNESSY pinza hemostática	111
MOELTGEN goniómetro	14,75
MOLLISON separadores	230
MOLT abre-bocas	435
MOORE perforadores	218
MORSE separadores	312
MUCK cuchillos	413
MUELLER aproximadores	467
MUELLER blefarostatos	389
MUELLER clip p. vasos	468
MÜNCHEN curetas aspiradoras	350
MURDOCK blefarostatos	389
MURPHY-LANE elevadores	260

MUSEUX pinza p. coger el cuello del útero	348
MYLES pinze cortantes nasales	418

N

NABATOFF juego p. varices	232
NAEGELE forceps obstétricos	364
NAGER elevadores p. amígdalas	436
nasal escofina GALLAHER	426
nasales sierras JOSEPH	428
navaja	41
NEFF meniscótomos	271
NEGUS pinza p. coger	437
NELATION sondas	15
NELSON agujas p. ligaduras	100
NELSON pinza de disección	46
NELSON trócares	284
NEWS ganchos o. traquetomia	171
NOTO pinza p. polipos útero	137,349
NOVAK curetas aspiradoras	344
NOYES tijera p. oculares	401

O

O'CONNOR separadores abdominales	336
obstétricos forceps ELLIOT	363
obstétricos forceps KIELLAND	363
obstétricos forceps NAEGELE	363
obstétricos forceps SIMPSON	363
OBWEGESER agujas	440
OBWEGESER periostótomos	440
OBWEGESER separadores	441,442
OCHSNER trócares thorax	283
OEHLER pinza de disección	84
OLDBERG pinza p. laminectomia	295
OLIVECRONA descoladores	194
OLIVECRONA espátulas cerebr	279
OLIVECRONA pinza-gubias	245
OLIVECRONA sierra	194
OLIVECRONA-TÖNNIS pinza aplicadora	273
OLLIER separadores	187
OLSEN-HEGAR porta-agujas	91
OMBREDANNE martillo	213
OSTROEM pinza osteotomos	417
O'SULLIVAN-O'CONNOR espéculo	336
OVERHOLT periostótomos	207

P

PARK blefarostatos	389
PARKER separadores	185-186
PARTSCH cinceles	196
PARTSCH gubias	196
PARTSCH martillo	211
pasa-hilos agujas DEMEL	262
PAYR pinza-clamp intestinales	130
PAYR sonda conductora	100
PEAN pinza hemostática	102,103,105
PEDERSON espéculos vaginales	335
PEERS pinza de campos	127
PEET pinza de disección	47
PELKMANN pinza p. tapones	112
pelvimetros COLLIER	346
PENFIELD descoladores	276
PENFIELD dissector	276
PERCY separadores	194
perforacráneos SMELLIE	366

perforadores	218,220,221	pinza cont. p. huesos LISTON	253	pinza hemostática HALSTED-	
perforadores eléctrico	224	pinza cont. p. huesos MC INDOE	252	MOSQUITO	106
perforadores MOORE	218	pinza cont. p. huesos SEMB	252	pinza hemostática HEISS	117
perforadores óseos man. STILLE	218	pinza cont. p. huesos STILLE-		pinza hemostática JOHNS-HOPKINS	111
perforadores óseos manuales BUNELL	224	HORSLEY	252	pinza hemostática KOCHER	103,105
perforadores óseos manuales con sierra		pinza contant p. huesos RUSKIN-		pinza hemostática LAHEY	117
Jacobs	219	LISTON	253	pinza hemostática LAWRENCE	111
perforadores óseos manuales HUDSON	218	pinza contant p. huesos STILLE-LISTON	253	pinza hemostática LERICHE	107
perforadores óseos manuales RALK	224	pinza cortante p. hipfisis	295	pinza hemostática LOVELACE	107
perforadores STILLE-SHERMAN	218	pinza cortantes HAJEK-KOFLER	417	pinza hemostática LOWER	117
periotostotomo MATSON-ALEXANDER	207	pinza cortantes KERRISON	419	pinza hemostática MARTEL	102
periotostótomos ALEXANDER	206	pinza de campos BACKHAUS	127	pinza hemostática MEEKER	111
periotostótomos BOIES	206	pinza de campos BÜLOW-GUNAR-HE	116	pinza hemostática MIXTER	111,112
periotostótomos DINGMANN	440	pinza de campos JONES	127	pinza hemostática MIXTER-BABY	106
periotostótomos DOYEN	208	pinza de campos JONES-CLIP	127	pinza hemostática PEAN	102,103,105
periotostótomos FARABEUF	205	pinza de campos LORNA	127	pinza hemostática PENNINGTON	107
periotostótomos FARABEUF-COLLIN	205	pinza de campos PEERS	127	pinza hemostática PRATT	102
periotostótomos FOMON	206	pinza de campos SCHAEDEL	127	pinza hemostática ROBERTS	108
periotostótomos GORNEY	206	pinza de campos TOHOKU	127	pinza hemostática RUMEL	108
periotostótomos JOSEPH	206	pinza de disección	44-52	pinza hemostática SAROT	109
periotostótomos KOENIG	206	pinza de disección ADSON	44-45	pinza hemostática TOENNIS	110
periotostótomos LAMBOTTE	205	pinza de disección ADSON-BROWN	45	pinza hemostática TUFFIER	102
periotostótomos LANGENBECK	205	pinza de disección ARCHER	47	pinza hemostática ZENKER	109
periotostótomos MATSON	207	pinza de disección BONNEY	45	pinza hemostáticas CRILE	104
periotostótomos OBWEGESER	440-442	pinza de disección BROWN	45	pinza hemostáticas CRILE RANKIN	104
periotostótomos OVERHOLT	207	pinza de disección COLLIN-DUVAL	46	pinza hemostáticas HARTMANN	103,104
periotostótomos SEDILLOT	205	pinza de disección DURANTE	46	pinza hemostáticas KELLY	103
periotostótomos SEMB	208	pinza de disección DUVAL	46	pinza hemostáticas ROCHESTER-	
periotostótomos WILLIGER	206	pinza de disección FEILCHENFELD	44	CARMALT	107
PESTALOZZA cucharillas p. aborto	365	pinza de disección GERALD	44-45	pinza hemostáticas SPENCER-WELLS	103
PHANEUF pinza p. peritoneo	114	pinza de disección GILLIES	45	pinza hemostática WILLET-MARTEL	102
PIERCE trócares	284	pinza de disección HUNTER	47	pinza hemostática MIXTER-	
PIFFARD curetas p. lupus	368	pinza de disección LANE	46	O'SHAUGNESSY	111
PINARD estetoscopio	14	pinza de disección LERCHE	46	pinza intestinales FEHLAND	131
pinza aplicadoras MC KENZIE	273	pinza de disección MC INDOE	44	pinza microlaringea	300
pinza aplicadoras SMITHWICK	273	pinza de disección NELSON	46	pinza musculares PRINCE	397
pinza aplicadoras SWEET	273	pinza de disección OEHLER	84	pinza nasales WATSON-WILLIAM	422
pinza atramaticas DE BAKEY	140-145	pinza de disección PEET	47	pinza nasales WEIL-BLAKESLEY	416
pinza auriculares HARTMANN	407	pinza de disección RUSSIAN	45	pinza osteotomos CITELLI	419
pinza auriculares LUCAE	47,406	pinza de disección SEMKEN	44	pinza osteotomos HAJEK-KOFLER	417
pinza auriculares TROELTSCH	47	pinza de disección STIEGLITZ	47	pinza osteotomos OSTROEM	417
pinza auriculares WILDE (TROELTSCH)	47	pinza de disección TAYLOR	46	pinza p. aborto SAENGER	137
pinza capsulares ARRUGA	399	pinza de disección USA	44	pinza p. aborto WINTER	365
pinza capsulares HESS	398	pinza de disección VIRTUS	48	pinza p. agrafes CHILDE	97
pinza capsulares SCHWEIGGER	399	pinza de disección WANGENSTEEN	85	pinza p. agrafes COLLIN	97
pinza CHEVALIER-JACKSON	296	pinza DE MARTEL-WOLFSON	134	pinza p. agrafes HEGENBARTH	97
pinza cierra-tubos	116-117	pinza de tracción craneal CRUTCHFIELD	274	pinza p. agrafes MICHEL	97
pinza clamp atrauma BAINBRIDGE	108	pinza de tracción CRUTCHFIELD	274	pinza p. agrafes RICHTER-HEATH	97
pinza clamp atrauma COOLEY	161	pinza de tracoma KANPP-LUER	397	pinza p. agrafes WACHENFELDT	97
pinza clamp atrauma DE BAKEY	140-144	pinza dechalazión AYER	399	pinza p. anastom. Atrauma HAYES	133
pinza clamp atrauma DE BAKEY	147,151	pinza dechalazión DESMARRS	399	pinza p. apéndice ALLEN	132
pinza clamp atrauma DE BAKEY	157	pinza dedisección POTTS-SMITH	44	pinza p. apéndice KLEINSCHMIDT	132
pinza clamp atrauma DERRA	148	pinza deentropión SNELLEN	399	pinza p. aplicar clips RANEY	274
pinza clamp atrauma GLOVER	141,151	pinza deiplatorias BEER	400	pinza p. arrancar unas	370
pinza clamp atrauma SATINSKY	129	pinza deiplatorias DOUGLAS	400	pinza p biopsia ALEXANDER	7,298
pinza clamp atrauma SUBRAMANIAN	162	pinza deiplatorias LITTAUER	400	pinza p. biopsia BURKE	305
pinza clamp bronq. FINOCCHIETTO	128	pinza HARTMANN	407	pinza p. biopsia EPPENDORFER	305
pinza clamp bronq. HARRINGTON	128	pinza HARTMANN-HOFFMANN	407	pinza p. biopsia FAURE	296
pinza clamp bronq. PRICE-THOMAS	128	pinza HARTMANN-WULLSTEIN	407	pinza p. biopsia KEVORKIAN	1,298,351
pinza clamp bronquiales SEMB	129	pinza hemostática ADSON	106	pinza p. biopsia rectal TURREL	304
pinza clamp estomacales LANE	135	pinza hemostática ADSON-BABY	106	pinza p. biopsia rectal YEOMAN	296,304
pinza clamp nacidos CASTANEDA	163	pinza hemostática ATRAUMA	121,131,133	pinza p. biopsia SCHUBERT	296
pinza clamp laparoskopie	357	pinza hemostática ATRAUMA	140-164	pinza p. biopsia SCHUMACHER	298
pinza clamp p. aorta WEBER	153	pinza hemostática CHAPUT	102	pinza p. biopsia THOMS-GAYLOR	296
pinza clamp p. auricula HARKEN	156	pinza hemostática COLLIN	102	pinza p. biopsia TISCHLER	1,351
pinza clamp p. coartación POTTS	150	pinza hemostática CRAFOORD	109	pinza p. biopsia TISCHLER-MORGAN	1,351
pinza clamp p. vasos SATINSKY	129	pinza hemostática CRAFOORD-		pinza p. biopsia TOWNSEND	1,351
pinza clamps hemor. MC GIVNEY	308	SELLORS	110	pinza p. biopsia TOWNSEND-MINI	1,351
pinza condugt. KLEINERT-KUTZ	272	pinza hemostática DANDY	107	pinza p. biopsia VAN DOREN	298
pinza cont. p. huesos BOEHLER	252	pinza hemostática DESJARDINS	112	pinza p. biopsia WITTNER	307
pinza cont. p. huesos COTTLE-		pinza hemostática GEMINI	109	pinza p. calculos biliar, BLAKE	123
KAZANJIA	253	pinza hemostática GRAY	112	pinza p. calculos biliar, DESJARDINS	122

pinza p. calculos biliar, MAYO-BLAKE . . .	123	pinza p. esterilizacion UNIVERSAL	369	pinza p. separar yesos WOLFF	74
pinza p. calculos biliar, MIXTER	123	pinza p. fijación ELSCHNIG	397	pinza p. tapones BOZEMANN	119
pinza p. calculos renales RANDALL	122	pinza p. hipofisis ADSON	277	pinza p. tapones CHERON	120
pinza p. cateter MAGILL	17	pinza p. histerectomia HEANEY	115,126	pinza p. tapones COLLIN	120
pinza p. clips de vasos BIEMER	464	pinza p. histerectomia HEANY- BALLENTINE	115	pinza p. tapones GROSS-MAIER	119
pinza p. coger alambre	214-216	pinza p. histerectomia ROGERS	115	pinza p. tapones LISTER	120
pinza p. coger amigdalas BALLENGER	438	pinza p. histerectomia WERTHEIM	114,126	pinza p. tapones PELKMANN	122
pinza p. coger amigdalas BLOHMKE	438	pinza p. histerectomia WERTHEIM- CULLEN	114	pinza p. tubos HOFFMANN	341
pinza p. coger amigdalas COLVER	437	pinza p. huesos BIRCHER-GANSKE	255	pinza p. tubos SIMPLEX	341
pinza p. coger amigdalas NEGUS	437	pinza p. huesos DINGMANN	255	pinza p. tumores YASARGIL	52
pinza p. coger amigdalas SAWTELL	437	pinza p. huesos FARABEU	254	pinza p. vasectomia	330
pinza p. coger amigdalas SCHNIDT	437	pinza p. huesos FARABEU- LAMBOTTE	254	pinza roman p. tumores	295
pinza p. coger amigdalas TYDING	438	pinza p. huesos FELDHEIM	371	pinza SERPENTINE GRASPER IUD	306
pinza p. coger amigdalas WHITE	437	pinza p. huesos KERN	254	pinza STEINMANN	267-268
pinza p. coger el bocio LAHEY	173	pinza p. huesos LAMBOTTE	254	pinza STONE	133
pinza p. coger el cuello del útero BARRET	347	pinza p. huesos LANE	253	pinza STONE-WATT	133
pinza p. coger el cuello del útero BRAUN	347	pinza p. huesos LANGENBECK	254	pinza STRUEMPEL	407
pinza p. coger el cuello del útero DUPLAY	127	pinza p. huesos LEWIN	256	pinza tira-lenguas COLLIN	102,435
pinza p. coger el cuello del útero HULKA	127	pinza p. huesos LOWMAN	204	pinza tira-lenguas YOUNG	435
pinza p. coger el cuello del útero IOWA	348	pinza p. huesos MARTIN	256	pinza TISCHLER-KEVORKIAN	351
pinza p. coger el cuello del útero JACOBS	348	pinza p. huesos REILL	256,257	pinza-clamp p. musculos MASTIN	173
pinza p. coger el cuello del útero JARCHO	347	pinza p. huesos SEMB	254	pinza-clamps HEYWOOD-SMITH	304
pinza p. coger el cuello del útero MUSEUX	348	pinza p. huesos ULRICH	257	pinza-gubias BEYER	249
pinza p. coger el cuello del útero PRATT	348	pinza p. huesos VERBUGGE	255	pinza-gubias BLUMENTHAL	245
pinza p. coger el cuello del útero SCHROEDER	127,348	pinza p. huesos FERGUSON	254	pinza-gubias BOEHLER	247
pinza p. coger el cuello del útero SKENE	127	pinza p. iris BARRAQUER	398	pinza-gubias CLEVELAND	244
pinza p. coger el cuello del útero STAUDE-MOORE	347	pinza p. iris BARRAQUER-KATZIN	398	pinza-gubias ECHLIN	248
pinza p. coger el cuello del útero TEALE	127	pinza p. iris BISHOP-HARMAN	398	pinza-gubias FRIEDMAN	244
pinza p. coger int. THOMS-ALLIS	121	pinza p. iris FISCHER	399	pinza-gubias FRIEDAN-MINI	244
pinza p. coger intestino ALLIS	121	pinza p. iris FOERSTER	399	pinza-gubias FRYKHOLM	243
pinza p. coger intestinos ALLIS-ADAIR	121	pinza p. iris GILL	398	pinza-gubias KLEINERT-KUTZ	246
pinza p. coger intestinos ALLIS-BABY	121	pinza p. iris GILL-HESS	398	pinza-gubias LEKSELL (STILLE)	249
pinza p. coger intestinos JUDD-ALLIS	121	pinza p. iris GRAEFE	396	pinza-gubias LEMPERT	244
pinza p. coger prostata MILLIN	324	pinza p. iris HESS	398	pinza-gubias LUER	245
pinza p. coger prostata YOUNG	324	pinza p. iris STEVENS	396	pinza-gubias MEAD	244
pinza p. coger pulmón LOVELACE	128	pinza p. iris TUEBINGEN	400	pinza-gubias OLIVECRONA	245
pinza p. coger tejidos DUVAL	130	pinza p. laminectomia CLOWARD	299	pinza-gubias RUSKIN	249
pinza p. coger tejidos WILLIAMS	131	pinza p. laminectomia COLCLOUGH	294	pinza-gubias SAUERBRUCH	248
pinza p. coger tendones	272	pinza p. laminectomia CUSHING	292	pinza-gubias SCAGLIETTI	248
pinza p. coger tendones BRAND	272	pinza p. laminectomia FERRIS- SMITH	293,294	pinza-gubias SEMB	248
pinza p. coger tendones CAROLL	272	pinza p. lmainectomia FERRIS- SMITH-KERRISON	293,294	pinza-gubias SMITH-PETERSEN	247
pinza p. cordales imp. ROWE	431	pinza p. laminectomia LOVE- GRUENWALD	293,294	pinza-gubias STILLE-LUER	249
pinza p. cortar alambre	216	pinza p. laminectomia OLDBERG	295	pinza-gubias STILLE-RUSKIN	249
pinza p. cuerpos extr. MATHIEU	325	pinza p. laminectomia SCHLESINGER	299	pinza-gubias ZAUFAL-JANSEN	249
pinza p. desechos DAVIS	44,369	pinza p. laminectomia SPURLING	293	pinzas bipolares	384-386
pinza p. desechos SAUERBRUCH	369	pinza p. ligaduras TUEBINGEN	400	pinzas p. cortar alambre HERKULES	216
pinza p. el tab. nasal BRUENINGS	416	pinza p. magullar tabique RUBIN	418	pinze cortantes MYLES	418
pinza p. el tab. nasal HEYMANN	416	pinza p. microcirugia	49-52	PIPER forceps obstétricos	364
pinza p. el tab. nasal KNIGHT	416	pinza p. microcirugia ADSON-BROWN	50	pistola lavatora con tobera	380
pinza p. el tabique nasal LUC	416	pinza p. microcirugia GOMEL	50	placas p. parpados JAEGER	389
pinza p. el útero COLLIN	137,349	pinza p. microcirugia VICKERS	51	platos p. tabletas	376A
pinza p. el útero DARTIGUES	137,349	pinza p. nefrostomia ELSÄSSER	123	PLESTER separadores	228
pinza p. el útero SOMER	137,349	pinza p. pedunculo HERRICK	114	PLESTER tubos de aspiración	17,281
pinza p. endrezar el tabique ASCH	420	pinza p. peritoneo FAURE	126	polipos pinza p. HARTMANN	407
pinza p. endrezar el tabique WALSHAM	420	pinza p. peritoneo MIKULICZ	126	polipotomos KRAUSE	420
pinza p. espinas	48	pinza p. peritoneo PHANEUF	114	polipotomos WILDE	420
pinza p. esponjas BRYANT	120	pinza p. polipos FRAENKEL	297	POLITZER aguja p. paracentesis	405
pinza p. esponjas FOERSTER	119-120	pinza p. polipos JURASZ	297	POLITZER insuflador de aire	404
pinza p. esponjas RAMPLEY	119	pinza p. polipos ULRICH	119	porta-agujas	88-95
pinza p. esterilizacion	44	pinza p. polipos útero DOYEN	137,349	porta-agujas ARRUGA	90
pinza p. esterilizacion CHEATLE	369	pinza p. polipos útero KELLY	137,349	porta-agujas BARRAQUER	90
pinza p. esterilizacion ROGGE	369	pinza p. poner aneurisma clips	465-470	porta-agujas BAUMGARTNER	89,94
		pinza p. poner clips BIEMER	467,469	porta-agujas CATROV.-MICRO	95
		pinza p. poner clips de vasos MEHDORN	465	porta-agujas CASTROVIEJO	88
				porta-agujas CRILE-WOOD	89,94
				porta-agujas DERF	89,94
				porta-agujas FINOCCHIETTO	89
				porta-agujas GILLIES	88
				porta-agujas HALSEY	89,94
				porta-agujas HEANEY	89
				porta-agujas HOESEL	91
				porta-agujas JACOBSON	89,90
				porta-agujas KILNER	88

porta-agujas LICHTENBERG	91
porta-agujas MASSON	89,94
porta-agujas MATHIEU	91,94
porta-agujas MAYO-HEGAR	89,94
porta-agujas OLSEN-HEGAR	91
porta-agujas RYDER	88
porta-algodon	412
porta-algodon TOBOLD	412
POTTS-SMITH pinza de disección	44,45
PRATT dilatadores uterinos	342
PRATT especulos rectales	329
PRATT pinza hemostática	102
PRATT pinza p. coger el cuello del útero	348
PRATT sondas p. fistulas	332
PRINCE pinza musculares	397
proctoscopio CHELSEA-EATON	332
proctoscopio FANSLER	331
proctoscopio KELLY	332
punzonadores p. capsulas HOLTH	396
PUTTI escofinas	217

Q

QUIRE elevadores	406
----------------------------	-----

R

RAGNELL separadores	185
RALK perforadores óseos manuales	224
RAMPLEY pinza p. esponjas	119
RAMUS separadores	442
RANDALL curetas aspiradoras	344
RANEY pinza hemostática	274
RANEY pinza p. aplicar clips	274
RECAMIER curetas uterinas	358
recipientes	375
rectal cierre-nudos WESTON	304
REDON aguja de guía	447
REICHERT depresor p. epiglotis	297
REILL pinza p. huesos	257
REINER cuchillos p. yesos	74
REINER jeringa completo	407
retractores nasales AUFRIEHT	428
REVERDIN agujas p. ligaduras	96
REVERDIN separadores abdominales	190
RIBBON separadores	190
RICHARDSON separadores	186,190
RICHARDSON-EASTMAN separadores	186
RIGBY separadores	232
RITTER-HALLE cánulas	422
ROBB espátulas	167
ROBERTS pinza hemostática	108
ROCHARD quadro p. separador abdom	236
ROGER elevadores p. tabique	423
ROGERS pinza p. hysterectomia	115
ROGGE pinza p. esterilización	369
ROLLET ganchitos p. saco lacr	393
rompe-hojas CASTROVIEJO	41
rompe-hojas TROUTMAN	41
ROSEN agujas	413
ROSEN cuchillos	411
ROSEN tubos de aspiración	281
ROSER-KOENIG abre-bocas	435
ROUX separadores	185,186
ROWE pinza p. cordales imp	431
RUDD ligadores hemorroidales	308
RUMEL pinza hemostática	108
RUMEL-BELMONT torniquetes	165

RUSKIN pinza-gubias	249
RYDEL-SEIFFERT diapasones	402
RYDER porta-agujas	88

S

SAALFELD saca comedones	368
saca comedones SCHAMBERG	368
saca comedones UNNA	368
saca comedones WALTON	368
SACHS descoladores	275
SACHS ganchos p. nervios	261
SAENGER pinza p. aborto	137
salpingógrafo SCHULTZE	345
SAROT pinza hemostática	109
SATINSKY pinza clamp p. vasos	129
SATINSKY tijera p. thorax	62
SATTERLEE sierra p. amputación	194
SAUERBRUCH costotomos	311
SAUERBRUCH pinza p. desechos	369
SAUERBRUCH pinza-gubias	248
SAUERBRUCH separadores	189
SAUERBRUCH-FREY costotomos	311
SAWTELL pinza p. coger amígdalas	437
SAYRE elevadores	269
SCAGLIETTI pinza-gubias	248
SCHAEDEL pinza de campos	127
SCHAMBERG saca comedones	368
SCHEDE cucharillas cortantes	290
SCHERBAK espéculos vaginales	337
SCHINK dermatomo	12
SCHIOETZ tonometro	388
SCHLESINGER pinza p. laminectomia	299
SCHMIEDEN sonda conductora	99
SCHNIDT pinza p. coger amígdalas	437
SCHÖNBORN separadores	173
SCHROEDER pinza p. coger	127
el cuello del útero	127
SCHUBERT pinza p. biopsia	296
SCHUKNECHT cuchillos	411
SCHULTZE salpingógrafo	345
SCHULZE-BERGMAN especulos	329
SCHUMACHER biopsie	298
SCHUMACHER inserto	302
SCHUMACHER tijera umbilicales	61
SCHWEIGGER pinza capsulares	399
SCOVILLE cucharillas cortantes	288
SCOVILLE separadores	270
SCOVILLE-HAVERFIELD separadores p. laminectomia	270
SEDILLOT periostótomos	205
SEGOND bisturi p. fibromas	344
SEMB periostótomos	208
SEMB pinza clamp bronquiales	129
SEMB pinza cont p. huesos	252
SEMB pinza p. huesos	252
SEMB pinza-gubias	248
SEMKEN pinza de disección	44
SEMM espéculos vaginales	335
SENN-GREEN separadores	178
sensímetro WARTENBERG	14
SEUTIN tijera p. vendas	61
separador abdominales ROCHARD	236
separador p. piloro BENSON	132
separadores abdominales BALFOUR	235,240
separadores abdominales COLLIN	232
separadores abdominales FRAZIER	239
separadores abdominales GOSSET	239
separadores abdominales KIRSCHNER	241
separadores abdominales O'SULLIFAN	239

separadores abdominales REVERDIN	190
separadores abdominales RICARD	237,238
separadores abdominales RIGBY	232
separadores abdominales DOYEN	236
separadores abdominales GELPI	232
separadores ADSON	226,227
separadores ADSON-BABY	226
separadores ALM	229
separadores alu FINOCCHIETTO	314
separadores ANDERSON-ADSON	226
separadores BECKMANN	227
separadores BECKMANN-EATON	227
separadores BRUNNER	180,187
separadores CASPAR	231
separadores CLOWARD	282,230
separadores COOLEY	182,316
separadores COOLEY-NEONATAL	315
separadores CORYLLOS	189
separadores CRILE	185
separadores CUSHING	184,188
separadores DARLING	230
separadores DAVIDSON	189
separadores DE BAKEY	316
separadores DE BOEY	316
separadores de yesos	74
separadores de yesos HAGLUND	74
separadores de yesos HENNIG	74
separadores DEEVER	190-191
separadores DESMARES	184,390
separadores DINGMANN	440
separadores espinales TAYLOR	260
separadores FARABEUF	186
separadores FINOCCHIETTO	312-314
separadores FINSEN	229
separadores FRITSCH	187
separadores GIL-VERNET	184
separadores GOELET	185
separadores GRAEFE	393
separadores GUTHRIE	176
separadores HABERER	190
separadores HAIGHT	317
separadores HARRINGTON	191
separadores HEANY	177
separadores HENLEY	228
separadores HOESEL	180
separadores HOLSHER	270
separadores INGE	282
separadores ISRAEL	188
separadores JANSEN	229
separadores JUDD-MASSON	323
separadores KELLY	190,192
separadores KOCHER	178,186
separadores KOCHER	187,192
separadores KOERTE	188
separadores LAHEY	178
separadores laminectomia	233-234
separadores LITTLE	178
separadores MATHIEU	186
separadores MEYERDING	179,191
separadores MIKULICZ	192
separadores MILLIN	323
separadores MOLLISON	230
separadores MORSE	312
separadores MORSE-FAVALORO	312
separadores OBWEGESER	442,443
separadores OLLIER	187
separadores p. labios y mejilla	430
separadores p. mej. STERNBERG	430
separadores p. nervios LOVE	261
separadores p. nervios SCOVILLE	270
separadores PARKER	185,186
separadores PLESTER	228
separadores RAGNELL	185

separadores RAMUS.	442
separadores rectales ALAN-PARKS.	328
separadores rectales SMITH-BUIE.	329
separadores RIBBON.	190
separadores RICHARDSON.	186,190
separadores RICHARDSON-EASTMAN.	186
separadores RIENHOFF.	316
separadores RIGBY.	232
separadores ROUX.	185,186
separadores SAUERBRUCH.	189
separadores SCHÖNBORN.	173
separadores SCOVILLE.	270
separadores SENN-GREEN.	178
separadores SIMON.	192
separadores SPINA-NASALIS.	443
separadores ST. MARKS.	181
separadores suelto ALAN-PARKS.	328
separadores TESSIER.	440
separadores THOMSON-WALKER.	323
separadores TUFFIER.	317
separadores USARMY.	187
separadores vesicales LEGUEU.	323
separadores vesicales MILLIN.	323
separadores VOLKMANN.	176,177
separadores VOLKMANN.	185
separadores WEITLANER.	229
separadores ZENKER.	183
separadores PERCY.	194
separadores p. laminectomía	
SCOVILLE-HAVERFIELD.	234
SEXTON cuchillos auriculares.	404
SHEA tijera auricularesmicro.	408
SIEBENMANN cánulas.	422
SIEGLE espejuelos auriculares.	404
sierra eléctrica p. yesos.	73
sierra OLIVECRONA.	194
sierra p. amputación CHARRIERE.	194
sierra p. amputación LANGENBECK.	194
sierra p. amputación SATTERLEE.	194
sierra nasales JOSEPH.	428
sierras p. yesos ENGEL.	74
sierras p. yesos WIGMORE.	74
SILVER cinceles p. plastica.	425
SIMON curetas uterinas.	290
SIMON separadores.	192
SIMPLEX pinza p. tubos.	341
SIMPSON forceps obstétricos.	363
SIMPSON -BRAUN forceps obstétricos.	363
SIMS curetas uterinas.	358
SIMS depresores uterinos.	341
SIMS dilatadores uterinos.	343
SIMS espéculo vaginales.	339
SIMS espéculos rectales.	328
SIMS espéculos vaginales.	339
SIMS histerómetros.	350
SIMS tijera ginecológicas.	60
SKENE pinza p. coger el cuello del	
útero.	127
SLUDER-BALLENGER amidalótomos.	439
SMELLIE gancho.	365
SMELLIE perforacráneos.	366
SMILLIE elevadores p. huesos.	260
SMILLIE meniscótomos.	271
SMITH blefarostatos.	389
SMITH tijera p. vendajes.	61
SMITH-PETERSEN cinceles.	198
SMITH-PETERSEN gubias.	198
SMITHWICK ganchos p. nervios.	261
SMITHWICK pinza aplicadoras.	273
SNELLEN asas.	395
SNELLEN pinza deentropión.	399
SOMER pinza p. el útero.	137,349
sonda conductora BRUNNER.	100
sonda conductora KIRSCHNER.	99
sonda conductora KOENIG.	99
sonda conductora PAYR.	99
sonda conductora SCHMIEDEN.	99
sonda JACOBSON.	278
sondas.	15
sondas DOYEN.	15
sondas FISH.	15
sondas KOCHER.	173
sondas metálicas p. prostata.	322
sondas NELATON.	15
sondas p. fistulas PRATT.	332
sondas STACKE.	15
SPENCER tijera p. ligaduras.	58
SPENCER-WELLS pinza hemostáticas.	103
SPINAL cucharillas cortantes.	288
SPINA-NASALIS separadores.	440-443
SPRATT cucharillas cortantes.	289
SPURLING pinza p. laminectomía.	292
ST. MARKS separadores.	181
ST. CLAIR-THOMSON cuchillos.	429
STACKE sondas.	15
STEINMANN clavos p. huesos.	267,268
STEVENS pinza p. iris.	396
STEVENS tijera p. tendones.	59
STEVENSOM blefarostatos.	389
STIEGLITZ pinza de disección.	47
STILLE cinceles.	201
STILLE cizallas p. vendajes.	74
STILLE costotomos.	310
STILLE gubias.	201
STILLE perforadores óseos.	204,218
STILLE pinza p. pedunculo.	113
STILLE-LUER pinza-gubias.	249
STILLE-RUSKIN pinza-gubias.	249
STILLE-SHERMAN perforadores.	218
STONE pinza.	133
STONE-WATT pinza.	133
STRAUSS compresores uretrales.	325
STRUEMPPEL pinza.	407
STRUYCKEN pinza cort. Nasales.	418
SWEET pinza aplicadoras.	273
T	
TABB cuchillos.	411
taladros filiformes KIRSCHNER.	266
tambores p. est. SCHIMMELBUSCH.	378
TARNIER cranioclasto.	364
TARNIER forceps obstétricos.	364
tarros.	375
TAYLOR pinza de disección.	46
TAYLOR separadores espinales.	260
TEALE pinza p. coger el cuello del útero.	127
tensor cierra-hilos DEMEL.	262
tensor cierra-hilos LOUTE.	204
TESSIER separadores.	440
THOMAS curetas uterinas.	360
THOMSON-WALKER separadores.	323
THOREK tijera p. thorax.	62
THUDICHUM espejuelos nasales.	415
TIECK-HALLE espejuelos nasales.	414
tijera auriculares micro.	407
tijera auriculares micro BELLUCCI.	408
tijera auriculares micro COS.	407
tijera auriculares micro GREVEN.	407
tijera auriculares micro HAUGH.	407
tijera auriculares micro JUERS.	407
tijera auriculares micro McGEE.	407
tijera auriculares micro ovale.	407
tijera auriculares micro SHEA.	408
tijera BRAUN STADLER.	72
tijera de disección LEXER.	60
tijera de disección LEXER-BABY.	57
tijera de disección MAYO.	56
tijera de disección METZENBAUM.	55,57
tijera laparoskopie.	2,3,4,5,6
tijera enterótomos.	59
tijera ginecológicas DOYEN.	72
tijera ginecológicas KELLY.	60
tijera ginecológicas SIMS.	60
tijera ginecológicas WERTHEIM.	61
tijera IRIS.	56
tijera KLINKENBERG-LOTH.	62
tijera nasal FOMON.	59
tijera nasal HEYMANN.	56
tijera nasales COTTLE.	63
tijera p. alambre UNIVERSAL.	58
tijera p. amígdalas BOETTCHER.	56
tijera p. amígdalas GOOD.	343
tijera p. cartilaguas MC INDOE.	62
tijera p. cirugía.	54-62
tijera p. cirugía FOMON.	59
tijera p. cirugía JOSEPH.	58
tijera p. cirugía KILNER.	56
tijera p. cirugía REYNOLDS.	58
tijera p. coronas BEEBEE.	59
tijera p. encias GOLDMAN-FOX.	59
tijera p. encias LOCKLIN.	82
tijera p. encias WAGNER.	60
tijera p. ligaduras LITTAUER.	58
tijera p. ligaduras SPENCER.	58
tijera p. lobectomía CRAFOORD.	62
tijera p. neuro TOENNIS-ADSON.	62
tijera p. neurocirugía STRULLY.	62
tijera p. oculares BARRAQUER.	401
tijera p. oculares NOYES.	401
tijera p. oculares WEAVER.	401
tijera p. oculares WESTCOTT.	67
tijera p. oftalmología.	57
tijera p. septum KILLIAN.	297
tijera p. strabismo.	58
tijera p. tendones STEVENS.	59
tijera p. thorax SATINSKY.	62
tijera p. thorax THOREK.	62
tijera p. unás.	370,371
tijera p. vendajes BERGMANN.	72
tijera p. vendajes BRUNS.	72
tijera p. vendajes ESMARCH.	72
tijera p. vendajes KNOWLES.	72
tijera p. vendajes LISTER.	72
tijera p. vendajes EXCENTER.	62
tijera p. vendajes SEUTIN.	61
tijera p. vendajes SMITH US ARMY.	61
tijera p. vendajes TC BRUNS.	82
tijera p. vendajes TC LISTER.	82
tijera p. vendajes UNIVERSAL.	58,72
tijera SYSTRUNK.	61
tijera umbilicales BUSCH.	61
tijera umbilicales SCHUMACHER.	61
tijera umbilicales US MODEL.	61
tijera vasculares.	63-65
tijera vasculares DEBAKEY.	64
tijera vasculares DIETRICH.	64
tijera vasculares FAVALORD.	64
tijera vasculares POTTS-SMITH.	64
tijera WALDMANN.	60
tirabuzón p. fibromas DOYEN.	344
tiradores BARTON.	364
tiradores BILL.	364
tiradores LUIKART-BILL.	364
tira-lenguas pinza COLLIN.	102,435

tira-lenguas pinza YOUNG	102,435
TISCHLER pinza p. biopsia.	1,351
TOBOLD abaja-lenguas	430
TOENNIS descoladores	275
TOENNIS pinza hemostática.	110
TOHOKU pinza de campos.	127
tonometro SCHIOETZ	388
torniquete neumático	202
torniquetes RUMEL-BELMONT	165
transformador eléctrico.	16
traqueales WAGENER-MOSHER	171
transformador	16
TRELAT espéculos vaginales	336
trépanos cutáneos juego KEYES	368
trócares COAKLEY	284
trócares DOUGLAS.	284
trócares LICHTWITZ	284
trócares NELSON	283,284
trócares PIERCE	284
trócares thorax NELSON.	283
trócares thorax OCHSNER	283
trócares traqueales UCKERMANN	170
TROELTSCH pinza auriculares	47
TROEMNER martillos de percusión	15
TROUTMAN rompe-hojas	41
TUBBS dilatadores de aorta	165
tubo de aspiración BABY-YANKAUER.	17
tubo de aspiración COOLEY.	17
tubo de aspiración YANKAUER	17
tubos de aspiración POOLE	17
tubos de aspiración ADSON.	279
tubos de aspiración BARON.	279
tubos de aspiración FRAZIER.	17
tubos de aspiración HOUSE	281
tubos de aspiración PLESTER	17
tubos de aspiración ROSEN	281
tubos de aspiración YASARGIL	280
tubos de aspiración ZÖLLNER	280
tubos pinza p. HOFFMANN	341
tubos pinza p. SIMPLEX	341
TUFFIER pinza hemostática	102
TUFFIER separadores	317
TURNBULL alicates corta-unas	370
TURREL pinza p. biopsia	304
TYDING pinza p. coger amígdalas	438

U

UCKERMANN porta-algodon	412
UCKERMANN trócares traqueales	170
ULRICH pinza p. huesos.	257
ULRICH pinza p. polipos.	119
umbilical clamp COLLIN	365
umbilical clamp KANE.	365
umbilicales tijera US MODEL	61
unas tijera p.	370-371
UNIVERSAL pinza p. esterilización	369
UNIVERSAL tijera p. alambre	58
UNIVERSAL tijera p. vendajes	72
UNNA saca comedones	368
US MODEL tijera umbilicales	61
USA pinza de disección	46
US ARMY separadores.	187
uterinas curetas BLAKE	346
uterinas curetas SIMON	290

V

VAN DOREN pinza p. biopsia.	298
VANNAS tijera micro.	401

VERBRUGGE pinza p. huesos	255
VIENNA especulos nasales.	414
VIRCHOW cuchillo p. resección	11
VIRTUS pinza de disección.	48
VOLKMANN cucharillas cortantes	289
VOLKMANN separadores	176-177
VOLKMANN separadores	185
VOLTOLINI especulos nasales	415
VU-MOORE espéculos vaginales	334

W

WAGENER ganchitos	406
WAGENER-MOSHER traqueales	171
WAGNER tijera p. encias	60
WALDMANN tijera.	60
WALLICH cucharillas p. aborto.	366
WALSHAM pinza p. enderezar el tabique	420
WALTON saca comedones.	368
WARTENBERG sensimetro	14
WATSON-CHEYNE elevadores.	269
WATSON-WILLIAM pinza nasales	422
WEBER asas	395
WEBER pinza clamp p. aorta	153
WECKER espátulas.	393
WECKER tijera p. oculares	401
WEEK blefarostatos	389
WEIL-BLAKESLEY pinza nasales	416
WEITLANER separadores	229
WERTHEIM pinza p. histerectomia.	126
WERTHEIM tijera ginecológicas	61
WEST cinceles nasales	425
WESTCOTT tijera p. oculares	61
WESTON cierre-nudos rectal	304
WHEELER espátulas p. ciclode	394
WHITE pinza p. coger amígdalas	437
WIENER escofina nasal.	426
WIGMORE sierras p. yesos.	74
WILDE cierranudos	406
WILDE polipotomos	420
WILDER asas.	395
WILDER dilatadores lacrimal.	394
WILLIAMS blefarostatos	389
WILLIGER cucharillas cortantes	286,289
WILLIGER martillo	210
WILLIGER periostótomos	206
WINTER pinza p. aborto	365
WITTNER pinza p. biopsia	307
WOLFF pinza p. separar yesos.	74
WULLSTEIN mango de aspiración	405
WYLIE dilatadores uterinos.	343

Y

YANKAUER tubo de aspiración	17
YASARGIL hook	270
YASARGIL pinza p. tumores.	52
YASARGIL tubos de aspiración	280
YEOMAN pinza p. biopsia.	304
YEOMAN pinza p. biopsia rectal.	296
YOUNG pinza p. coger prostata.	324
YOUNG pinua tira-lenguas	435
YOUNG separadores	324

Z

ZAUFAL-JANSEN pinza-gubias	249
ZENKER pinza hemostática	109

ZENKER separadores	183
ZIEGLER blefarostatos	389
ZIEGLER cuchillos p. disección	391
ZIEGLER espejo frontal.	16
ZIELKE gubias.	200
ZÖLLNER tubos de aspiración	280

A

abbassalingua ANDREW	430
abbassalingua BRUENINGS	430
abbassalingua BUCHWALD	430
abbassalingua DAVIS-BOYLE	434
abbassalingua DINGMANN	432
abbassalingua FRENZEL	430
abbassalingua HARTMANN	430
abbassalingua KILNER-DOUGHTY	433
abbassalingua KROENIG	432
abbassalingua MAYO	432
abbassalingua MORITZ-SCHMIDT	435
abbassalingua TOBOLD	430
ABRAHAM coltello p. tonsille	439
ADSON divaricatore	226,227
DSON periototomo	269
ADSON pinza emostatica	106
ADSON pinza p. dissezione	44-45
ADSON pinza p. ipofisi	277
ADSON tubi aspirazioni	279
ADSON uncini p. dura-madre	261
ADSON-BABY divaricatore	226
ADSON-BABY pinza emostatica	106
aghi p. legature DESCHAMPS	99
aghi p. legature KRONECKER	100
aghi p. legature NELSON	100
aghi REVERDIN	96
aghi YOUNG-BOOMERANG	96
ago BARBARA	413
ago curve tagl. ROSEN	411
ago elettrochirurgia mini	383
ago guida REDON	447
ago OBWEGESER	440
ago p. autopsia	263
ago p. paracentesi LUCAE	405
ago p. paracentesi POLITZER	405
ago p. tonsille CLAUS	439
ago p. tonsille CLAUS-EICKEN	439
ago p. tonsille DUPUY-WEISS	439
ago p. tonsille NAGER	439
ago p. tonsille TRELAT	439
agraffe in argento SILVER	273
agraffe MICHEL	97
ALAN-PARKS dilatatori p. l'ano	328
ALEXANDER periototomo	206
ALEXANDER scalpello	196
ALEXANDER sgorbie	196
ALLEN pinza p. appendice	132
ALLIS pinza p. affer. Intest	121
ALLISON spatole p. polmone	310
allungo tubo BRUENINGS	302
ALM divaricatore	229
Alu divaricatore COOLEY	315,317
Alu FINOCCHIETTO divaricatore	313
amniotomo BEACHAM	350
ANDERSON-ADSON divaricatore	226
ANDREW abbassalingua	430
anelli serie p. MEAD	210
anello di protezione LANGENBECK	431
anoscopo HIRSCHMANN	332
anoscopo IVES-FANSLER	332
anse BILLEAU	405
anse SNELLEN	395
anse WEBER	395
anse WILDE	395
antrum curette COAKLEY	428
ANVIL tronchesine p. unghie stainless	371
apparecchio di compressione	202
approssimat costali BAILEY	310
approssimat costali BAILEY-BABY	310
approssimat costali BAILEY-GIBBON	310

approssimatori BIEMER-MUELLER	466
approssimatori MUELLER	467
Approximator BIEMER	469
apribocca compl. DAVIS-BOYLE	434
apribocca compl. DINGMANN	432
apribocca compl. KILNER-DOUGHTY	433
apribocca compl. MC IVOR	433
apribocca DOYEN-JANSEN (MOLT)	434
apribocca HEISTER	435
apribocca JENNINGS	434
apribocca MC IVOR	433
apribocca ROSER-KOENIG	435
apribocca solo DAVIS-BOYLE	434
apribocca solo DINGMANN	432
apribocca solo KILNER-DOUGHTY	433
apribocca DENHART	435
ARCHER pinza p. schegge	47
archi p. estensione BOEHLER	205
archi p. estensione KIRSCHNER	204
Arthroskopie	446
ARMY forbici garza SMITH US	61
ARRUGA blefarostati	388
ARRUGA pinza capsulare	399
ARRUGA port'aghi	90
ARRUGA protettori	393
ASCH pinza p. la plastica	420
aspiratore p. capsule DASTOOR	396
assordatore BARANY	404
astuccio p. autopsia	75
astuccio p. varici NABATOFF	232
atrauma pinza emostatica	131
atrauma pinza intest. DOYEN	130
atrauma pinza intest. KOCHER	130
atrauma pinza p. anast. HAYES	133
AUFRIEDT uncino nasale	428
AUVARD specolo vaginale	339
AYER pinza p. calazio	399

B

BABCOCK pinza p. affer. int.	121
BABINSKY martello p. cussione	15
BABY-TISCHLER pinza b. biopsia	351
bacinelle	375
bacinelle p. compresse	377
bacinelle rondo	376
bacinelle rondo opaco	376B
BACKHAUS pinza fissateli	127
BACKHAUS-CLIP pinza fissateli	127
BAILEY approssimat costali	310
BAILEY-BABY appross. costali	310
BAINBRIDGE pinza emostatica	108
bajonet pinza auricol. LUCAE	47,406
BAKES sonda p. calcoli biliari	122
BALFOUR divaricatore addom	235,240
BALLENGER coltello p. setto	423
BALLENGER elevatore p. setto	421
BALLENGER pinza p. tonsille	438
BARACANI inserto	302
BARANY assordatore	404
BARBARA ago	413
BARBARA uncinetto	413
BARNHILL coltello adenoide	429
BARON tubi aspirazione	279
BARR specoli rettali	329
BARRAQUER blefarostati	388
BARRAQUER forbici oculistiche	401
BARRAQUER Mikro-port'aghi	90
BARRAQUER pinza p. iride	398
BARRAQUER port'aghi	90
BARRET pinza p. abbassare	347

BARTON forcipe	364
BARTON trattore	364
BAUMGARTNER port'aghi	89,94
BEACHAM amniotomo	350
BECKMANN coltello adenoide	429
BECKMANN divaricatore	227
BECKMANN-EATON divaricatore	227
BEEBEE forbici a corona	59
BEER pinzaipalatorie	400
BELLUCCI forcipe auric. Micro	408
BENGOLEA pinza emostatica	118
BENNETT elevatori p. ossa	259
BENSON divaricatore p. piloro	132
BERGMAN martello	211
BERGMANN forbici p. bendaggi	72
BERRY wire twisting forceps	223
BETHUNE costotomo	311
BEYER pinza sgorbie	246,249
bicchieri graduato	377
bicchieri p. medicinali	375,377
BIEMER Approximator	469
BIEMER pinza p. applicare	464,467
BIEMER pinza p. applicare	469
BIEMER-MUELLER approssimatori	466
BILLEAU anse	405
Biopsiezg. TISCHLER-MORGAN	1,351
BISHOP-HARMAN pinza p. iride	398
bisturi con manico di metallo	37-40
bisturi corneale ELSCHNIG	390
bisturi KOOS	278
bisturi manici	37-40
bisturi monouso sterili	38
bisturi p. capsule KNAPP	391
bisturi p. capsule ZIEGLER	391
bisturi p. fibromi SEGOND	344
BLAKE curette uterini	346
BLAKE pinza p. calcoli bil	123
blefarost. MELLINGER-AXENFELD	388
blefarostati ARRUGA	388
blefarostati BARRAQUER	388
blefarostati BOWMAN	388
blefarostati CASTROVIEJO	389
blefarostati CLARK	388
blefarostati CRITCHETT	388
blefarostati GRAEFE	388
blefarostati LANCASTER	389
blefarostati LISTER-BURCH	389
blefarostati MELLINGER	388
blefarostati MUELLER	389
blefarostati MURDOCK	389
blefarostati PARK	389
blefarostati SMITH	389
blefarostati STEVENSON	389
blefarostati WEEK	389
blefarostati WILLIAMS	389
blefarostati ZIEGLER	389
BLOHMKE pinza p. tonsille	438
BLOUNT elevatori p. ossa	260
BLUMENTHAL pinza sgorbie	245
BODENHAMMER specoli rettali	328
BOEHLER archi p. estensione	205
BOEHLER cesoie p. ossa	252
BOEHLER pinza sgorbie	247
BOERMA forcipe	364
BOETTCHER forbici p. tonsille	56
BOIES periototomo	206
BONNEY pinza p. dissezione	45
BOSE gancio p. tracheotomia	170
BOWMAN blefarostati	388
BOWMAN specillo p. can. Lacrim	394
BOZEMAN p. tampone	119
bracciale	202

BRAND strum. p. afferare	272	cesoie p. ossa MC INDOE	252	coltello p. meniscus SMILLIE	271
BRAUN cranioclasto	366	cesoie p. ossa RUSKIN-LISTON	253	coltello p. meniscus NEFF	271
BRAUN pinza p. abbassare	347	cesoie p. ossa SEMB	252	coltello p. resezione	12
BRAUN uncino p. detroncazione	366	cesoie p. ossa STILLE-HORSLEY	252	coltello p. resezione LANGENBECK	12
BRAUN pressorti uterini	350	cesoie p. ossa STILLE-LISTON	253	coltello p. setto BALLENGER	423
BRAUN-STADLER forbici ginecologiche	72	cestello	378	coltello p. setto FREER	423
BREISKY specolo vaginale	340	CHAPUT pinza emostatica	102	coltello p. tonsille ABRAHAM	439
BRUENINGS abbassalingua	430	CHARRIERE seghe p. amputazione	194	coltello p. tonsille BRUENINGS	439
BRUENINGS coltello p. tonsille	423,439	CHEATLE pinza p. sterilizz.	369	coltello p. tonsille CARPENTER	436
BRUENINGS inserto	302	CHELSEA-EATON proctoscopi	332	coltello p. tonsille DOUGLAS	439
BRUENINGS specoli auric. Serie	404	cheratomi CASTROVIEJO	392	coltello p. tonsille FISHER	439
BRUENINGS specoli auricolari	404	cheratomi GRAEFE	390	coltello PLESTER	411
BRUENINGS tubo allungo	302	cheratomi JAEGER	392	coltello ROSEN	411
BRUNETTI scalpello	263	cheratomi WECKER	392	coltello SCHUKNECHT	411
BRÜNINGS serranodi p. tonsille	420	cheratomi ZIEGLER	391	coltello ST. CLAIR-THOMSON	429
BRUNNER costotomo	311	CHERON pinza p. tampone	120	coltello TABB	411
BRUNNER divaricatore	180-187	CHERRY divaricatore p. lamin.	318	coltelle gessati ESMARCH	74
BRUNNER pinza intestinali	131	CHILDE pinza p. agraffe	97	coltelle gessati HOPKINS	74
BRUNNER sonde conduttrici	100	cilindrici recipienti	375	coltelle gessati REINER	74
BRUNS curette taglienti	287,290	CINELLI Septum scalpello	424	COLVER pinza p. tonsille	437
BRUNS forbici p. bendaggi	72	CITELLI pinza osteotomo	419	comedoni schiaccia SAALFELD	368
BRYANT pinza p. spugne	120	CLAR fascia metallica solo	16	comedoni schiaccia SCHAMBERG	368
BUCHWALD abbassalingua	430	CLARK befarostati	388	comedoni schiaccia UNNA	368
BUCK curette	405	CLAUS ago p. tonsille	439	comedoni schiaccia WALTON	368
BUCK leve p. corpi estranei	406	CLAUS-EICKEN ago p. tonsille	439	concave tronchesine p. unghie	370
BUCK martello p. cussione	15	CLEVELAND pinza sgorbie	244	conduttore MARTEL	134,270
BUIE cannula d'aspirazione	304	clip emostatica RANEY	274	conduttrici sonde BRUNNER	100
bulldog pinza DE BAKEY-DIETH	143	CLOWARD divaricatore completo	230	conduttrici sonde KIRSCHNER	99
bulldog pinza mini DIETHRICH	143	CLOWARD divaricatori	282	conduttrici sonde KOENIG	99
bulldog pinza	140	CLOWARD pinza taglienti	299	conduttrici sonde PAYR	100
BUMM curette uterini 28cm	358	COAKLEY curette antrum	428	conduttrici sonde SCHMIEDEN	99
BUNELL chiave solo p.	224	COAKLEY trequarto antrum	284	conduttrici sonde SCHMIEDEN-PAYR	99
BUNELL guida p. tendine	272	COBB scalpello	199	conduttrici sonde VIENN	100
BUNELL perforatore a mano	224	COBB sgorbie	199	CONVERSE coltello nasale	423
BUNT pinza p. sterilizzazione	369	COLCLOUGH pinza taglienti	294	COOLEY cannula p. aspirazione	17
BUREN tenaglie p. ossa VAN	255	COLLIN dinamometro	14	COOLEY dilatatori vascolari	165
BURKE pinza tagl. P. biopsia	305	COLLIN divaricatore addom.	232,238	COOLEY divaricatore	316,317
BUSCH forbici ginecologiche	61	COLLIN isterometro	341	COOLEY divaricatore Alu	315
		COLLIN martello	210	COOLEY divaricatori	182
		COLLIN pelvimetro	346	COOLEY pinza atraumatiche	161
		COLLIN pinza emostatica	102	COOLEY pinza p. la carotide	161
		COLLIN pinza ombelicale	365	COOLEY-NEONATAL divaricatore	317
		COLLIN pinza p. afp. l'utero	137,349	CORDES inserto	302
		COLLIN pinza p. agraffe	97	CORWIN compressore p. tonsille	439
		COLLIN pinza p. tampone	120	CORYLLOS costotomo	311
		COLLIN pinza tiralingua	102,435	CORYLLOS divaricatore	189
		COLLIN specolo vaginale	335,336	COS pinza auricolari micro	407
		COLLIN-DUVAL pinza	46	costotomo	310
		coltello adenoide BARNHILL	429	costotomo BETHUNE	311
		coltello adenoide BECKMANN	429	costotomo BRUNNER	311
		coltello adenoide LA FORCE	429	costotomo CORYLLOS	311
		coltello auricolari POLITZER	405	costotomo GIERTZ-STILLE	311
		coltello auricolari SEXTON	405	costotomo GLUCK	310
		coltello CREDO	371	costotomo SAUERBRUCH	311
		coltello FREER	423	costotomo SAUERBRUCH-FREY	311
		coltello interosseo	10	costotomo STILLE	310
		coltello MUCK	413	COTTLE elevatore	421
		coltello nasale CONVERSE	423	COTTLE forbici nasale	63
		coltello nasale COTTLE	425	COTTLE martello piano/convex	211,213
		coltello nasale JOSEPH	425	COTTLE scalpello	424
		coltello p. amputazione	10,11,12	COTTLE uncinetto di pelle	428
		coltello p. amputazione CATLIN	10,11,12	COTTLE uncino nasale	428
		coltello p. amputazione		CRAFOORD forbici polmonari	62
		LANGENBECK	10,12	CRAFOORD pinza emostatica	110
		coltello p. amputazione LISTON	10,12	cranioclasto BRAUN	366
		coltello p. cartilagini	11	cranioclasto TARNIER	364
		coltello p. cartilagini VIRCHOW	11	CREDO coltello	371
		coltello p. cataratta	390,392	CREGO elevatore	269
		coltello p. cataratta GRAEFE	390	CRILE divaricatori	185
		coltello p. cataratta DEUTSCHMANN		CRILE pinza emostatica	104
		390 coltello p. falan-		CRILE port'aghi	89
		gi	10,12	CRILE RANKIN pinza emostatica	104
				CRILE WOOD port'aghi	87,94

C

candelette dilatatrice GUYON	322
candelette dilatatrice VAN BUREN	322
cannula CHEVALIER-JACKSON	171
cannula d'aspirazione BUIE	304
cannula KILLIAN	420,422
cannula p. aspirazione BABY YANKAUER	17
cannula p. aspirazione COOLEY	17
cannula p. aspirazione POOLE	17
cannula p. aspirazione YANKAUER	17
cannula p. trach. WAGENER-MOSHER	171
cannula RITTER-HALLE	422
cannula SIEBENMANN	422
cannula tracheali LUER arg.	171
cannula WATSON-WILLIAMS	422
CAROLL strumenti p. afferare	272
CARPENTER coltello p. tonsille	436
CASPAR divaricatore	231,233
CASTANEDA pinza p. neonati	163,164
CASTROV.-MICRO port'aghi	88,95
CASTROVIEJO cheratomi	392
CACTROVIEJO forbici iridect	401
catetero SCHULTZE	345
catetero HARTMANN	405
CATLIN coltello p. amputazione	10
cavo bipolare	386
centrale valve con fibre	323
cesoie p. app.gessati STILLE	74
cesoie p. ossa BOEHLER	252
cesoie p. ossa COTTLE-KAZANJIAN	253
cesoie p. ossa LISTON	253

CRITCHETT blefarostati	388
CRUTCHFIELD pinza p trazione	274
CRUTCHFIELD trapano	274
cucchiai p. calazio MEYHOEFER	395
cucchiai p. calc. FERGUSSON	124
cucchiai p. calc. LUER-KOERTE	124
cucchiai p. calc. bil. DESJARDINS	125
cucchiai p. calc. bil. MAYO	125
cucchiai p. palpebre DAVIEL	395
cucchiai p. palpebre GRAEFE	395
cucchiai p. palpebre KNAPP	395
cucchiaio ostetrico SELLHEIM	366
cucchiaio p. medicinali	377
CULLER spatole	393
curette antrum COAKLEY	428
curette BUCK	405
curette d'aspir. MÜNCHEN	350
curette d'aspirazione HEANY	350
curette d'aspirazione NOVAK	344
curette d'aspirazione RANDALL	344
curette die aspirazione	361
curette HOUSE	413
curette p. aborto CUZZI	365
curette p. aborto PESTALOZZA	365
curette p. aborto WALLICH	366
curette p. ipofisi	277
curette p. lupus FOX	368
curette p. lupus PIFFARD	368
curette tagliente FAULKNER	428
curette taglienti	286
curette taglienti BRUNS	287,290
curette taglienti DAUBENSPECK	286
curette taglienti HALLE	288
curette taglienti JACOBSON	287
curette taglienti JANSEN	287
curette taglienti LEMPERT	290
curette taglienti MARTINI	289
curette taglienti SCHEDE	290
curette taglienti SCOVILLE	288
curette taglienti SPRATT	289
curette taglienti VOLKMANN	289
curette taglienti WILLIGER	289
curette uterini BLAKE	346
curette uterini BUMM	358
curette uterini RECAMIER	358,359
curette uterini SIMS	358
curette uterini THOMAS	360
CUSCO specolo vaginale	335,392
CUSHING divaricatore	184,188
CUSHING spatole cerebrali	279
CUSHING uncini p. nervi	261
CUZZI curette p. aborto	365
cystotomo GRAEFE	393
CZERNY specoli rettali	328
CZERNY pinza uterini	348

D

DANDY pinza emostatica	107
DANDY uncini p. nervi	261
DARLING divaricatore	230
DARTIGUES pinza p. afp.l'utero	137,149
DASTOOR pinza p. strabismo	396
DAUBENSPECK curette taglienti	286
DAVIEL cucchiai p. palpebre	395
DAVIS scollatori p. duramadre	275
DAVIS-BOYLE abbassalingua	434
DAVIS-BOYLE apribocca solo	434
DE BAKEY divaricatore	316
DE BAKEY pinza atraumatiche	148,149
DE BAKEY pinza atraumatiche	151,152

DE BAKEY pinza atraumatiche	153,160
DE BAKEY pinza atraumatiche	154,159
DE BAKEY pinza atraumatiche	157,158
DE BAKEY pinza p. coartazione	140,147
DE BAKEY dilatatori vascolari	166
DE BAKEY-MOSQUITO pinza atrauma	146
DE BAKEY-PEAN pinza atrauma	146
DE BOER divaricatore	316
DE MARATEL-WOLFSON serrapinza	134
DE MARTEL-WOLFSON pinza	134
DEAN forbici p tonsille	63
DEAVER divaricatori	190
DEJERINE martello p cussione	15
DEMEL aghi passafili	262
DEMEL strumento tendifili	262
DENHART apribocca	435
DENIS-BROWNE anillo solo	242
depressore p. epigl. REICHERT	297
depressori uterini BRAUN	350
depressori uterini SIMS	350
DERF port'aghi	89,94
dermatomo HUMBY	12
dermatomo SCHINK	12
DERRA pinza atraumatiche	148
DESCHAMPS aghi p. legature	99
DESJARDINS cucchiai p. calc. bil.	122
DESJARDINS pinza emostatica	112
DESMARRES divaricatore	184,390
DESMARRES pinza p. calazio	399
DeVILBIS	275
diapason completo HARTMANN	402,403
diapason HARTMANN	402,403
diapason LUCAE	402
diapason neurol. con martello	402
diapason RYDEL-SEIFFERT	402
DIEFFENBACH pinza serrafina	48
DIETRICH forbici vascolari	64
DIETRICH pinza p. aorta	161
dilat. trach. TROUSSEAU	170
dilatatore p. sacco lacr. WILDER	394
dilatatori p. l'ano ALAN-PARKS	328
dilatatori p. l'ano SMITH-BUIE	329
dilatatori p. trach. LABORD	170
dilatatori p. trach TROUSSEAU	170
dilatatori uterini doppio HEGAR	341
dilatatori uterini GOODELL	343
dilatatori uterini HANK	342
dilatatori uterini HEGAR	341,342
dilatatori uterini PRATT	342
dilatatori uterini SIMS	343
dilatatori uterini WYLIE	343
dilatatori vascolari DE-BAKEY	166
dilatatori vascolari COOLEY	165
dilatatori vascolari TUBBS	165
dilatatrice candelette GUYON	322
dilatatrice candelette VAN BUREN	322
dinamometro COLLIN	14
DINGMANN abbassalingua	432
DINGMANN divaricatore	432
DINGMANN periototomo	440
dissettore HURD	436
distributore p. spazzolini d. 10	379
distributore p. spazzolini d. 20	379
divaricatore addom DENIS-BROWN	242
divaricatore addom. BALFOUR	235,240
divaricatore addom. COLLIN	232
divaricatore addom. DOYEN	236
divaricatore addom. FRAZIER	239
divaricatore addom. GOSSET	239
divaricatore addom KIRSCHNER	241
divaricatore addom. RICARD	237,238
divaricatore addom. ROCHARD	236

divaricatore ADSON	226,227
divaricatore ADSON-BABY	226
divaricatore ALM	229
divaricatore Alu FINOCCHIETTO	312,314
divaricatore ANDERSON-ADSON	226
divaricatore BALFOUR-BABY	235,240
divaricatore BECKMANN	227
divaricatore BECKMANN-EATON	227
divaricatore BRUNNER	180-187
divaricatore CASPAR	231,233
divaricatore COLLIN-LOKTITE	238
divaricatore completo CLOWARD	230
divaricatore completo HENLEY	228
divaricatore COOLEY	315,317
divaricatore COOLEY-NEONATAL	315
divaricatore CORYLLOS	189
divaricatore CUSHING	184,188
divaricatore DARLING	230
divaricatore DAVIDSON	188,189
divaricatore DE BAKEY	316
divaricatore DE BOER	316
divaricatore DINGMANN	432
divaricatore DOYEN	187
divaricatore FINOCCHIETTO	312,314
divaricatore FINOCCHIETTO-BABY	314
divaricatore FINOCCHIETTO- BURFORD	313
divaricatore FINSEN	229
divaricatore FRITSCH	187
divaricatore GIL-VERNET	184
divaricatore HAIGHT	317
divaricatore HEANEY	177
divaricatore HOESEL	180
divaricatore HOFER	436
divaricatore ISRAEL	188
divaricatore JANSEN	229
divaricatore KELLY	190
divaricatore KOCHER	178,192
divaricatore KOCHER	186,187
divaricatore KOERTE	188
divaricatore LAHEY	178
div. laminect. completo CHERRY	318
divaricatore LITTLE	178
divaricatore LOVE	436
divaricatore MEYERDING	179,191
divaricatore MEYERDING	233
divaricatore MIKULICZ	192
divaricatore MOLLISON	230
divaricatore MORSE	312
divaricatore MORSE-FAVALORO	312
divaricatore NAGER	436
divaricatore OBWEGESER	442,443
divaricatore OLLIER	187
divaricatore p. guancie STERNBERG	430
divaricatore p. labbra	430
divaricatore p. lamin. CHERRY	318
divaricatore p. torace MERCEDES	319
divaricatore pelvico ST MARKS	181
divaricatore PLESTER	228
divaricatore RAMUS	440-443
divaricatore RIENHOFF-FINOCCHIETTO	316
divaricatore SAUERBRUCH	189
divaricatore SCOVILLE-AVERFIE	234
divaricatore SENN-GREEN	178
divaricatore SIMON	192
divaricatore TESSIER	440
divaricatore tiroide SCHÖNBORN	173
divaricatore TUFFIER	317
divaricatore vesc. JUDD-MASSON	323
divaricatore vesc. MILLIN	323
divaricatore vesc. THOMSON-WALKER	323
divaricatore vescicale LEGUE	323

divaricatore vescicale MILLIN 323
divaricatore VOLKMANN 176,177
divaricatore VOLKMANN 185
divaricatore WEITLANER 229
divaricatore YASARGIL 270
divaricatore YOUNG 324
divaricatore ZENKER 183
divaricatore O'SULLIVAN-O'CON. 336
divaricatori addom. HABERER 190
divaricatori addom. REVERDIN. 190
divaricatori addom. RIBBON. 190
divaricatori CLOWARD 282
divaricatori COOLEY 182
divaricatori CRILE 185
divaricatori doppio GOELET 185
divaricatori doppio MATHIEU 186
divaricatori doppio ROUX 186
divaricatori doppio US-ARMY. 187
divaricatori double SENN-MILLER 178
divaricatori FARABEUF 186
divaricatori GELPI 232
divaricatori HABERER. 190
divaricatori HARRINGTON 191
divaricatori KELLY GRIP 190
divaricatori PARKER 185,186
divaricatori RAGNELL 185
divaricatori RIBBON 190
divaricatori RICHARDSON 186,190
divaricatori RICHARDSON GRIP. 190
divaricatori RICHARDSON-EASTMAN 186
divaricatori RIGBY 232
divaricatori ROUX-BABY 185
divaricatori ROUX-MINI 185
divaricatori serie ROUX 186
DIX scalpello p. corpi estr. 394
DOUGLAS pinza deiplatorie 400
DOUGLAS trequarto antrum 284
DOYEN divaricatore 187
DOYEN divaricatore addom. 236
DOYEN periostotomo 208
DOYEN pinza intest. atrauma 130
DOYEN pinza p. affer. Int. 130
DOYEN sonda 15
DOYEN specolo vaginale 340
DOYEN tiramiomo 344
DOYEN-JANSEN apribocca (MOLT). 435
DUPLAY pinza p. abbassare 127,347
DUPUY-WEISS ago p. tonsille 439
DURANTE pinza p. dissezione 45
DUVAL pinza 46
DUVAL pinza p. affer. int. 130

E

ECHLIN pinza sgorbie 248
elevatore ADLERDYCE 269
elevatore COTTLE 421
elevatore CREGO 269
elevatore HENKE. 436
elevatore KEY 269
elevatore LEMPET 413
elevatore MC DONALD 269
elevatore p. ossa BLOUNT 260
elevatore p. ossa TAYLOR 260
elevatore p. setto 421-423
elevatore p. setto BALLENGER 421
elevatore p. setto COTTLE 421
elevatore p. setto FREER 421
elevatore p. setto JOSEPH. 421
elevatore p. setto KILLIAN 421,425
elevatore p. setto MC KENTY 421

elevatore WATSON-CHEYNE 269
elevatori p. ossa 259-260
elevatori p. ossa BENNETT. 259
elevatori p. ossa BLOUNT 260
elevatori p. ossa HOHMANN 258
elevatori p. ossa HOHMANN-MINI 258
elevatori p. ossa TAYLOR 260
elevatori p. ossa SMILLIE 260
ELLIOT forcipe 263
ELSÄSSER pinza p. nefrostomia 123
ELSCHNIG bisturi corneale 390
ELSCHNIG pinza p. fissaggio 397
ELSCHNIG spatole p. ciclod. 393
EMMET uncinio p. fistole 344
endospecolo KOGAN 341
ENGEL sega p. app. gessati 74
entropio pinza SNELLEN. 399
EPENDORFER pinza p. biopsia 305
ESMARCH coltelle gessati 74
ESMARCH forbici p. bendaggi 72
EVES serratodi p. tonsille 438

F

FELDHEIM 371
FANSLER proctoscopi 331
FARABEUF divaricatori 186
FARABEUF periostotomo 205
FARABEUF tenaglie p. ossa 254
FARABEUF-COLLIN periostotomo 205
FARRELLportacotone 412
FAULKNER curette tagliente 428
FAURE pinza p. itoneale 126
FAURE pinza tagl. P. biopsia 296
FAVALORO forbici vascolari 64
FEHLAND pinza intest. 131
FERGUSSON cucchiali p. calc. 124
FERRIS-SMITH pinza p. dissezione 46
FERRIS-SMITH-KERRISON pinza 293,294
FINOCCHIETTO divaricatore 312,314
FINOCCHIETTO pinza p. bronchi 128
FINOCCHIETTO port'aghi 89
FINOCCHIETTO-BURFORD divaricatore. 314
FINSEN divaricatore 229
FISCH uncinio 278
FISCHER pinza p. iride 399
FISH sonda 15
FISHER coltello p. tonsille 439
FOERSTER pinza p. iride 399
FOERSTER pinza p. spugne 119,12
FOMON forbici nasale 62
FOMON periostotomo 206
FOMON raspa nasale 426,427
FOMON scalpello 424
FOMON uncinetto di pelle 428
fonendoscopio PINARD 14
forbice ad asta tubolare micro 409,410
forbice auric. micro BELLUCCI 408
forbice auric. Micro SHEA 408
forbice p. la curalle unghie 370,371
forbici a corona BEEBEE 59
forbici fino IRIS 56
forbici fino JOSEPH 58
forbici fino KILNER 56
forbici fino REYNOLDS 58
forbici garza SMITH US ARMY 61
forbici gengivali GOLDMAN-FOX 59
forbici gengivali WAGNER 60
forbici ginecologiche BRAUN-STADLER 72
forbici ginecologiche BUSCH 61
forbici ginecologiche DOYEN 72

forbici ginecologiche KELLY 60
forbici ginecologiche SCHUMACHER. 61
forbici ginecologiche SIMS 60
forbici ginecologiche WERTHEIM 61
forbici iridectomia CASTROVIEJO 401
forbici iridectomia VANNAS 401
forbici KLINKENBERG-LOTH 62
forbici METZENBAUM *S* TC 79
forbici micro 66-69
forbici micro GOMEL 69
forbici micro HEPP-SCHIEDER 68
forbici nasale COTTLE 63
forbici nasale FOMON 59,62
forbici nasale HEYMANN 56
forbici neurochirurgia TOENNIS-ADSON 62
forbici neurochirurgia 62
forbici neurochirurgia STRULLY 62
forbici oculistiche BARRAQUER 401
forbici oculistiche NOYES 401
forbici oculistiche WECKER 401
forbici oculistiche WESTCOTT 61
forbici ombelicali USA 61
forbici ombelicali WALDMANN 60
forbici p. bendaggi BERGMANN 72
forbici p. bendaggi BRUNS 72
forbici p. bendaggi ESMARCH 74
forbici p. bendaggi KNOWLES 74
forbici p. bendaggi LISTER 72
forbici p. bendaggi SEUTIN 61
forbici p. bendaggi TC LISTER 82
forbici p. bendaggi UNIVERSAL 58
forbici p. chirurgia FOMON 62
forbici p. chirurgia STANDARD 54-61
forbici p. chirurgia SYSTRUNK 61
forbici p. dissez. JORGENSEN 57
forbici p. dissez. LEXER 60
forbici p. dissez. LEXER-BABY 57
forbici p. dissez. MAYO 56
forbici p. dissez. MAYO-STILLE 56
forbici p. dissez. METZENBAUM 55,57
forbici p. filo UNIVERSAL 58
forbici p. iris 56
forbici p. legature LITTAUER 58
forbici p. legature SPENCER 58
forbici p. ophtalmologia 57
forbici p. tenotomia STEVENS 59
forbici p. tonsille 56
forbici p. tonsille BOETTCHE 56
forbici p. tonsille GOOD 56
FOREGGER laringoscopio 23
FOX curette p. lupus 368
FRAENKEL inserto 302
FRAENKEL pinza p. polipi 297
FRAZIER divaricatore addom. 239
FRAZIER tubi aspirazione 279
FREER coltello 423
FREER elevatore p. setto 423
FREER scalpello 425
FREER scalpello p. plastica 423
FREER uncinetto di pelle 176
FRENZEL abbassalingua 430
FRIEDMANN pinza sgorbie 244
FRIEDMANN-MINI pinza sgorbie 244
FRIEDMANN specolo 339
FRITSCH divaricatore 187
FRYKHOLM pinza sgorbie 248

G

GASTROSKOPIE 445
GALLAHER raspa nasale 426

GELPI divaricatori	232
GEMINI pinza emostatica	109
GERALD pinza p. dissezione	44
GERSTER pinza p. ossa	204
GERZOG martello	210
GIERTZ-STILLE costotomo.	311
GIGLI manci p. segna	194
GILL pinza p. iride	398
GILL-HESS pinza p. iride	398
GILLIES pinza p. dissezione	45
GILLIES port'agi	88
GILLIES uncinetto di pelle.	428
GIL-VERNET divaricatore	184
GLOVER pinza atraumatiche	151
GLUCK costotomo	310
GOELET divaricatori doppio	185
GOLDMAN-FOX forbici gengivali	59
GOMEL forbici micro.	69
GOMEL pinza p. microchirurgia	50
goniometro MOELTGEN	14
GOOD forbici p. tonsille	56
GOODELL dilatatori uterini	343
GORNEY periostotomo	206
GOSSET divaricatore addom.	239
GRAEFE blefarostati	388
GRAEFE cheratomi	390
GRAEFE coltello p. cataratta	390
GRAEFE cucchiari p. palpebre.	395
GRAEFE cystotomo	391,393
GRAEFE pinza p. fissaggio	399
GRAEFE pinza p. iride	396
GRAEFE uncinetto	393
GRAEFE uncino p. il strabismo.	393
GRAHAM uncini p. nervi	261
GRASPER pinza p. biopsia	305
GRAVE specolo vaginale	335
GRAY pinza emostatica	112
GREVEN pinza auricolare micro.	407
GROSS-MAIER pinza p. tampone	119
GUTHRIE uncinetto	176,393
GUYON candelette dilatatrice.	322
GUYON pinza emostatica	113,131

H

HAEMORROIDAL ligat.	308
HABERER divaricatori	190
HAGLUND-STILLE	74
HAIGHT divaricatore	317
HAJEK martello	213
HAJEK pinza nasale	419
HAJEK scalpello	425
HAJEK-BALLENGER elevatore	421
HAJEK-KOFLER pinza osteotomo	419
HAJEK-KOFLER pinza taglienti.	417
Häkchen	413
HALLE curette taglienti	288
HALSEY port'agli	94
hand plaster spreader for one.	74
HANK dilatatori uterini.	342
HARKEN pinza auricola.	156
HARRINGTON divaricatori	191
HARRINGTON pinza p. bronchi.	128
HARTMANN cannula	422
HARTMANN catetero	405
HARTMANN diapason.	402,403
HARTMANN pinza	407
HARTMANN pinza auricolare	407
HARTMANN pinza emostatica	103,104
HARTMANN pinza nasale	418
HARTMANN pinza p. polipi.	415

HARTMANN pinza tagl. nasale	418
HARTMANN specoli auricolari	404
HARTMANN-HALLE specolo nasale.	414
HARTMANN-WULLSTEIN pinza	407
HAYES pinza atrauma p anast.	133
HEANEY divaricatore	177
HEANEY pinza p. isterectomia	115
HEANEY port'agli	89
HEANY curette d'aspirazione	350
HEATH martello.	213
HEGAR dilatatori uterini	340-341
HEGENBARTH pinza p. agraffe	97
HEISS pinza emostatica	117
HEISTER apribocca.	435
HENKE elevatore.	436
HENLEY divaricatore.	228
HENNIG	74
HEPP-SCHIEDL forbici micro.	68
HERKULES tenaglie tagliafilii.	216
HERRICK pinza emostatica	114
HESS pinza capsulare.	398
HESS pinza p. iride	398
HEYMANN forbici nasale	56
HIBBS scalpello	197
HIBBS sgorbie.	197
HIRSCHMANN anoscopo	332
HOEN scollatori p. duramide	276
HOESEL divaricatore.	180
HOESEL prot'agli	91
HOFER divaricatore.	436
HOFFMANN pinza serratubo	341
HOHMANN elevatori p. ossa	258,259
HOHMANN-MINI elevatori p. ossa	258
HOKE scalpello	197
HOLINGER laringoscopi	34
HOLSHER uncini p le radici	270
HOLTH pinza capsulari	396
HOPKINS coltelle gessati	74
HOUSE curette	413
HOUSE tubi aspirazione.	281
HUBER manico universale	302
HUDSON manico	219
HUKLA pinza	127,347
HUMBY dermatomo	12
HUNTER pinza p. schegge	47
HURD dissetto	436

I

inserto BARACANI	302
inserto BRUENINGS	302
inserto CORDES	302
inserto FLATAU	302
inserto FRAENKEL	302
inserto KRAUSE	302
inserto LANGE	302
inserto p. POLITZER	404
inserto SCHEINMANN.	302
inserto SCHUMACHER.	302
inserto SEIFERT	302
insoffiatore KABIERESKE	404
IOWA pinza	348
IRIS forbici fino	56
ISRAEL divaricatore	188
isterometro MARTIN	341
isterometro SIMS	341
ITERSON gancio p. tracheotomia.	170
IVES-FANSLER anoscopo	332
IUD-pinza	306
IRRIGATOR	377

J

JACKSON gancio p. tracheot.	170,171
JACKSON pinza	297
JACOBS perforatore a mano con.	219
JACOBS pinza p abbassare	348
JACOBS curette taglienti	287
JACOBSON port'agli	90
JACOBSON sonda bottonuta	278
JACOBSON sonda doppia	278
JACOBSON uncini p. dura-madre	278
JAEGER cheratomi	392
JAEGER placca p. palpebre	389
JAMESON uncino p. il strabismo	393
JANSEN curette taglienti.	287
JANSEN divaricatore.	229
JANSEN pinza p. orecchio	47,406
JARCHO pinza p. abbassare	347
JENNINGS apribocca	434
JOBSON-HORNE portacotone	412
JOHNS-HOPKINS pinza	48
JOHNS-HOPKINS pinza serrafina	48
JONES pinza fissateli	127
JONES-CLIP pinza fissateli.	127
JORGENSEN forbici p. dissez.	57
JOSEPH coltello nasale	423
JOSEPH forbici fino	58
JOSEPH periostotomo	206,421
JOSEPH raspa nasale	427
JOSEPH raspa nasale (LEWIS).	426
JOSEPH seghe nasale	428
JOSEPH uncinetto	176
JUDD-ALLIS pinza p. affer.int.	121
JUERS pinza auricolare micro	407
JURASZ pinza p. polipi.	297

K

KABIERESKE insoffiatore	404
KALLMORGEN specolo	339
KALLMORGEN valve.	339
KANE pinza ombelicale.	365
KELLY divaricatore	190
KELLY divaricatori GRIP	192
KELLY forbici ginecologiche.	60
KELLY pinza emostatica	103
KELLY protoscopo	332
KELLY-RANKIN pinza emostatica	103
KERN tenaglie p. ossa	254
KERRISON pinza taglienti.	419
KEVORKIAN curette d'aspiraz	298
KEVORKIAN punto solo	1
KEY elevatore	269
KEYES trefine cutanee	368
KIELLAND forcipe	363
KIELLAND-LUIKART forcipe.	363
KILLIAN cannula	420-422
KILLIAN elevatore p. setto	421
KILLIAN specolo nasale	414
KILLIAN-CLAUS scalpello.	425
KILNER forbici fino	56
KILNER port'agli.	88
KILNER uncino cutanei.	368
KILNER-DOUGHTY abbassalingua.	433
KILNER-DOUGHTY apribocca solo	433
KIRK martello	210
KIRSCHNER archi p estensione.	204
KIRSCHNER divaricatore addom.	241
KIRSCHNER fili p perforatori	266
KIRSCHNER sonde conduttrici.	99
KIRSCHNER telaio rigido	241

KLEINERT-KUTZ pinza sgorbie	246	leve p. corpi estranei BUCK	406	martello p. cussione BABINSKY	15
KLEINERT-KUTZ strumento p. afferare .	272	leve p. corpi estranei QUIRE	406	martello p. cussione BUCK	15
KNAPP bisturi p. capsule	391	LEWIN tenaglie p. ossa	256	martello p. cussione TAYLOR	15
KNAPP cucchiai p. palpebre	395	LEWIS raspa nasale	426	martello p. cussione TROEMNER	15
KNAPP uncino lacrimale	394	LEXER forbici p dissez	60	martello PARTSCH	211
KNAPP-LUER pinza trachiase	397	LEXER sgorbie	195	martello WILLIGER	210
KNOWLES forbici p bendaggi	72	LEXER-BABY forbici p. dissez	57	MARTIN isterometro	341
KOCHER divaricatore	178,186	LEXER-MINI scalpello	195	MARTIN pelvimetro	346
KOCHER divaricatore	187,192	LEXER-MINI sgorbie	195	MARTIN tenaglie p. ossa	256
KOCHER pinza emostatica fino	105	LICHTWITZ trequarti	284	MARTINI curette taglienti	289
KOCHER pinza intestinale	130	limetta forcice e da unghie	370,371	MASSON port'aghi	89
KOCHER sonde	173	LISTER forbici p. bendaggi	72	MASTIN pinza muscolare	173
KOCHER spatole vescicale	323	LISTER-BURCH blefarostati	389	MATHIEU divaricatori doppio	186
KOENIG periostotomo	206	LISTON cesoie p ossa	253	MATHIEU port'aghi	91
KOENIG sonde conduttrici	99	LISTON coltello p. amputazione	10	MATHIEU specoli rettali	328
KOERTE divaricatore	188	LITTAUER forbici p. legature	58	MATHIEU-OLSEN port'aghi	94
KOGAN endospecoli	341	LITTAUER pinza deiplatorie	400	MATSON periostotomo	207
KOOS bisturi	278	LITTLEWOOD pinza p. afferare	136	MATSON-ALEXANDER periostotomo	207
KRAUSE inserto	302	LORNA pinza fissateli	127	MAUNDER	431
KRAUSE serranodi	406,420	LOUTE strumento tendifili	204	MATZENAUER specoli	338
KRAYENBUEHL uncini p. nervi	279	LOVE divaricatore	436	MAYO abbassalingua	432
KRISTELLER specolo	339	LOVE uncini p. radici d. nervi	261	MAYO cucchiai p. calcoli bil.	125
KRISTELLER specolo vaginale	339	LOVELACE pinza emostatica	107	MAYO forbici p dissez	56
KROENIG abbassalingua	432	LOWER pinza emostatica	117	MAYO pinza p sterilizzazione	369
KRONECKER aghi p. legature	100	LOWMAN pinza p. ossa	204	MAYO sonde p calcoli bil.	125
KUHNT spatole p. corneale	391	LUC pinza p. il setto nasale	416	MAYO-GUYON pinza emostatica	113
		LUCAE ago p paracentesi	405	MAYO-HEGAR port'aghi	94
		LUCAE diapason	402	MAYO-STILLE forbici p. dissez	56
		LUCAE martello	210	MC GIVNEY legatore emorroidali	308
		LUCAE pinza auricol. bajonet	405	MC INDOE pinza	44
		LUER cannula tracheali argent	171	MC INTOSH laringoscopio	19-34
		LUER pinza sgorbie	245	MC LEAN-LUIKART forcipe	364
		LUIKART forcipe	364	MC GEE uncinetto	413
		LUIKART-BILL trattore	364	MC GIVNEY pinza p. emorroidali	308
		LUNIATSCHEK	436	MC IVOR apribocca	433
		lupus curette p. FOX	368	MC KENTY elevatore p. setto	421
		lupus curette p. PIFFARD	368	MEAD martello	210
				MEAD pinza sgorbie	244
				MEEKER pinza emostatica	111
				MEHDORN pinza p applicare	465
				MEHDORN serrafine	465
				MELLINGER blefarostati	388
				MELLINGER-AXENFELD blefarostati	388
				MERCEDES valve solo p.	319
				METZENBAUM forbici p dissez	55
				MEYERDING divaricatore	179,191
				MEYERDING divaricatore	233
				MEYHOEFER cucciai p. calazio	395
				MICHEL agraffe	97
				MICHEL pinza p. agraffe	97
				MICHEL specchio laringei	303,415
				micro forbici	66,67
				micro forbici	68,69
				micro forbici bajonet	66
				micro forbici GOMEL	69
				micro forbici HEPPE-SCHUIDEL	68
				micro pinza auricolari	408
				micro pinza auricolari COS	407
				micro pinza auricolari GREVEN	407
				micro pinza auricolari JUERS	407
				micro pinza auricolari MC GEE	407
				micro pinza auricolari ovale	407
				micro pinza intraoculare	410
				micro port'aghi BARRAQUER	90
				MIDDLETON-JANSEN pinza	417,419
				MIKULICZ divaricatore	192
				MIKULICZ pinza emostatica	126
				MILLIGAN scollat p. duramadre	275
				MILLIN divaricatore vescicali	323
				MILLIN pinza p. prostata	324
				MINI-LAMBOTTE scalpello	199
				MIXTER pinza emostatica	111,112

L

M

MIXTER-BABY pinza emostatica	111
MIXTER-O'SHAUGNESSY pinza	112
MODELLO pinza RUSSO	45
MOELTGEN goniometro	14
MOLLISON divaricatore	230
MOORE perforatore a mano	218
MORSE divaricatore	312
MORSE-FAVALORO divaricatore	312
MOYNIHAN pinza emostatica	112
MUCK coltello	413
MUELLER approssimatori	467
MUELLER blefarostati	389
MUELLER serratini	468
MÜNCHEN curette d'aspir.	350
MURDOCK blefarostati	389
MURPHY-LANE elevatore	260
MUSEUX pinza p. abbassare	348
MYLES pinza taglianti nasale	418

N

NABATOFF astuccio p. varici	232
NAEGELE focipe	363
NAGER ago p. tonsille	439
NAGER divaricatore	436
nastro metrico	14
NEFF voltello p. meniscus	271
NEGUS pinza p. tonsille	437
NELATON sonda	15
NELSON pinza p dissezione	46
NELSON trocar	283
NEWS gancio p tracheotomia	171
NOTO pinza p. polipi uterini	137,349
NOVAK curette d'aspirazione	344
NOYES forbici oculistiche	401

O

OBWEGESER ago	440
OBWEGESER divaricatore	440
OBWEGESER periostotomo	440
OBWEGESER periostotomo	441,442
OCHSNER trequarto thorax	283
OEHLER pinza p dissezione	84
OLDBERG pinza taglianti	295
OLIVECRONA pinza sgorbie	245
OLIVECRONA segna	194
OLIVECRONA spatole cerebrali	279
OLIVECRONA-TÖNNIS pinza	273
OLLIER divaricatore	187
OLSEN-HEGAR port'aghi	91
OMBREDANNE martello	213
osteotomo	195-201
osteotomo LAMBOTTE	195,199
osteotomo pinza CITELLI	419
osteotomo pinza HAJEK-KOFLER	417
osteotomo pinza OSTROEM	417
ostetricia cucchiaino SELLHEIM	366
ostetricia SAENGER	137
ostetricia WINTER	365
OSTROEM pinza osteotomo	417
O'SULLIVAN-O'CONNOR specolo	336
OVERHOLT periostotomo	207
OVERHOLT-GEISSENDOERFER pinza	108

P

padelle reniformi grande	375
padelle reniformi medio	376,376A

padelle reniformi piccolo	376B,377
parametro forbici	63,64
PARK blefarostati	389
PARKER divaricatori	188,186
PARTSCH martello	211
PARTSCH scalpello	196
PAYR pinza p. l'intesto	130
PAYR sonde conduttrici	100
PEAN pinza emostatica	102
PEAN pinza emostatica fino	103,105
PEDERSON specolo vaginale	335
PEERS pinza fissateli	127
PEET pinza p schegge	47
PELKMAN pinza p tampone	122
pelvimetro COLLIER	346
pelvimetro COLLIN	346
pelvimetro MARTIN	346
PENFIELD scollatori	276
PENNINGTON pinza emostatica	107
perforatore	220,221
perforatore a mano	218
perforatore a mano BUNELL	224
perforatore a mano HUDSON	218
perforatore a mano MOORE	218
perforatore a mano RALK	224
perforatore a mano STILLE	218
perforatore elettrico 220 V	224
perforatore STILLE-SHERMAN	218
perforatore fili p. KIRSCHNER	266
perforatore fili p. KIRSCHNER	267,268
PESTALOZZA curette p. aborto	365
pestoni	196
PHANEUF pinza p. itoneale	114
PIERCE trequarto antrum	284
PIFFARD curette p. lupus	368
PINARD fonendoscopio	14
pinza atraumatiche BAINBRIDGE	148
pinza atraumatiche BAKEY	144-149
pinza atraumatiche BAKEY	151,152
pinza atraumatiche BAKEY	158,159
pinza atraumatiche COOLEY	161
pinza atraumatiche DE BAKEY	154,157
pinza atraumatiche DE BAKEY	160
pinza atraumatiche DE BAKEY-MOSQU.	146
pinza atraumatiche DE BAKEY-PEAN	146
pinza atraumatiche DE BAKEY-RANKIN	151
pinza atraumatiche GLOVER	151
pinza atraumatiche neonatal	163,164
pinza atraumatiche POTTS	150,152
pinza atraumatiche SUBRAMANIAN	162
pinza atraumatiche DERRA	148
pinza auricolari HARTMANN	407
pinza auricolari LUCAE	406
pinza auricolari micro	407,408
pinza auricolari micro COS	407
pinza auricolari micro GREVEN	407
pinza auricolari micro JUERS	407
pinza auricolari micro MC GEE	407
pinza auricolari micro ovale	407
pinza auricolari WILDE (TROELTSCH)	406
pinza auricola HARKEN	156
pinza BOZEMANN-DOUGLAS	119
pinza bulldog DE BAKEY-DIETHRICH	143
pinza bulldog mini DIETHRICH	143
pinza capsulare ARRUGA	399,400
pinza capsulare HESS	398
pinza capsulare SCHWEIGGER	399
pinza capsulare DASTOOR	396
pinza capsulari HOLTH	396
pinza cardiovasc. SATINSKYY	155
pinza CHEVALIER-JACKSON	296
pinza coagulazione bipolar	382-386

pinza COLLIN-DUVAL	46
pinza deiplatorie BEER	400
pinza deiplatorie DOUGLAS	400
pinza deiplatorie LITTAUER	400
pinza emostatica ADSON	106
pinza emostatica ADSON-BABY	106
pinza emostatica ATRAUMA	107
pinza emostatica BAINBRIDGE	108
pinza emostatica BENGOLEA	118
pinza emostatica CHAPUT	102
pinza emostatica COLLIN	102
pinza emostatica CRAFOORD	109
pinza emostatica CRAFOORD-SELLORS	110
pinza emostatica CRILE	104
pinza emostatica CRILE-RANKIN	104
pinza emostatica DANDY	107
pinza emostatica fino KOCHER	103
pinza emostatica GEMINI	109
pinza emostatica GRAY	112
pinza emostatica GUYON	113
pinza emostatica HALSTED-MOSQUITO	106
pinza emostatica HARTMANN	103,104
pinza emostatica HEISS	117
pinza emostatica HERRICK	114
pinza emostatica JOHNS-HOPKINS	111
pinza emostatica KELLY	103
pinza emostatica KELLY-RANKIN	104
pinza emostatica LAHEY	117
pinza emostatica LAWRENCE	111
pinza emostatica LERICHE	107
pinza emostatica LOVELACE	107
pinza emostatica LOWER	117
pinza emostatica MARTEL	102
pinza emostatica MAYO-GUYON	113
pinza emostatica MEEKER	111
pinza emostatica MICRO-HARTMANN	103,104
pinza emostatica MIKULICZ	126
pinza emostatica MIXTER	111,112
pinza emostatica MIXTER-BABY	106
pinza emostatica MOYNIHAN	112
pinza emostatica PEAN	103,105
pinza emostatica PENNINGTON	107
pinza emostatica PRATT	102
pinza emostatica ROBERTS	108
pinza emostatica ROCHESTER-PEAN	105
pinza emostatica RUMEL	108
pinza emostatica SAROT	109
pinza emostatica SPENCER-WELLS	103
pinza emostatica STILLE	113
pinza emostatica TOENNIS	110
pinza emostatica TUFFIER	102
pinza emostatica WILLET MARTEL	102
pinza emostatica ZENKER	109
pinza emostatica DESJARDINS	112
pinza entropio SNELLEN	399
pinza FERRIS-SMITH-KERRISON	293,294
pinza fissateli	127
pinza fissateli BACKHAUS	127
pinza fissateli BACKHAUS-CLIP	127
pinza fissateli BALL A. SOCKET	127
pinza fissateli BÜLOW-GUNAR-HEY	116
pinza fissateli JONES	127
pinza fissateli JONES-CLIP	127
pinza fissateli LORNA	127
pinza fissateli PEERS	127
pinza fissateli SCHAEDEL	127
pinza fissateli TOHOKU	127
pinza HARTMANN	407
pinza HARTMANN-WULLSTEIN	407
pinza intestinali atrauma DOYEN	130

pinza intestinali BRUNNER	131	pinza p. applicare BIEMER	467,469	pinza p. la plastica ASCH	420
pinza intestinali FEHLAND	131	pinza p. applicare MEHDORN	465	pinza p. la plastica WALSHAM	420
pinza intestinali KOCHER	130	pinza p. applicare MINI	460-463	pinza p. lacer.d.unghe RADOLF	370
pinza JACKSON	297	pinza p. applicare RANEY	274	pinza p. l'intesto PAYR	130
pinza JOHNS-HOPKINS	48,111	pinza p. applicare STANDARD	460-463	pinza p. l'intesto PAYR-BABY	130
pinza MARTEL-WOLFSON	134	pinza p. biopsia BABY-TISCHLER	351	pinza p. medica LISTER SINUS	120
pinza MIDDLETON-JANSEN	417,419	pinza p. biopsia EPPENDORFER	305	pinza p. microchirurgia	49,51
pinza MODELLO RUSSO	45	pinza p. bronchi FINOCCHIETTO	128	pinza p. microchirurgia ADSON- BROWN	45,50
pinza muscolare MASTIN	173	pinza p. bronchi HARRINGTON	128	pinza p. microchirurgia GOMEL	50
pinza muscolare PRINCE	397	pinza p. bronchi PRICE-THOMAS	128	pinza p. microchirurgia Titan	50,51
pinza nasale HAJEK	419	pinza p. bronchi SEMB	129	pinza p. nefrostomia ELSÄSSER	123
pinza nasale HARTMANN	418	pinza p. calazio AYER	399	pinza p. neonati CASTANEDA	163,164
pinza nasale WEIL-BLAKESLEY	416	pinza p. calcoli bil. BLAKE	123	pinza p. occl. Tangenz. SATINSKY	155
pinza OLIVECRONA-TÖNNIS	273	pinza p. calcoli bil. DESJARDINS	122	pinza p. orecchio JANSEN	47,406
pinza ombelicale COLLIN	365	pinza p. calcoli bil. MAYO-BLAKE	123	pinza p. orecchio TROELTSCH	47
pinza ombelicale KANE	365	pinza p. calcoli bil. MIXTER	123	pinza p. ossa FELDHEIM	371
pinza osteotomo CITELLI	419	pinza p. calcoli renali RANDALL	122	pinza p. ossa GERSTER	204
pinza osteotomo HAJEK-KOFLER	419	pinza p. coartazione DE BAKEY	140,147	pinza p. polipi HARTMANN	407
pinza osteotomo OSTROEM	417	pinza p. coartazione POTTS	150,152	pinza p. polipi HEYMANN-KNIGHT	416
pinza OVERHOLT-GEISSENDOERFER	108	pinza p. corpi estranei MATHIEU	325	pinza p. polipi laringei FRAENKEL	297
pinza p. abbassare HULKA	127	pinza p. cuoio cappell. GAUSS	365	pinza p. polipi laringei JURASZ	297
pinza p. abbassare il collo del l'utero BARRETT	347	pinza p. dissezione ADSON	44,85	pinza p. polipi uterini DOYEN	137,349
pinza p. abbassare il collo del l'utero BRAUN	347	pinza p. dissezione ADSON-MICRO	85	pinza p. polipi uterini KELLY	137,349
pinza p. abbassare il collo del l'utero DUPLAY	127,347	pinza p. dissezione anat. USA	44	pinza p. polipi uterini NOTO	137,349
pinza p. abbassare il collo del l'utero JACOBS	348	pinza p. dissezione anatomiche	44	pinza p. pressione FERGUSSON	107
pinza p. abbassare il collo del l'utero JARCHO	347	pinza p. dissezione BONNEY	45,85	pinza p. prostata MILLIN	324
pinza p. abbassare il collo del l'utero MUSEUX	348	pinza p. dissezione BROWN	45	pinza p. rifiuti SAUERBRUCH	369
pinza p. abbassare il collo del l'utero PRATT	348	pinza p. dissezione chir.	45	pinza p. riposizione ROWE	431
pinza p. abbassare il collo del l'utero SCHROEDER	347	pinza p. dissezione chir. USA	46	pinza p. schegge	44,48
pinza p. abbassare il collo del l'utero SKENE	347	pinza p. dissezione CUSHING	85	pinza p. schegge ARCHER	47
pinza p. abbassare il collo del l'utero TEALE	348	pinza p. dissezione DURANTE	45	pinza p. schegge CARMALT	48
pinza p. affer. int. ALLIS	121	pinza p. dissezione FERRIS-SMITH	46	pinza p. schegge FEILCHENFELD	44
pinza p. affer. int. ALLIS-ADAIR	121	pinza p. dissezione GERALD	85	pinza p. schegge HUNTER	47
pinza p. affer. int. ALLIS-BABY	121	pinza p. dissezione GILLIES	45	pinza p. schegge PEET	47
pinza p. affer. int. BABCOCK	121	pinza p. dissezione LANE	46	pinza p. schegge STIEGLITZ	47
pinza p. affer. int. DOYEN	130	pinza p. dissezione LERCHE	46	pinza p. schegge VIRTUS	47
pinza p. affer. int. DOYEN-BABY	130	pinza p. dissezione NELSON	46	pinza p. setto RUBIN	418
pinza p. affer. int. DUVAL	130	pinza p. dissezione OEHLER	84	pinza p. spugne BRYANT	120
pinza p. affer. int. JUDD-ALLIS	121	pinza p. dissezione POTTS-SMITH	44	pinza p. spugne FOERSTER	119,120
pinza p. affer. int. TC BABCOCK	121	pinza p. dissezione SEMKEN	45	pinza p. spugne RAMPLEY	119
pinza p. affer. int. THOMS-ALLIS	121	pinza p. dissezione TAYLOR	45	pinza p. sterilizzazione CHEATLE	369
pinza p. affer. int. WILLIAMS	131	pinza p. dissezione WANGESTEEN	85	pinza p. sterilizzazione UNIVERSAL	369
pinza p. affer. polmone LOVELACE	128	pinza p. emorr. HEYWOOD-SMITH	304	pinza p. sterilizzazione	369
pinza p. affer. prostata YOUNG	324	pinza p. emorroidali MC GIVNEY	308	pinza p. sterilizzazione BUNT	369
pinza p. afferare LITTLEWOOD	136	pinza p. fissaggio ELSCHNIG	397	pinza p. sterilizzazione MAYO	369
pinza p. afferare l'utero COLLIN	137,349	pinza p. gozzo LAHEY	173	pinza p. sterilizzazione ROGGE	369
pinza p. afferare l'utero DARTIGUES	349	pinza p. il setto nasale HEYMAN	416	pinza p. tampone BOZEMANN	119
pinza p. afferare l'utero SOMER	137,349	pinza p. il setto nasale KNIGHT	416	pinza p. tampone CHERON	120
pinza p. agraiffe CHILDE	97	pinza p. il setto nasale LUC	416	pinza p. tampone COLLIN	120
pinza p. agraiffe COLLIN	97	pinza p. introdurre sonda MAGILL	17	pinza p. tampone GROSS-MAIER	119
pinza p. agraiffe HEGENBARTH	97	pinza p. ipofisi	295	pinza p. tampone PELKMAN	122
pinza p. agraiffe MICHEL	97	pinza p. ipofisi ADSON	277	pinza p. tampone ULRICH	119
pinza p. agraiffe RICHTER-HEATH	97	pinza p. iride BARRAQUER	398	pinza p. tonsille BALLENGER	437
pinza p. agraiffe WACHENFELDT	97	pinza p. iride BARRAQUER-KATZIN	398	pinza p. tonsille BLOHMKE	437
pinza p. aorta DIETRICH	143	pinza p. iride BISHOP-HARMAN	398	pinza p. tonsille COLVER	437
pinza p. aorta WEBER	152	pinza p. iride BONN	398-400	pinza p. tonsille NEGUS	437
pinza p. appendice ALLEN	132	pinza p. iride FISCHER	399	pinza p. tonsille SAWTELL	437
pinza p. appendice KLEINSCHMIDT	132	pinza p. iride FOERSTER	399	pinza p. tonsille SCHNIDT	437
pinza p. applicare agraife MC KENZIE	132	pinza p. iride GILL	398	pinza p. tonsille TYDING	438
pinza p. applicare agraife SMITHWICK	273	pinza p. iride GILL-HESS	398	pinza p. tonsille WHITE	437
pinza p. applicare agraife SWEET	273	pinza p. iride GRAEFE	396	pinza p. trazione CRUTCHFIELD	274
pinza p. applicare BIEMER	464,467	pinza p. iride HESS	398	pinza p. tumori smussa LANDOLT	295
		pinza p. iride STEVENS	396	pinza p. vasectomia	330
		pinza p. iride TUEBINGEN	400	pinza PROVIDENCE-HOSPITAL	103
		pinza p. isterectomia HEANEY	115	pinza ROCHESTER-CARMALT	107
		pinza p. isterectomia HEANEY-BALLENT	115	pinza ROCHESTER-OCHSNER	105
		pinza p. isterectomia ROGERS	115	pinza rompe-lame CATROVIEJO	41
		pinza p. isterectomia WERTHEIM	114	pinza rompe-lame TROUTMAN-CHRIS	41
		pinza p. itoneale FAURE	126	pinza serrafina DIEFFENBACH	48
		pinza p. itoneale PHANEUF	114	pinza serrafina JOHNS-HOPKINS	48
		pinza p. la carotide COOLEY	161	pinza serratubi	117

pinza serratubo HOFFMANN	341
pinza serratubo SIMPLEX	341
pinza setto nasale BRUENINGS	416
pinza sgorbie BEYER	246
pinza sgorbie BLUMENTHAL	245
pinza sgorbie BOEHLER	247
pinza sgorbie CLEVELAND	244
pinza sgorbie ECHLIN	248
pinza sgorbie FRIEDMANN	244
pinza sgorbie FRIEDMANN-MINI	244
pinza sgorbie FRYKHOLM	248
pinza sgorbie KLEINERT-KUTZ	246
pinza sgorbie LEKSELL-STILLE	249
pinza sgorbie LEMPERS	244
pinza sgorbie LUER	245
pinza sgorbie MEAD	244
pinza sgorbie OLIVECRONA	245
pinza sgorbie RUSKIN	249
pinza sgorbie SAUERBRUCH	248
pinza sgorbie SEMB	248
pinza sgorbie SMITH-PETERSEN	247
pinza sgorbie STILLE-LUER	249
pinza sgorbie STILLE-RUSKIN	249
pinza sgorbie ZAUFAL-JANSEN	249
pinza stomacali LANE	135
pinza STONE	133
pinza STONE-WATT	133
pinza STRUEMPEL	407
pinza SUBRAMANIAN-MINIATURE	162
pinza tagl. nasale HARTMANN	418
pinza tagl. nasale STRUYCKEN	418
pinza tagl. p. biopsia BURKE	305
pinza tagl. p. biopsia ALEXANDER	298
pinza tagl. p. biopsia FAURE	296
pinza tagl. p. biopsia KEVORKIAN	298
pinza tagl. p. biopsia SCHUBERT	296
pinza tagl. p. biopsia SCHUMACHER	298
pinza tagl. p. biopsia THOMAS-GAYLOR	296
pinza tagl. p. biopsia TISCHLER	1,351,307
pinza tagl. p. biopsia TOWNSEND	1,351
pinza tagl. p. biopsia VAN DOREN	298
pinza tagl. p. biopsia WITTNER	307
pinza tagliente LOVE-GRUENWALD	292
pinza taglienti CLOWARD	299
pinza taglienti COLCLOUGH	294
pinza taglienti CUSHING	292
pinza taglienti FERRIS-SMITH	294
pinza taglienti HAJEK-KOFLER	417
pinza taglienti KERRISON	293
pinza taglienti nasale MYLES	418
pinza taglienti OLDBERG	295
pinza taglienti SCHLESINGER	299
pinza taglienti SPURLING	292
pinza taglienti p. biops. TURREL	304
pinza taglienti p. biops. YEOMANN	304
pinza tiralingua COLLIN	102,435
pinza tiralingua YOUNG	435
pinza TISCHLER-KEVORKIAN	351,307
pinza trachiasi KNAPP-LUER	397
pinza uterini GREEN-ARMYTAGE	137
pinza WULLSTEIN	407
pistola lavatrice completa	380
placca p. palpebre JAEGER	389
PLESTER coltello	411
PLESTER divaricatore	228
PLESTER tubi aspirazioni	17,281
POLITZER ago p. paracentesi	405
POLITZER isnerto	404
POOLE cannula p. aspirazione	17
portacotone FARRELL	412
portacotone JOBSON-HORNE	412
portacotone TOBOLD	412

portacotone UCKERMANN	412
port'aghi ARRUG	90
port'aghi BARRAQUER	90
port'aghi BARRAQUER-TROUTMAN	90
port'aghi BAUMGARTNER	89,94
port'aghi CASTROV.-MICRO	88,95
port'aghi CASTROVIEJO	88
port'aghi CRILE-WOOD	89,94
port'aghi FINOCCHIETTO	89
port'aghi GILLIES	88
port'aghi HALSEY	89
port'aghi HEANEY	89
port'aghi HOESEL	91
port'aghi JACOBSON	89
port'aghi KILNER	88
port'aghi LANGENBECK	91
port'aghi LICHTENBERG	91
port'aghi MASSON	89,94
port'aghi MATHIEU	91,94
port'aghi MATHIEU-OLSEN	91
port'aghi MAYO-HEGAR	88,94
port'aghi OLSEN-HEGAR	91
port'aghi RYDER	88
port'aghi TC	88-91
POTTS pinza p coartazione	150,152
POTTS-SMITH forbici vascolari	63
PRATT dilatatori uterini	342
PRATT pinza emostatica	102
PRATT pinza p. abbassare	348
PRATT sonda p fistole	332
PRATT specoli rettali	329
PRINCE pinza muscolari	397
proctoscopi CHELSEA-EATON	332
proctoscopi FANSLER	331
proctoscopo KELLY	332
prottetori ARRUGA	393
PROVIDENCE-HOSPITAL pinza	103
PUTTI raspe	217

Q

QUIRE leve p. corpi estranei	406
------------------------------	-----

R

RADOLF pinza	370
RAGNELL divaricatori	185
RALK perforatore a mano	224
RAMPLEY pinza p. spugne	119
RAMUS divaricatore	442
RANDALL curette d'aspirazione	344
RANEY clip emostatica	274
RANEY pinza p. applicare	274
rasoi	41
raspe nasale FOMON	426,427
raspe nasale GALLAHER	426
raspe nasale JOSEPH	427
raspe nasale JOSEPH (LEWIS)	426
raspe nasale LEWIS	426
raspe nasale MALTZ (COTTLE)	426,427
raspe nasale WIENER	426
raspe	217
raspe PUTTI	217
RECAMIER curette uterini 31cm	358
recipienti cilindrici	375
recipiente	375
REDON ago guida	447
REICHERT pressore p. epigl.	297
REILL tenaglie p ossa	257
REINER coltelle gessati	74

REINER siringa completo	407
retrattore CASPAR	231
rett. SCHULZE-BERGMANN specoli	329
REVERDIN aghi	96
REYNOLDS forbici	58
RIBBON divaricatori addom.	190
RICARD divaricatore addominale	238
RICHARDSON divaricatori	186
RICHARDSON divaricatori GRIP	186
RICHARDSON-EASTMAN divaricatori	186
RIGBY divaricatori	232
RITTER-HALLE cannula	422
ROBB spatola	167
ROBERTS pinza emostatica	108
ROCHARD divaricatore addominale	236
ROCHESTER-CARMALT pinza	107
ROCHESTER-OCHSNER pinza	105
ROGER elevatore p. setto	423
ROGERS pinza p. isterectomia	115
ROLLET uncino lacrimale	393
rompe-lamette CASTROVIEJO	41
rompe-lamette TROUTMAN-CHRIS	41
ROSEN ago curve tagl	413
ROSEN coltello	411
ROSEN tubi aspirazioni	281
ROSER-KOENIG apribocca	435
ROUX divaricatori	186
ROUX divaricatori doppio	185
ROUX-BABY divaricatori	185
ROUX-MINI divaricatori	185
ROWE pinza p. riposizione	431
RUBIN pinza p. setto	418
RUDD legatori emorroidali	308
RUMEL pinza emostatica	108
RUMEL-BELMONT Tornichetti	165
RUSKIN pinza sgorbie	249
RUSSO pinza MODELLO	45
RYDEL-SEIFFERT diapason	402
RYDER port'aghi	88

S

SAALFELD schiaccia comedoni	368
SACHS scollatori p. duramadre	275
SACHS uncini p. nervi	261
SAENGER osetricia	137
salpingografo compl. SCHULTZE	345
SAROT pinza emostatica	109
SATINSKY pinza cardiovascolare	129
SATINSKY forbici toracali	62
SATTERLEE seghe p. amputazione	194
SAUERBRUCH costotomo	311
SAUERBRUCH divaricatore	189
SAUERBRUCH pinza p. rifiuti	369
SAUERBRUCH pinza sgorbie	248
SAUERBRUCH-FREY costotomo	311
SAWTELL pinza p. tonsille	437
SAYRE periostotomo	269
SCAGLIETTI pinza sgorbie	248
scalpello	195-201
scalpello ALEXANDER	196
scalpello COBB	199
scalpello COTTLE	425
scalpello FOMON	424
scalpello FREER	425
scalpello HAJEK	425
scalpello HIBBS	197
scalpello HOKE	197
scalpello KILLIAN-CLAUS	425
scalpello LEXER-MINI	195
scalpello MINI-LAMBOTTE	195,199

scalpello nasale WEST	425	SEXTON coltello auricolari	404	sonde DOYEN	15
scalpello p. corpi estr. WALTON.	391	sgorbie.	196	sonde FISH	15
scalpello p. plastica COTTLE	424	sgorbie ALEXANDER.	196	sonde KOCHER.	173
scalpello p. plastica FREER	423	sgorbie COBB.	199	sonde metalliche femur	322
scalpello p. sterno LEBSCHÉ	217	sgorbie HIBBS.	197	sonde NELATON.	15
scalpello PARTSCH.	196	sgorbie LEKSELL-STILLE pinza	249	sonde p. calcoli bil. MAYO	125
scalpello septum CINELLI.	424	sgorbie LEXER	195	sonde p. calcoli bil. BAKES	122
scalpello septum SILVER	425	sgorbie LEXER-MINI	195	sonde p. calcoli bil. DESJARDINS	125
scatola interna solo	374	sgorbie pinza BEYER	246,249	sonde p. fistole PRATT	332
scatola p. strumenti.	374,376	sgorbie pinza BLUMENTHAL	245	sonde STACKE	15
scatole p. sterili. SAUERBRUCH	374	sgorbie pinza BOEHLER.	247	spatola ROBB	167
SCHAEDEL pinza fissateli.	127	sgorbie pinza CLEVELAND	244	spatola cerebrali CUSHING	279
SCHAMBERG schiaccia comedoni	368	sgorbie pinza ECHLIN.	248	spatola cerebrali OLIVERCRONA	279
SCHÉDE curette taglienti	290	sgorbie pinza FRIEDMANN.	244	spatole CULLER	393
SCHERBAK manico solo p.	337	sgorbie pinza FRIEDMANN-MINI	244	spatole p. ciclod. BANGERTER	393
SCHERBAK specoli vaginale	337	sgorbie pinza FRYKHOLM	248	spatole p. ciclod. ELSCHNIG	393
schiaccia comedoni SAALFELD	368	sgorbie pinza KLEINERT-KUTZ	246	spatole p. corneale KUHN	391
schiaccia comedoni SCHAMBERG	368	sgorbie pinza LEMPÉRT	244	spatole p. polmone ALLISON	310
schiaccia comedoni UNNA	368	sgorbie pinza LUER.	245	spatole vescicale KOCHER.	323
schiaccia comedoni WALTON	368	sgorbie pinza MEAD	244	spatole vescicale LEGUEU	323
SCHINK dermatomo	12	sgorbie pinza OLIVECRONA.	245	spatole WECKER	393
SCHIOETZ tonometro	388	sgorbie pinza RUSKIN	249	specchio frontale ZIEGLER.	16
SCHLESINGER pinza taglienti	299	sgorbie pinza SAUERBRUCH.	248	specchio laringei	303
SCHMIEDEN sonde conduttrici	99	sgorbie pinza SCAGLIETTI	248	specchio laringei MICHEL.	415
SCHUBERT pinza tagl.p. biopsia	296	sgorbie pinza SEMB	248	specillo p. can. lacrim. BOWMAN.	388
SCHUKNECHT coltello	411	sgorbie pinza STILLE-LUER	249	specoli auric. HARTMANN	404
SCHUMACHER forbici ginecologiche.	61	sgorbie pinza STILLE-RUSKIN	249	specoli auric. SIEGLE	404
SCHUMACHER inserto	302	sgorbie pinza ZAUFAL-JANSEN.	249	specoli auric. TOYNBEE	404
SCHWEIGGER pinza capsulare	399	sgorbie pinza SMITH-PETERSEN.	198	specoli rettali BARR	329
scollatori p. duramadre	275,276	sgorbie pinza SMITH-PETERSEN pinza.	247	specoli rettali BODENHAMMER	328
scollatori p. duramadre DAVIS	275	sgorbie STILLE	201	specoli rettali CZERNY	328
scollatori p. duramadre FRAZIER	276	SHEA forcipe auric. micro	408	specoli rettali MATHIEU	328
scollatori p. duramadre HOEN	276	SIEBENMANN cannula	422	specoli rettali PRATT.	329
scollatori p. duramadre HORSLEY	276	SIEGLE specoli auric.	404	specoli rettali SCHULZE-BERGMANN	329
scollatori p. duramadre SACHS	275	SILVER Septum scalpello	425	specoli rettali SIMS	328
scollatori p. duramadre TOENNIS.	275	SIMON curette uterini	290	specolo FRIEDMANN	339
scollatori PENFIELD	276	SIMON divaricatore.	192	specolo nasale COTTLE	415
SCOVILLE curette taglienti	288	SIMPLEX pinza serratubo	341	specolo nasale HARTMANN-HALLE.	414
SCOVILLE uncini p. nervi	270	SIMPSON forcipe	363	specolo nasale KILLIAN	414
SCOVILLE valve	234	SIMPSON-BRAUN forcipe	363	specolo nasale THUDICHUM	415
sega elettrica p. gessi	73	SIMPSON-LUIKART forcipe	363	specolo nasale TIECK-HALLE.	414
sega ENGEL	74	SIMS dilatatori uterini	343	specolo nasale VIENNA	414
sega nasale JOSEPH	428	SIMS forbici ginecologiche	60	specolo nasale VOLTOLINI.	415
sega OLIVECRONA.	194	SIMS pressori uterini.	350	specolo O'SULLIVAN-O'CONNOR	336
sega p. amputazione CHARRIERE	194	SIMS specoli rettali	328	specolo vaginale AUVARD	339
sega p. amputazione LANGENBECK.	194	SIMS specolo vaginale	339	specolo vaginale BREISKY	340
sega p. amputazione SATTERLEE.	194	SINUS pinza p. medica LISTER	120	specolo vaginale COLLIN	335
sega WIGMORE	74	siringa completo REINER	407	specolo vaginale CUSCO	335
SEGOND bisturo p. fibromi.	344	siringa p. tonsillo	438	specolo vaginale DOYEN	340
SELLHEIM cucchiaio ostetrico	366	SKENE pinza p. abbassare.	347	specolo vaginale GRAVE	335
SEMB cesoie p. ossa	252	SLUDER-BALLENGER tonsillotomo	439	specolo vaginale KALLMORGEN	339
SEMB periostotomo	208	SMELLIE spezza crano	366	specolo vaginale KRISTELLER	339
SEMB pinza p. bronchi	129	SMELLIE uncino	365	specolo vaginale LANDAU	340
SEMB pinza sgorbie	248	SMILLIE coltello p. meniscus	271	specolo vaginale PEDERSON	335
SEMB tenaglie p. ossa	252	SMILLIE elevatori p. ossa	260	specolo vaginale SCHERBAK	337
SEMKEN pinza p. dissezione	44	SMITH blefarostati	389	specolo vaginale SEMM	335
SEMM specolo vaginale	335	SMITH forbici	61	specolo vaginale SIMS	339
SENN-GREEN divaricatore	178	SMITH-BUIE dilatatori p. l'ano	329	specolo vaginale TRELAT	336
sensimetro WARTENBERG.	14	SMITHWICK pinza p. applicare	273	specolo vaginale VU-MOORE.	334
SEUTIN forbici p. bendaggi	61	SMITHWICK uncini p. nervi.	261	SPENCER forbici p. legature	58
separatore ROCHARD	236	SNELLEN anse	395	SPENCER-WELLS pinza emost.	103
serrafini MUELLER	468	SNELLEN pinza entropio.	399	spezza crano SMELLIE	366
serrafini YASARGIL	448-459	SOMER pinza p. afp.l'utero	137,349	SPINAL curette taglienti	288
serranodi KRAUSE	406,420	sonda bottonuta JACOBSON.	278	SPRATT curette taglienti.	289
serranodi p. tonsille BRÜNINGS.	420	sonde.	15	SPURLING pinza taglienti	292
serranodi p. tonsille EVES.	438	sonde conduttrici BRUNNER	100	ST.CLAIR-THOMSON coltello.	429
serranodi WESTON	304	sonde conduttrici KIRSCHNER.	99	ST.MARKS divaricatore pelvico	181
serranodi WILDE	406	sonde conduttrici KOENIG	99	STEINMANN chiodi p. ossa	267,268
serrapene STOCKMANN.	325	sonde conduttrici PAYR	100	STERNBERG divaricatore p guancie	430
serrapene STRAUSS.	325	sonde conduttrici SCHMIEDEN	99	STEVENS forbici p. tenotomia	59
serrapinza DE MARATEL-WOLFSON.	134	sonde conduttrici SCHMIEDEN-PAYR.	99	STEVENS pinza p. iride.	396
set p. suture	97,98	sonde conduttrici VIENNA	100	STEVENSON blefarostati	389

STIEGLITZ pinza p. schegge	47
STILLE cesoie	74
STILLE costotomo	310
STILLE perforatore a mano	204
STILLE pinza emostatica	113
STILLE scalpello	201
STILLE-LUER pinza sgorbie	249
STILLE-RUSKIN pinza sgorbie	249
STILLE-SHERMAN perforatore	204,218
STOCKMANN serrapene	325
STONE pinza	133
STONE-WATT pinza	133
STRAUSS serrapene	325
STRUEMPPEL pinza	407
strumenti p. afferrare BRAND	272
strumenti p. afferrare CAROLL	272
strumenti p. afferrare KLEINERT-KUTZ	272
strumenti p. afferrare tendini	272
strumenti p. circoncisione	325
strumenti p. corpi estran. DIX	394
strumenti p. marcare CASTROVIEJO	396
strumenti p. misure	346
STRUYCKEN pinza tagl. nasale	418
SUBRAMANIA pinza traumatiche	162
SWEET pinza p. applicare	273

T

TABB coltello	411
tamboro SCHIMMELBUSCH	378
TARNIER cranioclasto	364
TARNIER forcipe	364
TAYLOR elevatore p. ossa	260
TAYLOR martello p. cussione	15
TAYLOR pinza p. dissezione	45
TEALE pinza p. abbassare	348
telaio MC IVOR	433
telaio rigido KIRSCHNER	241
telaio ROCHARD	236
tenaglie p. afferrare	214-216
tenaglie p. ossa	255,256
tenaglie p. ossa BIRCHER-GANSKE	255
tenaglie p. ossa DINGMANN	255
tenaglie p. ossa FARABEUF	254
tenaglie p. ossa FARABEUF-LAMB	254
tenaglie p. ossa FERGUSSON	254
tenaglie p. ossa KERN	254
tenaglie p. ossa LAMBOTTE	254
tenaglie p. ossa LANE	253
tenaglie p. ossa LANGENBECK	254
tenaglie p. ossa LEWIN	256
tenaglie p. ossa MARTIN	256
tenaglie p. ossa REILL	257
tenaglie p. ossa SEMB	252
tenaglie p. ossa ULRICH	257
tenaglie p. ossa VAN BUREN	255
tenaglie p. ossa VERBRUGGE	255
tenaglie tagliafilii HERKULES	216
TESSIER divaricatore	440
THOMAS curette uterini	360
THOREK forcipi polmonari	62
THUDICHUM specolo nasale	415
TIECK-HALLE specolo nasale	414
tiramio DOYEN	344
TISCHLER pinza tagl. P. biopsia	307,351
TISCHLER-KEVORKIAN pinza	307,351
TISCHLER-MORGAN pinza p. biopsia	307,351
Titan pinza MOSQUITO	106
Titan pinza bulldog	142
Titan pinza p. microchirurgia	50,51

TOBOLD abbassalingua	430
TOBOLD portacotone	412
TOENNIS pinza emostatica	110
TOHUKO pinza fissatelli	127
tonometro SCHIOETZ	388
tonsillotomo SLUDER-BALLENGER	439
tonsillotomo TYDING	438
tornichetti RUMEL-BELMONT	165
TOWNSEND pinza tagl. p. biopsia	351
TOWNSEND-MINI punto solo	351
TOYNEE specoli auric. Serie	404
trapano	219
trasformatore	16
trattore BARTON	362,364
trattore BILL	362,364
trattore LUIKART-BILL	362
trefine cutanee KEYES	368
trefine cutanee serie KEYES	368
TRELAT specolo vaginale	336
trequarto antrum COAKLEY	284
trequarto antrum DOUGLAS	284
trequarto antrum LICHTWITZ	284
trequarto antrum PIERCE	284
trequarto LICHTWITZ	284
trequarto STANDARD (NELSON)	283
trequarto thorax NELSON	284
trequarto thorax OCHSNER	283
trequarto trach. UCKERMANN	170
trequarto UNIVERSAL	284
TROELTSCH pinza p. orecchio	47
TROEMNER martello p. cussione	15
tronchesine p. unghie	370,371
tronchesine p. unghie ANVIL	371
tronchesine p. unghie TURNBULL	370
TROUSSEAU dilatatori p. trach	170
TUBBS dilatatori vascolari	165
tubi aspirazione ADSON	279-280
tubi aspirazione BARON	279
tubi aspirazione FRAZIER	17,289
tubi aspirazione HOUSE	281
tubi aspirazione PLESTER	281
tubi aspirazione ROSEN	281
tubi aspirazione YASARGIL	280
tubi aspirazione ZÖLLNER	280
tubo allungo BRUENINGS	302
TUEBINGEN pinza p. iride	400
TUFFIER divaricatore	317
TUFFIER pinza emostatica	102
TURNBULL tronchesine p. unghie	370,371
TURREL pinza tagliente p. biopsia	304
TYDING pinza p. tonsille	438
TYDING tonsillotomi	438

U

UCKERMANN portacotone	412
UCKERMANN trequarto trach.	170
ULRICH pinza p. tampone	119
ULRICH tenaglie p. ossa	257
uncinetto	413
uncinetto BARBARA	413
uncinetto COTTLE-NEIVERT	428
uncinetto di pelle FOMON	428
uncinetto di pelle FREER	176
uncinetto di pelle GILLIES	428
uncinetto GUTHRIE	176
uncinetto JOSEPH	176
uncinetto MC GEE	413
uncini muscolari	238
uncini p. dura-madre ADSON	261
uncini p. dura-madre JACOBSON	278

uncini p. le radici HOLSHER	270
uncini p. le radici SCOVILLE	270
uncini p. nervi CUSHING	261
uncini p. nervi DANDY	261
uncini p. nervi GRAHAM	261
uncini p. nervi KRAYENBUEHL	279
uncini p. nervi SACHS	261
uncini p. nervi SCOVILLE	261
uncini p. nervi SMITHWICK	261
uncini p. radici d. nervi LOVE	261
uncino cutanei KILNER	368
uncino FISCH	278
uncino lacrimale KNAPP	394
uncino lacrimale ROLLET	393
uncino nasale AUFRICHT	428
uncino nasale COTTLE	428
uncino p. detroncazione BRAUN	333
uncino p. fistole EMMET	344
uncino p. muscoli	238
uncino p. strabismo GRAEFE	393
uncino p. strabismo JAMESON	393
uncino SCOVILLE	270
uncino SMELLIE	365
UNIVERSAL forcipi p. bendaggi	72
UNIVERSAL forcipi p. filo	58
UNIVERSAL pinza p. sterilizz.	369
UNIVERSAL trequarti	284
UNNA schiaccia comedoni	368
USA forcipi ombelicali	61
USA pinza p. dissezione	46
US-ARMY divaricatori doppio	187

V

VALLEIX uterine	350
valve KALLMORGEN	339
valve KRISTELLER	339
valve SCOVILLE	234
valve TAYLOR	234
VAN BUREN candelette dilatatrice	322
VAN BUREN tenaglie p. ossa	255
VANNAS forcipi iridectomia	401
VERBRUGGE tenaglie p. ossa	255
VERRES ago pneumop. Itoneo	475
VIENNA specolo nasale	414
VIRTUS pinza p. schegge	48
VOLKMANN curette	289
VOLKMANN divaricatore	176,177
VOLKMANN divaricatore	185
VOLTOLINI specolo nasale	415
VU-MOORE specolo vaginale	334

W

WACHENFELDT pinza p. agraiffe	97
WAGNER forcipi gengivali	60
WALDMANN forcipi ombelicali	60
WALLICH curette p. aborto	366
WALSHAM pinza p. la plastica	420
WALTON schiaccia comedoni	368
WARTENBERG sensimetro	14
WATSON-CHEYNE elevatore	269
WATSON-WILLIAMS cannula	422
WEBER anse	395
WEBER pinza p. aorta	153
WECKER forcipi oculistiche	401
WECKER spatole	393
WEEK blefarostati	389
WEIL-BLAKESLEY pinza nasale	416
WEITLANER divaricatore	229

WERTHEIM pinza p. isterectomia	126
WEST scalpello nasale	425
WESTCOTT forbici oculistiche	61
WESTON serranodi	304
WHITE pinza p. tonsille	437
WIENER raspa nasale	426
WIGMORE sega p. app. gessati	74
WILDE serranodi	406,420
WILDER anse	395
WILLET pinza emostatica MARTEL	102
WILLIAMS blefarostati	389
WILLIAMS pinza p. affer. intestino	131
WILLIGER curette taglienti	286,289
WILLIGER martello	210
WILLIGER periostotomo	206
WINTER ostetricia	365
WITTNER pinza tagl. p. biopsia	307
WOLFF pinza	74
WRIGLEY forcipe	364
WULLSTEIN canula	405
WULLSTEIN pinza	407
WYLIE dilatatori uterini	343

Y

YASARGIL divaricatore	270
YASARGIL pinza p. tumori	52
YASARGIL serrafini	448,470
YASARGIL tubi aspirazioni	280
YEOMAN pinza p. biopsia	296,304
YOUNG divaricatore	324
YOUNG pinza tiralingua	435

Z

ZAUFAL-JANSEN pinza sgorbie	249
ZENKER divaricatore	183
ZENKER pinza emostatica	109
ZIEGLER bisturi p capsule	391
ZIEGLER blefarostati	389
ZIEGLER specchio frontale	16
ZIELKE scalpello	200
ZÖLLNER tubi aspirazioni	280