

External Fixateur

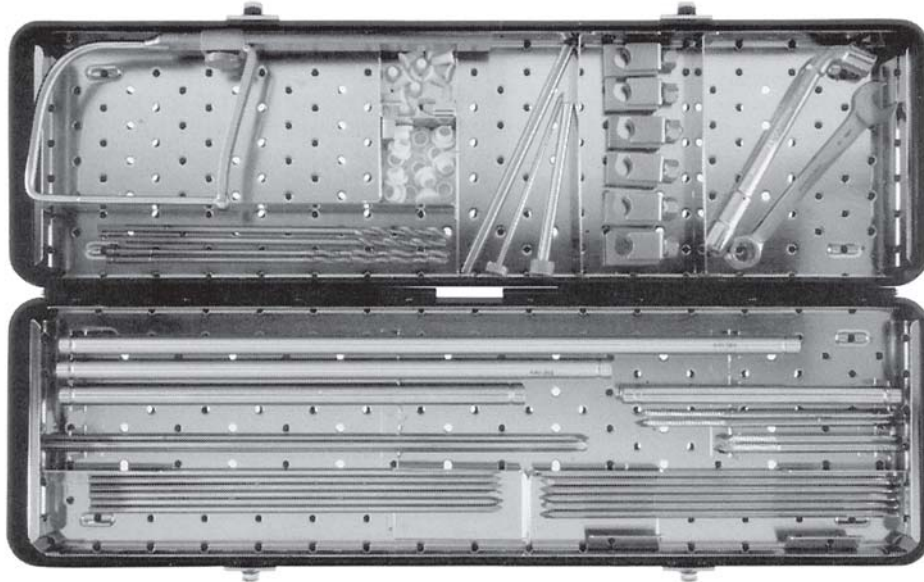

M 08000	Standard Set External Fixateur (Tubular System)		
M 01110	Aluminium Case Red		
M 08110	Upper Tray		
M 08120	Lower Tray		
	Instruments		
9023	Drill Bit, \varnothing 3.5 mm, extra long, with end to fit quick coupling	ea. 2	
9438	Combination Wrench, width across flats 11 mm		
80070	Socket Wrench, width across flats 11 mm		
80072	Hexagonal Allen Key		
80068	Universal Chuck with T-handle		
80080	Open Compressor	ea. 2	
80060	Drill Sleeve, 5.0 mm / 3.5 mm \varnothing , 100 mm length		
80061	Drill Sleeve, 5.0 mm / 3.5 mm \varnothing , 80 mm length		
80064	Drill Sleeve, 6.0 mm / 5.0 mm \varnothing		
80065	Drill Sleeve, 6.0 mm / 5.0 mm \varnothing		
80062	Trocar, 3.5 mm \varnothing		
80092	Trocar, 3.5 mm \varnothing		
	Implants		
81138	Steinmann Pin 5.0 mm \varnothing 150 mm length	ea. 6	
81140	Steinmann Pin 5.0 mm \varnothing 180 mm length	ea. 6	
81264- 81270	Schanz Screw 125, 150, 170, 200 mm length	ea. 6	24 pieces
	Fixation Material		
80198	Protective Cap for Fixation pins 5.0 mm \varnothing		
80170	Plug for Tubes		
80100- 80102	Tubes 100, 125 mm length	ea. 1	2 pieces
80104- 80114	Tubes 150, 200, 250, 300, 350, 400 mm length	ea. 2	
80190	Tube to Tube Clamps	ea. 2	
80180	Adjustable Clamp	ea. 4	
80186	Universal Joint for two tubes	ea. 2	
80188	Open clamp	ea. 12	



9023 Drill Bit 3.5 mm extra long
9027 Drill Bit 4.5 mm extra long



9438 Combination Wrench with across flats 11 mm



80068 Simple T-Handle for Steinmann Pin insertion



80070 Socket Wrench with across flats 11 mm
180 mm long, for threaded conical bolts
and external fixateur



80072 Hexagonal Allen Key



80092 Trocar with point ø 3.5 mm short



80062 Trocar for aiming device 3.5 long



80061 Drill Sleeve 5.0 / 3.5 mm short



80060 Drill Sleeve 5.0 / 3.5 mm long



80065 Drill Sleeve 6.0 / 5.0 mm short



80064 Drill Sleeve 6.0 / 5.0 mm long



80080 Open Compressor



80084 Bar with hook and sliding drill sleeve \varnothing 3.5 mm, 80 mm long



80090 Check Tube for Device Alignment



	Tubes 11 mm \varnothing		Carbon fiber rods 11 mm \varnothing
80100	100 mm length	80140	100 length
80102	125 mm length	80142	125 length
80104	150 mm length	80144	150 length
80106	200 mm length	80146	200 length
80108	250 mm length	80148	250 length
80110	300 mm length	80150	300 length
80112	350 mm length	80152	350 length
80114	400 mm length	80154	400 length
80116	450 mm length	80156	450 length
80118	500 mm length	80158	500 length
80120	550 mm length	80160	550 length
80122	600 mm length	80162	600 length



80170 Plug for Tubes



80180 Single Adjustable Clamp



80182 Single Open Clamp
with one nut for tightening both tube and Steinmann Pin
can also be mounted on tubes after External Fixator is assembled
i.e. for three-dimensional fixation



80186 Universal Joint for two tubes
for connecting two tubes



80188 Open adjustable clamp



80190 11 mm Tube-to Tube Clamp



80194 Universal Tube, compatible



80198 Protective Caps for Steinmann pins
5.0 mm dia.

External Fixator - Hofmann System

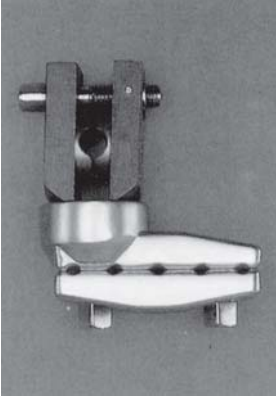

80800
Universal Joint Clamp for
5 pins and for connecting
rod

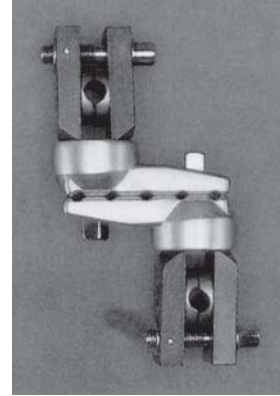

80802
Universal Joint Clamp for
5 pins and 2 connecting
rods / diagonal

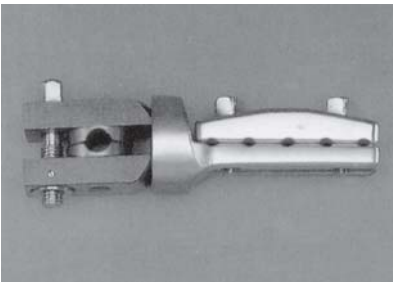

80804
Universal Joint Clamp for 5 pins
and for 1 connecting rod



80806
Universal Joint clamp for 5 pins
and for 2 connecting rods / parallel

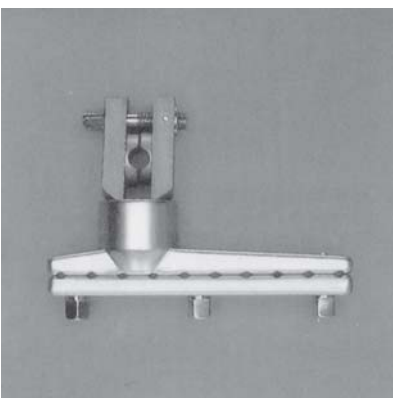

80810
Universal Joint Clamp for 10 pins
for 1 connecting rod



80812
Universal Joint Clamp for up to 10
pins for 2 connecting rods / diagonal

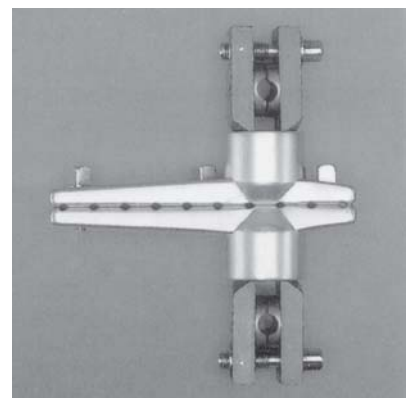

80814
Universal Joint Clamp for up to 10
pins for 2 connecting rods / diagonal

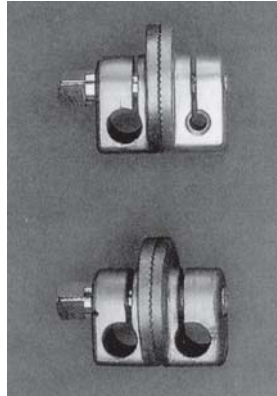

80820
Articulation Coupling
rod/pin 8 mm/4 mm
8 mm/5 mm

80822
Articulation Coupling
rod/rod 8 mm/8mm



Plain Connecting Rods dia. 8 mm
stainless

L = mm	steel
150	80830
200	80832
250	80834
300	80836
350	80838
400	80840
450	80842
500	80844

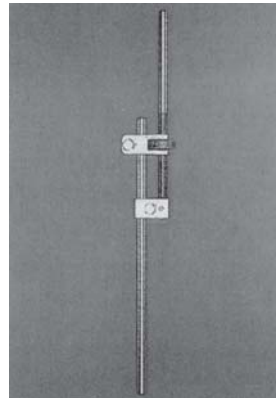

Adjustable Connecting Rod

L = mm	Cat. No.
350	80870

Length can be varied by use of Connecting Rods

80801 Simple Triangular Frame for Femur

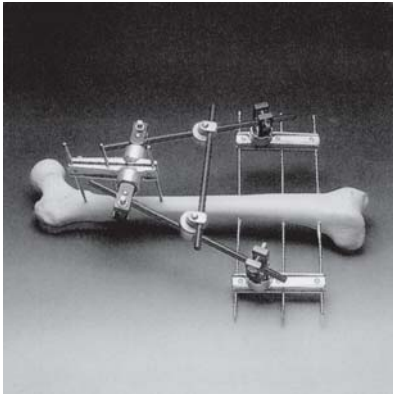

- 80810** 2 Universal Clamps
- 80814** 1 Universal Clamps
- 80820** 2 Articulation Couplings 8 x 8 mm
- 80830** 1 Connecting Rod 8 mm 150 mm
- 80836** 2 Connecting Rods 8 mm 300 mm
- 81228** 3 Schanz Screws 4.0 x 170 mm
- 81160** 3 Steinmann Pins with centre thread 4.0 mm 4.0 x 200 mm

Needed components:

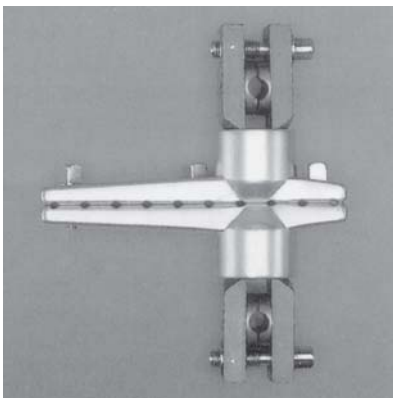

80814
Universal Joint Clamps for 10 pins
for 1 Connecting Rod



80810
Universal Joint Clamps for 10 pins
for 1 Connecting Rod / diagonal

80803 Unilateral Double Arthrodesis Frame

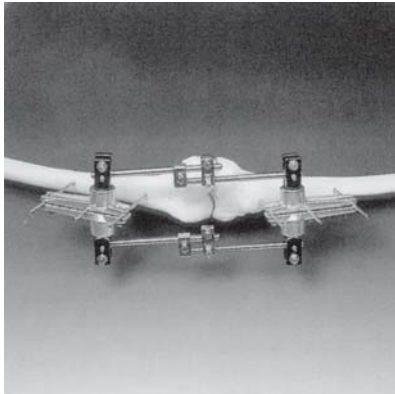

- 80814** 2 Universal Joint Clamps
- 80870** 2 Adjustable Connecting Rods
- 81224** 6 Schanz Screws 4.0 x 130 mm

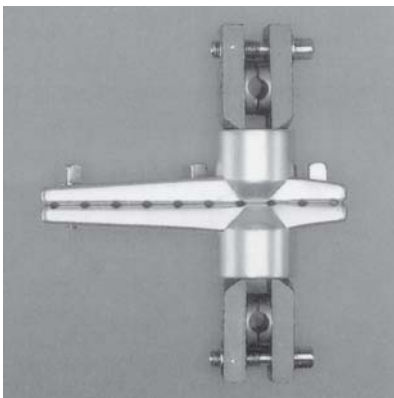

80814
Universal Joint Clamp for
10 pins and 3 Connecting Rods

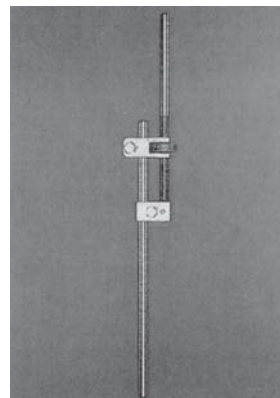

80870
Adjustable Connecting Rod

80805 Universal Double Frame for Tibia

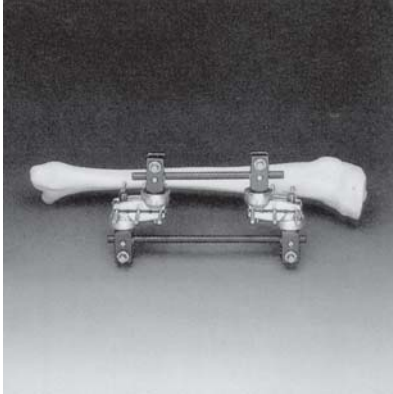

80805 Universal Double Frame for Tibia
components needed:

- 80802** 2 Universal Clamps
- 80830** 1 Connecting Rod 150 mm
- 80832** 1 Connecting Rod 200 mm
- 81224** 6 Schanz Screws 4.0 x 130 mm

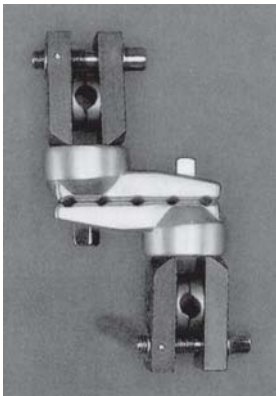

80802 Universal Joint Clamp for 5 Pins and
2 Connecting Rods/diagonal

80807 Simple Unilateral Frame for Tibia Elastic Fixation

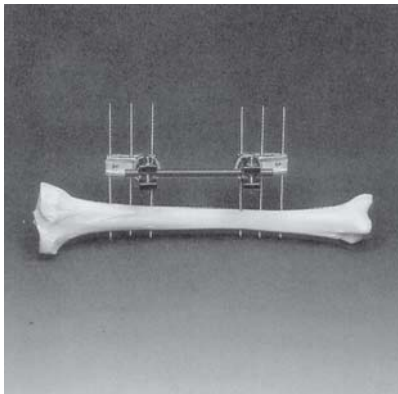

- 80807** Simple Unilateral Frame for Tibia Elastic Fixation
components needed
- 80800** 2 Universal Joint Clamps
 - 80830** 1 Connecting Rod 150 mm
 - 81224** 6 Schanz Screws 4.0 x 130 mm



- 80800** Universal Joint Clamp
for 5 Pins and for
1 Connecting Rod

80809 Unilateral Double Frame for Tibia (Lower 3rd Fractures)

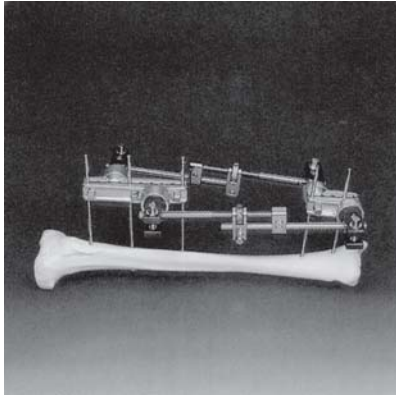

- 80809** Unilateral Double Frame for Tibia (Lower 3rd Fractures)
- 80802** 1 Universal Joint Clamp
- 80812** 1 Universal Joint Clamp
- 80870** 2 Adjustable Connecting Rods
- 81228** 6 Schanz Screws 4.0 x 170 mm

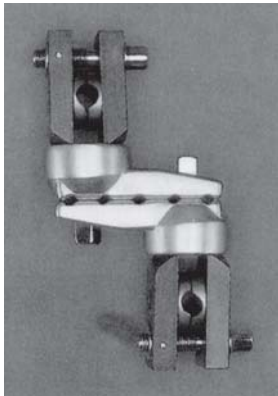

80802
Universal Joint Clamp for 5 Pins
and 2 Connecting Rods /
diagonal



80812
Universal Joint Clamp for up to 10 Pins

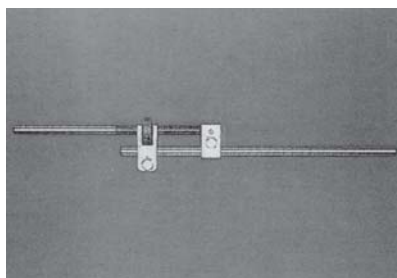

Adjustable Connecting Rod
L = 350 mm Cat. No.
350 **80870**

Length can be varied by use of
Connecting Rod

80811 Universal Double Frame for Tibia

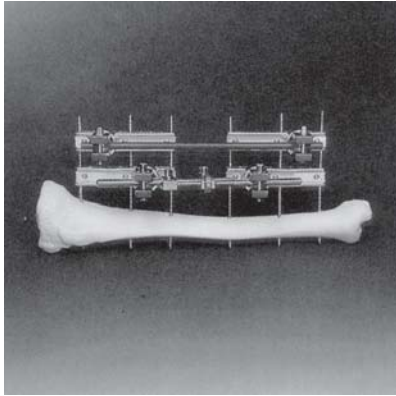

- 80811** Unilateral Double Frame for Tibia
components needed:
80810 4 Universal Joint Clamps
80834 1 Connecting Rod 250 mm
80870 Adjustable Connecting Rod



80810 Universal Joint Clamp

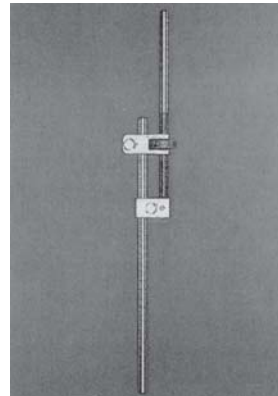

Adjustable Connecting Rod
L = 350 mm Cat. No.
350 **80870**

Length can be varied by use of
Connecting Rods

80813 Simple Unilateral Frame Elastic Fixation

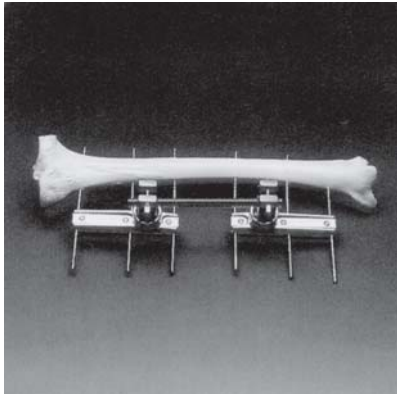

- 80813** Simple Unilateral Frame for Tibia (Elastic Fixation)
components needed:
80810 2 Universal Joint Clamps
80832 1 Connecting Rod 200 mm
81228 6 Schanz Screws 4.0 x 170 mm



- 80810**
Universal Joint Clamp for 10 Pins
for 1 Connecting Rod

80815 Trapezoidal Frame for Pelvis

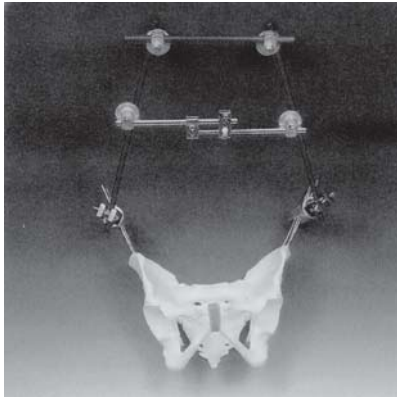

- 80815** Trapezoidal Frame for Pelvis
components needed:
- 80804** 2 Universal Joint Clamps
 - 80822** 4 Articulation Clamps
 - 80832** 1 Connecting Rod 200 mm
 - 80836** 2 Connecting Rods 300 mm
 - 80870** 1 Adjustable Connecting Rod
 - 81228** 3 Schanze Screws 4.0 x 170 mm

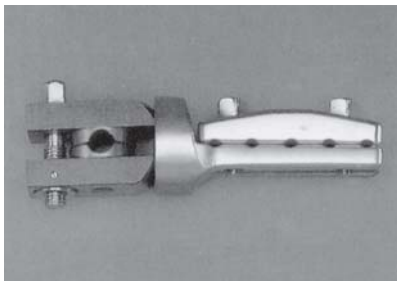

- 80804**
Universal Joint Clamp for 5 pins
and for 1 Connecting Rod

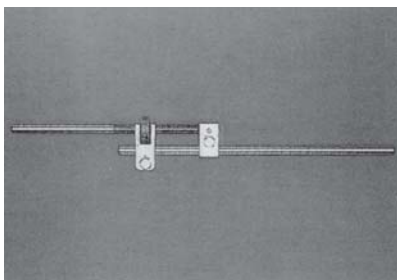

Adjustable Connecting Rod

L = mm
350

Cat. No.
80870



- 80822**
Articulation Coupling
8 mm / 8 mm

Midi - Fixateur - Externe

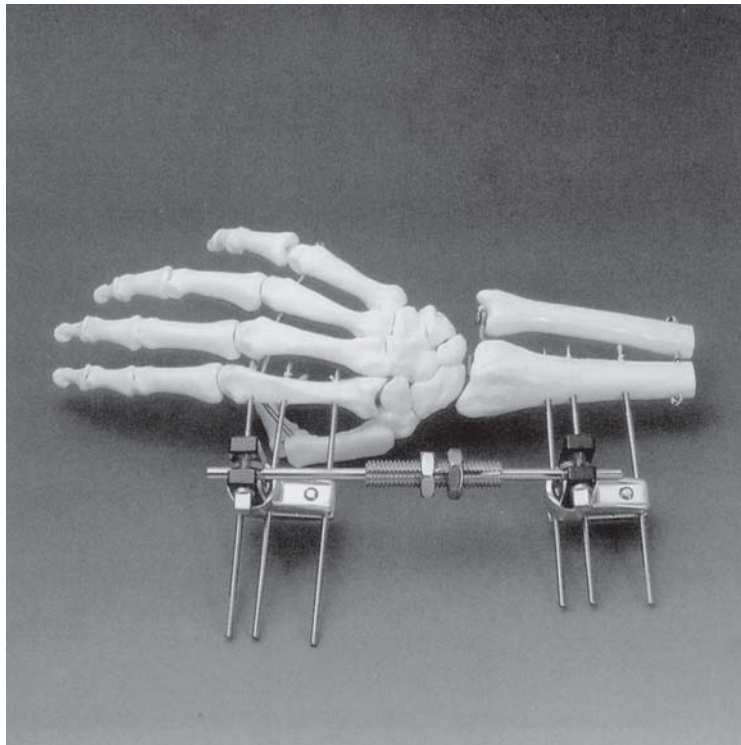

Midi - Fixateur

The forearm assembly requires smaller dimensions of components. In our hands the midi - version has been highly efficient in the management of distal radius fractures presenting the tendency to redislocate regardless of their original type. Lower weight and price compared to other systems together with ease and versatility of handling has made the midifixateur indispensable in our unit.

(Klinikum Villingen-Schwenningen, PD Dr. H. Henkemeyer)

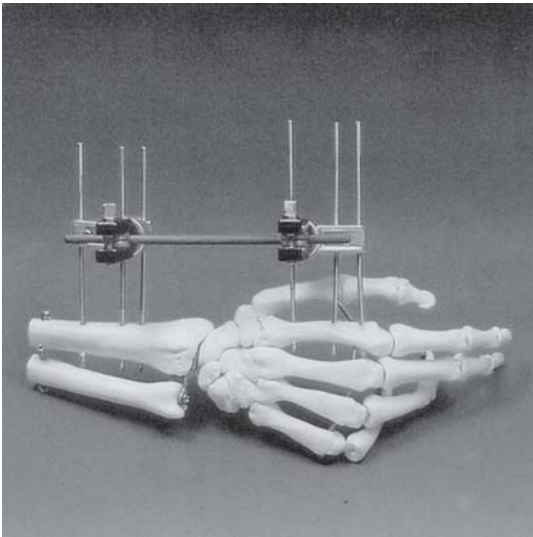

80817 Simple Distal Radius Frame
80900 2 Universal Joint Clamps
80912 2 Connecting Rods 150 mm
81202 6 Schanz Screws 3.0 x 80 mm

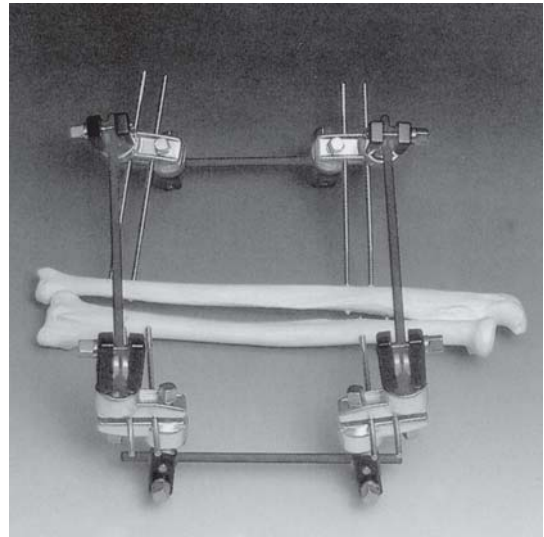

80819 Forearm Frame
80902 4 Universal Joint Clamps
80912 2 Connecting Rods 150 mm
80914 2 Connecting Rods 200 mm
81202 8 Schanz Screws 3.0 x 80 mm



80900
 Universal Joint Clamp
 for 4 pins and for 1
 Connecting Rod



80902
 Universal Joint Clamp
 for 4 pins and 2
 Connecting Rods / diagonal

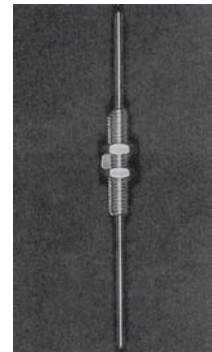

80904
 Adjustable Connecting
 Rod \varnothing 5 mm

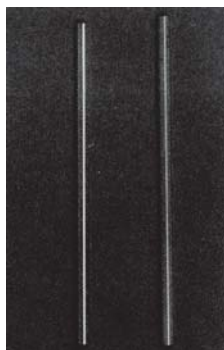

Plain Connecting Rods \varnothing 5 mm

L = mm	steel	carbon
100	80910	80920
150	80912	80922
200	80914	80924
250	80916	80926
300	80918	80928

Instruments for Maxi and Midi External Fixation

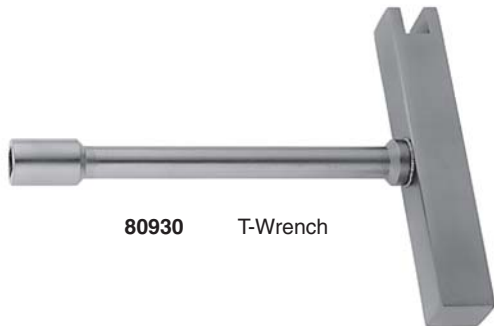

80930 T-Wrench



9090 T-Handle with quick action chuck



80934 Spanner width 7 mm



80936 Drill Brace



80942 Drill Sleeve for 2.5 mm Twist Drill



80944 Drill Sleeve for 3.2 mm Twist Drill
80946 Drill Sleeve for 4.0 mm Twist Drill
80948 Drill Sleeve for 4.5 mm Twist Drill

Instruments for Maxi and Midi External Fixation



80954 Maxi External Fixation Pin-Guide



80956 Midi External Fixation Pin-Guide



- 80947** Twist Drill d=2.5 mm for 3 mm pins
- 80951** Twist Drill d=3.2 mm for 4 mm pins
- 80955** Twist Drill d=4.0 mm for 5 mm pins
- 80957** Twist Drill d=4.5 mm for 6 mm pins



- 80960** Guide Sleeve for 4 mm pins
- 80962** Guide Sleeve for 5 mm pins



80870 Adjustable Connecting Rod



- 80970** Stop clip 5 mm
- 80972** Stop clip 8 mm



80904 Adjustable Connecting Rod ø 5 mm



4184 Applying Forceps

Steinmann Pins



Point	Trocar	Trocar	Trocar	Trocar
Shaft end	Triangular	Triangular	Triangular	Triangular
Length	ø 3.5 mm	ø 4.0 mm	ø 4.5 mm	ø 5.0 mm
120 mm	81100	81112	81124	81136
150 mm	81102	81114	81126	81138
180 mm	81104	81116	81128	81140
200 mm	81106	81118	81130	81142
250 mm	81108	81120	81132	81144
300 mm	81110	81122	81134	81146



- 81147** Protective Caps for Steinmann Pins 3.0 mm
- 81148** Protective Caps for Steinmann Pins 4.0 mm
- 81149** Protective Caps for Steinmann Pins 5.0 mm

Steinmann Pins with Central Thread with Trocar Point and Triangular Shaft
 (on request, available in other shafts needed)



thread - \varnothing is 0.5 mm
 more than pin - \varnothing

Order No.	mm \varnothing	Length mm
81150	3.00	150
81151	3.00	180
81152	3.00	200
81153	3.00	230
81154	3.50	150
81155	3.50	180
81156	3.50	200
81157	3.50	230
81158	4.00	150
81159	4.00	180
81160	4.00	200
81161	4.00	230
81162	4.00	250
81163	4.50	150
81164	4.50	180
81165	4.50	200
81166	4.50	230
81167	4.50	250
81168	4.50	300
81169	5.00	150
81170	5.00	180
81171	5.00	200
81172	5.00	230
81173	5.00	250
81174	5.00	300

Schanz Screws (with Trocar Point and Triangular Shaft)



Order No.	mm \varnothing	Length mm	Thread length mm
81200	3.00	60	20
81202	3.00	80	20
81220	4.00	60	25
81222	4.00	100	25
81224	4.00	130	25
81228	4.00	170	25
81240	4.50	100	50
81242	4.50	120	50
81244	4.50	150	50
81246	4.50	170	50
81248	4.50	200	50
81250	4.50	250	50
81260	5.00	100	50
81264	5.00	125	50
81266	5.00	150	50
81268	5.00	170	50
81270	5.00	200	50
81272	5.00	250	50
81280	6.00	100	30
81284	6.00	150	50
81285	6.00	170	50
81286	6.00	200	50
81287	6.00	250	50

Cortical Screws
 ø Shaft 6 mm
 ø Thread 6/5 mm
 ø Drill 4.8 mm



Total length mm	Thread length mm							
	30	40	50	60	70	80	90	100
90	81350							
100	81352	81356						
110		81358	81370					
120		81360		81380				
130		81362	81372	81382				
140			81374					
150				81384				
160					81390		81400	
170						81396		
180							81402	81410
200						81398	81404	

Cancellous Screws
 ø Shaft 6 mm
 ø Thread 6/5 mm
 ø Drill 4.8 mm



Total length mm	Thread length mm			
	30	40	50	60
90	81450			
100	81452	81456		
110		81458	81464	
120		81460		81470
130		81462	81466	81472
150			81468	81474

Blunt Half Pin, self tapping, with Triangle End



Order No.	mm ø	Length mm	Thread length mm	Twist Drill
81500	3.00	75	25	25
81502	3.00	110	22	25
81504	4.00	120	45	45
81506	5.00	120	40	40
81508	5.00	150	50	50
81510	5.00	180	50	50
81512	6.00	150	50	50
81514	6.00	180	50	50
81516	6.00	200	60	60

Threaded Steinmann Pins 230 mm
Trocar point and round end



Diameter	2.0	2.5	3.0	3.5	4.0	4.5	5.0
Cat. No.:	81600	81602	81604	81606	81608	81610	81612

Calibrated Steinmann Pins 230 mm (Watson Jones)
Trocar point and round end



Diameter	2.0	2.5	3.0	3.5	4.0	4.5	5.0
Cat. No.:	81620	81622	81624	81626	81628	81630	81632

MATTES Dynamic Axial Fixateur



80400
Long Model



80402
Standard Model



80404
Short Model

**MATTES Dynamic Axial Fixateur
with articulated body**



80410
Long Model

80412
Standard Model

**MATTES Dynamic Axial Fixateur
with T clamp**



80420
Long Model

80422
Standard Model

80424
Short Model

MATTES Limb Lengthener Fixateur



80430
Long Model



80432
Standard Model



80434
Short Model

MATTES Limb Reconstruction Fixateur



80440

23 cm long with 2 clamps and 1 compression - distraction units

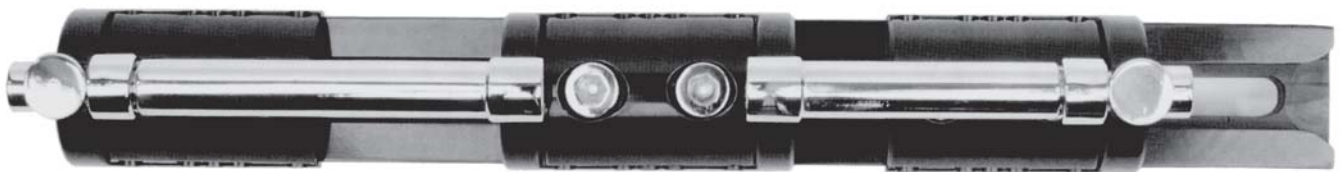

80442

40 cm long with 3 clamps and 2 compression - distraction units

Small External Fixateur for Hand and Forearm



M 08060	Small External Fixateur for Hand and Forearm	
152020	Small Aluminium Case, blue, perforated 300 x 140 x 70 mm	
152115	Trays for small instruments (2 pieces)	
9014	Drill Bit 2.0 mm	2 pieces
9016	Drill Bit 2.5 mm	2 pieces
80934	Combination Wrench width across flats 7 mm	1 piece
80246	Socket Wrench 7 mm	1 piece
80248	Drill Sleeve complete	1 piece
80210 -	Connecting Bars	24 pieces
	2 each: 60 - 160 - 180 -200 mm	
80217	4 each: 80 - 100 - 120 - 140 mm	
80240	Clamps Open	4 pieces
80242	Clamps	12 pieces
80256	Springloaded Nut	2 pieces
80250	Schanz Screw 4.0 x 3.0 mm	4 pieces
7260	Kirschner Wire 1.6 x 150 mm	10 pieces
7264	Kirschner Wire 2.0 x 150 mm	10 pieces
7315	Kirschner Wire with Thread 15 mm, 2.5 x 150 mm	10 pieces

Small External Fixater Set



9014 Dril Bit 2.0 mm
9016 Dril Bit 2.5 mm



80934 Combination Wrench,
width across flats, 7 mm



80248 Drill Sleeve complete

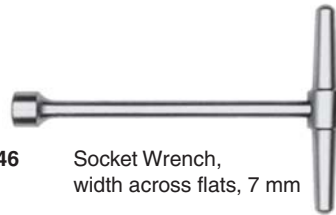

80246 Socket Wrench,
width across flats, 7 mm



80250 Drill Sleeve 5.0 / 4.0 mm



80251 Drill Sleeve 5.0 / 4.0 mm



80252 Trokar, \varnothing 2.7 mm



Connecting Bars, 4.0 mm diam.
stainless steel

80210	60 mm
80211	80 mm
80212	100 mm
80213	120 mm
80214	140 mm
80215	160 mm
80216	180 mm
80217	200 mm



80240 Clamp Open
2.5 - 5.0 mm \varnothing



80242 Clamp 2.5 - 5.0 mm \varnothing



80244 Open Compressor

80254 Schanz Screws
 \varnothing 4.0 / 3.0 mm - 80 mm

80255 Schanz Screws
 \varnothing 4.0 - 80 mm



80256 Springloaded Nut

MAITIS



ORTHO DYNO - FIX
EXTERNAL FIXATEUR SYSTEM

External Fixateur ORTHO DYNO FIX for Femur and Tibia

Material: Special aluminium alloys
 Type: Dynamic Axial, Long, Standard, Short
 Move angle: 50°
 Diameter: 30 mm



80406
135° Clamp



80408
T Clamp

Cat. No.:	Type	Length	Weight gr	Lengthening
80404	Short	230	600	25
80402	Standard	250	640	45
80400	Long	280	700	65

External Fixateur ORTHO DYNO FIX



80414
Pylon Clamp with long and standard fixator

Cat. No.:	Type	Length	Weight gr
80410	Long	280	700
80412	Standard	250	640

Limb Lengthener Fixateur
Femur and Tibia
DINO-FIX



Cat. No.:	Type	Length mm	Weight gr	Lengthening
80430	Long	230	540	80
80432	Standard	200	480	60
80434	Short	180	420	50

LIMB Reconstruction Fixateur for Femur and Tibia DINO-Fix



80440
Short Model
200 mm long with 2 clamps



80442
Standard Model
250 mm long with 3 clamps



80444
Long Model
300 mm long with 3 clamps

Cat. No.:	Type	Length mm	Weight gr
80440	Short	200	410
80442	Standard	250	480
80444	Long	300	560

External Fixateur for Pelvic



Pelvic External Fixator with Clamp	
Cat. No.:	Model
80450	Short
80452	Standard
80454	Long

Rod and Clamp Fixateur Multipurpose



Rod and Clamp Fixator Multipurpose	
Cat. No.:	Model
80460	Short
80462	Standard
80464	Long
80466	Small

Axial Fixator for Humerus and Small Tibia

Material: Special Aluminium Alloys
 Type: Dynamic Axial, Long, Standard
 Move Angle: 45°
 Diameter: 25 mm



80474
T Clamp

Cat. No.	Type	Length mm	Lengthening mm	Weight gr
80470	Standard	170	25	300
80472	Long	195	46	340

External Fixator for Hand - Wrist and Radius



Cat. No.	Type
80480	Short
80482	Standard
80484	Long



Cat. No.:	
9023	Drill Bit 3.5 mm extra long 180 mm
9027	Drill Bit 4.5 mm extra long 180 mm
1.11864	Drill Bit 2.7 mm 150 mm
1.11866	Drill Bit 4.0 mm 150 mm
1.11867	Drill Bit 4.8 mm 150 mm

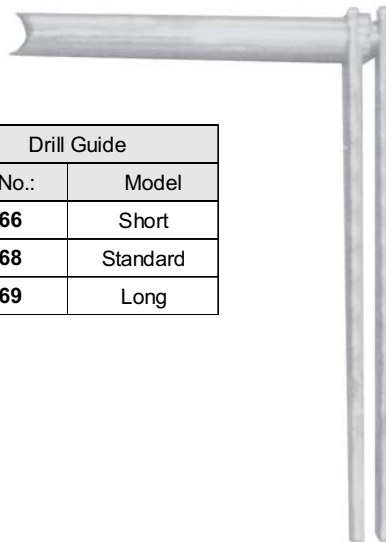

Drill Guide	
Cat. No.:	Model
80366	Short
80368	Standard
80369	Long

Schanz Screws (with Trocar Point and Triangular Shaft)



Order No.	mm \varnothing	Length mm	Thread length mm
81200	3.00	60	20
81202	3.00	80	20
81220	4.00	60	25
81222	4.00	100	25
81224	4.00	130	25
81228	4.00	170	25
81240	4.50	100	50
81242	4.50	120	50
81244	4.50	150	50
81246	4.50	170	50
81248	4.50	200	50
81250	4.50	250	50
81260	5.00	100	50
81264	5.00	125	50
81266	5.00	150	50
81268	5.00	170	50
81270	5.00	200	50
81272	5.00	250	50
81280	6.00	100	30
81284	6.00	150	50
81285	6.00	170	50
81286	6.00	200	50
81287	6.00	250	50

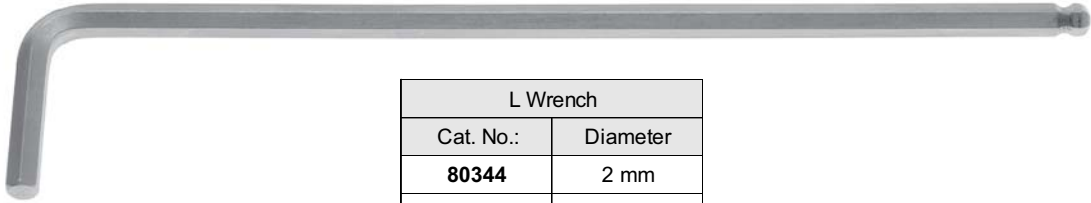

L Wrench	
Cat. No.:	Diameter
80344	2 mm
80343	3 mm
80339	4 mm
80338	5 mm
80345	6 mm



T Wrench	
Cat. No.:	Diameter
80927	3 mm
80928	4 mm
80929	5 mm
80930	6 mm



9090 T-Handle with quick action chuck



80068 Simple T-Handle for Steinmann Pin insertion

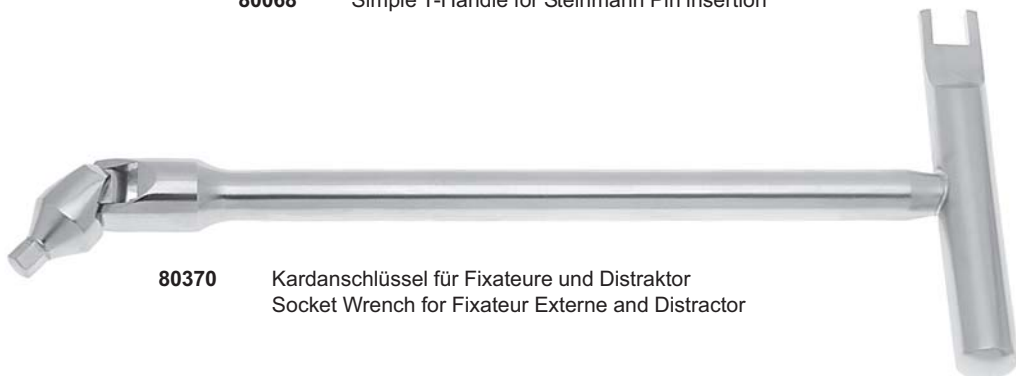

80370 Kardanschlüssel für Fixateure und Distraktor
Socket Wrench for Fixateur Externe and Distractor

MATTES

Cortical Screws

Ø Shaft 6 mm

Ø Thread 6/5 mm · Konic

Ø Drill 4.8 mm



Total length mm	Thread length mm			
	30	40	50	60
90	81350			
100	81352	81356		
110	81353	81358	81370	
120		81360		81380
130	81354	81362		81382
140			81374	
150	81355	81364	81376	81384
160			81377	
170		81366		81386
180			81378	81387
190			81379	81388

Cancellous Screws

Ø Shaft 6 mm

Ø Thread 6/5 mm · Konic

Ø Drill 4.8 mm



Total length mm	Thread length mm			
	30	40	50	60
90	81450			
100	81452	81456		
110		81458	81464	
120		81460		81470
130		81462	81466	81472
150			81468	81474

Finger and Mandibula Fixateur



Cat. No.	Type
80500	Long
80502	Standard
80504	Short



8051 Set

- 7300** Kirschnerdraht mit Gewinde und Trokarspitze \varnothing 1,8 mm, 70 mm lang, 10 mm Gewinde
Kirschner Wire with thread and trocar point \varnothing 1.8 mm, 70 mm long, 10 mm thread
- 7301** Kirschnerdraht mit Gewinde und Trokarspitze \varnothing 1,6 mm, 70 mm lang, 10 mm Gewinde
Kirschner Wire with thread and trocar point \varnothing 1.6 mm, 70 mm long, 10 mm thread



7430
TC 180 mm
weicher Draht 2,0 mm
soft Wire 2.0 mm
harter Draht 1,5 mm
hard Wire 1.5 mm



7432
TC 180 mm
Front und Seitenschneider
front and lateral cutting action
weicher Draht 2,0 mm
soft Wire 2.0 mm
harter Draht 1,5 mm
hard Wire 1.5 mm



7388

Extraktionszange für Bohrdraht, 130 mm
Extraction Pliers for Boring Wire, 130 mm

7390

Extraktionszange für Bohrdraht, 180 mm
Extraction Pliers for Boring Wire, 180 mm

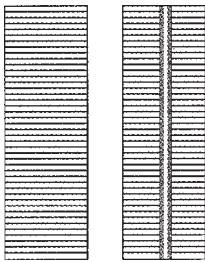

7400

Parallel - Flachzange mit Seitenschneider
180 mm Chrom Vanadium
Flat - Nose Pliers parallel, with lateral Wire
cutter 180 mm Chrom Vanadium

7402

Parallel - Flachzange ohne Seitenschneider
180 mm Stainless Steel
Flat - Nose Pliers parallel, without lateral
wire cutter 180 mm Stainless Steel