

---

KLEMMEN  
HEMOSTATS  
PINZAS HEMOSTATICAS  
PINCES HEMOSTATIQUES  
PINZE EMOSTATICHE

AA

nopa<sup>®</sup> instruments



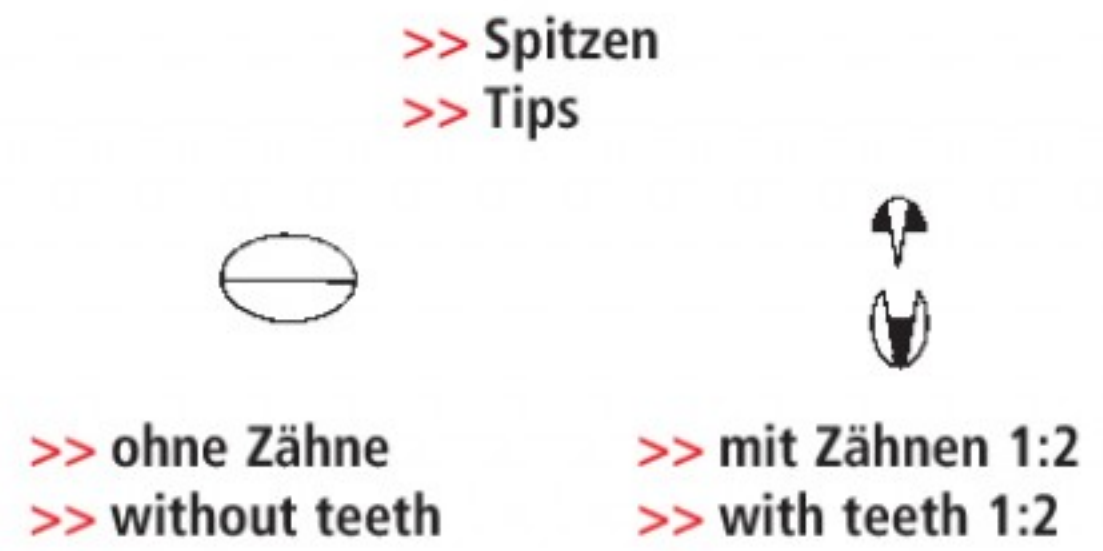
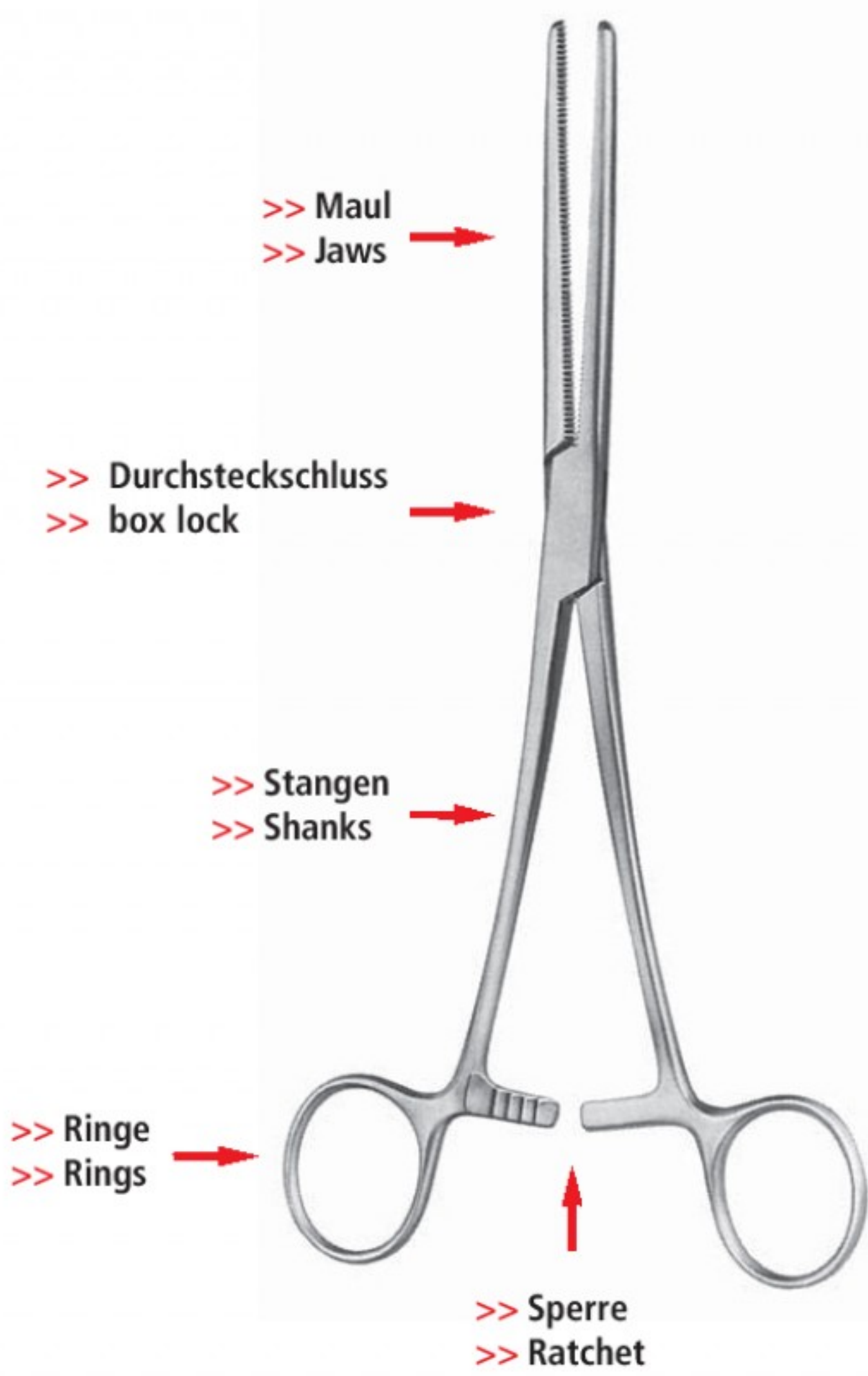

>> Maulbiegung  
>> jaw curvature

>> Riefung  
>> serrations

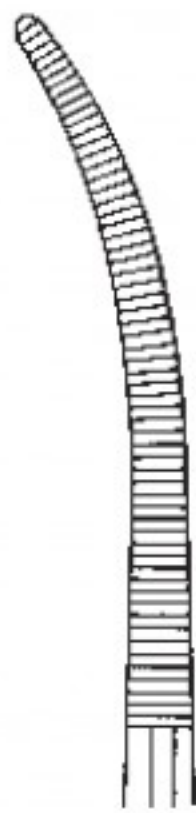

>> gerade  
>> straight

>> gebogen  
>> curved



>> quer  
>> horizontal



>> längs  
>> longitudinal



>> kreuz  
>> cross

KLEMMEN HEMOSTATS PINZAS HEMOSTATICAS PINCES HEMOSTATIQUES PINZE EMOSTATICHE

Gewebefasszangchen, Darmfasszangen  
 Tissue Seizing Forceps  
 Pinzas para coger tejidos e intestinos  
 Pinces pour saisir le tissu et l'intestin  
 Pinze per afferrare tessuti e l'intestino

AA  
 AB  
 AC  
 AD  
 AE  
 AF  
 AK  
 AL  
 AM  
 AO  
 AP  
 AR  
 KA  
 KB  
 KC  
 KD  
 KU  
 KY



**ALLIS 4:5**  
 KD 054/15  
 15,0 cm/6"



**ALLIS 5:6**  
 15,0 cm/6"      KD 055/15  
 19,0 cm/7 1/2"      KD 055/19  
 25,0 cm/10"      KD 055/25



**BABCOCK**



KD 111/16  
 16,0 cm/6 1/4"



KD 111/18  
 18,0 cm/7"



KD 111/20  
 20,0 cm/8"

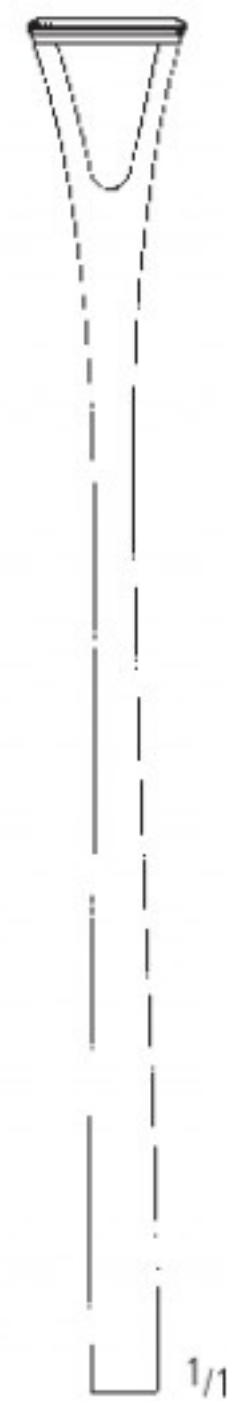

KD 111/24  
 24,0 cm/9 1/2"



**AA**

**KLEMMEN HEMOSTATS PINZAS HEMOSTATICAS PINCES HEMOSTATIQUES PINZE EMOSTATICHE**

Bulldogklemmen  
Bulldog Clamps  
Clamps Bulldog  
Clamps Bulldog  
Pinze Bulldog

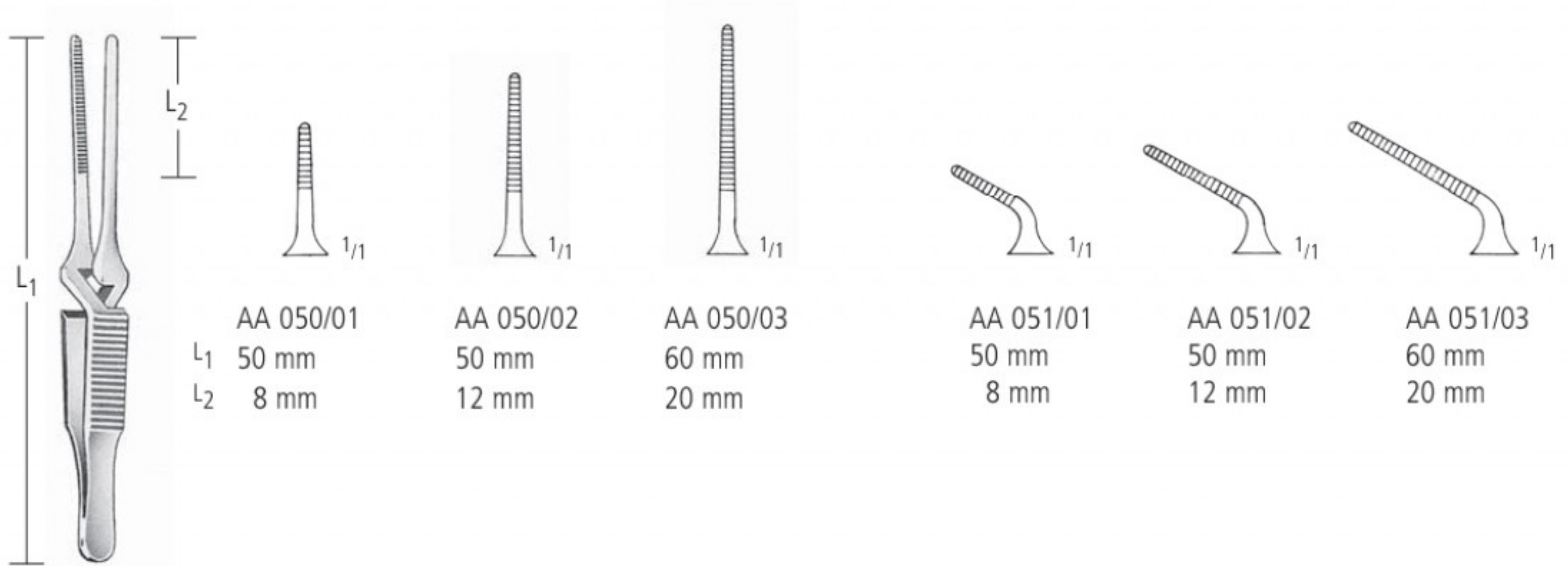

AA 050/01  
L<sub>1</sub> 50 mm  
L<sub>2</sub> 8 mm

AA 050/02  
50 mm  
12 mm

AA 050/03  
60 mm  
20 mm

AA 051/01  
50 mm  
8 mm

AA 051/02  
50 mm  
12 mm

AA 051/03  
60 mm  
20 mm

3 gr. Gewicht  
50 gr. Druck  
Gewicht  
Druck  
Weight  
Pressure  
Peso  
Presión  
Poids  
Pression  
Peso  
Pressione

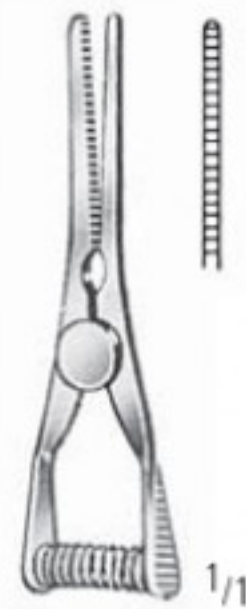
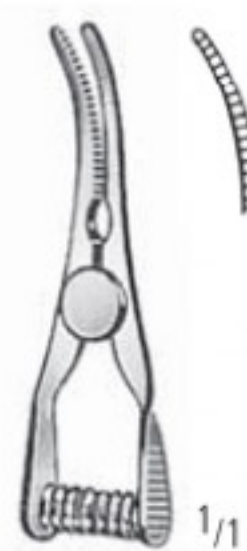
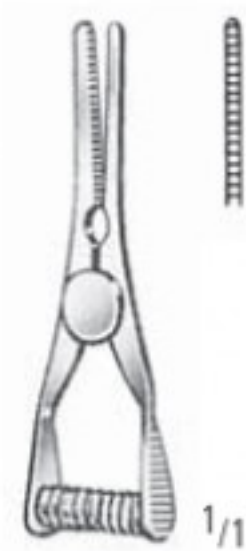

**VENA ARTERIA**

AA 052/01  
AA 053/01

**TITAN 30 mm**  
AA 052/02  
AA 053/02

AA 052/03  
AA 053/03

AA 054/01  
AA 055/01

**TITAN 35 mm**  
AA 054/02  
AA 055/02

AA 054/03  
AA 055/03



**VENA ARTERIA**

AA 056/01  
AA 057/01

**TITAN 40 mm**  
AA 056/02  
AA 057/02

AA 056/03  
AA 057/03

AA 058/01  
AA 059/01

**TITAN 50 mm**  
AA 058/02  
AA 059/02

AA 058/03  
AA 059/03



KLEMMEN HEMOSTATS PINZAS HEMOSTATICAS PINCES HEMOSTATIQUES PINZE EMOSTATICHE

Bulldogklemmen, Anlegezange  
 Bulldog Clamps, Setting Forceps  
 Clamps Bulldog, Pinza para poner  
 Clamps Bulldog, Pince à poser  
 Pinze Bulldog, Pinza per posizionare

AA

AB

AC

AD

AE

AF

AK

AL

AM

AO

AP

AR

KA

KB

KC

KD

KU

KY



**DIEFFENBACH**



AA 060/03  
3,5 cm/1 1/2"

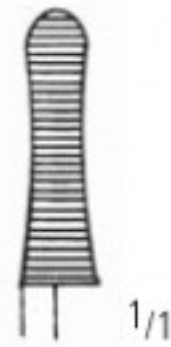

AA 060/05  
5,0 cm/2"

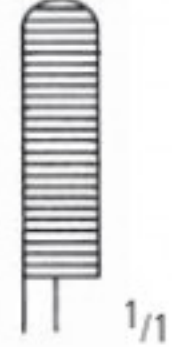

AA 060/06  
6,0 cm/2 1/2"



AA 061/03  
3,5 cm/1 1/2"

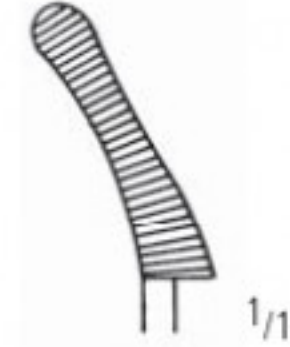

AA 061/05  
5,0 cm/2"



AA 061/06  
6,0 cm/2 1/2"



**JOHNS-HOPKINS**

AA 069/24  
24,5 cm/9 3/4"



**JOHNS-HOPKINS**

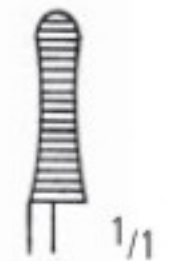

AA 070/04  
4,0 cm/1 1/2"



AA 070/05  
5,0 cm/2"

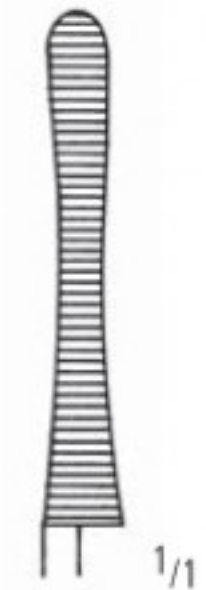

AA 070/06  
6,5 cm/2 1/2"

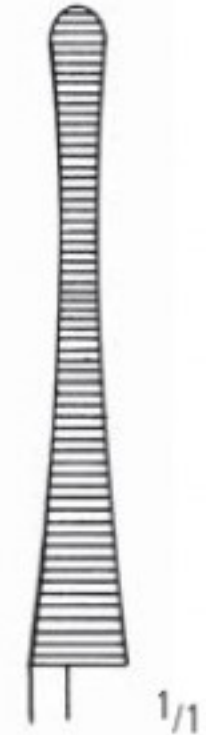

AA 070/07  
7,5 cm/3"

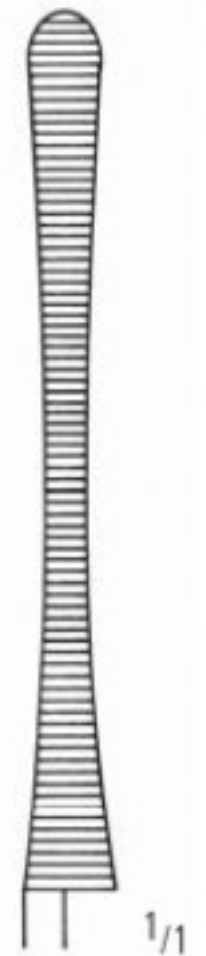

AA 070/09  
9,0 cm/3 1/2"



AA 071/04  
4,0 cm/1 1/2"



AA 071/05  
5,0 cm/2"

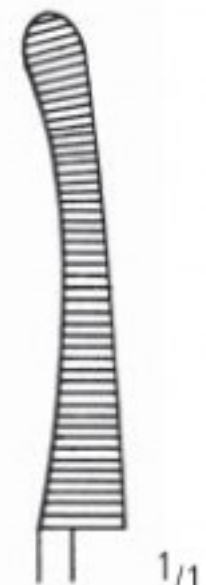

AA 071/06  
6,5 cm/2 1/2"

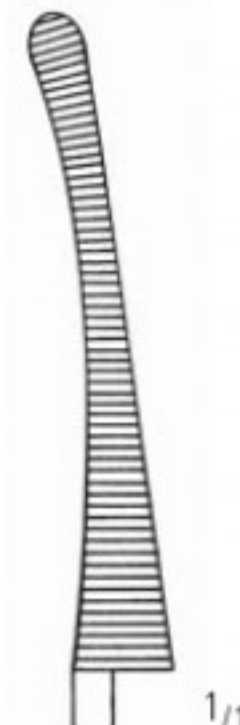

AA 071/07  
7,5 cm/3"

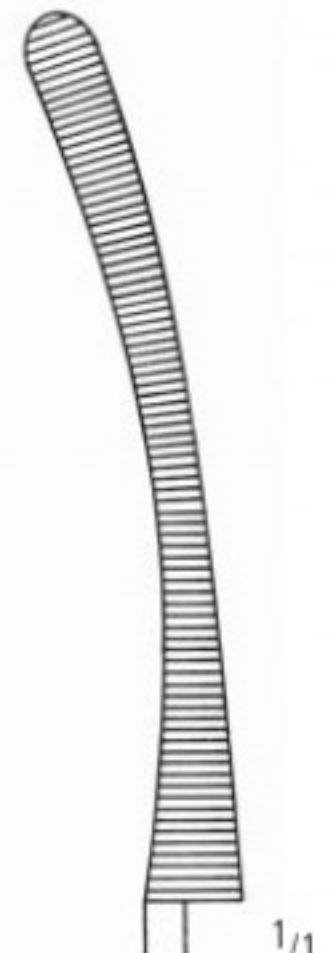

AA 071/09  
9,0 cm/3 1/2"

Fasszangen, Gefäßklemme, Kopfhautklemmen  
 Seizing Forceps, Blood Vessel Clamps, Scalp Flap Forceps  
 Pinzas para coger, Clamps para vasos, Pinzas hemostáticas para pericráneo  
 Pincers à saisir, Pincers vasculaire, Pincers hémostatiques pour le cuir chevelu  
 Pinze per afferrare, Pinza per vasi, Pinze emostatiche per il cuoio capelluto



**CHAPUT**  
 AA 072/02  
 13,0 cm/5"



**TUFFIER**  
 AA 072/04  
 13,0 cm/5"

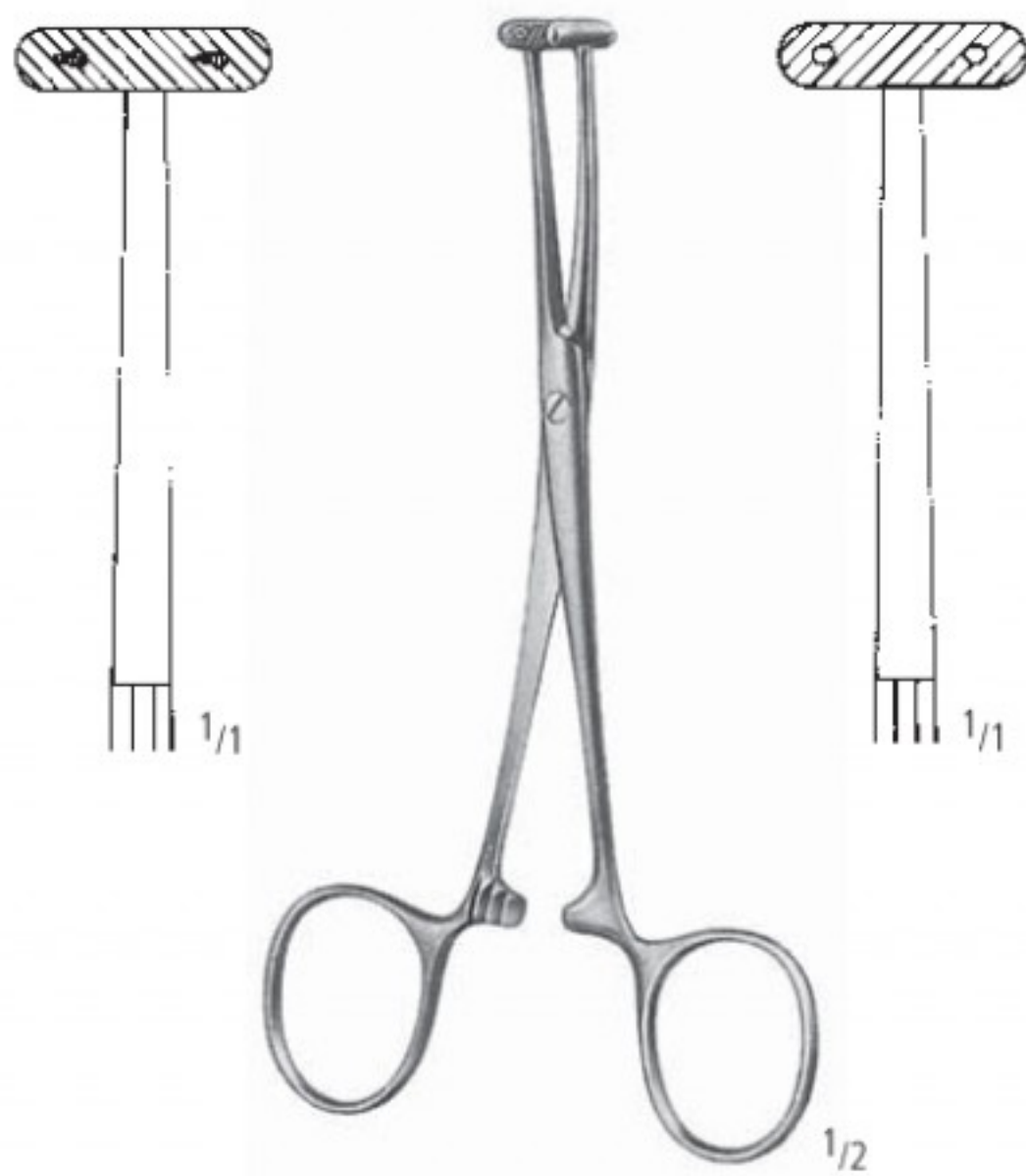

**MARTEL**  
 AA 078/14  
 14,0 cm/5 1/2"

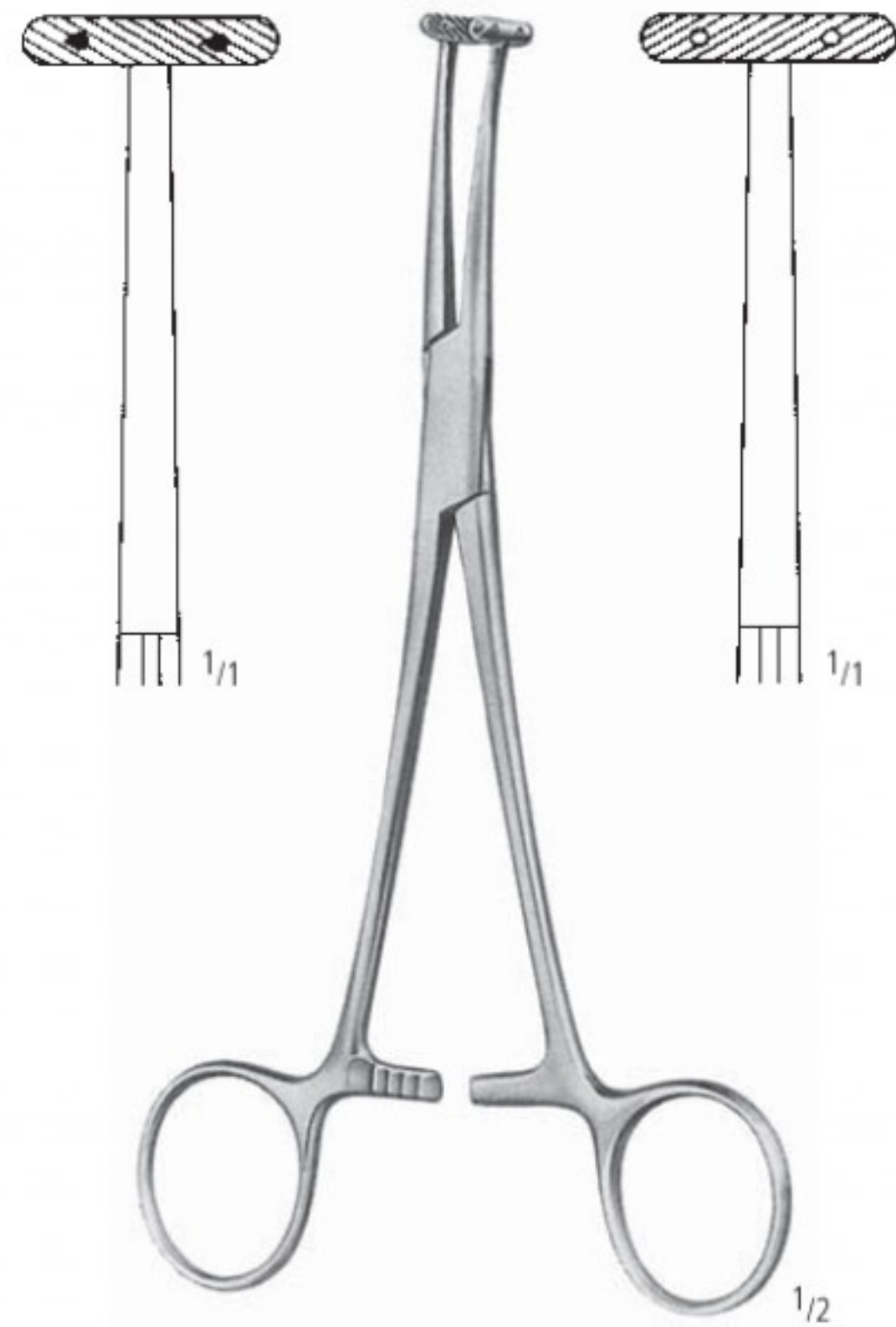

**WILLET-MARTEL**  
 AA 078/19  
 19,0 cm/7 1/2"



KLEMMEN HEMOSTATS PINZAS HEMOSTATICAS PINCES HEMOSTATIQUES PINZE EMOSTATICHE

Arterienklemmen, Faszangen  
 Artery Forceps, Seizing Forceps  
 Pinzas hemostáticas, Pinzas para coger  
 Pincés hémostatiques, Pincés à saisir  
 Pinze emostatiche, Pinze per afferrare

AA

AB

AC

AD

AE

AF

AK

AL

AM

AO

AP

AR

KA

KB

KC

KD

KU

KY

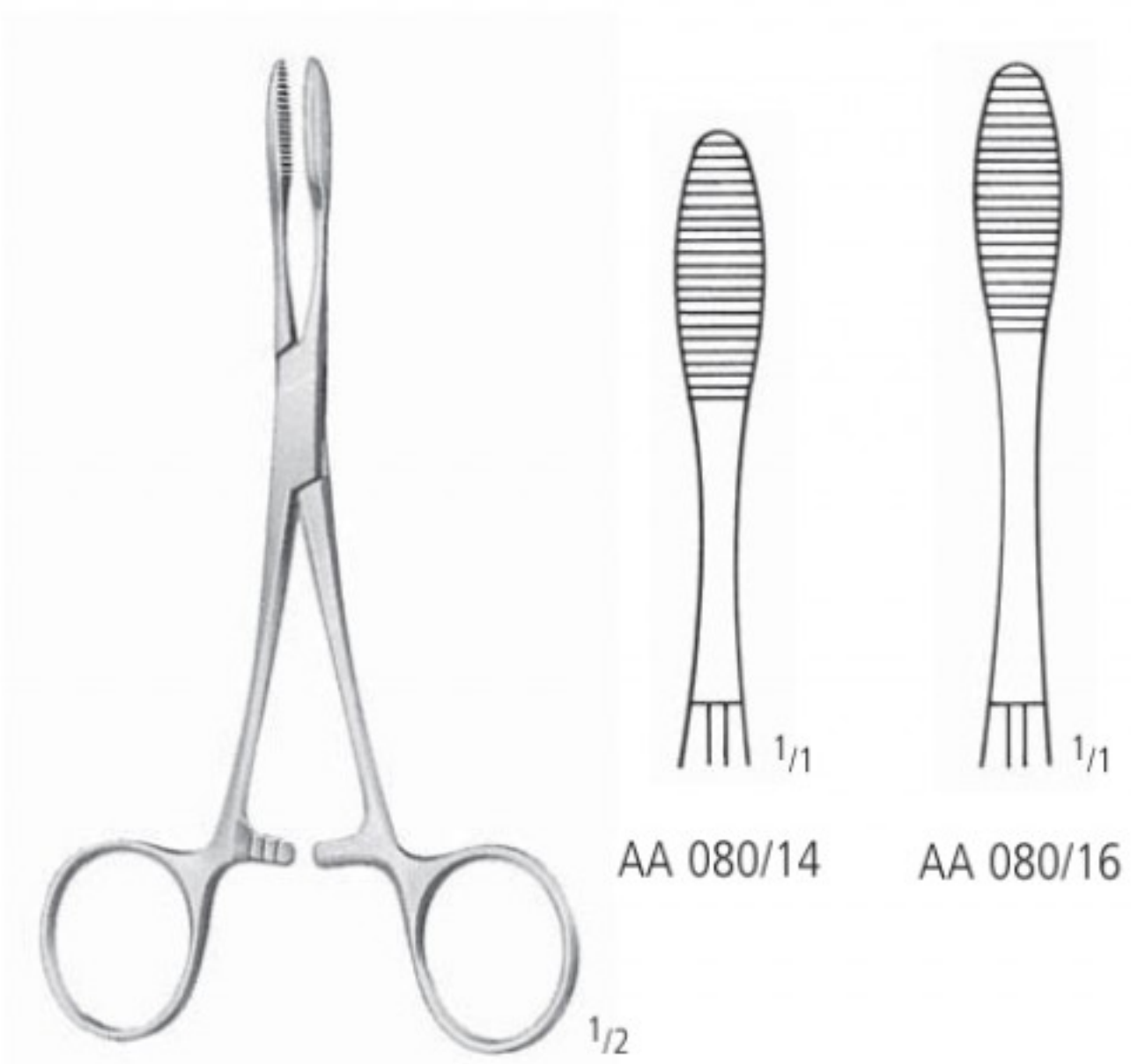

**PEAN**  
 14,0 cm/5<sup>1</sup>/<sub>2</sub>" AA 080/14  
 16,0 cm/6<sup>1</sup>/<sub>4</sub>" AA 080/16



**KROENLEIN**  
 AA 082/13  
 13,0 cm/5"

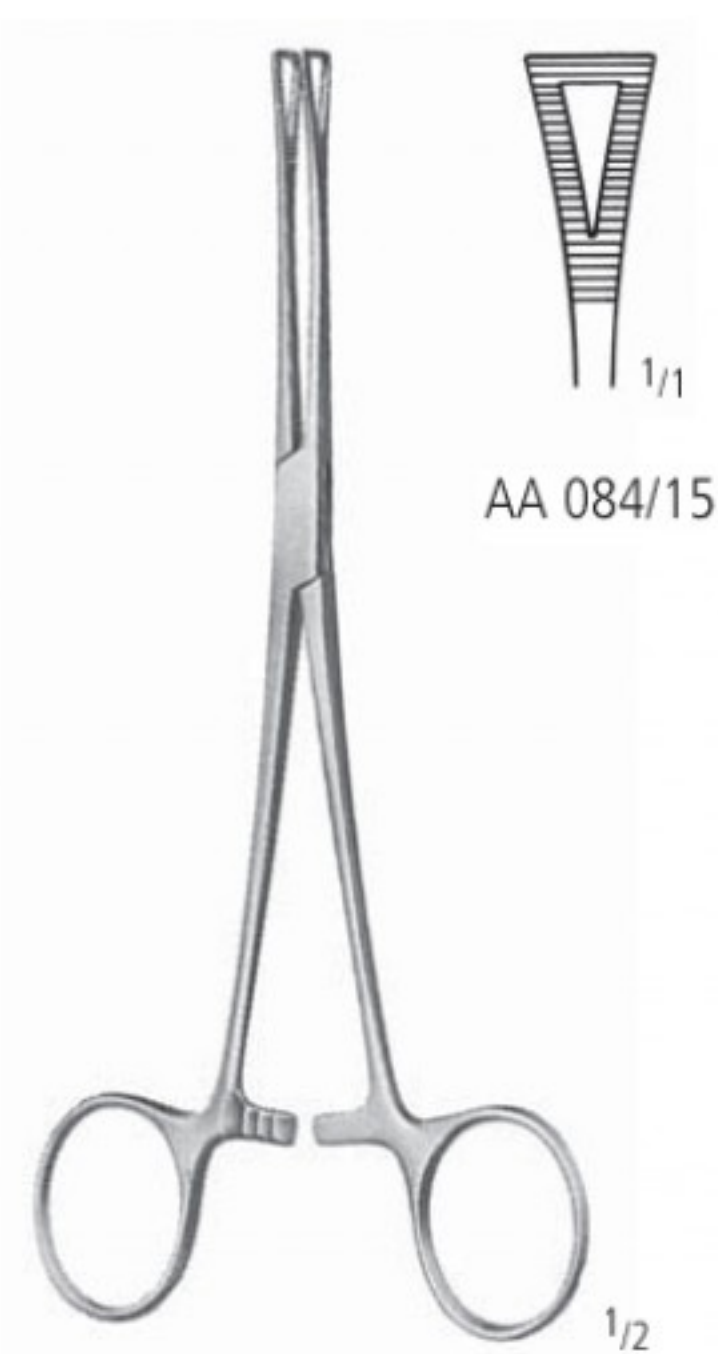

**PENNINGTON**  
 15,5 cm/6" AA 084/15  
 20,0 cm/8" AA 084/20



**COLLIN**  
 16,0 cm/6<sup>1</sup>/<sub>4</sub>"

**AA**

**KLEMMEN HEMOSTATS PINZAS HEMOSTATICAS PINCES HEMOSTATIQUES PINZE EMOSTATICHE**

Arterienklemmen  
 Artery Forceps  
 Pinzas hemostáticas  
 Pincas hémostatiques  
 Pinze emostatiche



**SPENCER-WELLS**

1/2

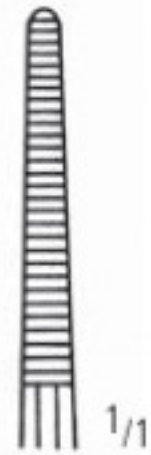

AA 110/13  
 13,0 cm/5"

1/1

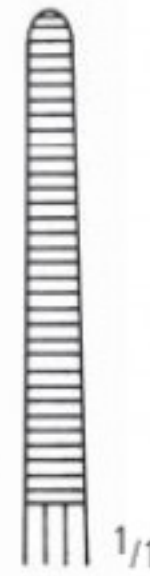

AA 110/14  
 14,0 cm/5 1/2"

1/1

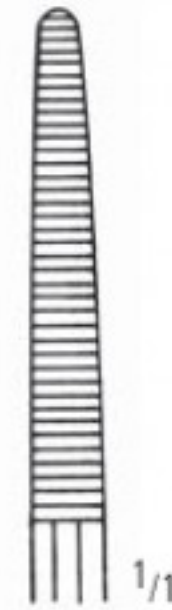

AA 110/15  
 15,5 cm/6"

1/1

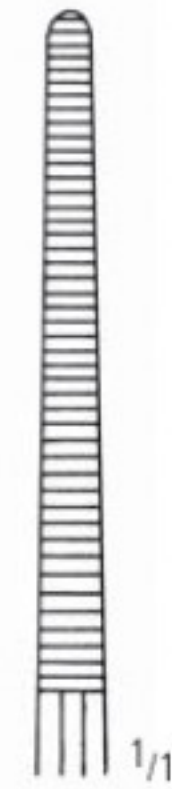

AA 110/18  
 18,0 cm/7"

1/1

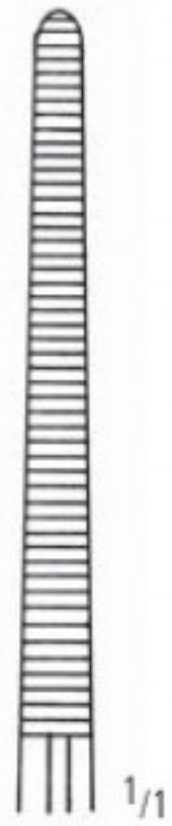

AA 110/20  
 20,0 cm/8"

1/1



AA 111/13  
 13,0 cm/5"

1/1



AA 111/14  
 14,0 cm/5 1/2"

1/1

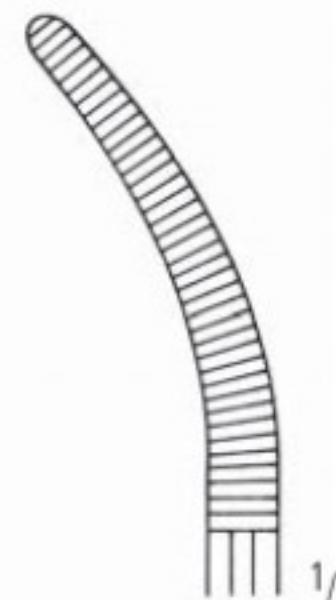

AA 111/15  
 15,5 cm/6"

1/1

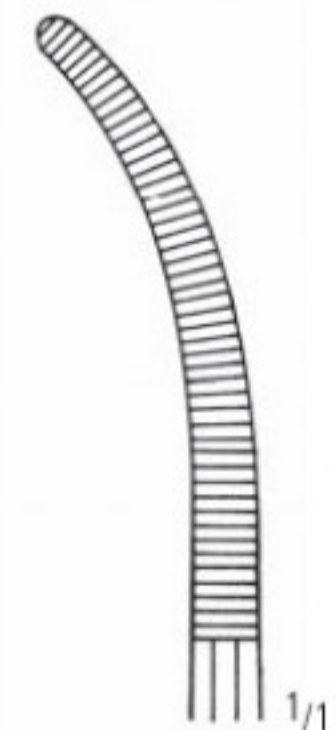

AA 111/18  
 18,0 cm/7"

1/1

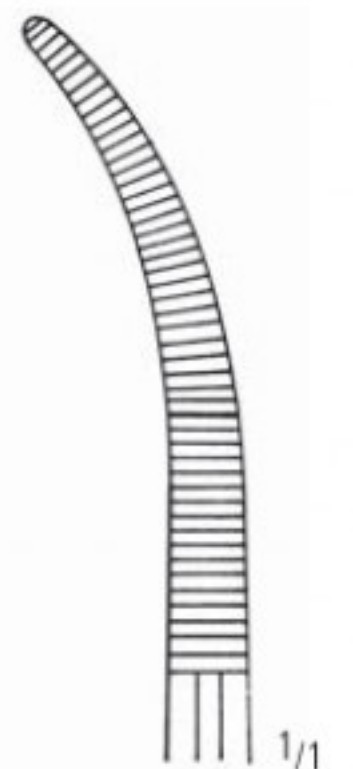

AA 111/20  
 20,0 cm/8"

1/1



**HARTMANN**  
 AA 114/10  
 10,0 cm/4"

2/3



1/1

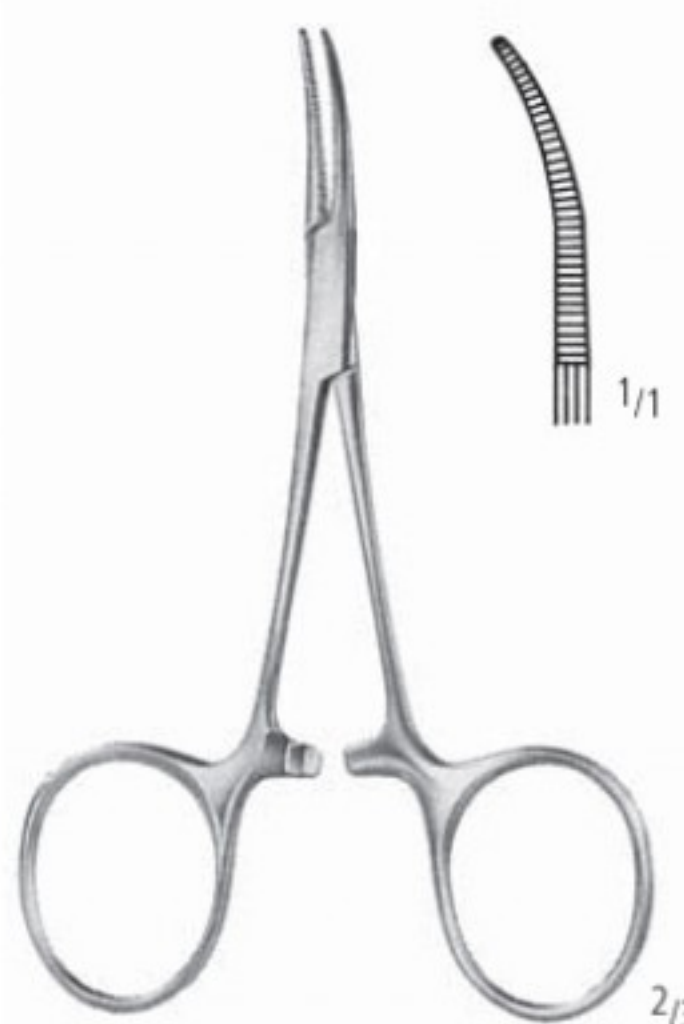

**HARTMANN**  
 AA 115/10  
 10,0 cm/4"

2/3

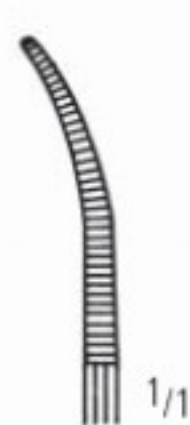

1/1



**CARREL**  
 AA 116/08  
 8,5 cm/3 1/2"

2/3

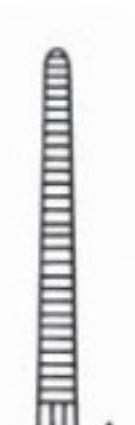

1/1

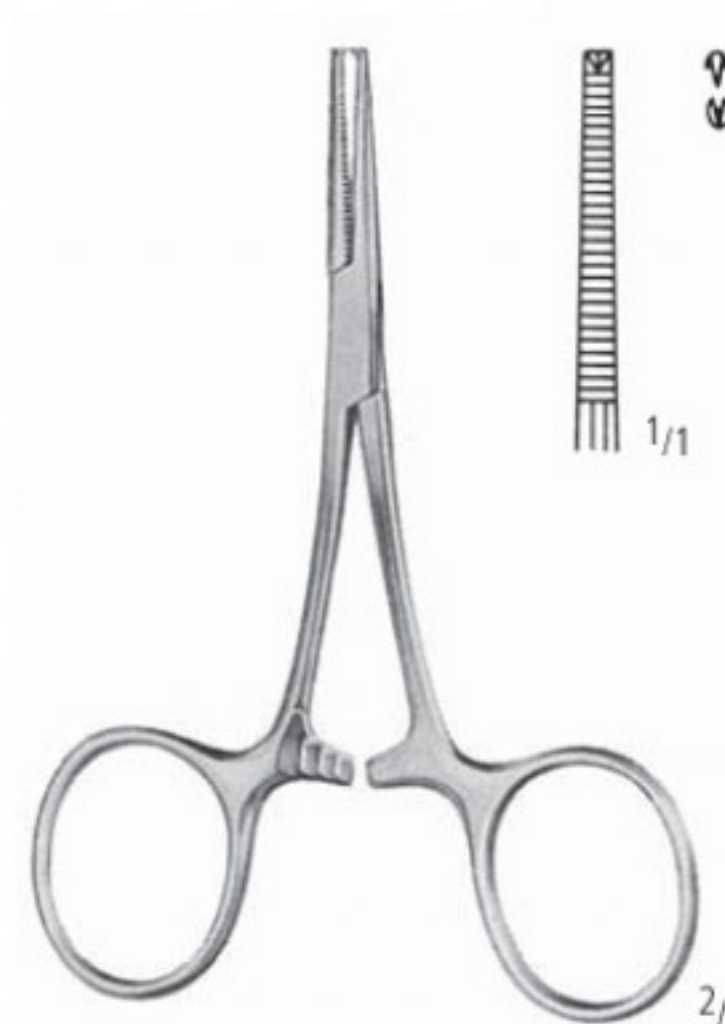

**TERRIER 1:2**  
 AA 118/08  
 8,5 cm/3 1/2"

2/3

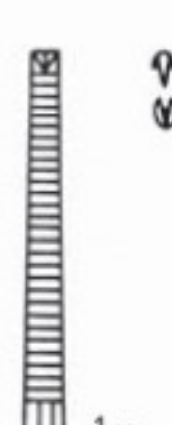

1/1





Feine Arterienklemmen  
 Fine Artery Forceps  
 Pinzas hemostáticas finas  
 Pincés hémostatiques fines  
 Pinze emostatiche fine

AA  
 AB  
 AC  
 AD  
 AE  
 AF  
 AG  
 AH  
 AI  
 AJ  
 AK  
 AL  
 AM  
 AN  
 AO  
 AP  
 AQ  
 AR  
 AS  
 AT  
 AU  
 AV  
 AW  
 AX  
 AY  
 AZ  
 BA  
 BB  
 BC  
 BD  
 BE  
 BF  
 BG  
 BH  
 BI  
 BJ  
 BK  
 BL  
 BM  
 BN  
 BO  
 BP  
 BQ  
 BR  
 BS  
 BT  
 BU  
 BV  
 BW  
 BX  
 BY  
 CA  
 CB  
 CC  
 CD  
 CE  
 CF  
 CG  
 CH  
 CI  
 CJ  
 CK  
 CL  
 CM  
 CN  
 CO  
 CP  
 CQ  
 CR  
 CS  
 CT  
 CU  
 CV  
 CW  
 CX  
 CY  
 DA  
 DB  
 DC  
 DD  
 DE  
 DF  
 DG  
 DH  
 DI  
 DJ  
 DK  
 DL  
 DM  
 DN  
 DO  
 DP  
 DQ  
 DR  
 DS  
 DT  
 DU  
 DV  
 DW  
 DX  
 EY  
 EY

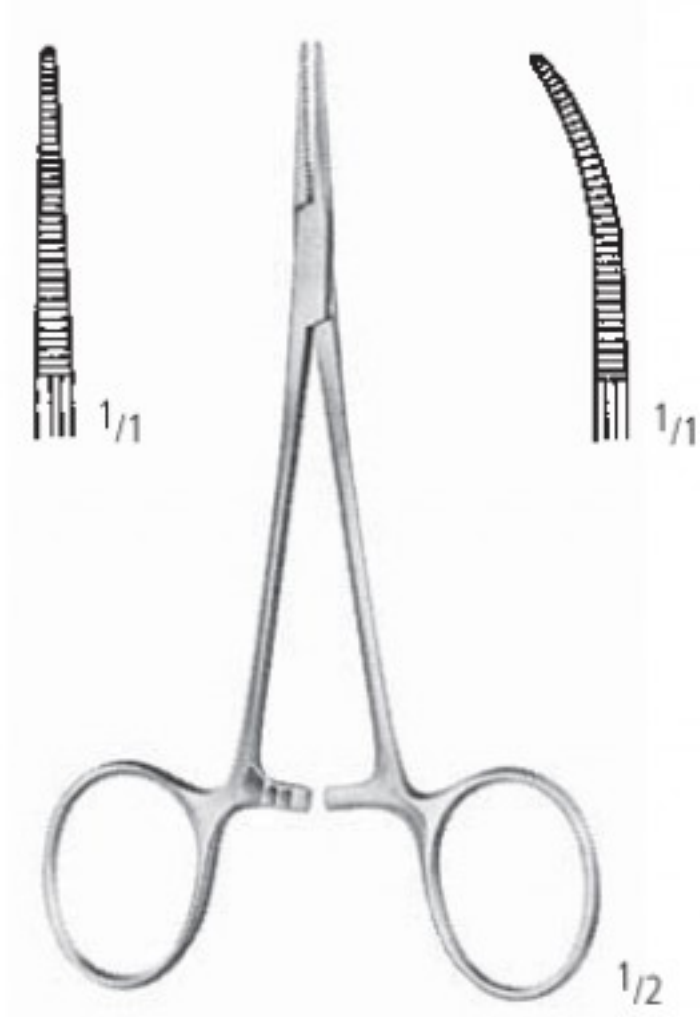

**MICRO-MOSQUITO**

AA 130/10      AA 131/10  
 AA 130/12      AA 131/12

10,0 cm/4"  
 12,0 cm/4<sup>3</sup>/<sub>4</sub>"

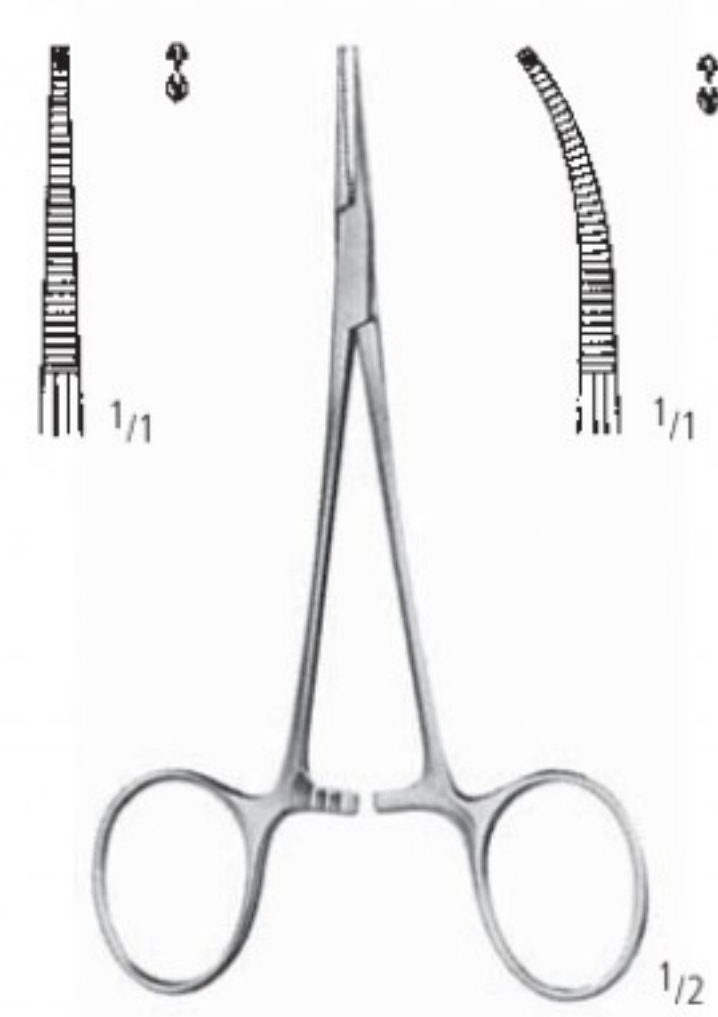

**MICRO-MOSQUITO 1:2**

AA 132/10      AA 133/10  
 AA 132/12      AA 133/12

**WILLIAM STEWART HALSTED**

was professor of surgery in the Johns Hopkins University. In 1890 he had bronze casts made of his own hands. On these casts the first surgical rubber gloves were moulded.

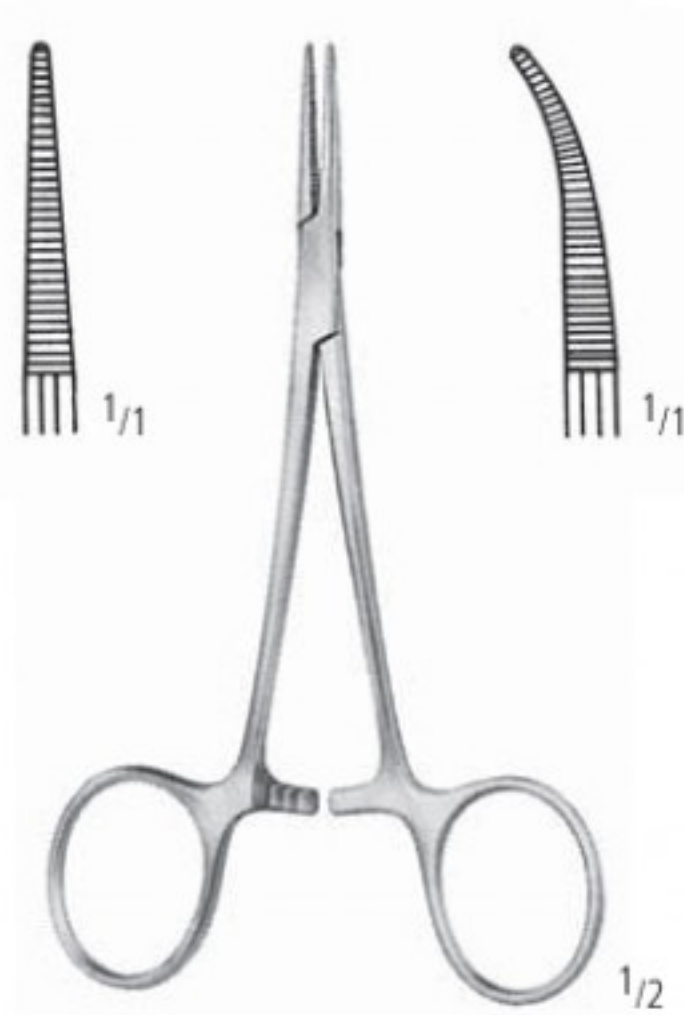

**HALSTED-MOSQUITO**

AA 150/12      AA 151/12  
 AA 150/14      AA 151/14

12,5 cm/5"  
 14,0 cm/5<sup>1</sup>/<sub>2</sub>"

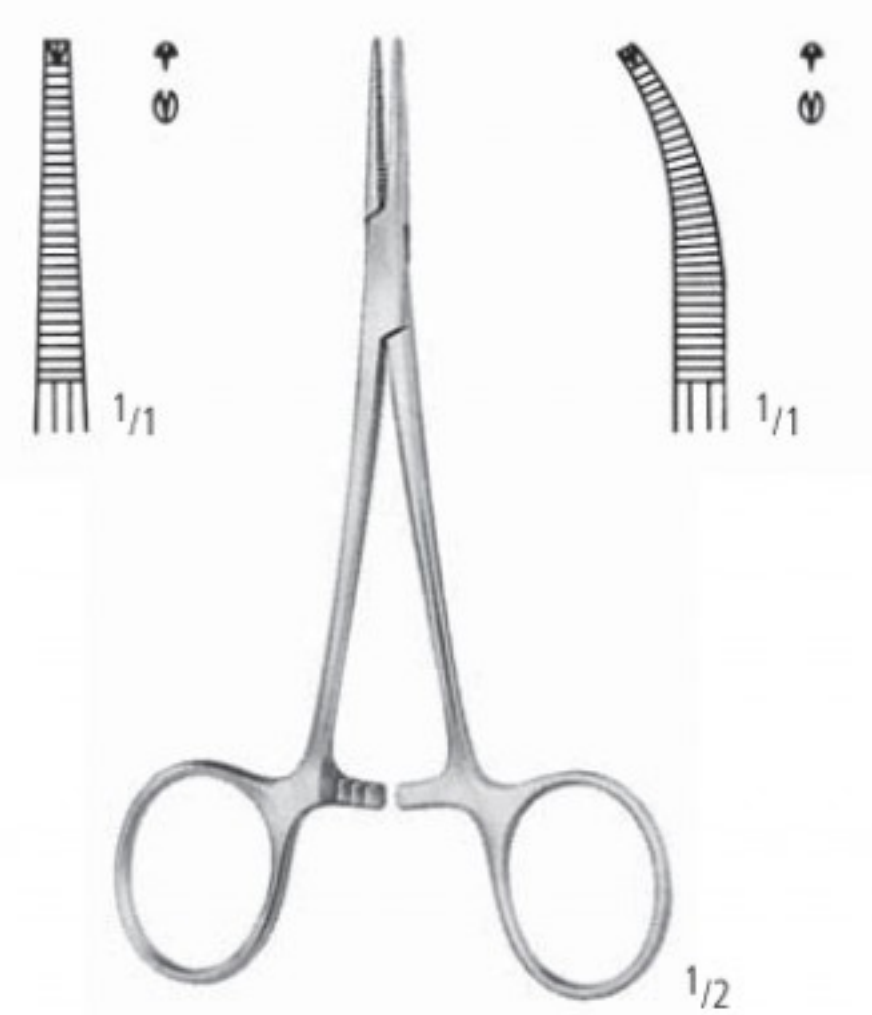

**HALSTED-MOSQUITO 1:2**

AA 152/12      AA 153/12  
 AA 152/14      AA 153/14

Arterienklemmen  
 Artery Forceps  
 Pinzas hemostáticas  
 Pincés hémostatiques  
 Pinze emostatiche

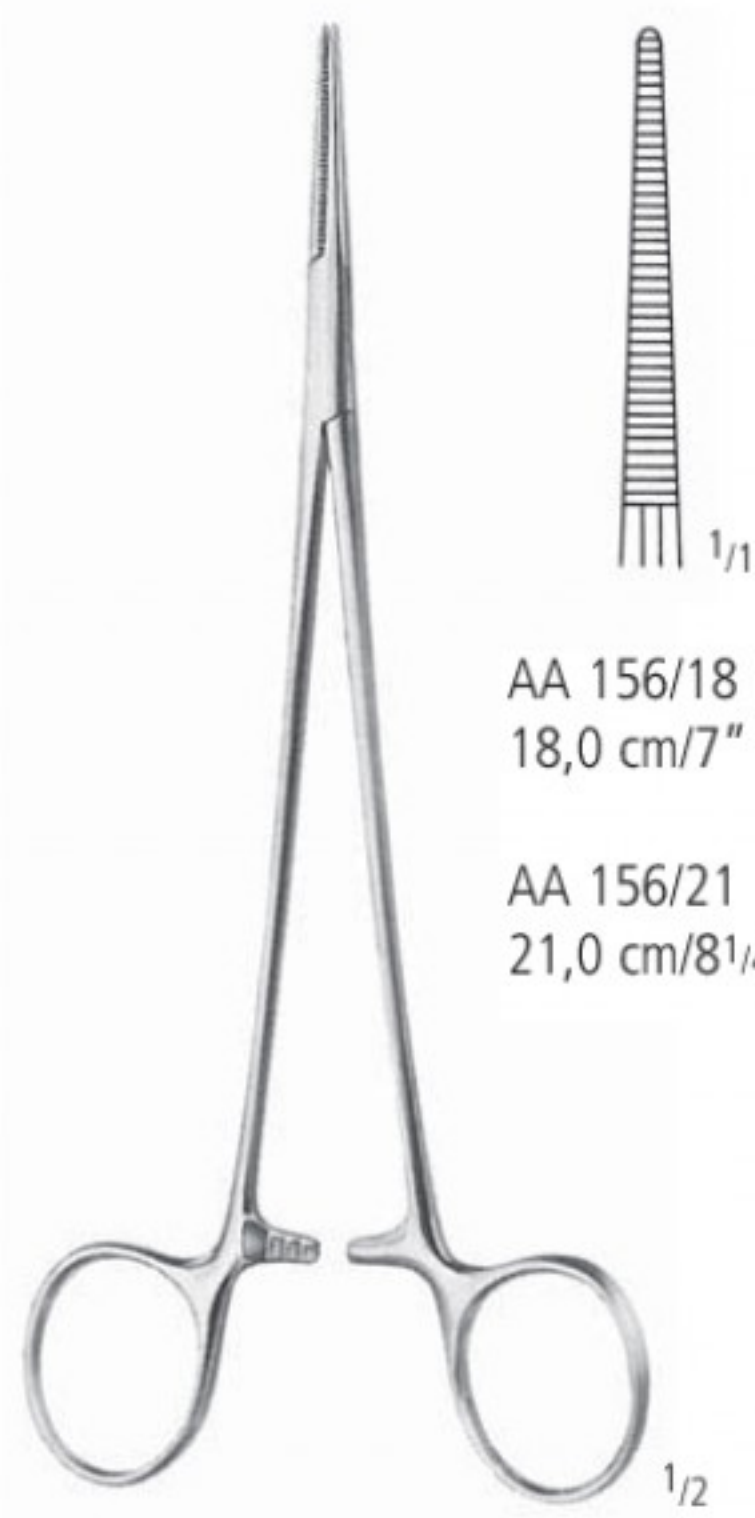

AA 156/18  
 18,0 cm/7"

AA 156/21  
 21,0 cm/8<sup>1</sup>/<sub>4</sub>"

**HALSTED**



AA 157/18  
 18,0 cm/7"

AA 157/21  
 21,0 cm/8<sup>1</sup>/<sub>4</sub>"

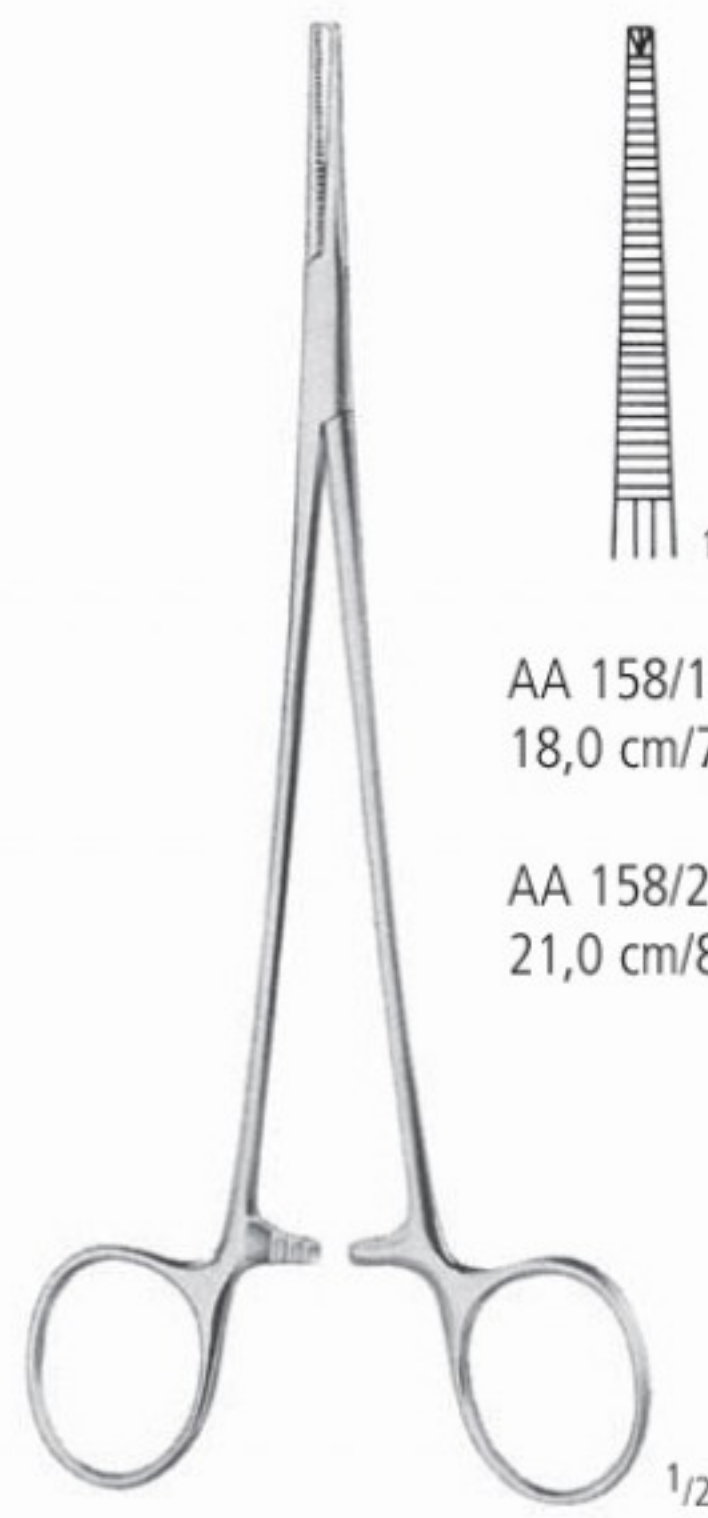

AA 158/18  
 18,0 cm/7"

AA 158/21  
 21,0 cm/8<sup>1</sup>/<sub>4</sub>"

**HALSTED 1:2**

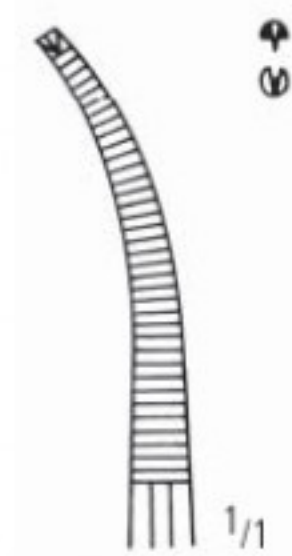

AA 159/18  
 18,0 cm/7"

AA 159/21  
 21,0 cm/8<sup>1</sup>/<sub>4</sub>"

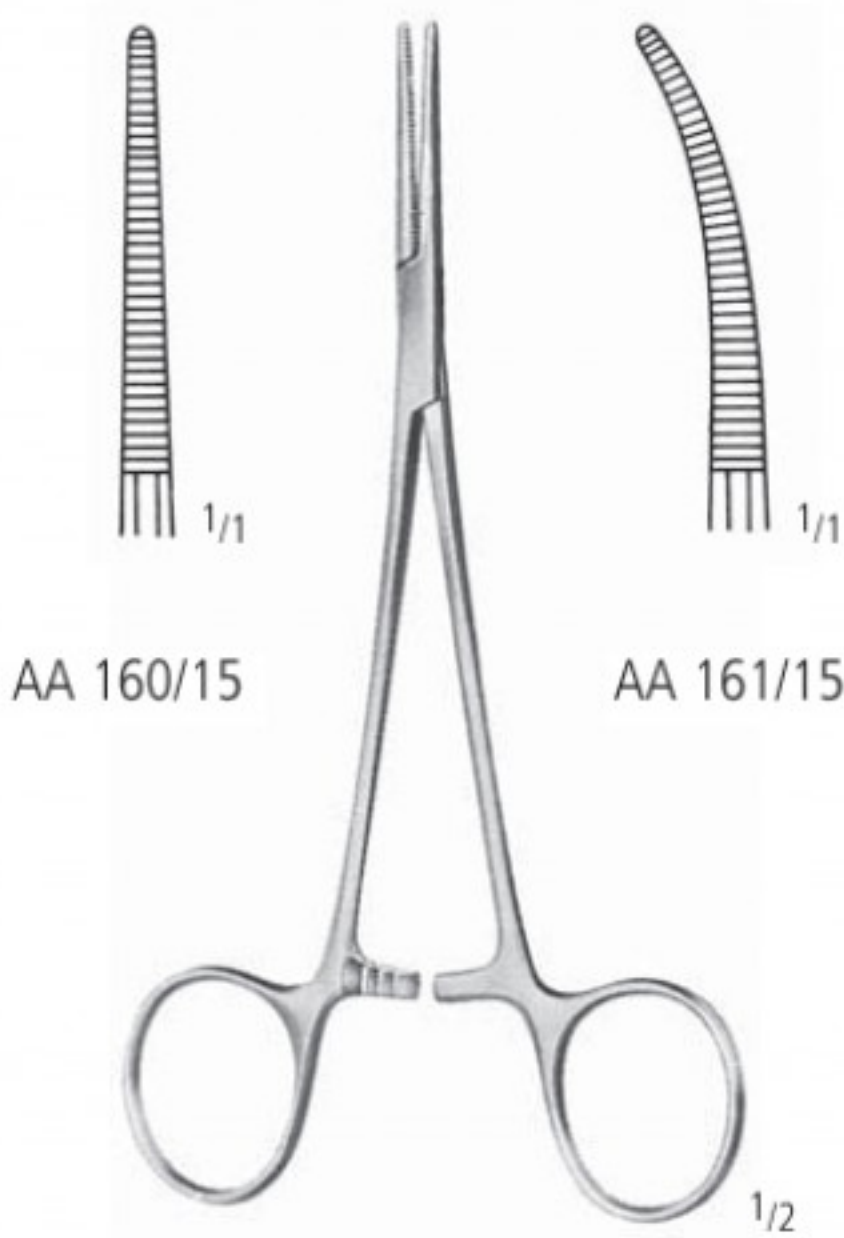

AA 160/15

AA 161/15

**LERICHE**  
 15,0 cm/6"

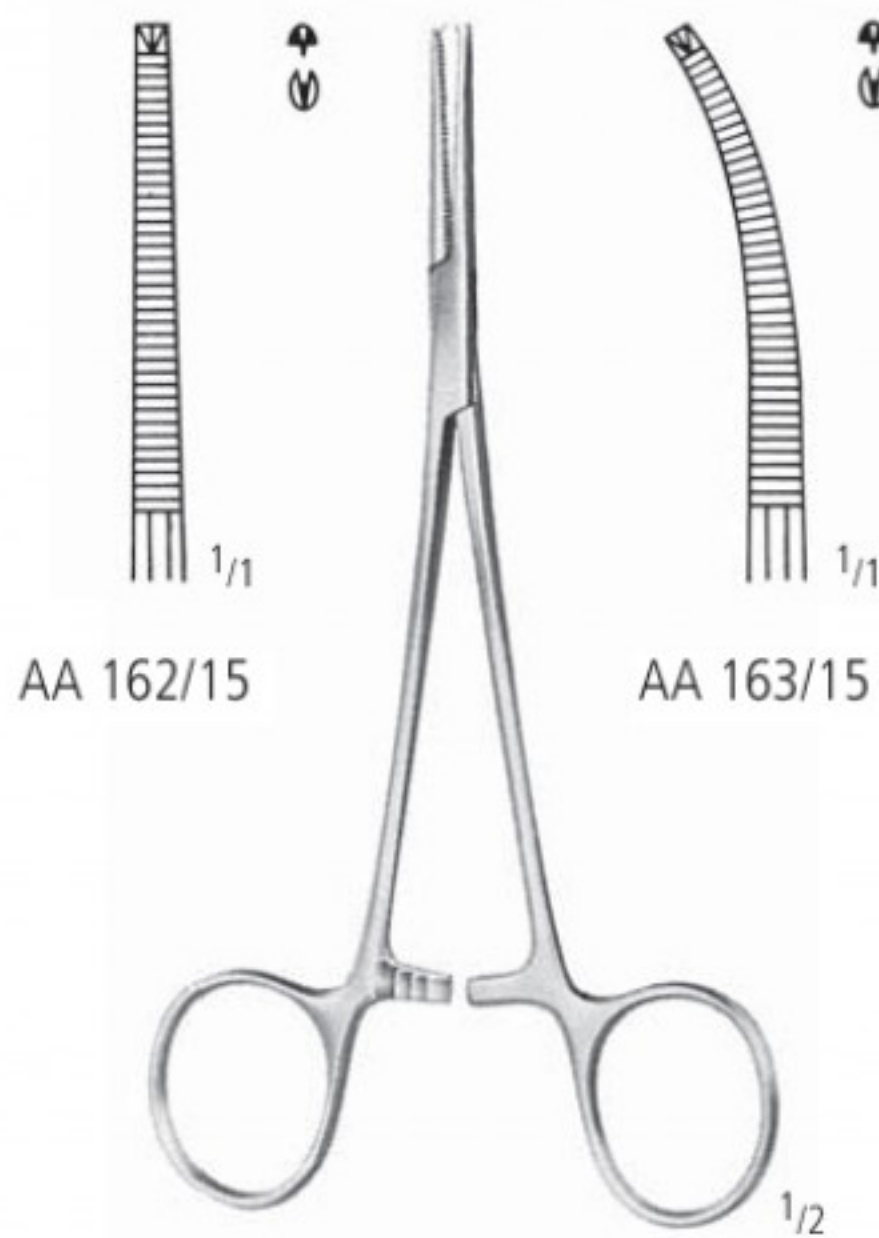

AA 162/15

AA 163/15

**LERICHE 1:2**  
 15,0 cm/6"

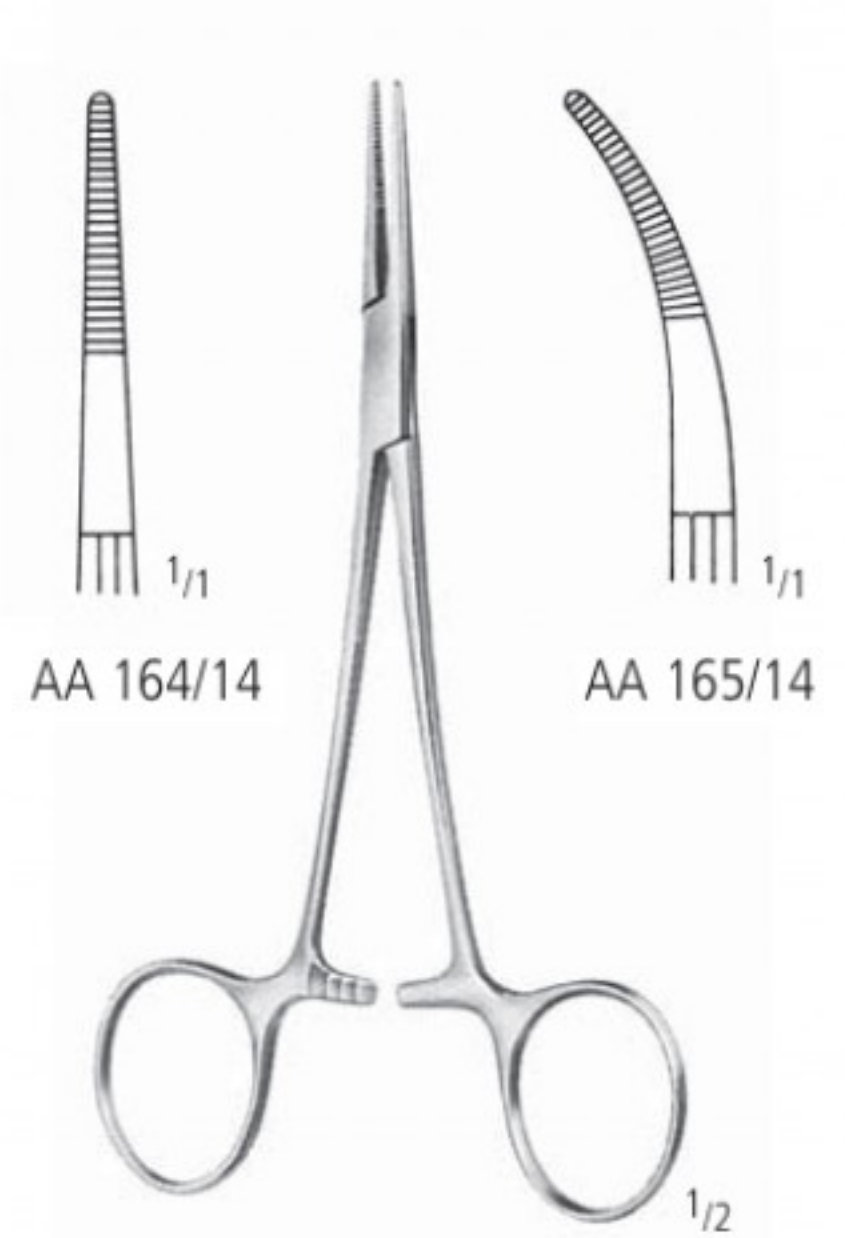

AA 164/14

AA 165/14

**PROVIDENCE-HOSPITAL**  
 14,0 cm/5<sup>1</sup>/<sub>2</sub>"



KLEMMEN HEMOSTATS PINZAS HEMOSTATICAS PINCES HEMOSTATIQUES PINZE EMOSTATICHE

Arterienklemmen  
 Artery Forceps  
 Pinzas hemostáticas  
 Pincas hémostatiques  
 Pinze emostatiche

AA

AB

AC

AD

AE

AF

AK

AL

AM

AO

AP

AR

KA

KB

KC

KD

KU

KY

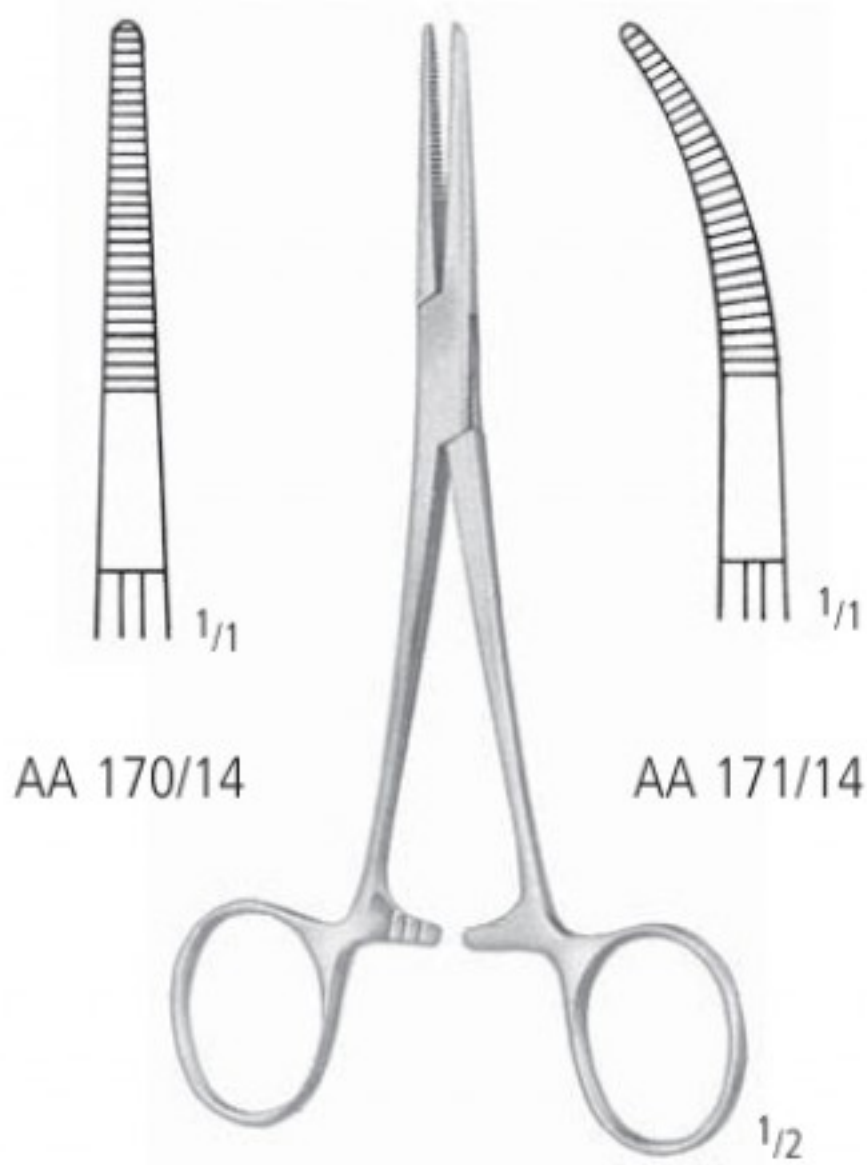

**KELLY**  
 14,0 cm/5 1/2"

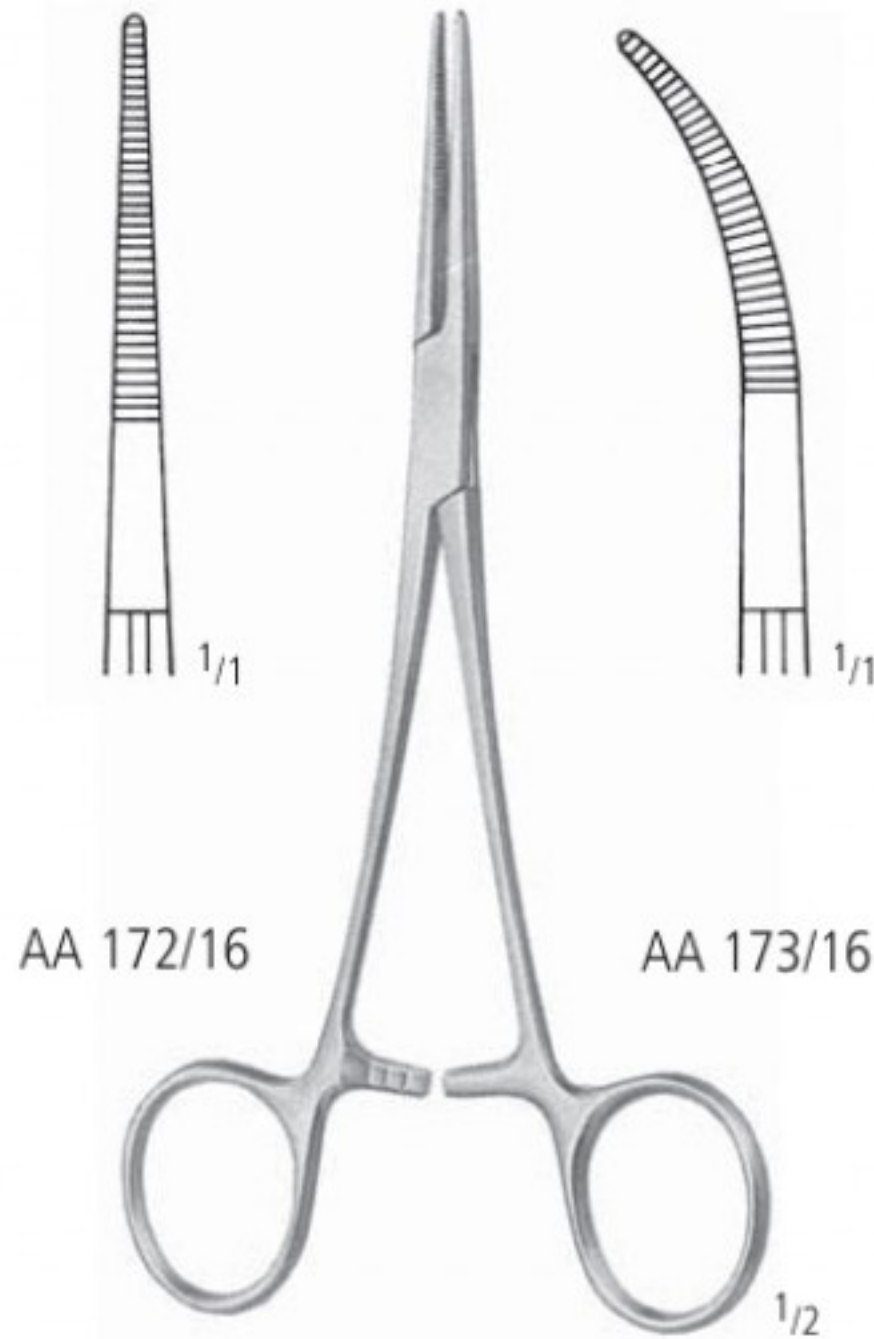

**KELLY-RANKIN**  
 16,0 cm/6 1/4"

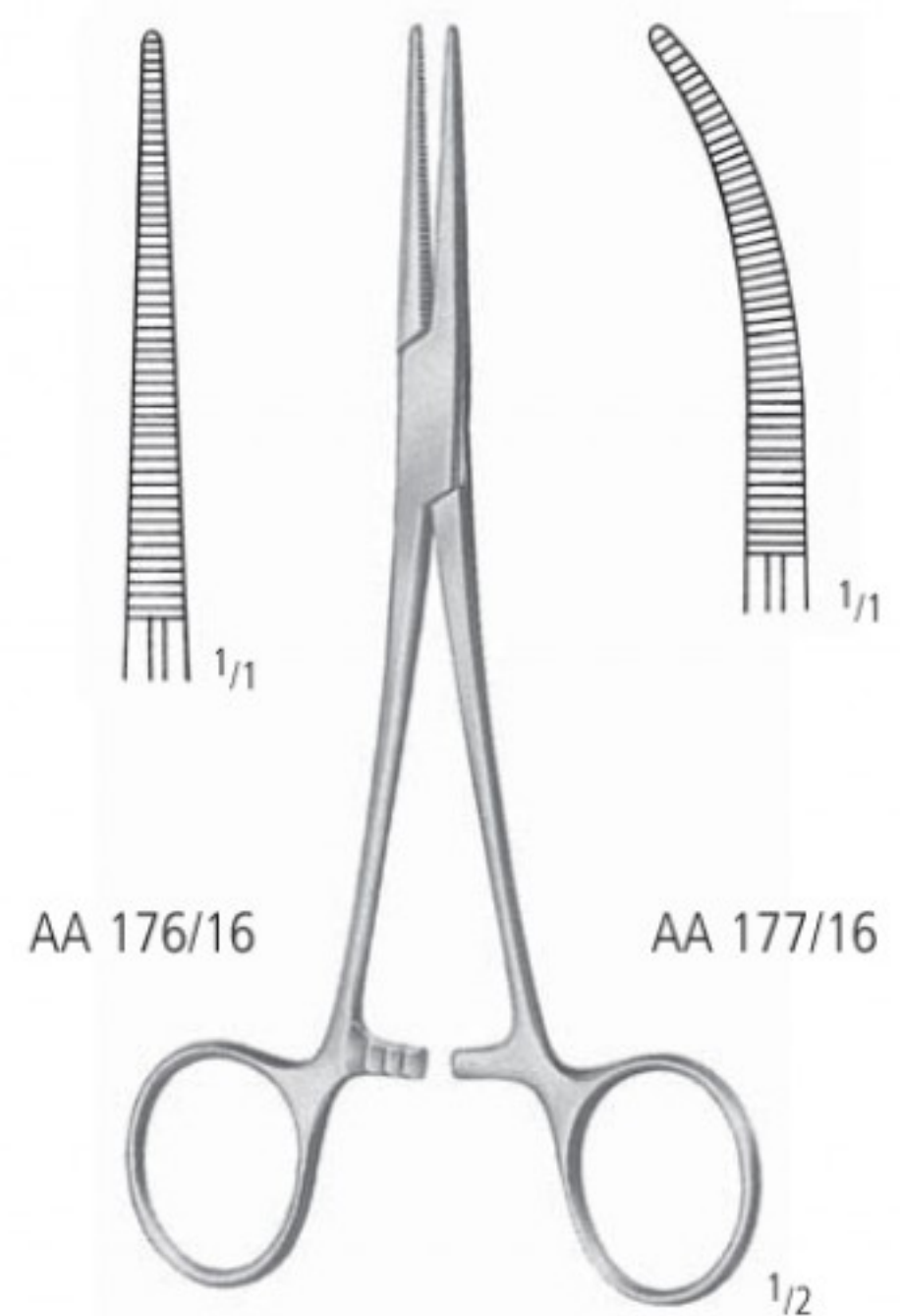

**COLLER**  
 AA 176/14 14,0 cm/5 1/2" AA 177/14  
 AA 176/16 16,0 cm/6 1/4" AA 177/16

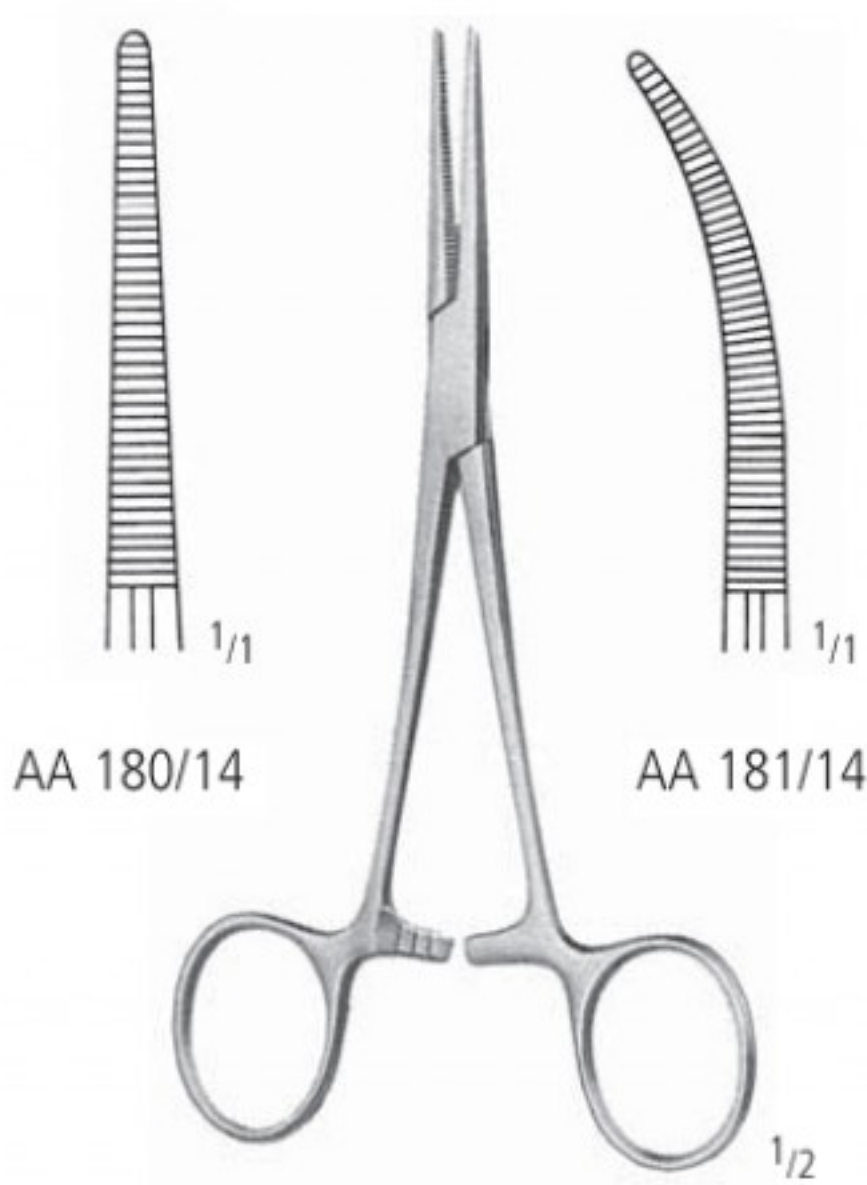

**CRILE**  
 14,0 cm/5 1/2"

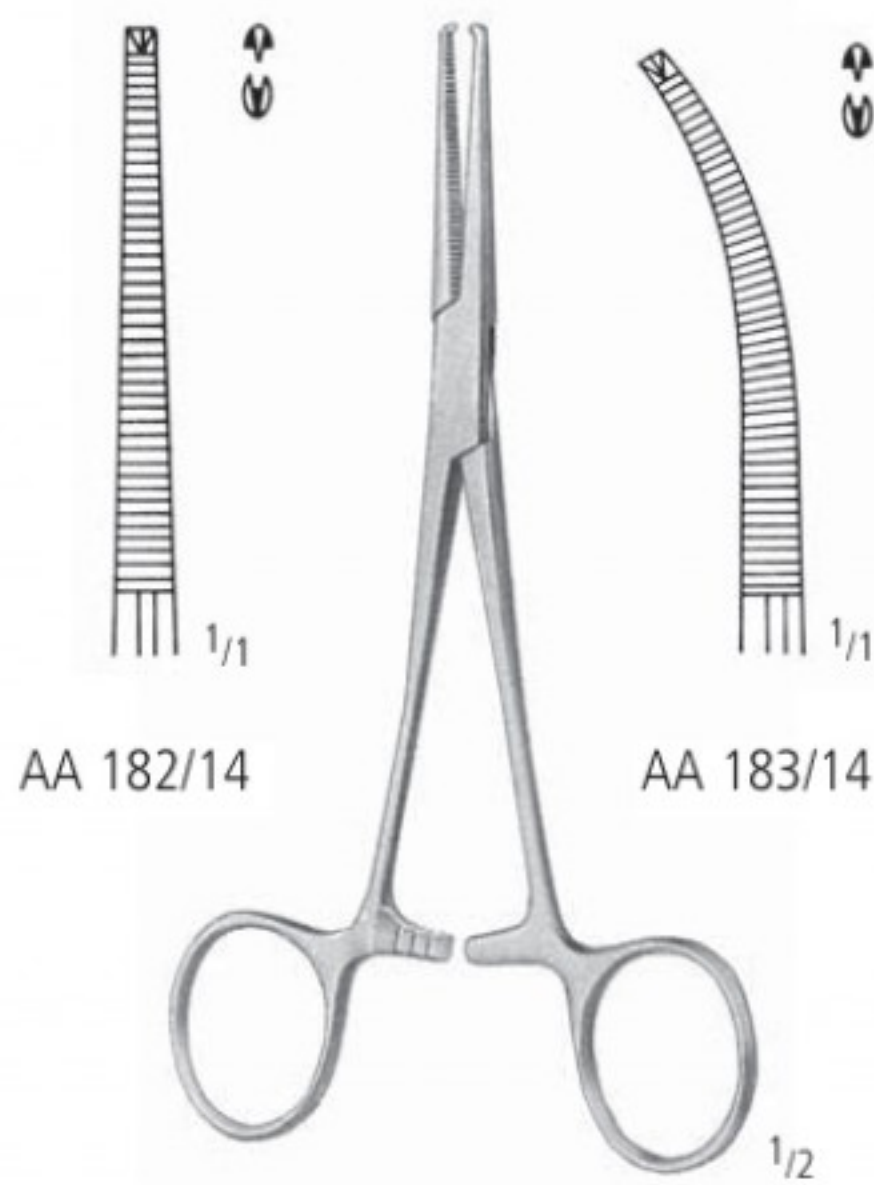

**CRILE 1:2**  
 14,0 cm/5 1/2"

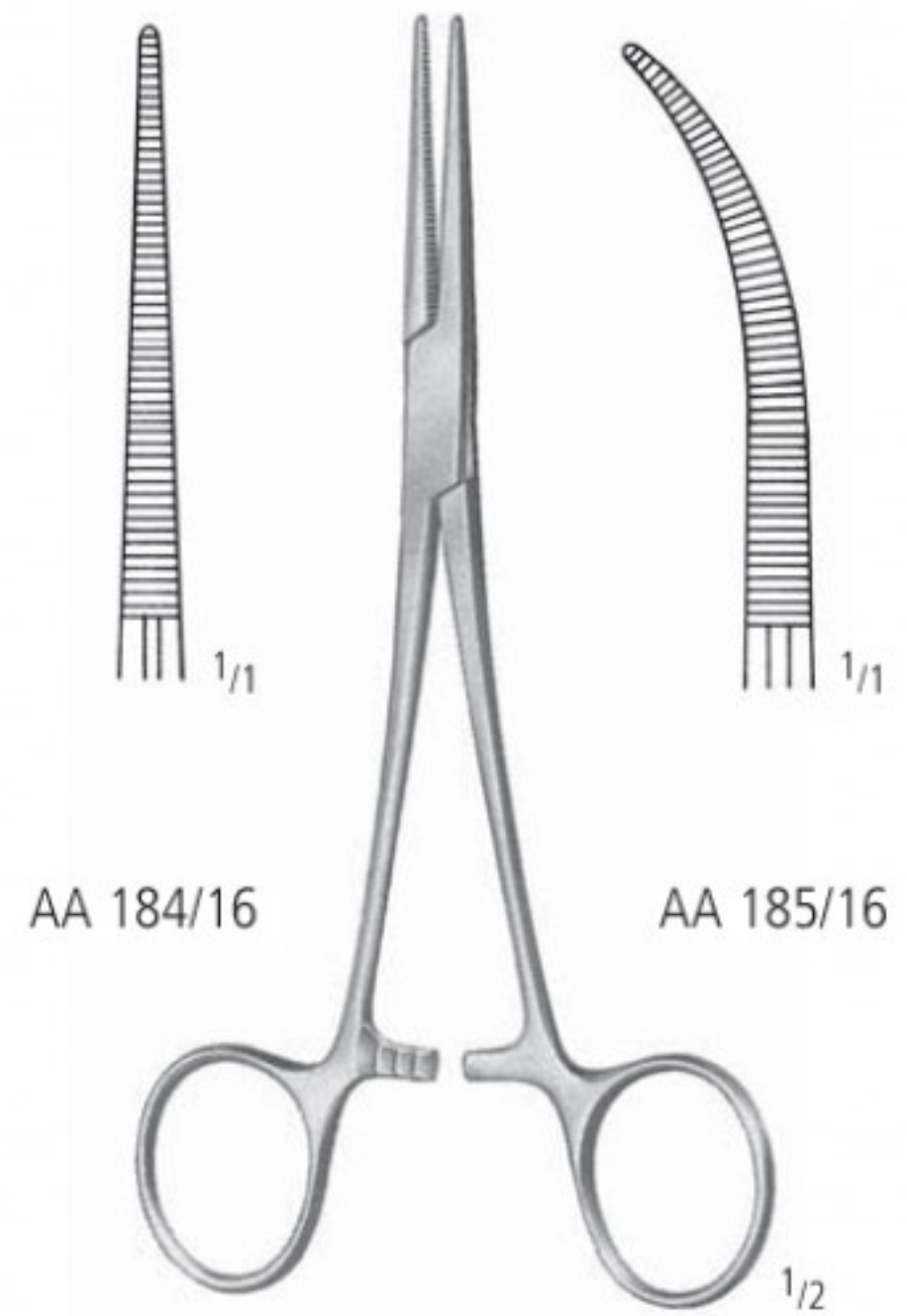

**CRILE-RANKIN**  
 16,0 cm/6 1/4"



Arterienklemmen  
 Artery Forceps  
 Pinzas hemostáticas  
 Pincés hémostatiques  
 Pinze emostatiche

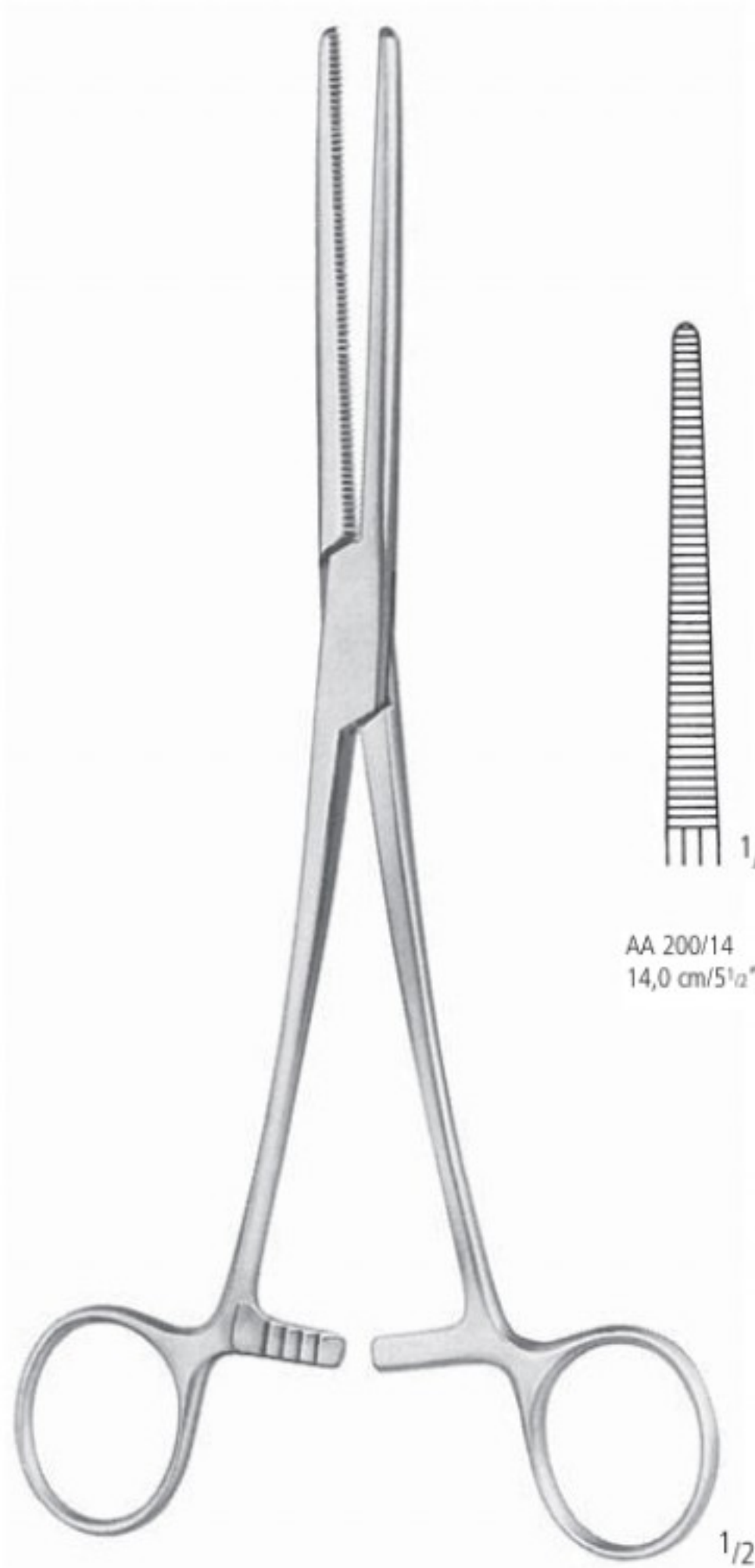

ROCHESTER-PEAN

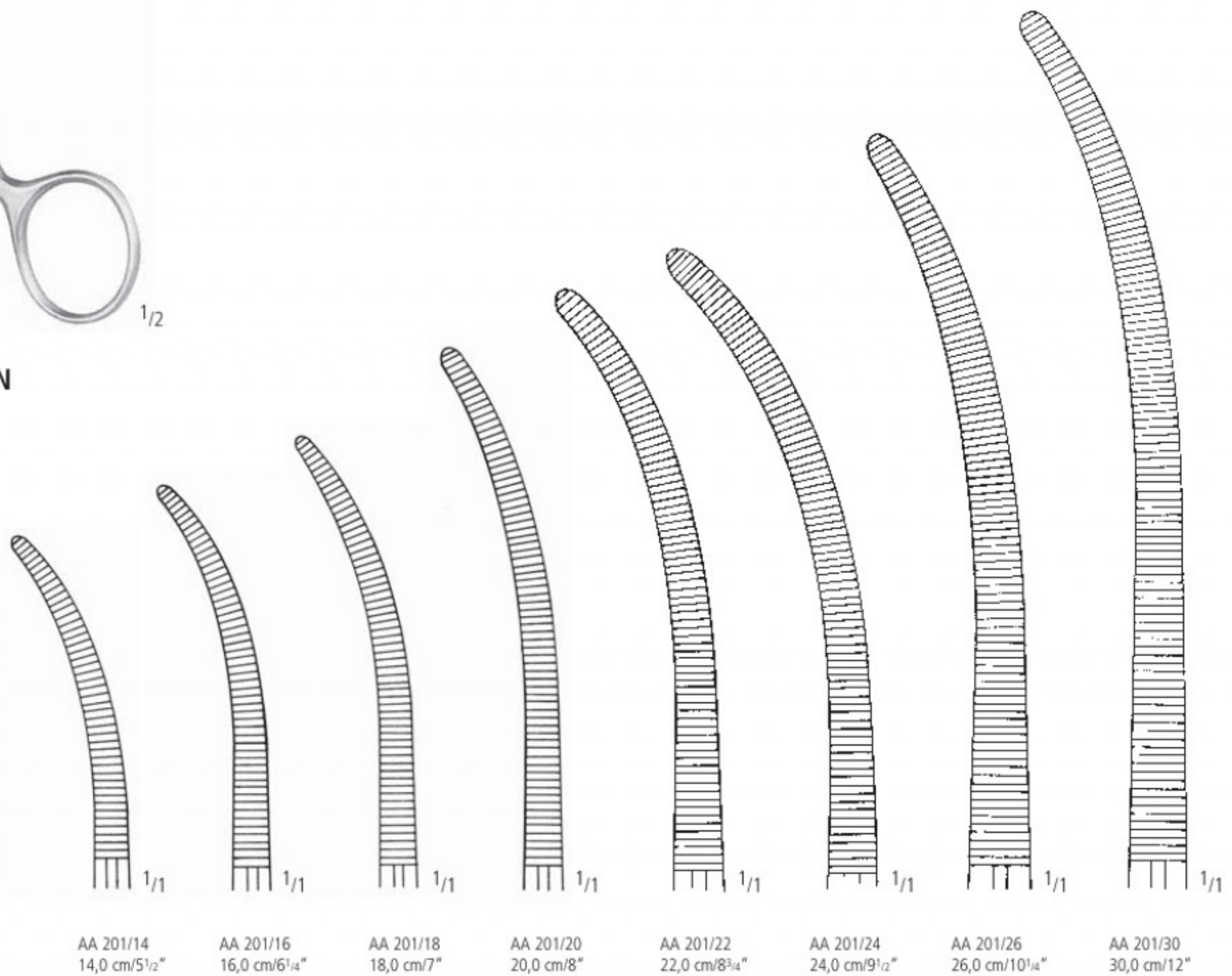
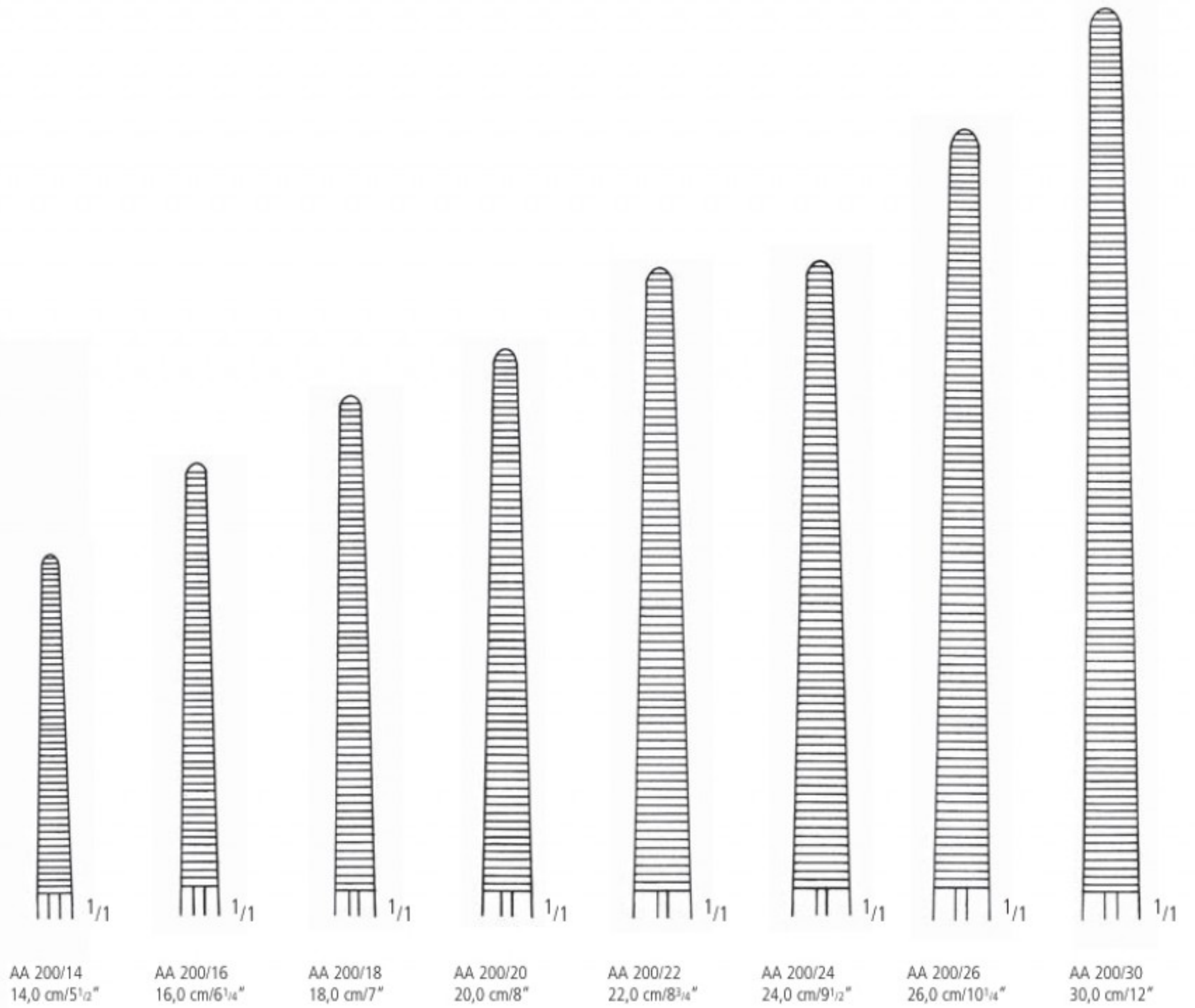



KLEMMEN HEMOSTATS PINZAS HEMOSTATICAS PINCES HEMOSTATIQUES PINZE EMOSTATICHE

Arterienklemmen  
 Artery Forceps  
 Pinzas hemostáticas  
 Pincas hémostatiques  
 Pinze emostatiche

AA

AB

AC

AD

AE

AF

AK

AL

AM

AO

AP

AR

KA

KB

KC

KD

KU

KY



OCHSNER-KOCHER 1:2

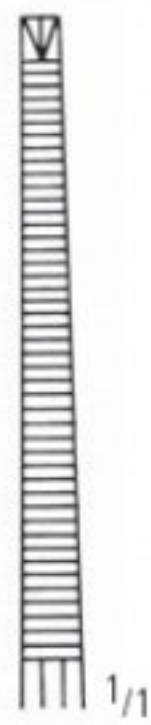

AA 210/14  
14,0 cm/5 1/2"

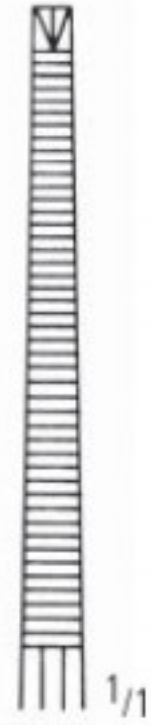

AA 210/16  
16,0 cm/6 1/4"

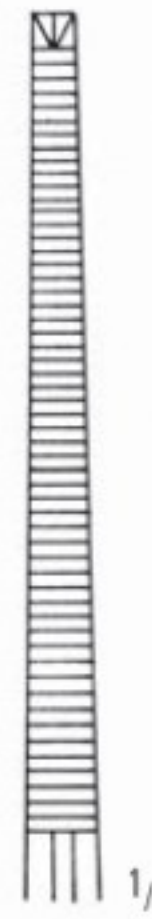

AA 210/18  
18,0 cm/7"



AA 210/20  
20,0 cm/8"



AA 210/22  
22,0 cm/8 3/4"

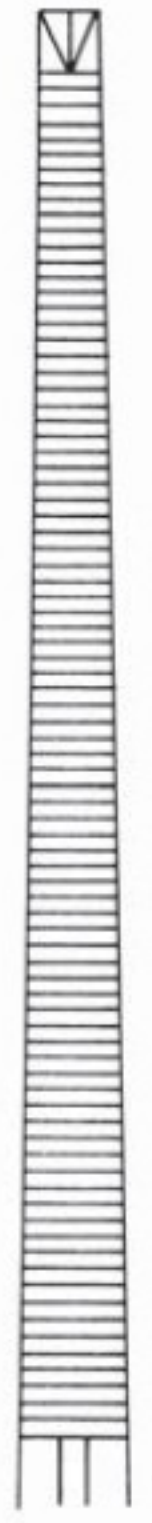

AA 210/24  
24,0 cm/9 1/2"

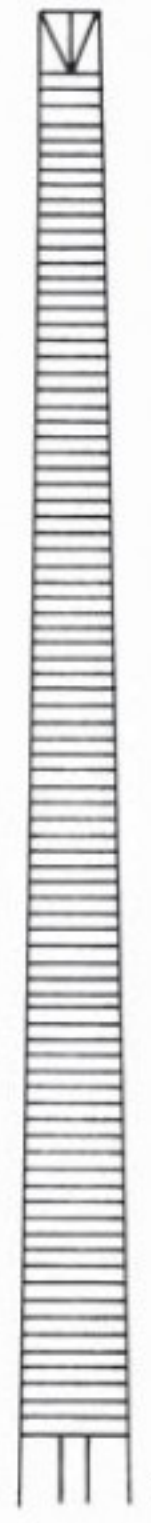

AA 210/26  
26,0 cm/10 1/4"

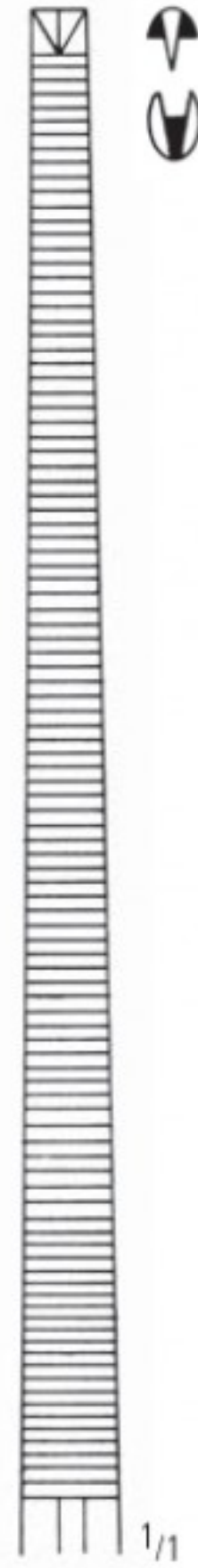

AA 210/30  
30,0 cm/12"



AA 211/14  
14,0 cm/5 1/2"



AA 211/16  
16,0 cm/6 1/4"



AA 211/18  
18,0 cm/7"



AA 211/20  
20,0 cm/8"

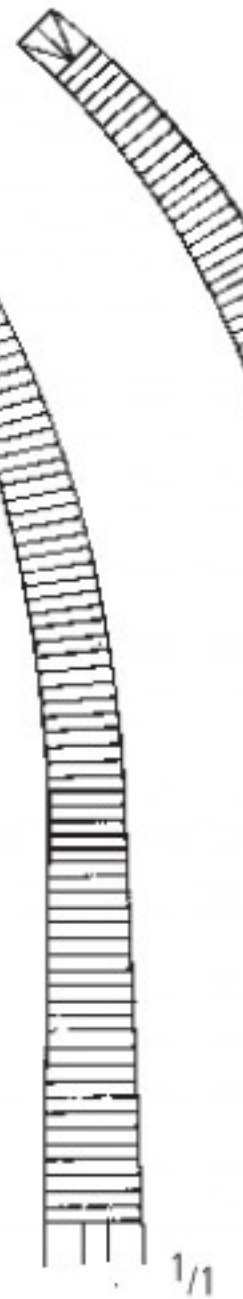

AA 211/22  
22,0 cm/8 3/4"



AA 211/24  
24,0 cm/9 1/2"



AA 211/26  
26,0 cm/10 1/4"



AA 211/30  
30,0 cm/12"



Grazile Arterienklemmen  
 Delicate Artery Forceps  
 Pinzas hemostáticas delgadas  
 Pincas hémostatiques graciles  
 Pinze emostatiche delicate

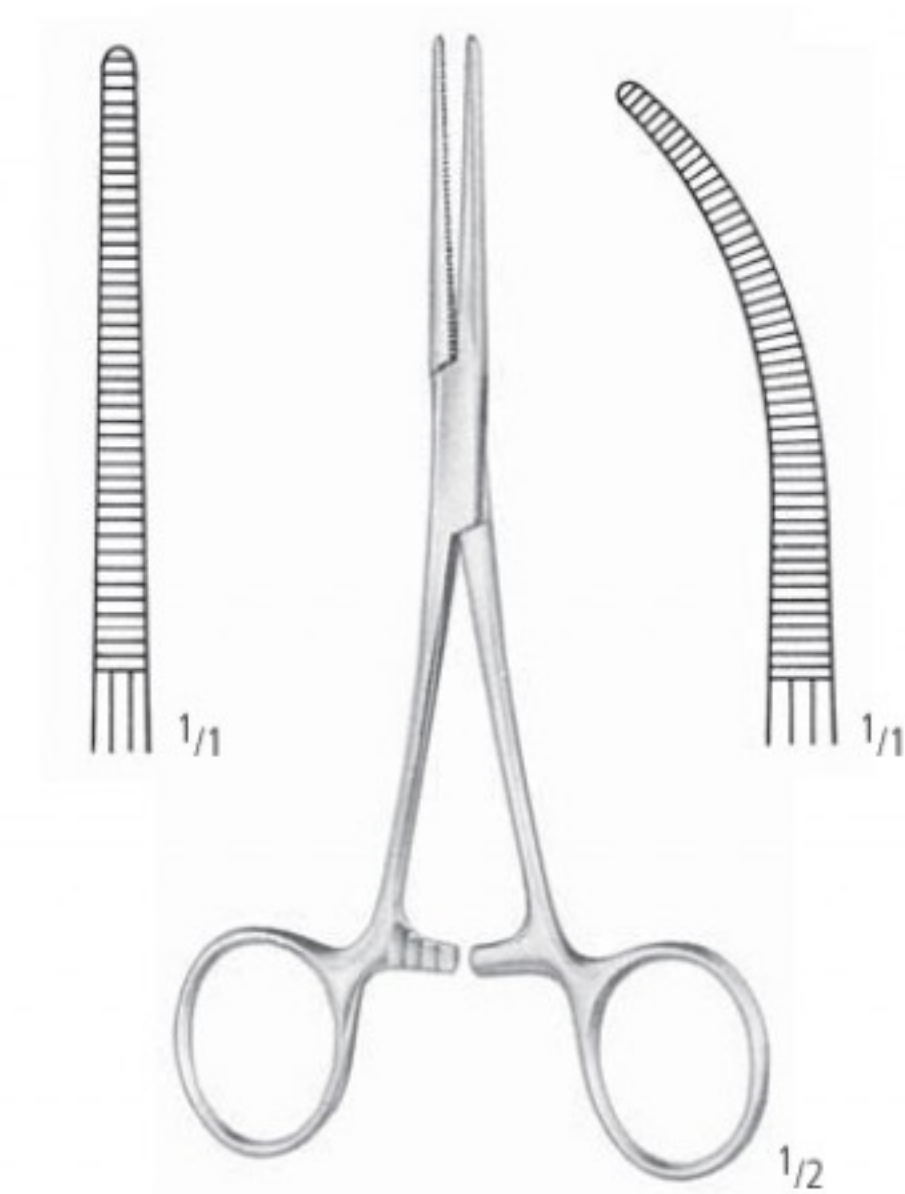

**PEAN - DELICATE**

AA 214/13	AA 215/13
AA 214/14	AA 215/14
AA 214/16	AA 215/16

13,0 cm/5"  
 14,0 cm/5½"  
 16,0 cm/6¼"

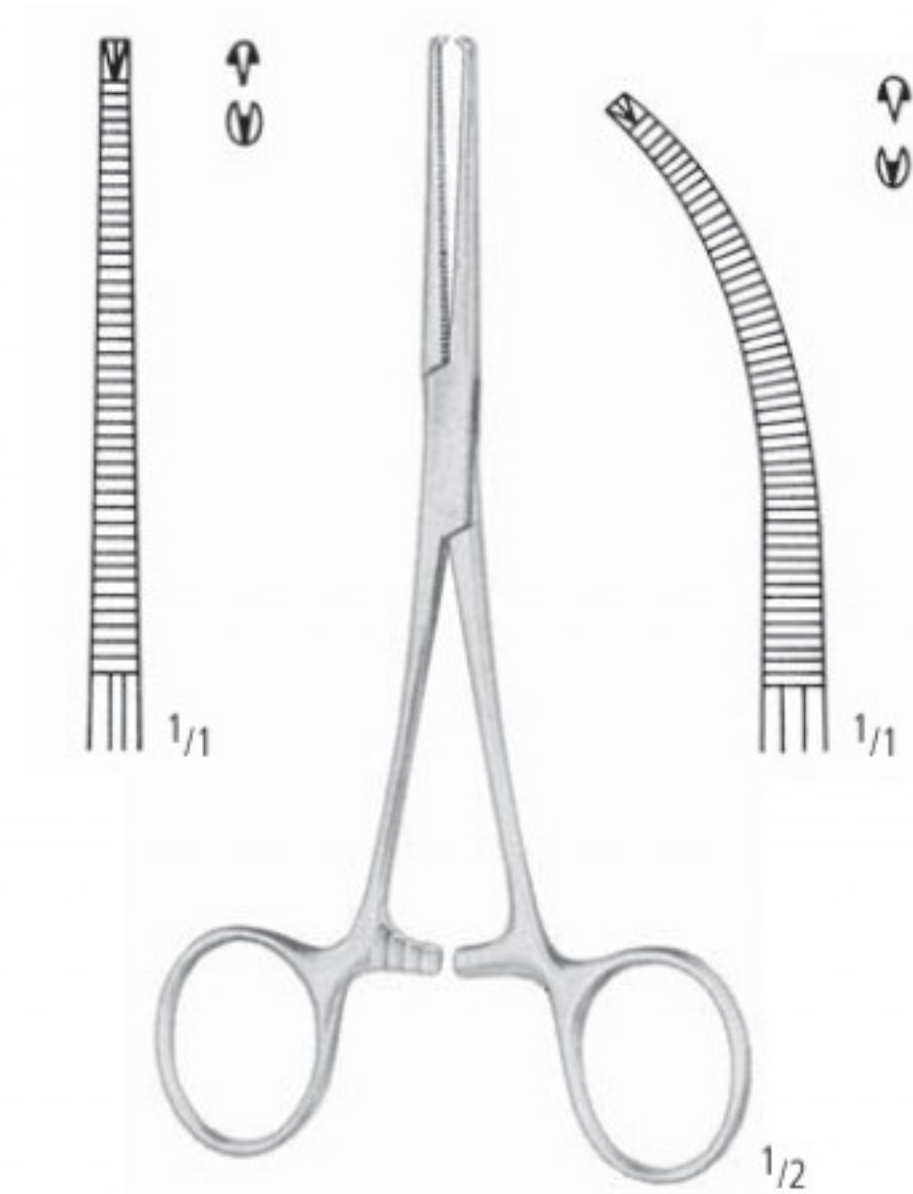

**KOCHER 1:2 - DELICATE**

AA 216/13	AA 217/13
AA 216/14	AA 217/14
AA 216/16	AA 217/16

**JULES PEAN**, born 1830, died 1898, was the most important French gynecological surgeon of his time. He studied at Paris 1860. 1864 Pean was the first surgeon in Paris to perform an ovariectomy. By the use of Pean pins he introduced forceps pressure for control of hemorrhage, thus he invented the most used surgical instrument, next to the scalpel.

**ALBERT J. OCHSNER**, born 1858, died 1925. He devoted much time to attending and participating in medical discussions and was member of all leading societies in his fields.

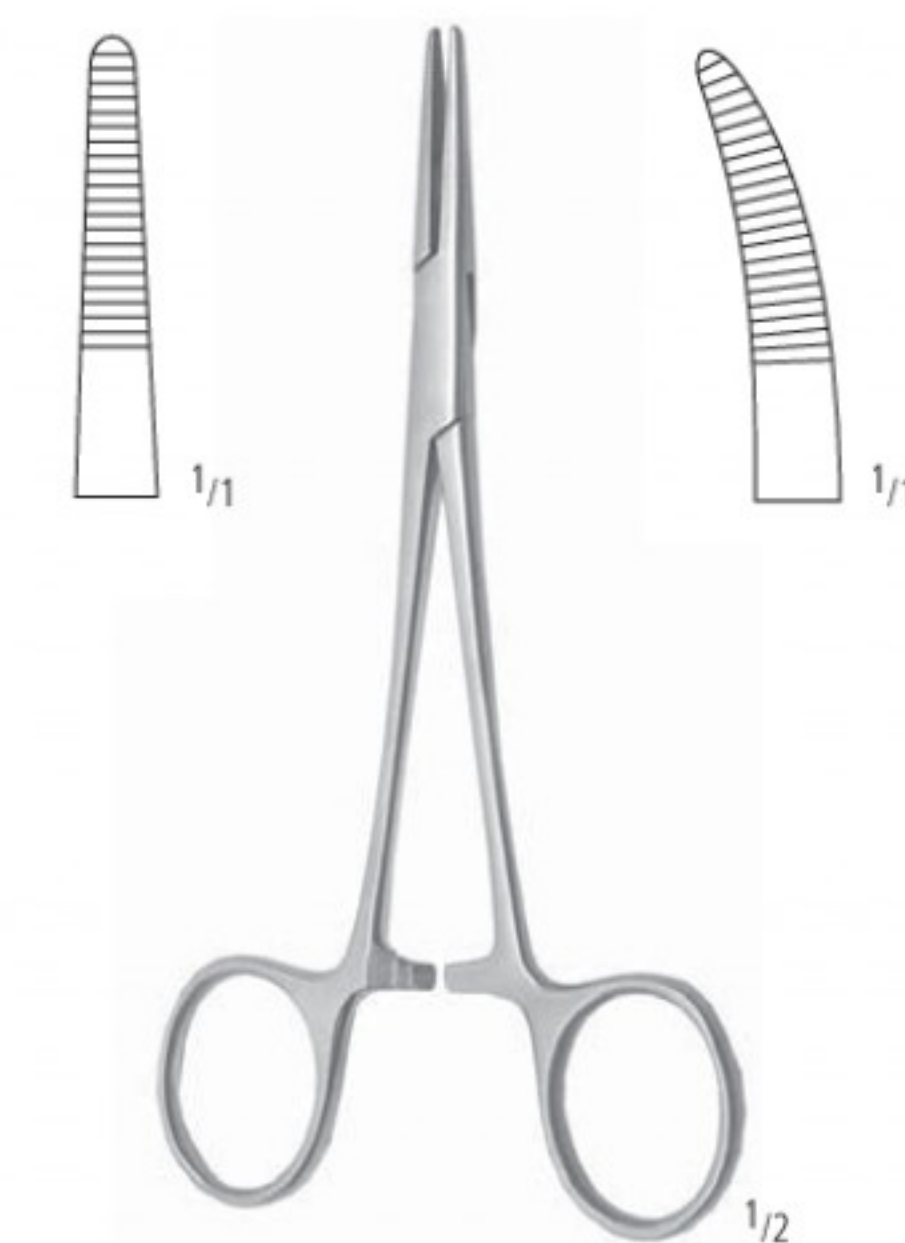

**CAIRNS**

AA 218/15	15,0 cm/6"	AA 219/15
-----------	------------	-----------

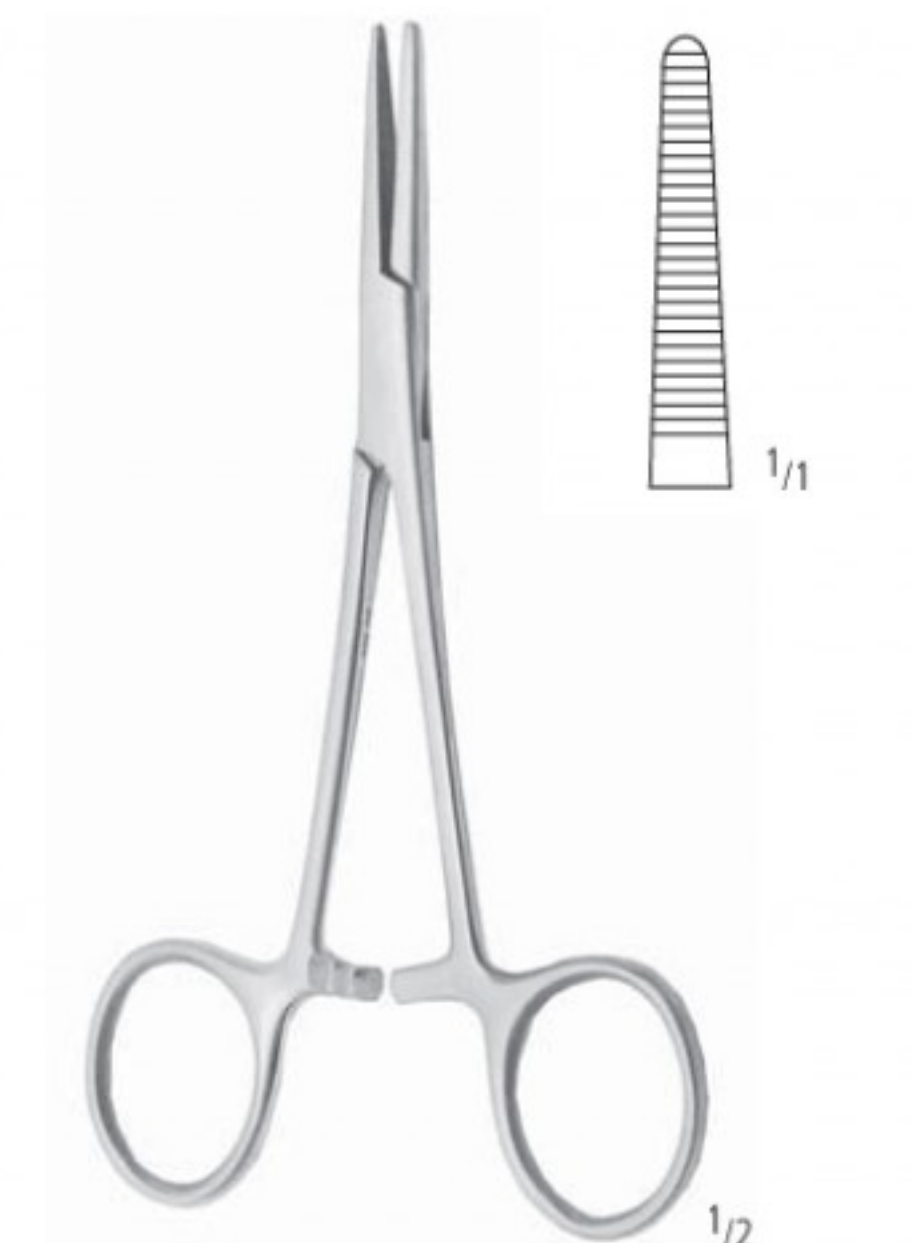

**DUNHILL**

AA 220/13  
 13,0 cm/5"



KLEMMEN HEMOSTATS PINZAS HEMOSTATICAS PINCES HEMOSTATIQUES PINZE EMOSTATICHE

Arterienklemmen, Präparier- und Ligaturklemmen  
 Artery Forceps, Dissecting and Ligature Forceps  
 Pinzas hemostáticas, Pinzas para preparaciones y ligaduras  
 Pincas hémostatiques, Pincas à disséquer et à ligatures  
 Pinze emostatiche, Pinze per preparazioni e legature

AA

AB

AC

AD

AE

AF

AK

AL

AM

AO

AP

AR

KA

KB

KC

KD

KU

KY



1/2

**OVERHOLT-GEISSENDOERFER**

21,0 cm/8<sup>1</sup>/<sub>4</sub>"  
 27,0 cm/10<sup>3</sup>/<sub>4</sub>"

21,0 cm/8<sup>1</sup>/<sub>4</sub>"  
 27,0 cm/10<sup>3</sup>/<sub>4</sub>"  
 29,5 cm/11<sup>1</sup>/<sub>2</sub>"

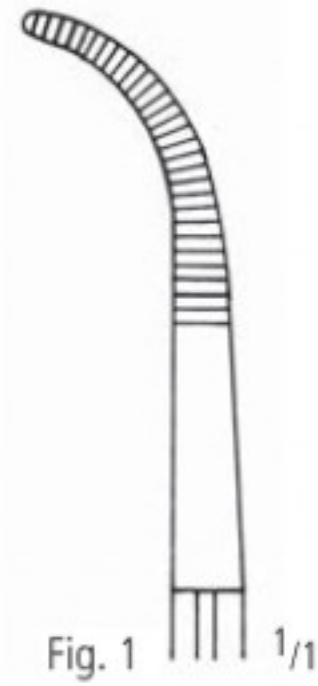

Fig. 1 1/1

AA 221/01  
 AA 223/01

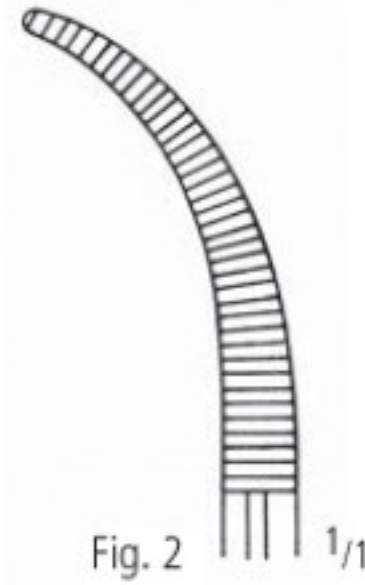

Fig. 2 1/1

AA 221/02  
 AA 223/02

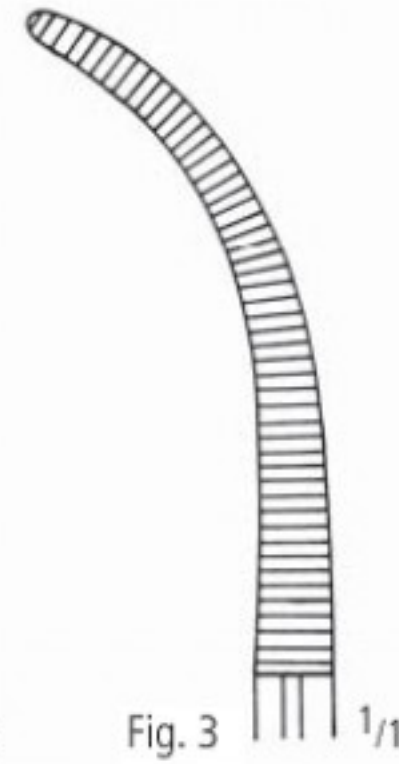

Fig. 3 1/1

AA 221/03  
 AA 223/03

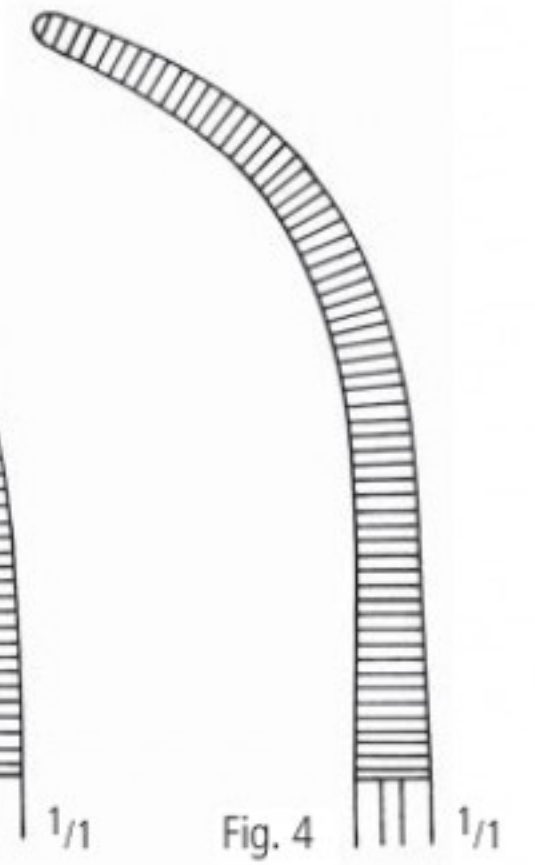

Fig. 4 1/1

AA 221/04  
 AA 223/04

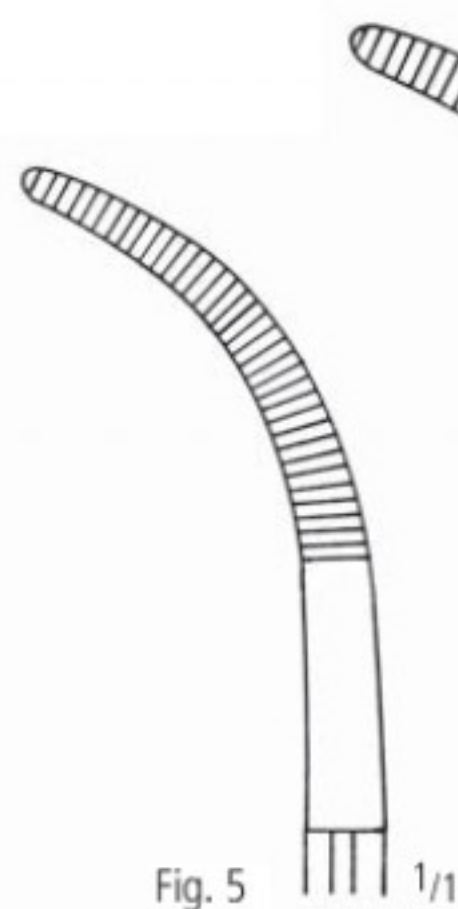

Fig. 5 1/1

AA 221/05  
 AA 223/05

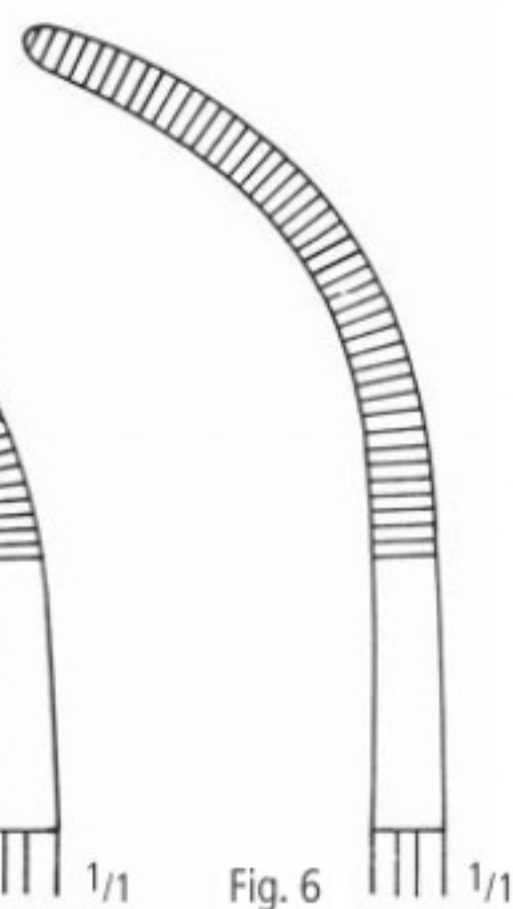

Fig. 6 1/1

AA 221/06  
 AA 223/06

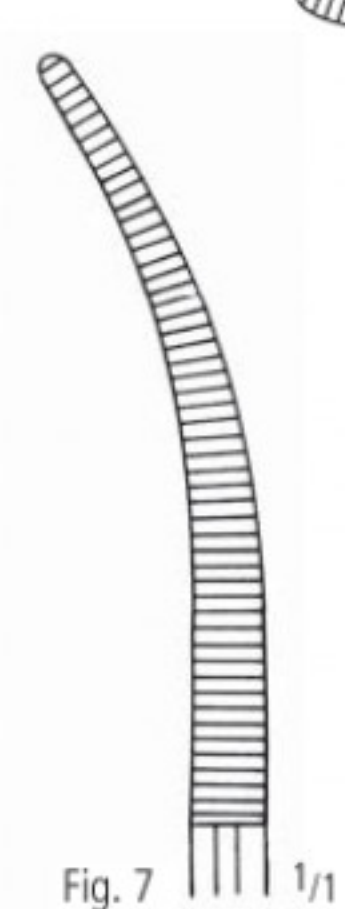

Fig. 7 1/1

AA 221/07  
 AA 223/07

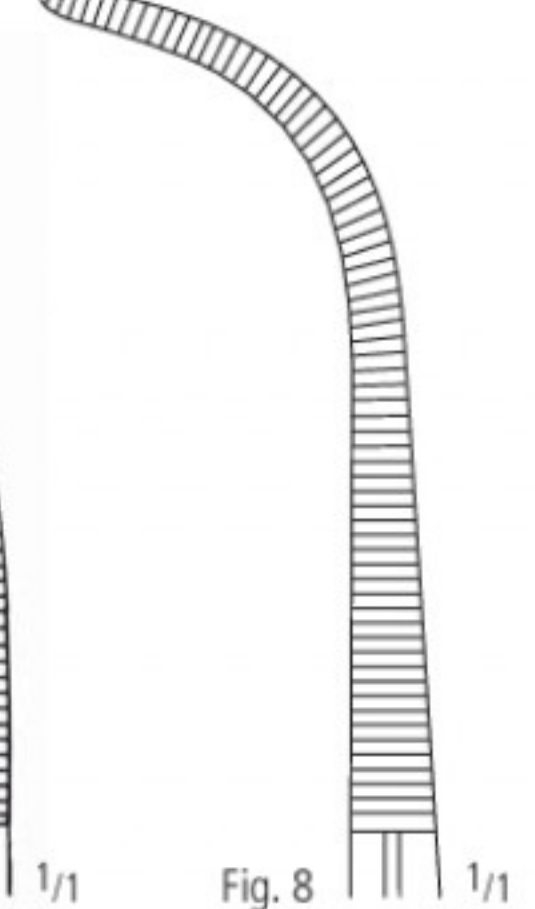

Fig. 8 1/1

AA 224/08



1/2

**BABY-OVERHOLT**

AA 225/13  
 13,5 cm/5<sup>1</sup>/<sub>4</sub>"

Präparier- und Ligaturklemmen  
 Dissecting and Ligature Forceps  
 Pinzas para preparaciones y ligaduras  
 Pincès à disséquer et à ligatures  
 Pinze per preparazioni e legature

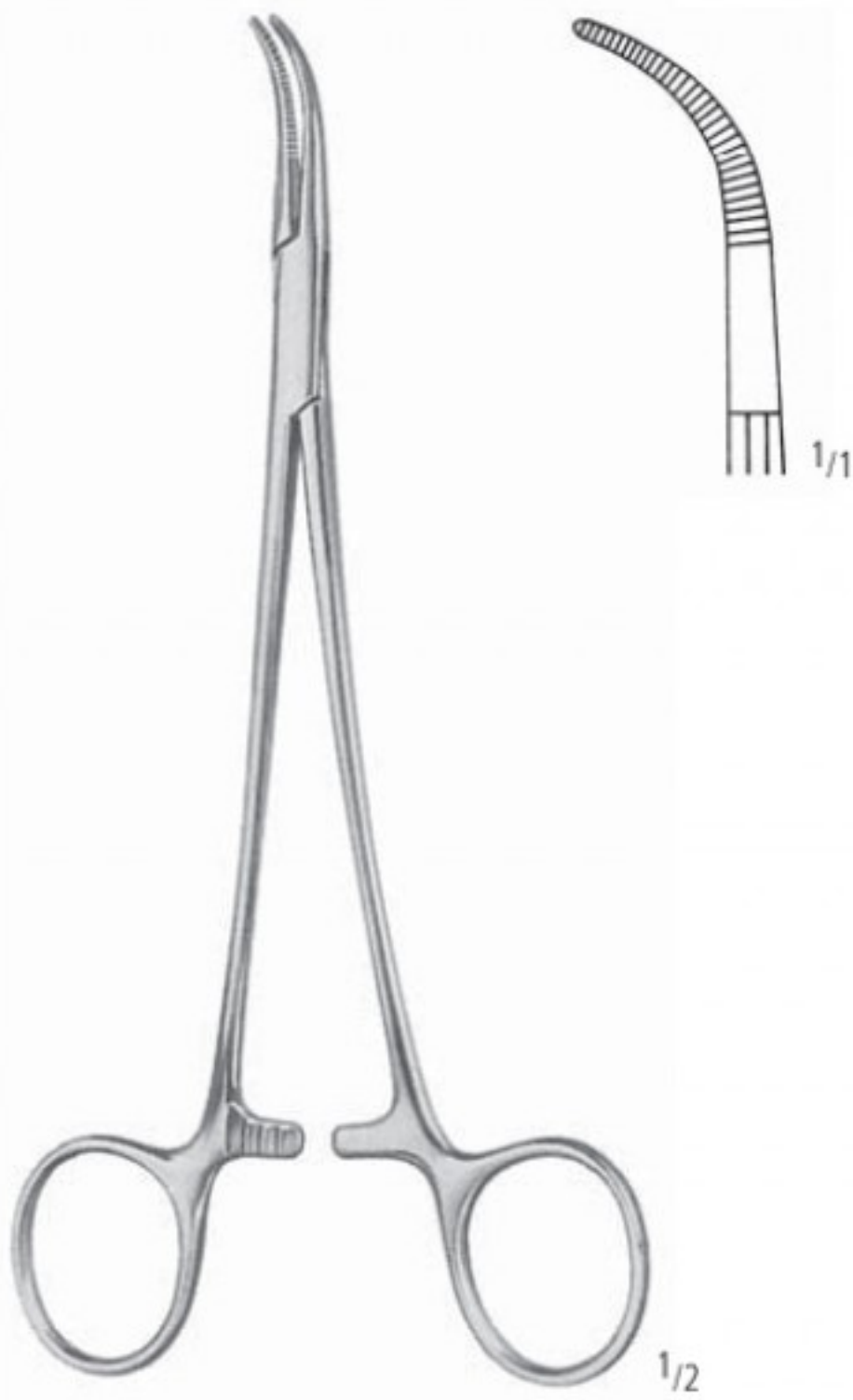

**OVERHOLT**  
 AA 229/01  
 18,5 cm/7<sup>1</sup>/<sub>3</sub>"



**OVERHOLT**  
 AA 229/02  
 20,5 cm/8"

S-förmig gebogen  
 S-shaped  
 curvas en S  
 courbes en S  
 curve in S

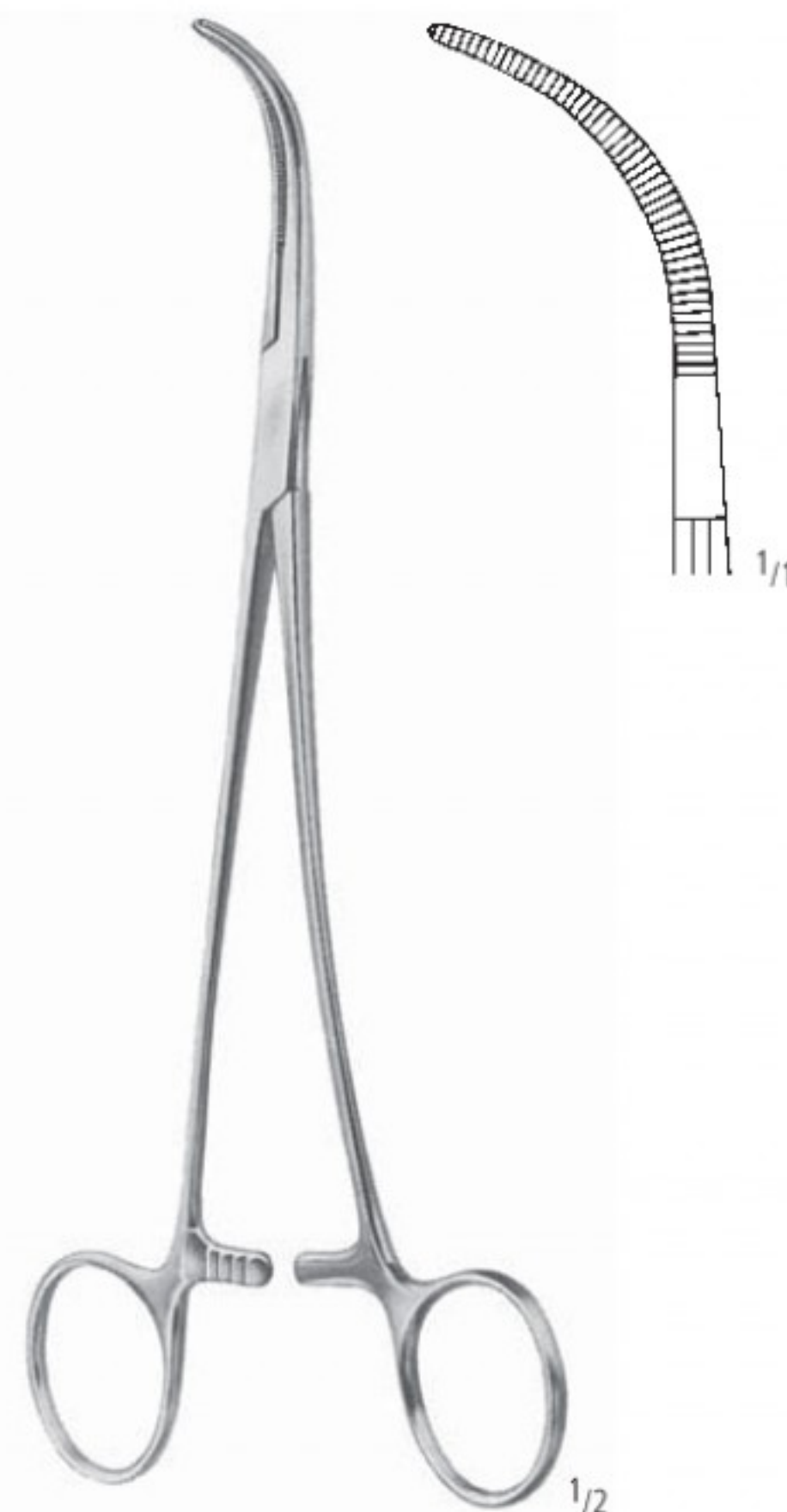

**OVERHOLT**  
 AA 229/03  
 21,0 cm/8<sup>1</sup>/<sub>4</sub>"

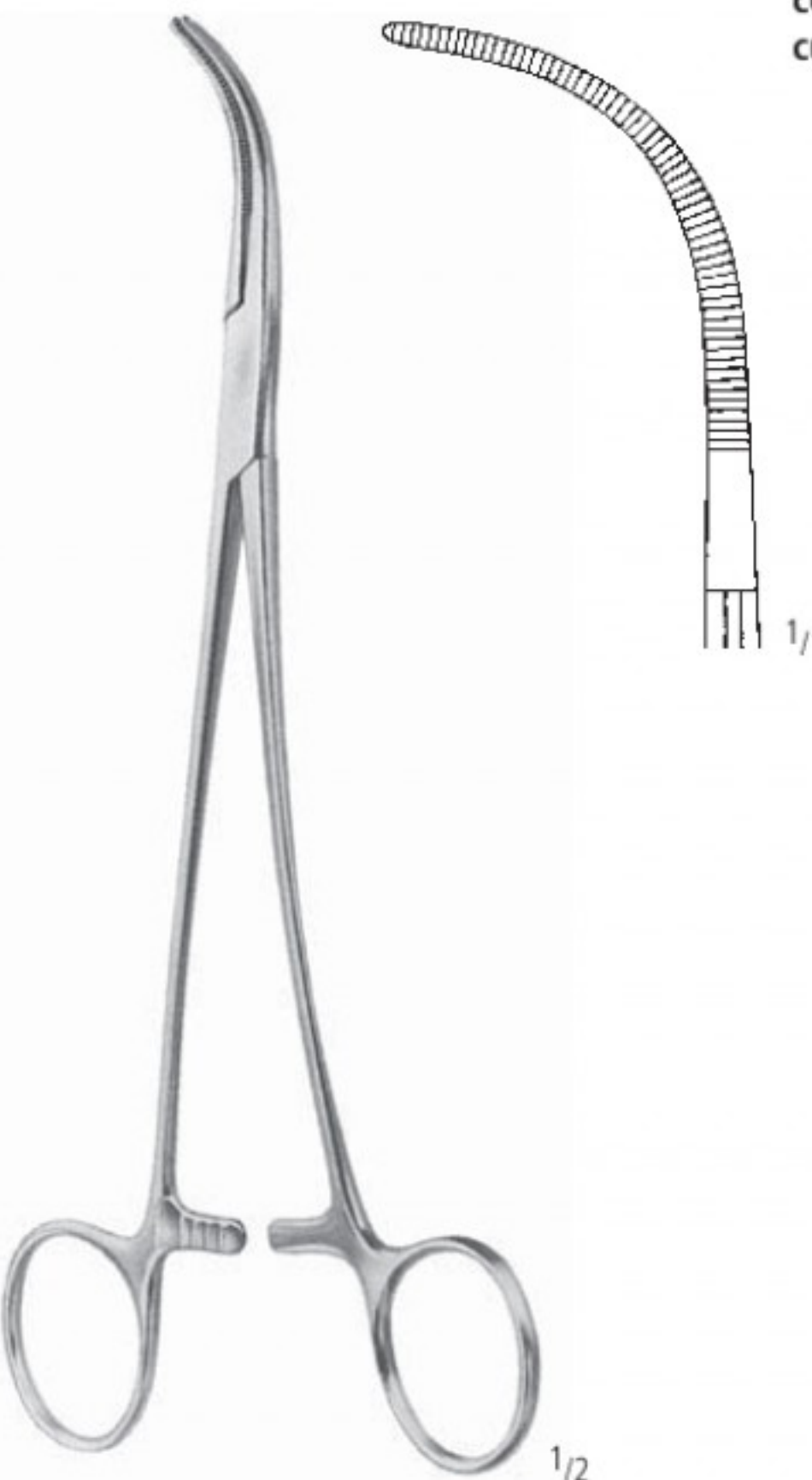

**OVERHOLT**  
 AA 229/04  
 21,5 cm/8<sup>1</sup>/<sub>2</sub>"



KLEMMEN HEMOSTATS PINZAS HEMOSTATICAS PINCES HEMOSTATIQUES PINZE EMOSTATICHE

Arterienklemmen, Präparier- und Ligaturklemmen  
 Artery Forceps, Dissecting and Ligature Forceps  
 Pinzas hemostáticas, Pinzas para preparaciones y ligaduras  
 Pincés hémostatiques, Pincés à disséquer et à ligatures  
 Pinze emostatiche, Pinze per preparazioni e legature

AA

AB

AC

AD

AE

AF

AK

AL

AM

AO

AP

AR

KA

KB

KC

KD

KU

KY



**BABY-ADSON**  
 AA 235/14  
 14,0 cm/5 1/2"



**BABY-ADSON**  
 AA 237/18  
 18,0 cm/7"

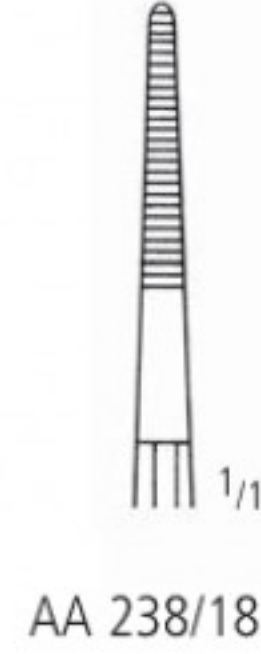

AA 238/18

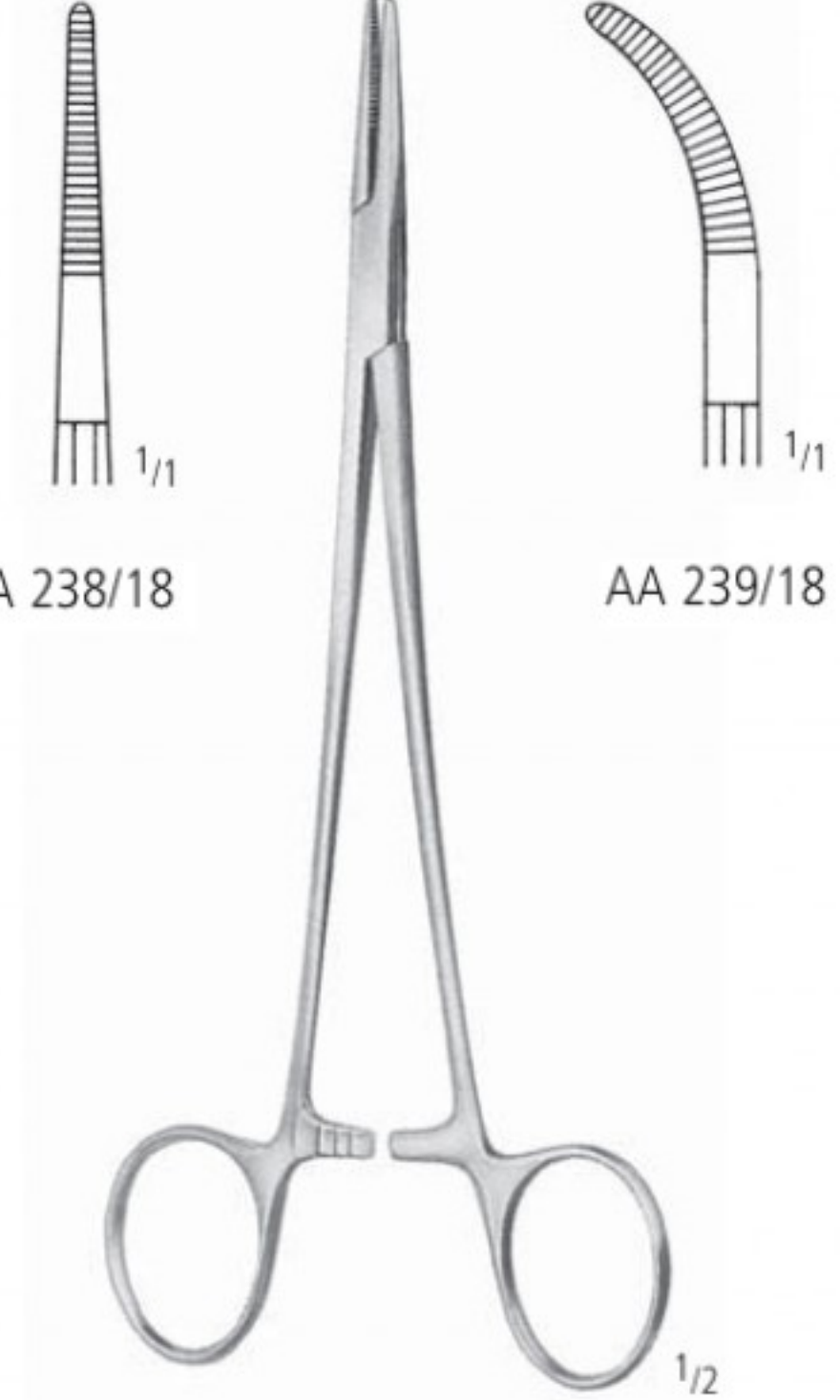

**ADSON**  
 18,5 cm/7 1/3"

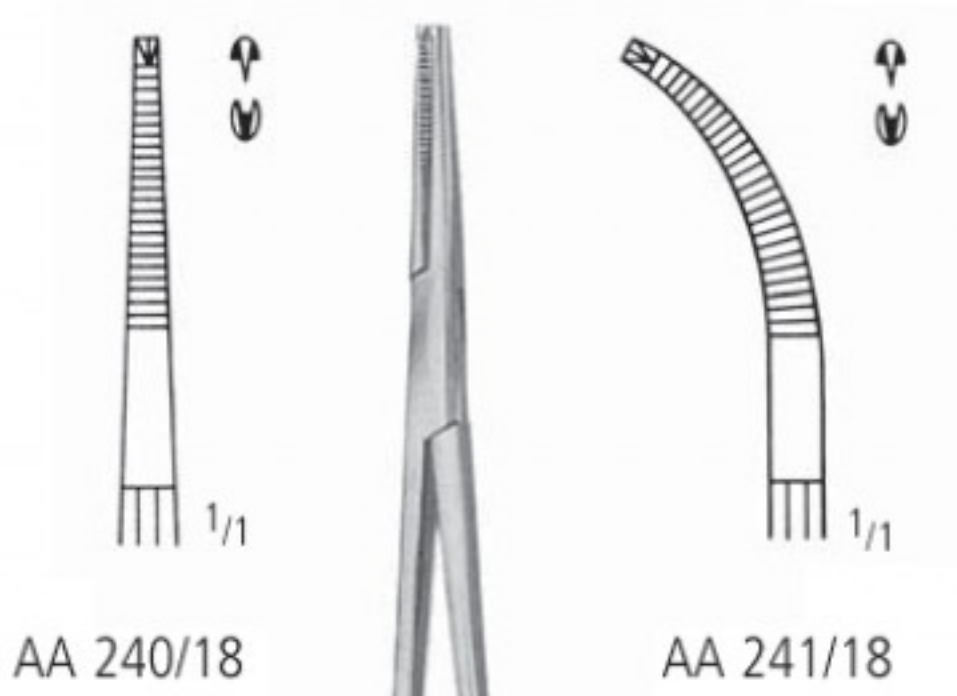

AA 240/18

AA 241/18

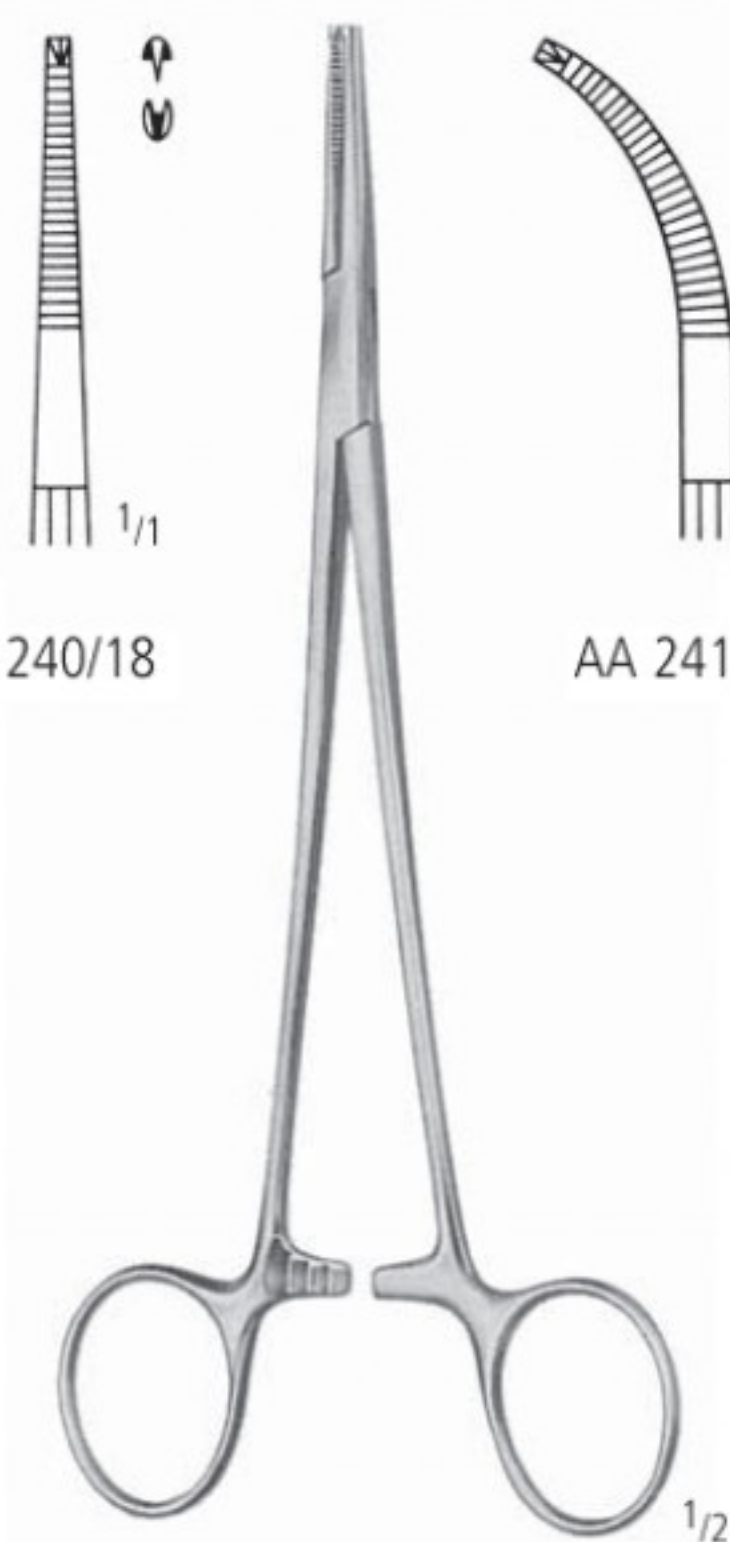

**ADSON 1:2**  
 18,5 cm/7 1/3"



**MEEKER**

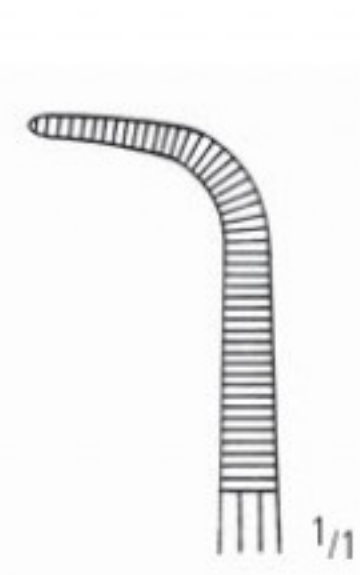

AA 251/18  
 18,0 cm/7"

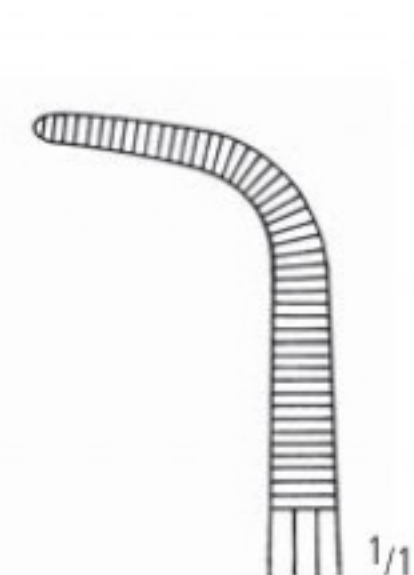

AA 251/28  
 28,0 cm/11"

Arterienklemmen, Kopfhautklemmen  
 Artery Forceps, Scalp Flap Forceps  
 Pinzas hemostáticas, Pinzas hemostáticas para pericráneo  
 Pincés hémostatiques, Pincés hémostatiques pour le cuir chevelu  
 Pinze emostatiche, Pinze emostatiche per il cuoio capelluto



**DIXON-LOVELACE**  
 AA 286/15  
 15,5 cm/6"



**DIXON-LOVELACE 1:2**  
 AA 288/15  
 15,5 cm/6"

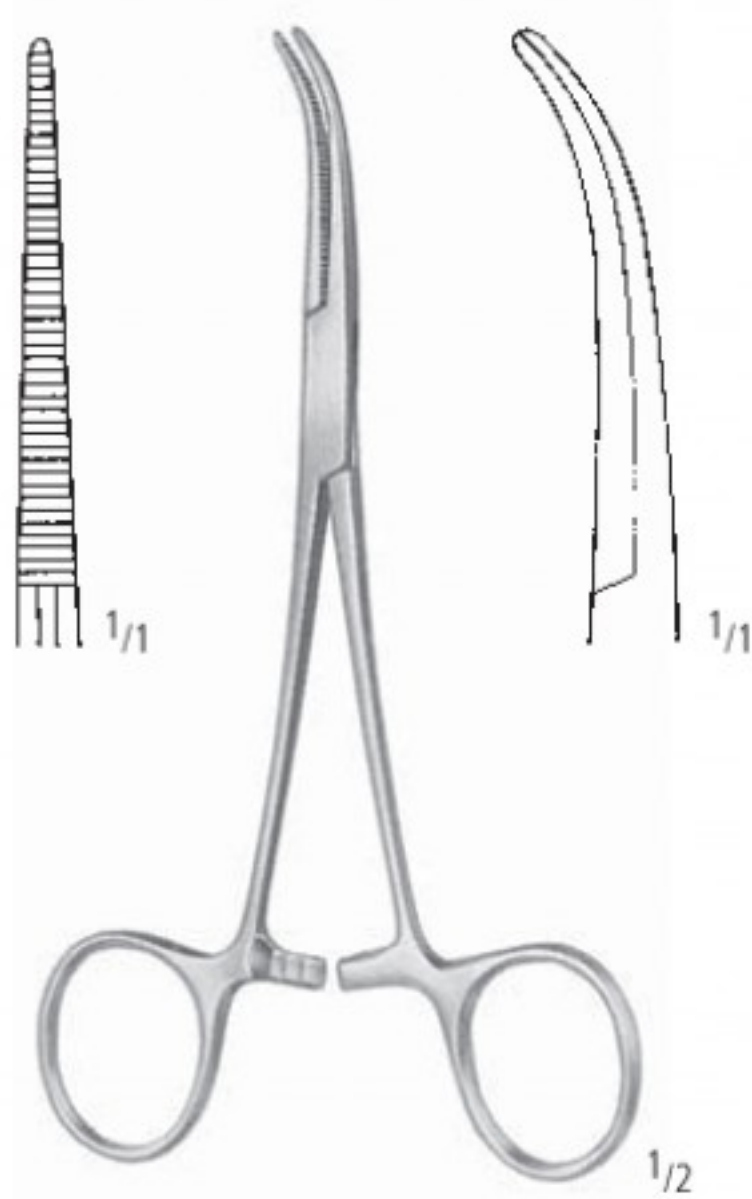

**DANDY**  
 AA 291/14  
 14,0 cm/5 1/2"

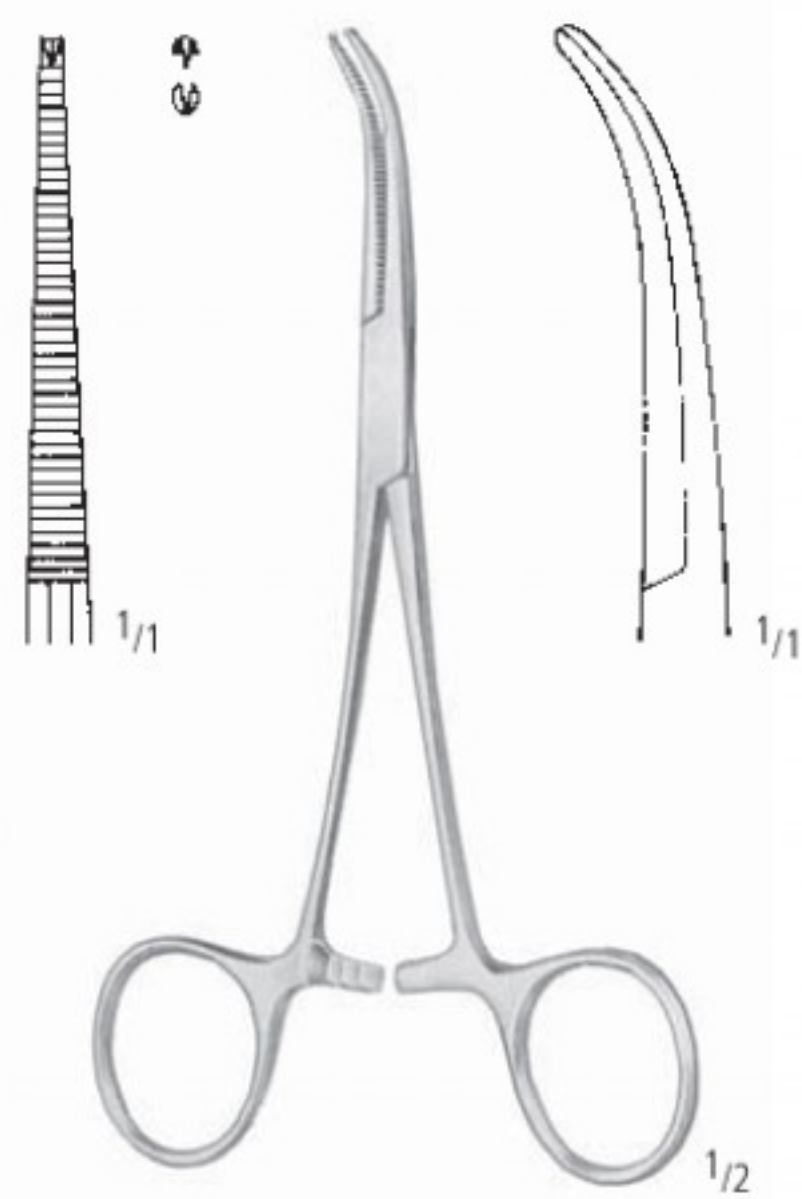

**DANDY 1:2**  
 AA 293/14  
 14,0 cm/5 1/2"



KLEMMEN HEMOSTATS PINZAS HEMOSTATICAS PINCES HEMOSTATIQUES PINZE EMOSTATICHE

Tonsillenklemmen, Arterienklemmen  
 Tonsil Hemostatic Forceps, Artery Forceps  
 Pinzas hemostáticas para amígdalas, Pinzas hemostáticas  
 Pincés hémostatiques pour amygdales, Pincés hémostatiques  
 Pinze emostatiche per tonsille, Pinze emostatiche

AA  
 AB  
 AC  
 AD  
 AE  
 AF  
 AG  
 AH  
 AI  
 AJ  
 AK  
 AL  
 AM  
 AN  
 AO  
 AP  
 AQ  
 AR  
 AS  
 AT  
 AU  
 AV  
 AW  
 AX  
 AY  
 AZ

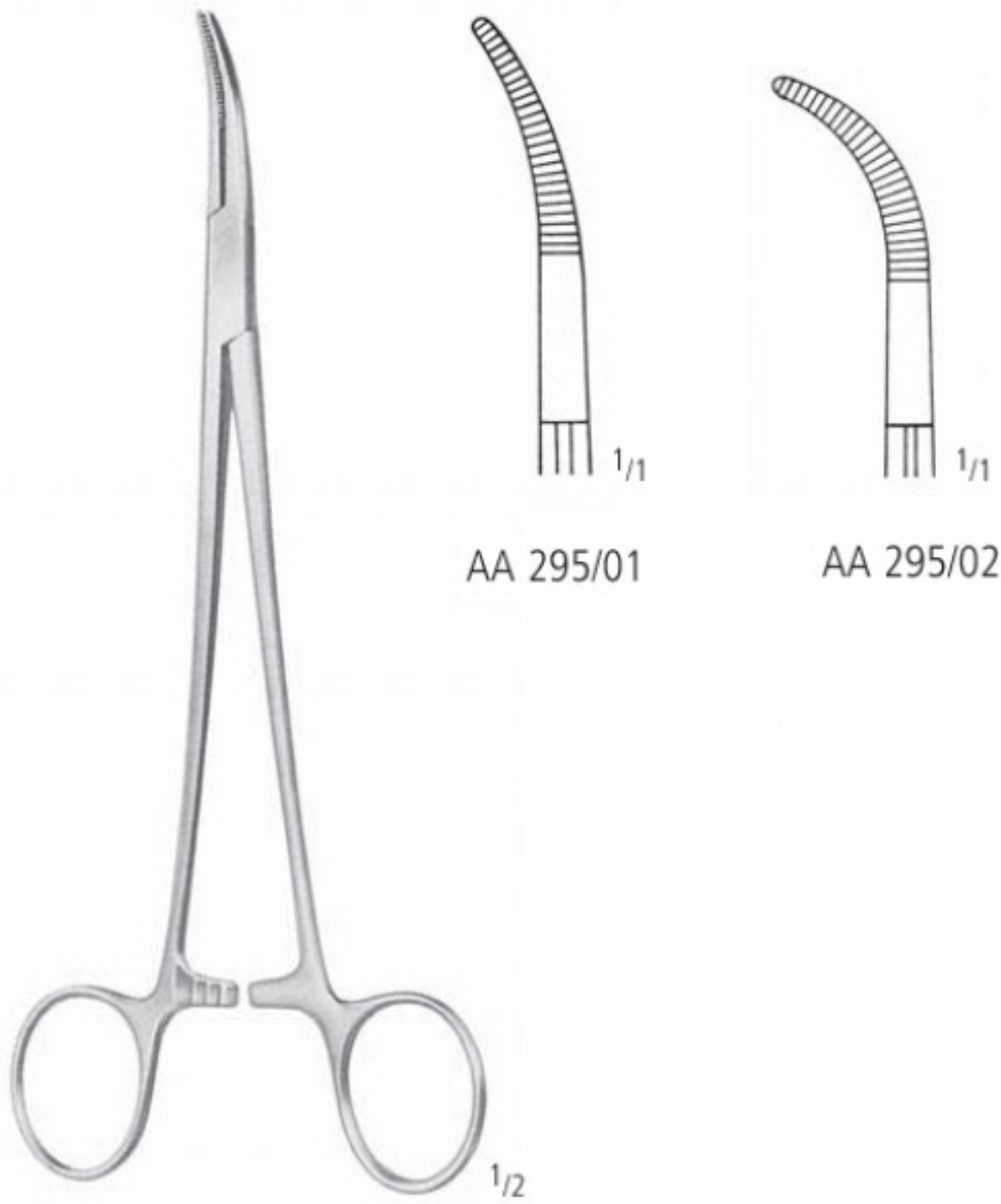

AA 295/01

AA 295/02

**SCHNIDT-SAWTELL**  
 19,0 cm/7<sup>1</sup>/<sub>2</sub>"

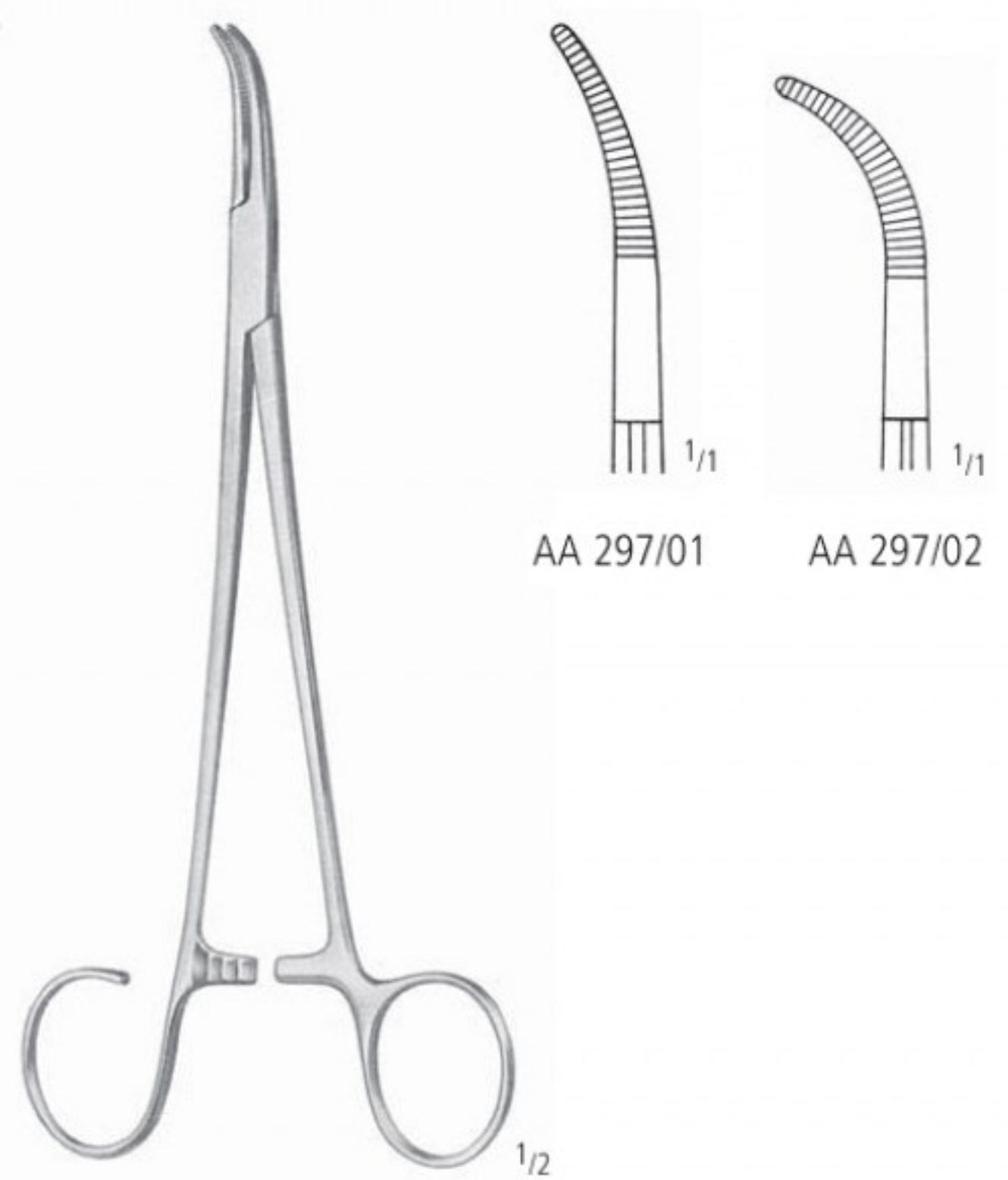

AA 297/01

AA 297/02

**SCHNIDT-SAWTELL**  
 19,0 cm/7<sup>1</sup>/<sub>2</sub>"

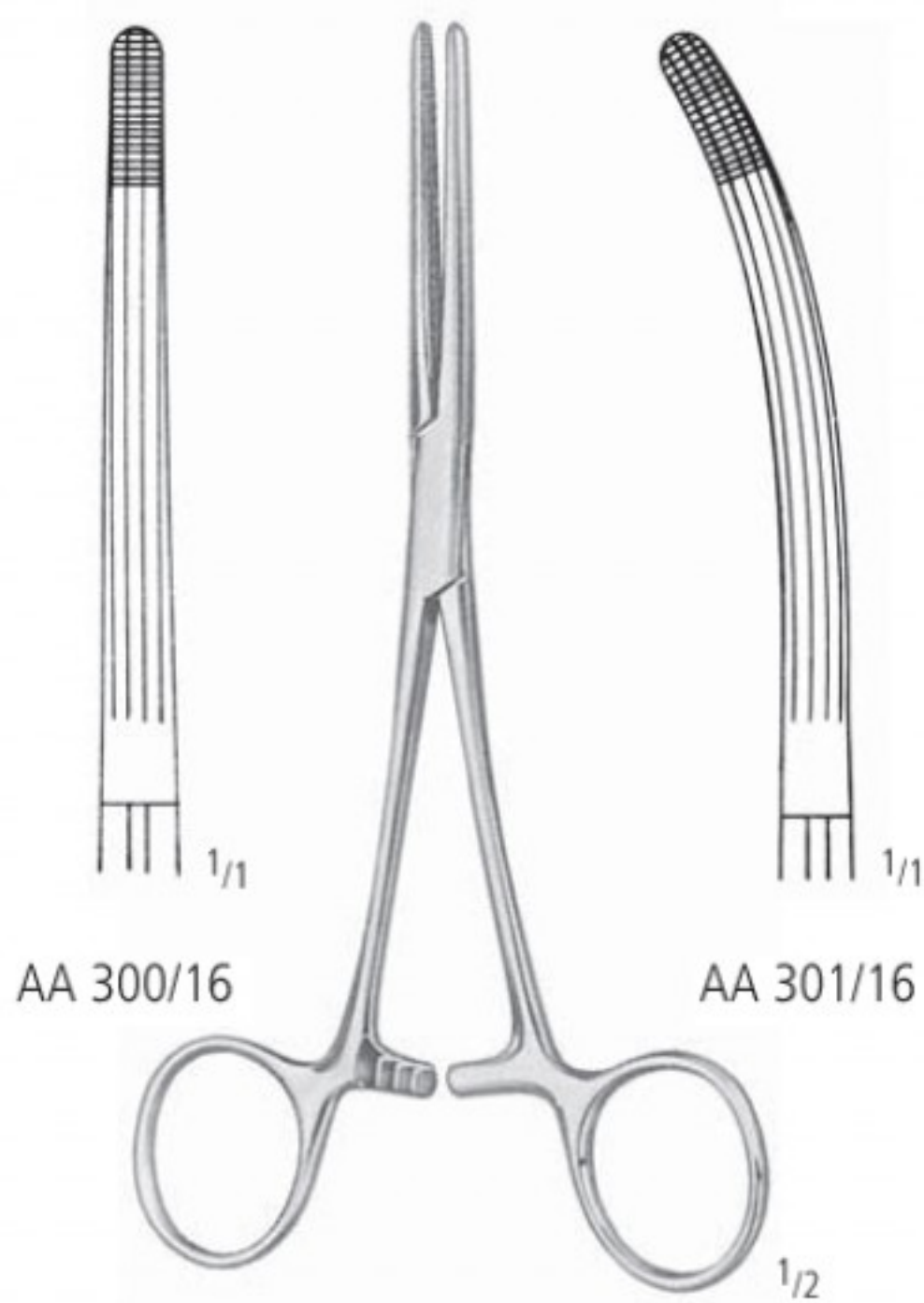

AA 300/16

AA 301/16

**ROCHESTER-CARMALT**

AA 300/16  
 AA 300/20

16,0 cm/6<sup>1</sup>/<sub>4</sub>"  
 20,0 cm/8"

AA 301/16  
 AA 301/20

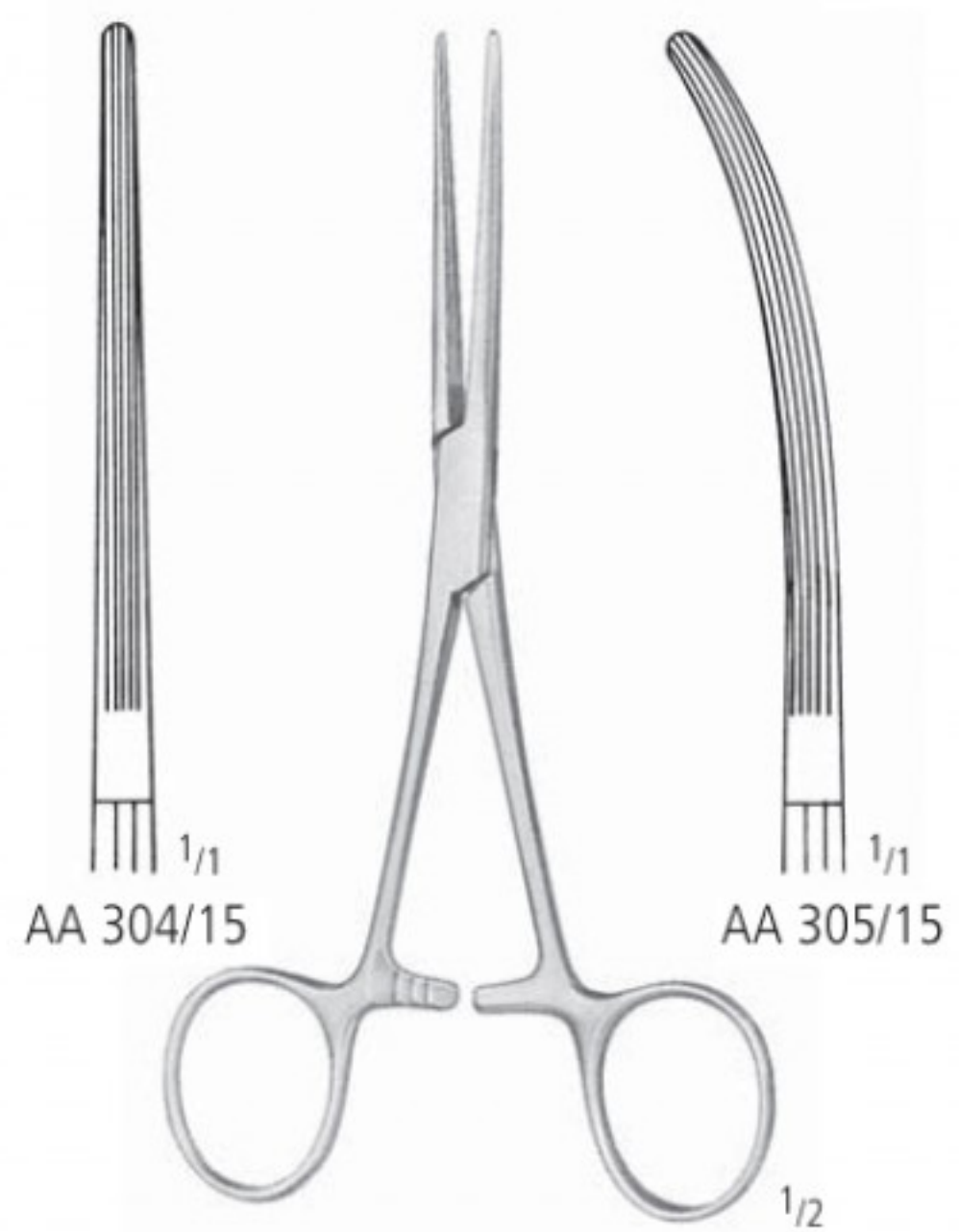

AA 304/15

AA 305/15

**BAINBRIDGE**

AA 304/15  
 AA 304/18

15,0 cm/6"  
 18,5 cm/7<sup>1</sup>/<sub>3</sub>"

AA 305/15  
 AA 305/18

**AA**

KLEMMEN HEMOSTATS PINZAS HEMOSTATICAS PINCES HEMOSTATIQUES PINZE EMOSTATICHE

Arterienklemmen  
 Artery Forceps  
 Pinzas hemostáticas  
 Pincas hémostatiques  
 Pinze emostatiche

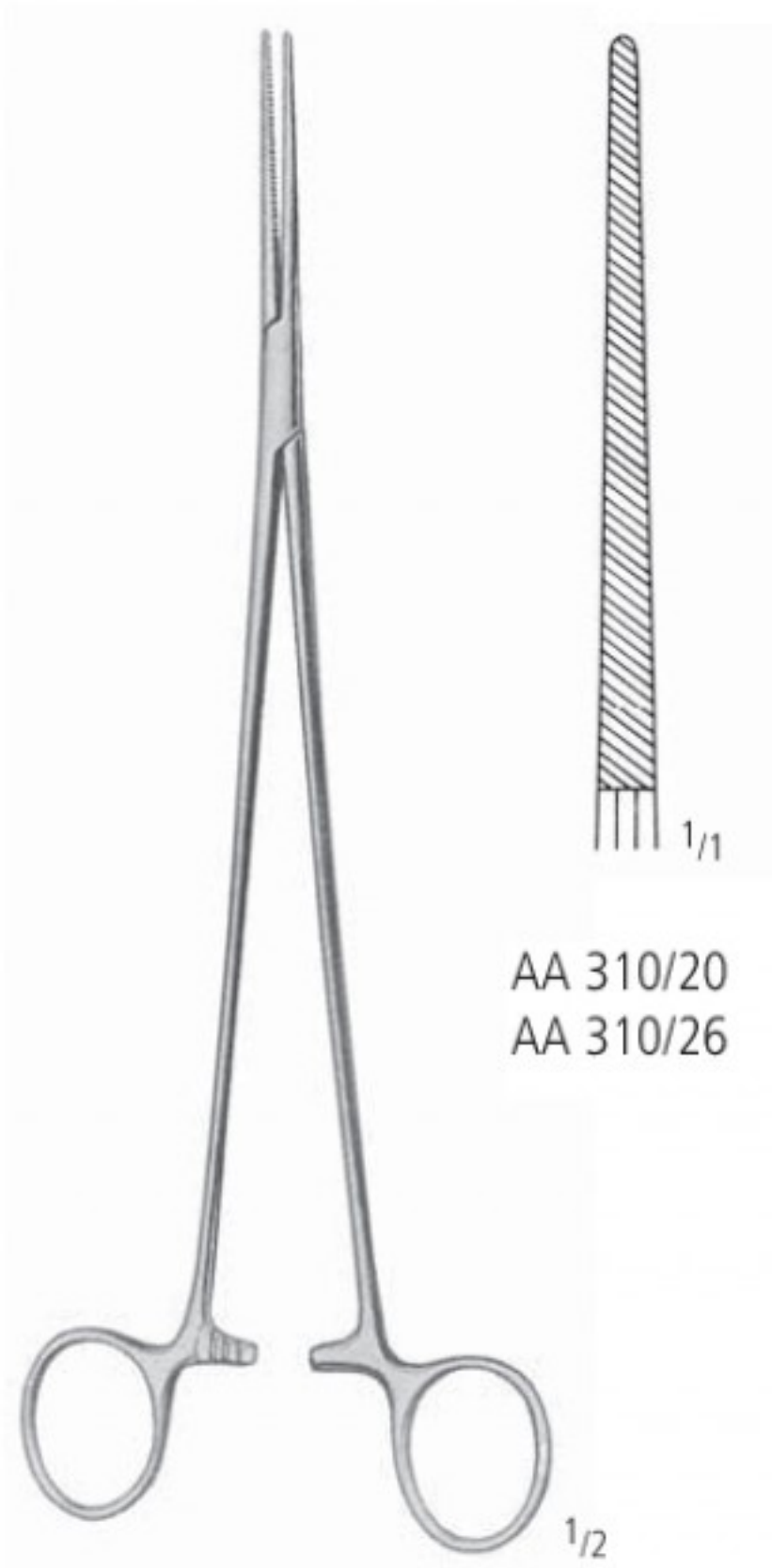

**BENGOLEA**

AA 310/20  
 AA 310/26

20,0 cm/8"  
 26,0 cm/10 1/2"



AA 311/20  
 AA 311/26

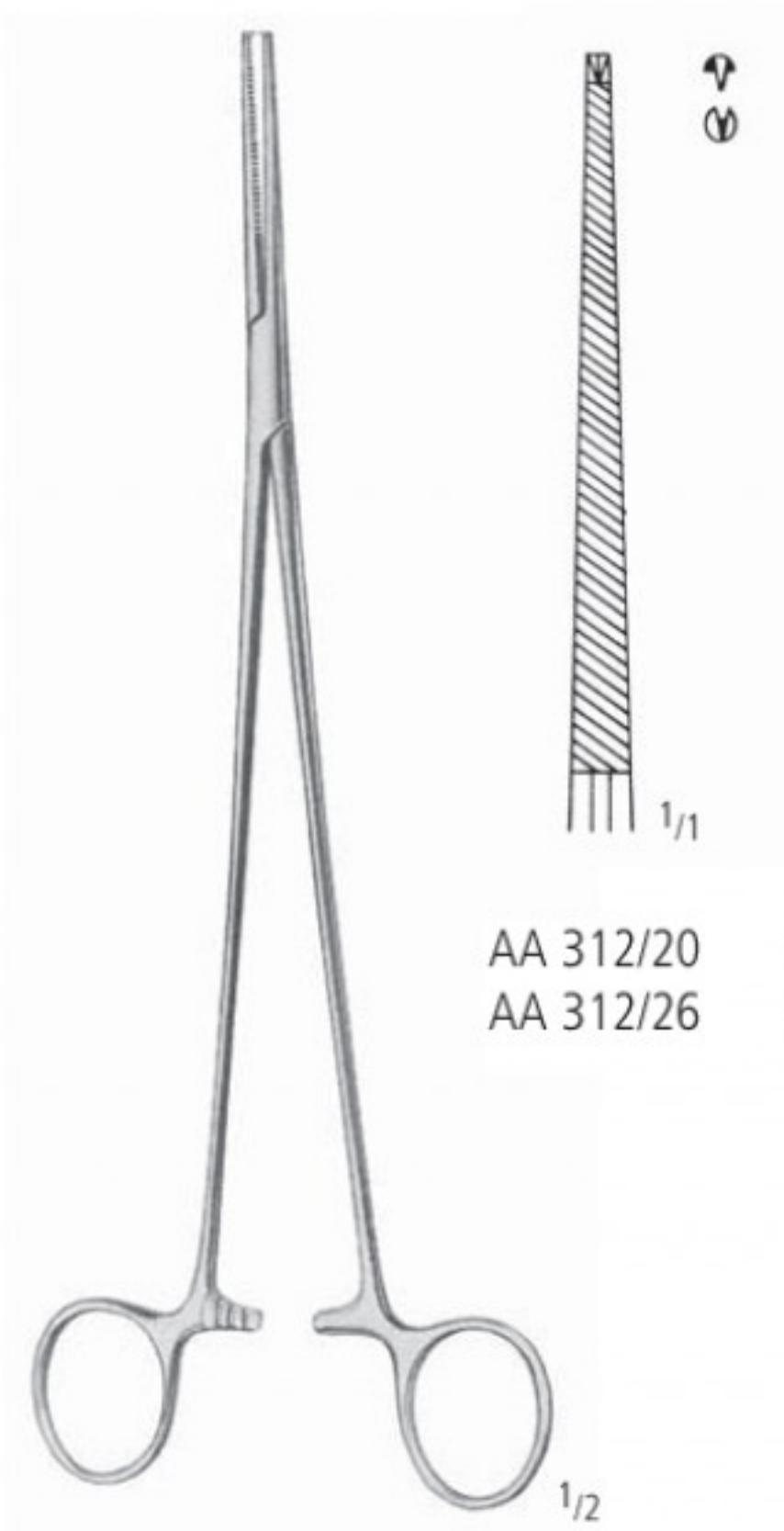

**BENGOLEA 1:2**

AA 312/20  
 AA 312/26

20,0 cm/8"  
 26,0 cm/10 1/2"

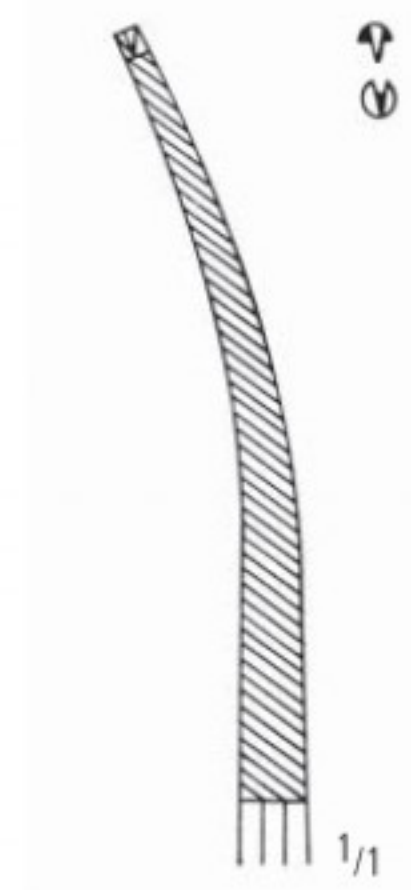

AA 313/20  
 AA 313/26



Aurikelklemmen, Präparier- und Ligaturklemmen  
 Auricle Forceps, Dissecting and Ligature Forceps  
 Pinzas para aurícula, Pinzas para preparaciones y ligaduras  
 Pincés auriculaires, Pincés à disséquer et à ligatures  
 Pinza auricolari, Pinze per preparazioni e legature

AA

AB

AC

AD

AE

AF

AK

AL

AM

AO

AP

AR

KA

KB

KC

KD

KU

KY



**CRAFOORD-SELLORS**

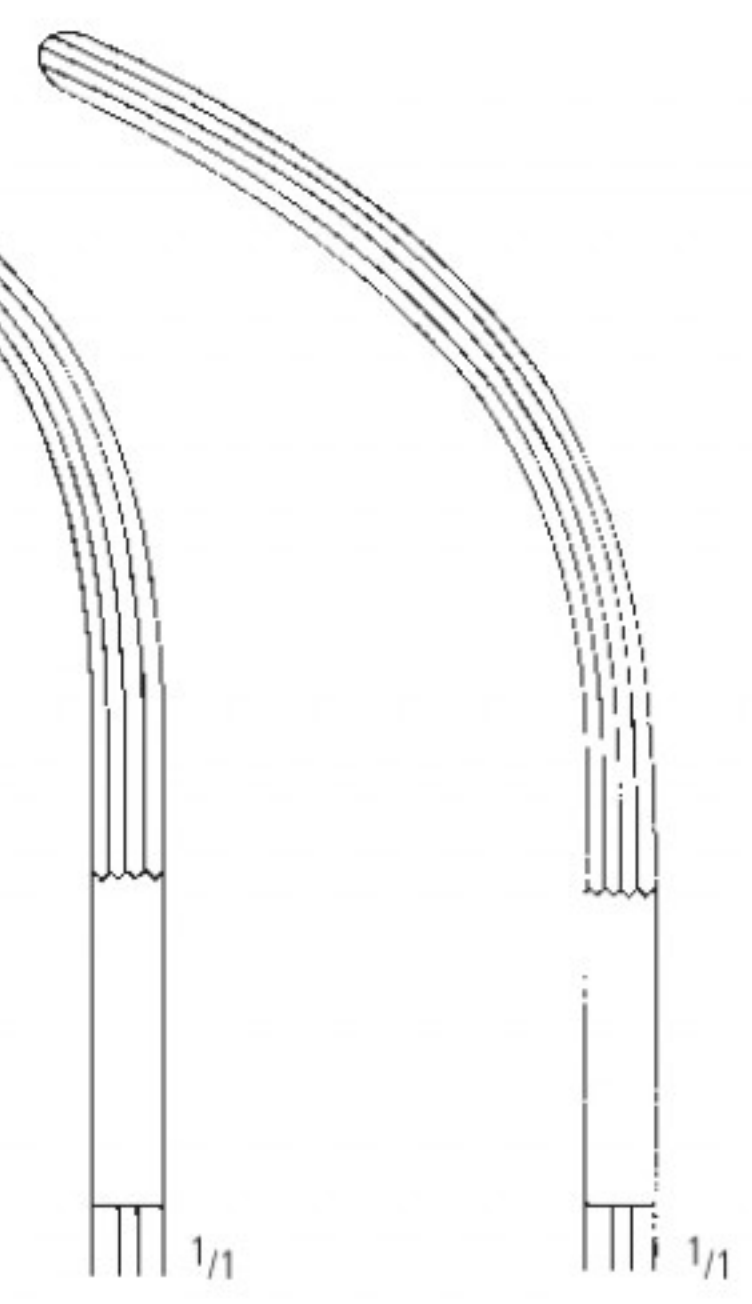

AA 317/22  
22,0 cm/8<sup>3</sup>/<sub>4</sub>"

AA 317/23  
23,0 cm/9"

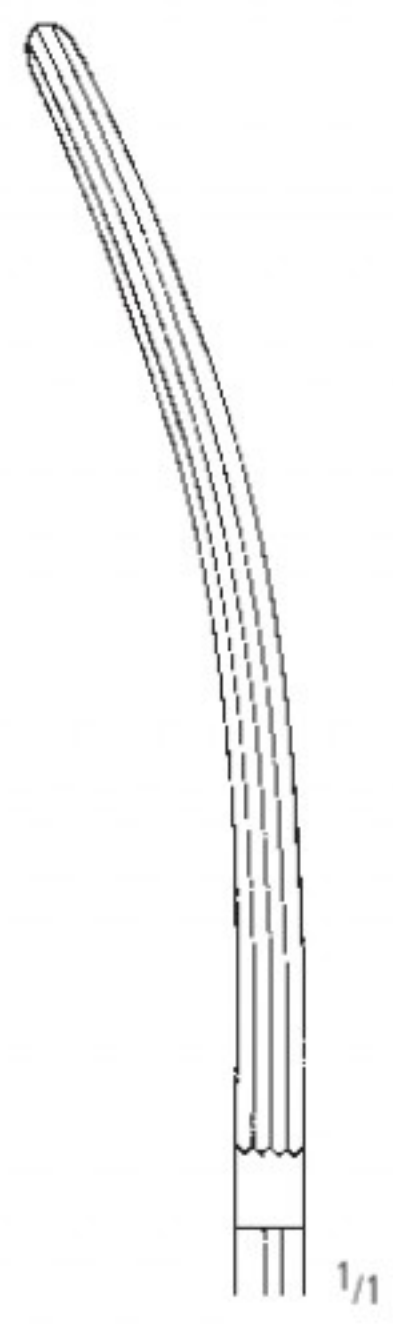

AA 317/24  
24,0 cm/9<sup>1</sup>/<sub>2</sub>"

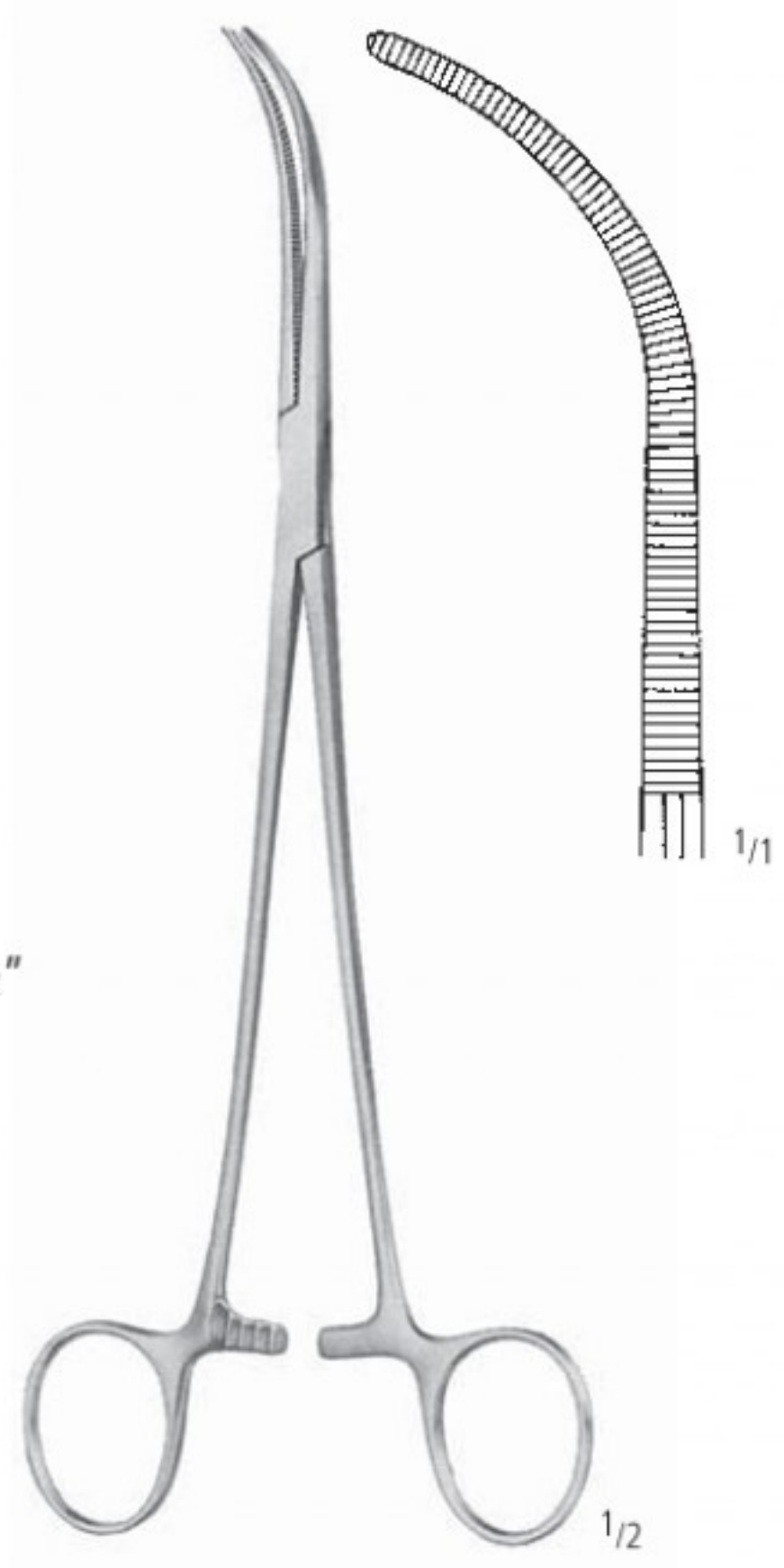

**OVERHOLT-MIXTER**

AA 319/21  
21,0 cm/8<sup>1</sup>/<sub>4</sub>"

Arterienklemmen, Bronchusklemmen  
 Artery Forceps, Bronchus Forceps  
 Pinzas hemostáticas, Pinzas-clamps bronquias  
 Pincés hémostatiques, Pincés-clamps à bronches  
 Pinze emostatiche, Pinze per bronchi

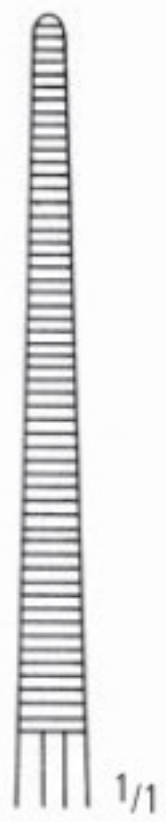

Fig. 1  
AA 320/01

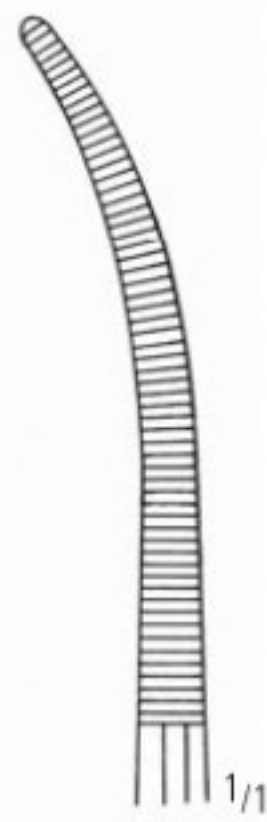

Fig. 2  
AA 320/02

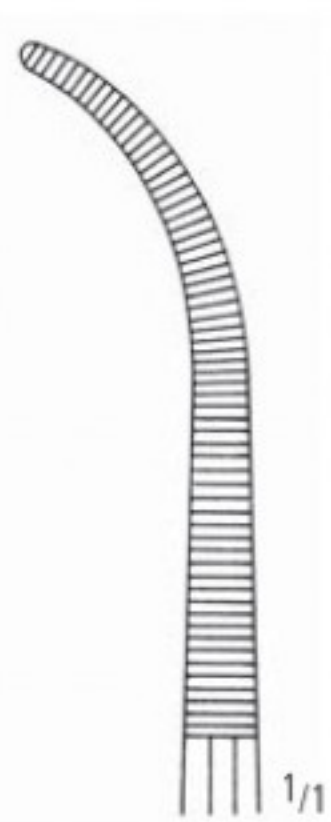
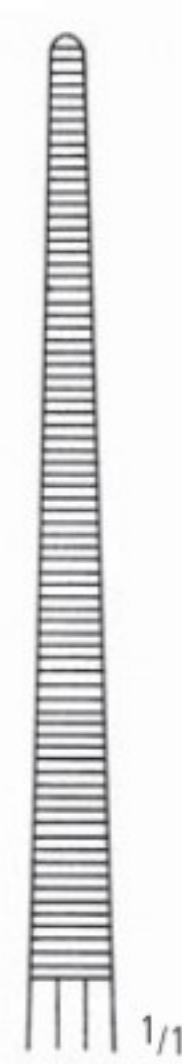
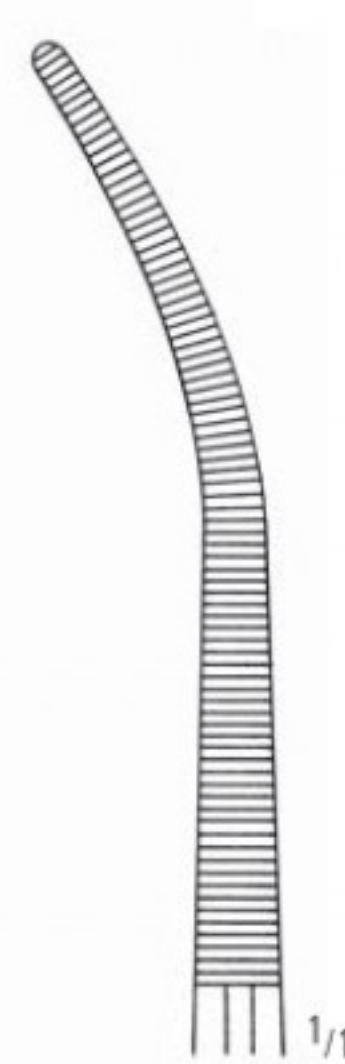

Fig. 3  
AA 320/03



AA 322/22



AA 323/22

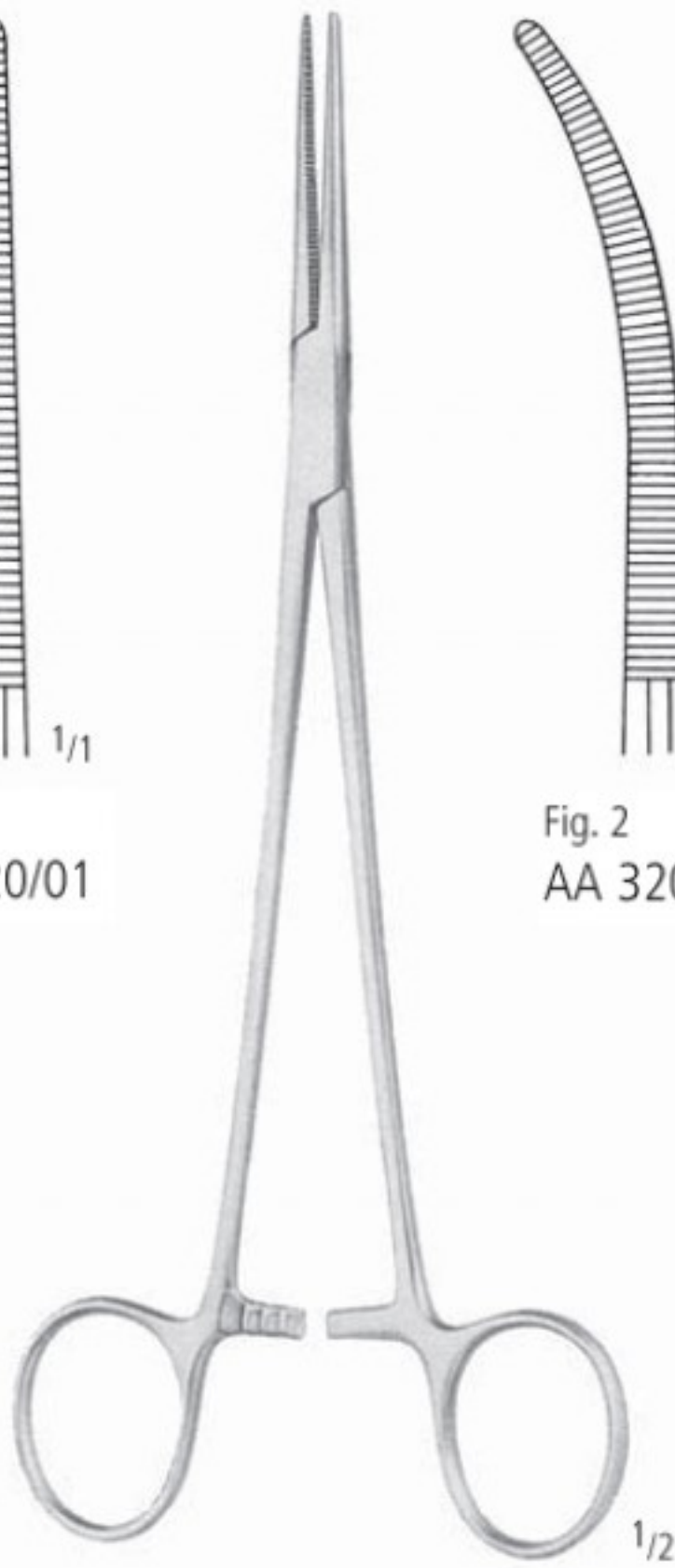

**HEISS**  
20,0 cm/8"

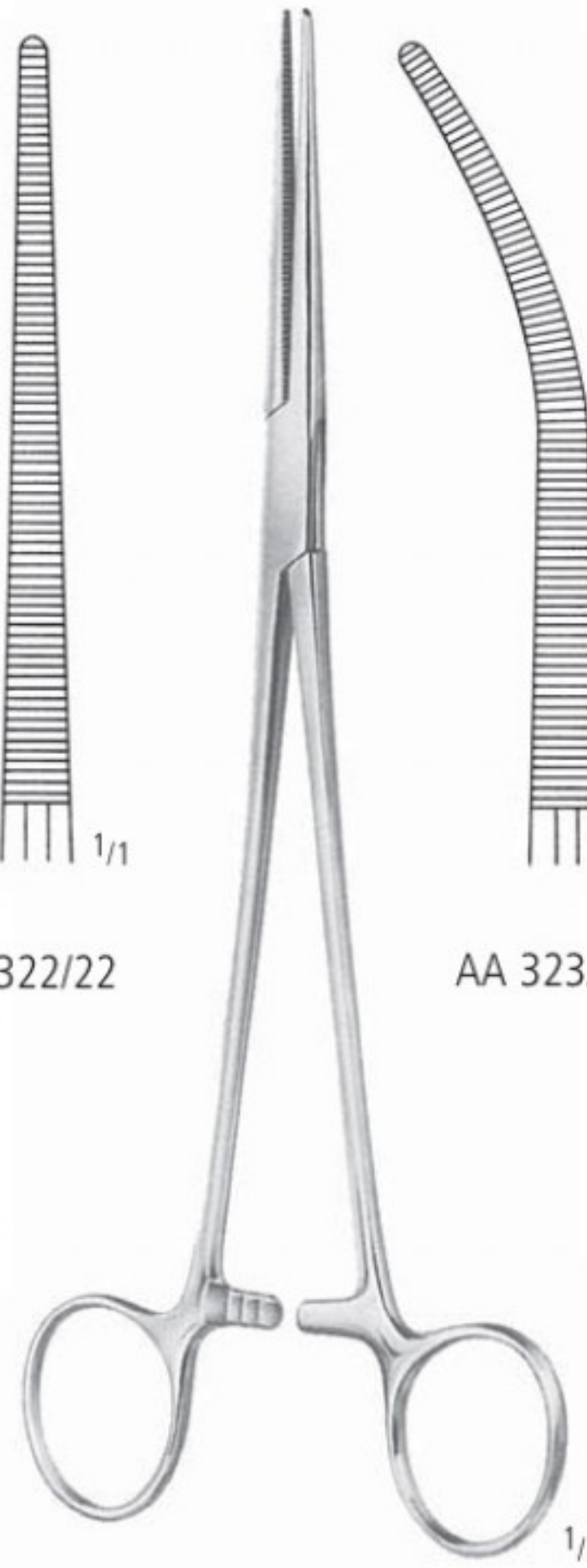

**ROBERTS**  
22,0 cm/8<sup>3</sup>/<sub>4</sub>"

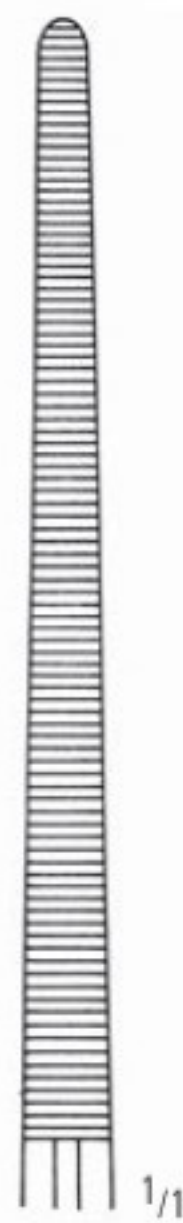

AA 328/24

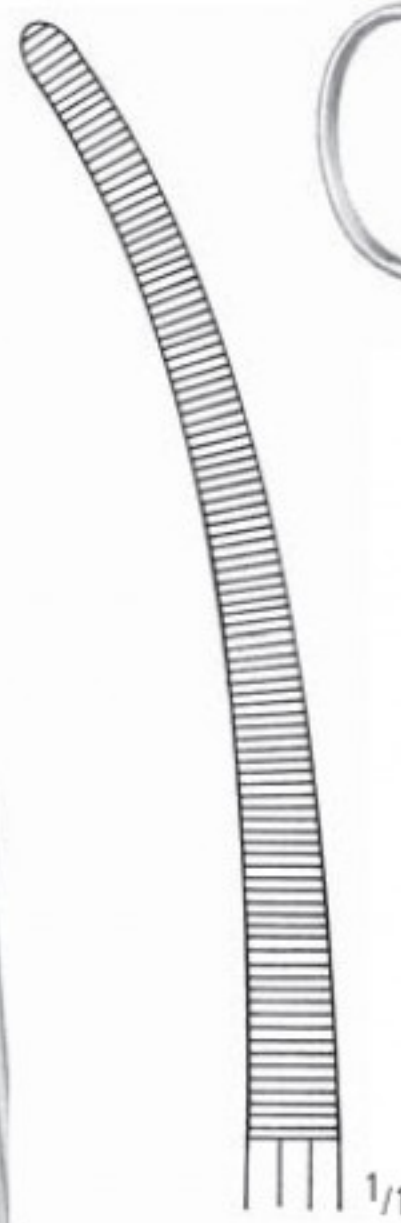

AA 329/24

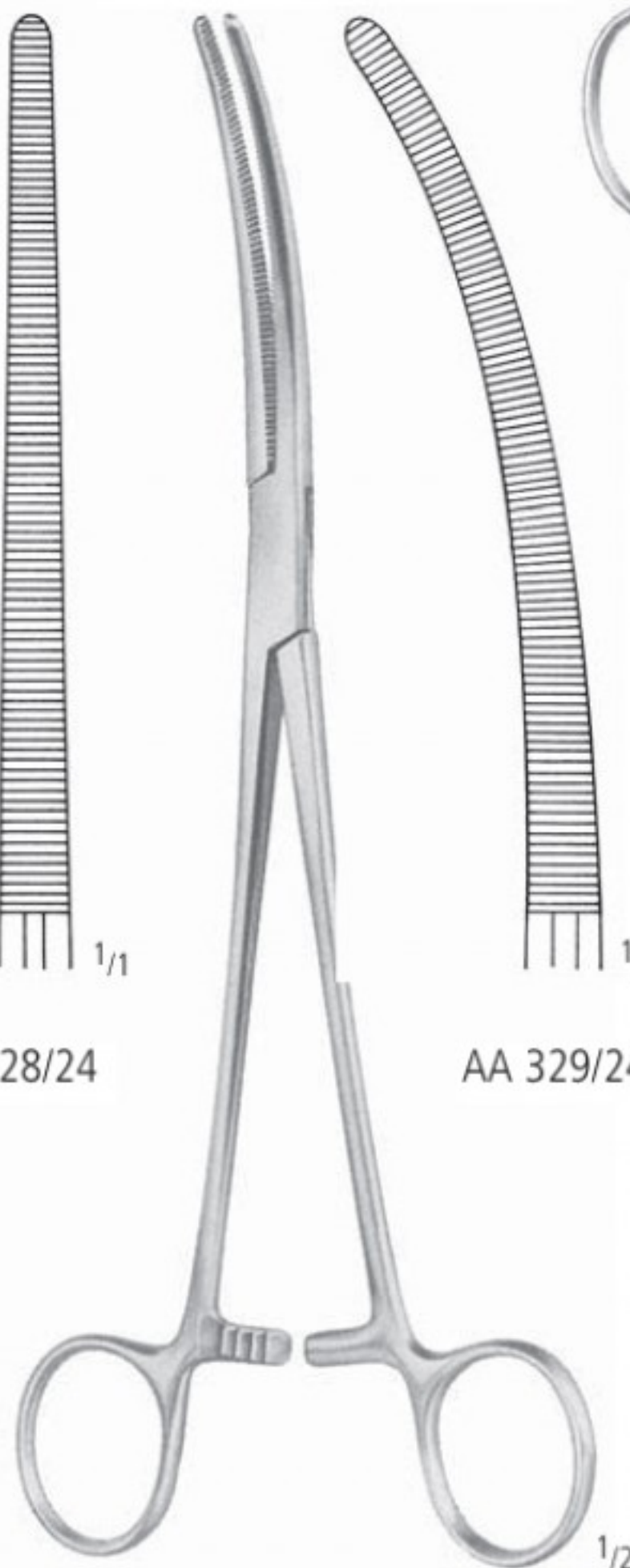

**SAROT**  
24,0 cm/9<sup>1</sup>/<sub>2</sub>"



1/1

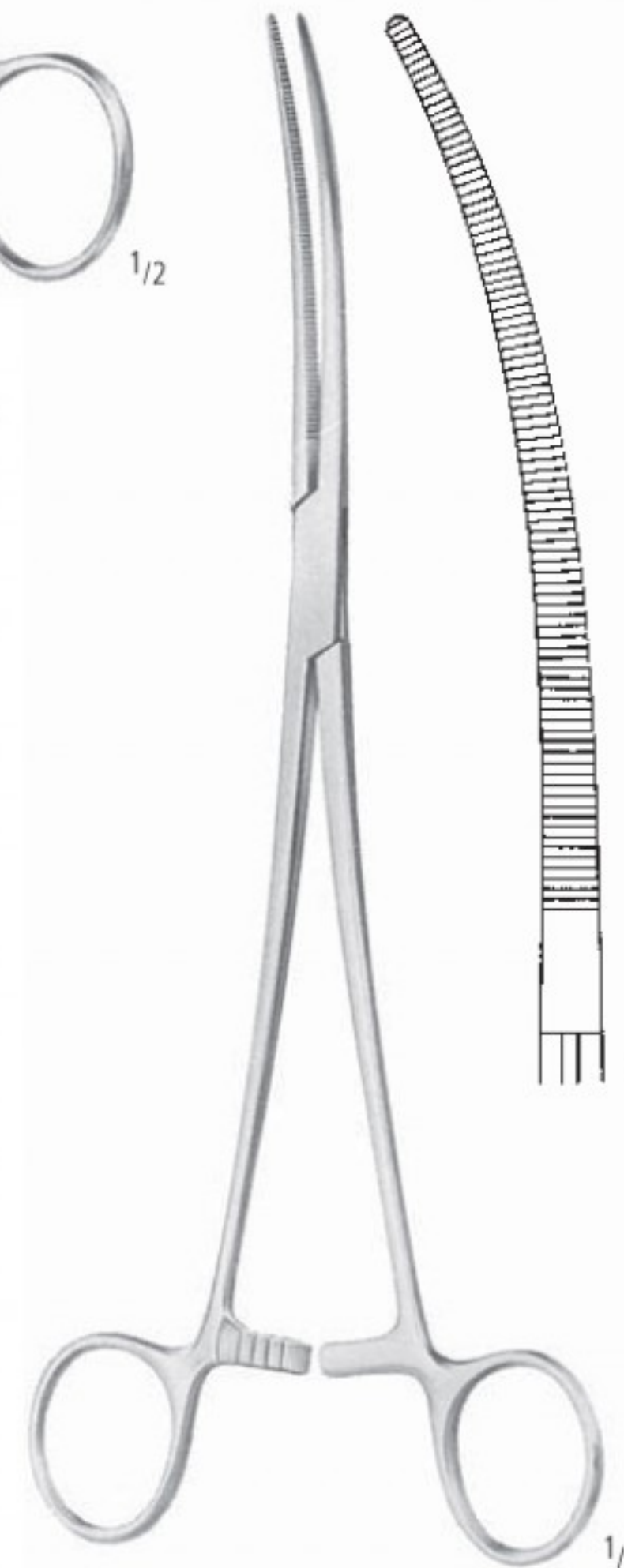

**CRAFOORD**  
AA 330/24  
24,0 cm/9<sup>1</sup>/<sub>2</sub>"



KLEMMEN HEMOSTATS PINZAS HEMOSTATICAS PINCES HEMOSTATIQUES PINZE EMOSTATICHE

Präparier- und Ligaturklemmen  
 Dissecting and Ligature Forceps  
 Pinzas para preparaciones y ligaduras  
 Pincès à disséquer et à ligatures  
 Pinze per preparazioni e legature

AA  
 AB  
 AC  
 AD  
 AE  
 AF  
 AK  
 AL  
 AM  
 AO  
 AP  
 AR  
 KA  
 KB  
 KC  
 KD  
 KU  
 KY



**RUMEL**  
 23,0 cm/9"



AA 335/01

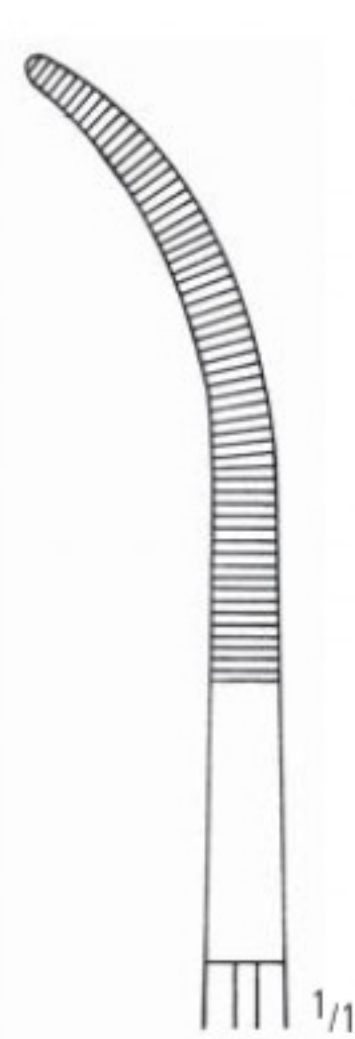

AA 335/02

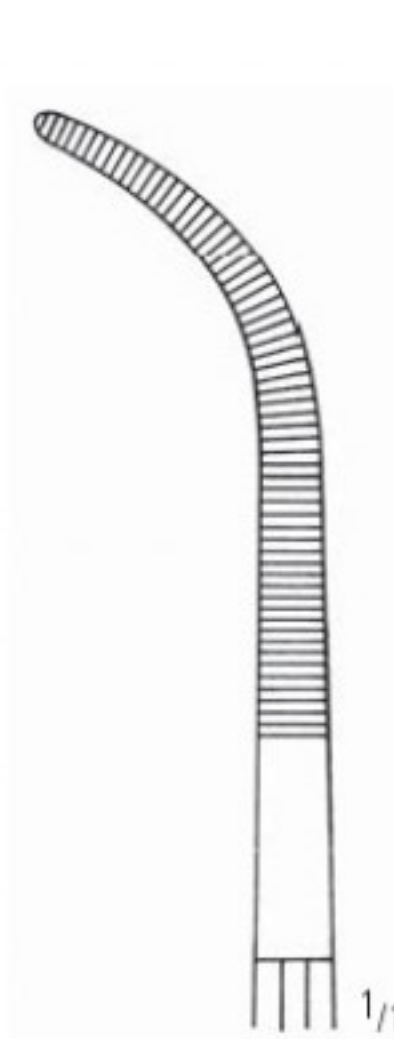

AA 335/03

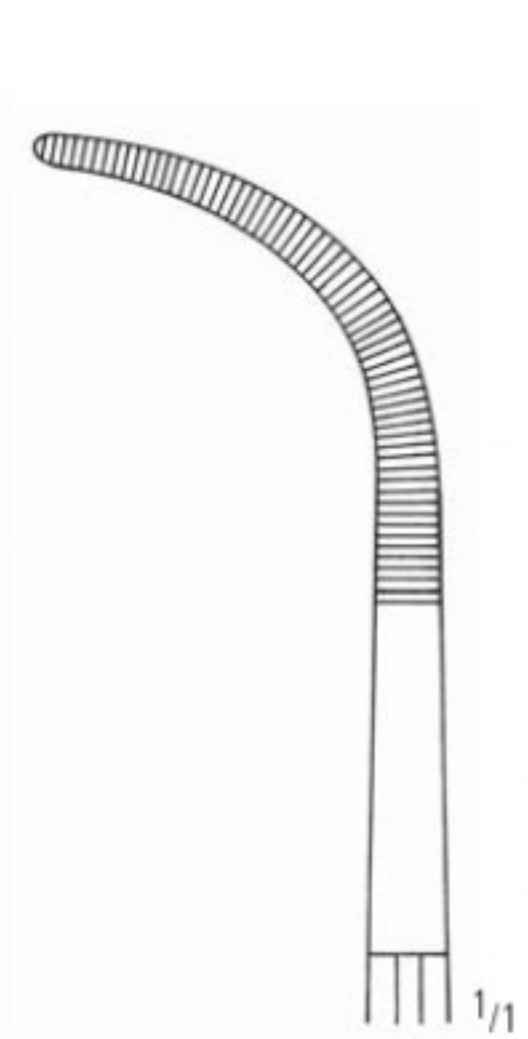

AA 335/04

Präparier- und Ligaturklemmen  
 Dissecting and Ligature Forceps  
 Pinzas para preparaciones y ligaduras  
 Pincès à disséquer et à ligatures  
 Pinze per preparazioni e legature

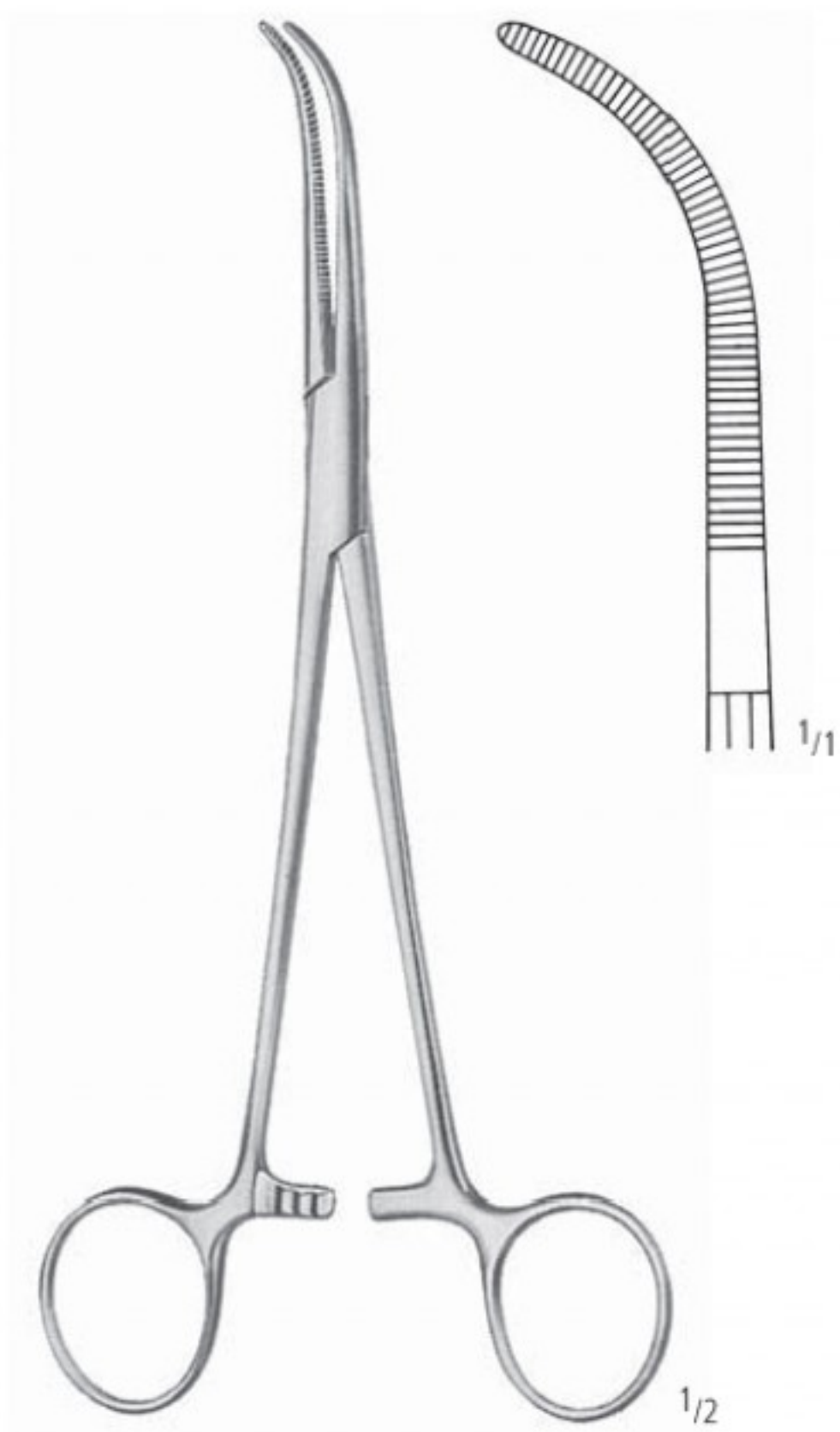

**JOHNS HOPKINS**  
 AA 338/20  
 20,0 cm/8"

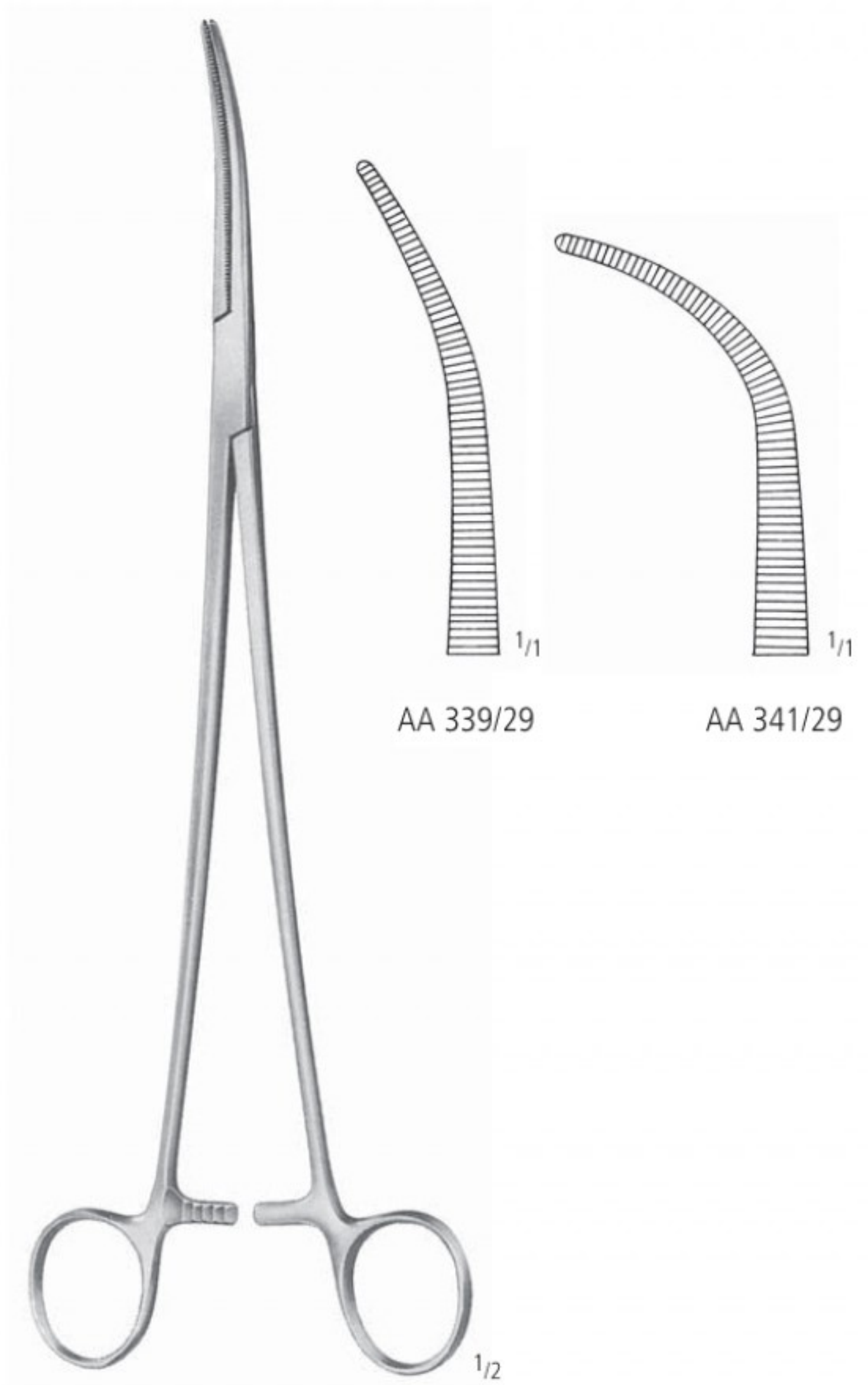

**ZENKER**  
 29,5 cm/11 1/2"



KLEMMEN HEMOSTATS PINZAS HEMOSTATICAS PINCES HEMOSTATIQUES PINZE EMOSTATICHE

Präparier- und Ligaturklemmen  
 Dissecting and Ligature Forceps  
 Pinzas para preparaciones y ligaduras  
 Pincès à disséquer et à ligatures  
 Pinze per preparazioni e legature

AA  
 AB  
 AC  
 AD  
 AE  
 AF  
 AG  
 AH  
 AI  
 AJ  
 AK  
 AL  
 AM  
 AN  
 AO  
 AP  
 AQ  
 AR  
 AS  
 AT  
 AU  
 AV  
 AW  
 AX  
 AY  
 AZ  
 BA  
 BB  
 BC  
 BD  
 BE  
 BF  
 BG  
 BH  
 BI  
 BJ  
 BK  
 BL  
 BM  
 BN  
 BO  
 BP  
 BQ  
 BR  
 BS  
 BT  
 BU  
 BV  
 BW  
 BX  
 BY  
 BZ  
 CA  
 CB  
 CC  
 CD  
 CE  
 CF  
 CG  
 CH  
 CI  
 CJ  
 CK  
 CL  
 CM  
 CN  
 CO  
 CP  
 CQ  
 CR  
 CS  
 CT  
 CU  
 CV  
 CW  
 CX  
 CY  
 CZ  
 DA  
 DB  
 DC  
 DD  
 DE  
 DF  
 DG  
 DH  
 DI  
 DJ  
 DK  
 DL  
 DM  
 DN  
 DO  
 DP  
 DQ  
 DR  
 DS  
 DT  
 DU  
 DV  
 DW  
 DX  
 DY  
 DZ  
 EA  
 EB  
 EC  
 ED  
 EE  
 EF  
 EG  
 EH  
 EI  
 EJ  
 EK  
 EL  
 EM  
 EN  
 EO  
 EP  
 EQ  
 ER  
 ES  
 ET  
 EU  
 EV  
 EW  
 EX  
 EY  
 EZ  
 FA  
 FB  
 FC  
 FD  
 FE  
 FF  
 FG  
 FH  
 FI  
 FJ  
 FK  
 FL  
 FM  
 FN  
 FO  
 FP  
 FQ  
 FR  
 FS  
 FT  
 FU  
 FV  
 FW  
 FX  
 FY  
 FZ  
 GA  
 GB  
 GC  
 GD  
 GE  
 GF  
 GG  
 GH  
 GI  
 GJ  
 GK  
 GL  
 GM  
 GN  
 GO  
 GP  
 GQ  
 GR  
 GS  
 GT  
 GU  
 GV  
 GW  
 GX  
 GY  
 GZ  
 HA  
 HB  
 HC  
 HD  
 HE  
 HF  
 HG  
 HH  
 HI  
 HJ  
 HK  
 HL  
 HM  
 HN  
 HO  
 HP  
 HQ  
 HR  
 HS  
 HT  
 HU  
 HV  
 HW  
 HX  
 HY  
 HZ  
 IA  
 IB  
 IC  
 ID  
 IE  
 IF  
 IG  
 IH  
 II  
 IJ  
 IK  
 IL  
 IM  
 IN  
 IO  
 IP  
 IQ  
 IR  
 IS  
 IT  
 IU  
 IV  
 IW  
 IX  
 IY  
 IZ  
 JA  
 JB  
 JC  
 JD  
 JE  
 JF  
 JG  
 JH  
 JI  
 JJ  
 JK  
 JL  
 JM  
 JN  
 JO  
 JP  
 JQ  
 JR  
 JS  
 JT  
 JU  
 JZ  
 KA  
 KB  
 KC  
 KD  
 KE  
 KF  
 KG  
 KH  
 KI  
 KJ  
 KK  
 KL  
 KM  
 KN  
 KO  
 KP  
 KQ  
 KR  
 KS  
 KT  
 KU  
 KV  
 KW  
 KX  
 KY  
 KZ  
 LA  
 LB  
 LC  
 LD  
 LE  
 LF  
 LG  
 LH  
 LI  
 LJ  
 LK  
 LL  
 LM  
 LN  
 LO  
 LP  
 LQ  
 LR  
 LS  
 LT  
 LU  
 LV  
 LW  
 LX  
 LY  
 LZ  
 MA  
 MB  
 MC  
 MD  
 ME  
 MF  
 MG  
 MH  
 MI  
 MJ  
 MK  
 ML  
 MM  
 MN  
 MO  
 MP  
 MQ  
 MR  
 MS  
 MT  
 MU  
 MV  
 MW  
 MX  
 MY  
 MZ  
 NA  
 NB  
 NC  
 ND  
 NE  
 NF  
 NG  
 NH  
 NI  
 NJ  
 NK  
 NL  
 NM  
 NN  
 NO  
 NP  
 NQ  
 NR  
 NS  
 NT  
 NU  
 NV  
 NW  
 NX  
 NY  
 NZ  
 OA  
 OB  
 OC  
 OD  
 OE  
 OF  
 OG  
 OH  
 OI  
 OJ  
 OK  
 OL  
 OM  
 ON  
 OO  
 OP  
 OQ  
 OR  
 OS  
 OT  
 OU  
 OV  
 OW  
 OX  
 OY  
 OZ  
 PA  
 PB  
 PC  
 PD  
 PE  
 PF  
 PG  
 PH  
 PI  
 PJ  
 PK  
 PL  
 PM  
 PN  
 PO  
 PP  
 PQ  
 PR  
 PS  
 PT  
 PU  
 PV  
 PW  
 PX  
 PY  
 PZ  
 QA  
 QB  
 QC  
 QD  
 QE  
 QF  
 QG  
 QH  
 QI  
 QJ  
 QK  
 QL  
 QM  
 QN  
 QO  
 QP  
 QQ  
 QR  
 QS  
 QT  
 QU  
 QV  
 QW  
 QX  
 QY  
 QZ  
 RA  
 RB  
 RC  
 RD  
 RE  
 RF  
 RG  
 RH  
 RI  
 RJ  
 RK  
 RL  
 RM  
 RN  
 RO  
 RP  
 RQ  
 RR  
 RS  
 RT  
 RU  
 RV  
 RW  
 RX  
 RY  
 RZ  
 SA  
 SB  
 SC  
 SD  
 SE  
 SF  
 SG  
 SH  
 SI  
 SJ  
 SK  
 SL  
 SM  
 SN  
 SO  
 SP  
 SQ  
 SR  
 SS  
 ST  
 SU  
 SV  
 SW  
 SX  
 SY  
 SZ  
 TA  
 TB  
 TC  
 TD  
 TE  
 TF  
 TG  
 TH  
 TI  
 TJ  
 TK  
 TL  
 TM  
 TN  
 TO  
 TP  
 TQ  
 TR  
 TS  
 TT  
 TU  
 TV  
 TW  
 TX  
 TY  
 TZ  
 UA  
 UB  
 UC  
 UD  
 UE  
 UF  
 UG  
 UH  
 UI  
 UJ  
 UK  
 UL  
 UM  
 UN  
 UO  
 UP  
 UQ  
 UR  
 US  
 UT  
 UZ  
 VA  
 VB  
 VC  
 VD  
 VE  
 VF  
 VG  
 VH  
 VI  
 VJ  
 VK  
 VL  
 VM  
 VN  
 VO  
 VP  
 VQ  
 VR  
 VS  
 VT  
 VZ  
 WA  
 WB  
 WC  
 WD  
 WE  
 WF  
 WG  
 WH  
 WI  
 WJ  
 WK  
 WL  
 WM  
 WN  
 WO  
 WP  
 WQ  
 WR  
 WS  
 WT  
 WZ  
 XA  
 XB  
 XC  
 XD  
 XE  
 XF  
 XG  
 XH  
 XI  
 XJ  
 XK  
 XL  
 XM  
 XN  
 XO  
 XP  
 XQ  
 XR  
 XS  
 XT  
 XU  
 XV  
 XW  
 XX  
 XY  
 XZ  
 YA  
 YB  
 YC  
 YD  
 YE  
 YF  
 YG  
 YH  
 YI  
 YJ  
 YK  
 YL  
 YM  
 YN  
 YO  
 YP  
 YQ  
 YR  
 YS  
 YT  
 YZ  
 ZA  
 ZB  
 ZC  
 ZD  
 ZE  
 ZF  
 ZG  
 ZH  
 ZI  
 ZJ  
 ZK  
 ZL  
 ZM  
 ZN  
 ZO  
 ZP  
 ZQ  
 ZR  
 ZS  
 ZT  
 ZU  
 ZV  
 ZW  
 ZX  
 ZY  
 ZZ

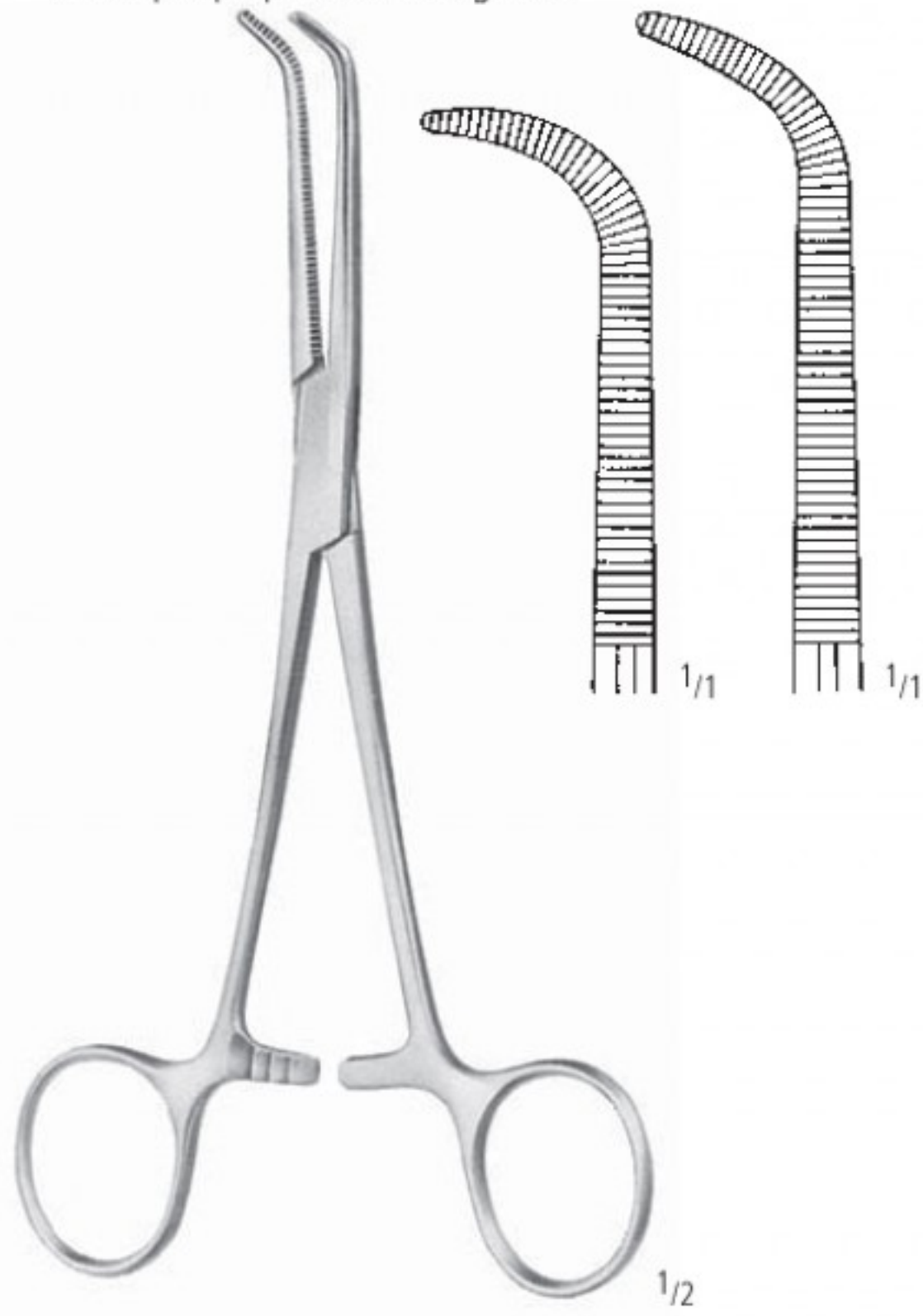

**MIXTER**  
 15,5 cm/6"  
 19,0 cm/7½"

AA 345/15  
 AA 345/19

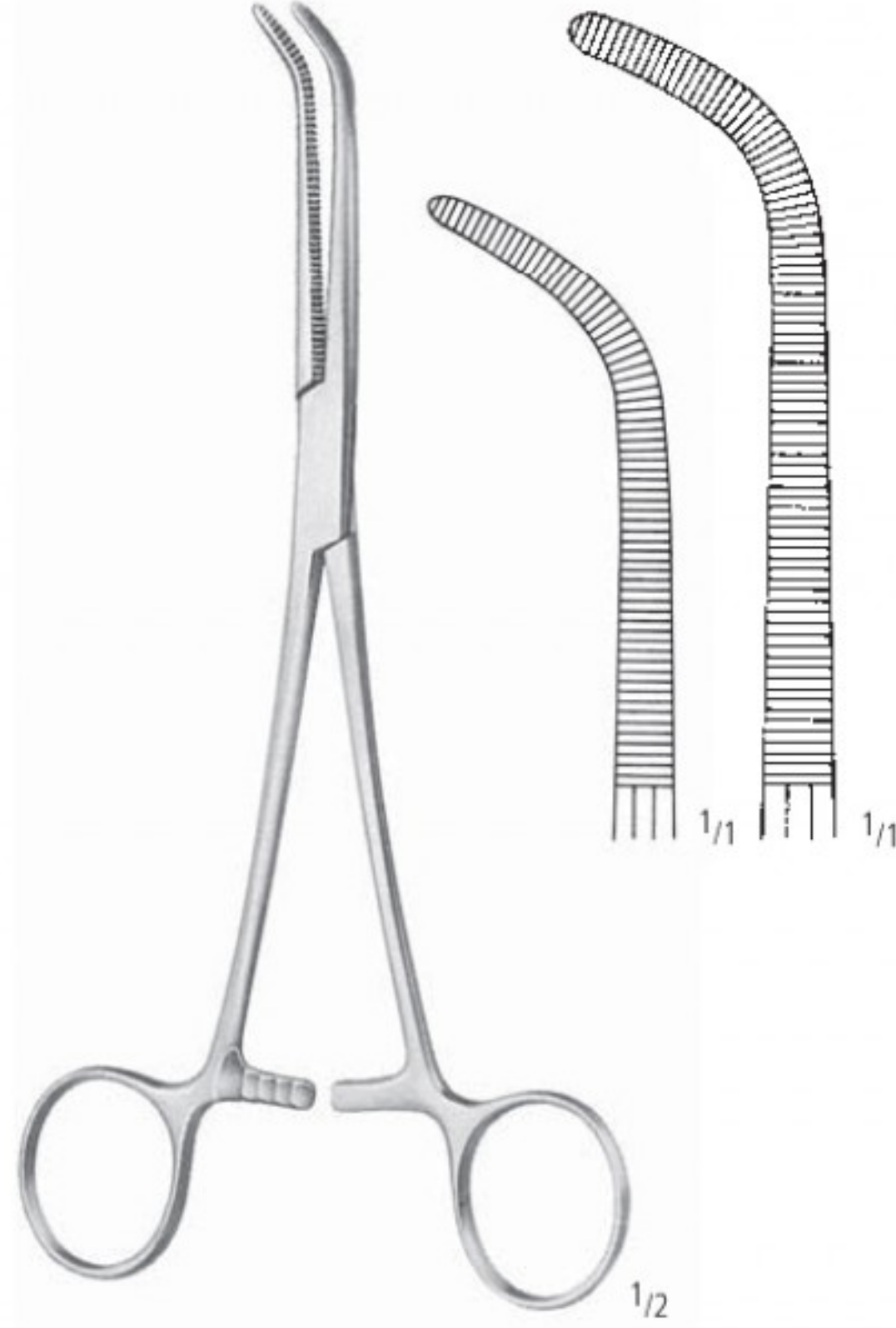

**MIXTER-O'SHAUGNESSY**  
 15,5 cm/6"  
 19,0 cm/7½"

AA 347/15  
 AA 347/19

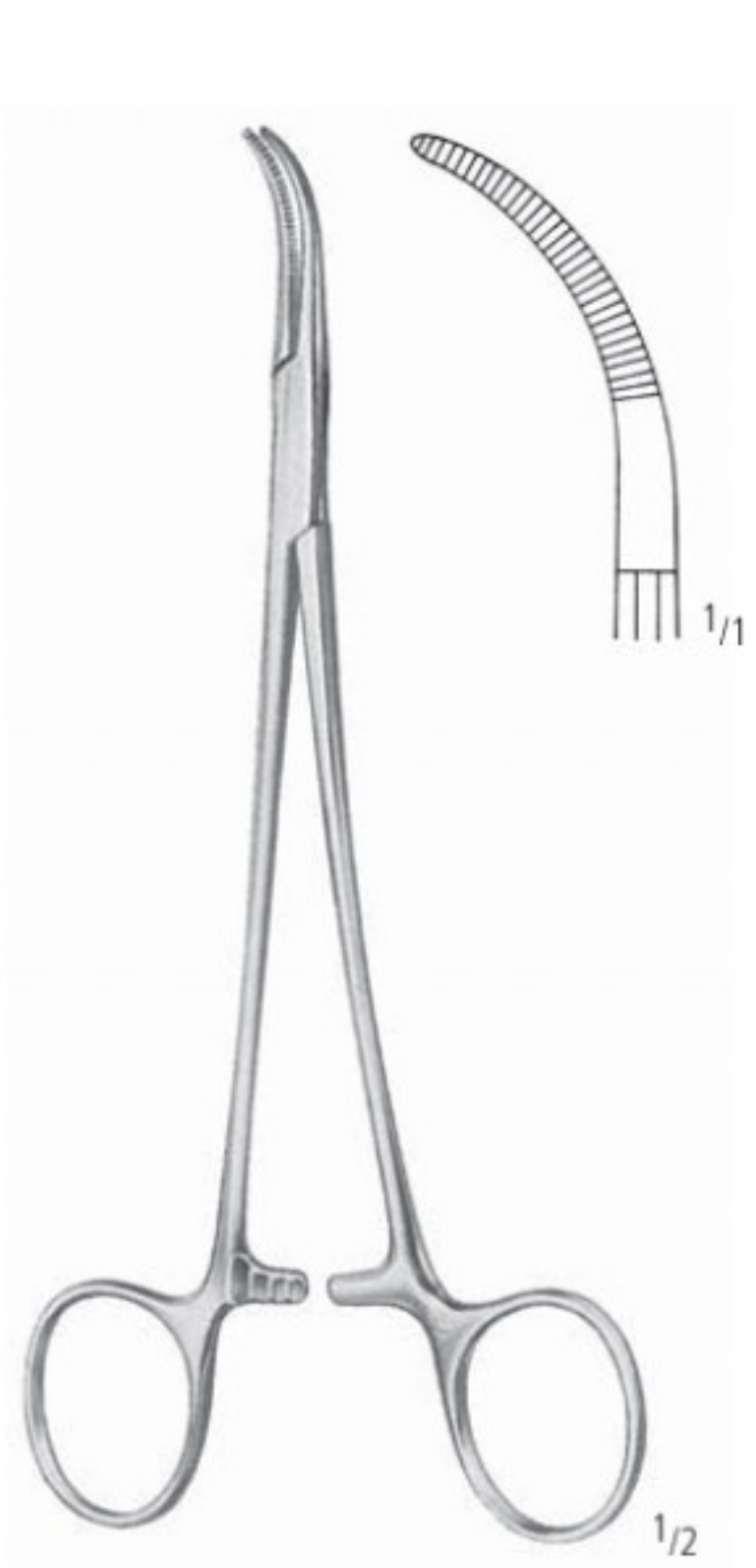

**BABY-MIXTER**  
 18,0 cm/7"

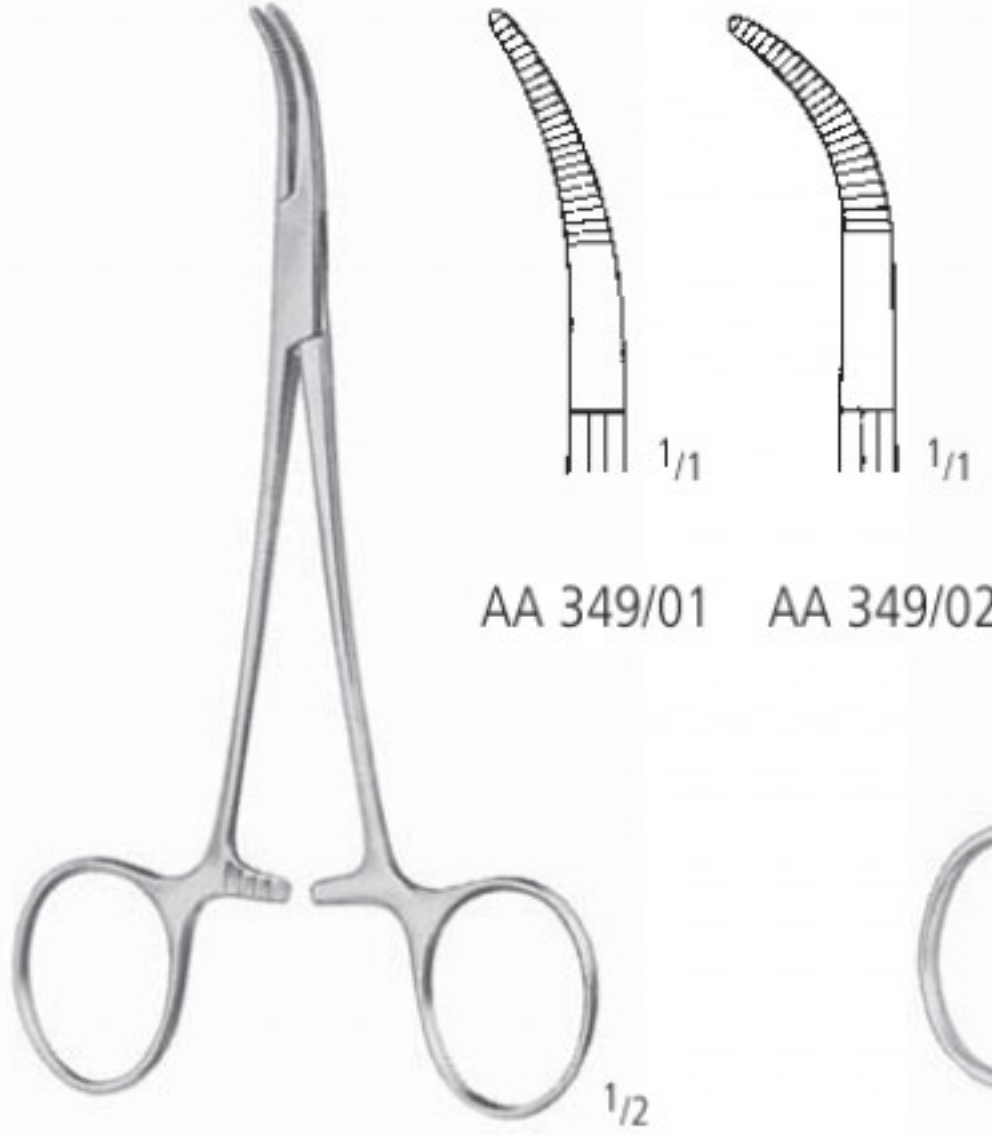

**BABY-MIXTER**  
 14,0 cm/5½"

AA 349/01 AA 349/02



**MIXTER**



Fig. 1  
 AA 353/22  
 22,0 cm/8¾"

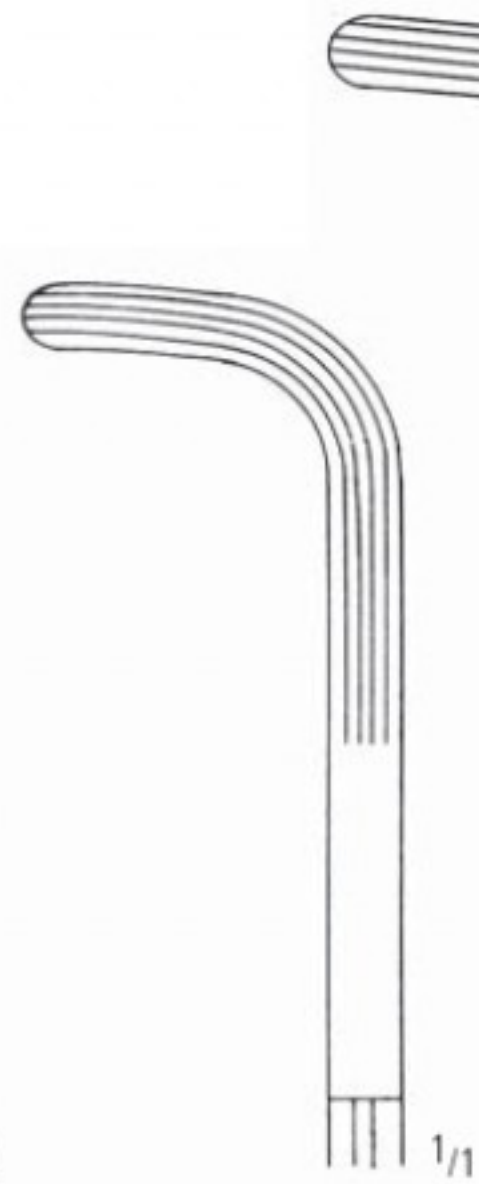

Fig. 2  
 AA 353/25  
 25,0 cm/10"

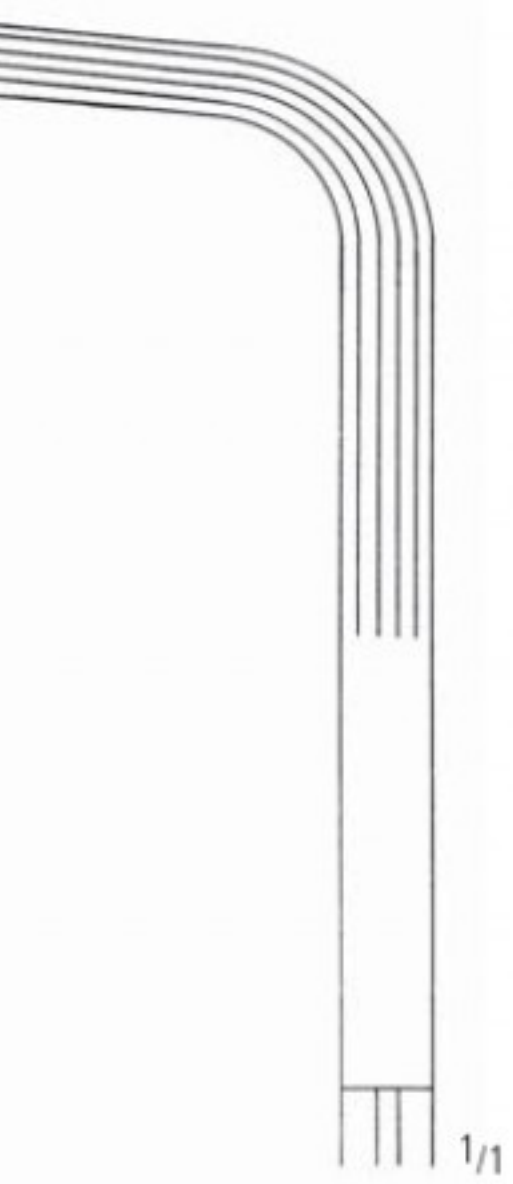

Fig. 3  
 AA 353/28  
 28,0 cm/11"

Präparier- und Ligaturklemmen  
 Dissecting and Ligature Forceps  
 Pinzas para preparaciones y ligaduras  
 Pincès à disséquer et à ligatures  
 Pinze per preparazioni e legature



**MIXTER**  
 AA 355/23  
 23,0 cm/9"



**BRIDGE**  
 28,0 cm/11"



**LAWRENCE**  
 AA 361/28  
 28,0 cm/11"



KLEMMEN HEMOSTATS PINZAS HEMOSTATICAS PINCES HEMOSTATIQUES PINZE EMOSTATICHE

Präparier- und Ligaturklemmen  
 Dissecting and Ligature Forceps  
 Pinzas para preparaciones y ligaduras  
 Pincés à disséquer et à ligatures  
 Pinze per preparazioni e legature

AA

AB

AC

AD

AE

AF

AK

AL

AM

AO

AP

AR

KA

KB

KC

KD

KU

KY



**KANTROWITZ**

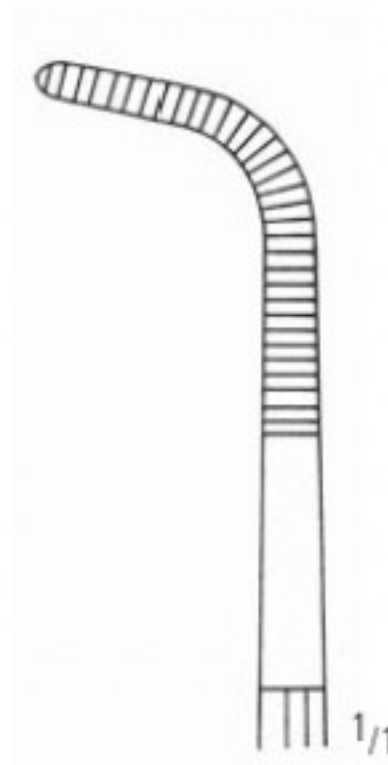

AA 363/20  
20,0 cm/8"

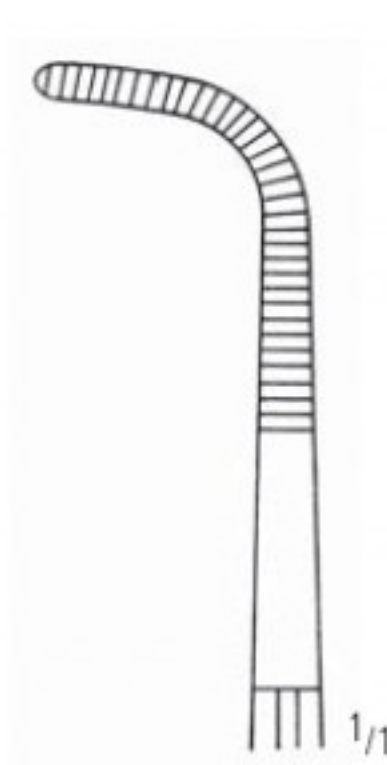

AA 363/24  
24,0 cm/9 1/2"

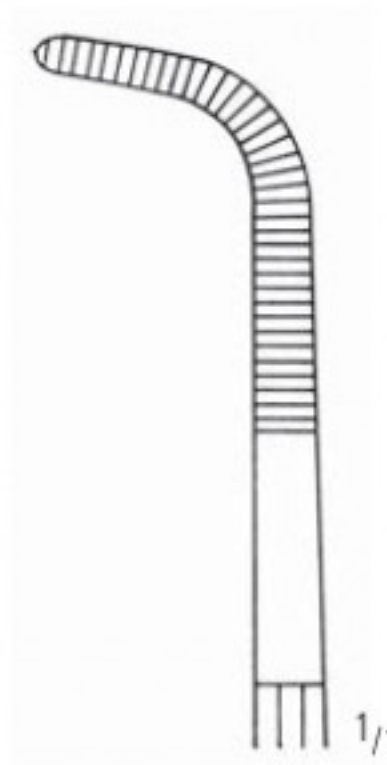

AA 363/28  
28,0 cm/11"



**GEMINI**



AA 365/14  
14,0 cm/5 1/2"

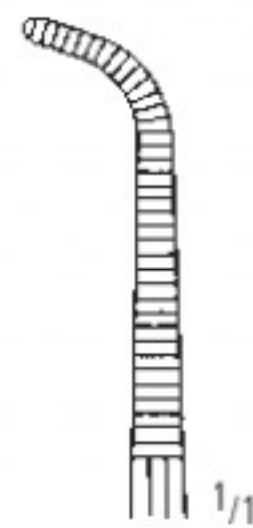

AA 365/18  
18,0 cm/7"

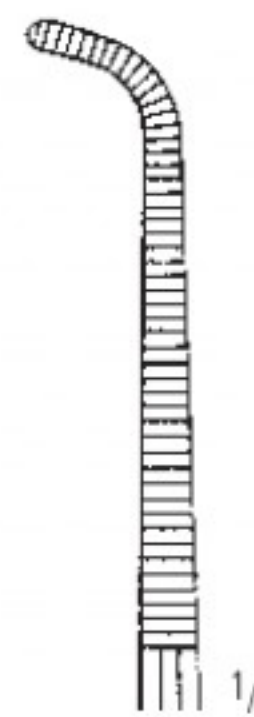

AA 365/22  
22,0 cm/8 3/4"

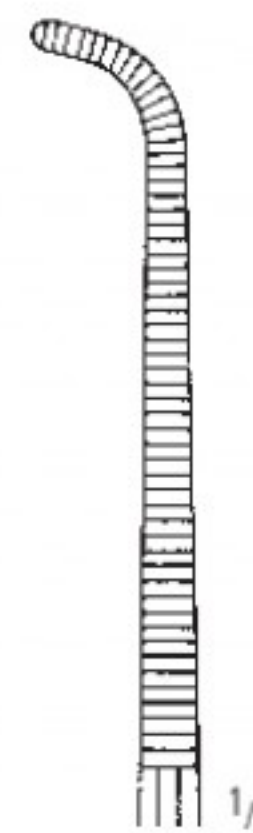

AA 365/25  
25,0 cm/10"

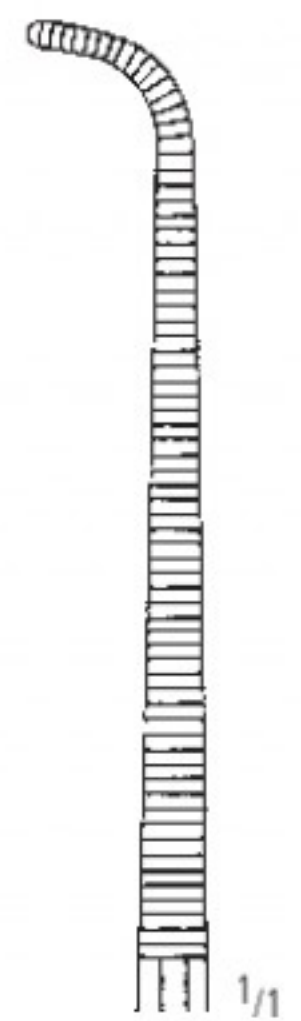

AA 365/28  
28,0 cm/11"

Präparier- und Ligaturklemmen  
 Dissecting and Ligature Forceps  
 Pinzas para preparaciones y ligaduras  
 Pincès à disséquer et à ligatures  
 Pinze per preparazioni e legature

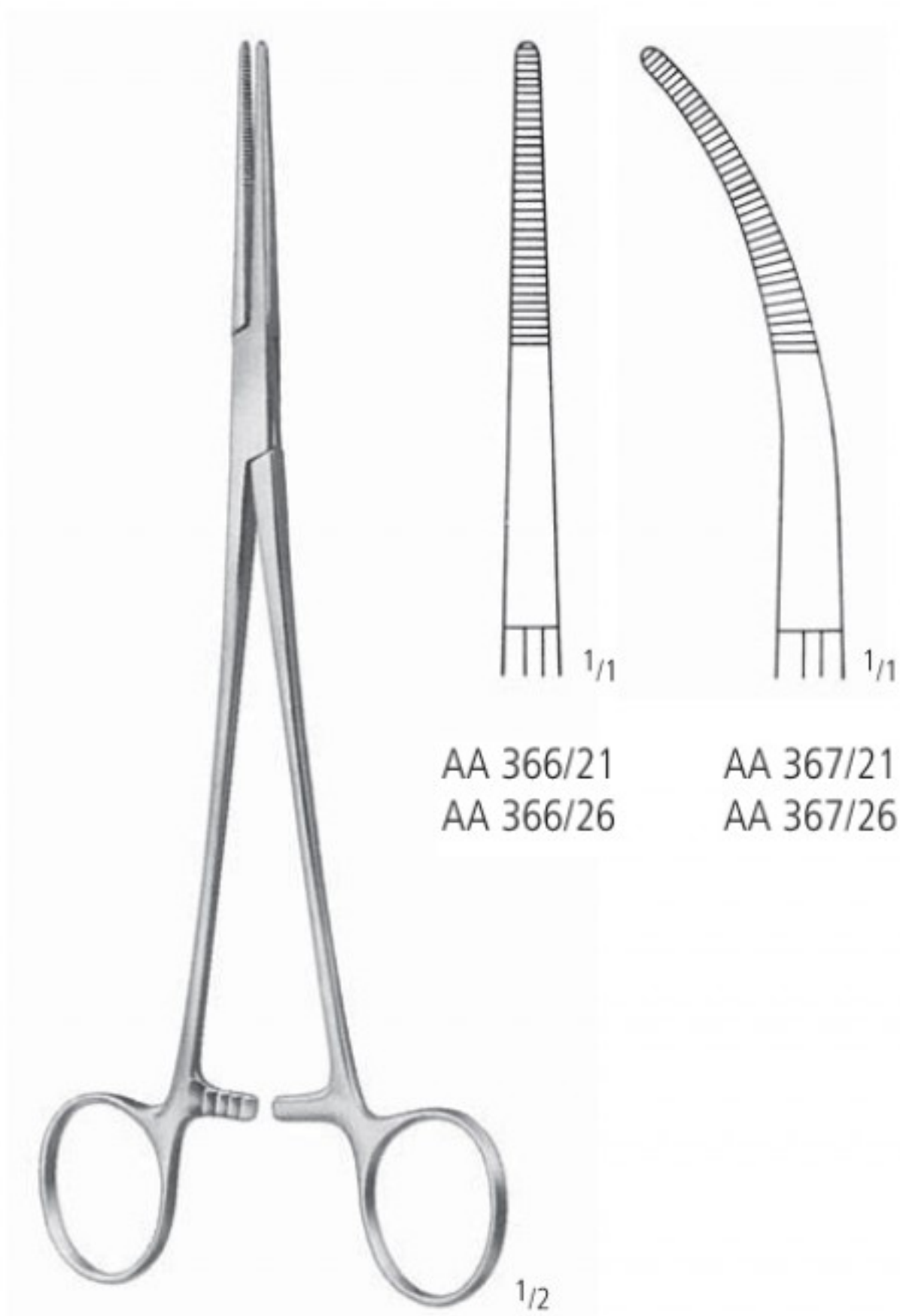

AA 366/21  
 AA 366/26

AA 367/21  
 AA 367/26

**TOENNIS**  
 21,0 cm/8<sup>1</sup>/<sub>4</sub>"  
 26,0 cm/10<sup>1</sup>/<sub>2</sub>"

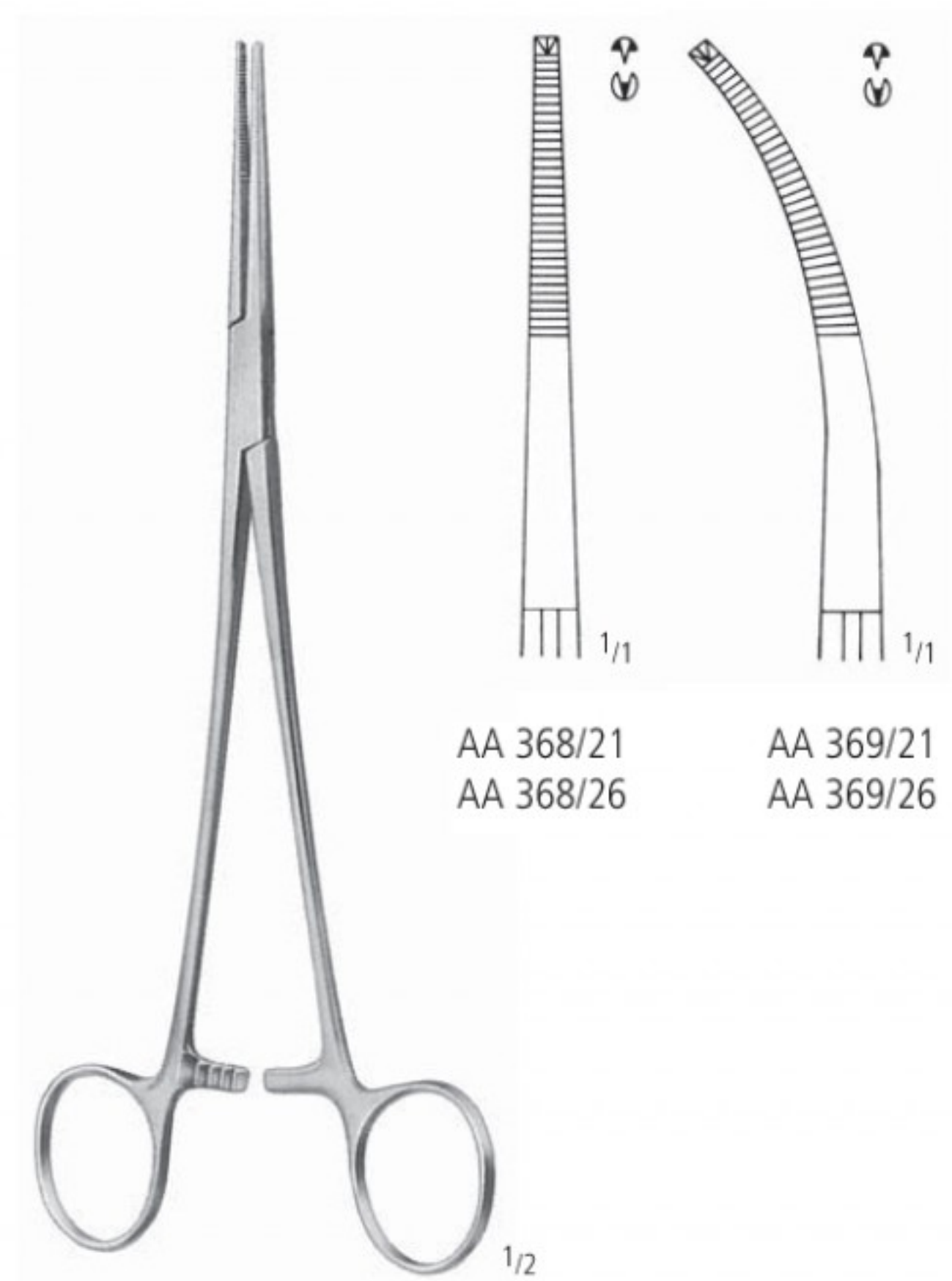

AA 368/21  
 AA 368/26

AA 369/21  
 AA 369/26

**TOENNIS 1:2**  
 21,0 cm/8<sup>1</sup>/<sub>4</sub>"  
 26,0 cm/10<sup>1</sup>/<sub>2</sub>"



KLEMMEN HEMOSTATS PINZAS HEMOSTATICAS PINCES HEMOSTATIQUES PINZE EMOSTATICHE

Gallenkanal- und Nierenstiellklemmen  
 Gall Duct and Kidney Pedicle Clamp Forceps  
 Pinzas-clamps para conducto biliar y pedúnculos renales  
 Pincers-clamps pour voies biliaires et pédicules rénaux  
 Pinze per vie biliari e peduncoli renali

AA

AB

AC

AD

AE

AF

AK

AL

AM

AO

AP

AR

KA

KB

KC

KD

KU

KY

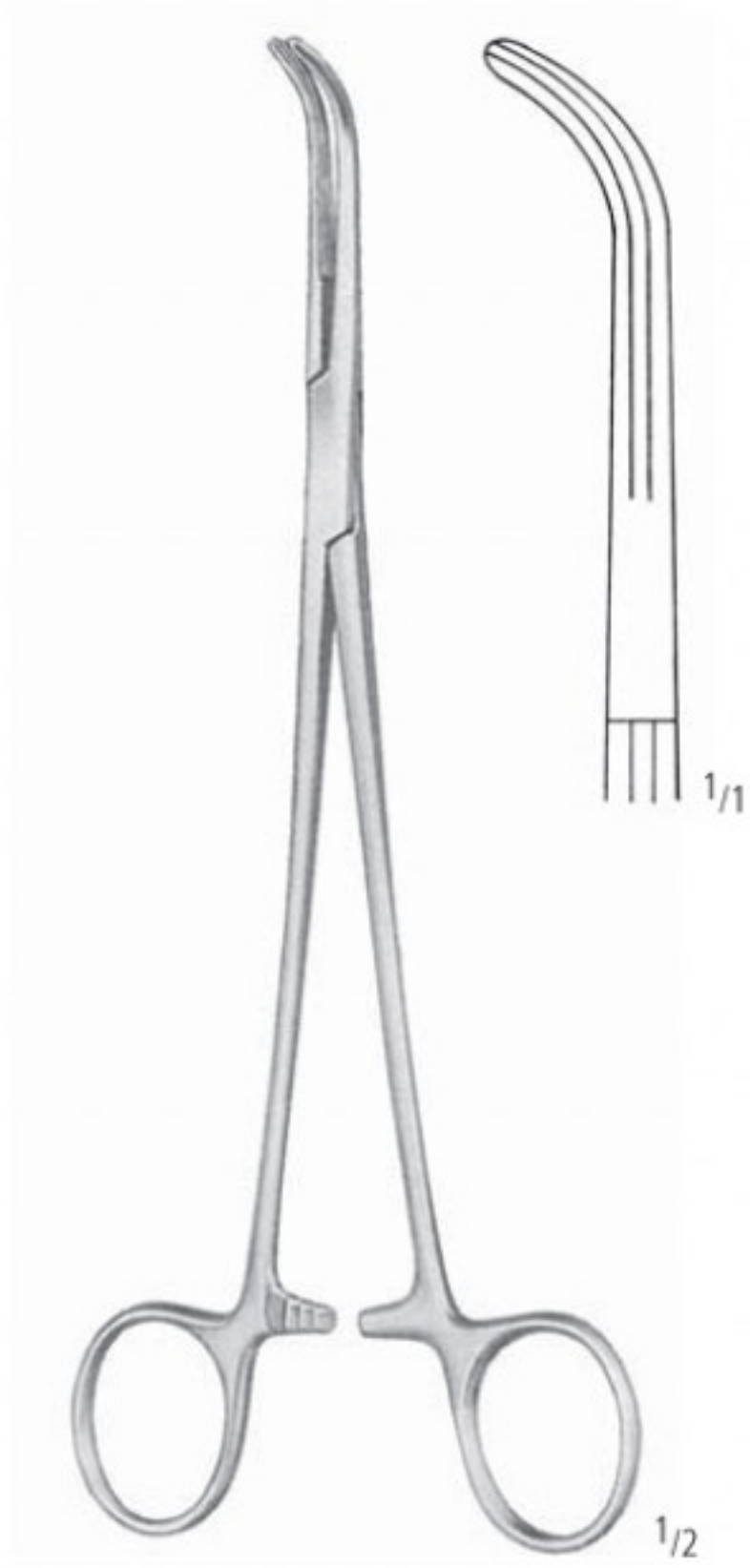

**LAHEY**  
 AA 401/19  
 19,0 cm/7 1/2"

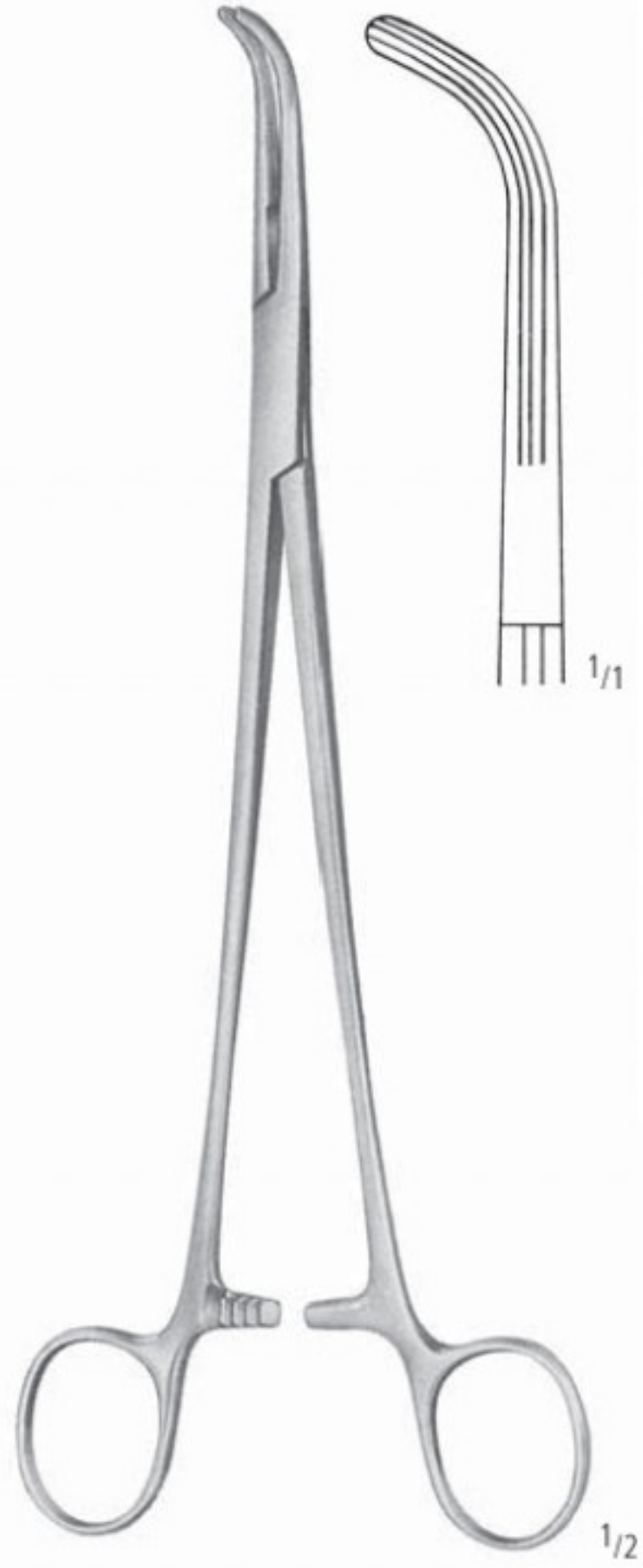

**LAHEY**  
 AA 401/23  
 23,0 cm/9"



**LOWER**  
 AA 403/18  
 18,0 cm/7"

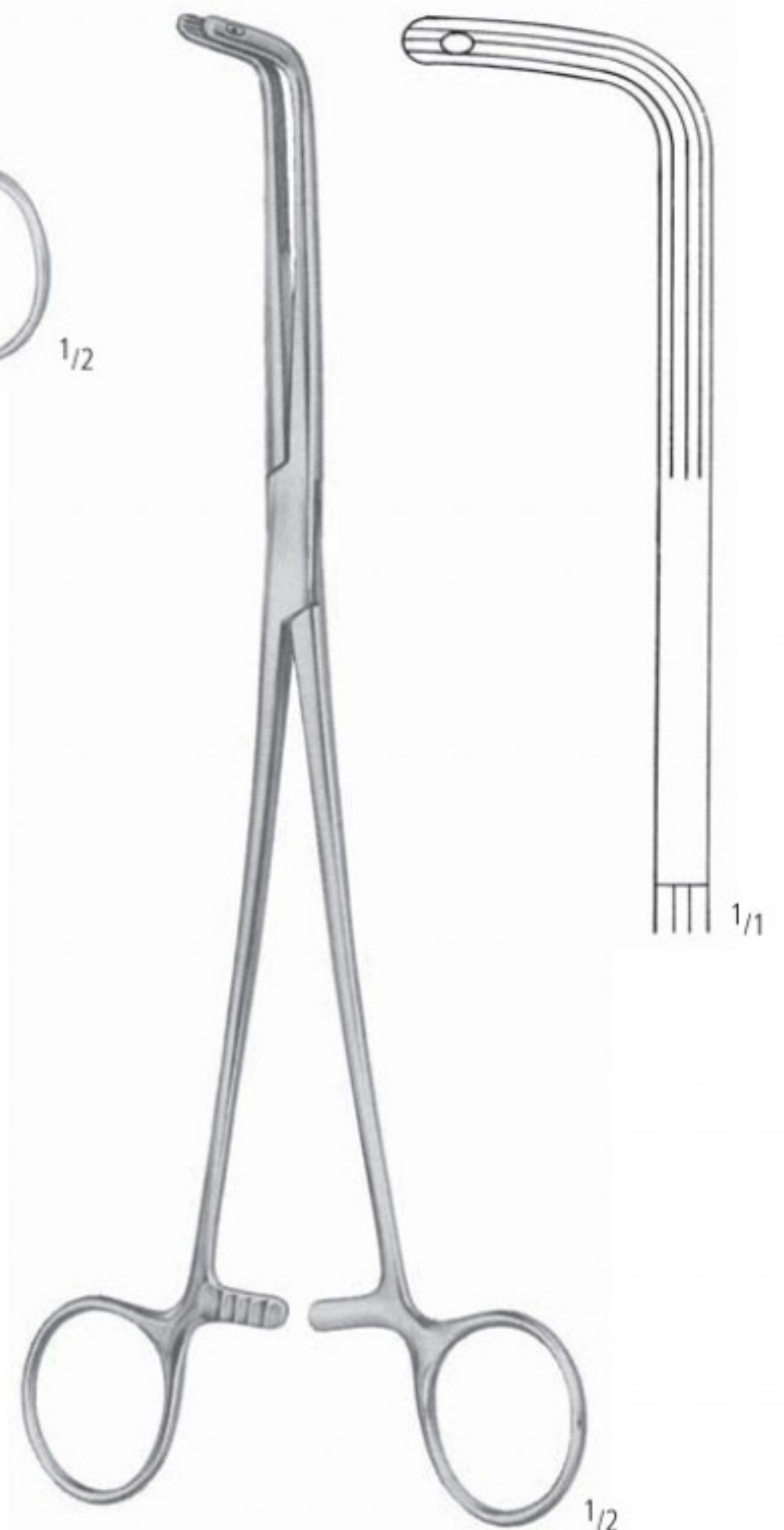

**FINOCCHIETTO**  
 AA 405/24  
 24,0 cm/9 1/2"

Nierenstielklemmen  
 Kidney Pedicle Clamp Forceps  
 Pinzas-clamps para pedúnculos renales  
 Pincas-clamps pour pédicules rénaux  
 Pinze per peduncoli renali

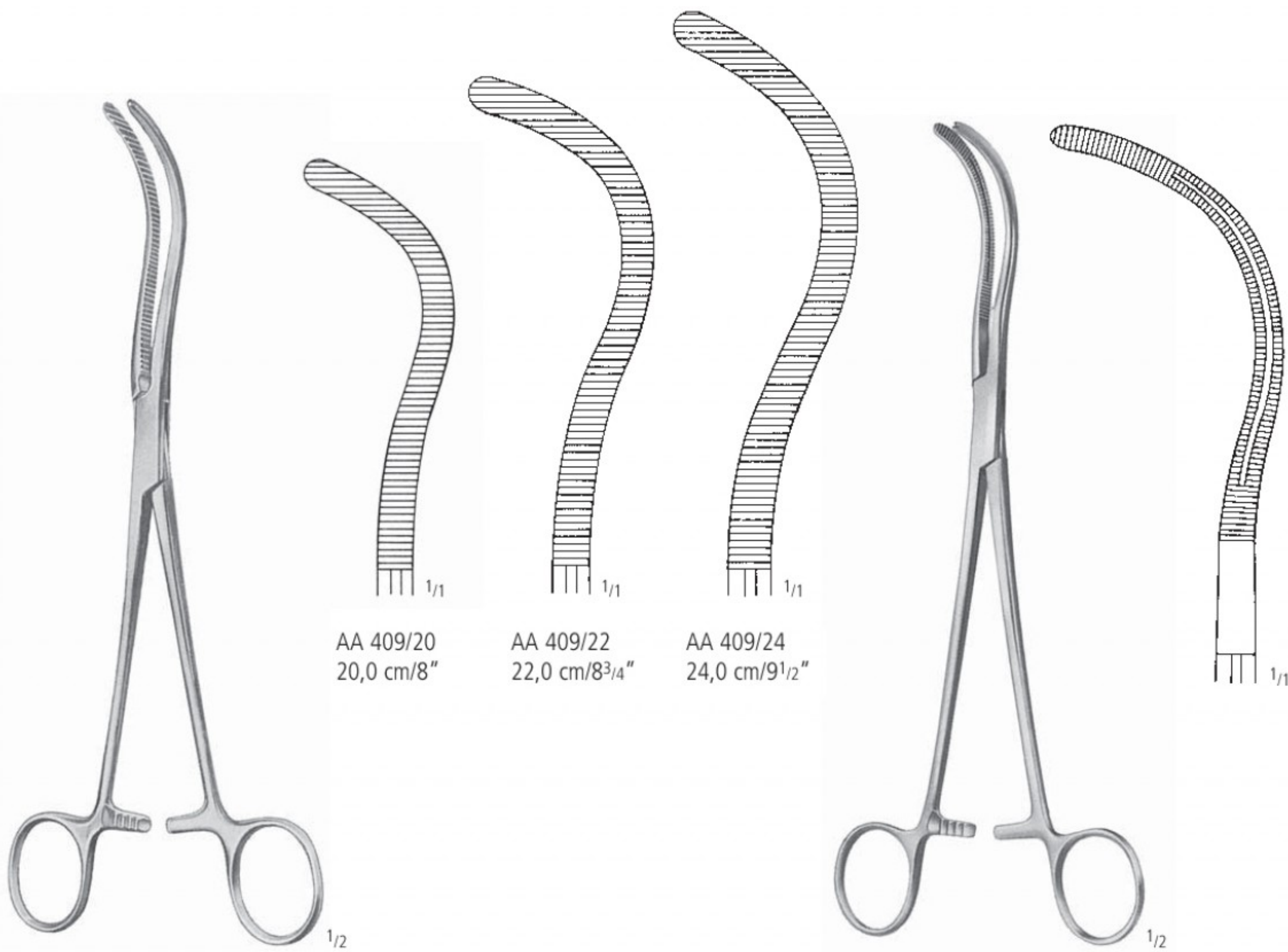

**GUYON**

AA 409/20  
 20,0 cm/8"

AA 409/22  
 22,0 cm/8<sup>3</sup>/<sub>4</sub>"

AA 409/24  
 24,0 cm/9<sup>1</sup>/<sub>2</sub>"

**STILLE**  
 AA 411/23  
 23,0 cm/9"



Nierenstielklemmen  
 Kidney Pedicle Clamp Forceps  
 Pinzas-clamps para pedúnculos renales  
 Pincers-clamps pour pédicules rénaux  
 Pinze per peduncoli renali

AA

AB

AC

AD

AE

AF

AK

AL

AM

AO

AP

AR

KA

KB

KC

KD

KU

KY

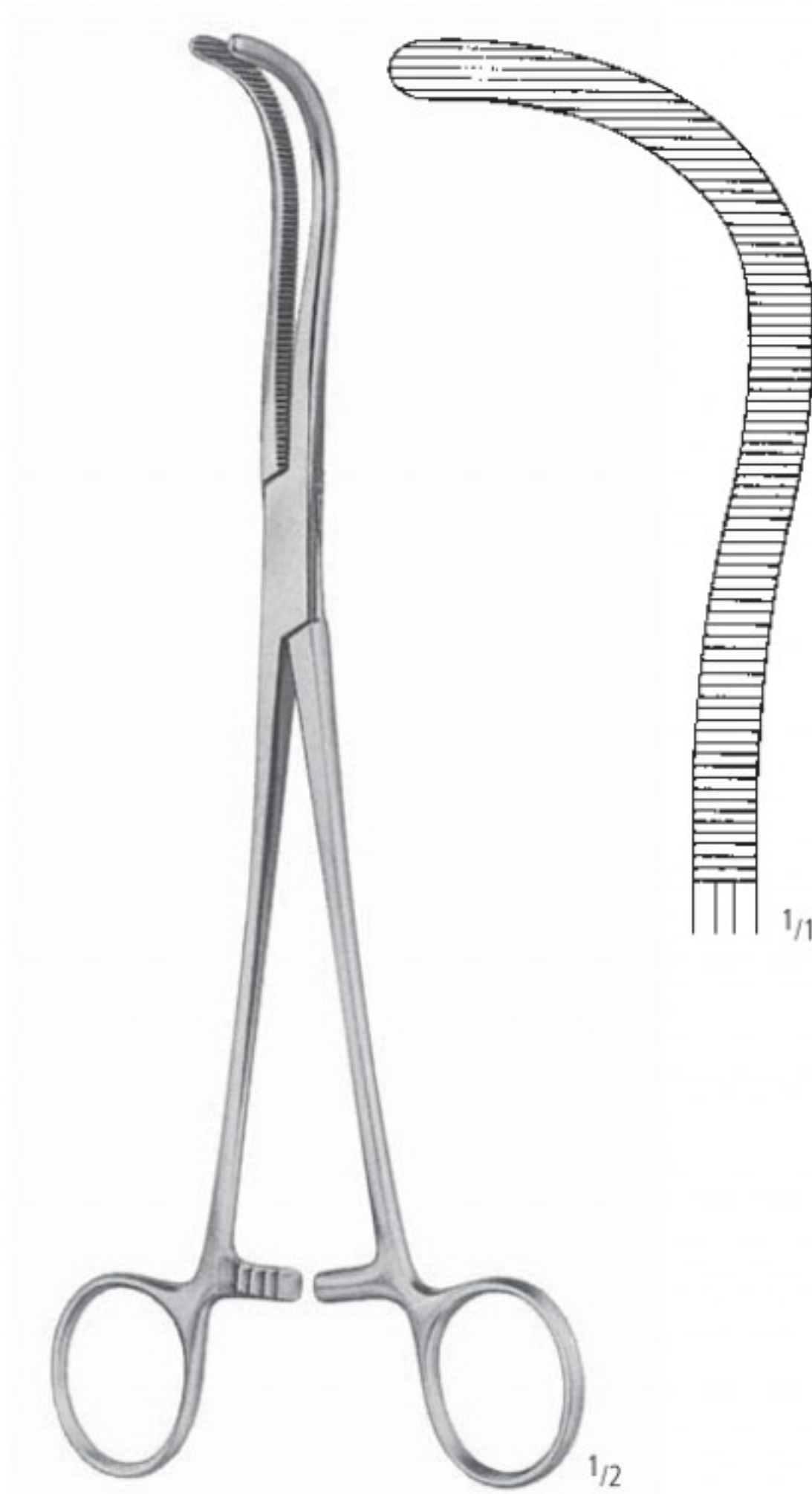

**GUYON**  
 AA 413/23  
 23,0 cm/9"

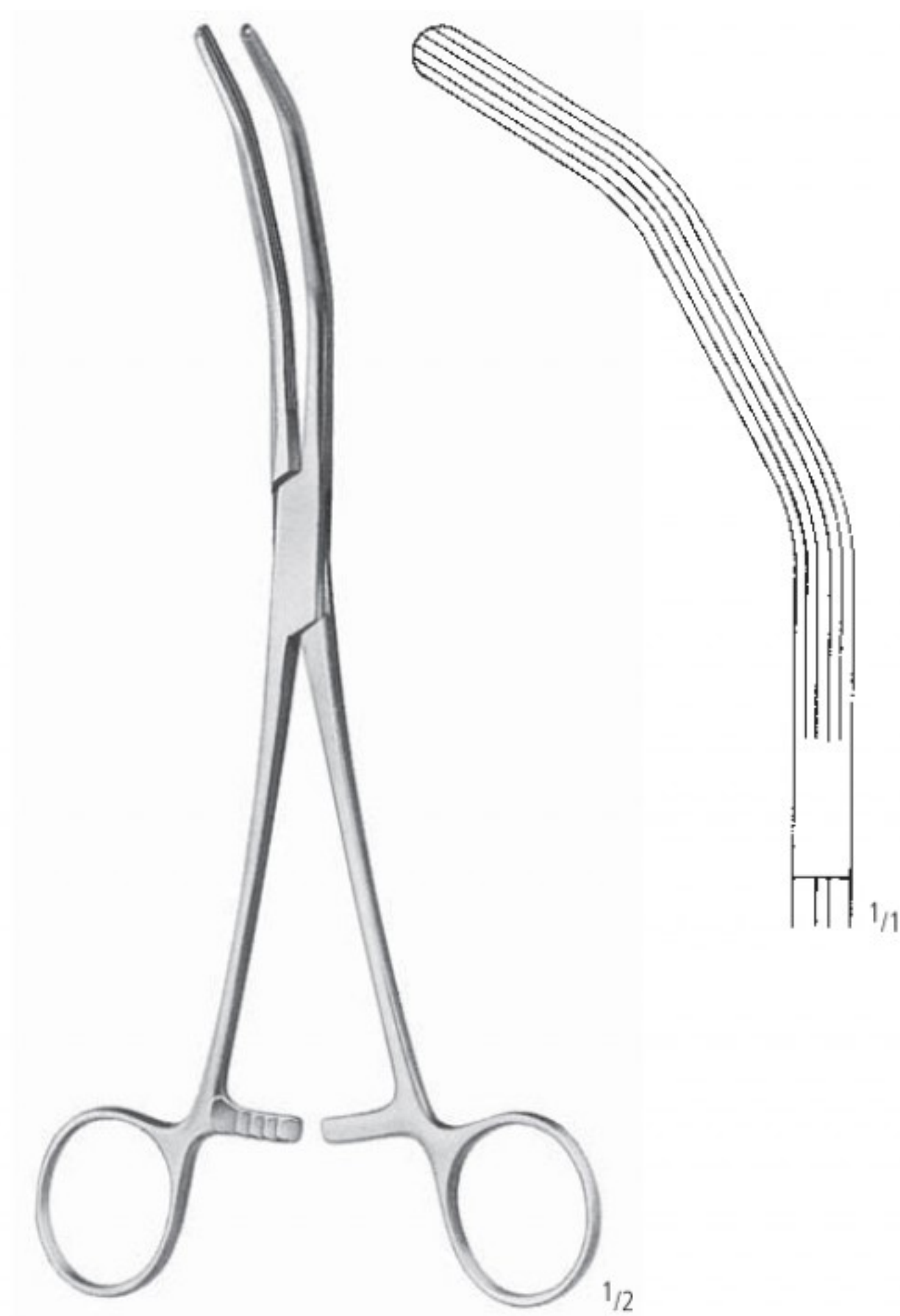

**HERRICK**  
 AA 417/23  
 23,0 cm/9"

Gallenkanalklemmen  
 Gall Duct Forceps  
 Pinzas-clamps para conducto biliar  
 Pincers-clamps pour voies biliaires  
 Pinze per vie biliari

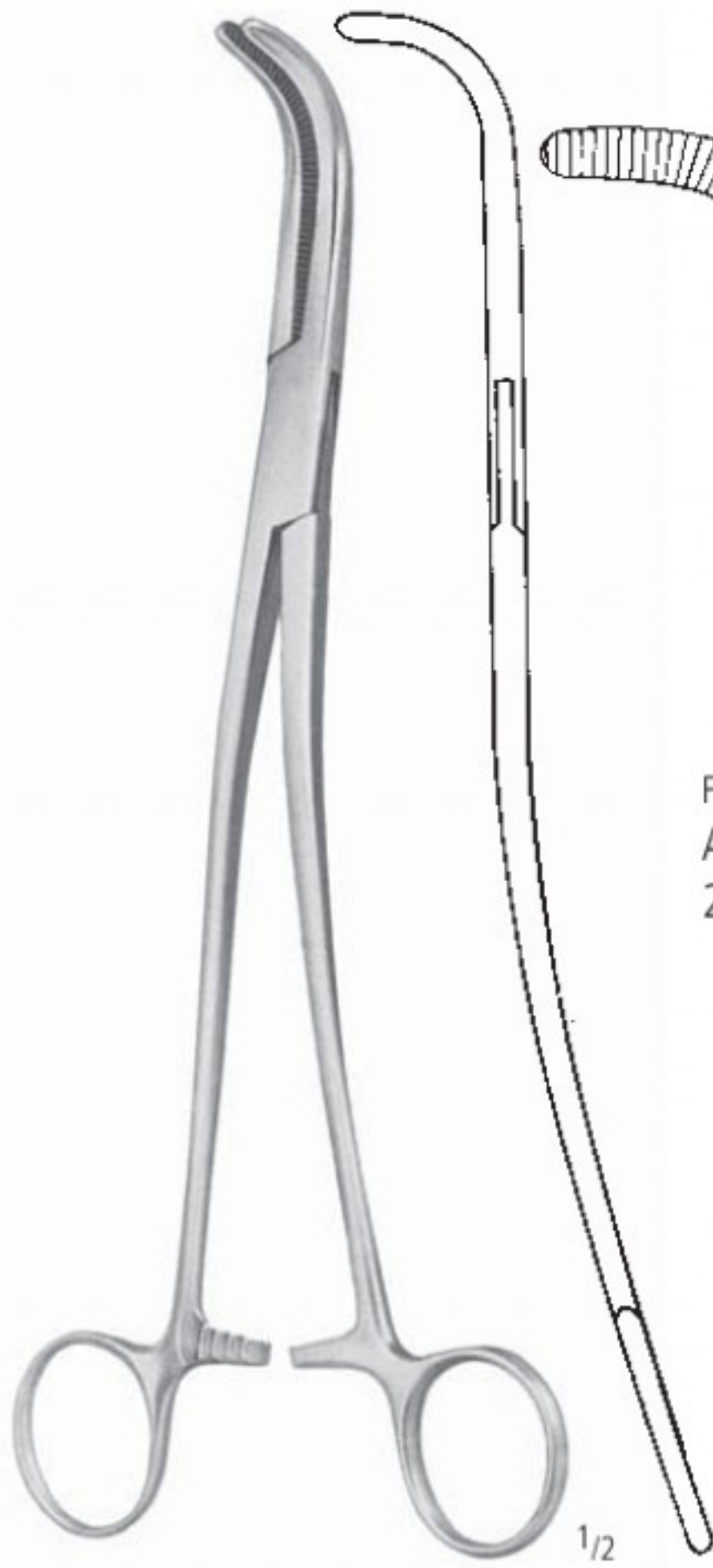

GRAY

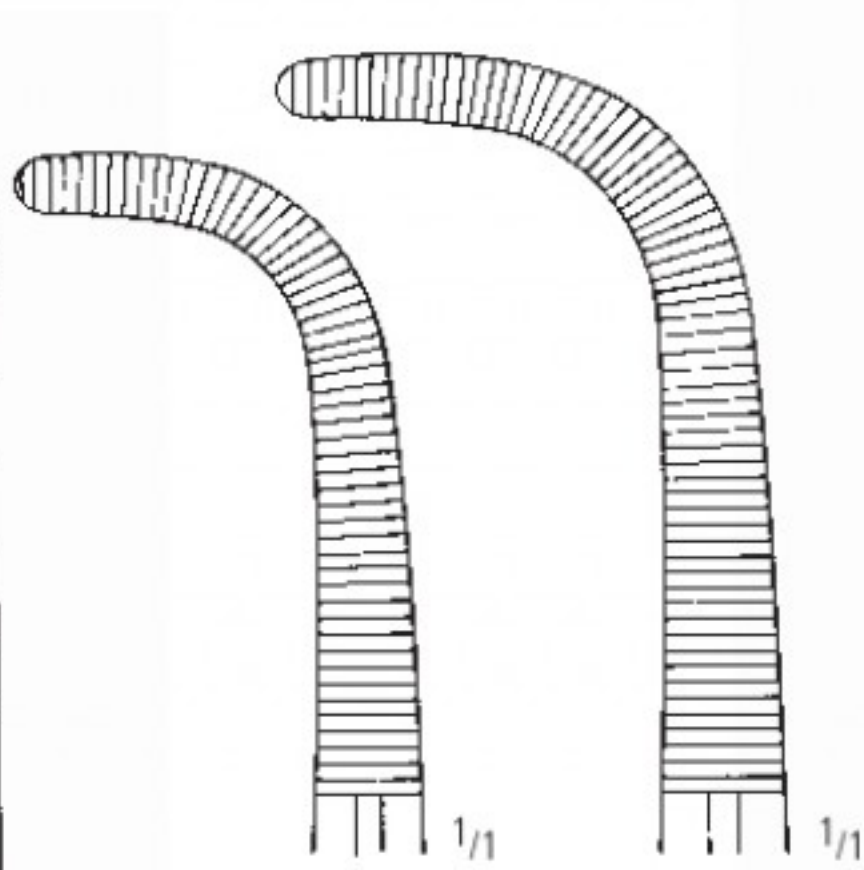
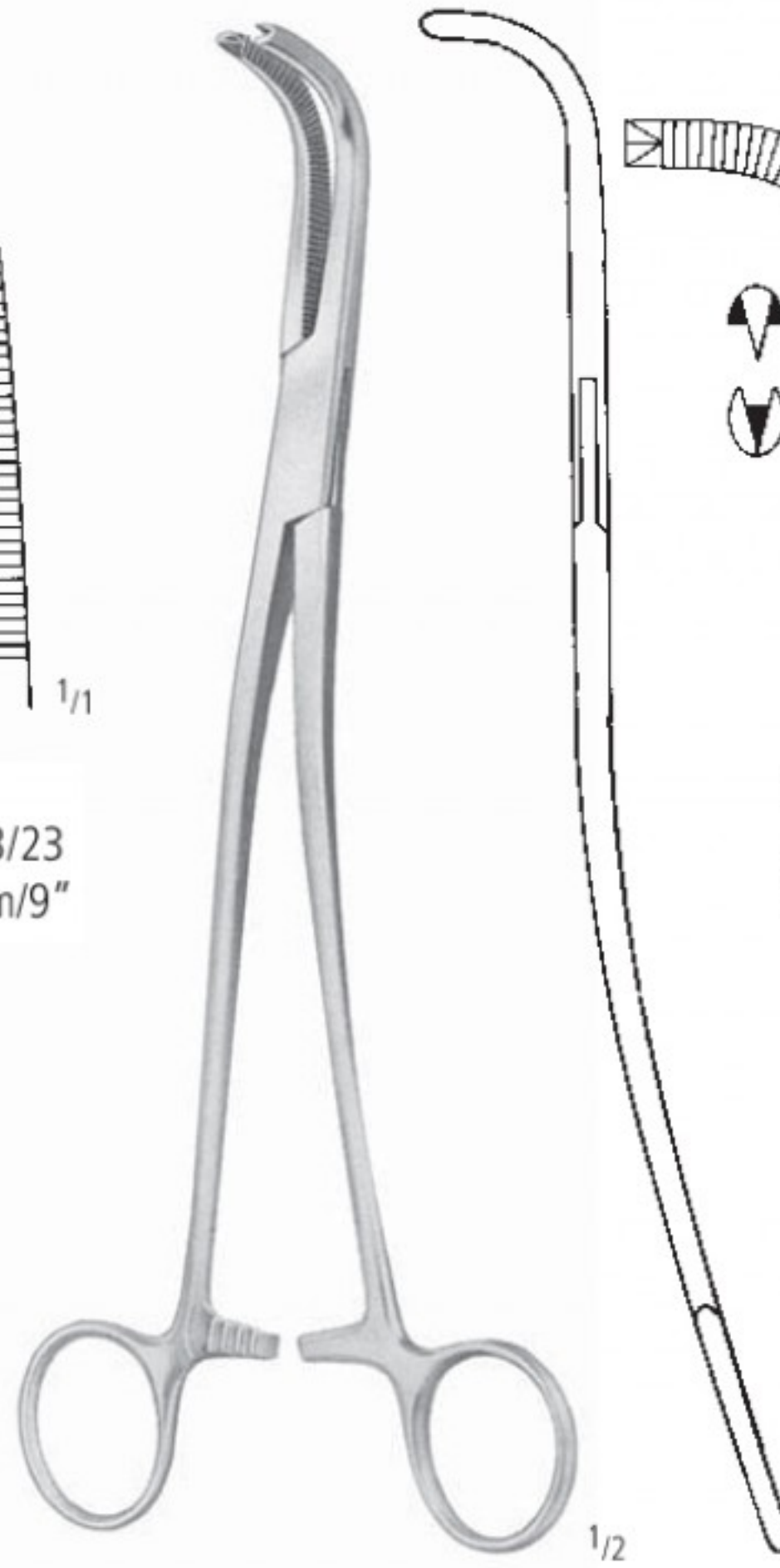

Fig. 1  
 AA 423/22  
 22,0 cm/8<sup>3</sup>/<sub>4</sub>"

Fig. 2  
 AA 423/23  
 23,0 cm/9"



GRAY 1:2

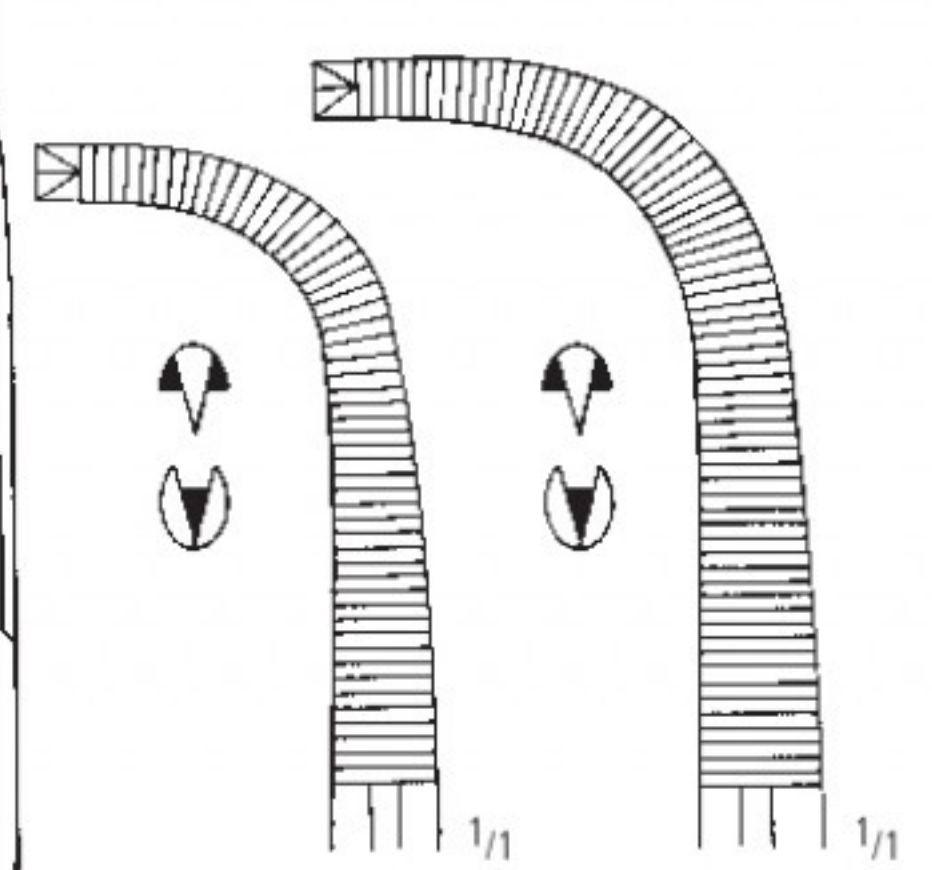

Fig. 1  
 AA 425/22  
 22,0 cm/8<sup>3</sup>/<sub>4</sub>"

Fig. 2  
 AA 425/23  
 23,0 cm/9"



DESJARDINS  
 AA 429/21  
 21,0 cm/8<sup>1</sup>/<sub>4</sub>"

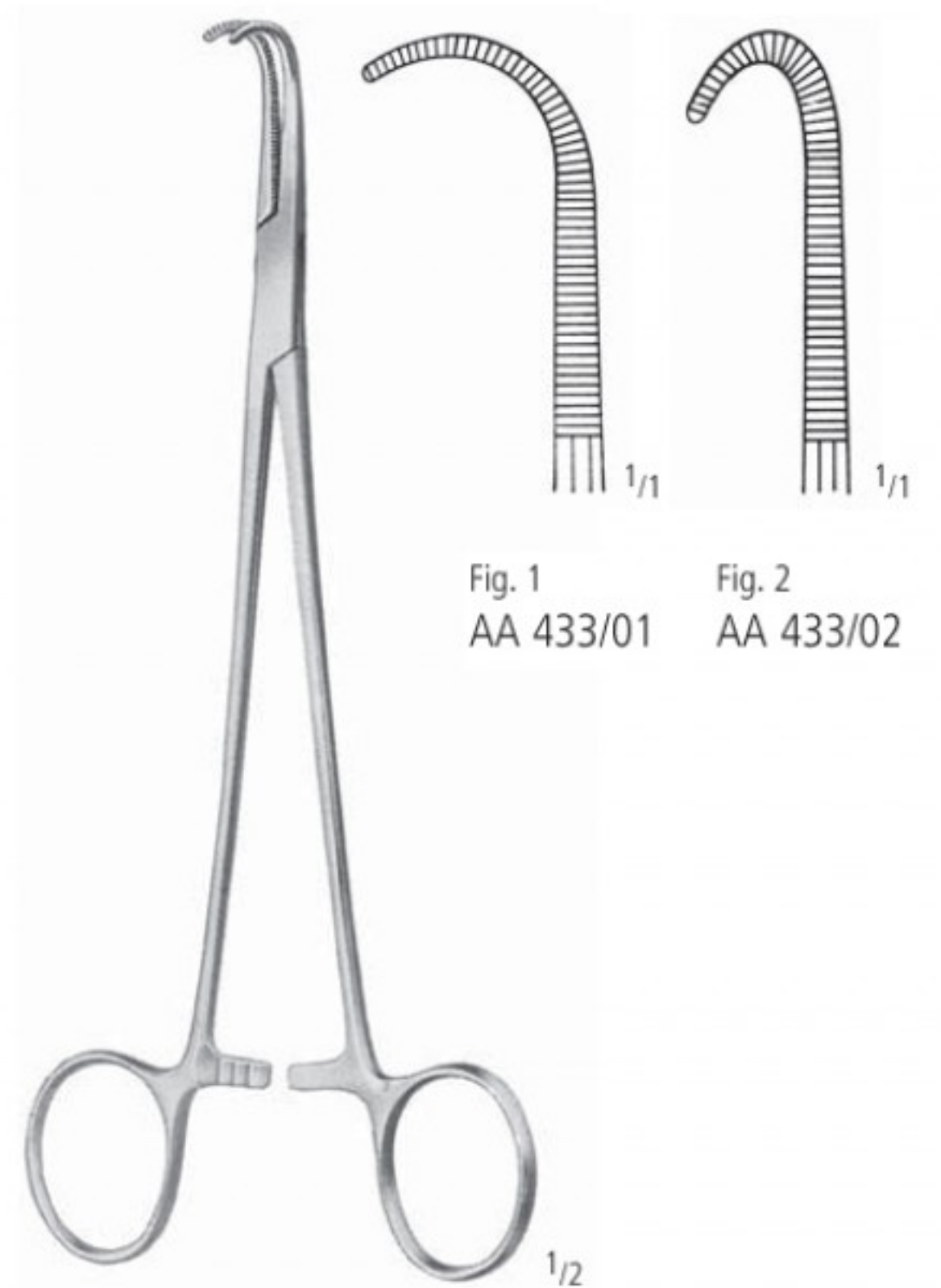

Fig. 1  
 AA 433/01

Fig. 2  
 AA 433/02

NEGUS  
 19,0 cm/7<sup>1</sup>/<sub>2</sub>"



KLEMMEN HEMOSTATS PINZAS HEMOSTATICAS PINCES HEMOSTATIQUES PINZE EMOSTATICHE

Präparier- und Ligaturklemmen, Hysterektomieklemmen  
 Dissecting and Ligature Forceps, Hysterectomy Forceps  
 Pinzas para preparaciones y ligaduras, Pinzas-clamps para histerectomía  
 Pincés à disséquer et à ligatures, Pincés à hystérectomie  
 Pinze per preparazioni e legature, Pinze per isterectomia

AA  
AB  
AC  
AD  
AE  
AF  
AK  
AL  
AM  
AO  
AP  
AR  
KA  
KB  
KC  
KD  
KU  
KY

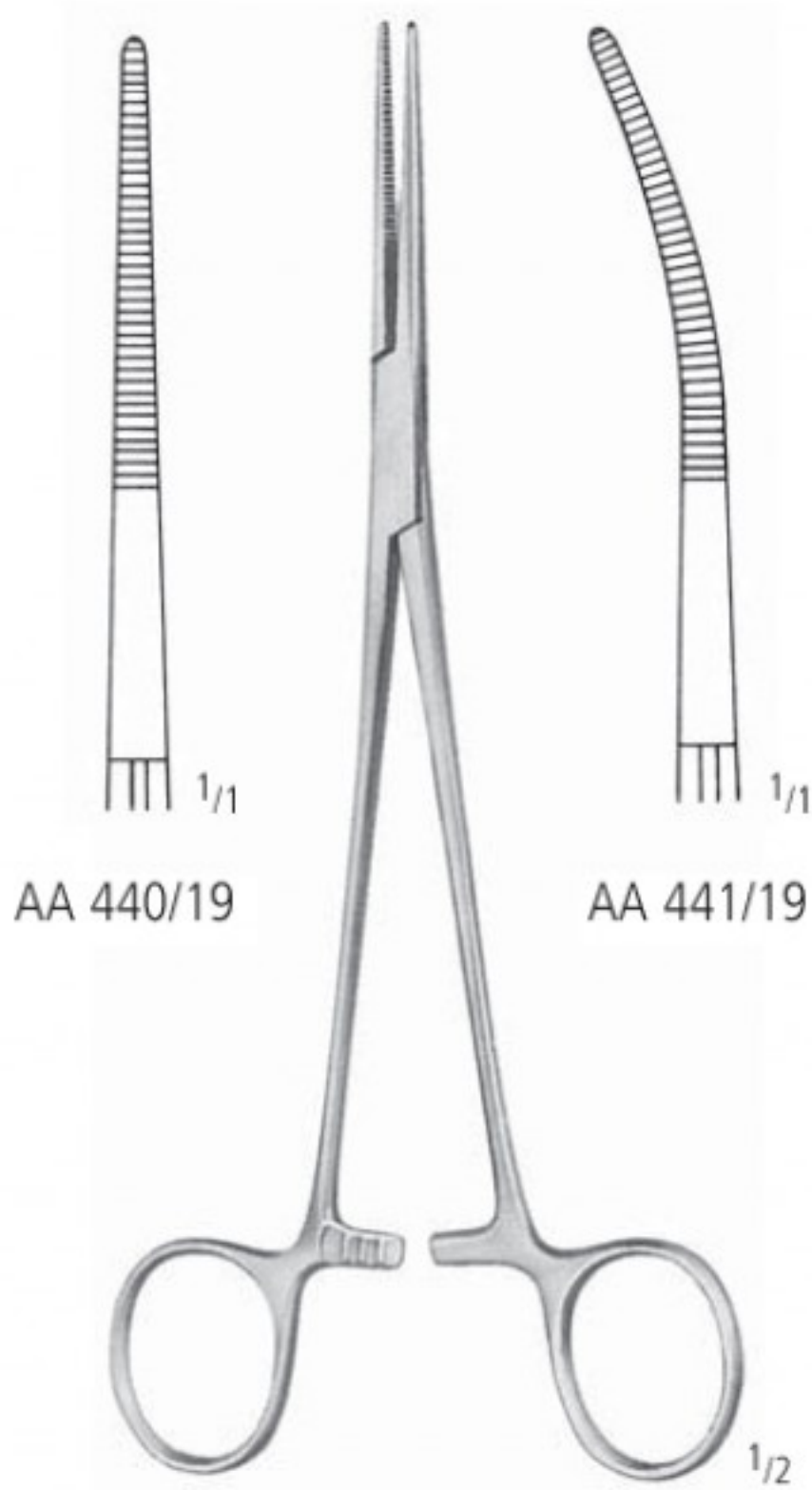

**BIRKETT**  
19,0 cm/7<sup>1</sup>/<sub>2</sub>"

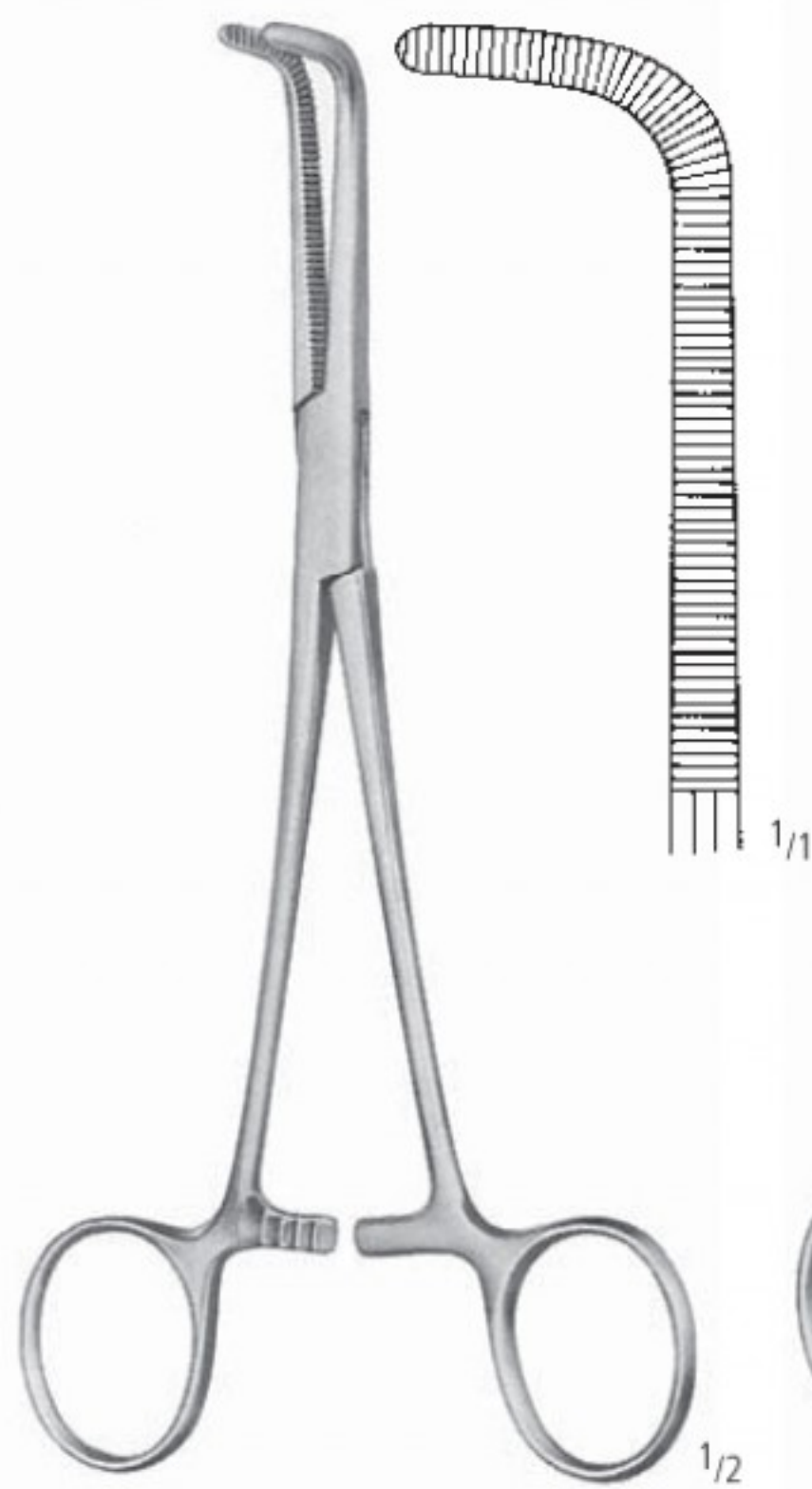

**WIKSTROEM**  
AA 443/19  
19,0 cm/7<sup>1</sup>/<sub>2</sub>"

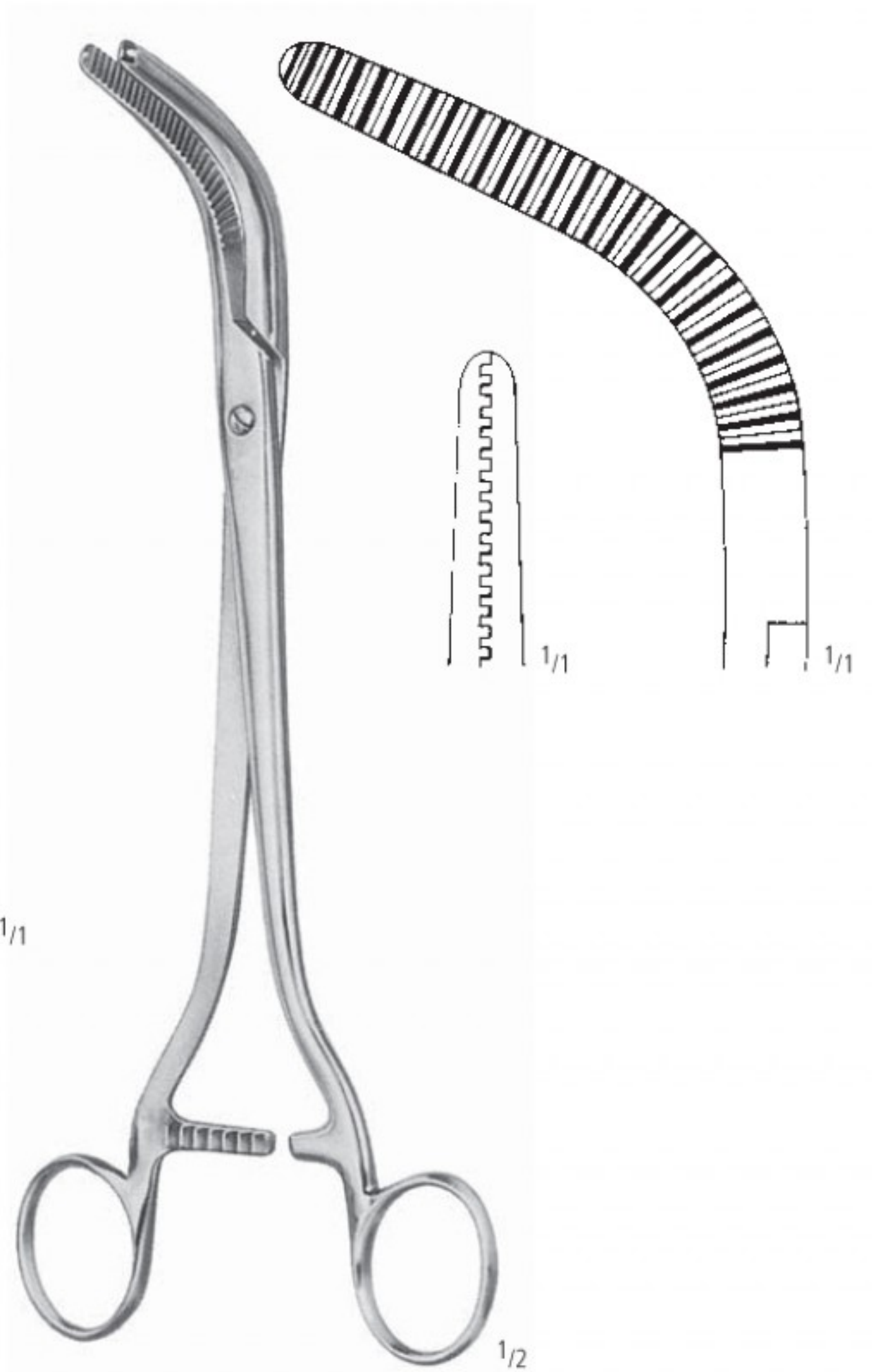

**WERTHEIM**  
AA 500/27  
27,0 cm/10<sup>3</sup>/<sub>4</sub>"

Hysterektomieklemmen  
 Hysterectomy Forceps  
 Pinzas-clamps para histerectomía  
 Pincés à hystérectomie  
 Pinze per isterectomia

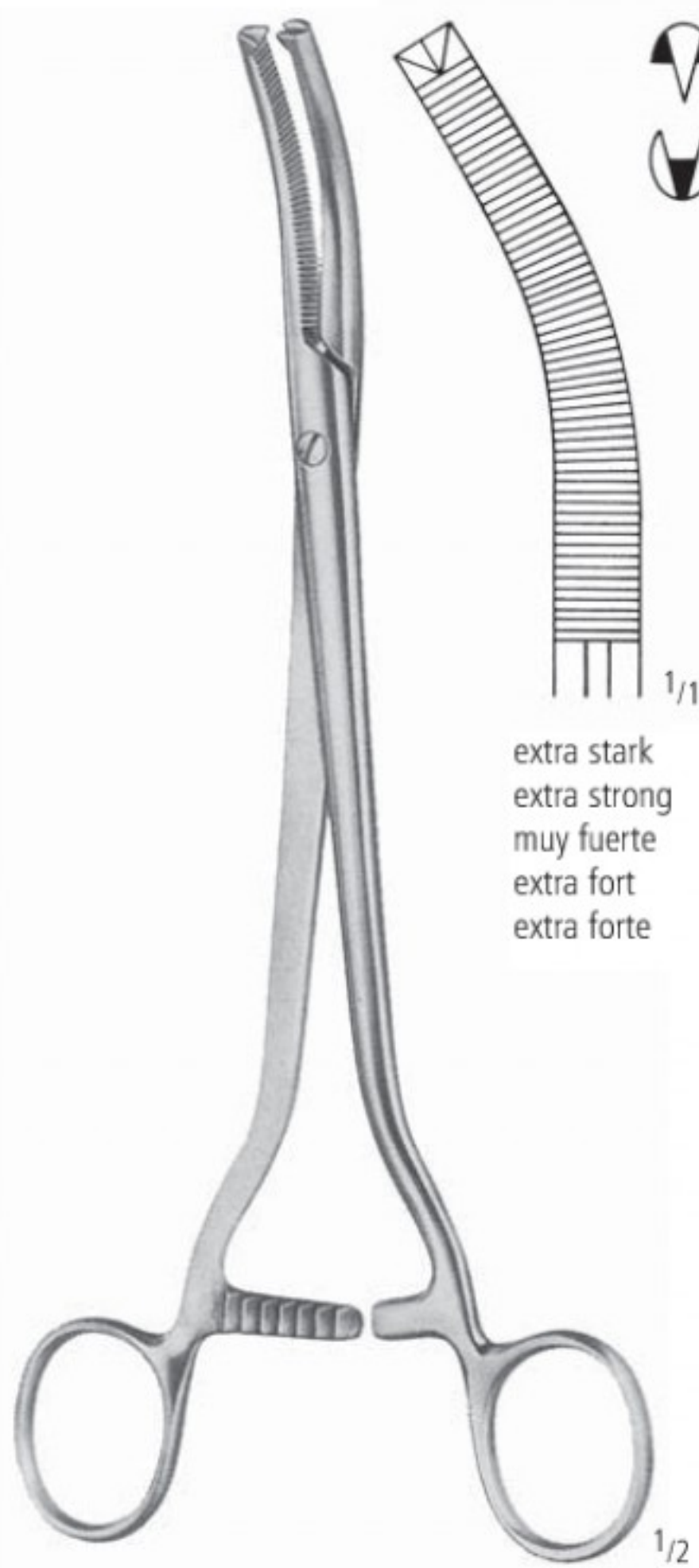

extra stark  
 extra strong  
 muy fuerte  
 extra fort  
 extra forte

**WERTHEIM 1:2**  
 AA 501/24  
 24,0 cm/9 1/2"

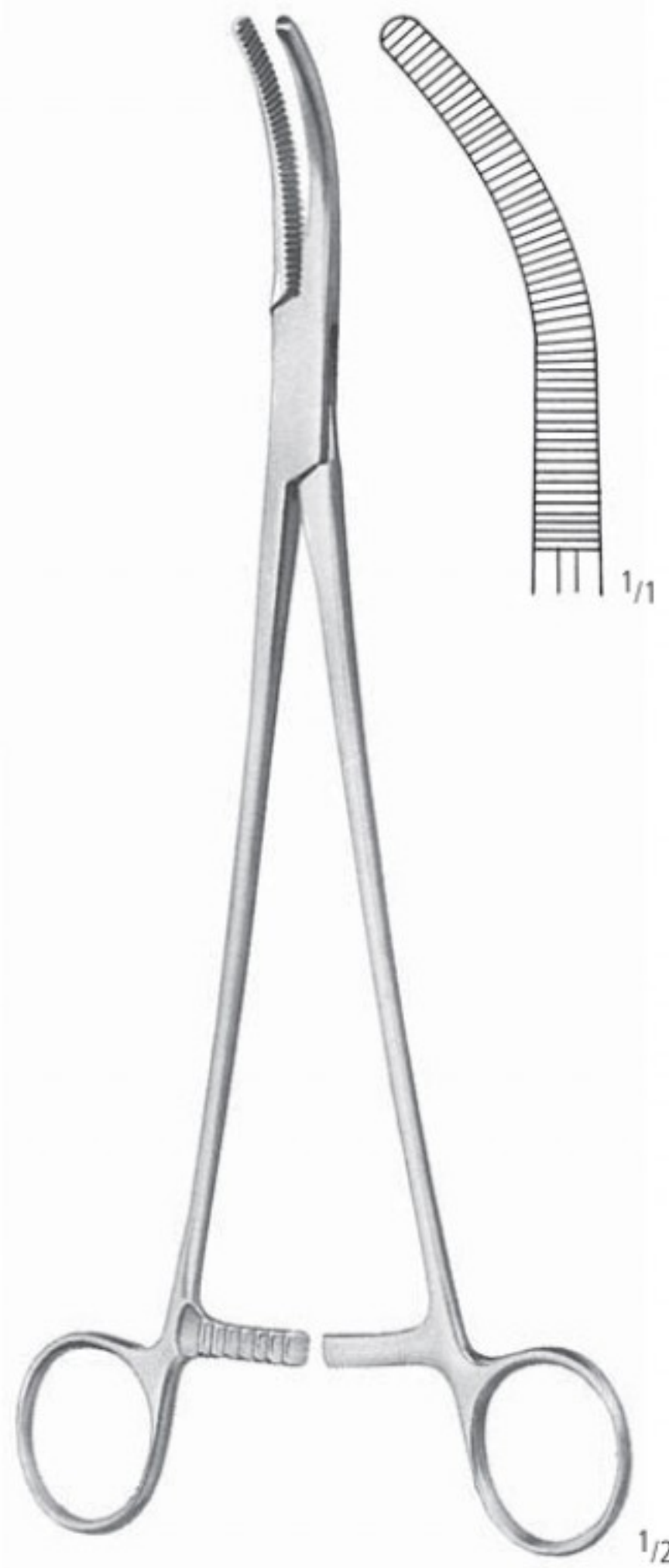

**WERTHEIM**  
 AA 502/25  
 25,0 cm/10"

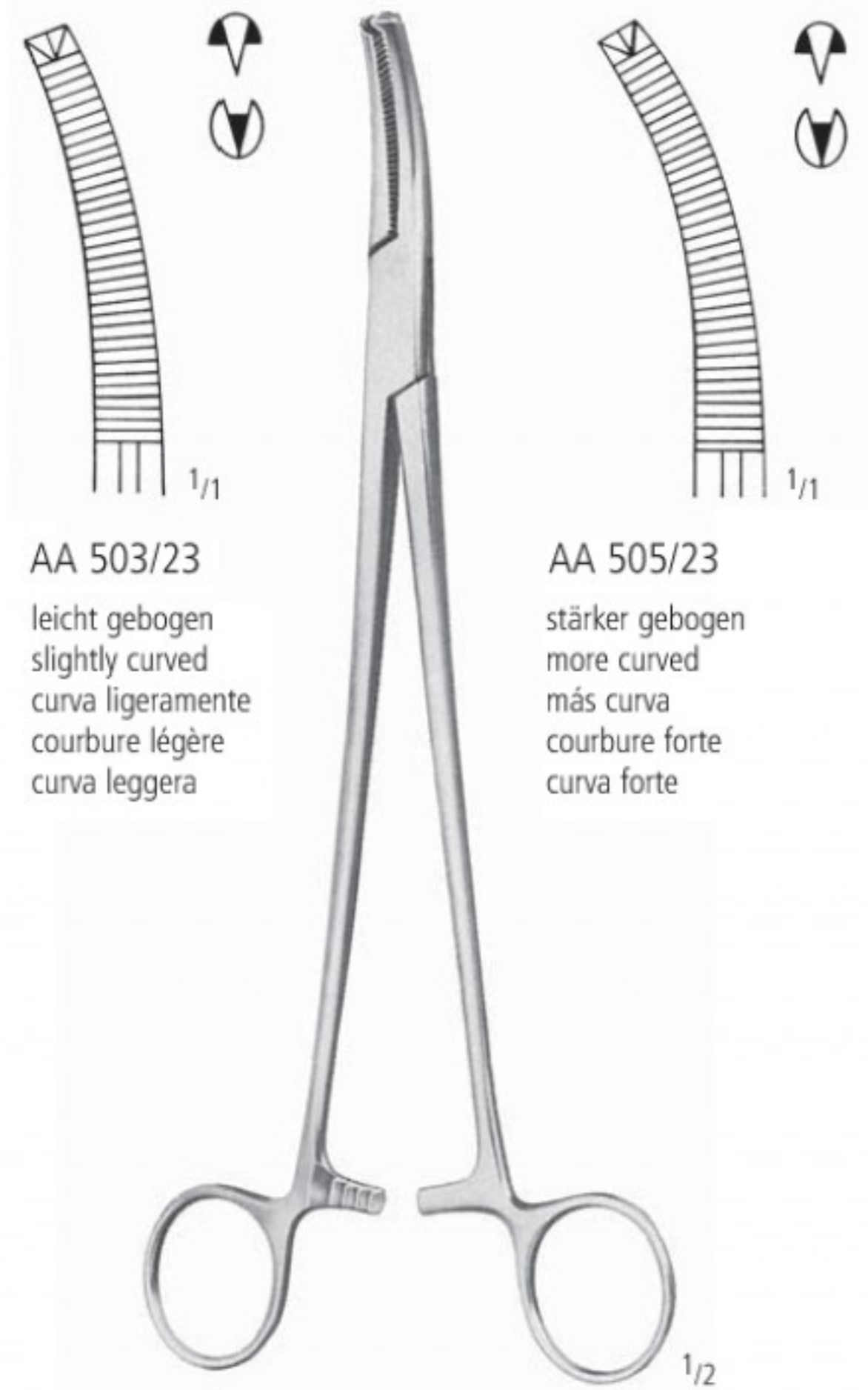

AA 503/23  
 leicht gebogen  
 slightly curved  
 curva ligeramente  
 courbure légère  
 curva leggera

AA 505/23  
 stärker gebogen  
 more curved  
 más curva  
 courbure forte  
 curva forte

**WERTHEIM 1:2**  
 23,0 cm/9"



KLEMMEN HEMOSTATS PINZAS HEMOSTATICAS PINCES HEMOSTATIQUES PINZE EMOSTATICHE

Hysterektomieklemmen  
Hysterectomy Forceps  
Pinzas-clamps para histerectomía  
Pinces à hystérectomie  
Pinze per isterectomia



leichtes Maul  
light jaws  
Boca ligera  
Mors léger  
Morso leggero

**HEANEY**  
AA 507/21  
21,0 cm/8<sup>1</sup>/<sub>4</sub>"

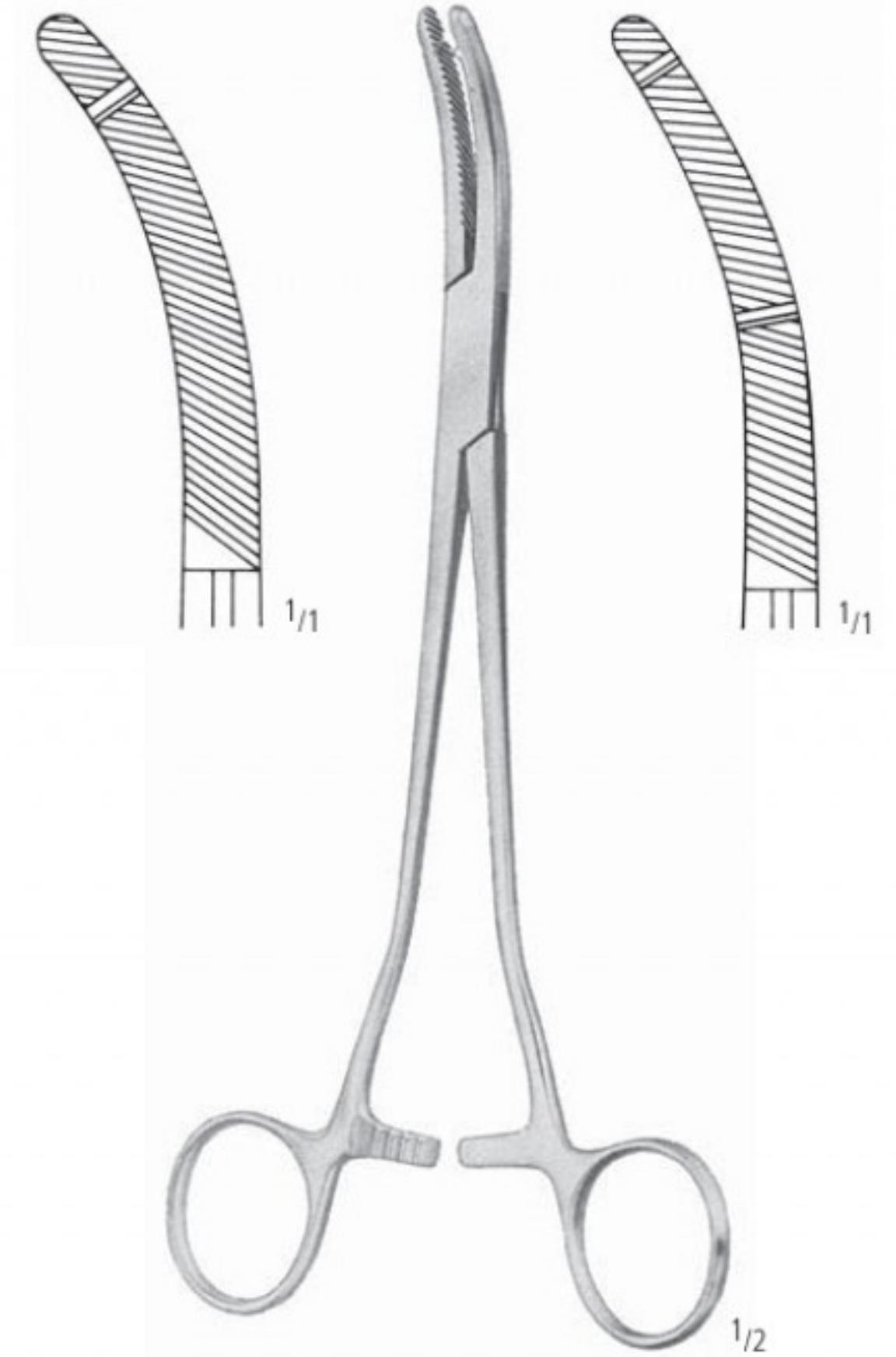

**HEANEY**  
AA 511/21 21,0 cm/8<sup>1</sup>/<sub>4</sub>" AA 513/21  
AA 511/23 23,0 cm/9" AA 513/23

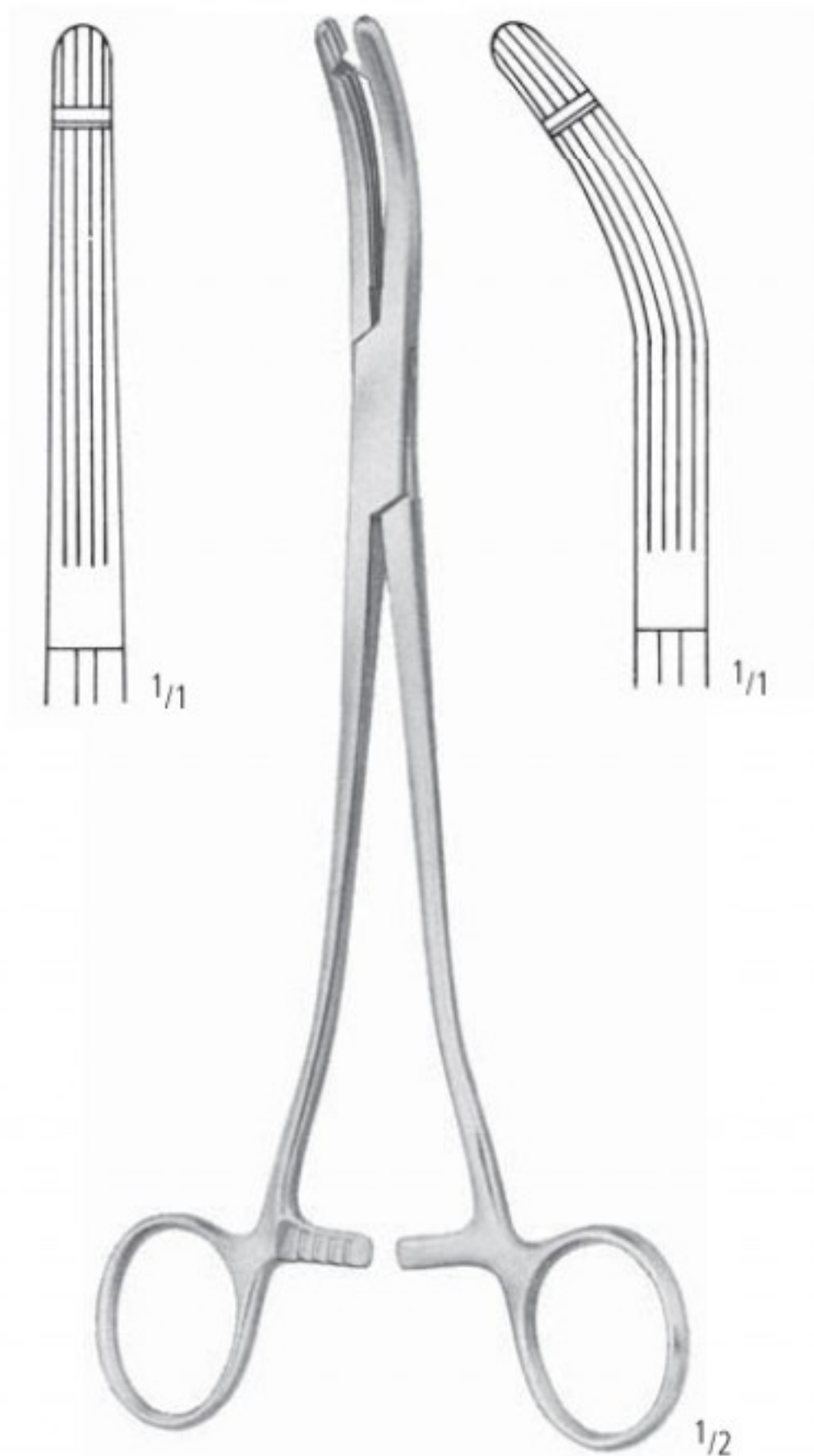

**HEANEY-BALLANTINE**  
AA 514/21 21,0 cm/8<sup>1</sup>/<sub>4</sub>" AA 515/21

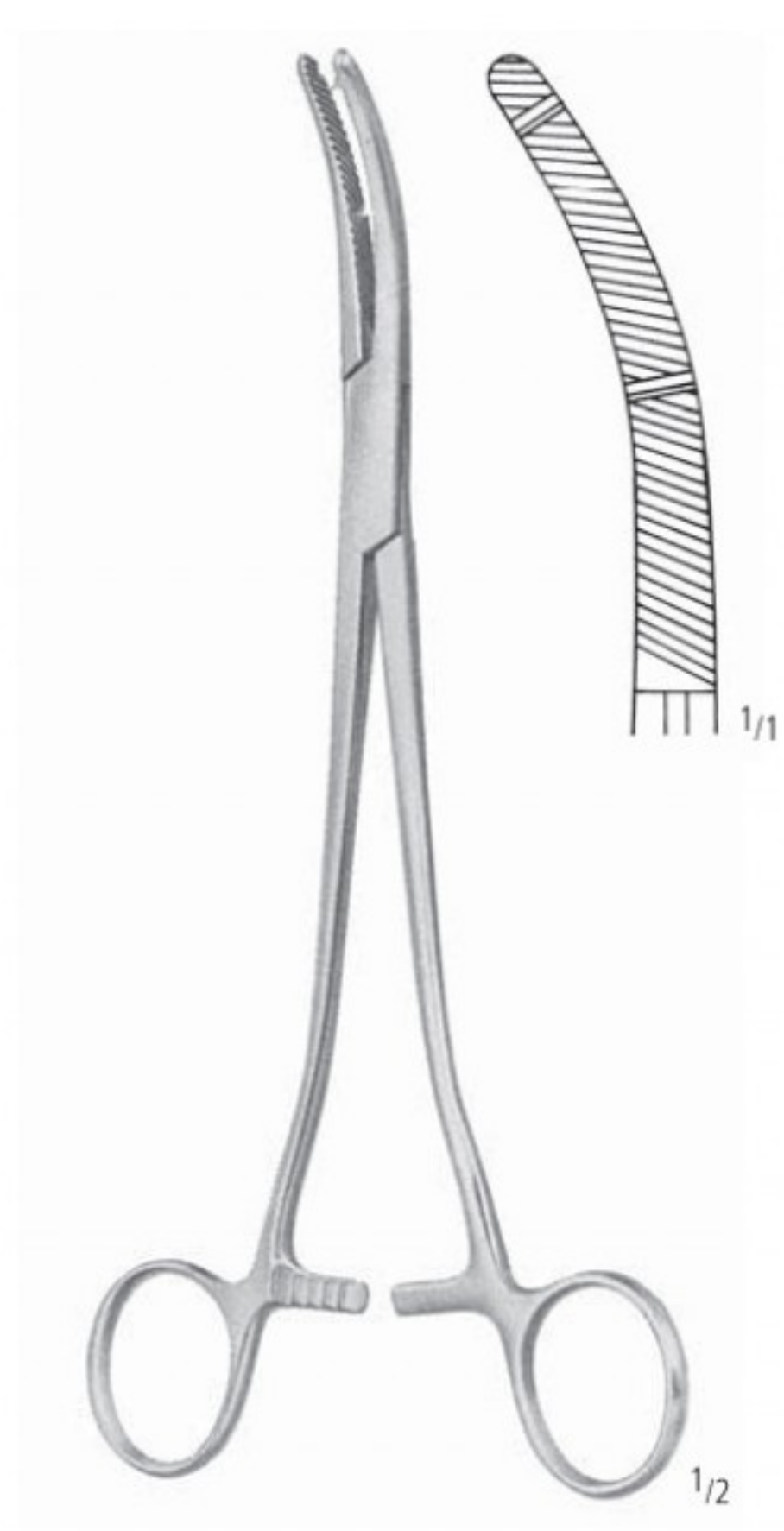

**HEANEY-KANTER**  
AA 517/21  
21,0 cm/8<sup>1</sup>/<sub>4</sub>"

AA

AB

AC

AD

AE

AF

AK

AL

AM

AO

AP

AR

KA

KB

KC

KD

KU

KY



Hysterektomieklemmen  
 Hysterectomy Forceps  
 Pinzas-clamps para histerectomía  
 Pincés à hystérectomie  
 Pinze per isterectomia

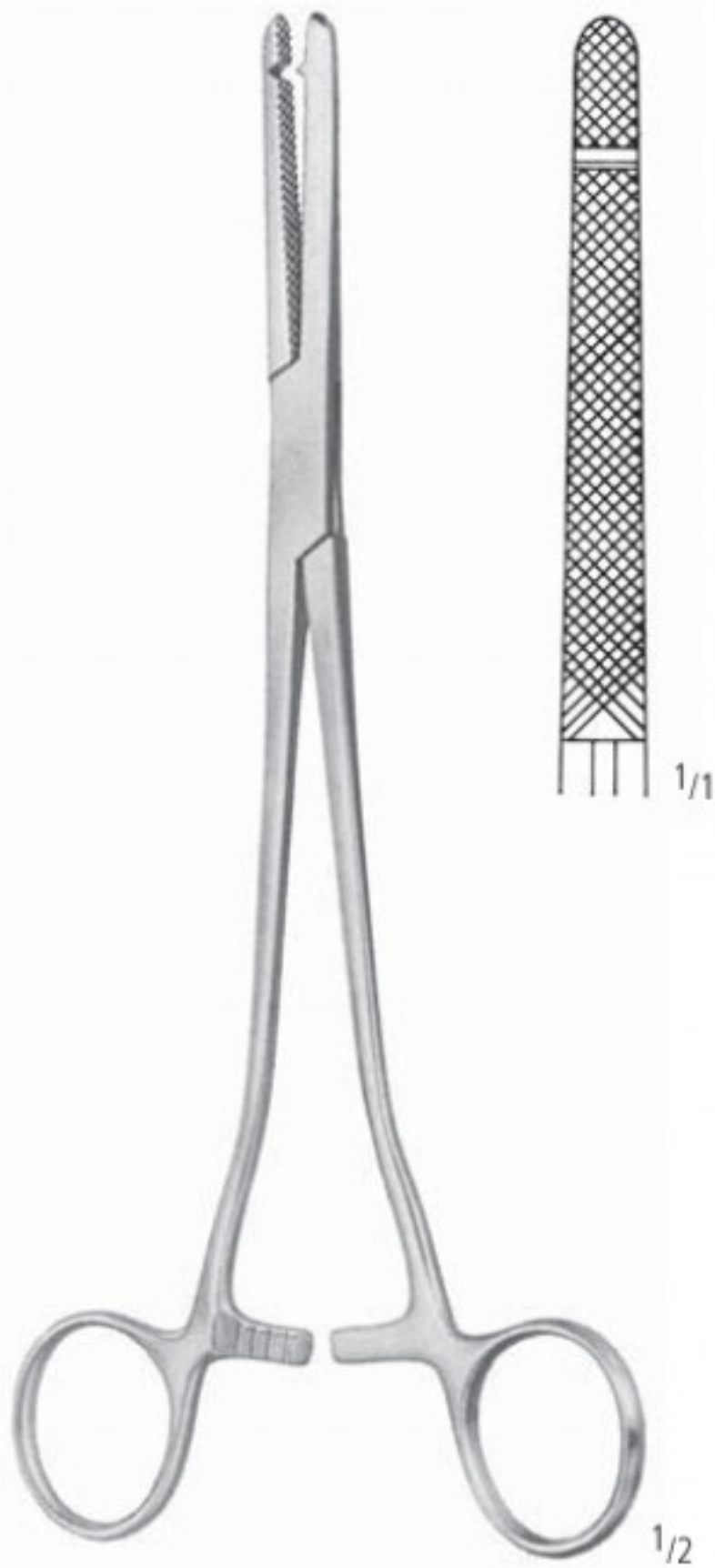

**HEANEY-REZAK**  
 AA 519/21  
 21,0 cm/8<sup>1</sup>/<sub>4</sub>"

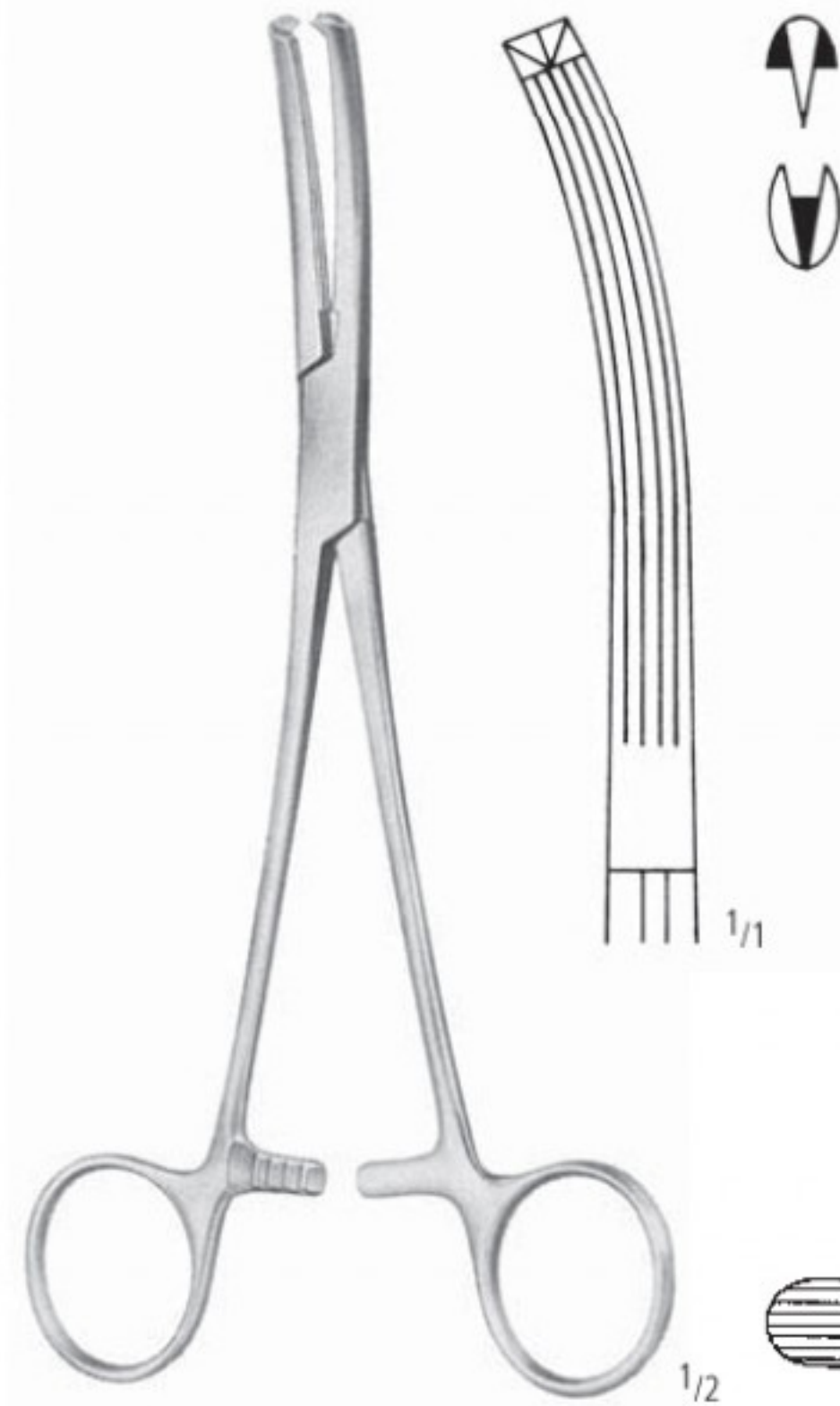

**LONG**  
 AA 521/19  
 19,0 cm/7<sup>1</sup>/<sub>2</sub>"

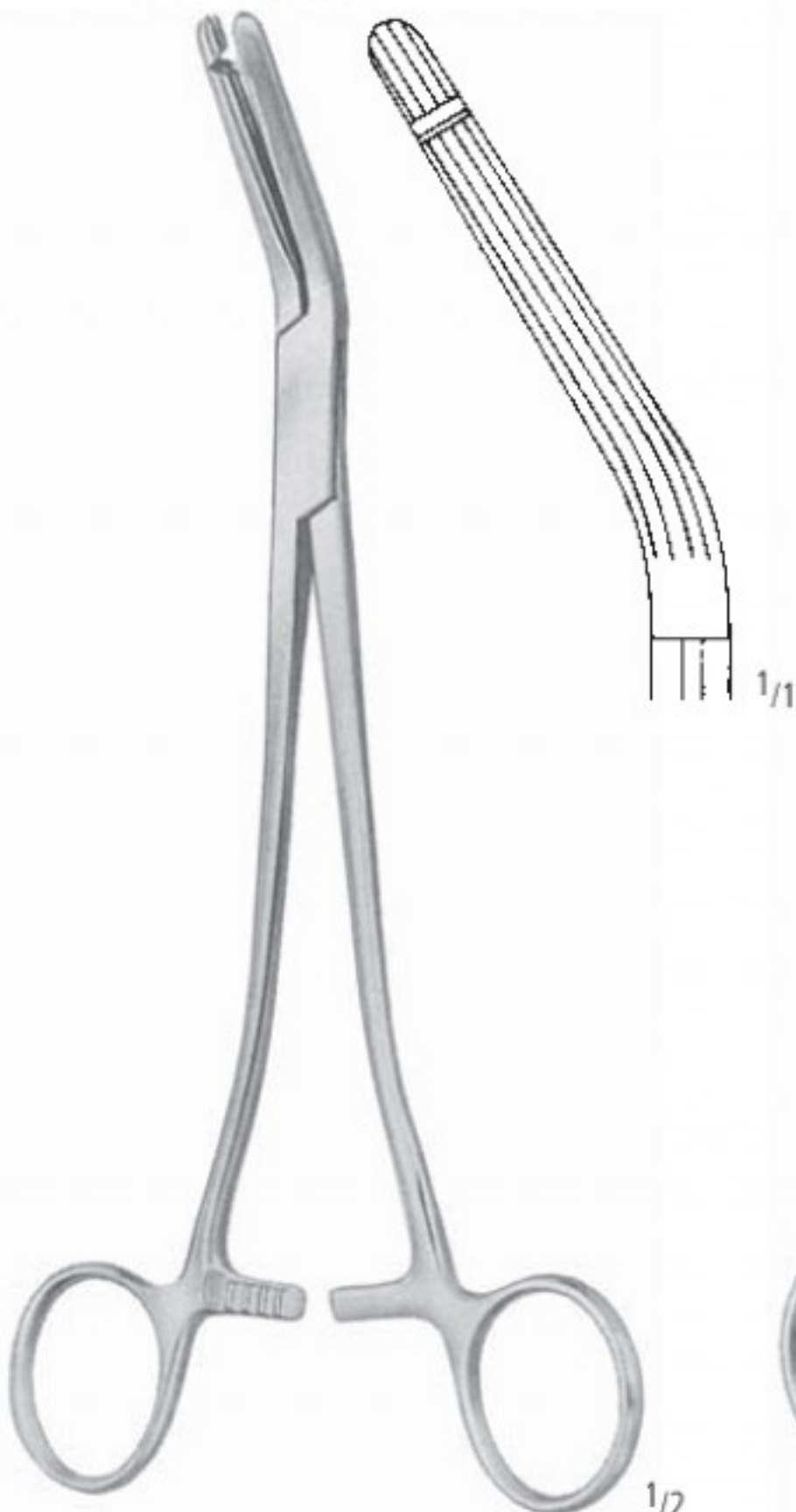

**GARLAND**  
 AA 523/21  
 21,0 cm/8<sup>1</sup>/<sub>4</sub>"

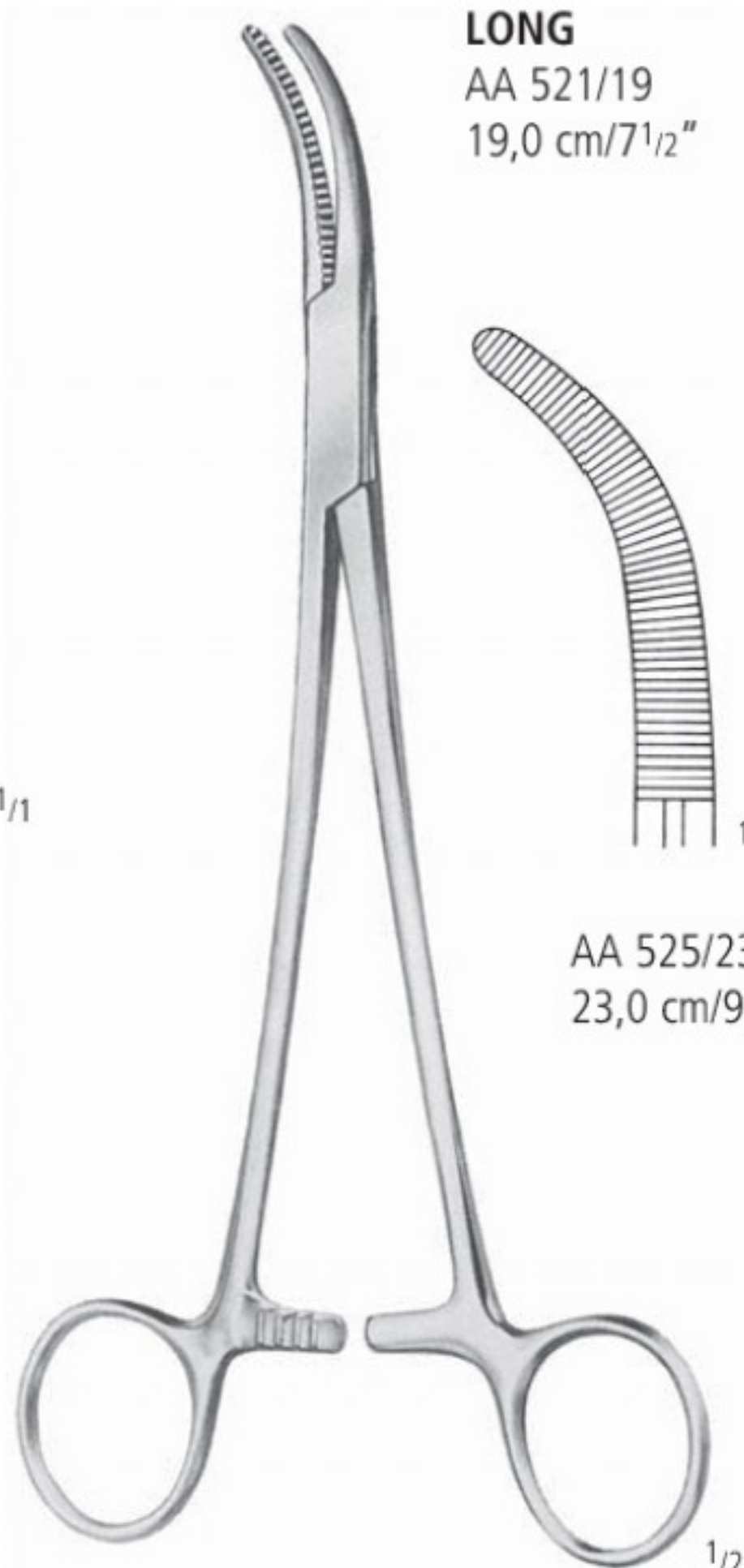

**MOYNIHAN**

AA 525/23  
 23,0 cm/9"

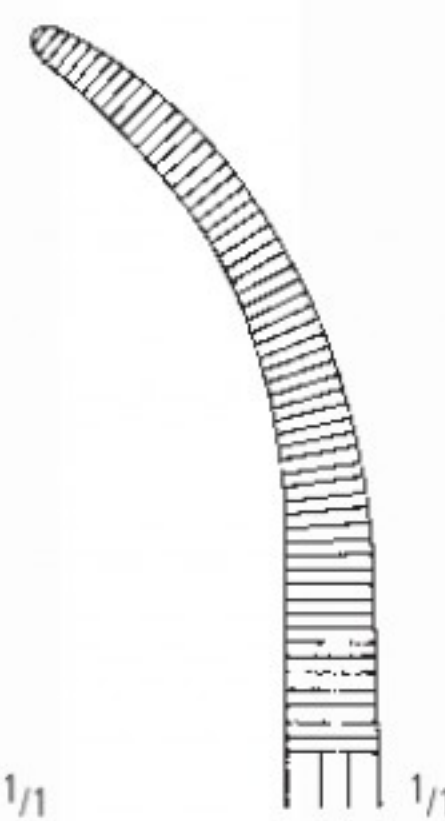

AA 527/24  
 24,0 cm/9<sup>1</sup>/<sub>2</sub>"

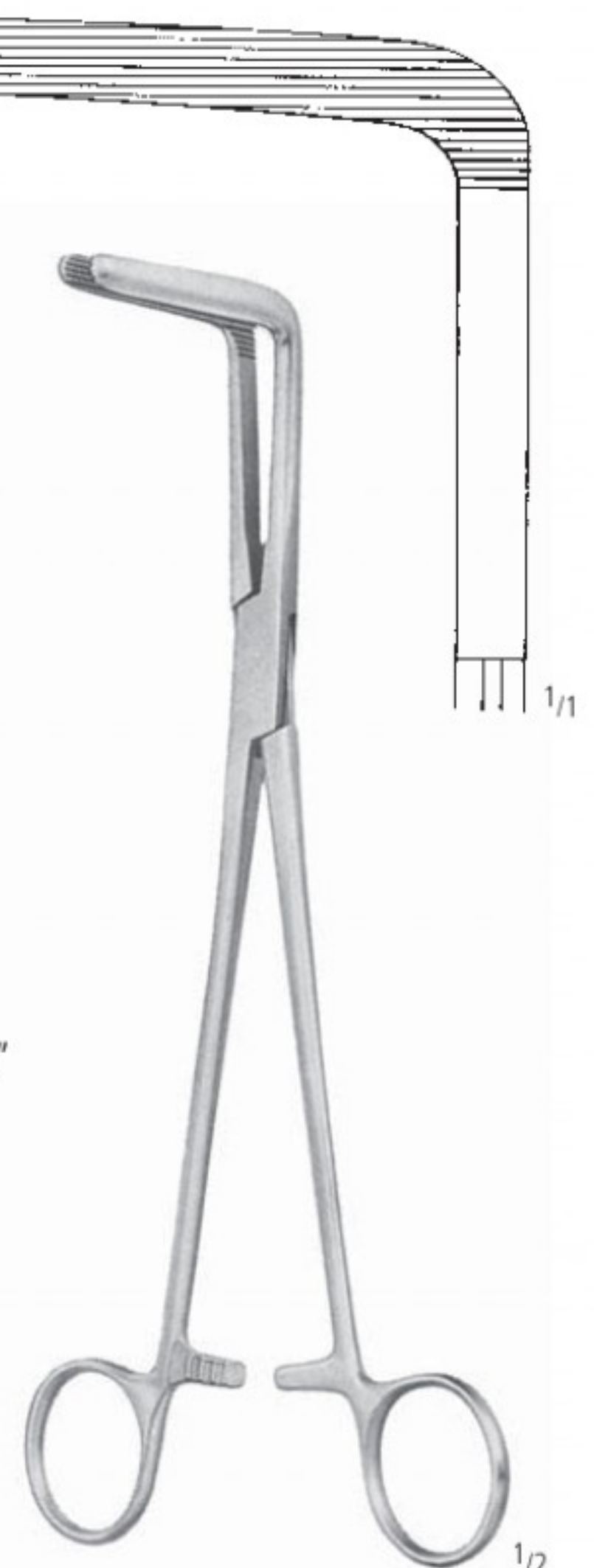

**WERTHEIM-CULLEN**  
 AA 529/21  
 21,5 cm/8<sup>1</sup>/<sub>2</sub>"



KLEMMEN HEMOSTATS PINZAS HEMOSTATICAS PINCES HEMOSTATIQUES PINZE EMOSTATICHE

Hysterektomieklemmen  
 Hysterectomy Forceps  
 Pinzas-clamps para histerectomía  
 Pincès à hystérectomie  
 Pinze per isterectomia

AA

AB

AC

AD

AE

AF

AK

AL

AM

AO

AP

AR

KA

KB

KC

KD

KU

KY

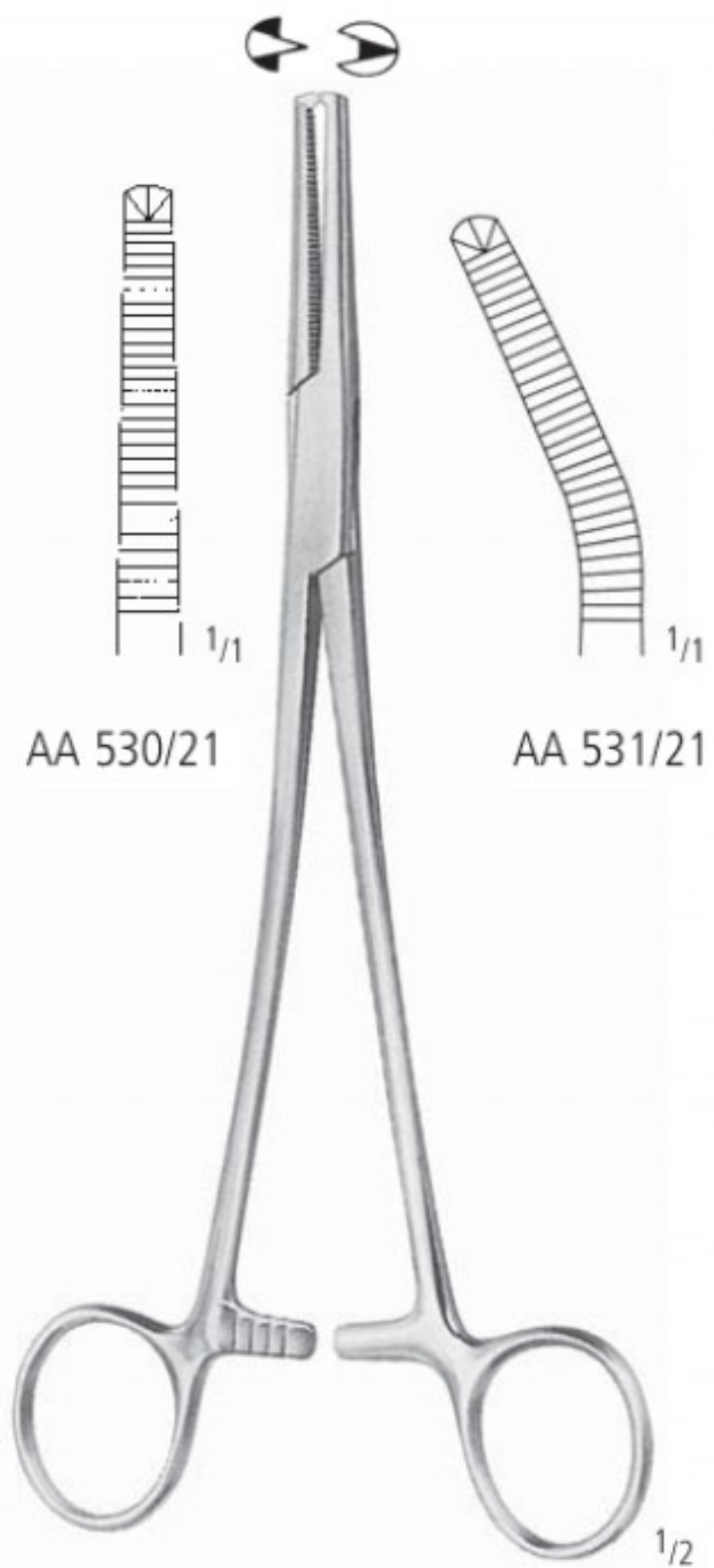

AA 530/21

AA 531/21

**PHANEUF 1:2**  
21,5 cm/8½"

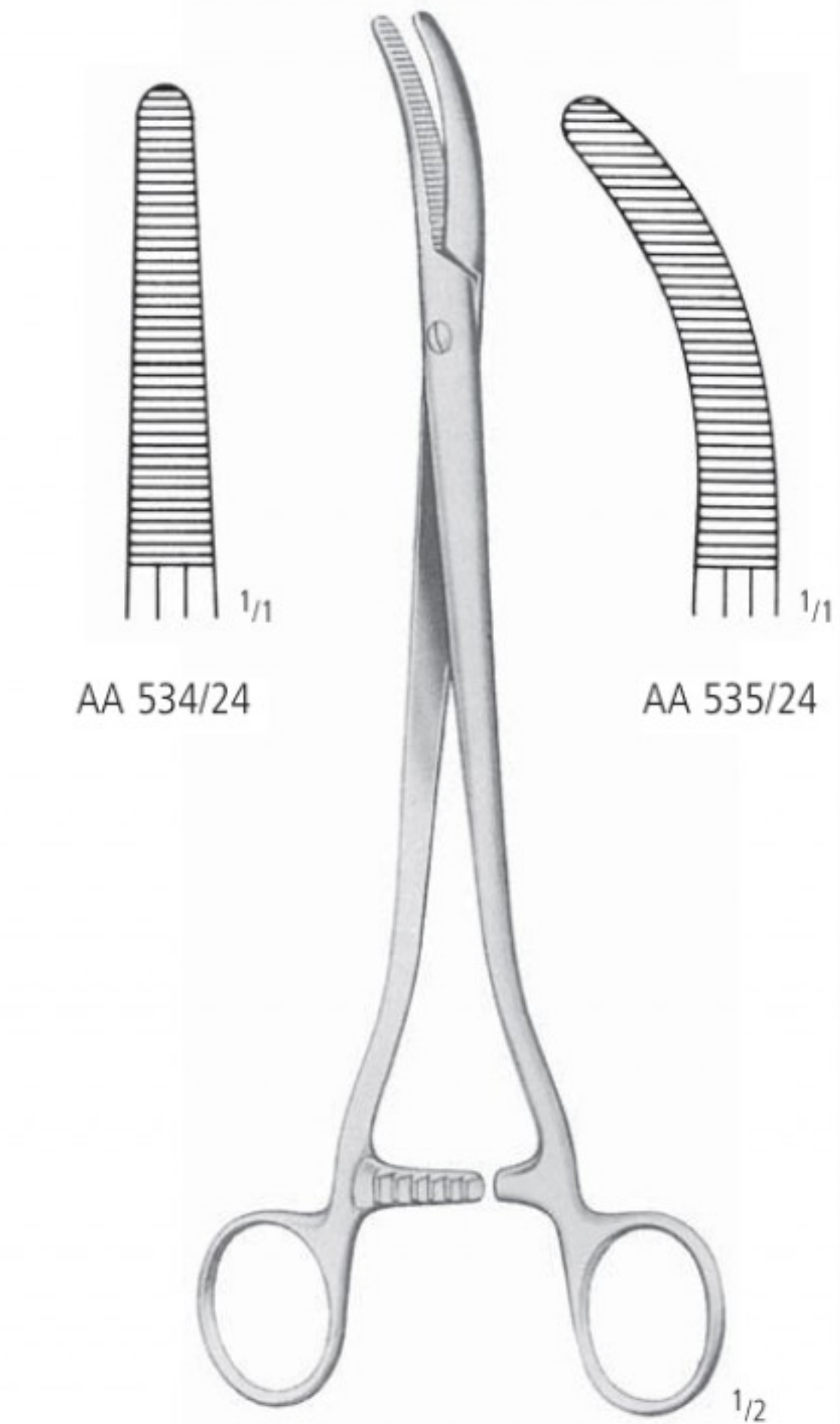

AA 534/24

AA 535/24

**SEGOND-LANDAU**  
24,0 cm/9½"

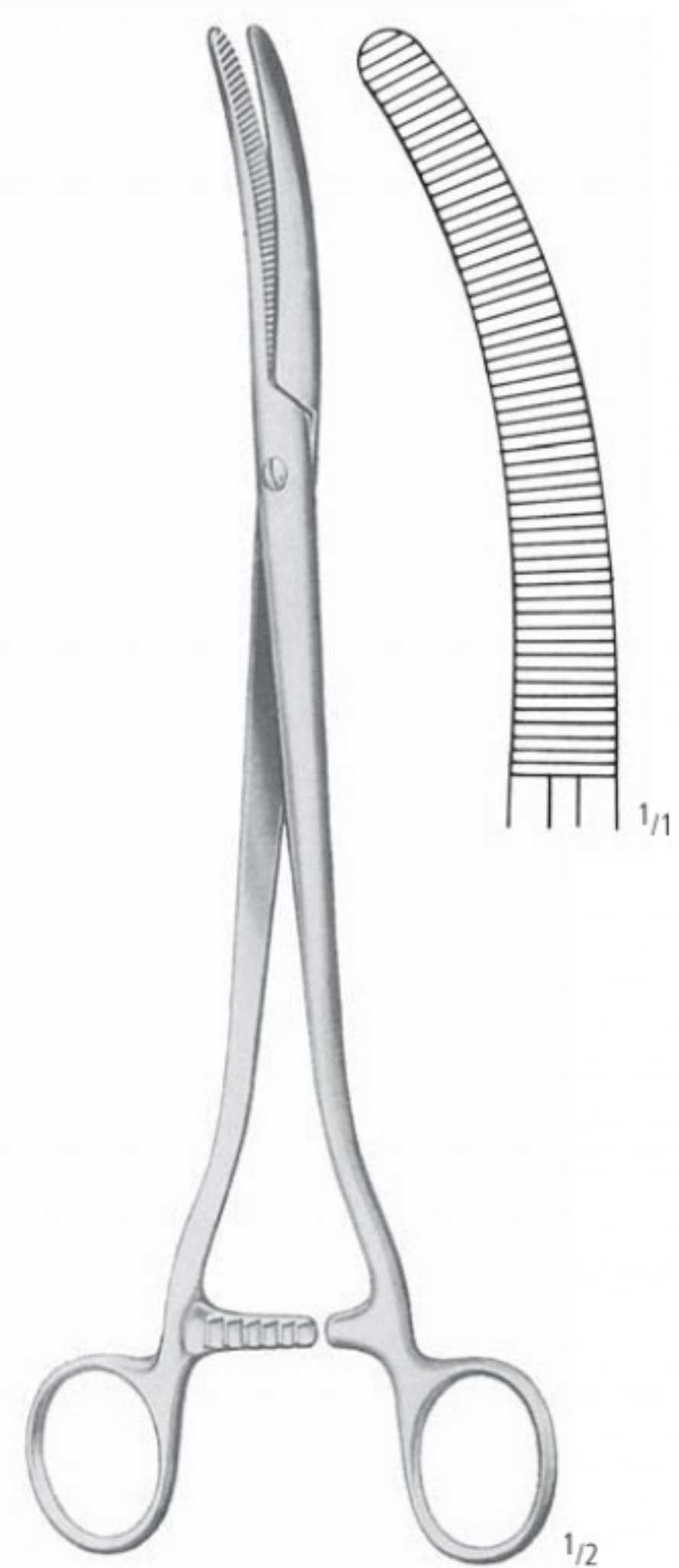

**FAURE**  
AA 537/25  
25,0 cm/10"

Parametriumklemmen  
 Parametrium Forceps  
 Pinzas-clamps para parametrium  
 Pincas-clamps pour parametrium  
 Pinze per parametrium



**PARAMETRIUM**  
 21,0 cm/8<sup>1</sup>/<sub>4</sub>"

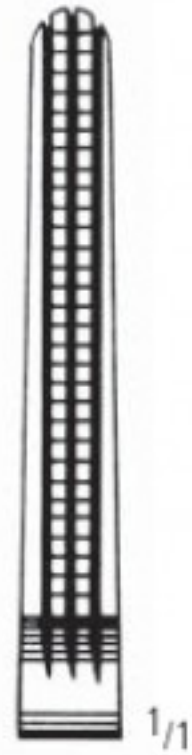

AA 540/00

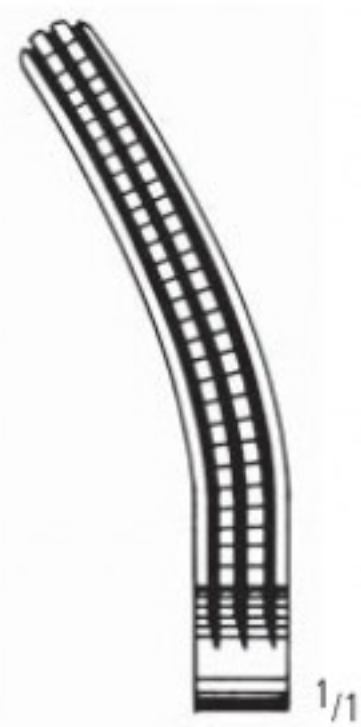

AA 541/01



AA 541/02

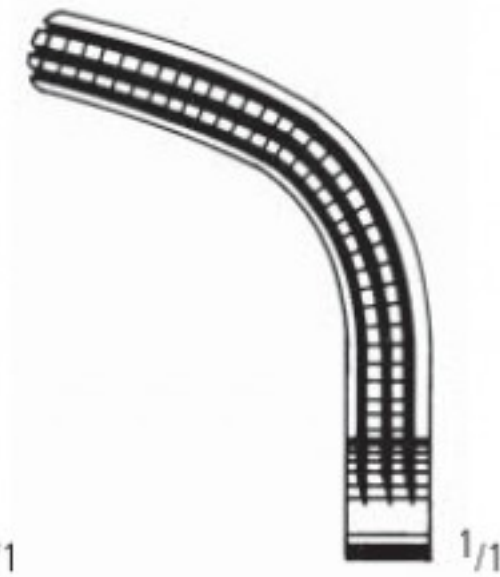

AA 541/03

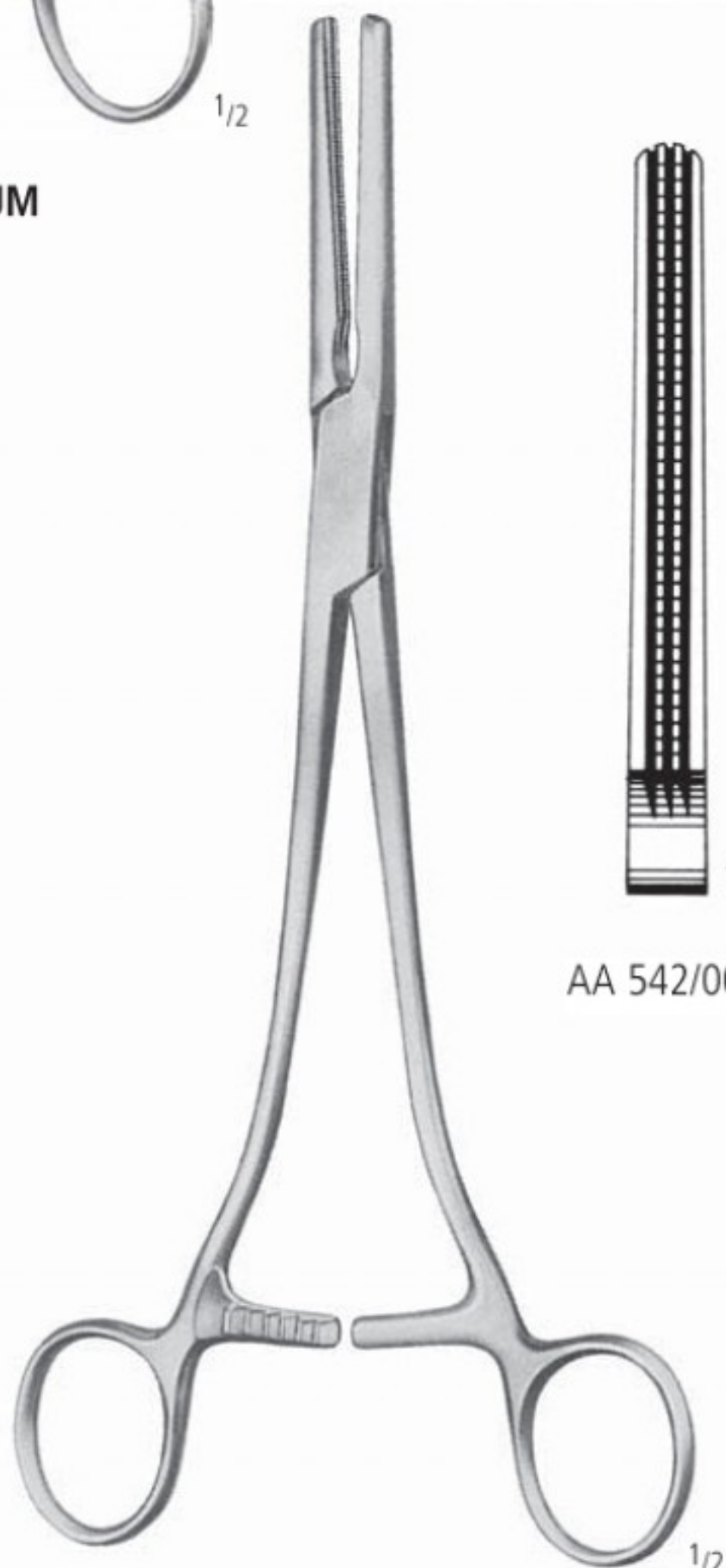

**PARAMETRIUM**  
 24,0 cm/9<sup>1</sup>/<sub>2</sub>"

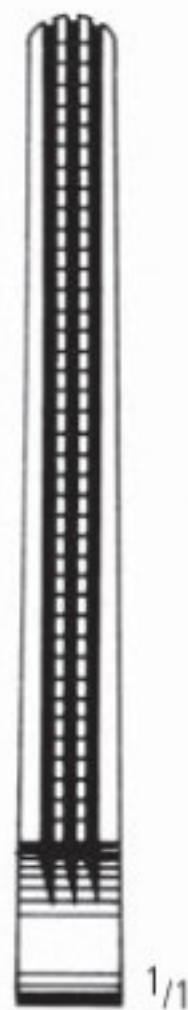

AA 542/00



AA 543/01

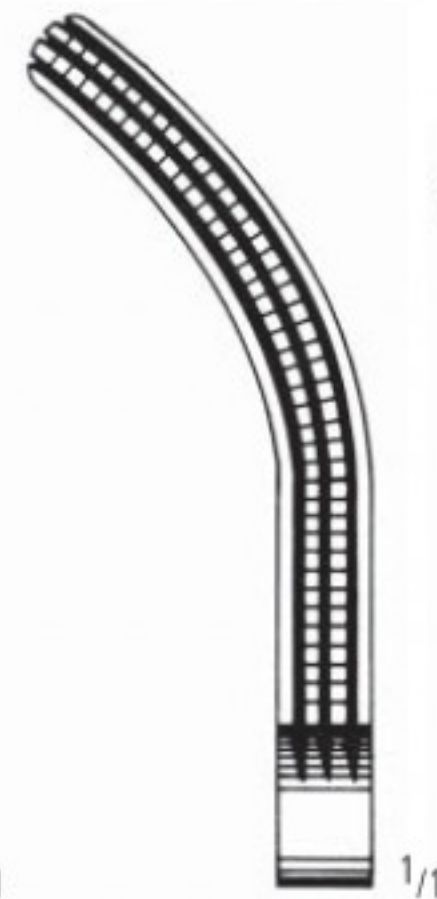

AA 543/02



AA 543/03



KLEMMEN HEMOSTATS PINZAS HEMOSTATICAS PINCES HEMOSTATIQUES PINZE EMOSTATICHE

Druckklemmen, Hämorrhoidenklemmen  
 Angiotribes, Haemorrhoidal Forceps  
 Pinzas-clamps de presión progresiva, Pinzas hemorroidales  
 Pincers-clamps à pression progressive et à hémorroïdes  
 Pinze per pressione progressiva e per emorroidi

AA

AB

AC

AD

AE

AF

AK

AL

AM

AO

AP

AR

KA

KB

KC

KD

KU

KY

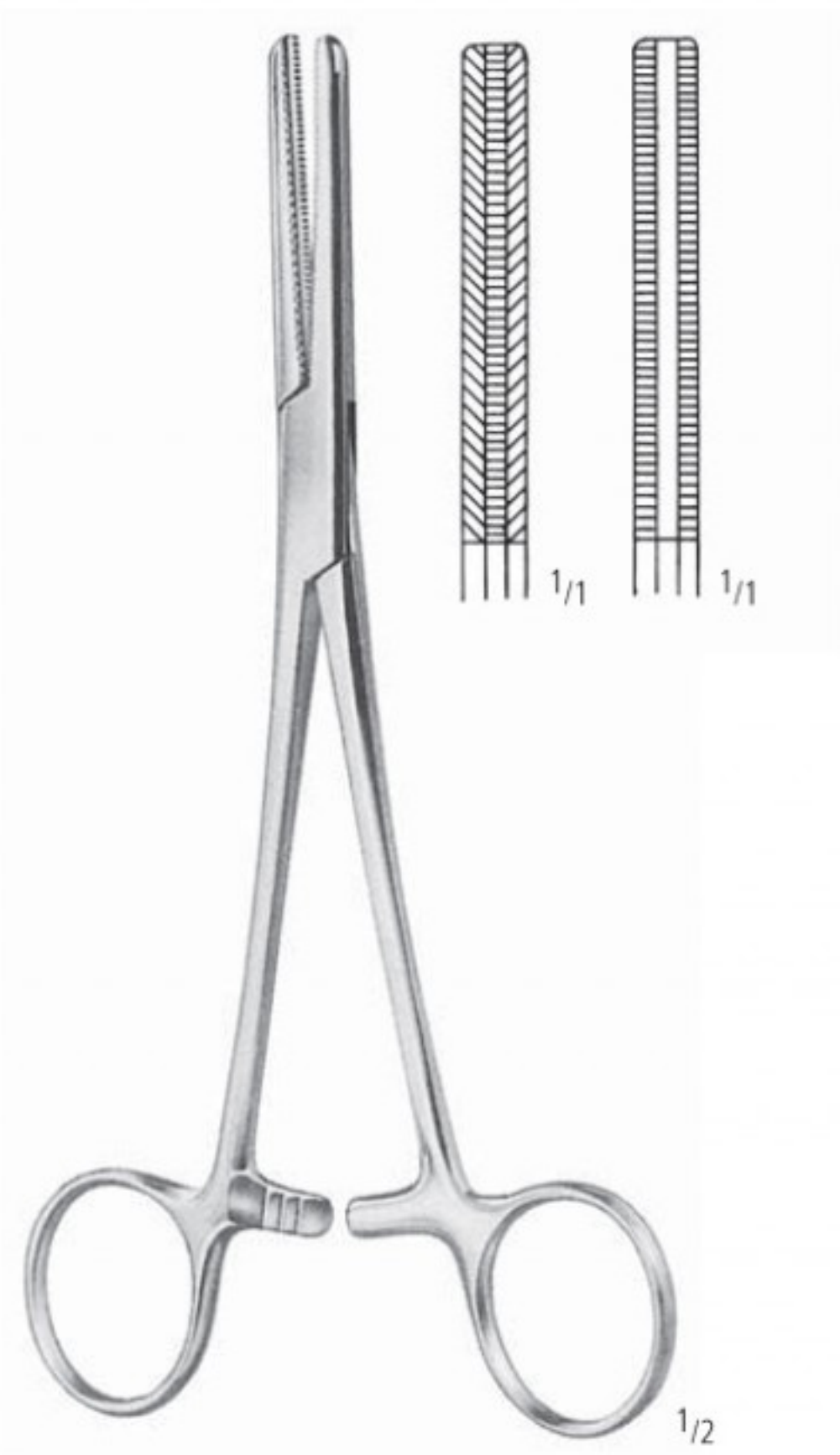

**FERGUSSON**

AA 550/16  
 AA 550/20

16,0 cm/6<sup>1</sup>/<sub>4</sub>"  
 20,0 cm/8"

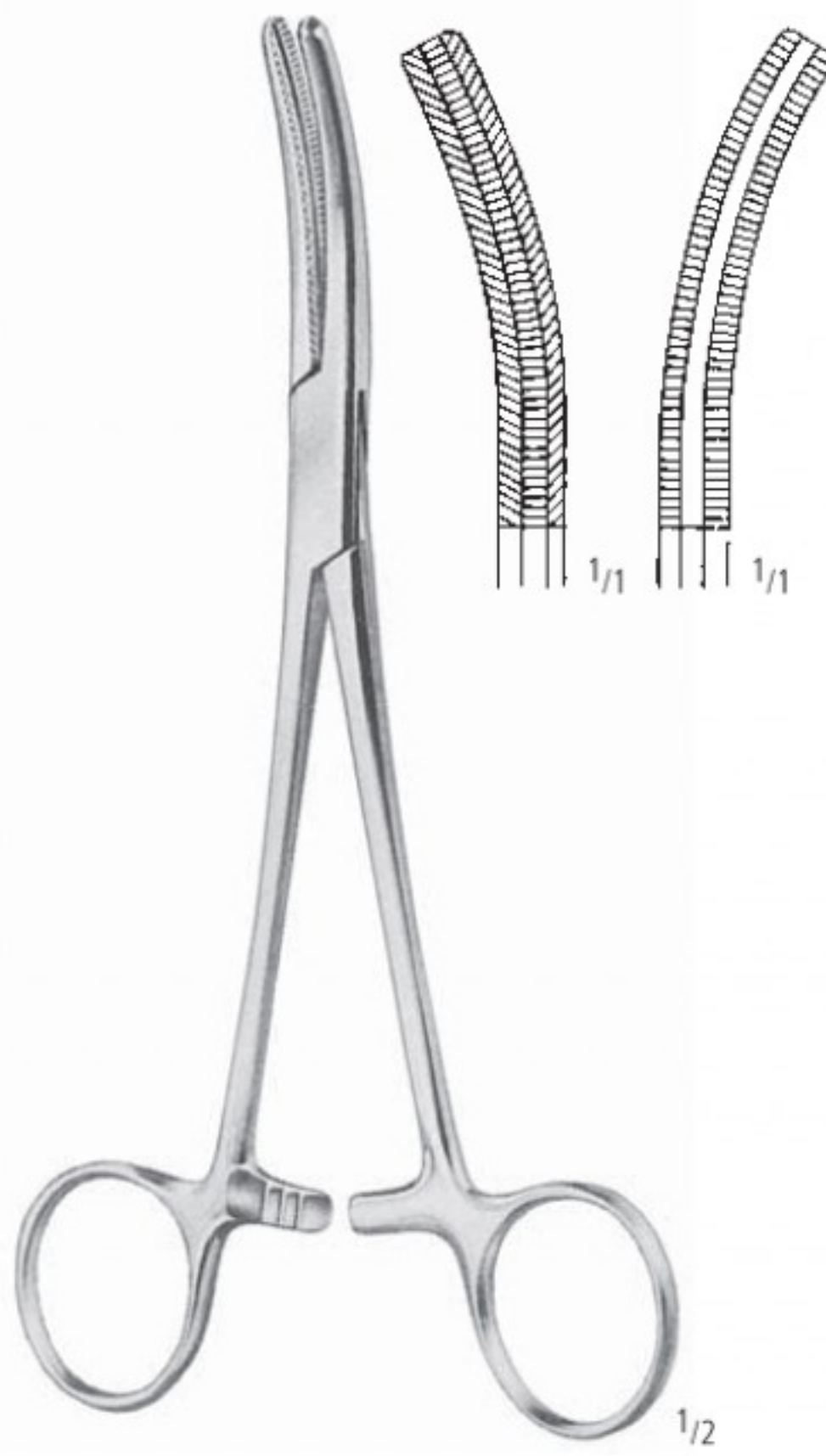

**FERGUSSON**

AA 551/16  
 AA 551/20



**PRATT**

AA 556/15  
 15,0 cm/6"

Druckklemmen, Hämorrhoidenklemmen  
 Angiotribes, Haemorrhoidal Forceps  
 Pinzas-clamps de presión progresiva, Pinzas hemorroidales  
 Pincers-clamps à pression progressive et à hémorroïdes  
 Pinze per pressione progressiva e per emorroidi

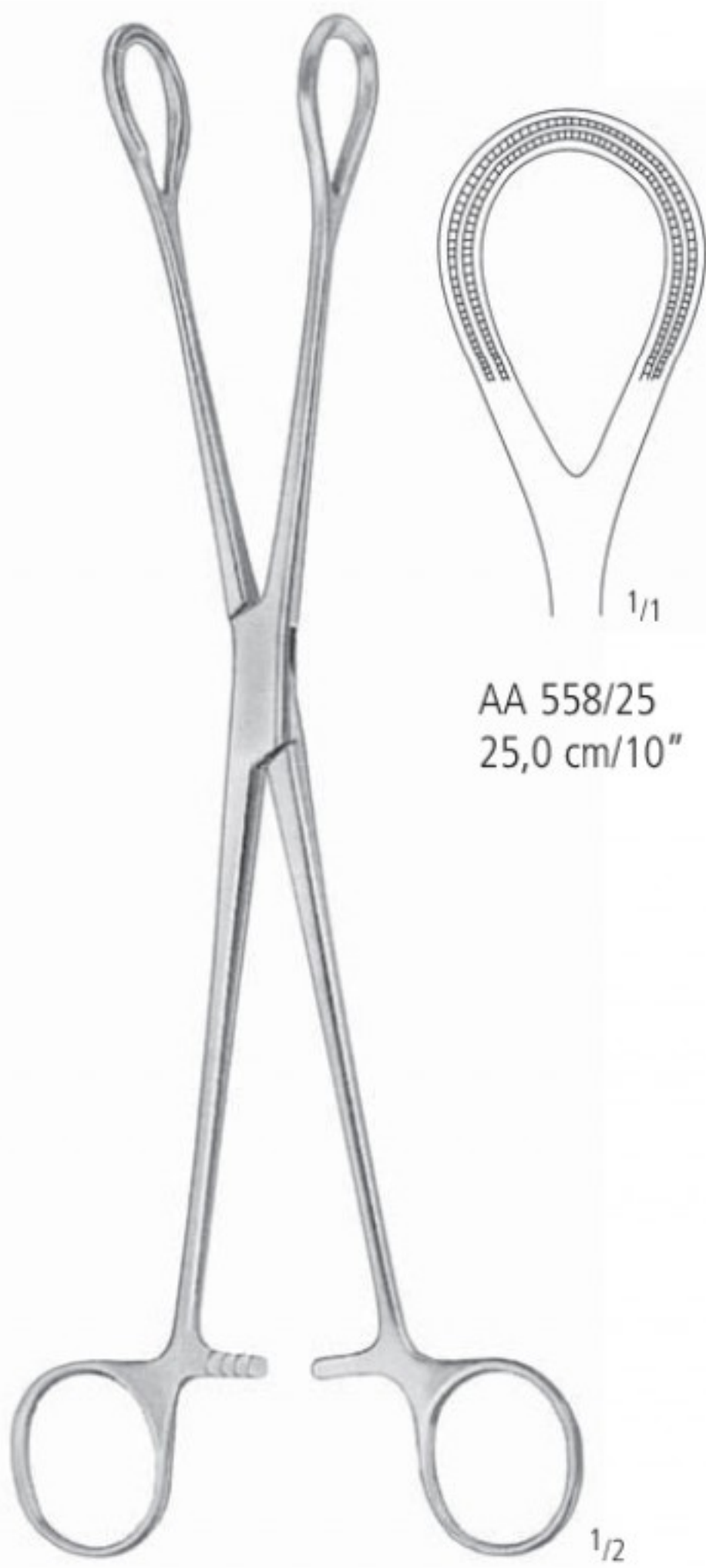

AA 558/25  
 25,0 cm/10"



AA 558/27  
 27,0 cm/10<sup>3</sup>/<sub>4</sub>"

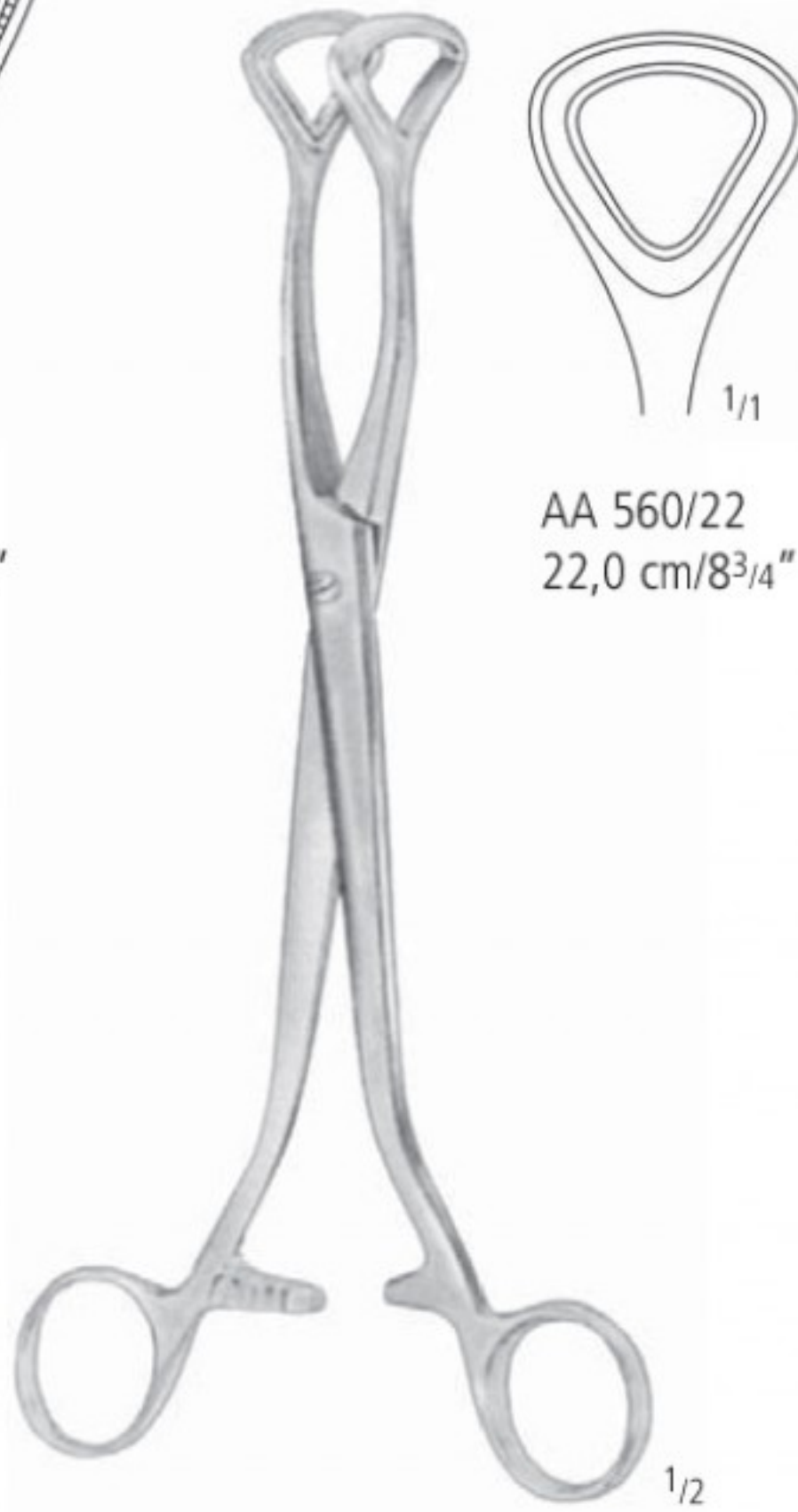

AA 560/22  
 22,0 cm/8<sup>3</sup>/<sub>4</sub>"



AA 560/24  
 24,0 cm/9<sup>1</sup>/<sub>2</sub>"

LUER



KLEMMEN HEMOSTATS PINZAS HEMOSTATICAS PINCES HEMOSTATIQUES PINZE EMOSTATICHE

Peritoneumklemmen  
 Peritoneal Clamp Forceps  
 Pinzas-clamps para peritoneo  
 Pincas-clamps pour le péritoine  
 Pinze per peritoneo

AA

AB

AC

AD

AE

AF

AK

AL

AM

AO

AP

AR

KA

KB

KC

KD

KU

KY

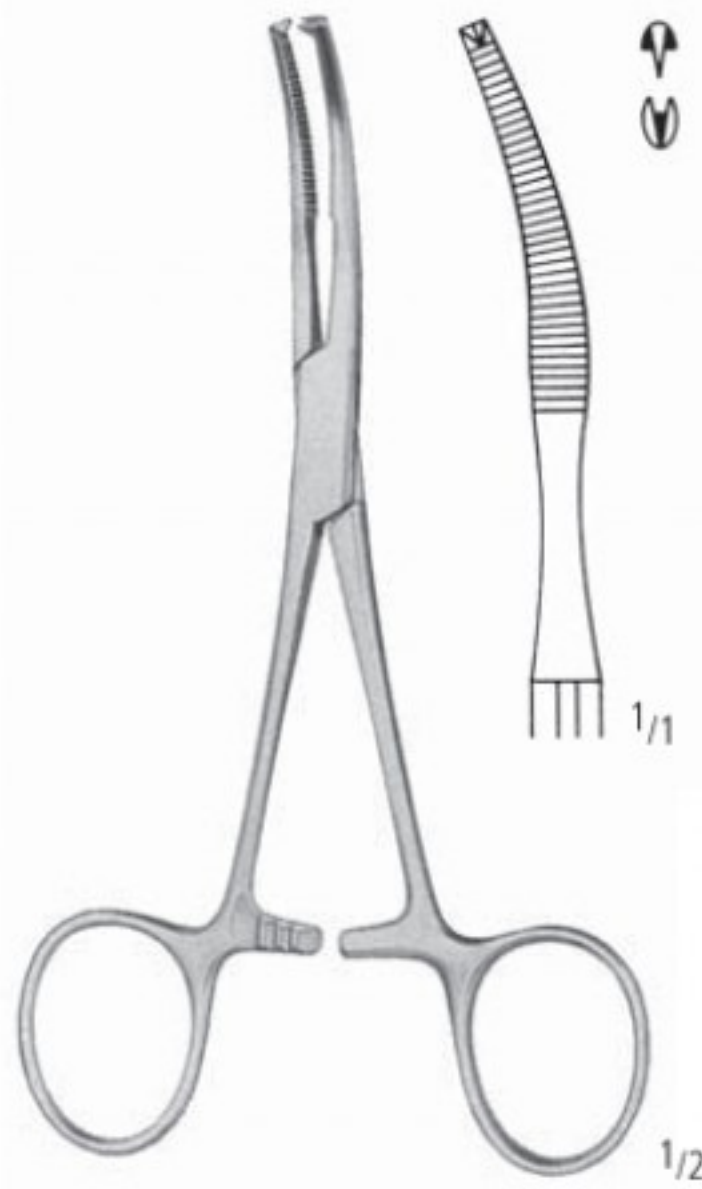

**BABY-MIKULICZ 1:2**  
 AA 601/14  
 14,0 cm/5 1/2"

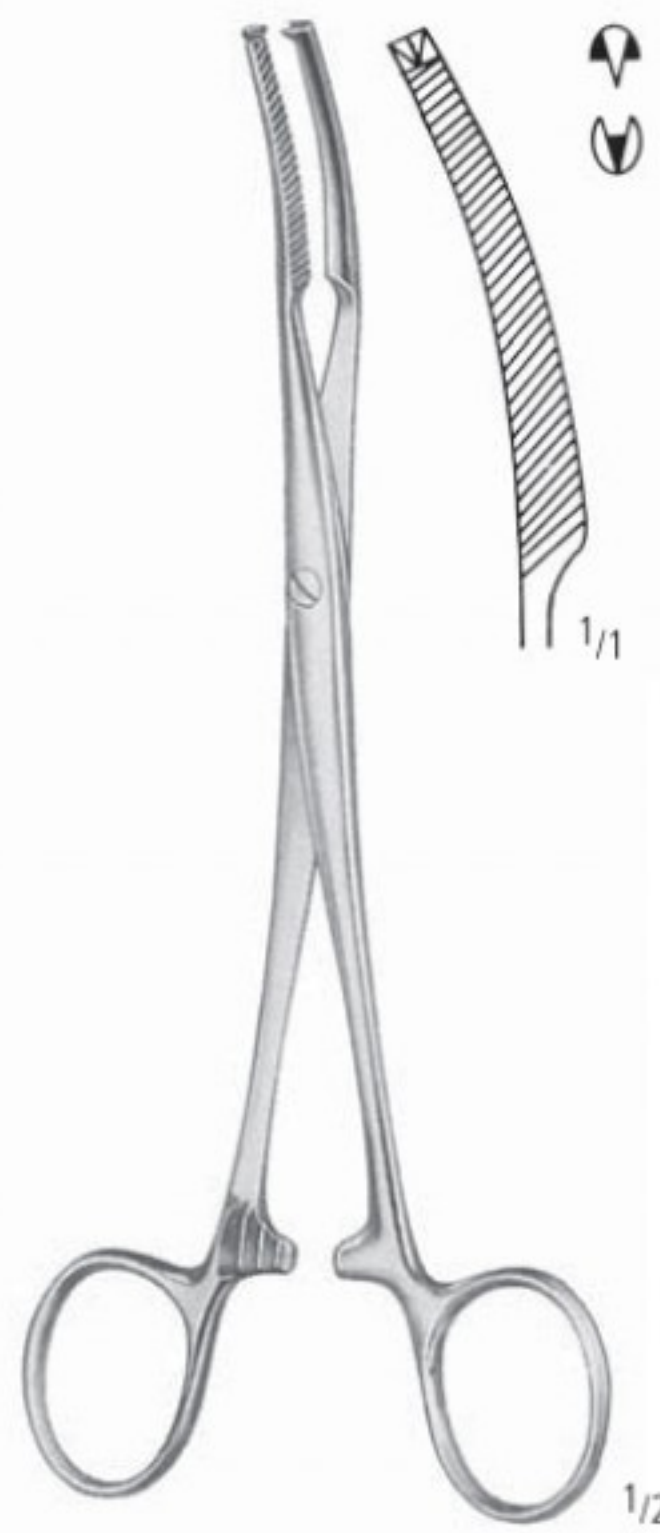

**MIKULICZ 1:2**  
 AA 603/18  
 18,0 cm/7"

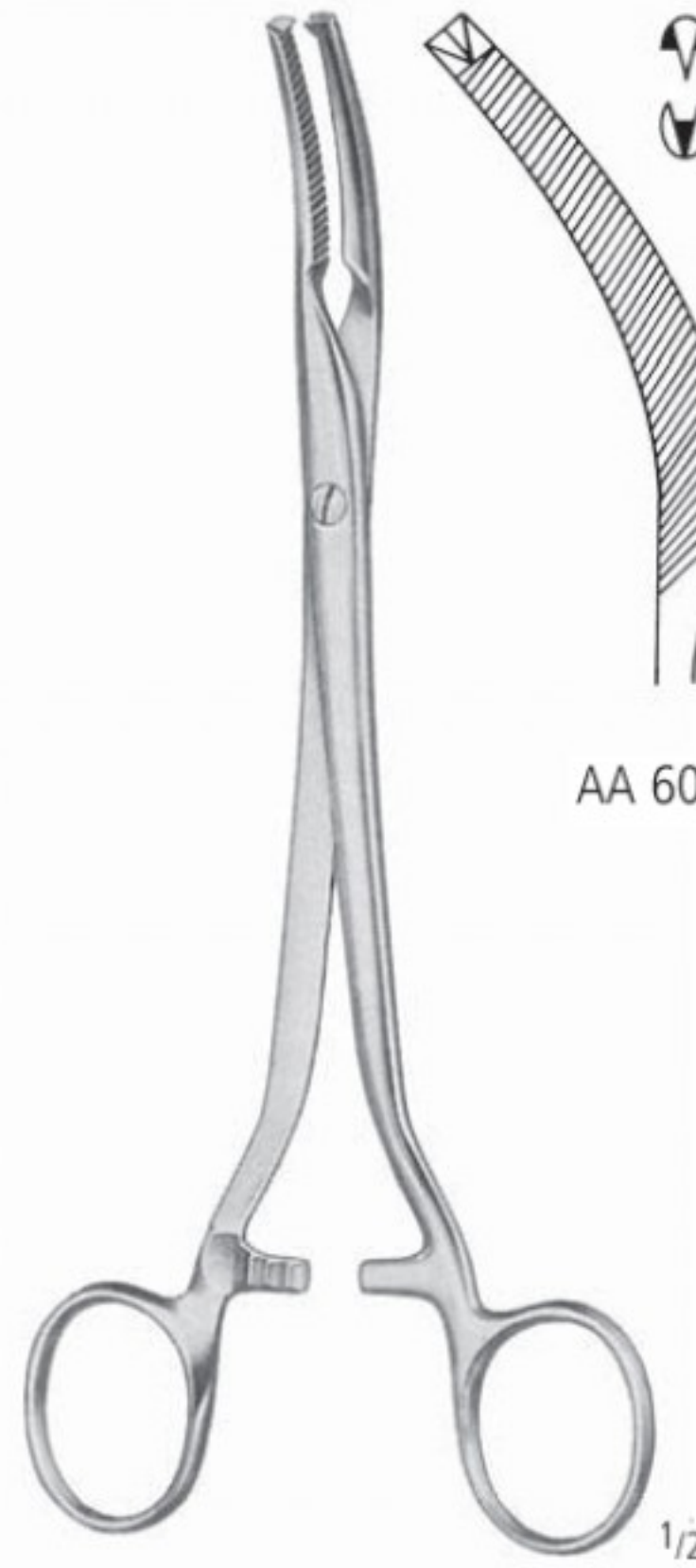

AA 605/20

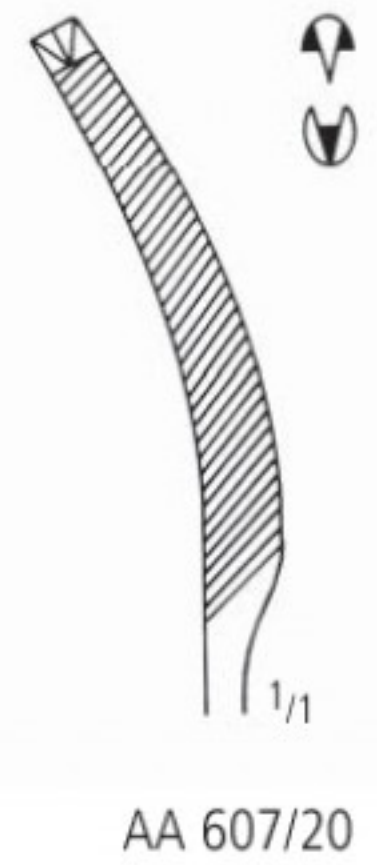

AA 607/20

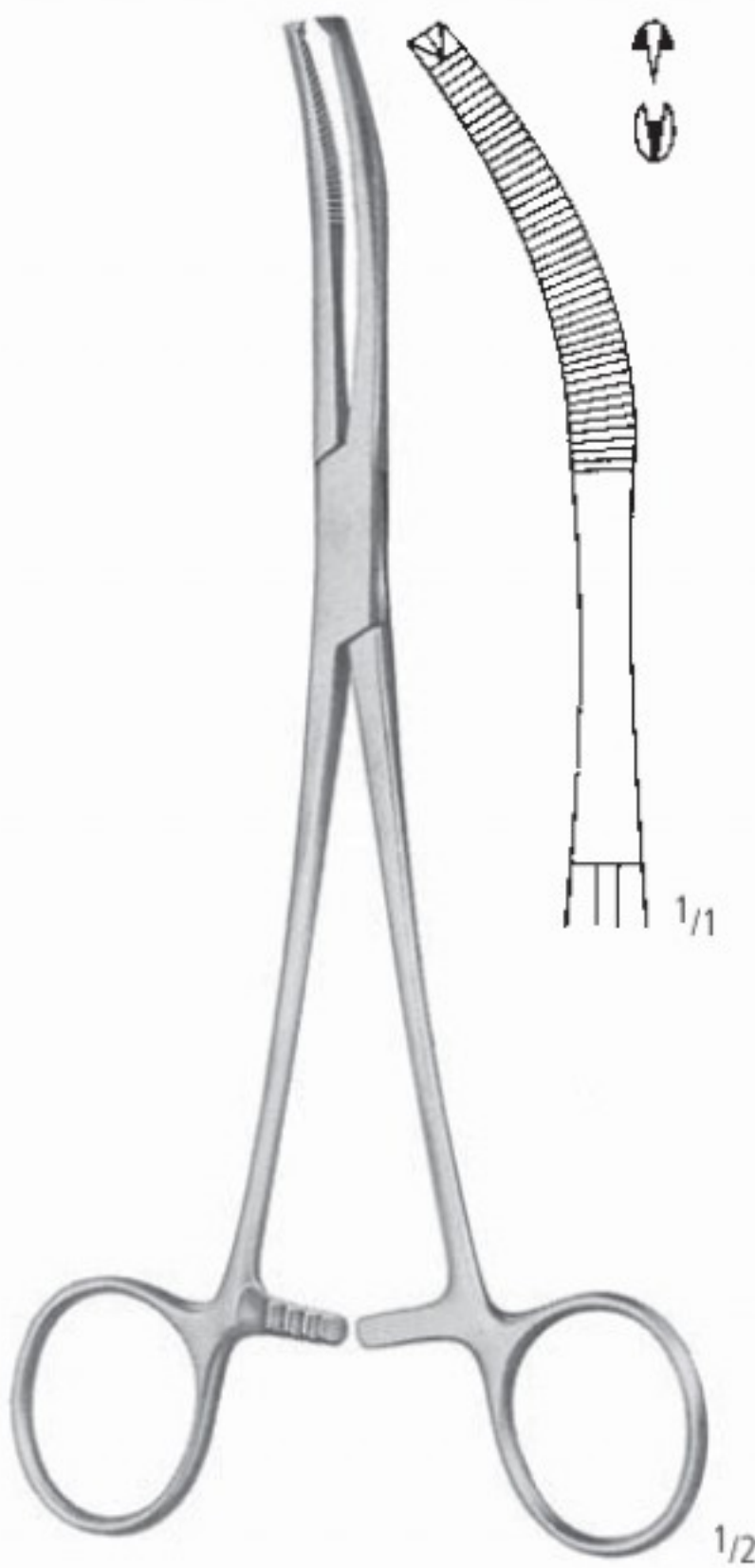

**MIKULICZ 1:2**  
 AA 609/20  
 20,0 cm/8"

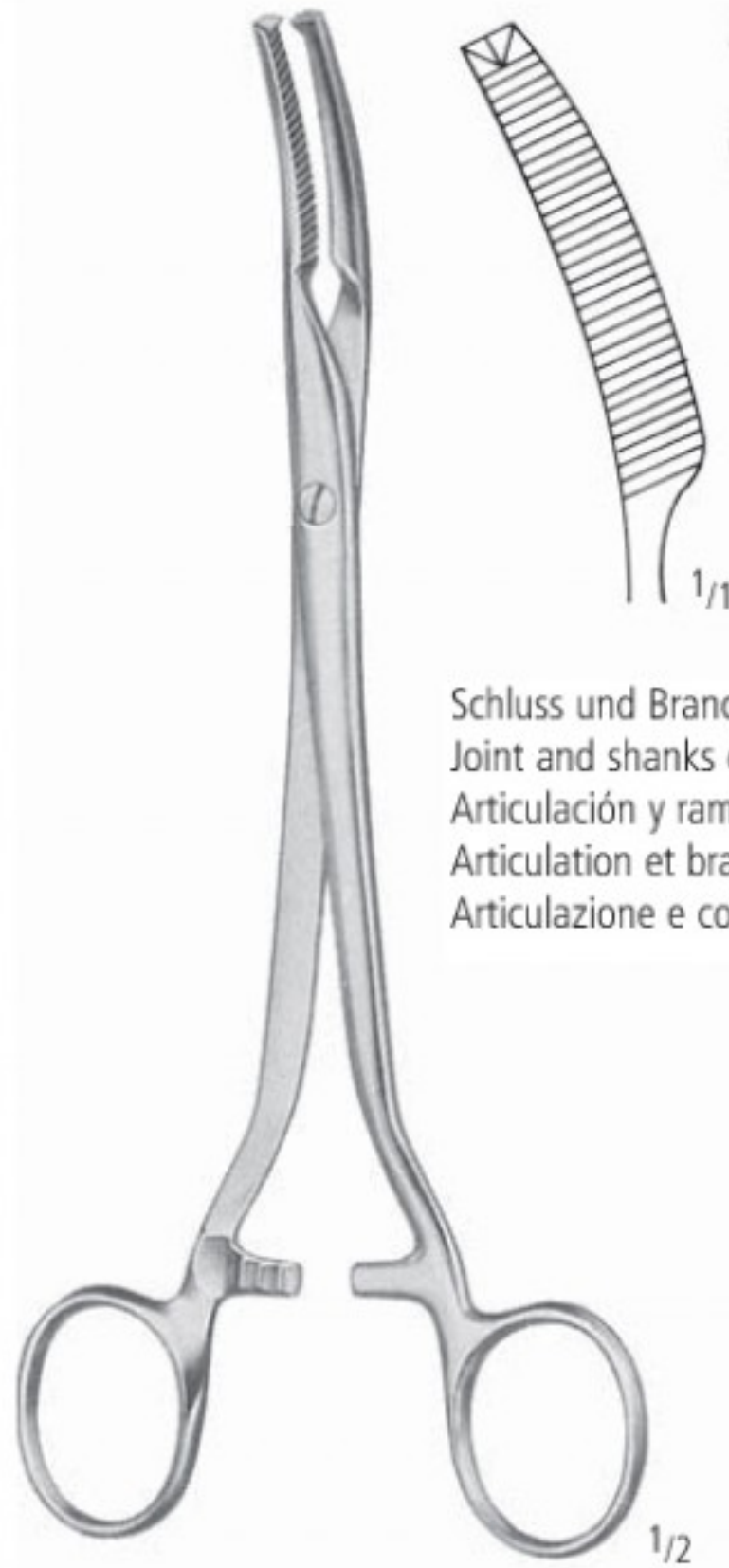

**MIKULICZ 1:2**  
 AA 611/20  
 20,5 cm/8"

Schluss und Branchen extra stark  
 Joint and shanks extra strong  
 Articulación y ramas muy fuerte  
 Articulation et branches très fortes  
 Articolazione e corpo molto robusto

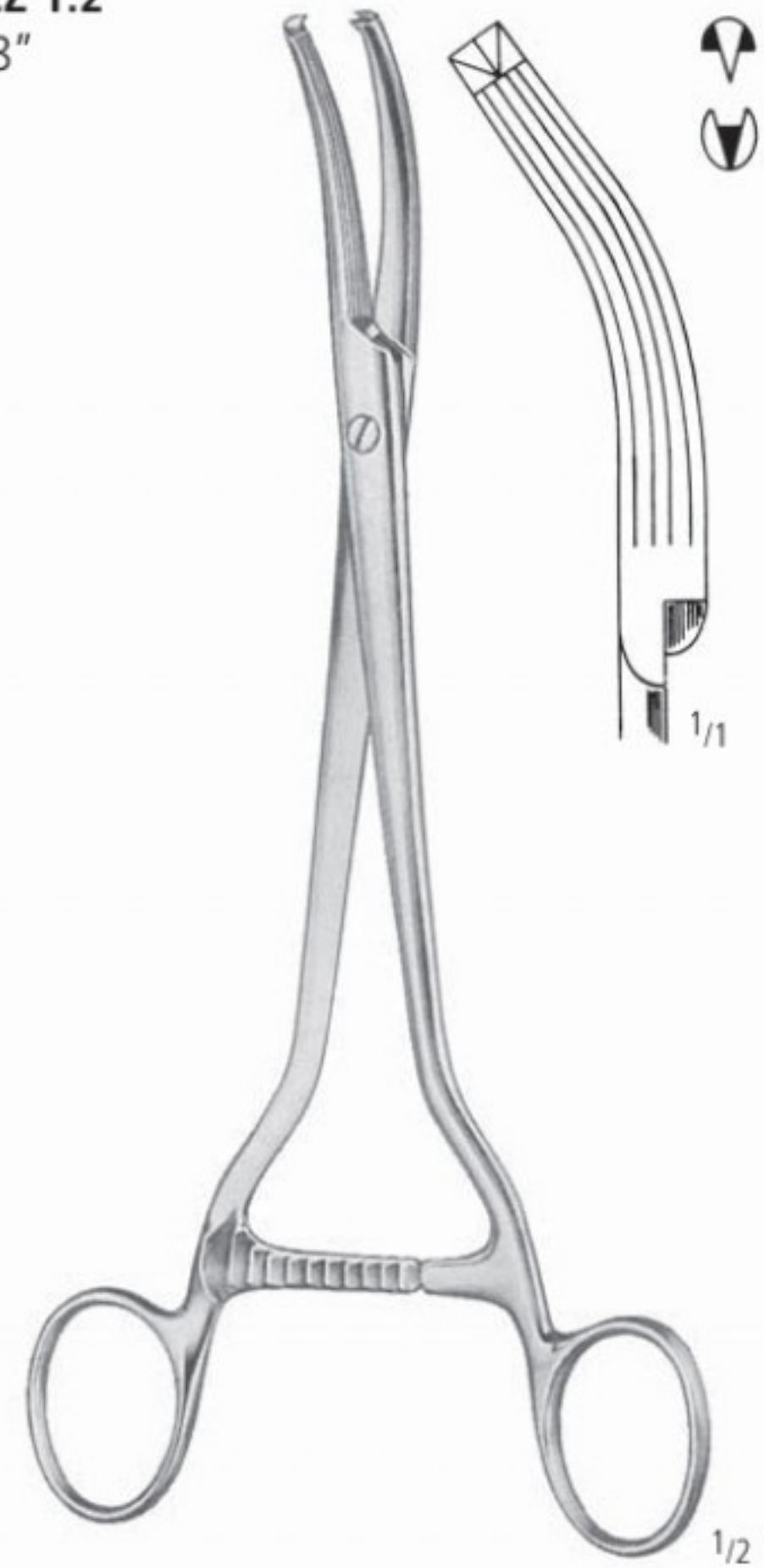

**MIKULICZ 1:2**  
 AA 613/23  
 23,0 cm/9"



Peritoneumklemmen  
 Peritoneal Clamp Forceps  
 Pinzas-clamps para peritoneo  
 Pincas-clamps pour le péritoine  
 Pinze per peritoneo



AA 621/20  
 leicht gebogen  
 slightly curved  
 curva ligeramente  
 courbure légère  
 curva leggera

**FAURE 1:2**  
 20,0 cm/8"

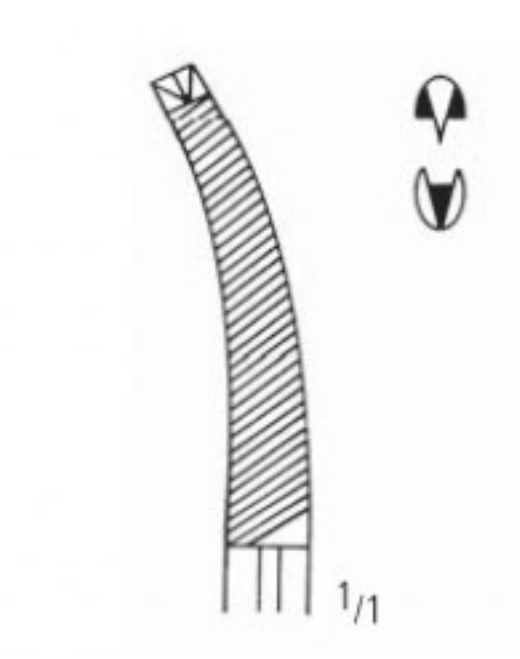

AA 623/20  
 stärker gebogen  
 more curved  
 más curva  
 courbure forte  
 curva forte



**SCHINDLER 1:2**  
 AA 625/20  
 20,0 cm/8"



KLEMMEN HEMOSTATS PINZAS HEMOSTATICAS PINCES HEMOSTATIQUES PINZE EMOSTATICHE

Tuchklemmen  
Towel Forceps  
Pinzas para compresas, Pinzas de campo  
Pinces à champs, Pinces à compresses  
Pinze per fissare le compresse (Fissatele)

AA

AB

AC

AD

AE

AF

AK

AL

AM

AO

AP

AR

KA

KB

KC

KD

KU

KY



**SCHAEDEL**  
AA 710/09  
9,0 cm/3 1/2"



**JONES**  
5,0 cm/2"  
9,0 cm/3 1/2" AA 711/05  
AA 711/09



**ENGL. MODELL**  
AA 717/09  
9,0 cm/3 1/2"



**DOYEN**  
AA 721/18  
18,0 cm/7"



**BERNHARD**  
AA 726/16  
16,5 cm/6 1/2"



**LANE**  
15,0 cm/6"  
18,0 cm/7"  
20,0 cm/8" AA 730/15  
AA 730/18  
AA 730/20



Tuchklemmen  
Towel Forceps  
Pinzas para compresas, Pinzas de campo  
Pinces à champs, Pinces à compresses  
Pinze per fissare le compresse (Fissatele)



AA 749/11

11,0 cm/4<sup>1</sup>/<sub>3</sub>"

- mit Schlauch- oder Kabelhalter
- with clip for tubing or cable
- con porta-tubo o porta-cable
- avec clamp porte-tube ou porte-corton d'alimentation
- con porta tubo o porta cavo

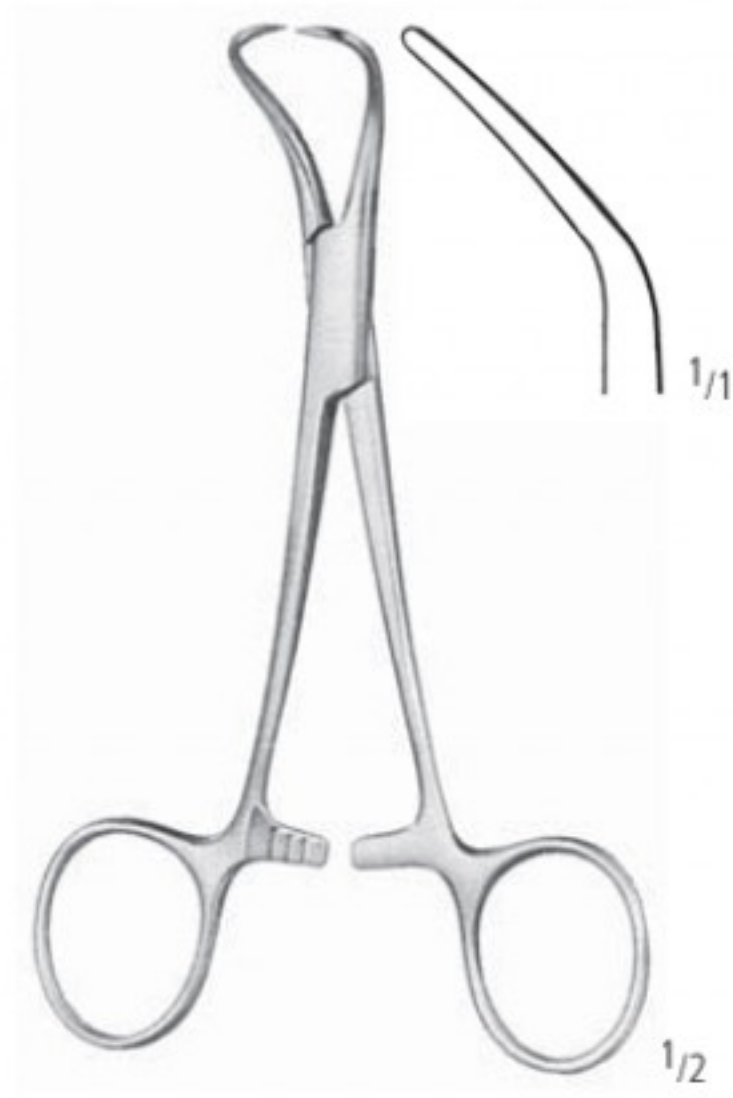

**BACKHAUS**

- |   |           |
|---|-----------|
| 8,0 cm/3"                               | AA 751/08 |
| 11,0 cm/4 <sup>1</sup> / <sub>3</sub> " | AA 751/11 |
| 13,0 cm/5"                              | AA 751/13 |
| 15,0 cm/6"                              | AA 751/15 |



**BALL & SOCKET**

- |   |           |
|---|-----------|
| 11,0 cm/4 <sup>1</sup> / <sub>3</sub> " | AA 753/11 |
| 13,0 cm/5"                              | AA 753/13 |



**ROEDER**

- |            |           |
|------------|-----------|
| 13,0 cm/5" | AA 761/13 |
| 15,0 cm/6" | AA 761/15 |

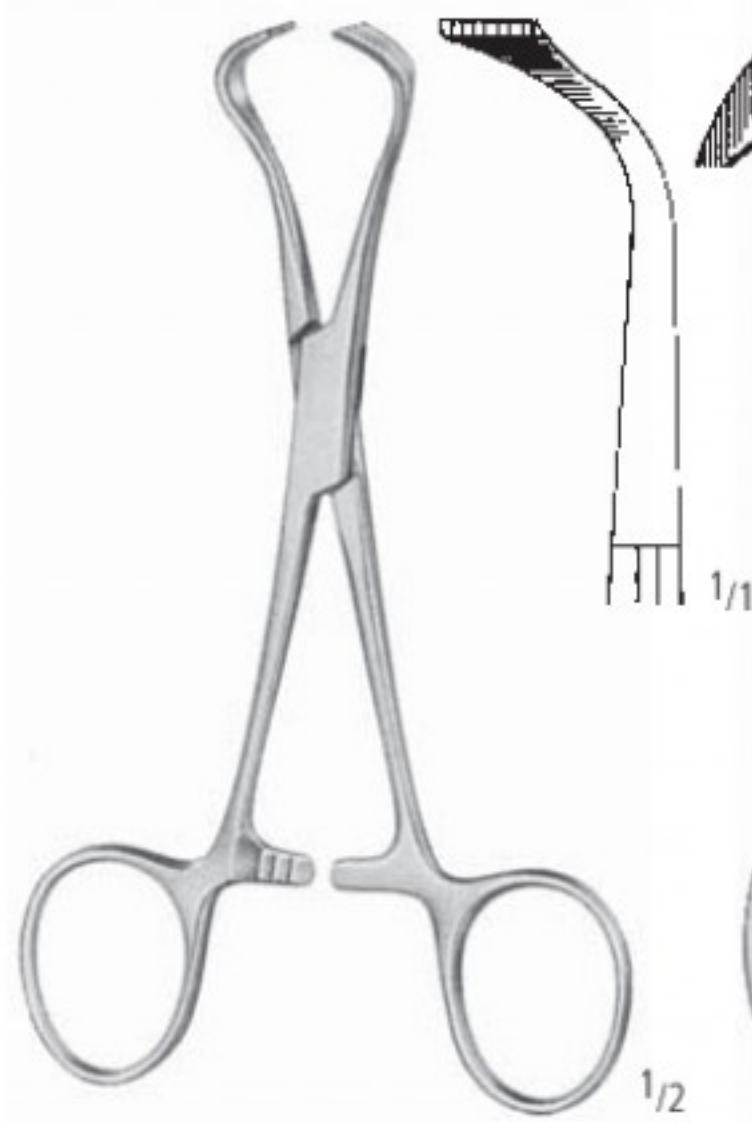

**LORNA**

- |            |           |
|------------|-----------|
| 10,0 cm/4" | AA 763/10 |
| 13,0 cm/5" | AA 763/13 |

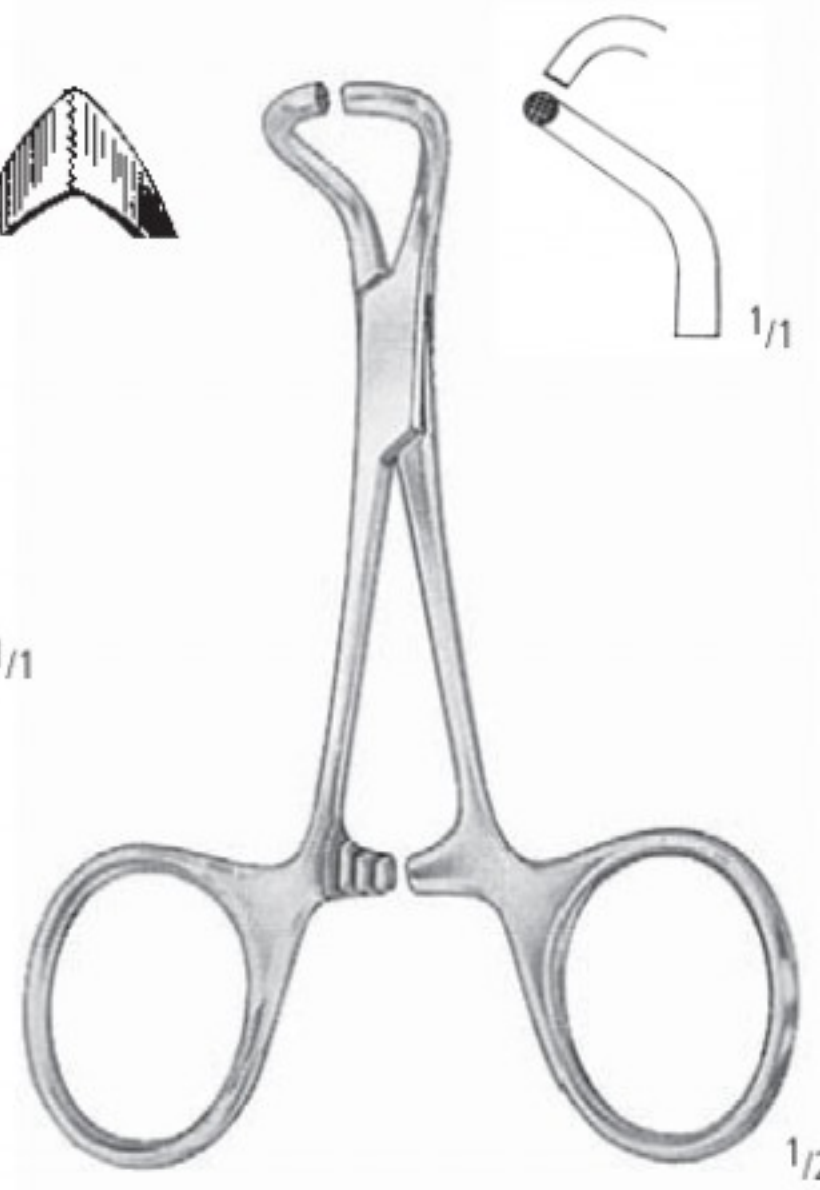

**TOHOKU-JAPAN**

- |            |           |
|------------|-----------|
| 10,0 cm/4" | AA 764/10 |
| 13,0 cm/5" | AA 764/13 |

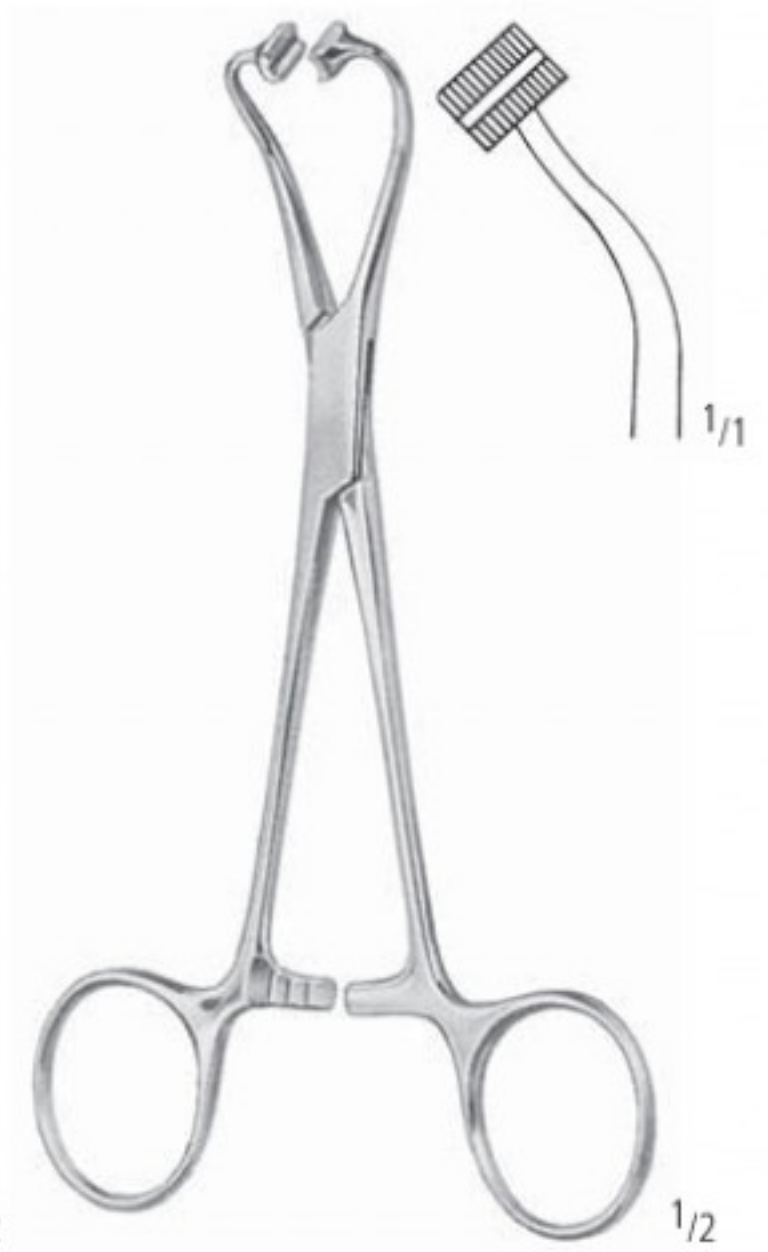

**PEERS**

- |   |
|---|
| AA 765/14                               |
| 14,5 cm/5 <sup>3</sup> / <sub>4</sub> " |

für Papiertücher  
for paper tissues  
para servilletas de papel  
pour serviettes en papier  
per tessuti di carta



KLEMMEN HEMOSTATS PINZAS HEMOSTATICAS PINCES HEMOSTATIQUES PINZE EMOSTATICHE

Schlauchklemmen  
Tubing Clamps  
Pinzas para tubos  
Presses-tube  
Pinze serratubi

AA

AB

AC

AD

AE

AF

AK

AL

AM

AO

AP

AR

KA

KB

KC

KD

KU

KY

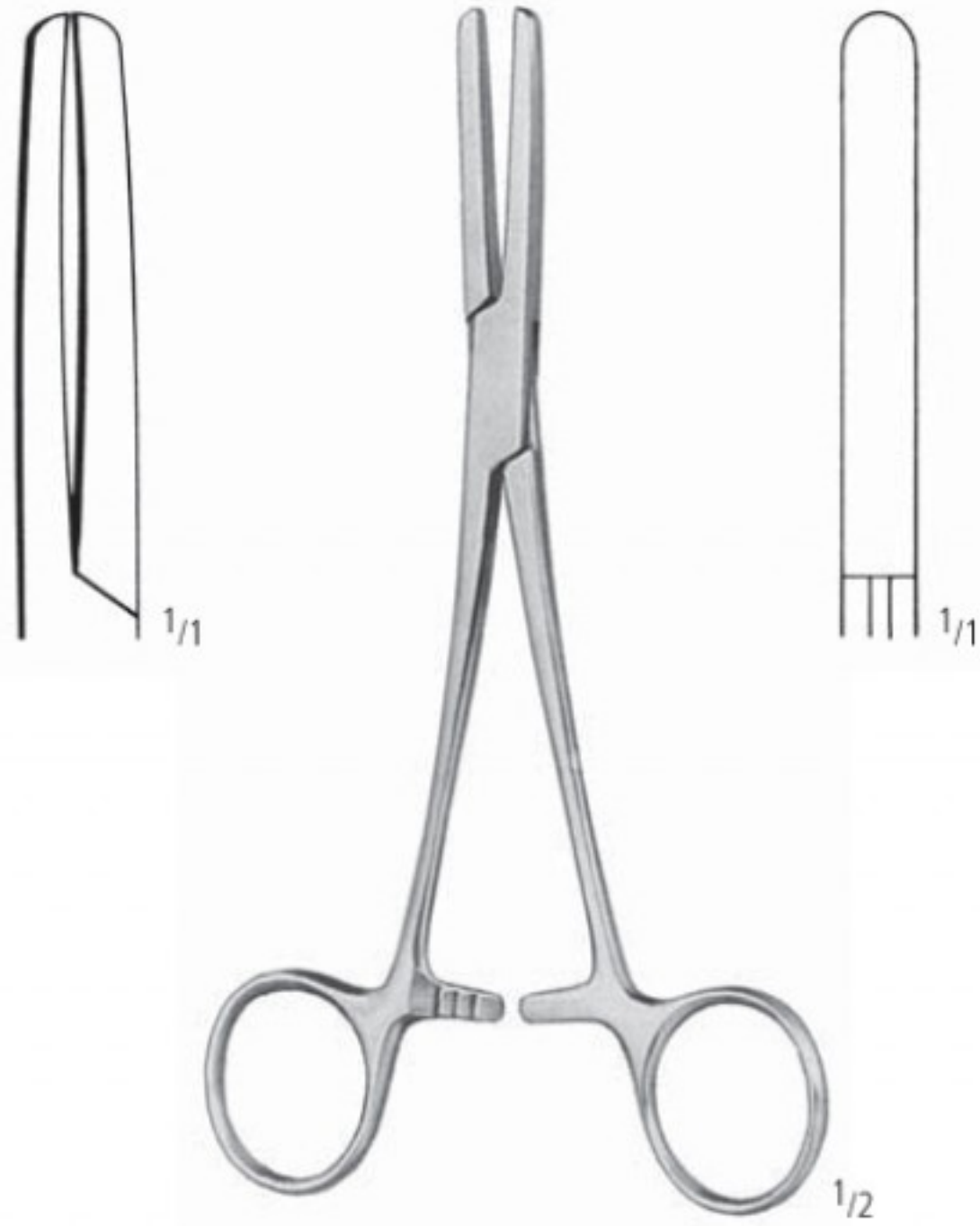

**PRESBYTERIAN**

16,5 cm/6<sup>1</sup>/<sub>2</sub>" AA 790/16  
18,0 cm/7" AA 790/18



**KLINIKUM BERLIN**

AA 792/14  
14,5 cm/5<sup>3</sup>/<sub>4</sub>"  
mit langer Sperre  
with long ratchet  
con cremallera larga  
à crémaillère extra longue  
con cremagliera extra lunga



AA 794/15  
AA 794/18  
AA 794/20

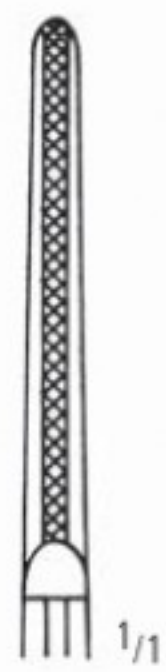

AA 794/15

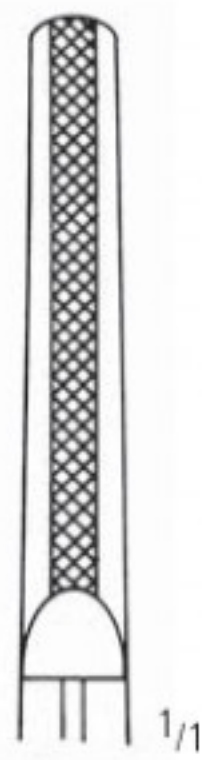

AA 794/18

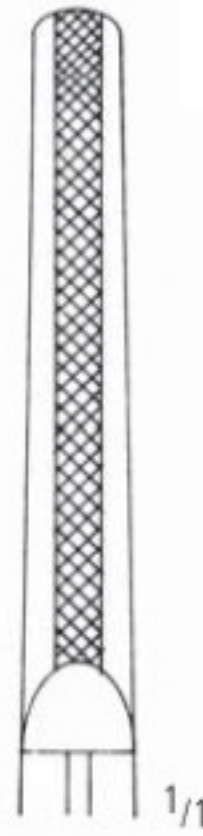

AA 794/20

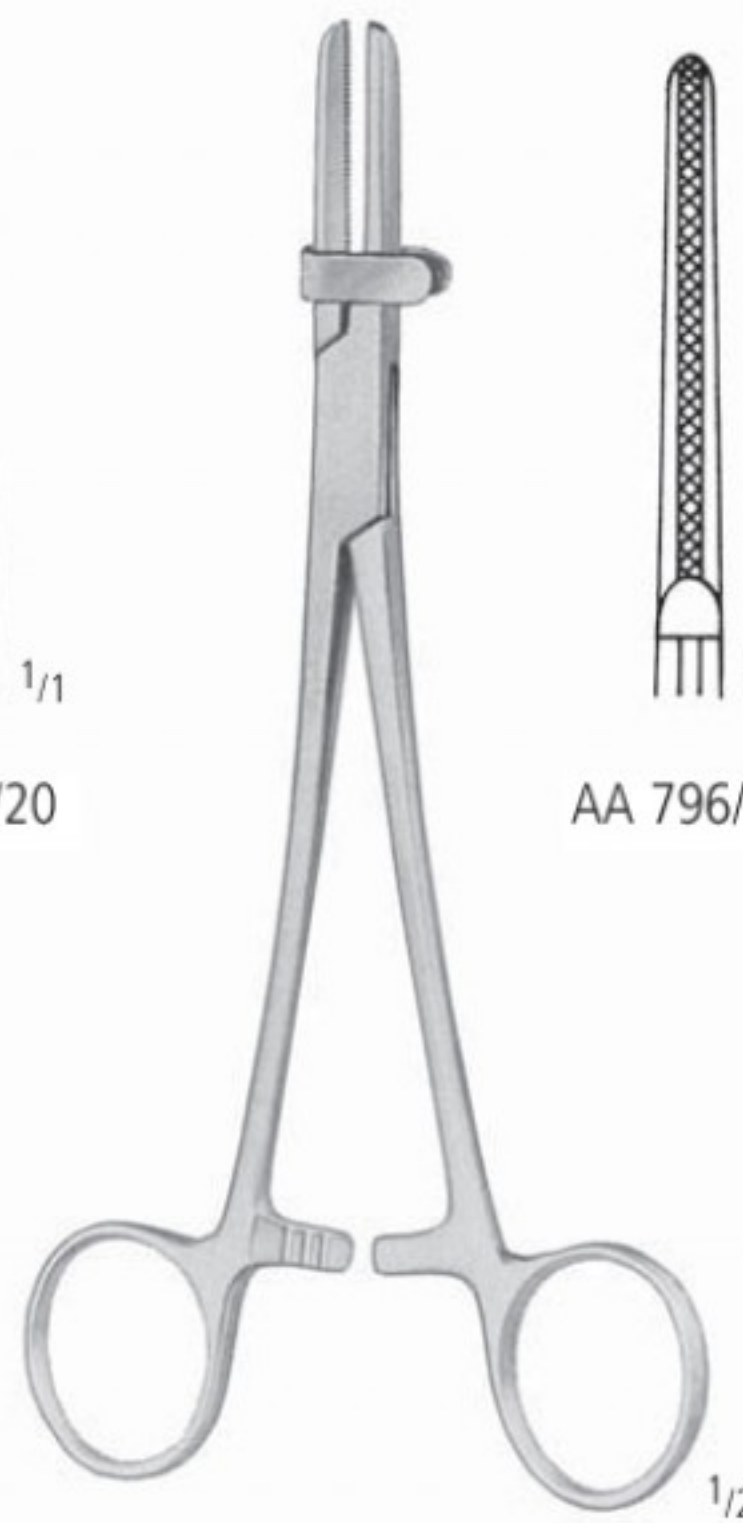

AA 796/15  
AA 796/18  
AA 796/20

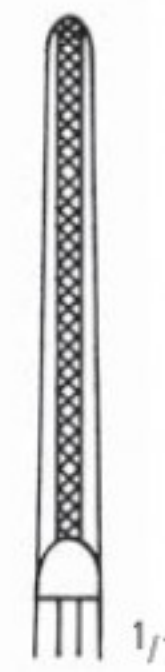

AA 796/15

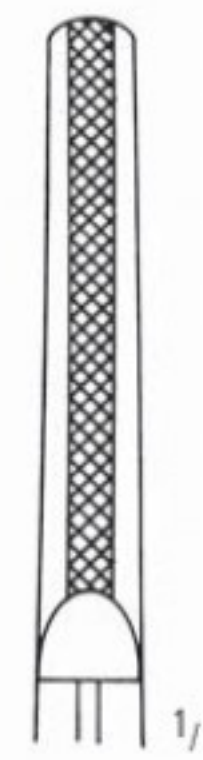

AA 796/18

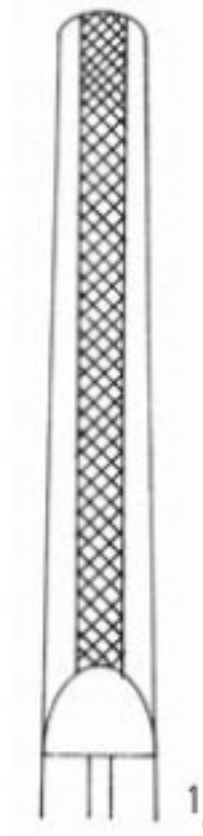

AA 796/20

