PINZETTEN
FORCEPS
PINZAS
PINCES
PINZE

AB

nopa[®] instruments





>> unsere kostenlosen Helfer
bei der Auswahl Ihres
chirurgischen Instrumentariums

>> auch auf CD-ROM

>> our support for your selection of
surgical instruments

>> also available on CD-ROM

nopa[®] instruments



PINZETTEN FORCEPS PINZAS PINCES PINZE

Anatomische Pinzetten, Chirurgische Pinzetten
 Dressing Forceps, Tissue Forceps
 Pinzas de disección, Pinzas de disección con dientes
 Pincés à dissection, Pincés à griffes
 Pinze anatomiche per dissezione, Pinze chirurgiche a denti di topo

AA
AB
 AC
 AD
 AE
 AF
 AK
 AL
 AM
 AO
 AP
 AR
 KA
 KB
 KC
 KD
 KU
 KY



STANDARD

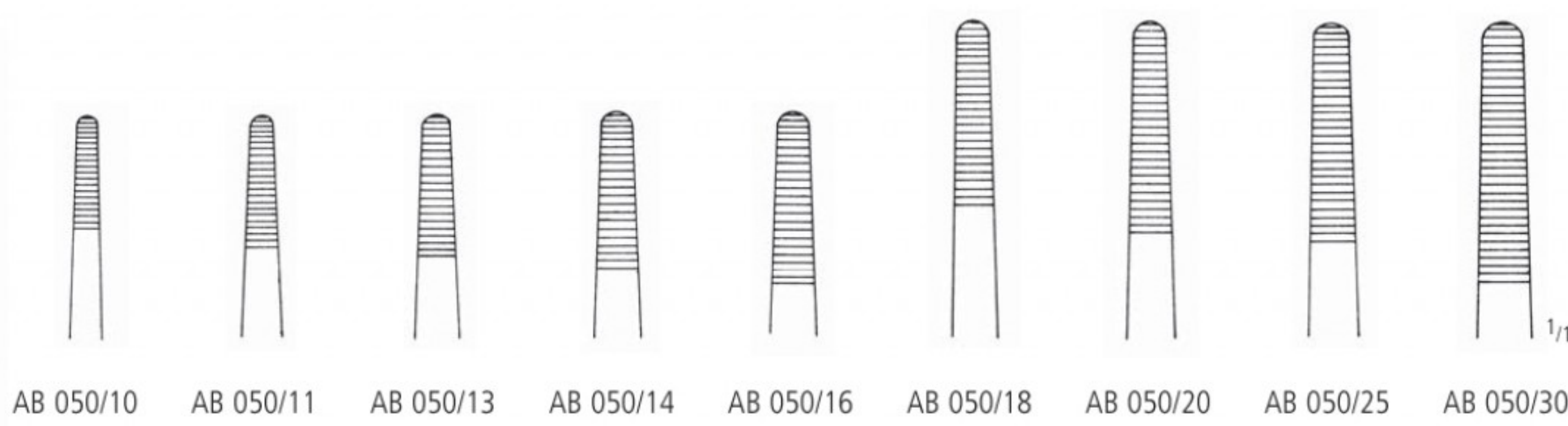

10,5 cm/4 ¹ / ₄ "	AB 050/10
11,5 cm/4 ¹ / ₂ "	AB 050/11
13,0 cm/5"	AB 050/13
14,5 cm/5 ³ / ₄ "	AB 050/14
16,0 cm/6 ¹ / ₄ "	AB 050/16
18,0 cm/7"	AB 050/18
20,0 cm/8"	AB 050/20
25,0 cm/10"	AB 050/25
30,0 cm/12"	AB 050/30



1:2
STANDARD

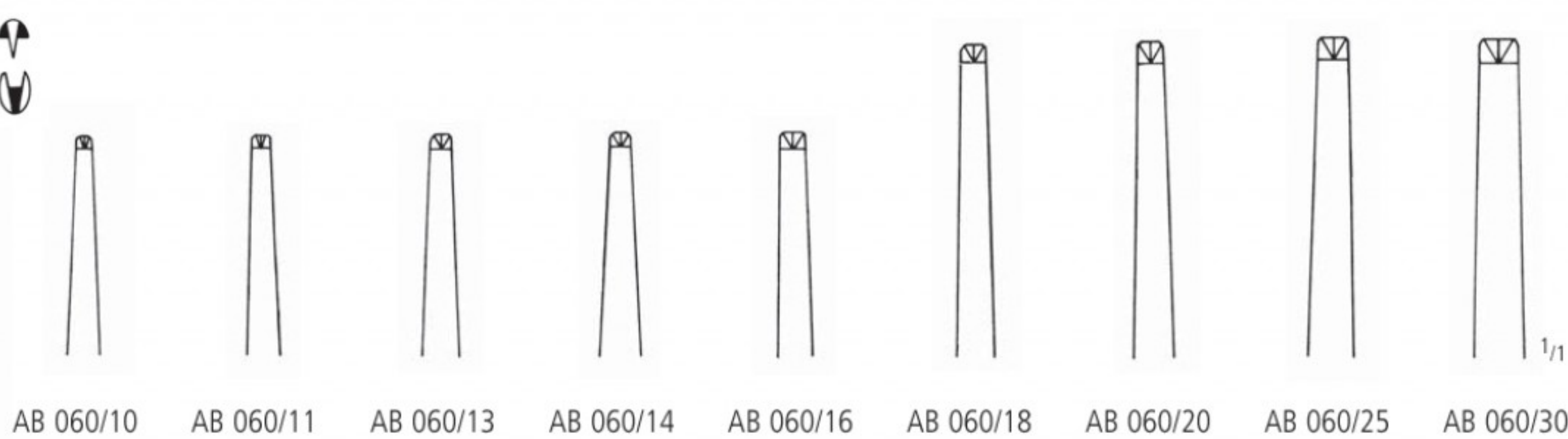

10,5 cm/4 ¹ / ₄ "	AB 060/10
11,5 cm/4 ¹ / ₂ "	AB 060/11
13,0 cm/5"	AB 060/13
14,5 cm/5 ³ / ₄ "	AB 060/14
16,0 cm/6 ¹ / ₄ "	AB 060/16
18,0 cm/7"	AB 060/18
20,0 cm/8"	AB 060/20
25,0 cm/10"	AB 060/25
30,0 cm/12"	AB 060/30

AB PINZETTEN FORCEPS PINZAS PINCES PINZE

Anatomische Pinzetten, Chirurgische Pinzetten
 Dressing Forceps, Tissue Forceps
 Pinzas de disección, Pinzas de disección con dientes
 Pincers à dissection, Pincers à griffes
 Pinze anatomiche per dissezione, Pinze chirurgiche a denti di topo



AB 062/14



AB 064/14

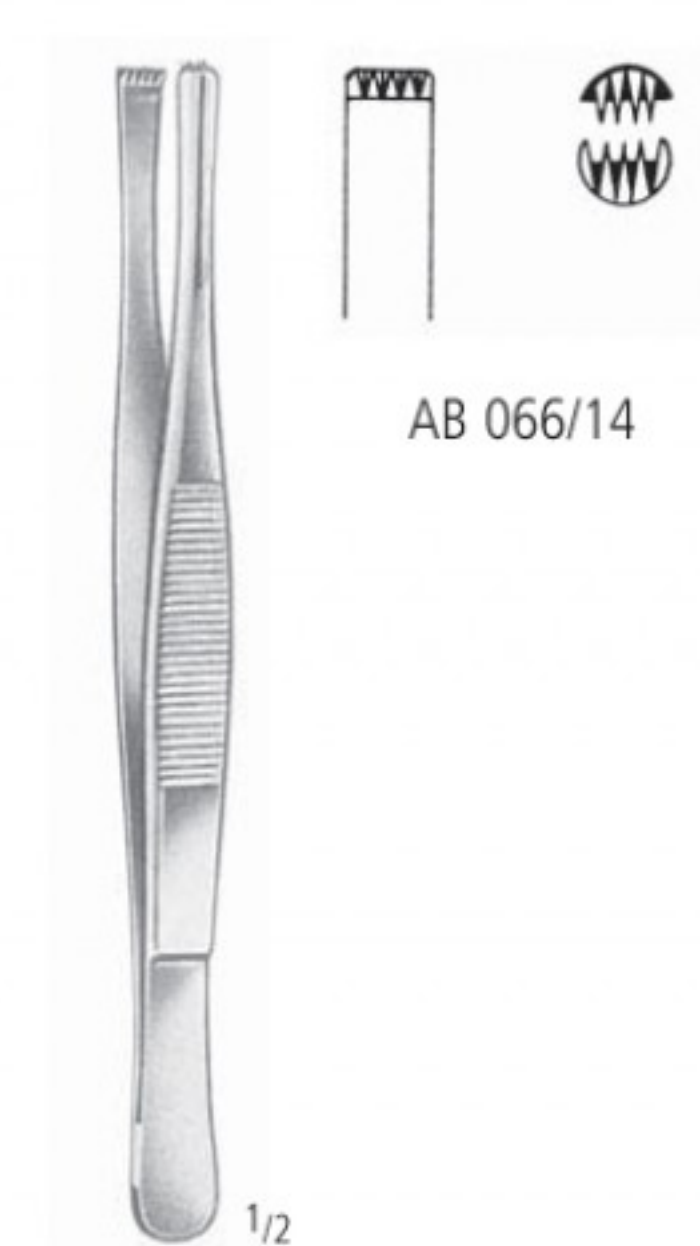

AB 066/14

2:3

3:4

4:5

- 13,0 cm/5" AB 062/13
- 14,5 cm/5³/₄" AB 062/14
- 16,0 cm/6¹/₄" AB 062/16
- 18,0 cm/7" AB 062/18
- 20,0 cm/8" AB 062/20
- 25,0 cm/10" AB 062/25
- 30,0 cm/12" AB 062/30

- AB 064/13
- AB 064/14
- AB 064/16

- AB 066/13
- AB 066/14
- AB 066/16

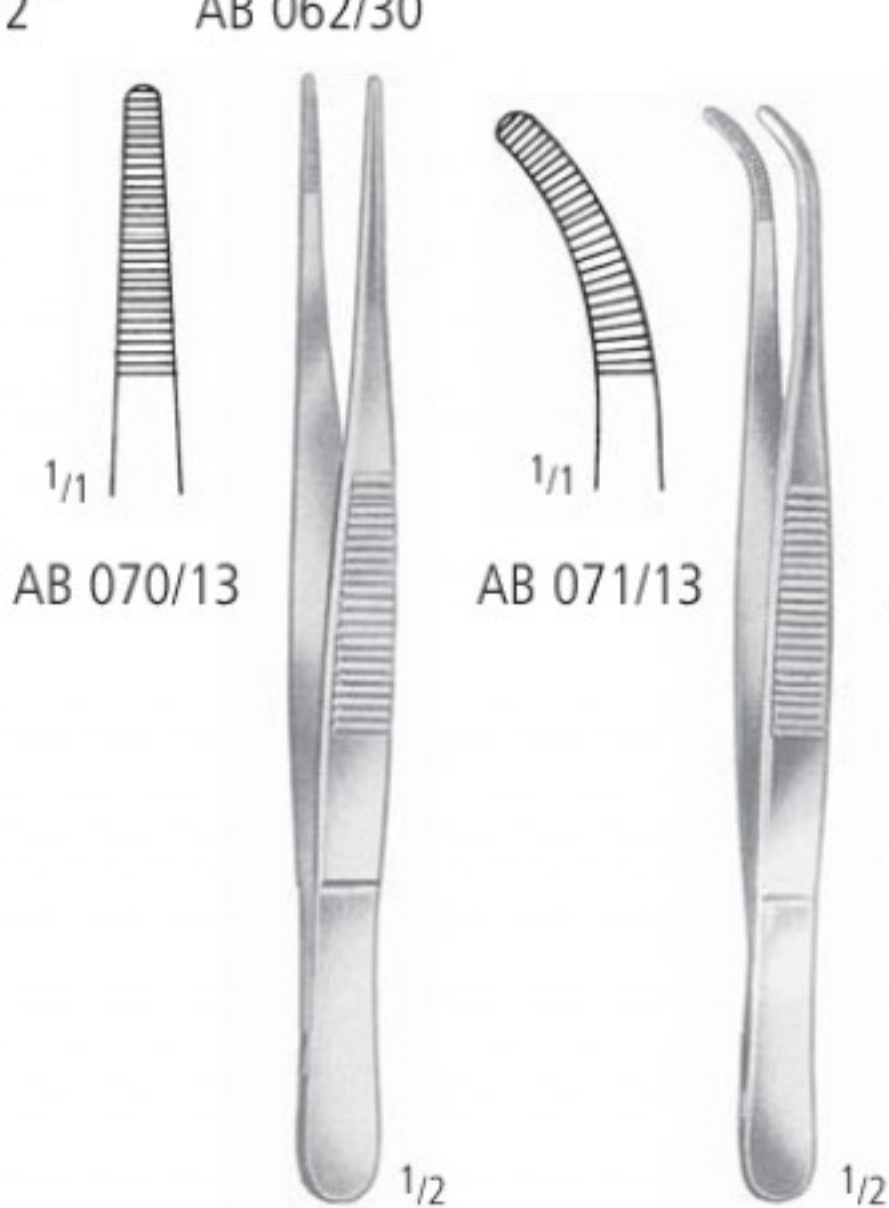

AB 070/13

AB 071/13

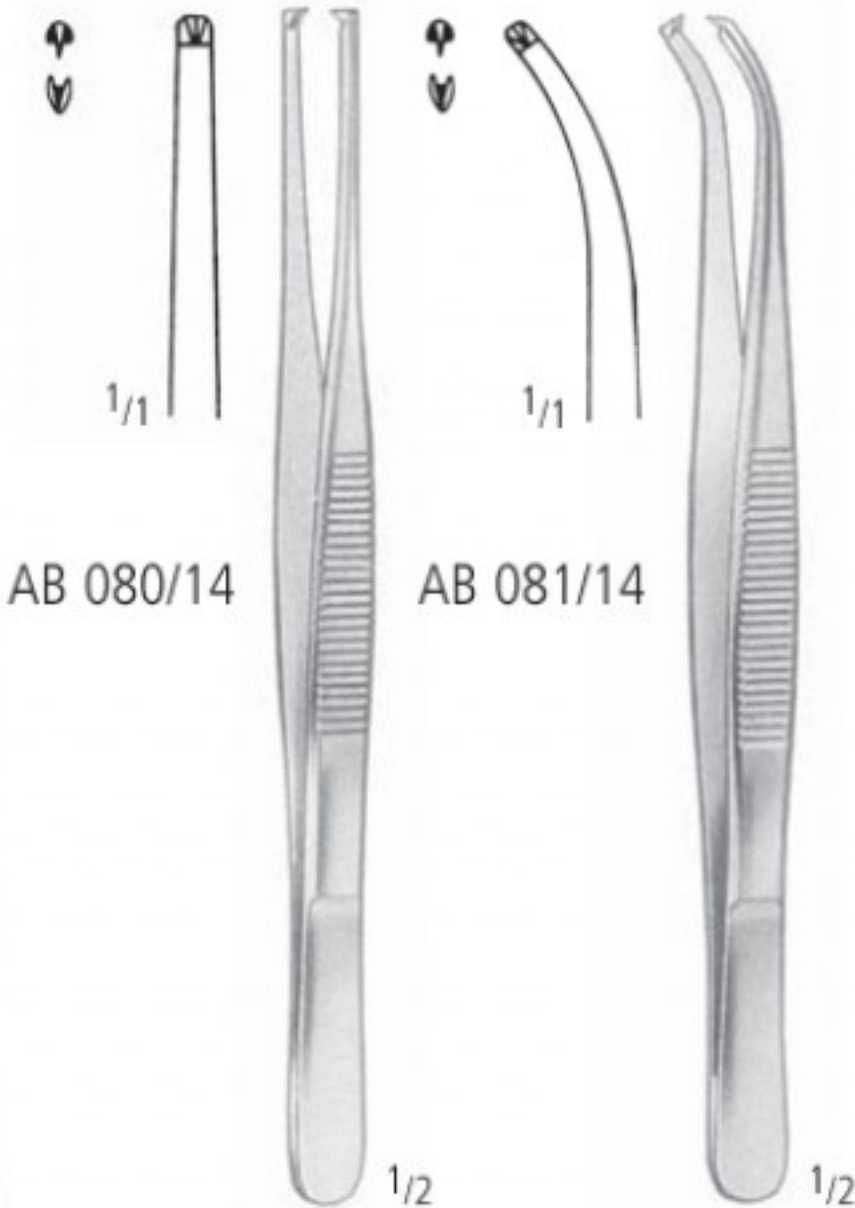

AB 080/14

AB 081/14

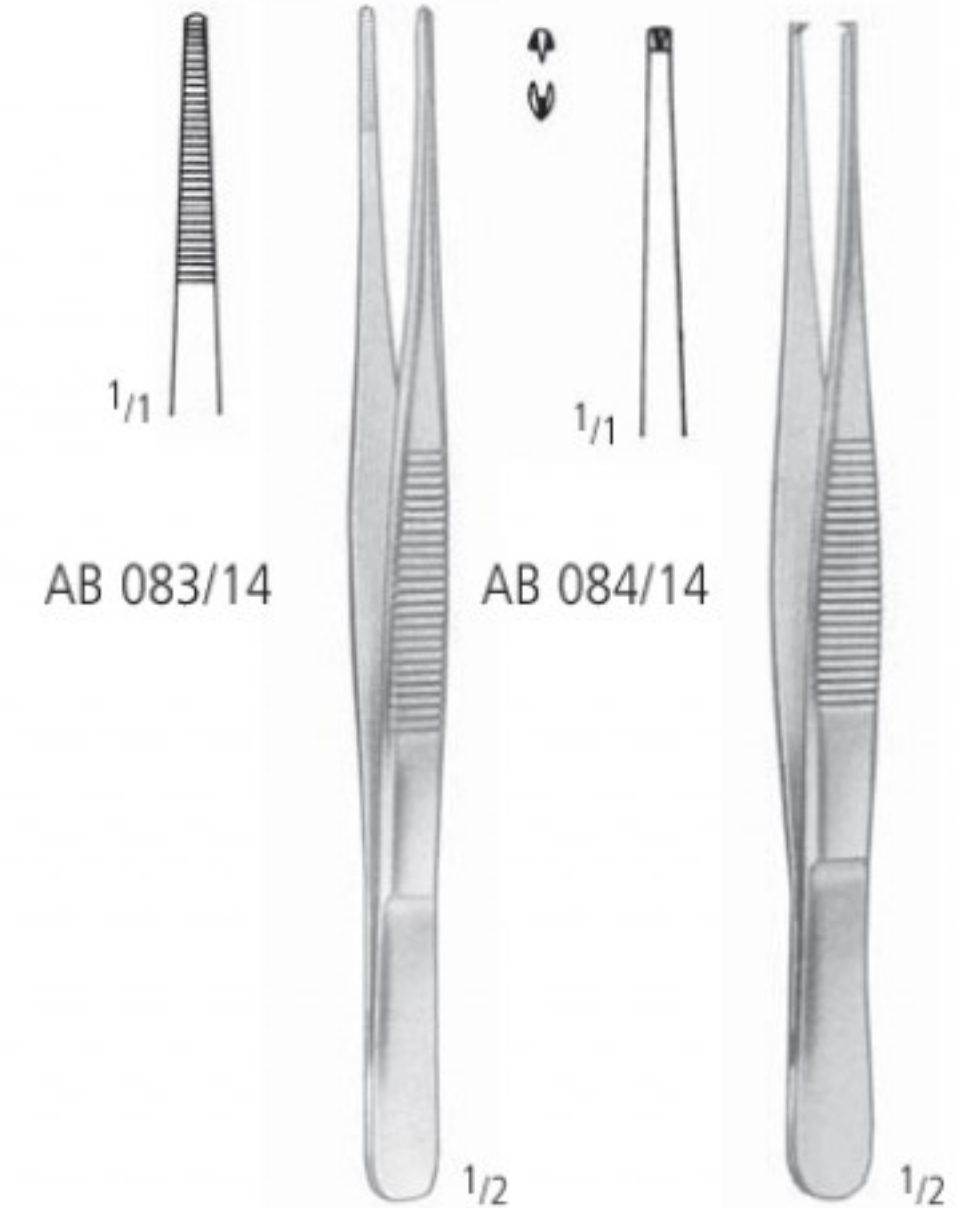

AB 083/14

AB 084/14

1:2

1:2

1:2

schmal - narrow - estrechas - étroites - strette

fein - delicate - finas - fines - fine

10,5 cm/4 ¹ / ₄ "	AB 070/10	AB 071/10	AB 080/10	AB 081/10
11,5 cm/4 ¹ / ₂ "	AB 070/11	AB 071/11	AB 080/11	AB 081/11
13,0 cm/5"	AB 070/13	AB 071/13	AB 080/13	AB 081/13
14,5 cm/5 ³ / ₄ "	AB 070/14	AB 071/14	AB 080/14	AB 081/14
16,0 cm/6 ¹ / ₄ "	AB 070/16	AB 071/16	AB 080/16	AB 081/16
18,0 cm/7"	AB 070/18	AB 071/18	AB 080/18	AB 081/18
20,0 cm/8"	AB 070/20	AB 071/20	AB 080/20	AB 081/20
23,0 cm/9"	AB 070/23		AB 080/23	
25,0 cm/10"	AB 070/25	AB 071/25	AB 080/25	AB 081/25
30,0 cm/12"	AB 070/30	AB 071/30	AB 080/30	AB 081/30

AB 083/13	AB 084/13
AB 083/14	AB 084/14

PINZETTEN FORCEPS PINZAS PINCES PINZE

Anatomische Pinzetten, Chirurgische Pinzetten
 Dressing Forceps, Tissue Forceps
 Pinzas de disección, Pinzas de disección con dientes
 Pincès à dissection, Pincès à griffes
 Pinze anatomiche per dissezione, Pinze chirurgiche a denti di topo

MODELL USA

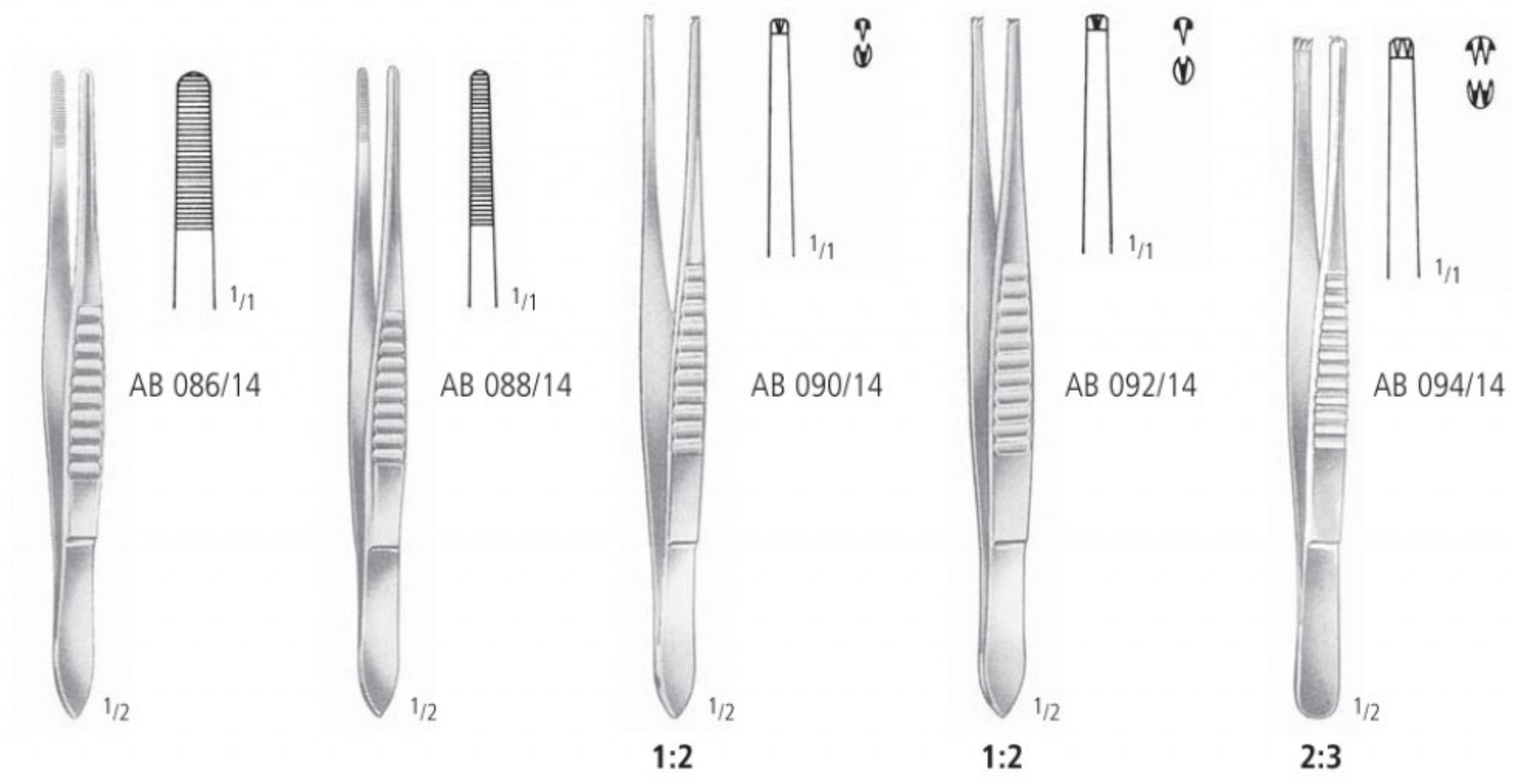

schmal - narrow - estrechas - étroites - strette

12,0 cm/4 ³ / ₄ "	AB 086/12	AB 088/12		AB 092/12	AB 094/12
13,0 cm/5"	AB 086/13	AB 088/13	AB 090/13	AB 092/13	AB 094/13
14,5 cm/5 ³ / ₄ "	AB 086/14	AB 088/14	AB 090/14	AB 092/14	AB 094/14
15,5 cm/6"	AB 086/15	AB 088/15	AB 090/15	AB 092/15	AB 094/15
18,0 cm/7"	AB 086/18			AB 092/18	AB 094/18
21,0 cm/8 ¹ / ₄ "	AB 086/21			AB 092/21	AB 094/21
25,0 cm/10"	AB 086/25			AB 092/25	AB 094/25
31,0 cm/12 ¹ / ₄ "	AB 086/31			AB 092/31	AB 094/31

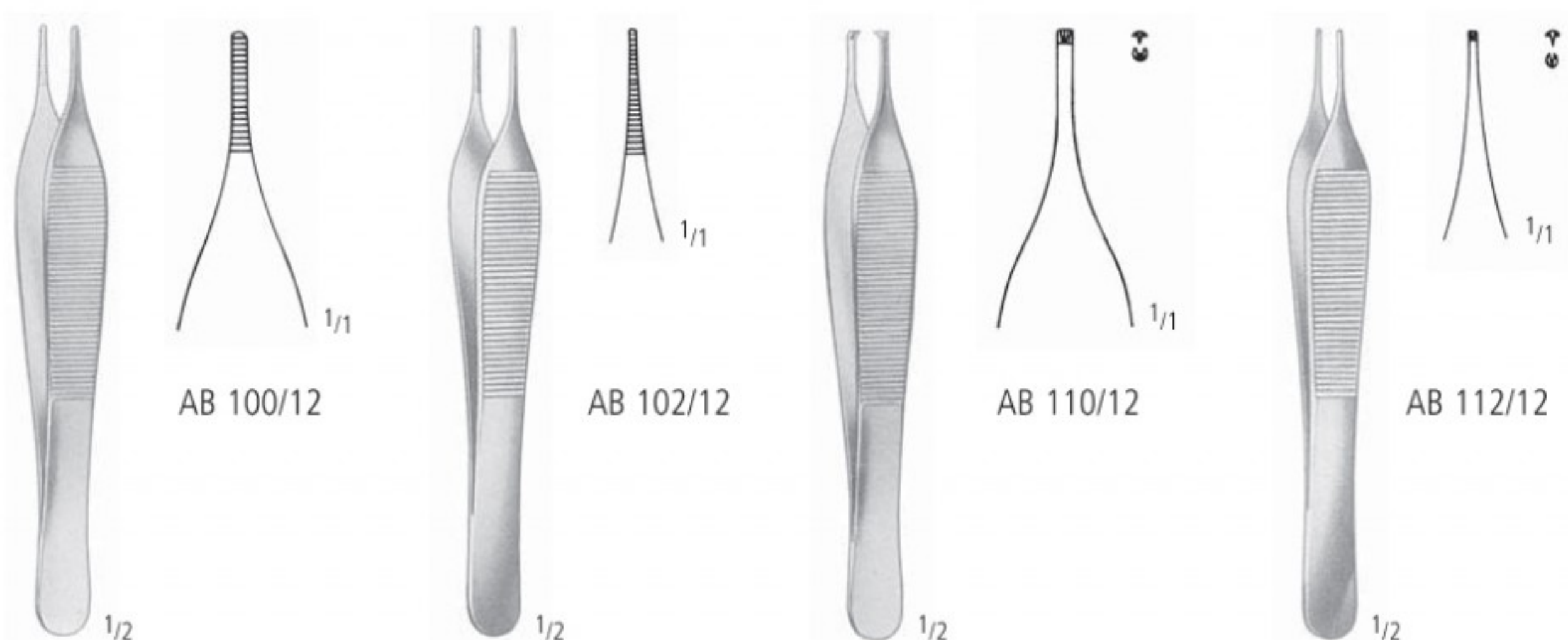

12,0 cm/4 ³ / ₄ "	ADSON AB 100/12	MICRO-ADSON AB 102/12	ADSON 1:2 AB 110/12	MICRO-ADSON 1:2 AB 112/12
15,0 cm/6"	AB 100/15	AB 102/15	AB 110/15	AB 112/15

AA
AB
 AC
 AD
 AE
 AF
 AG
 AH
 AI
 AJ
 AK
 AL
 AM
 AN
 AO
 AP
 AQ
 AR
 AS
 AT
 AU
 AV
 AW
 AX
 AY
 AZ

AB PINZETTEN FORCEPS PINZAS PINCES PINZE

Anatomische Pinzetten, Chirurgische Pinzetten
 Dressing Forceps, Tissue Forceps
 Pinzas de disección, Pinzas de disección con dientes
 Pincès à dissection, Pincès à griffes
 Pinze anatomiche per dissezione, Pinze chirurgiche a denti di topo

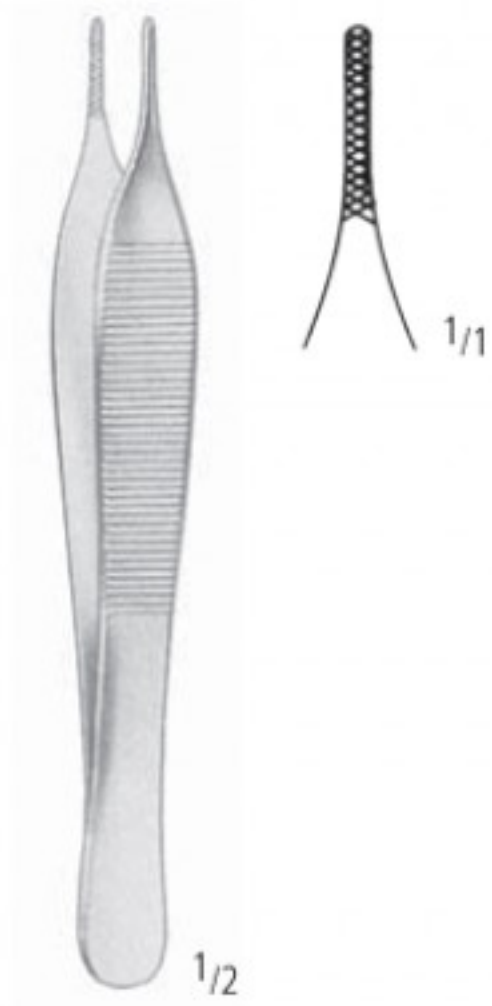

ADSON
 AB 114/12
 12,0 cm/4³/₄"

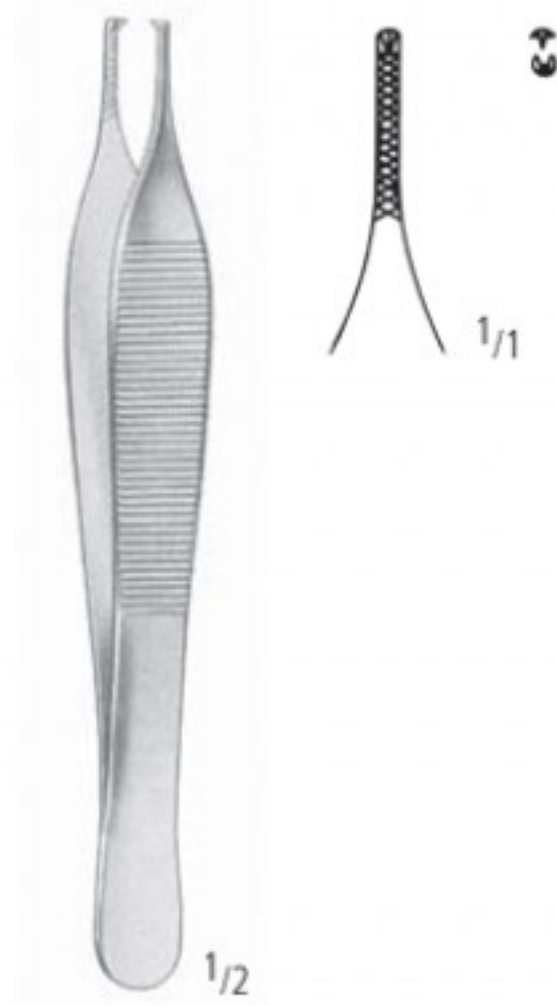

ADSON 1:2
 AB 115/12
 12,0 cm/4³/₄"

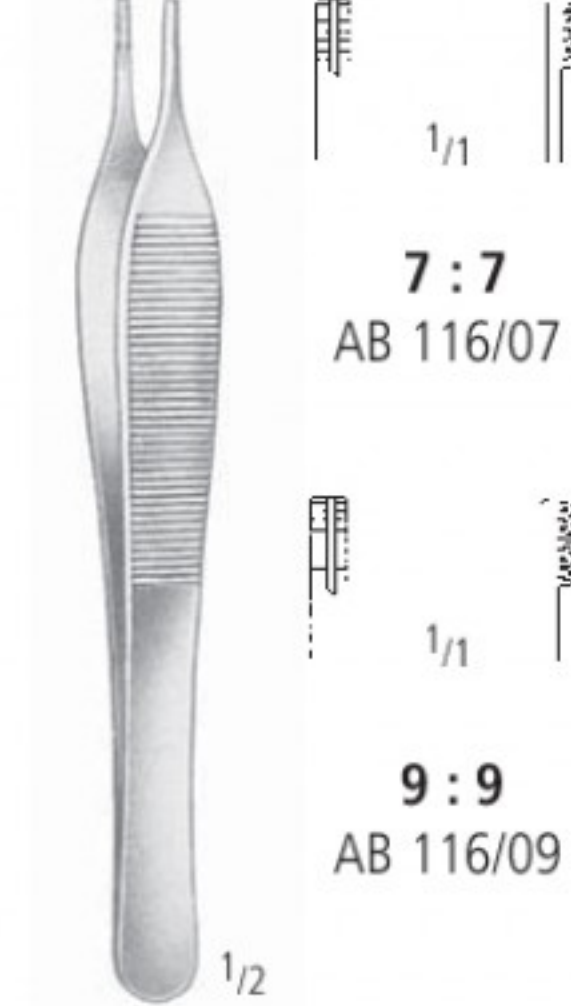

ADSON-BROWN
 12,0 cm/4³/₄"



ADSON-BROWN
 AB 117/09
 12,0 cm/4³/₄"

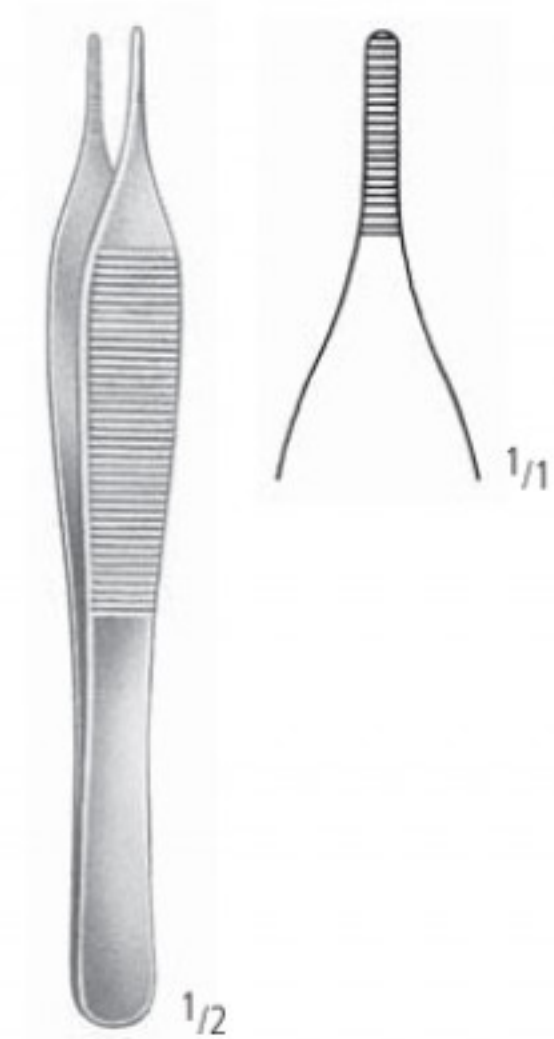

EWALD
 AB 118/01
 12,0 cm/4³/₄"

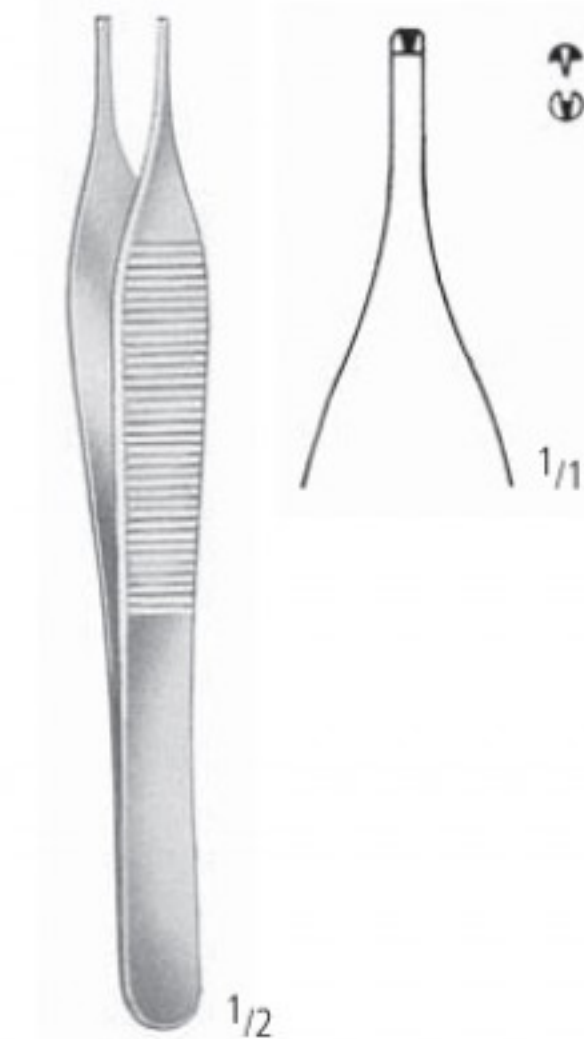

EWALD 1:2
 AB 118/02
 12,0 cm/4³/₄"



McINDOE
 AB 119/15
 15,0 cm/6"



SEMKEN
 AB 120/12
 AB 120/15

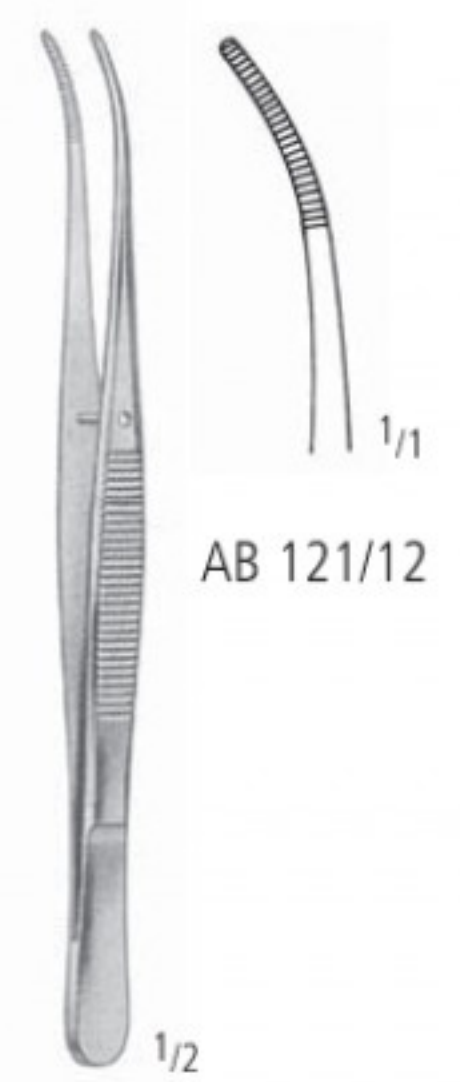

SEMKEN
 12,5 cm/5"
 15,5 cm/6"
 AB 121/12
 AB 121/15

PINZETTEN FORCEPS PINZAS PINCES PINZE

Anatomische Pinzetten, Chirurgische Pinzetten
 Dressing Forceps, Tissue Forceps
 Pinzas de disección, Pinzas de disección con dientes
 Pincés à dissection, Pincés à griffes
 Pinze anatomiche per dissezione, Pinze chirurgiche a denti di topo

AA

AB

AC

AD

AE

AF

AK

AL

AM

AO

AP

AR

KA

KB

KC

KD

KU

KY

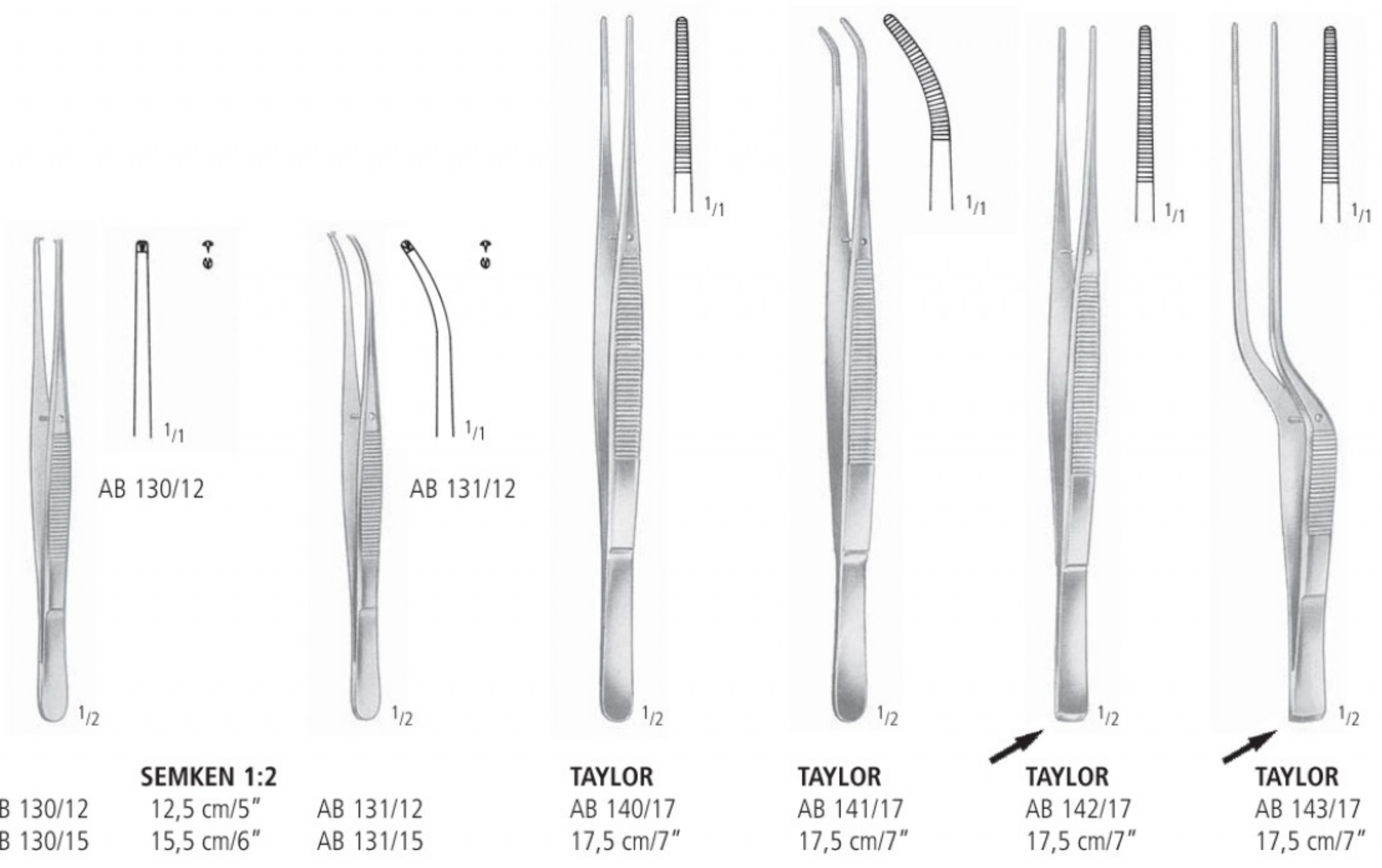

AB 130/12
AB 130/15

SEMKEN 1:2
12,5 cm/5"
15,5 cm/6"

AB 131/12
AB 131/15

TAYLOR
AB 140/17
17,5 cm/7"

TAYLOR
AB 141/17
17,5 cm/7"

TAYLOR
AB 142/17
17,5 cm/7"

TAYLOR
AB 143/17
17,5 cm/7"

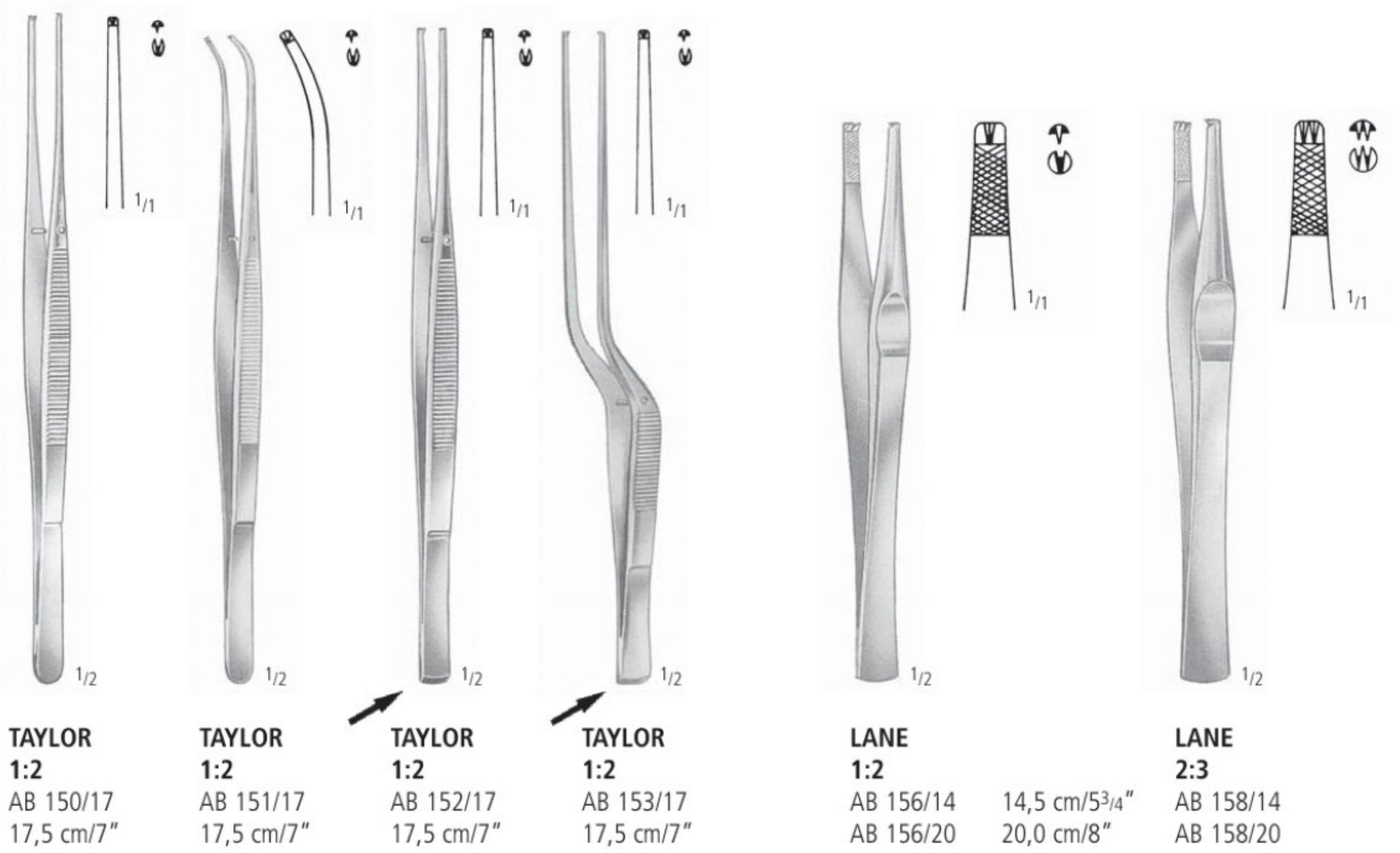

TAYLOR 1:2
AB 150/17
17,5 cm/7"

TAYLOR 1:2
AB 151/17
17,5 cm/7"

TAYLOR 1:2
AB 152/17
17,5 cm/7"

TAYLOR 1:2
AB 153/17
17,5 cm/7"

LANE 1:2
AB 156/14 14,5 cm/5³/₄"
AB 156/20 20,0 cm/8"

LANE 2:3
AB 158/14
AB 158/20

AB PINZETTEN FORCEPS PINZAS PINCES PINZE

Anatomische Pinzetten, Chirurgische Pinzetten
 Dressing Forceps, Tissue Forceps
 Pinzas de disección, Pinzas de disección con dientes
 Pincers à dissection, Pincers à griffes
 Pinze anatomiche per dissezione, Pinze chirurgiche a denti di topo

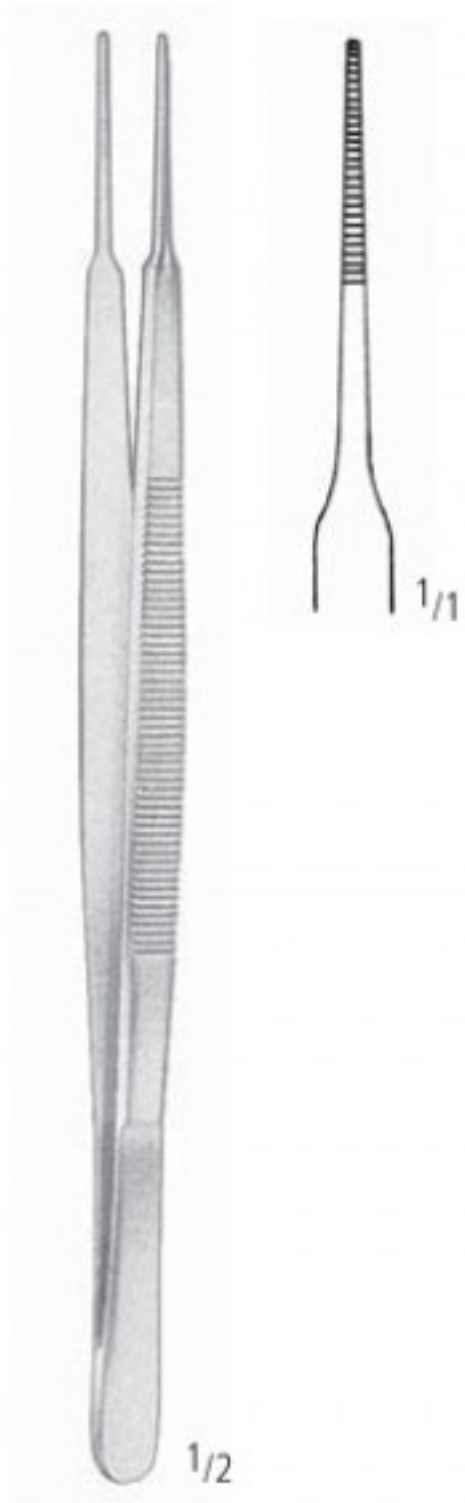

GERALD
 AB 160/18 18,0 cm/7"

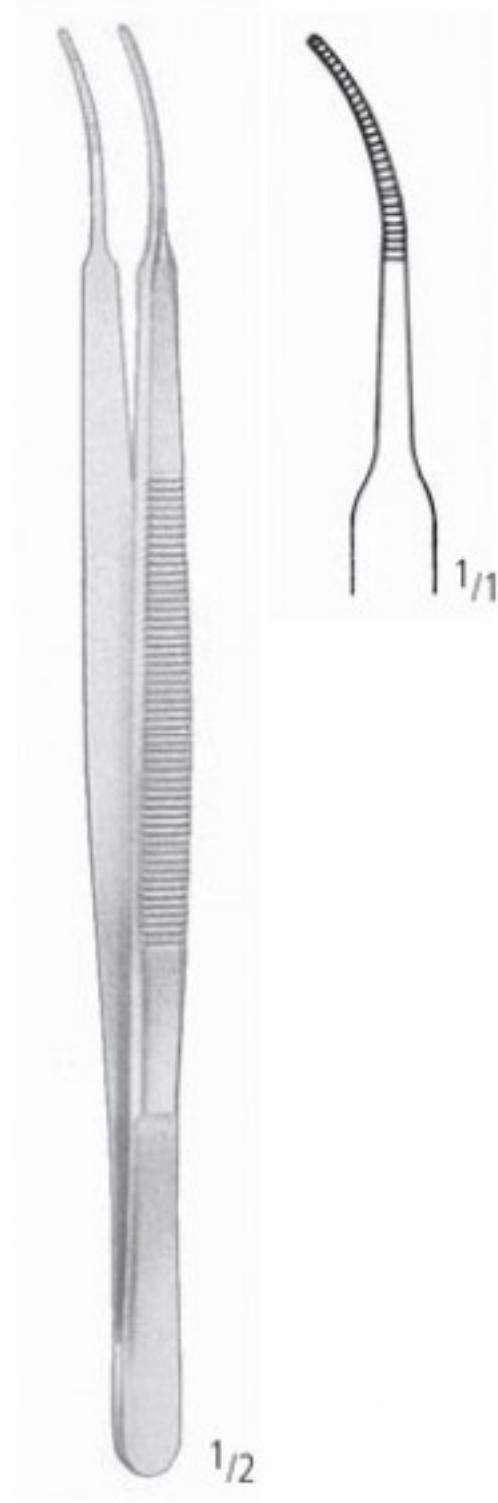

GERALD
 AB 161/18



GERALD 1:2
 AB 170/18 18,0 cm/7"



GERALD 1:2
 AB 171/18



CUSHING
 AB 180/17 17,5 cm/7"



CUSHING
 AB 181/17



CUSHING 1:2
 AB 190/17 17,5 cm/7"



CUSHING 1:2
 AB 191/17

PINZETTEN FORCEPS PINZAS PINCES PINZE

Anatomische Pinzetten, Chirurgische Pinzetten
 Dressing Forceps, Tissue Forceps
 Pinzas de disección, Pinzas de disección con dientes
 Pincés à dissection, Pincés à griffes
 Pinze anatomiche per dissezione, Pinze chirurgiche a denti di topo

AA

AB

AC

AD

AE

AF

AK

AL

AM

AO

AP

AR

KA

KB

KC

KD

KU

KY



AB 200/18

POTTS-SMITH

1/2



AB 201/18



AB 210/18

POTTS-SMITH
1:2

1/2



AB 211/18

1/2

18,0 cm/7"
 21,0 cm/8 1/4"
 25,0 cm/10"

AB 200/18
 AB 200/21
 AB 200/25

AB 201/18
 AB 201/21
 AB 201/25

AB 210/18
 AB 210/21
 AB 210/25

AB 211/18
 AB 211/21
 AB 211/25



BROPHY

1/2



AB 251/20



BROPHY
1:2

1/2



AB 261/20

20,0 cm/8"

AB 250/20

AB 260/20

AB PINZETTEN FORCEPS PINZAS PINCES PINZE

Anatomische Pinzetten, Chirurgische Pinzetten
 Dressing Forceps, Tissue Forceps
 Pinzas de disección, Pinzas de disección con dientes
 Pincés à dissection, Pincés à griffes
 Pinze anatomiche per dissezione, Pinze chirurgiche a denti di topo

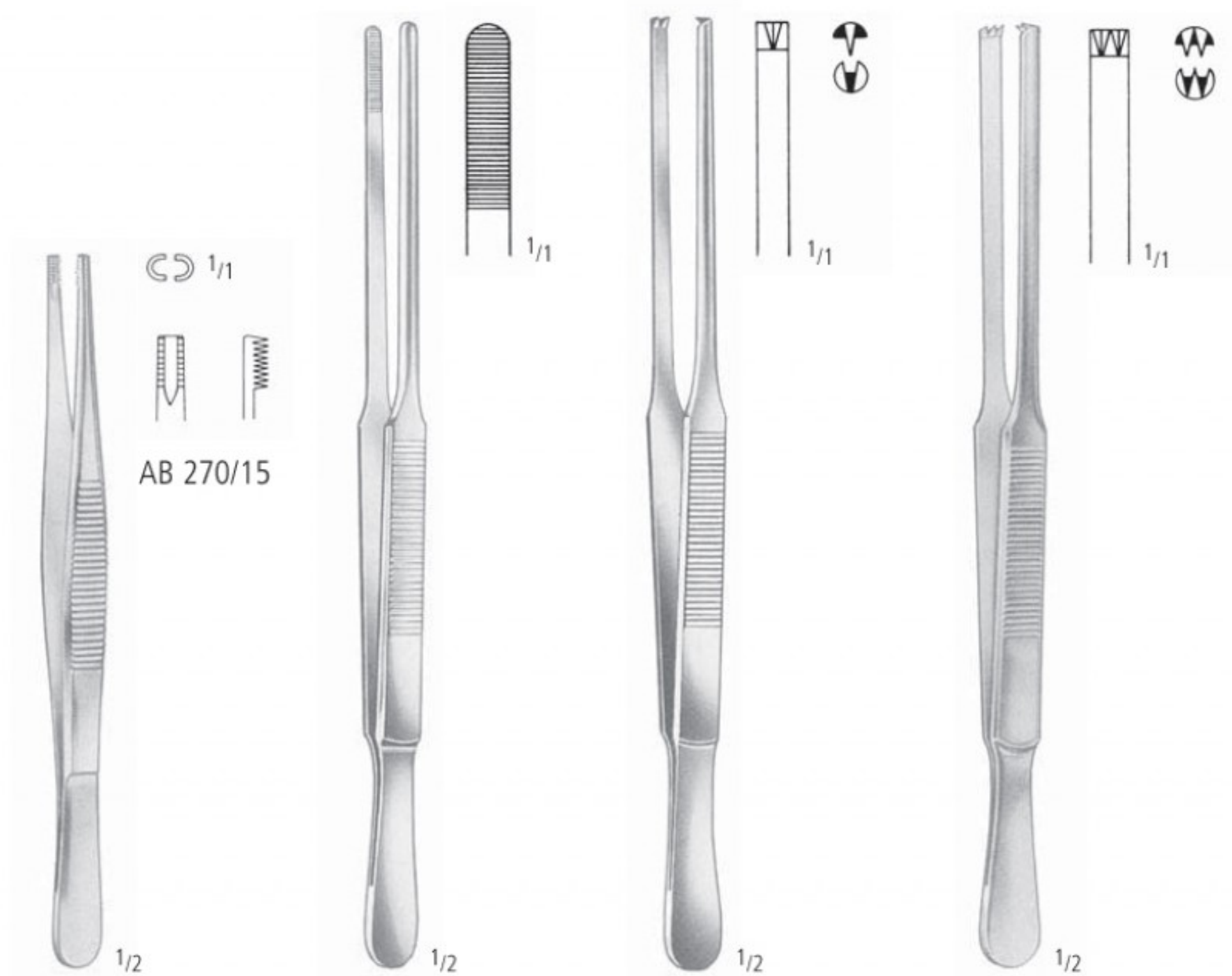

15,0 cm/6"
 20,0 cm/8"
 25,0 cm/10"

BROWN
 AB 270/15
 AB 270/20
 AB 270/25

DUEHRSEN
 AB 290/20

DUEHRSEN 1:2
 AB 292/20

DUEHRSEN 2:3
 AB 294/20

PINZETTEN FORCEPS PINZAS PINCES PINZE

Anatomische Pinzetten, Chirurgische Pinzetten
 Dressing Forceps, Tissue Forceps
 Pinzas de disección, Pinzas de disección con dientes
 Pincés à dissection, Pincés à griffes
 Pinze anatomiche per dissezione, Pinze chirurgiche a denti di topo

AA

AB

AC

AD

AE

AF

AK

AL

AM

AO

AP

AR

KA

KB

KC

KD

KU

KY



WANGENSTEEN
 AB 306/23
 23,0 cm/9"



AB 316/20

STILLE-BARRAYA 3:4
 18,0 cm/7" AB 316/18
 20,0 cm/8" AB 316/20
 25,0 cm/10" AB 316/25

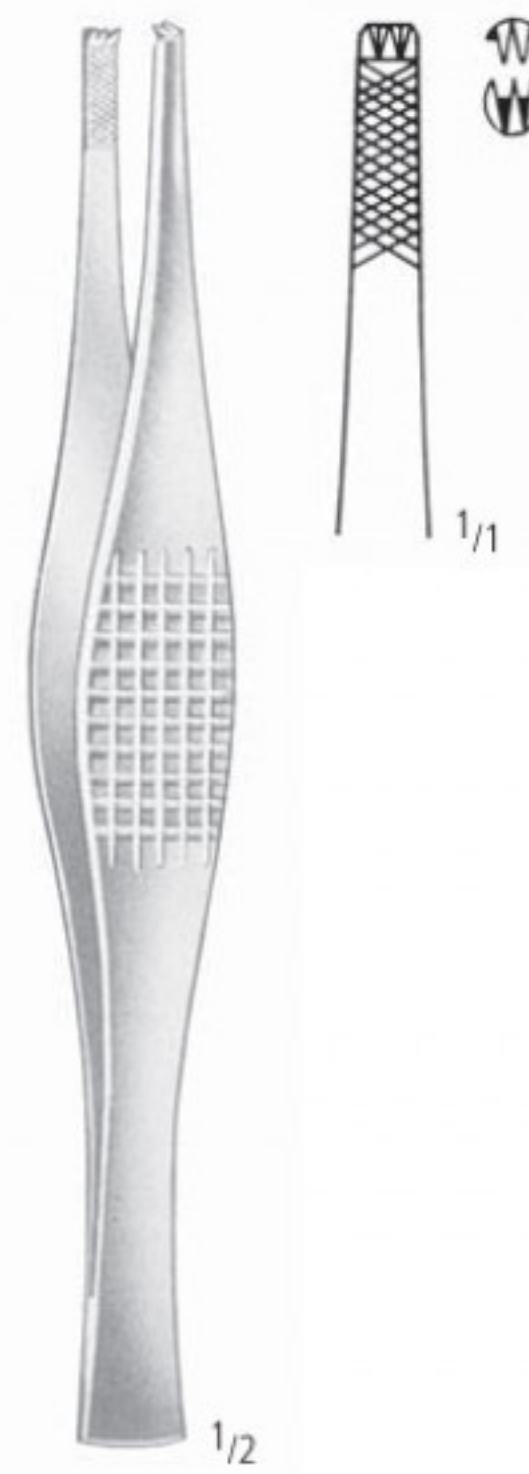

FERRIS-SMITH 2:3
 AB 320/18
 18,0 cm/7"

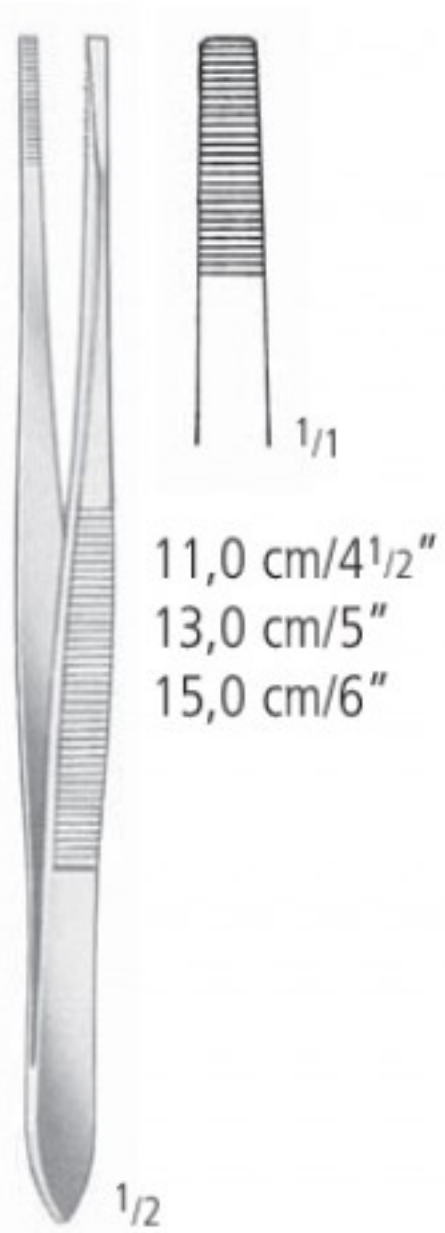

STILLE
 AB 370/11
 AB 370/13
 AB 370/15



STILLE 1:2
 AB 380/15
 15,0 cm/6"



STILLE 2:3
 AB 382/15
 15,0 cm/6"



ADLERKREUTZ
 AB 400/15
 AB 400/20

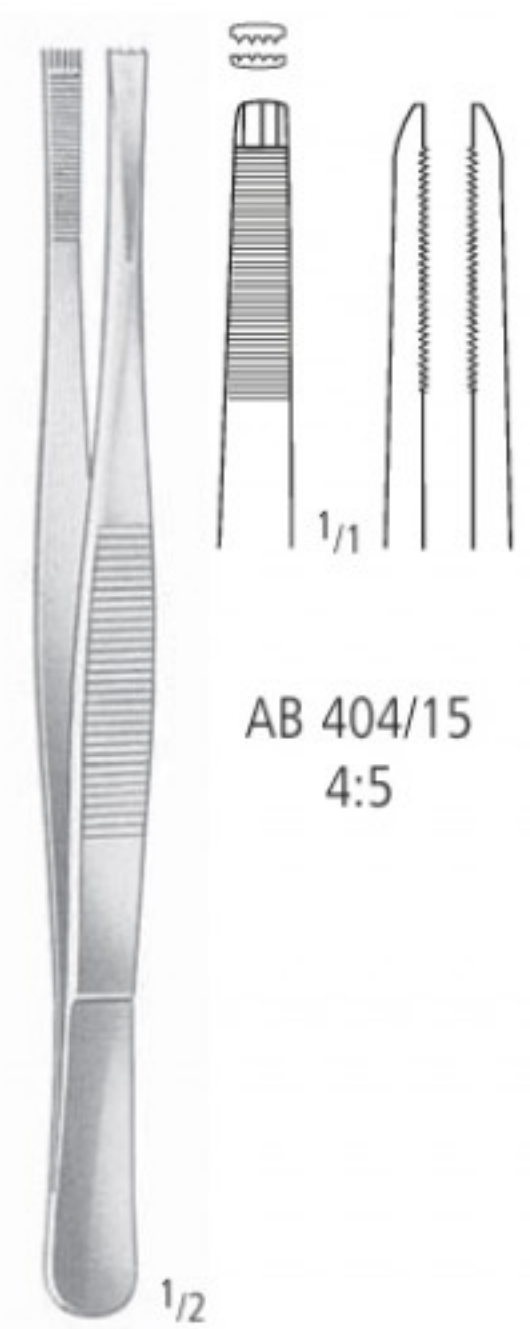

AB 404/15
 AB 404/20
 AB 404/25

AB PINZETTEN FORCEPS PINZAS PINCES PINZE

Fasspinzetten
 Grasping Forceps
 Pinzas para coger
 Pincers pour saisir les tissus
 Pinze per afferrare tessuti

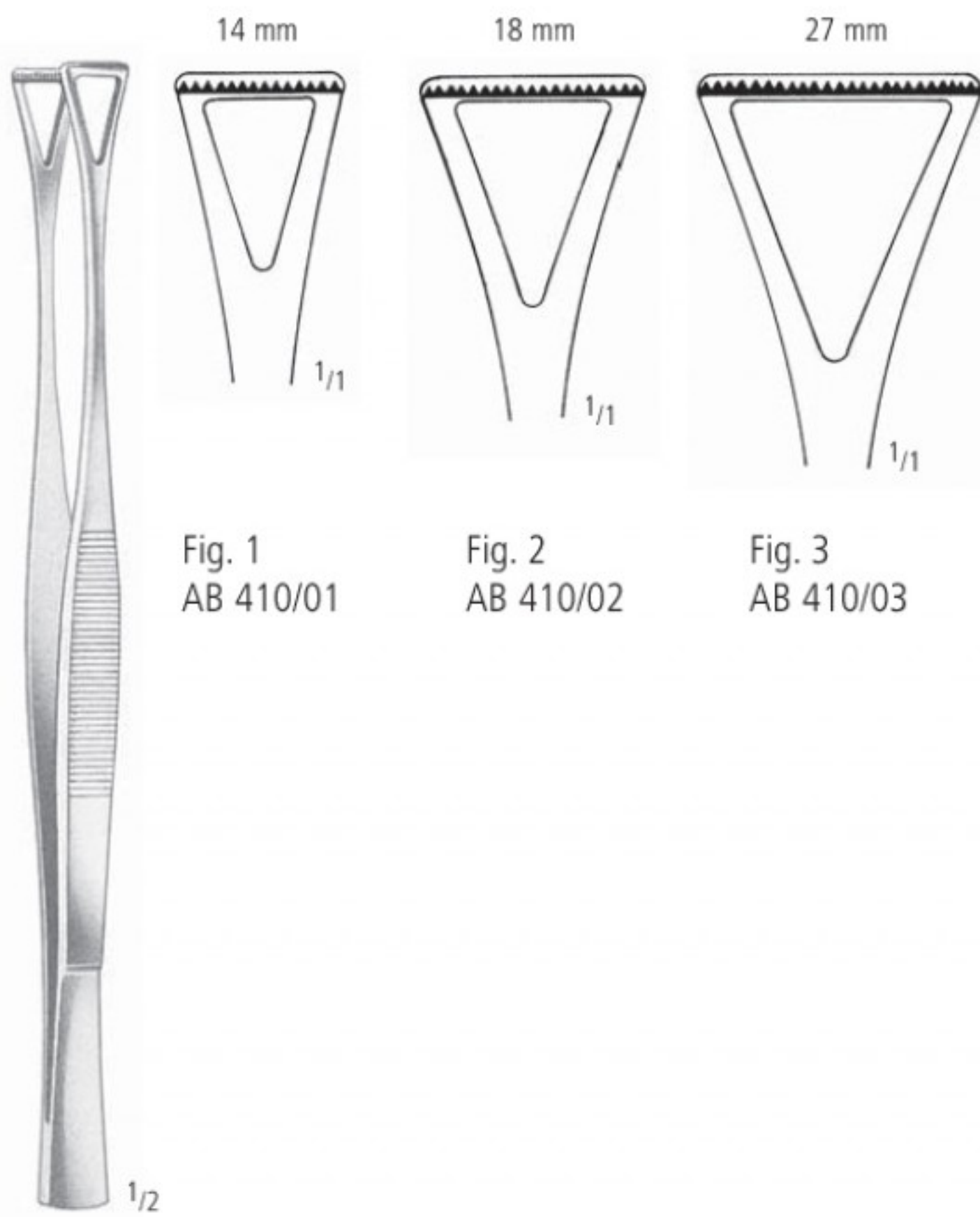
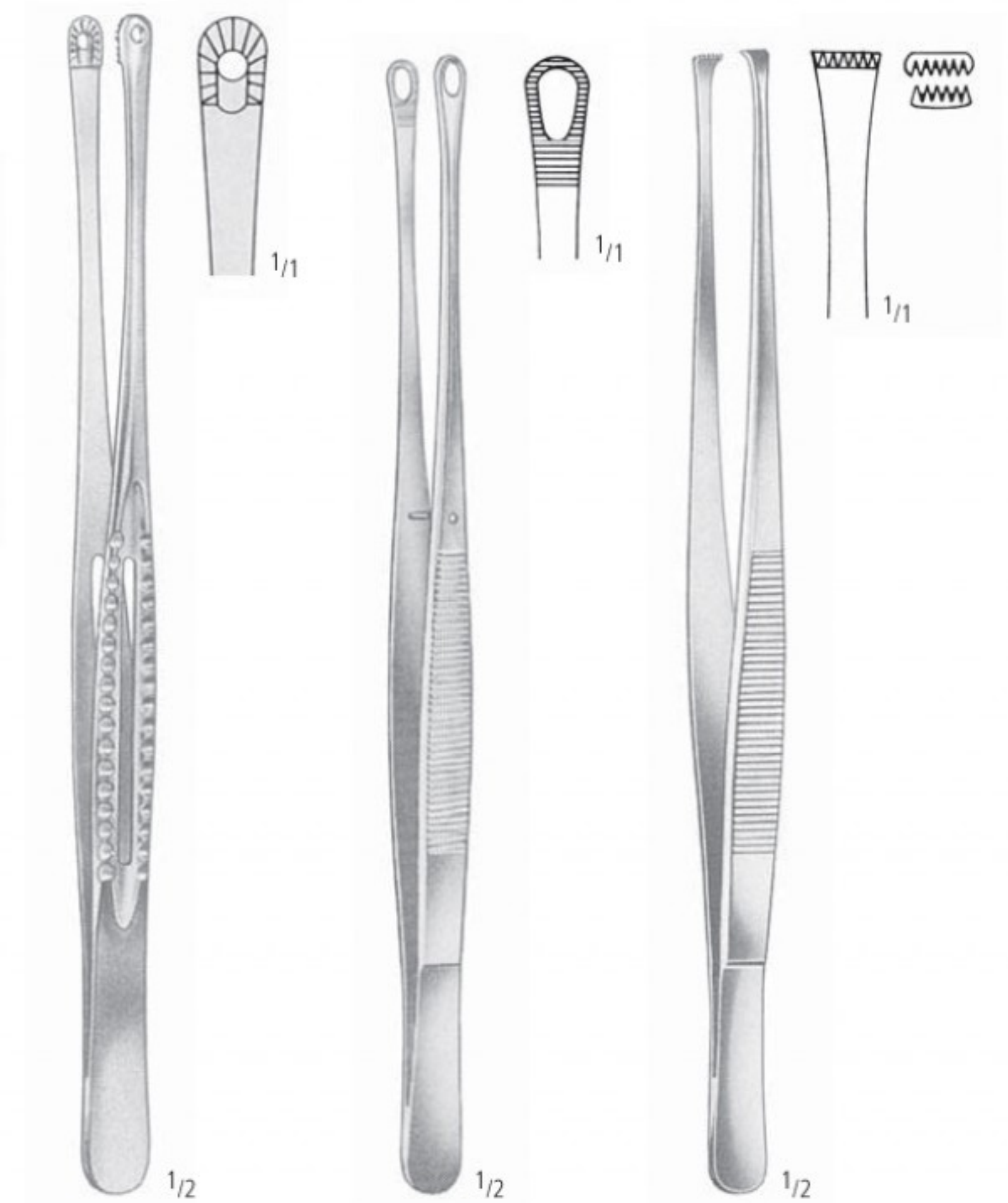

Fig. 1
 AB 410/01

Fig. 2
 AB 410/02

Fig. 3
 AB 410/03

COLLIN-DUVAL
 20,0 cm/8"



MAYO-RUSS.
 AB 414/23
 23,0 cm/9"

SINGLEY-TUTTLE
 AB 416/23
 23,0 cm/9"

NELSON
 AB 418/23
 23,0 cm/9"

PINZETTEN FORCEPS PINZAS PINCES PINZE

Chirurgische Pinzetten, Fasspinzetten
 Tissue Forceps, Grasping Forceps
 Pinzas de disección con dientes, Pinzas para coger
 Pincès à griffes, Pincès pour saisir les tissus
 Pinze chirurgiche a denti di topo, Pinze per afferrare tessuti

AA

AB

AC

AD

AE

AF

AK

AL

AM

AO

AP

AR

KA

KB

KC

KD

KU

KY



GILLIES 1:2
 AB 430/15
 15,0 cm/6"



WAUGH 1:2
 AB 434/20
 20,5 cm/8"

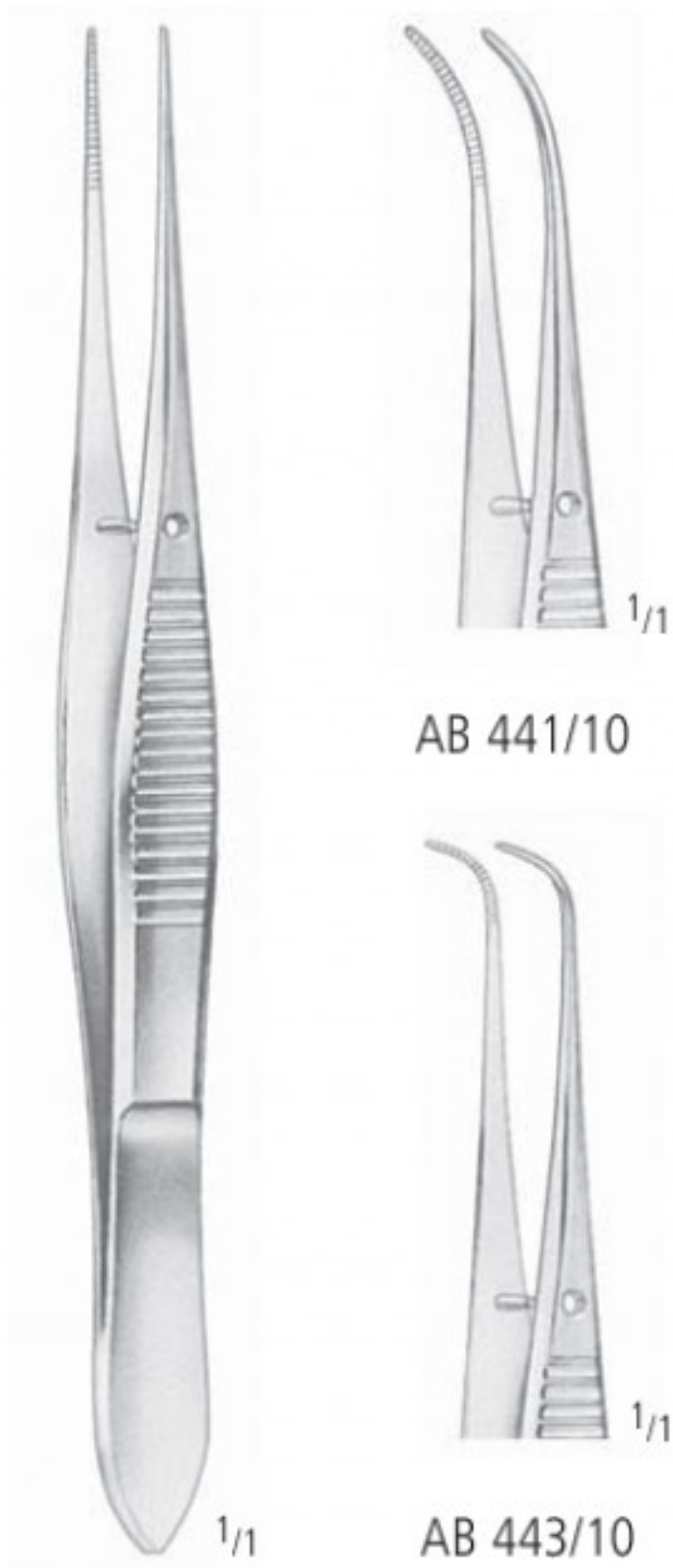

AB 440/10
 10,5 cm/4¹/₄"

AB 441/10

AB 443/10

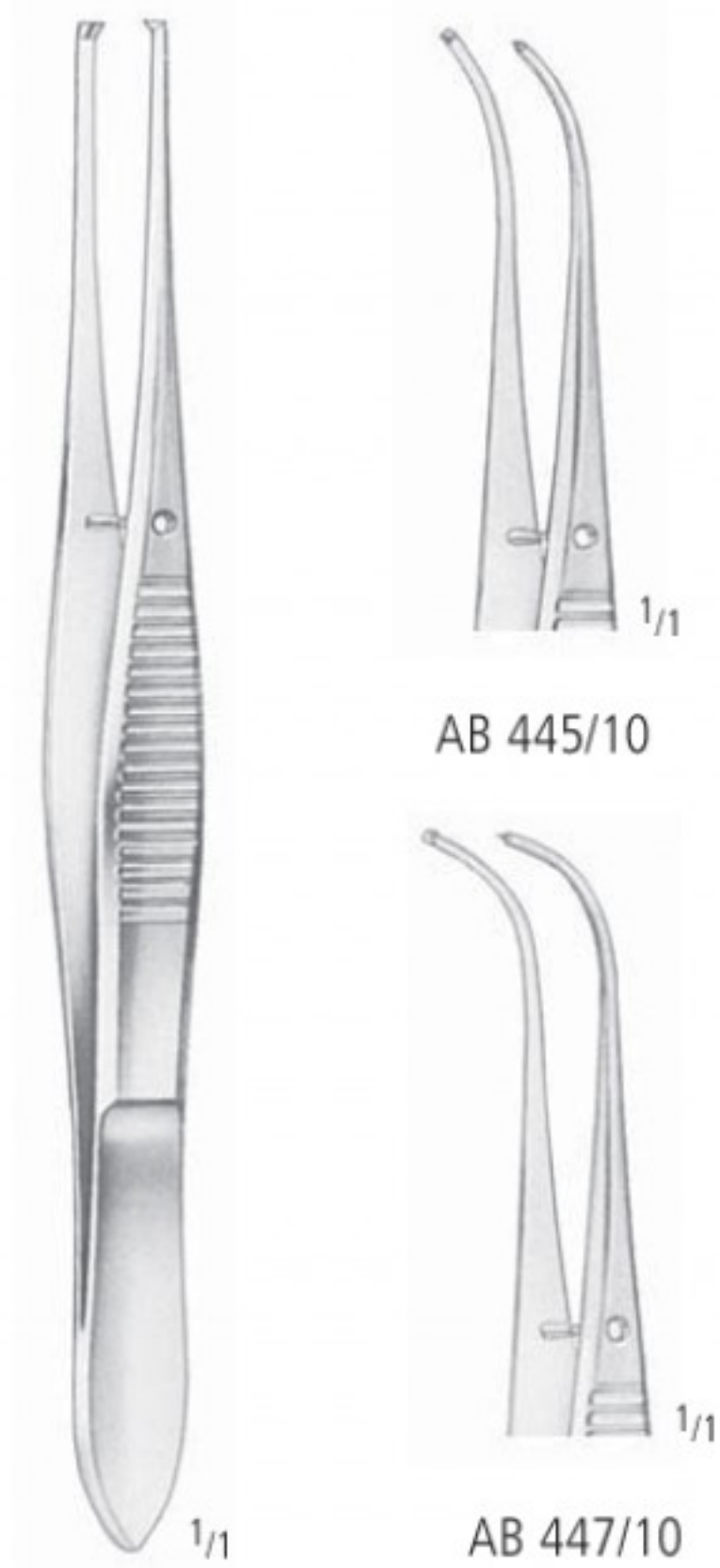

1:2
 AB 444/10
 10,5 cm/4¹/₄"

AB 445/10

AB 447/10

AB PINZETTEN FORCEPS PINZAS PINCES PINZE

Chirurgische Pinzetten, Fasspinzetten
 Tissue Forceps, Grasping Forceps
 Pinzas de disección con dientes, Pinzas para coger
 Pincés à griffes, Pincés pour saisir les tissus
 Pinze chirurgiche a denti di topo, Pinze per afferrare tessuti

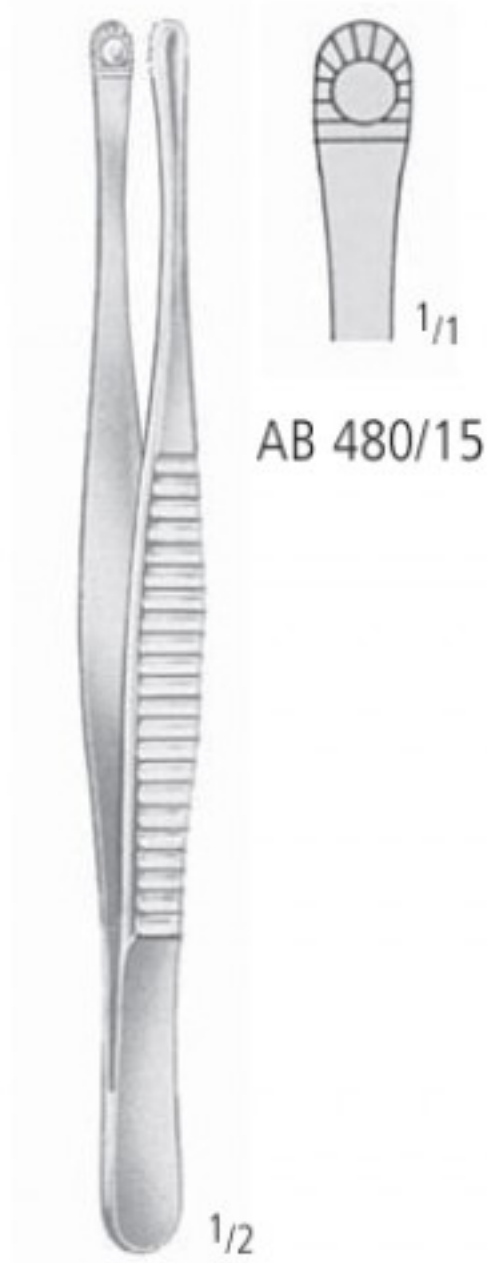

AB 480/15

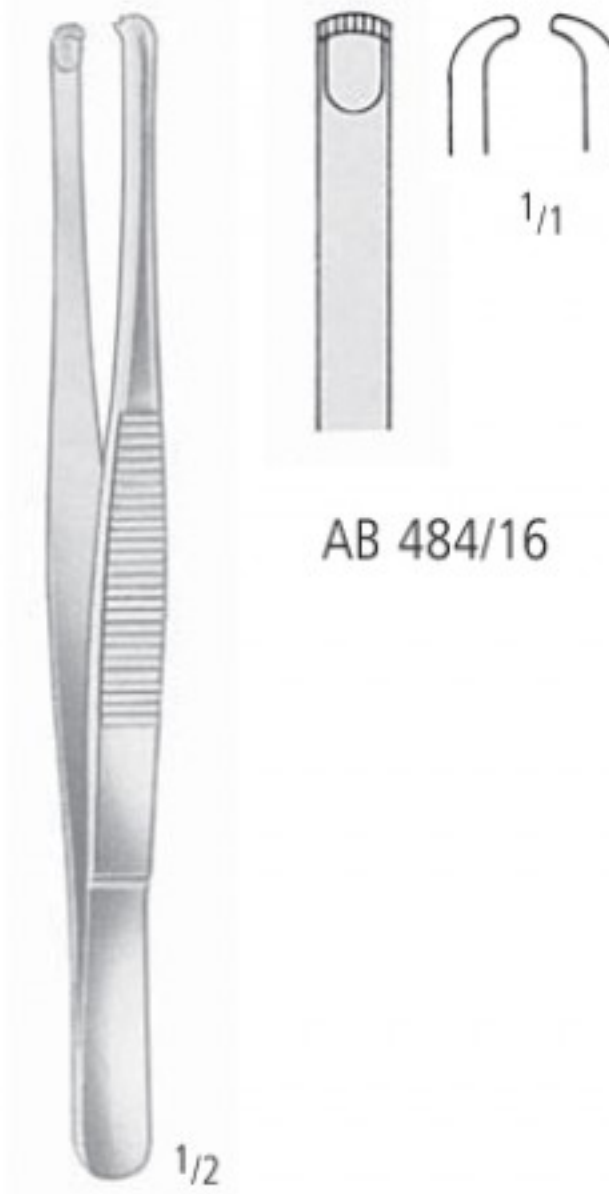

AB 484/16

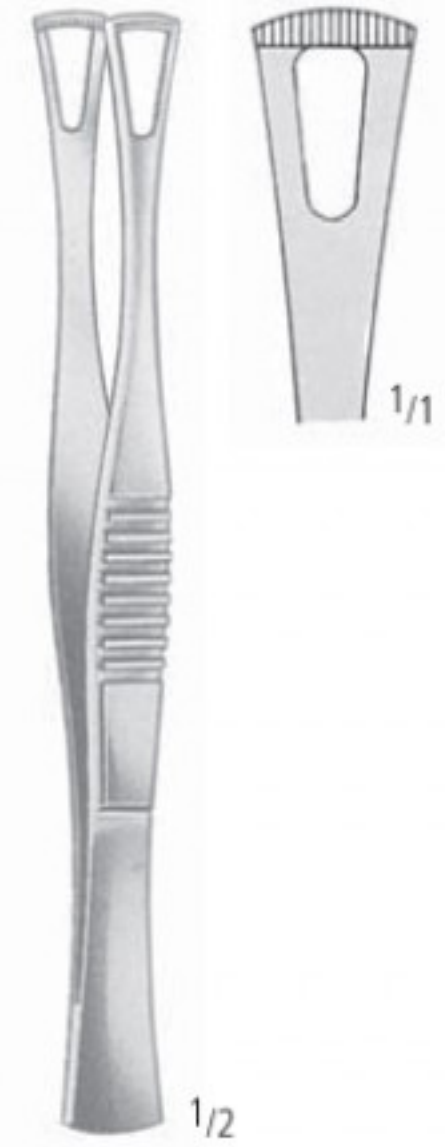

DUVAL

AB 486/14
 14,5 cm/5³/₄"

RUSS. MODELL

15,0 cm/6"
 20,0 cm/8"
 25,0 cm/10"
 AB 480/15
 AB 480/20
 AB 480/25

DURANTE

14,5 cm/5³/₄"
 16,0 cm/6¹/₄"
 20,0 cm/8"
 AB 484/14
 AB 484/16
 AB 484/20

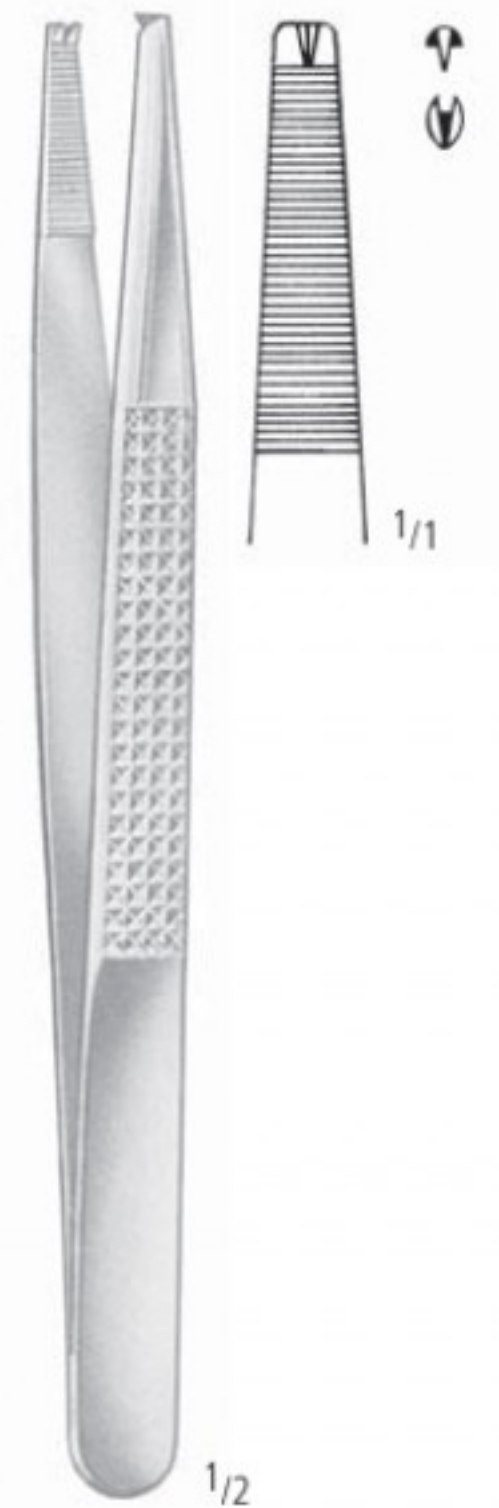

BONNEY 1:2

AB 490/18
 18,0 cm/7"

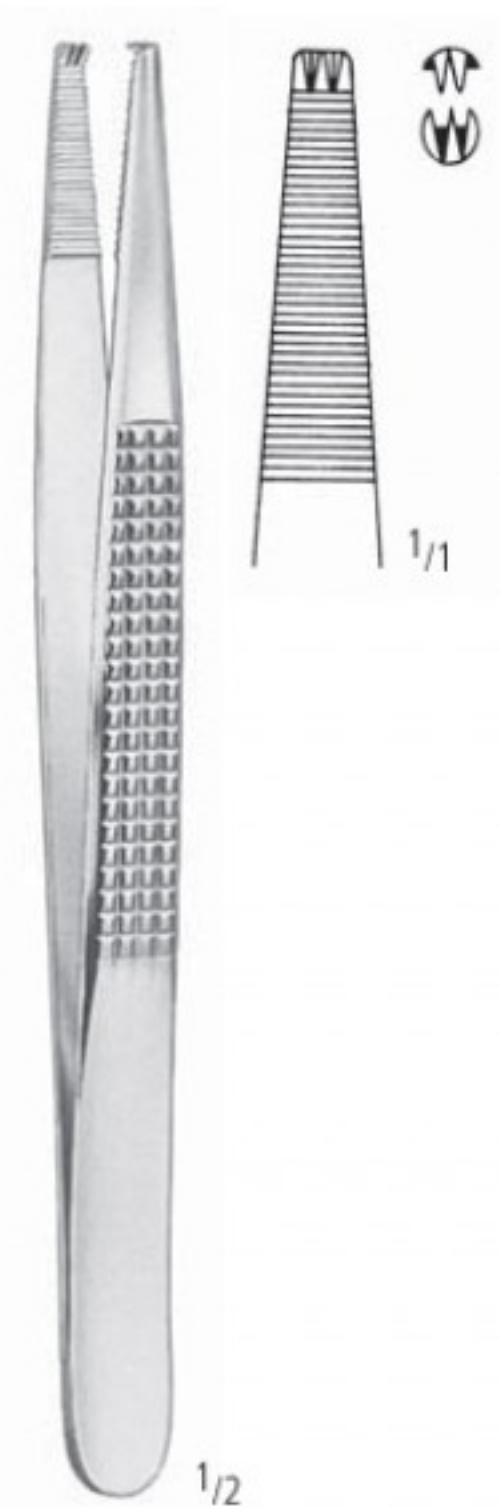

BONNEY 2:3

AB 492/18
 18,0 cm/7"

PINZETTEN FORCEPS PINZAS PINCES PINZE

Uhrmacherpinzetten
Jeweler's Forceps
Pinzas de relojero
Pinces d'horloger
Pinze da orologiaio



1/1

No. 1

AB 501/01
12,0 cm/4³/₄"



1/1

No. 2

AB 501/02
12,0 cm/4³/₄"



1/1

No. 3

AB 501/03
12,0 cm/4³/₄"



1/1

No. 4

AB 501/04
11,0 cm/4¹/₃"



1/1

No. 5

AB 501/05
11,0 cm/4¹/₃"



1/1

No. 5a

AB 501/15
11,0 cm/4¹/₃"



1/1

No. 5/45°

AB 501/45
10,5 cm/4¹/₄"



1/1

No. 5/90°

AB 501/90
10,5 cm/4¹/₄"



1/1

No. 7

AB 502/07
11,5 cm/4¹/₂"

AA

AB

AC

AD

AE

AF

AK

AL

AM

AO

AP

AR

KA

KB

KC

KD

KU

KY

AB PINZETTEN FORCEPS PINZAS PINCES PINZE

Fasspinzetten
Grasping Forceps
Pinzas para coger
Pincers pour saisir les tissus
Pinze per afferrare tessuti



AB 506/01
Ø 3,0 mm AB 506/02
Ø 3,0 mm

SAMII
24,0 cm/9¹/₂"



AB 507/01 AB 507/02
Ø 3,0 mm Ø 5,0 mm
Löffel
Spoon
AB 508/01 AB 508/02
Ø 3,0 mm Ø 5,0 mm
flach
flat

22,0 cm/8³/₄"



AB 509/01 AB 509/02
Ø 3,0 mm Ø 5,0 mm
Kürette
Curette

HEIFETZ
22,0 cm/8³/₄"



HUNT
AB 510/20
20,0 cm/8"



16,0 cm/6 ¹ / ₄ "	AB 515/16	AB 516/16	AB 517/16
18,0 cm/7"	AB 515/18	AB 516/18	AB 517/18
20,0 cm/8"	AB 515/20	AB 516/20	AB 517/20
22,0 cm/8 ³ / ₄ "	AB 515/22	AB 516/22	
24,0 cm/9 ¹ / ₂ "	AB 515/24	AB 516/24	

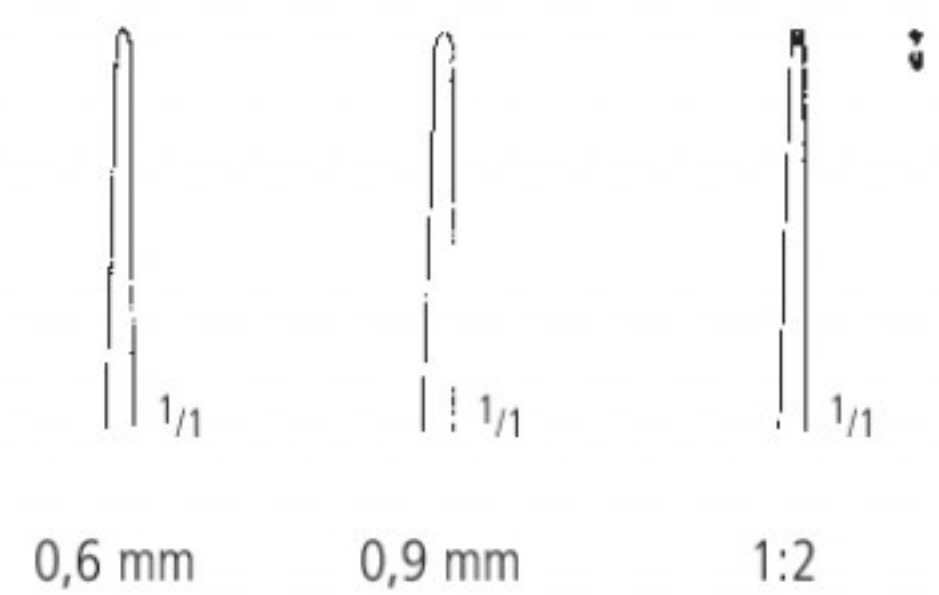

PINZETTEN FORCEPS PINZAS PINCES PINZE

Mikro-Pinzetten, Knüpfpinzetten mit Plateau
 Micro Forceps, Suture Tying Forceps with platform
 Micro-Pinzas, Pinzas de ligadura con plataforma
 Micro-Pinces, Pinces à ligature avec plate-forme
 Micro-Pinze, Pinze per ligature con piattaforma

AA

AB

AC

AD

AE

AF

AK

AL

AM

AO

AP

AR

KA

KB

KC

KD

KU

KY

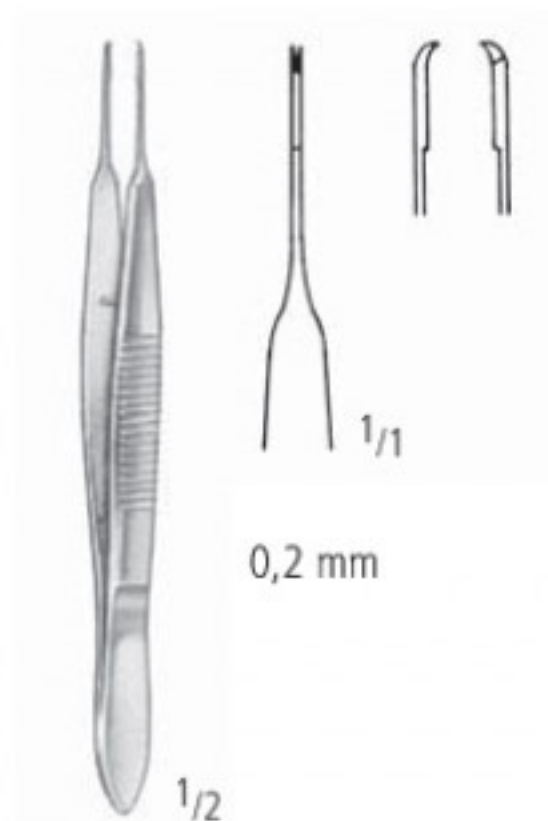

1:2
 AB 530/09
 9,5 cm/3³/₄"

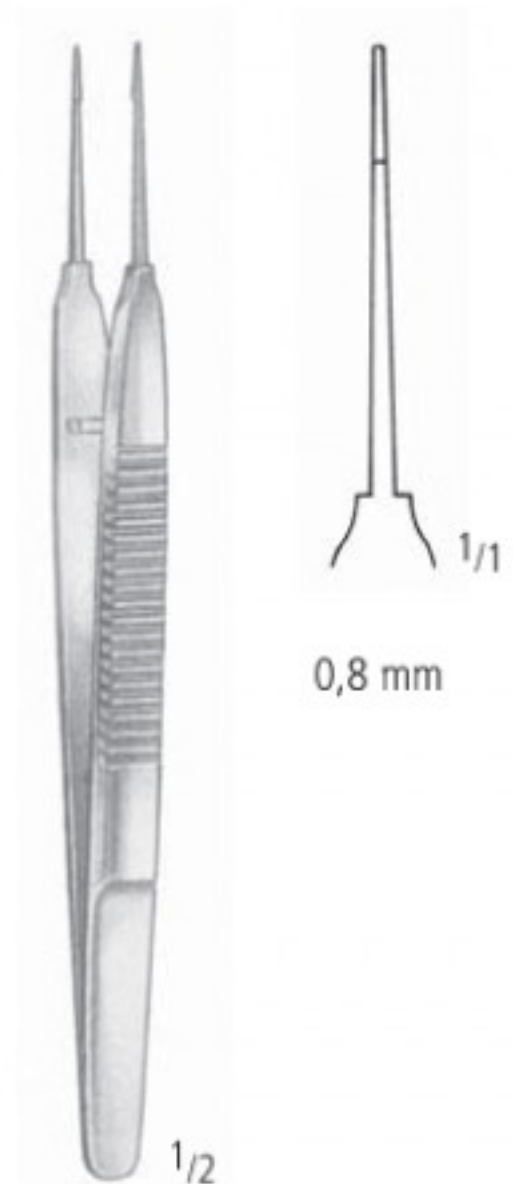

AUSTIN
 AB 532/14
 14,0 cm/5¹/₂"

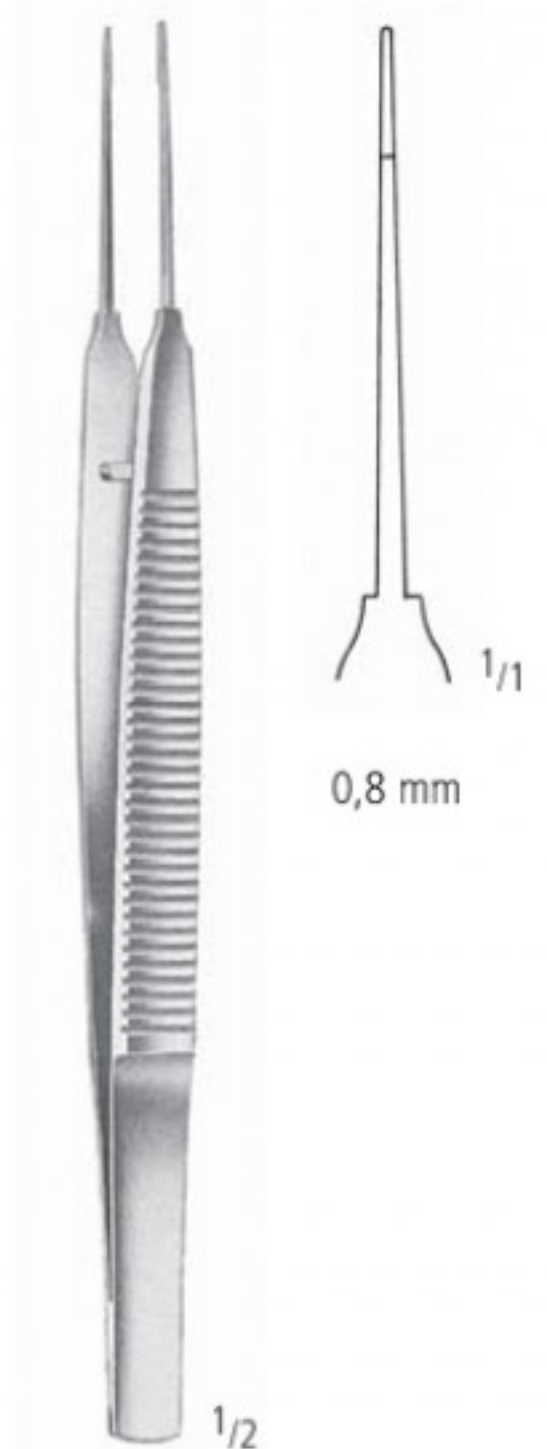

AUSTIN
 AB 532/18
 18,0 cm/7"

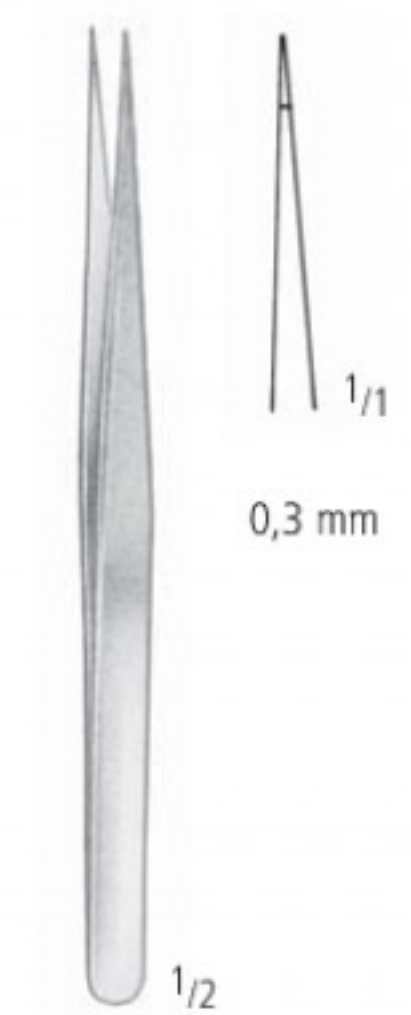

AB 534/12
 12,0 cm/4³/₄"



VISE
 AB 534/13
 13,5 cm/5¹/₄"

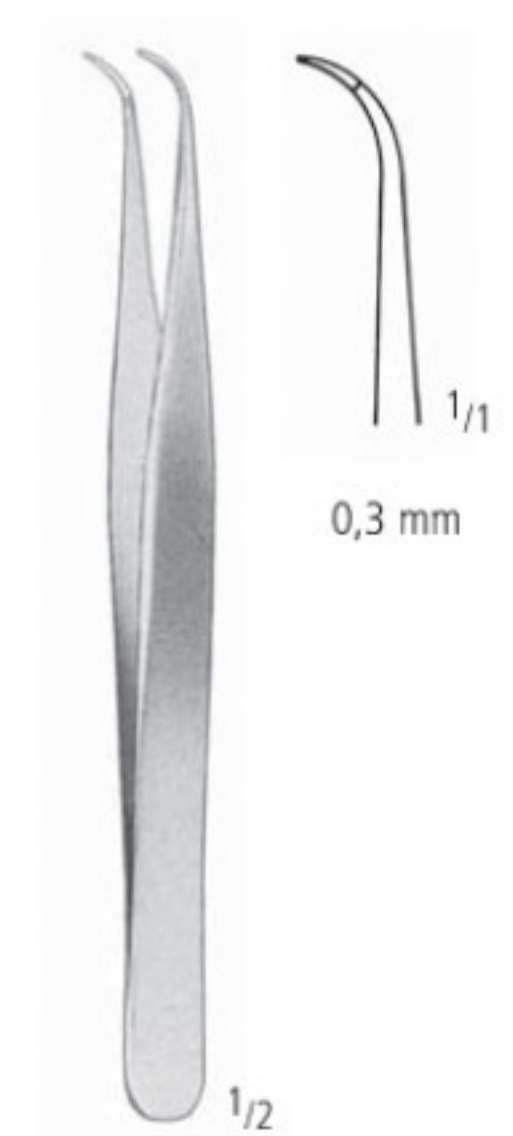

VISE
 AB 535/13
 13,5 cm/5¹/₄"

AB PINZETTEN FORCEPS PINZAS PINCES PINZE

Mikro-Pinzetten, Knüpfpinzetten mit Plateau, Gefäßdilator
 Micro Forceps, Suture Tying Forceps with platform, Vessel Dilator
 Micro-Pinzas, Pinzas de ligadura con plataforma, Dilatador para vasos
 Micro-Pinces, Pinces à ligature avec plate-forme, Dilatateur pour vaisseaux
 Micro-Pinze, Pinze per ligature con piattaforma, Dilatatore per vasi



AB 536/14
14,0 cm/5 1/2"



AB 538/14 **1:2**
14,0 cm/5 1/2"



AB 540/14 **1:2**
14,0 cm/5 1/2"

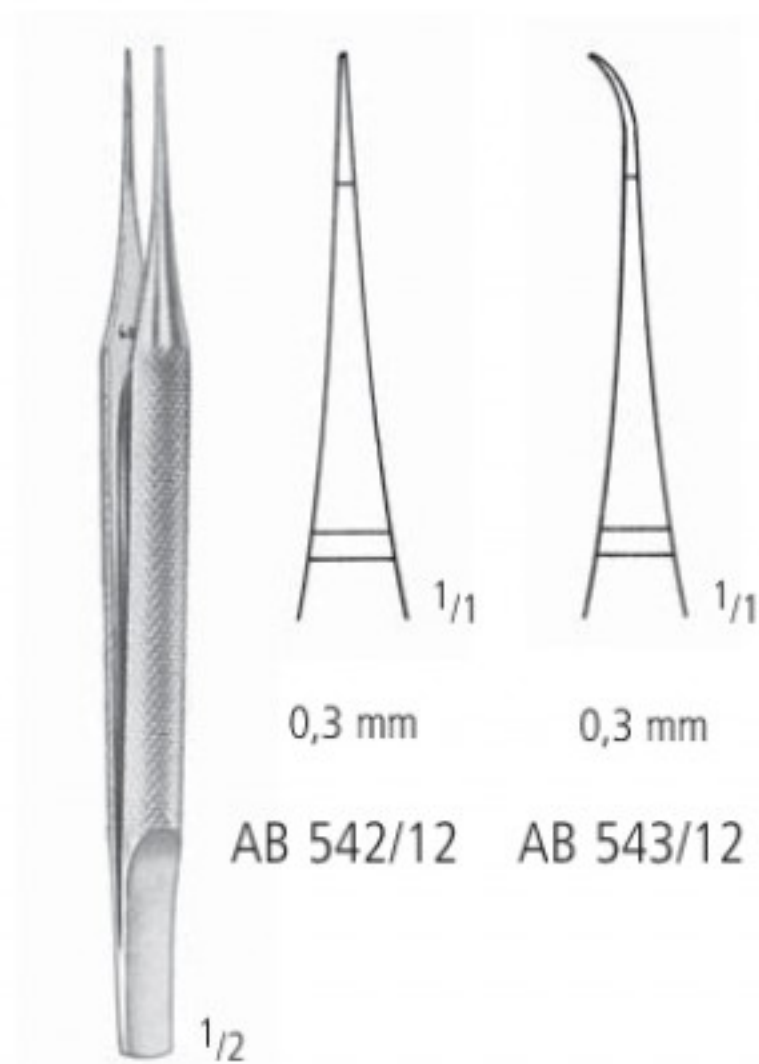

12,0 cm/4 3/4" AB 542/12 AB 543/12
15,0 cm/6" AB 542/15 AB 543/15

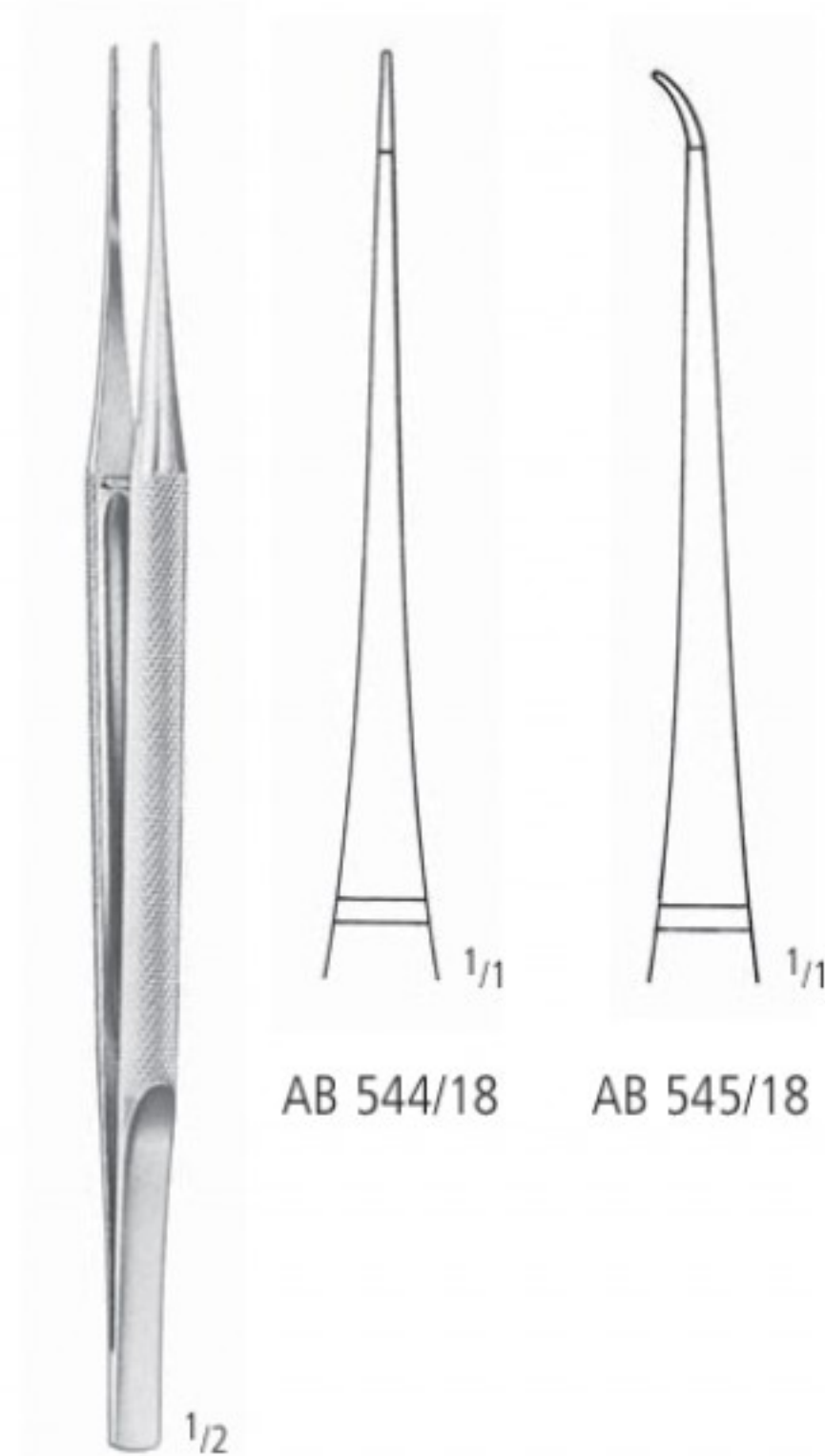

18,0 cm/7"

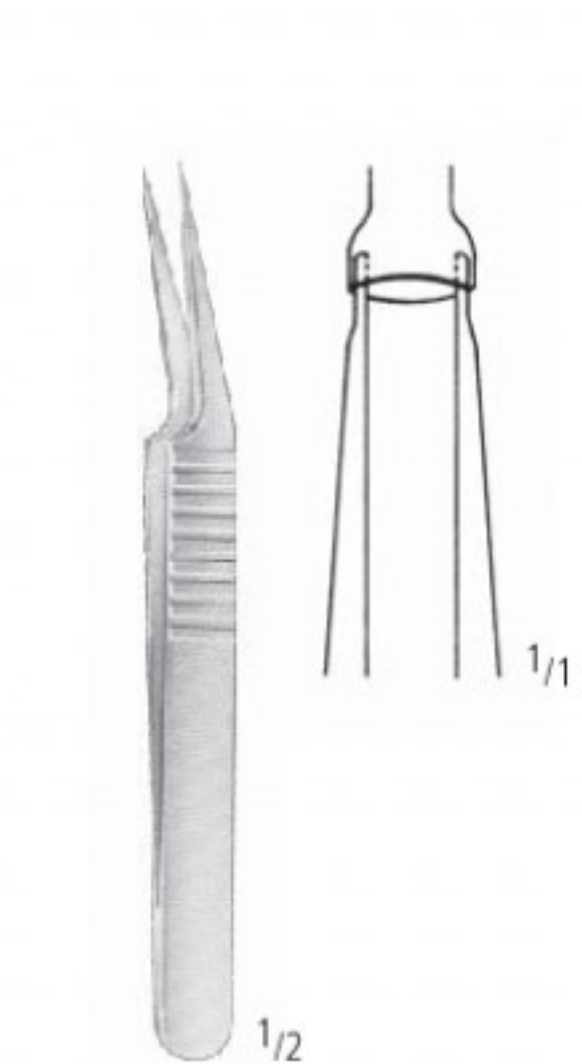

AB 546/11
11,0 cm/4 1/3"

PINZETTEN FORCEPS PINZAS PINCES PINZE

Splitter-Pinzetten
 Splinter Forceps
 Pinzas para espinas
 Pinces à échardes
 Pinze per schegge



FEILCHENFELD

- 7,5 cm/3" AB 550/07
- 9,0 cm/3 1/2" AB 550/09
- 11,5 cm/4 1/2" AB 550/11

ohne Führungsstift
 without guide pin
 sin espiga de guía
 sans repères
 senza perno da guida

- 8,0 cm/3"
- 9,0 cm/3 1/2"
- 10,5 cm/4 1/4"
- 11,5 cm/4 1/2"
- 12,5 cm/5"
- 14,5 cm/5 3/4"



HUNTER
 AB 552/10
 10,5 cm/4 1/4"



HUNTER
 AB 553/10
 10,5 cm/4 1/4"



WALTER-CARMALT
 AB 556/10
 10,5 cm/4 1/4"

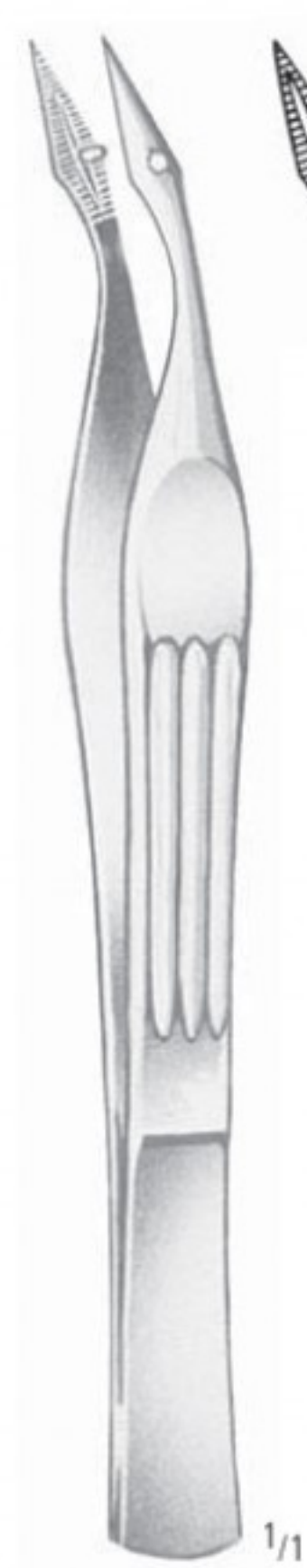

WALTER-CARMALT
 AB 557/10
 10,5 cm/4 1/4"



AB 560/10



AB 561/10

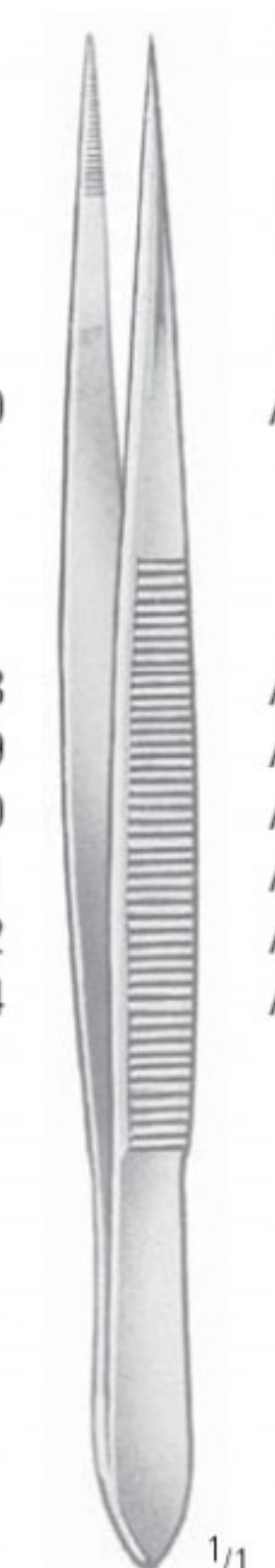

AB 562/10

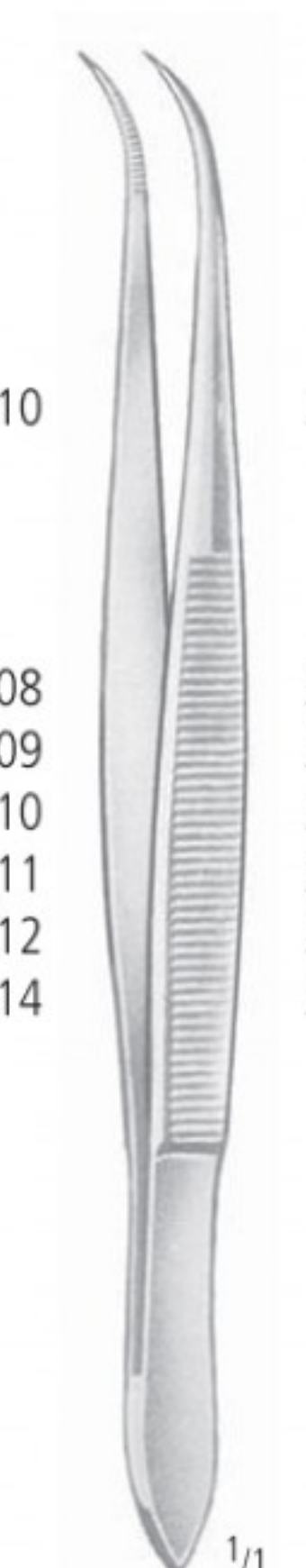

AB 563/10

- AB 560/08
- AB 560/09
- AB 560/10
- AB 560/11
- AB 560/12
- AB 560/14

- AB 561/08
- AB 561/09
- AB 561/10
- AB 561/11
- AB 561/12
- AB 561/14

- AB 562/08
- AB 562/09
- AB 562/10
- AB 562/11
- AB 562/12
- AB 562/14

- AB 563/08
- AB 563/09
- AB 563/10
- AB 563/11
- AB 563/12
- AB 563/14

AA
 AB
 AC
 AD
 AE
 AF
 AG
 AH
 AI
 AJ
 AK
 AL
 AM
 AN
 AO
 AP
 AQ
 AR
 AS
 AT
 AU
 AV
 AW
 AX
 AY
 AZ

AB PINZETTEN FORCEPS PINZAS PINCES PINZE

Splitter-Pinzetten
 Splinter Forceps
 Pinzas para espigas
 Pincas à échardes
 Pinze per schegge

mit Führungsstift
 with guide pin
 con espiga de guía
 avec repères
 con perno da guida



AB 564/10



AB 565/10



AB 566/10



AB 567/10

1/1

1/1

1/1

1/1

- 8,0 cm/3" AB 564/08
- 9,0 cm/3 1/2" AB 564/09
- 10,5 cm/4 1/4" AB 564/10
- 11,5 cm/4 1/2" AB 564/11
- 12,5 cm/5" AB 564/12
- 14,5 cm/5 3/4" AB 564/14

- AB 565/08
- AB 565/09
- AB 565/10
- AB 565/11
- AB 565/12
- AB 565/14

- AB 566/08
- AB 566/09
- AB 566/10
- AB 566/11
- AB 566/12
- AB 566/14

- AB 567/08
- AB 567/09
- AB 567/10
- AB 567/11
- AB 567/12
- AB 567/14

PINZETTEN FORCEPS PINZAS PINCES PINZE

Splitter-Pinzetten
 Splinter Forceps
 Pinzas para espinas
 Pincas à échardes
 Pinze per schegge

AA

AB

AC

AD

AE

AF

AK

AL

AM

AO

AP

AR

KA

KB

KC

KD

KU

KY

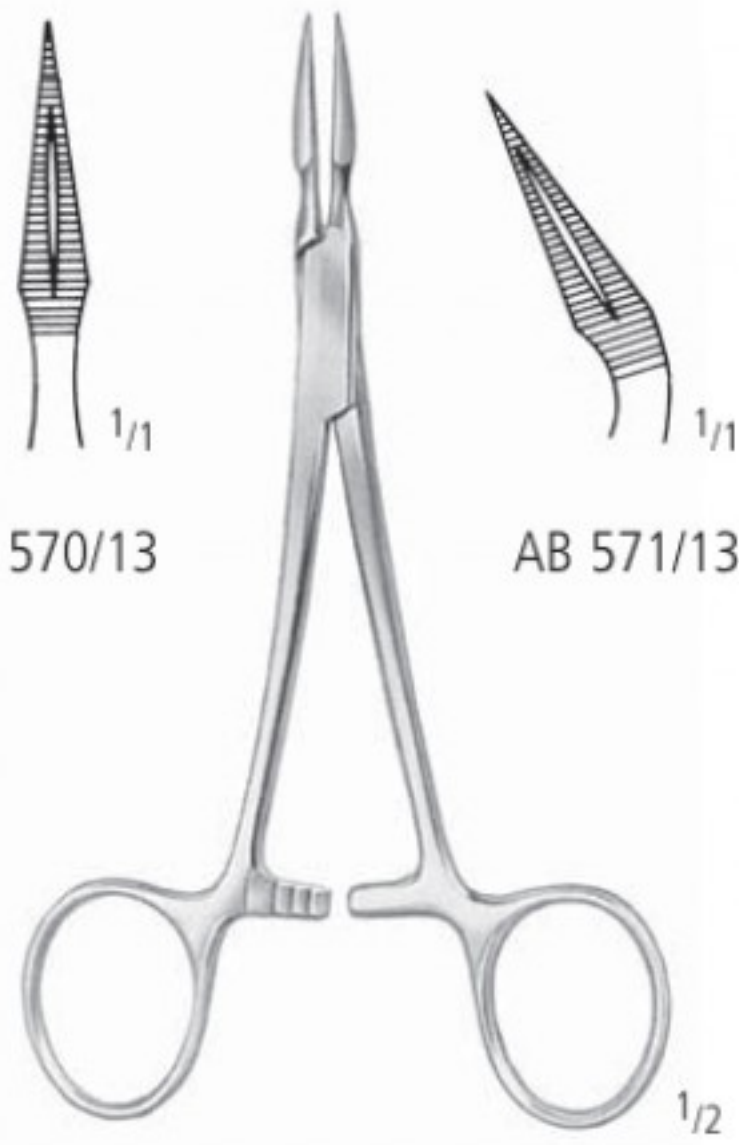

AB 570/13

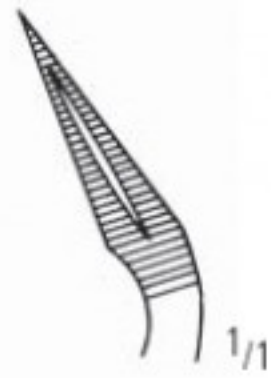

AB 571/13

STIEGLITZ
 13,5 cm/5¹/₄"



STIEGLITZ
 AB 571/90
 13,5 cm/5¹/₄"

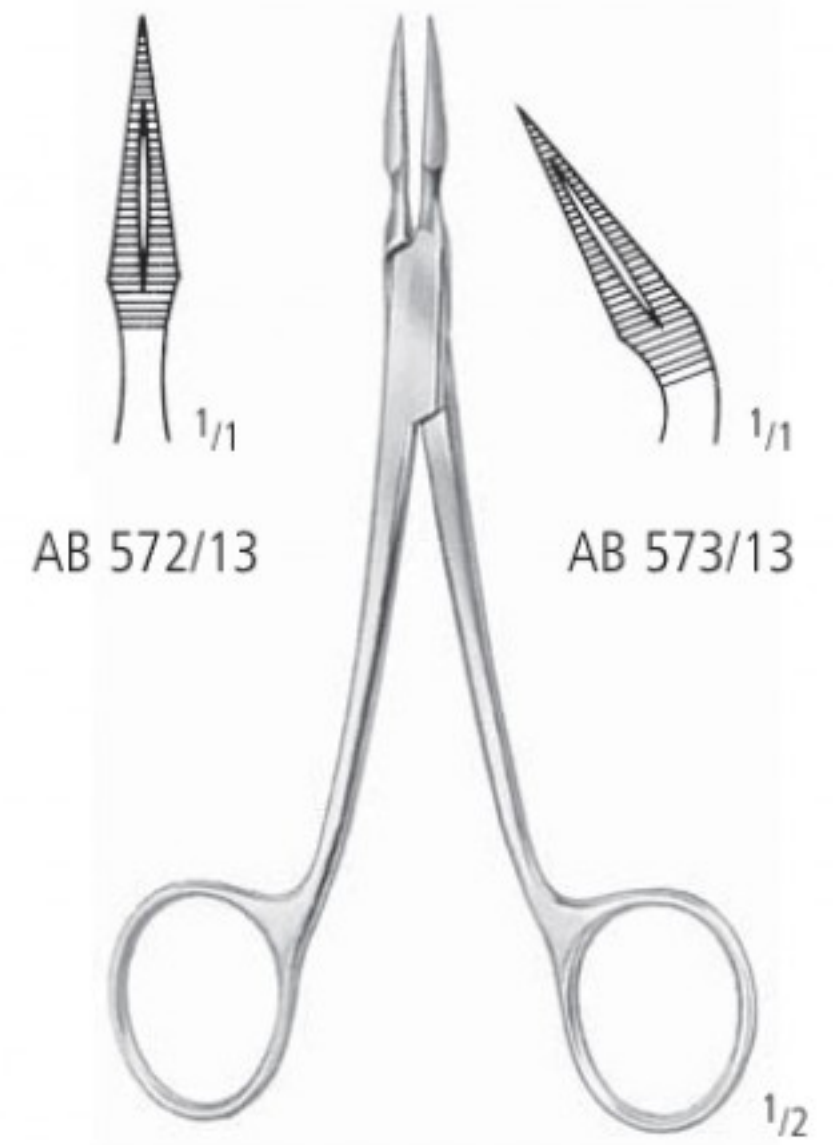

AB 572/13

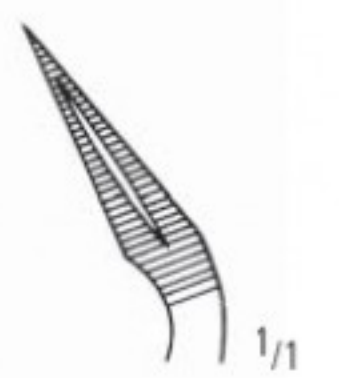

AB 573/13

STIEGLITZ
 13,5 cm/5¹/₄"

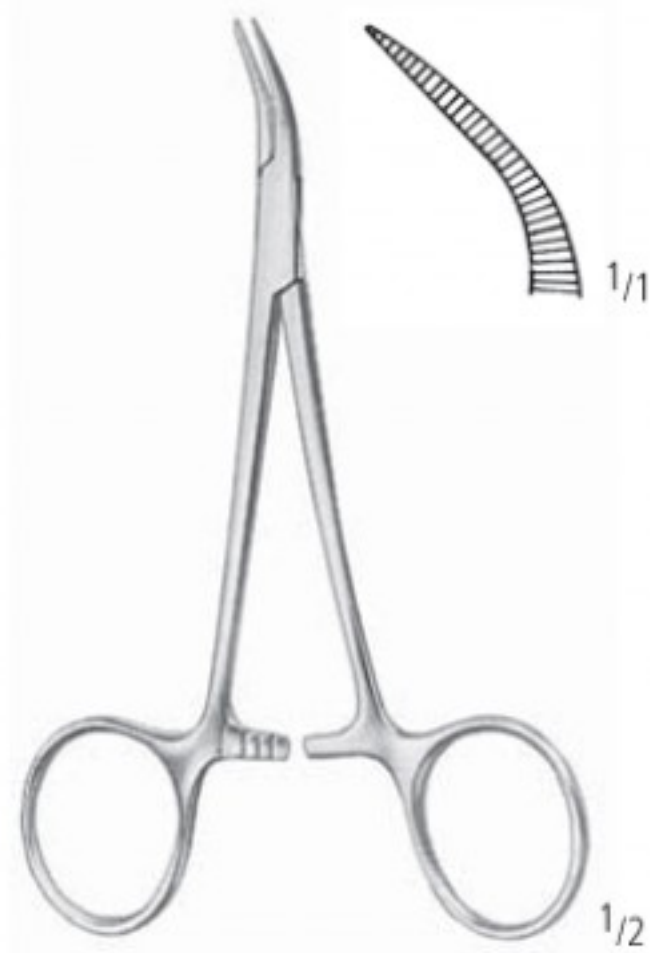

PEET
 AB 580/11
 11,5 cm/4¹/₂"

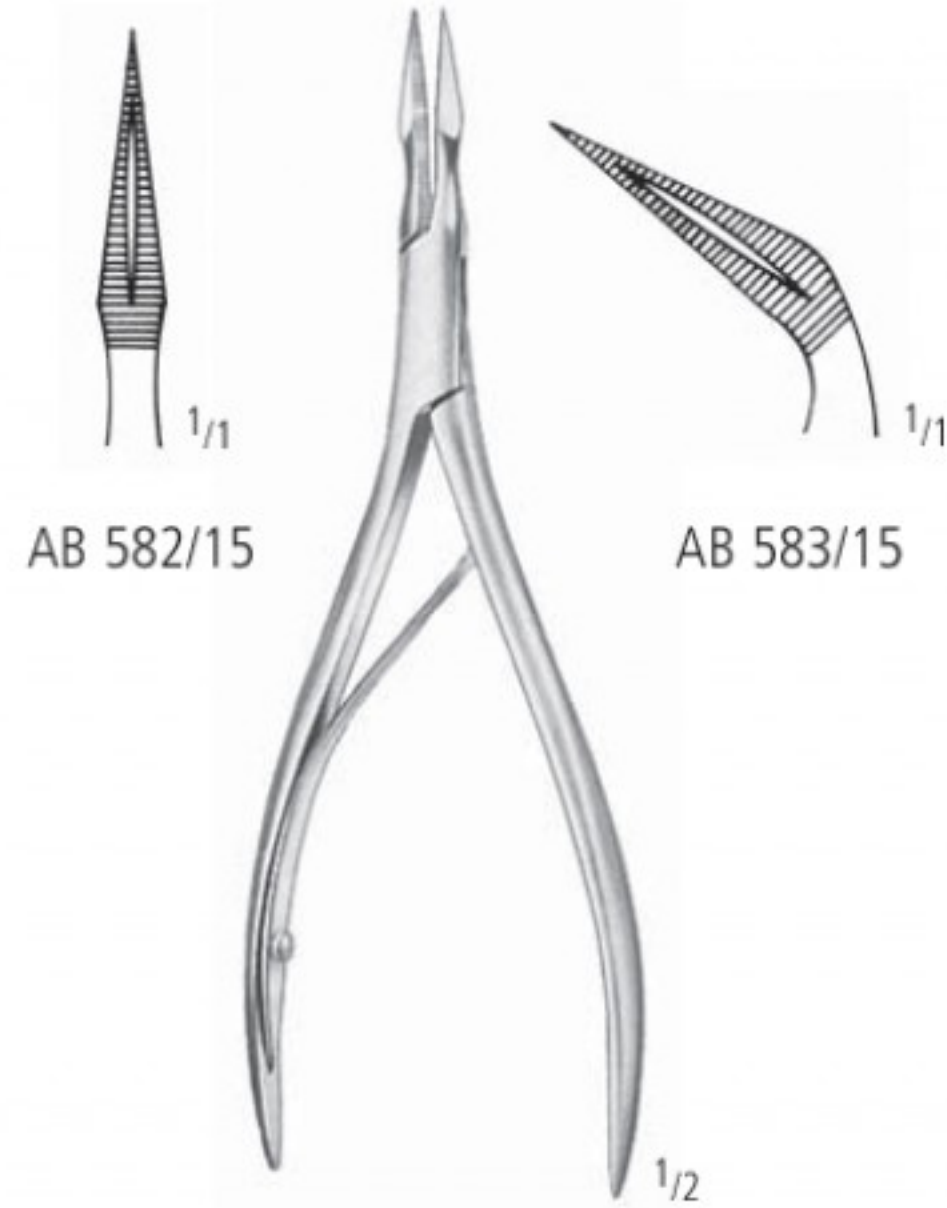

AB 582/15

AB 583/15

RALK
 15,0 cm/6"

AB PINZETTEN FORCEPS PINZAS PINCES PINZE

Cilienpinzetten
Cilia Forceps
Pinzas depilatorias
Pinces à épiler les cils
Pinze depilatorie



LITTAUER
AB 620/08
8,5 cm/3¹/₃"



AB 621/09
9,0 cm/3¹/₂"



DOUGLAS
AB 624/09
9,0 cm/3¹/₂"



BEER
AB 626/09
9,0 cm/3¹/₂"



ZIEGLER
AB 628/09
9,0 cm/3¹/₂"



BARRAQUER
AB 633/10
10,5 cm/4¹/₄"

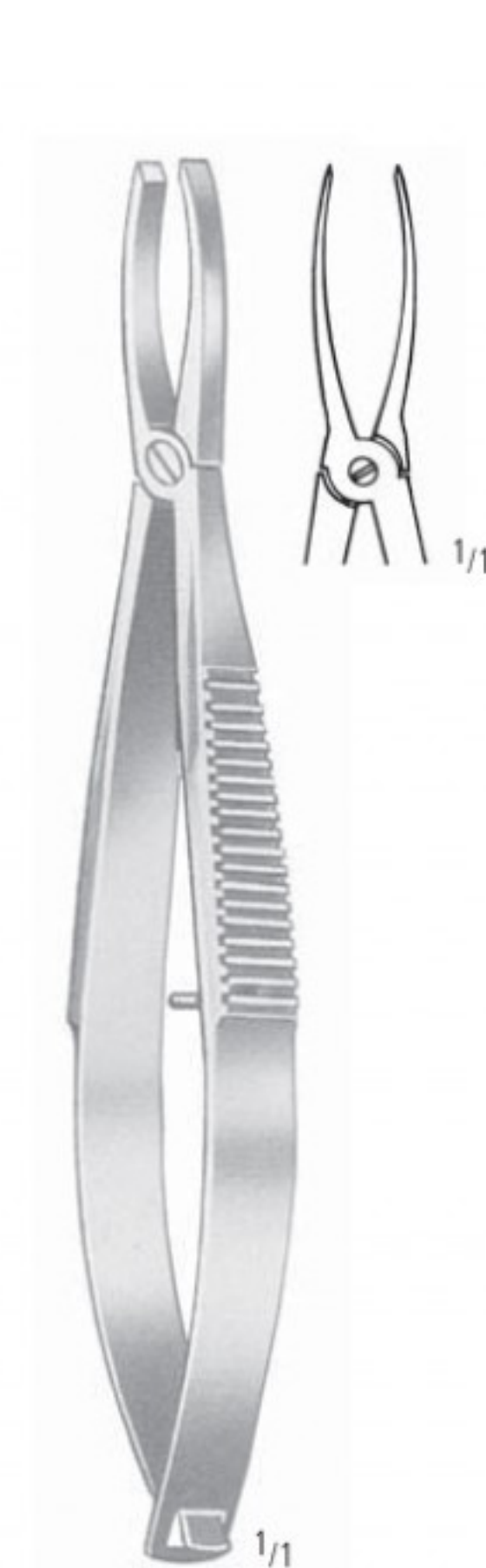

GRADLE
AB 635/09
9,5 cm/3³/₄"

PINZETTEN FORCEPS PINZAS PINCES PINZE

Ohr- und Nasenpinzetten
 Ear and Nose Dressing Forceps
 Pinzas auriculares y nasales
 Pincès auriculaires et nasales
 Pinze auricolare e nasale

AA

AB

AC

AD

AE

AF

AK

AL

AM

AO

AP

AR

KA

KB

KC

KD

KU

KY



AB 650/11



AB 652/12



TROELTSCH (WILDE)

Mod. Jalasvirta

AB 654/11

AB 654/13

11,0 cm/4¹/₃"

13,0 cm/5"

11,0 cm/4¹/₃"
 12,0 cm/4³/₄"
 15,0 cm/6"
 18,0 cm/7"

TROELTSCH (WILDE)

AB 650/11

AB 650/12

AB 650/15

AB 650/18

TROELTSCH (WILDE) 1:2

AB 652/12

AB 652/15

AB 652/18



LUCAE

AB 656/14

14,0 cm/5¹/₂"



LUCAE 1:2

AB 658/14

14,0 cm/5¹/₂"



AB 660/18

JANSEN

16,0 cm/6¹/₄"

AB 660/16

18,0 cm/7"

AB 660/18

20,0 cm/8"

AB 660/20



COTTLE

AB 665/14

14,0 cm/5¹/₂"

AB PINZETTEN FORCEPS PINZAS PINCES PINZE

Tamponpinzetten, Deckglaspinzetten
 Dressing and Tampon Forceps, Cover Glass Forceps
 Pinzas para compresas y tamponamientos, Pinzas porta-laminillas
 Pincès à pansements, Pincès porte-lamelles
 Pinze per medicature, Pinze porta-lamelle



GRUENWALD (JANSEN)
 AB 690/20
 20,0 cm/8"



GRUENWALD 1:2
 AB 692/20
 20,0 cm/8"

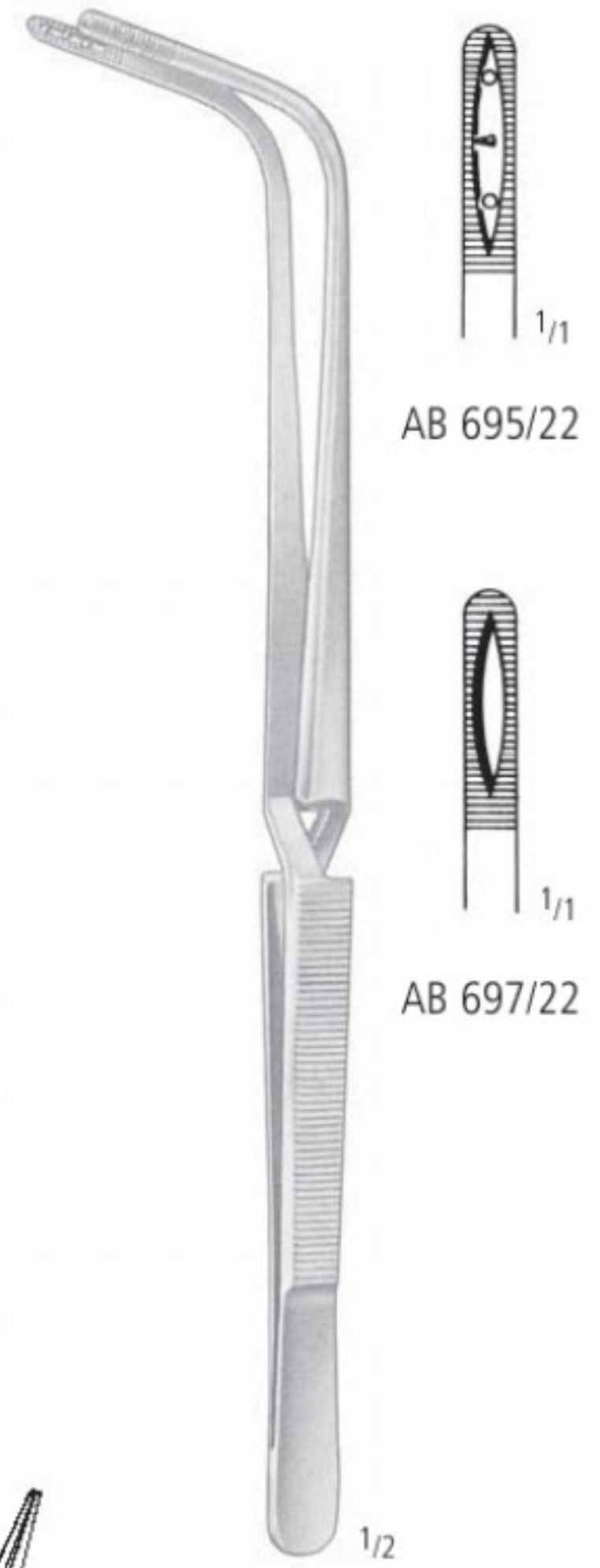

JACKSON
 22,0 cm/8³/₄"



KUEHNE
 AB 698/10
 10,5 cm/4¹/₄"



KUEHNE
 AB 699/10
 10,5 cm/4¹/₄"

PINZETTEN FORCEPS PINZAS PINCES PINZE

Irispinzetten
Iris Forceps
Pinzas para iris
Pinces à iris
Pinze per iride



AB 700/07

GRAEFE
7,0 cm/2³/₄"
AB 700/05
AB 700/07
AB 700/10

0,5 mm
0,7 mm
1,0 mm



AB 701/07

GRAEFE
7,0 cm/2³/₄"
AB 701/05
AB 701/07
AB 701/10



AB 702/07

GRAEFE 1:2
7,0 cm/2³/₄"
AB 702/05
AB 702/07
AB 702/10

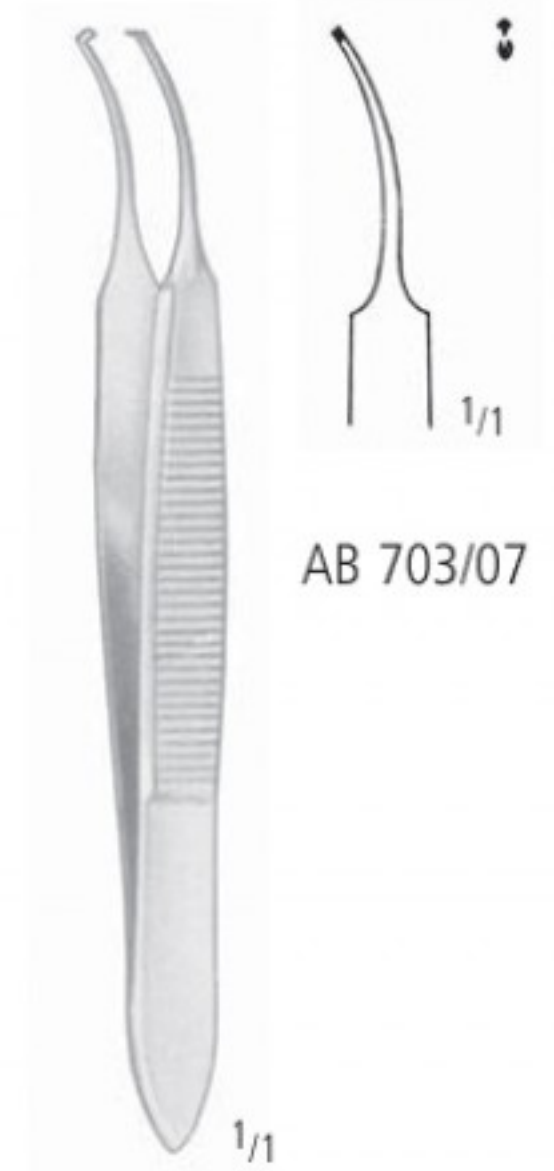

AB 703/07

GRAEFE 1:2
7,0 cm/2³/₄"
AB 703/05
AB 703/07
AB 703/10



7,0 cm/2³/₄"
10,0 cm/4"

GRAEFE

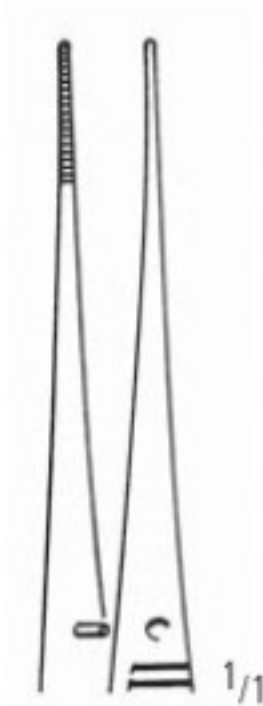

AB 710/07
AB 710/10

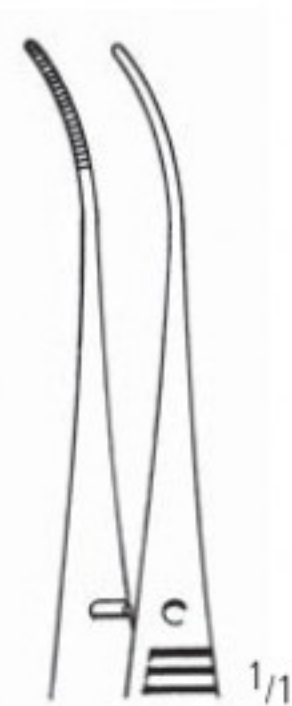

AB 711/07
AB 711/10

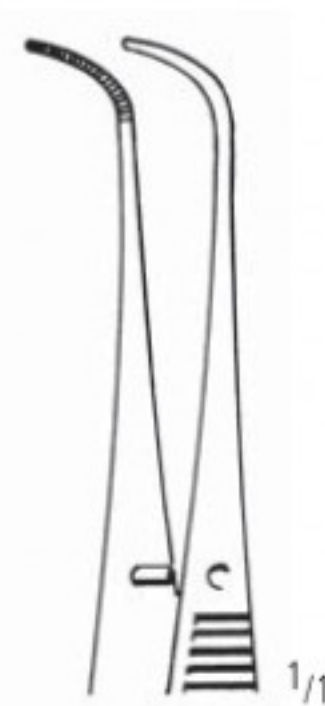

AB 713/07
AB 713/10

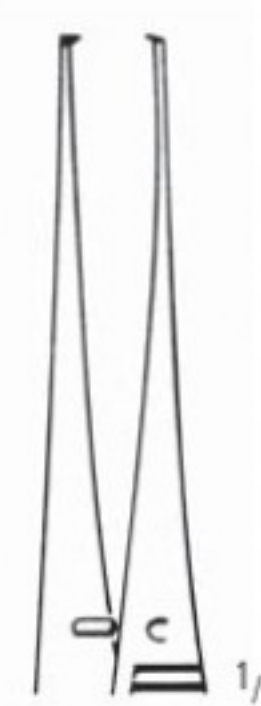

AB 714/07
AB 714/10

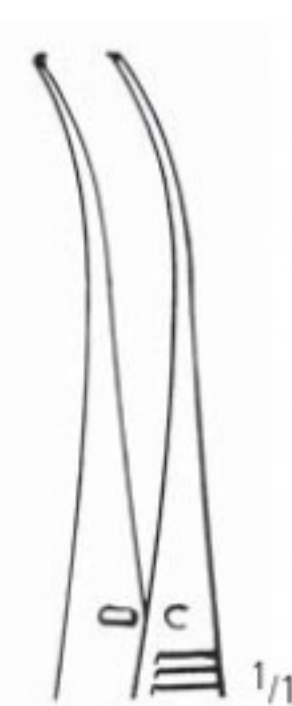

AB 715/07
AB 715/10

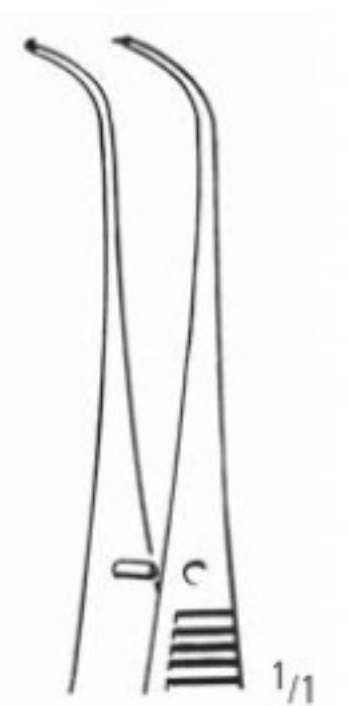

AB 717/07
AB 717/10

AA
AB
AC
AD
AE
AF
AG
AH
AI
AJ
AK
AL
AM
AN
AO
AP
AQ
AR
AS
AT
AU
AV
AW
AX
AY
AZ
BA
BB
BC
BD
BE
BF
BG
BH
BI
BJ
BK
BL
BM
BN
BO
BP
BQ
BR
BS
BT
BU
BV
BW
BX
BY
BZ
CA
CB
CC
CD
CE
CF
CG
CH
CI
CJ
CK
CL
CM
CN
CO
CP
CQ
CR
CS
CT
CU
CV
CW
CX
CY
CZ
DA
DB
DC
DD
DE
DF
DG
DH
DI
DJ
DK
DL
DM
DN
DO
DP
DQ
DR
DS
DT
DU
DV
DW
DX
DY
DZ
EA
EB
EC
ED
EE
EF
EG
EH
EI
EJ
EK
EL
EM
EN
EO
EP
EQ
ER
ES
ET
EU
EV
EW
EX
EY
EZ
FA
FB
FC
FD
FE
FF
FG
FH
FI
FJ
FK
FL
FM
FN
FO
FP
FQ
FR
FS
FT
FU
FV
FW
FX
FY
FZ
GA
GB
GC
GD
GE
GF
GG
GH
GI
GJ
GK
GL
GM
GN
GO
GP
GQ
GR
GS
GT
GU
GV
GW
GX
GY
GZ
HA
HB
HC
HD
HE
HF
HG
HH
HI
HJ
HK
HL
HM
HN
HO
HP
HQ
HR
HS
HT
HU
HV
HW
HX
HY
HZ
IA
IB
IC
ID
IE
IF
IG
IH
II
IJ
IK
IL
IM
IN
IO
IP
IQ
IR
IS
IT
IU
IV
IW
IX
IY
IZ
JA
JB
JC
JD
JE
JF
JG
JH
JI
JJ
JK
JL
JM
JN
JO
JP
JQ
JR
JS
JT
JU
JV
JW
JX
JY
JZ
KA
KB
KC
KD
KE
KF
KG
KH
KI
KJ
KK
KL
KM
KN
KO
KP
KQ
KR
KS
KT
KU
KV
KW
KX
KY
KZ
LA
LB
LC
LD
LE
LF
LG
LH
LI
LJ
LK
LL
LM
LN
LO
LP
LQ
LR
LS
LT
LU
LV
LW
LX
LY
LZ
MA
MB
MC
MD
ME
MF
MG
MH
MI
MJ
MK
ML
MM
MN
MO
MP
MQ
MR
MS
MT
MU
MV
MW
MX
MY
MZ
NA
NB
NC
ND
NE
NF
NG
NH
NI
NJ
NK
NL
NM
NN
NO
NP
NQ
NR
NS
NT
NU
NV
NW
NX
NY
NZ
OA
OB
OC
OD
OE
OF
OG
OH
OI
OJ
OK
OL
OM
ON
OO
OP
OQ
OR
OS
OT
OU
OV
OW
OX
OY
OZ
PA
PB
PC
PD
PE
PF
PG
PH
PI
PJ
PK
PL
PM
PN
PO
PP
PQ
PR
PS
PT
PU
PV
PW
PX
PY
PZ
QA
QB
QC
QD
QE
QF
QG
QH
QI
QJ
QK
QL
QM
QN
QO
QP
QQ
QR
QS
QT
QU
QV
QW
QX
QY
QZ
RA
RB
RC
RD
RE
RF
RG
RH
RI
RJ
RK
RL
RM
RN
RO
RP
RQ
RR
RS
RT
RU
RV
RW
RX
RY
RZ
SA
SB
SC
SD
SE
SF
SG
SH
SI
SJ
SK
SL
SM
SN
SO
SP
SQ
SR
SS
ST
SU
SV
SW
SX
SY
SZ
TA
TB
TC
TD
TE
TF
TG
TH
TI
TJ
TK
TL
TM
TN
TO
TP
TQ
TR
TS
TT
TU
TV
TW
TX
TY
TZ
UA
UB
UC
UD
UE
UF
UG
UH
UI
UJ
UK
UL
UM
UN
UO
UP
UQ
UR
US
UT
UU
UV
UW
UX
UY
UZ
VA
VB
VC
VD
VE
VF
VG
VH
VI
VJ
VK
VL
VM
VN
VO
VP
VQ
VR
VS
VT
VU
VV
VW
VX
VY
VZ
WA
WB
WC
WD
WE
WF
WG
WH
WI
WJ
WK
WL
WM
WN
WO
WP
WQ
WR
WS
WT
WU
WV
WW
WX
WY
WZ
XA
XB
XC
XD
XE
XF
XG
XH
XI
XJ
XK
XL
XM
XN
XO
XP
XQ
XR
XS
XT
XU
XV
XW
XX
XY
XZ
YA
YB
YC
YD
YE
YF
YG
YH
YI
YJ
YK
YL
YM
YN
YO
YP
YQ
YR
YS
YT
YU
YV
YW
YX
YY
YZ
ZA
ZB
ZC
ZD
ZE
ZF
ZG
ZH
ZI
ZJ
ZK
ZL
ZM
ZN
ZO
ZP
ZQ
ZR
ZS
ZT
ZU
ZV
ZW
ZX
ZY
ZZ

AB PINZETTEN FORCEPS PINZAS PINCES PINZE

Irispinzetten
Iris Forceps
Pinzas para iris
Pinces à iris
Pinze per iride



STEVENS 1:2
AB 718/01
11,0 cm/4¹/₃"



STEVENS 1:2
AB 718/02
11,0 cm/4¹/₃"



STEVENS
10,5 cm/4¹/₄"

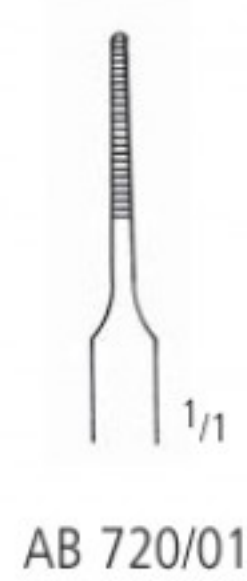

AB 720/01



AB 720/02

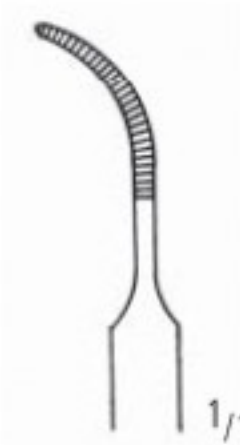

AB 720/03

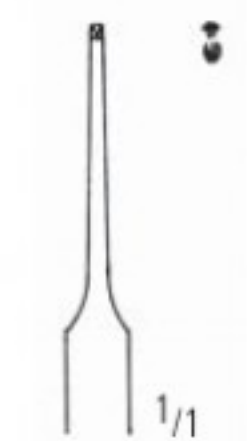

AB 721/01 1:2



AB 721/02 1:2



AB 721/03 1:2

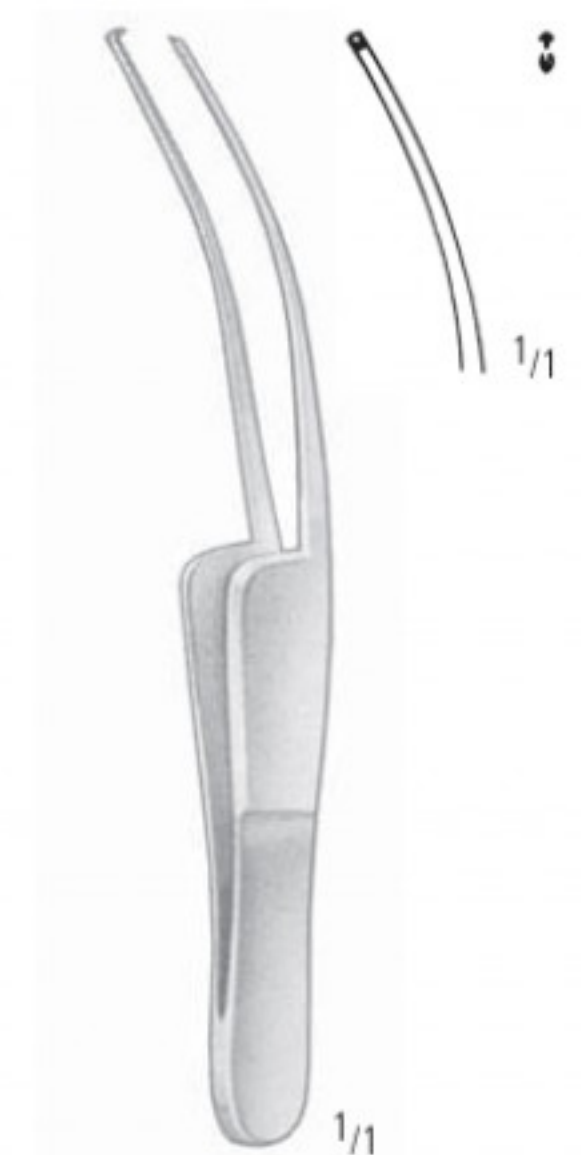

FISCHER-ARLT 1:2
AB 723/07
7,0 cm/2³/₄"

PINZETTEN FORCEPS PINZAS PINCES PINZE

Irispinzetten
Iris Forceps
Pinzas para iris
Pinces à iris
Pinze per iride

AA

AB

AC

AD

AE

AF

AK

AL

AM

AO

AP

AR

KA

KB

KC

KD

KU

KY



FOERSTER
AB 726/08
8,5 cm/3¹/₃"



FOERSTER
AB 727/08
8,5 cm/3¹/₃"



FOERSTER 1:2
AB 728/08
8,5 cm/3¹/₃"



FOERSTER 1:2
AB 729/08
8,5 cm/3¹/₃"



HESS 1:2
AB 730/07
7,0 cm/2³/₄"



HESS 1:2
AB 731/09
9,0 cm/3¹/₂"



MOD. BONN 1:2
AB 734/01
7,0 cm/2³/₄"



MOD. BONN 1:2
AB 734/02
7,0 cm/2³/₄"



MOD. BONN
AB 735/01 AB 735/02
7,0 cm/2³/₄"

AB PINZETTEN FORCEPS PINZAS PINCES PINZE

Irispinzetten
Iris Forceps
Pinzas para iris
Pincas à iris
Pinze per iride



BISHOP-HARMAN 1:2

AB 736/08
8,5 cm/3¹/₃"

AB 738/08
8,5 cm/3¹/₃"

BISHOP-HARMAN 1:2

AB 740/08
8,5 cm/3¹/₃"

AB 742/08
8,5 cm/3¹/₃"

KIRBY 1:2

AB 748/09
9,0 cm/3¹/₂"

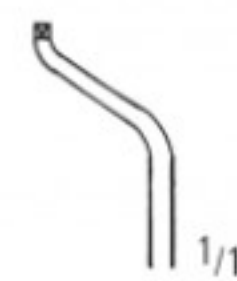

AB 756/07

Zähne seitwärts
teeth on side
dientes laterales
dents latérales
denti laterali

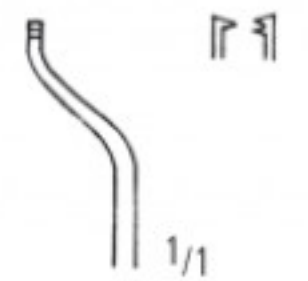

AB 757/07

Zähne unten
teeth below
dientes inferiores
dents en bas
denti in basso

BARRAQUER-KATZIN 1:2 (Colibri)
AB 750/07
7,0 cm/2³/₄"

TROUTMAN 1:2 (Corneal)
AB 751/07
7,5 cm/3"

BARRAQUER-KATZIN 1:2 (Colibri)
AB 752/07
7,0 cm/2³/₄"

GILL-HESS 1:2
7,5 cm/3"

PINZETTEN FORCEPS PINZAS PINCES PINZE

Kapselpinzetten
Capsular Forceps
Pinzas capsulares
Pincas capsulaires
Pinze capsulari



GILL 1:2
AB 762/07
7,5 cm/3"



GILL-FUCHS
AB 763/07
7,5 cm/3"



TERSON
AB 765/09
9,0 cm/3 1/2"



CASTROVIEJO
AB 767/01
10,0 cm/4"



CASTROVIEJO
AB 767/02
10,0 cm/4"



ungeeicht
not calibrated
non calibrada
non calibrée
non calibrata

AB 768/01



geeicht
calibrated
calibrada
calibrée
calibrata

AB 768/02

ARRUGA
10,0 cm/4"



ungeeicht
not calibrated
non calibrada
non calibrée
non calibrata

AB 769/01

ARRUGA
10,0 cm/4"



geeicht
calibrated
calibrada
calibrée
calibrata

AB 769/02



BINKHORST
AB 770/07
7,0 cm/2 3/4"

AA
AB
AC
AD
AE
AF
AK
AL
AM
AO
AP
AR
KA
KB
KC
KD
KU
KY

AB PINZETTEN FORCEPS PINZAS PINCES PINZE

Fixierpinzetten
Fixation Forceps
Pinzas de fijación
Pincés à fixer
Pinze fissatrici

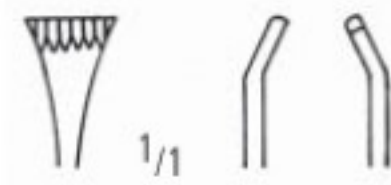

AB 785/01
ohne Schloss
without spring catch
sin cierre de resorte
sans arrêt à ressort
senza arresto a molla

AB 785/02
mit Schloss
with spring catch
con cierre de resorte
avec arrêt à ressort
con arresto a molla

GRAEFE
11,0 cm/4¹/₃"

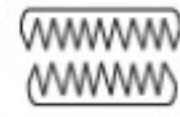

AB 786/01
5 mm

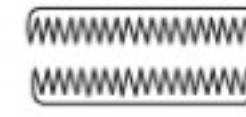

AB 786/02
10 mm

GREEN
10,0 cm/4"

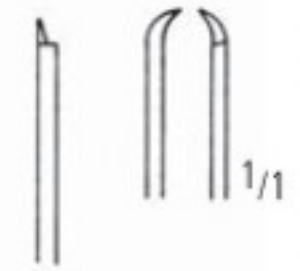

AB 790/09



AB 791/09

CASTROVIEJO 1:1
9,0 cm/3¹/₂"

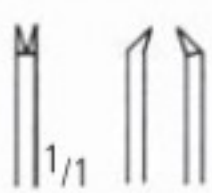

ELSCHNIG 1:2
AB 792/11
11,0 cm/4¹/₃"

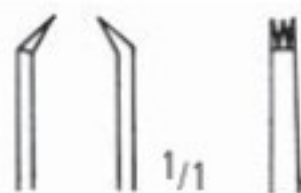

ELSCHNIG 2:3
AB 793/11
11,0 cm/4¹/₃"



ELSCHNIG 3:4
AB 794/11
11,0 cm/4¹/₃"

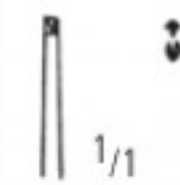

1:2
AB 796/02



2:3
AB 796/03

LESTER
9,0 cm/3¹/₂"



MOORFIELD
AB 798/10
10,0 cm/4"

PINZETTEN FORCEPS PINZAS PINCES PINZE

Nahtpinzetten
Suture Forceps
Pinzas para sutura
Pinces pour sutures
Pinze per sutura

Vorderkammer-Pinzetten
Anterior Chamber Forceps
Pinzas para la cámara anterior
Pinces pour la chambre antérieure
Pinze per la camera anteriore

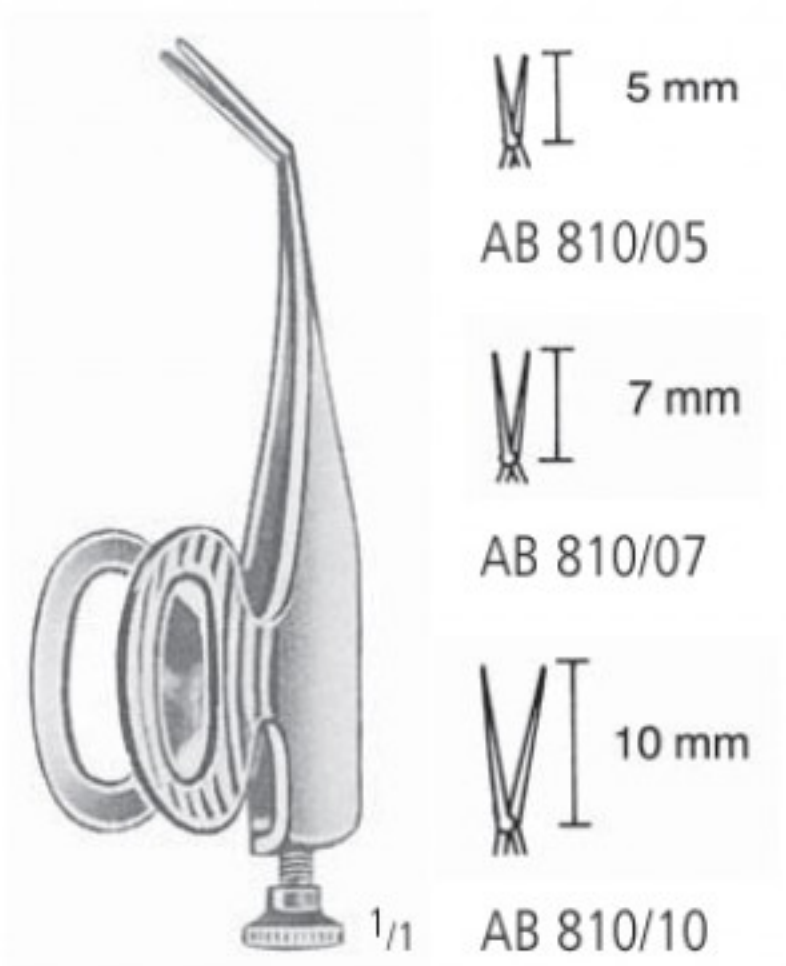

BARRAQUER
5,5 cm/2¹/₄"

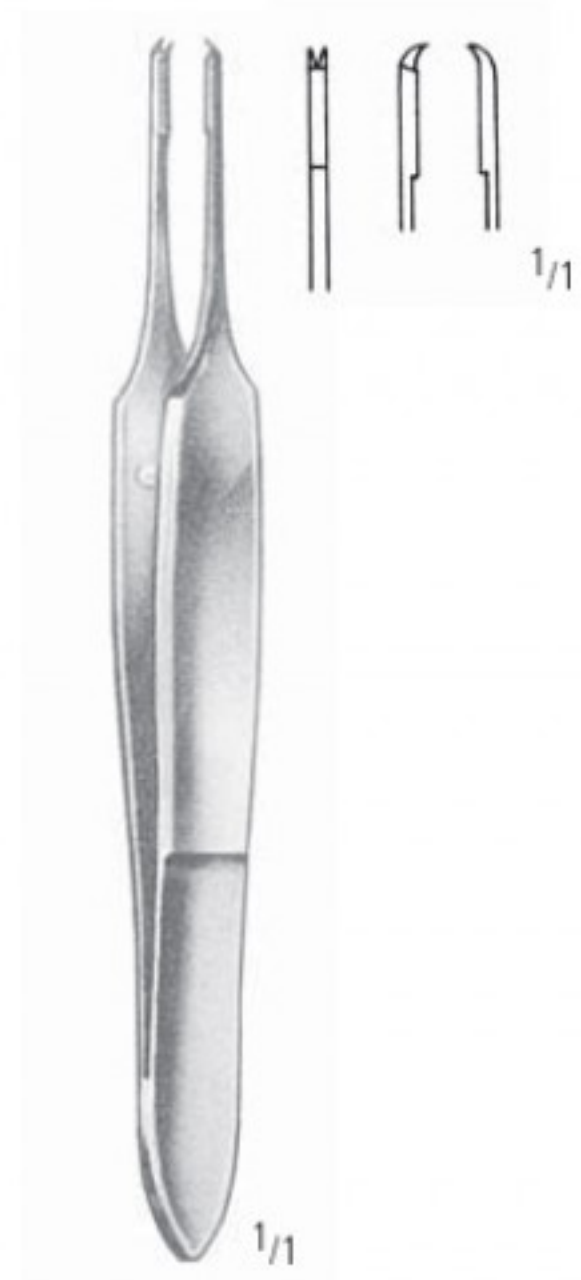

ST. MARTIN 1:2
AB 812/07
7,0 cm/2³/₄"



0,12 mm
0,30 mm
0,50 mm
1,00 mm
1,50 mm

AB 816/01
AB 816/03
AB 816/05
AB 816/10
AB 816/15

CASTROVIEJO 1:2
10,0 cm/4"



AB 817/01
AB 817/03
AB 817/05
AB 817/10
AB 817/15

CASTROVIEJO 1:2
10,0 cm/4"



McPHERSON
10,0 cm/4"



KELMAN-McPHERSON 1:2
AB 820/10
10,0 cm/4"



BONACCOLTO
AB 824/01
10,0 cm/4"



BONACCOLTO
AB 824/02
10,0 cm/4"

AA
AB
AC
AD
AE
AF
AG
AH
AI
AJ
AK
AL
AM
AN
AO
AP
AQ
AR
AS
AT
AU
AV
AW
AX
AY
AZ
BA
BB
BC
BD
BE
BF
BG
BH
BI
BJ
BK
BL
BM
BN
BO
BP
BQ
BR
BS
BT
BU
BV
BW
BX
BY
BZ
CA
CB
CC
CD
CE
CF
CG
CH
CI
CJ
CK
CL
CM
CN
CO
CP
CQ
CR
CS
CT
CU
CV
CW
CX
CY
CZ
DA
DB
DC
DD
DE
DF
DG
DH
DI
DJ
DK
DL
DM
DN
DO
DP
DQ
DR
DS
DT
DU
DV
DW
DX
DY
DZ
EA
EB
EC
ED
EE
EF
EG
EH
EI
EJ
EK
EL
EM
EN
EO
EP
EQ
ER
ES
ET
EU
EV
EW
EX
EY
EZ
FA
FB
FC
FD
FE
FF
FG
FH
FI
FJ
FK
FL
FM
FN
FO
FP
FQ
FR
FS
FT
FU
FV
FW
FX
FY
FZ
GA
GB
GC
GD
GE
GF
GG
GH
GI
GJ
GK
GL
GM
GN
GO
GP
GQ
GR
GS
GT
GU
GV
GW
GX
GY
GZ
HA
HB
HC
HD
HE
HF
HG
HH
HI
HJ
HK
HL
HM
HN
HO
HP
HQ
HR
HS
HT
HU
HV
HW
HX
HY
HZ
IA
IB
IC
ID
IE
IF
IG
IH
II
IJ
IK
IL
IM
IN
IO
IP
IQ
IR
IS
IT
IU
IV
IW
IX
IY
IZ
JA
JB
JC
JD
JE
JF
JG
JH
JI
JJ
JK
JL
JM
JN
JO
JP
JQ
JR
JS
JT
JU
JV
JW
JX
JY
JZ
KA
KB
KC
KD
KE
KF
KG
KH
KI
KJ
KK
KL
KM
KN
KO
KP
KQ
KR
KS
KT
KU
KV
KW
KX
KY
KZ
LA
LB
LC
LD
LE
LF
LG
LH
LI
LJ
LK
LL
LM
LN
LO
LP
LQ
LR
LS
LT
LU
LV
LW
LX
LY
LZ
MA
MB
MC
MD
ME
MF
MG
MH
MI
MJ
MK
ML
MM
MN
MO
MP
MQ
MR
MS
MT
MU
MV
MW
MX
MY
MZ
NA
NB
NC
ND
NE
NF
NG
NH
NI
NJ
NK
NL
NM
NN
NO
NP
NQ
NR
NS
NT
NU
NV
NW
NX
NY
NZ
OA
OB
OC
OD
OE
OF
OG
OH
OI
OJ
OK
OL
OM
ON
OO
OP
OQ
OR
OS
OT
OU
OV
OW
OX
OY
OZ
PA
PB
PC
PD
PE
PF
PG
PH
PI
PJ
PK
PL
PM
PN
PO
PP
PQ
PR
PS
PT
PU
PV
PW
PX
PY
PZ
QA
QB
QC
QD
QE
QF
QG
QH
QI
QJ
QK
QL
QM
QN
QO
QP
QQ
QR
QS
QT
QU
QV
QW
QX
QY
QZ
RA
RB
RC
RD
RE
RF
RG
RH
RI
RJ
RK
RL
RM
RN
RO
RP
RQ
RR
RS
RT
RU
RV
RW
RX
RY
RZ
SA
SB
SC
SD
SE
SF
SG
SH
SI
SJ
SK
SL
SM
SN
SO
SP
SQ
SR
SS
ST
SU
SV
SW
SX
SY
SZ
TA
TB
TC
TD
TE
TF
TG
TH
TI
TJ
TK
TL
TM
TN
TO
TP
TQ
TR
TS
TT
TU
TV
TW
TX
TY
TZ
UA
UB
UC
UD
UE
UF
UG
UH
UI
UJ
UK
UL
UM
UN
UO
UP
UQ
UR
US
UT
UU
UV
UW
UX
UY
UZ
VA
VB
VC
VD
VE
VF
VG
VH
VI
VJ
VK
VL
VM
VN
VO
VP
VQ
VR
VS
VT
VU
VV
VW
VX
VY
VZ
WA
WB
WC
WD
WE
WF
WG
WH
WI
WJ
WK
WL
WM
WN
WO
WP
WQ
WR
WS
WT
WU
WV
WW
WX
WY
WZ
XA
XB
XC
XD
XE
XF
XG
XH
XI
XJ
XK
XL
XM
XN
XO
XP
XQ
XR
XS
XT
XU
XV
XW
XX
XY
XZ
YA
YB
YC
YD
YE
YF
YG
YH
YI
YJ
YK
YL
YM
YN
YO
YP
YQ
YR
YS
YT
YU
YV
YW
YX
YY
YZ
ZA
ZB
ZC
ZD
ZE
ZF
ZG
ZH
ZI
ZJ
ZK
ZL
ZM
ZN
ZO
ZP
ZQ
ZR
ZS
ZT
ZU
ZV
ZW
ZX
ZY
ZZ

AB PINZETTEN FORCEPS PINZAS PINCES PINZE

Nahtpinzetten
Suture Forceps
Pinzas para sutura
Pincas pour sutures
Pinze per sutura



10 x
0,12 mm AB 825/01



MOD. BONN
10,0 cm/4"



AB 825/02



MOD. TÜBINGEN
AB 826/10
10,0 cm/4"



PAUFIQUE 1:2
AB 828/10
10,0 cm/4"

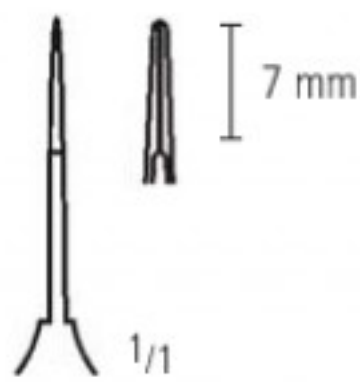
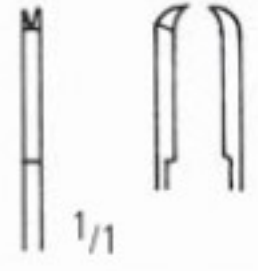

HARMs
AB 829/01
10,0 cm/4"

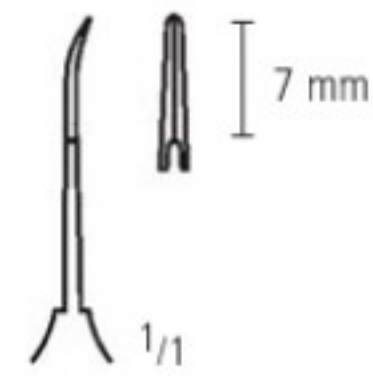

HARMs
AB 829/02
10,0 cm/4"

PINZETTEN FORCEPS PINZAS PINCES PINZE

Muskelpinzetten
Muscular Forceps
Pinzas musculares
Pincers musculaires
Pinze muscolare



SATTLER
AB 830/01
10,0 cm/4"

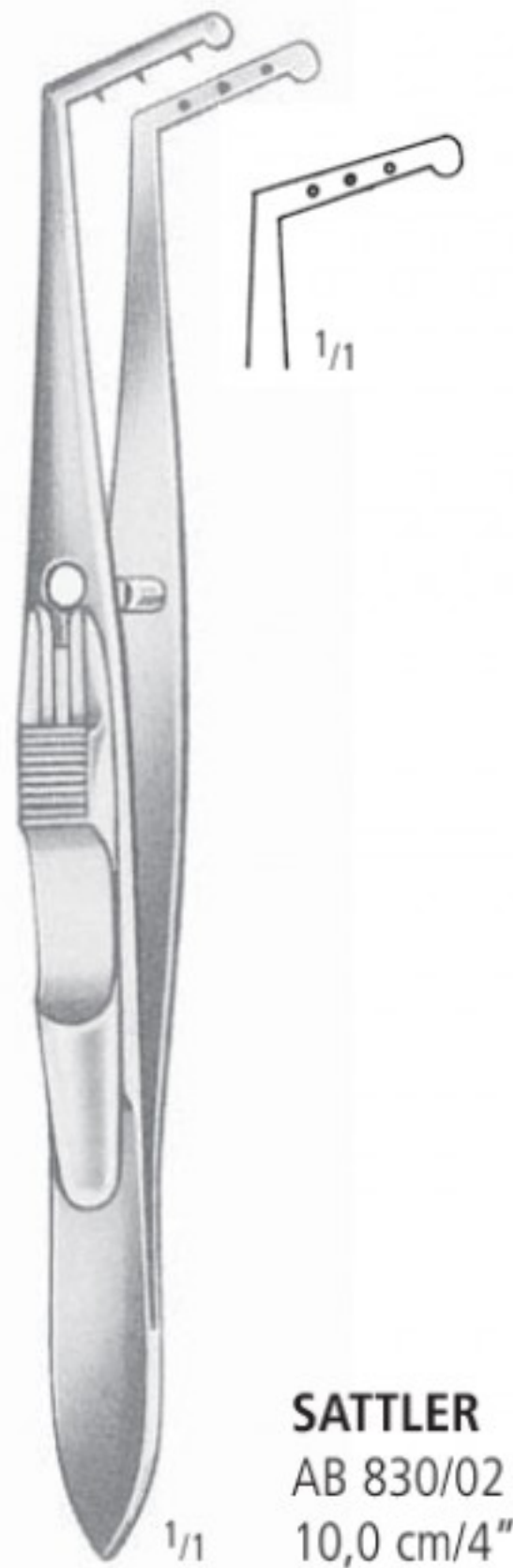

SATTLER
AB 830/02
10,0 cm/4"



BLASCOVICS
AB 832/01
9,0 cm/3 1/2"



BLASCOVICS
AB 832/02
9,0 cm/3 1/2"



JAMESON
AB 833/01
10,0 cm/4"



JAMESON
AB 833/02
10,0 cm/4"



PRINCE
AB 834/01
10,0 cm/4"



PRINCE
AB 834/02
10,0 cm/4"

AA
AB
AC
AD
AE
AF
AG
AH
AI
AJ
AK
AL
AM
AN
AO
AP
AQ
AR
AS
AT
AU
AV
AW
AX
AY
AZ
BA
BB
BC
BD
BE
BF
BG
BH
BI
BJ
BK
BL
BM
BN
BO
BP
BQ
BR
BS
BT
BU
BV
BW
BX
BY
BZ
CA
CB
CC
CD
CE
CF
CG
CH
CI
CJ
CK
CL
CM
CN
CO
CP
CQ
CR
CS
CT
CU
CV
CW
CX
CY
CZ
DA
DB
DC
DD
DE
DF
DG
DH
DI
DJ
DK
DL
DM
DN
DO
DP
DQ
DR
DS
DT
DU
DV
DW
DX
DY
DZ
EA
EB
EC
ED
EE
EF
EG
EH
EI
EJ
EK
EL
EM
EN
EO
EP
EQ
ER
ES
ET
EU
EV
EW
EX
EY
EZ
FA
FB
FC
FD
FE
FF
FG
FH
FI
FJ
FK
FL
FM
FN
FO
FP
FQ
FR
FS
FT
FU
FV
FW
FX
FY
FZ
GA
GB
GC
GD
GE
GF
GG
GH
GI
GJ
GK
GL
GM
GN
GO
GP
GQ
GR
GS
GT
GU
GV
GW
GX
GY
GZ
HA
HB
HC
HD
HE
HF
HG
HH
HI
HJ
HK
HL
HM
HN
HO
HP
HQ
HR
HS
HT
HU
HV
HW
HX
HY
HZ
IA
IB
IC
ID
IE
IF
IG
IH
II
IJ
IK
IL
IM
IN
IO
IP
IQ
IR
IS
IT
IU
IV
IW
IX
IY
IZ
JA
JB
JC
JD
JE
JF
JG
JH
JI
JJ
JK
JL
JM
JN
JO
JP
JQ
JR
JS
JT
JU
JV
JW
JX
JY
JZ
KA
KB
KC
KD
KE
KF
KG
KH
KI
KJ
KK
KL
KM
KN
KO
KP
KQ
KR
KS
KT
KU
KV
KW
KX
KY
KZ
LA
LB
LC
LD
LE
LF
LG
LH
LI
LJ
LK
LL
LM
LN
LO
LP
LQ
LR
LS
LT
LU
LV
LW
LX
LY
LZ
MA
MB
MC
MD
ME
MF
MG
MH
MI
MJ
MK
ML
MM
MN
MO
MP
MQ
MR
MS
MT
MU
MV
MW
MX
MY
MZ
NA
NB
NC
ND
NE
NF
NG
NH
NI
NJ
NK
NL
NM
NN
NO
NP
NQ
NR
NS
NT
NU
NV
NW
NX
NY
NZ
OA
OB
OC
OD
OE
OF
OG
OH
OI
OJ
OK
OL
OM
ON
OO
OP
OQ
OR
OS
OT
OU
OV
OW
OX
OY
OZ
PA
PB
PC
PD
PE
PF
PG
PH
PI
PJ
PK
PL
PM
PN
PO
PP
PQ
PR
PS
PT
PU
PV
PW
PX
PY
PZ
QA
QB
QC
QD
QE
QF
QG
QH
QI
QJ
QK
QL
QM
QN
QO
QP
QQ
QR
QS
QT
QU
QV
QW
QX
QY
QZ
RA
RB
RC
RD
RE
RF
RG
RH
RI
RJ
RK
RL
RM
RN
RO
RP
RQ
RR
RS
RT
RU
RV
RW
RX
RY
RZ
SA
SB
SC
SD
SE
SF
SG
SH
SI
SJ
SK
SL
SM
SN
SO
SP
SQ
SR
SS
ST
SU
SV
SW
SX
SY
SZ
TA
TB
TC
TD
TE
TF
TG
TH
TI
TJ
TK
TL
TM
TN
TO
TP
TQ
TR
TS
TT
TU
TV
TW
TX
TY
TZ
UA
UB
UC
UD
UE
UF
UG
UH
UI
UJ
UK
UL
UM
UN
UO
UP
UQ
UR
US
UT
UU
UV
UW
UX
UY
UZ
VA
VB
VC
VD
VE
VF
VG
VH
VI
VJ
VK
VL
VM
VN
VO
VP
VQ
VR
VS
VT
VU
VV
VW
VX
VY
VZ
WA
WB
WC
WD
WE
WF
WG
WH
WI
WJ
WK
WL
WM
WN
WO
WP
WQ
WR
WS
WT
WU
WV
WW
WX
WY
WZ
XA
XB
XC
XD
XE
XF
XG
XH
XI
XJ
XK
XL
XM
XN
XO
XP
XQ
XR
XS
XT
XU
XV
XW
XX
XY
XZ
YA
YB
YC
YD
YE
YF
YG
YH
YI
YJ
YK
YL
YM
YN
YO
YP
YQ
YR
YS
YT
YU
YV
YW
YX
YY
YZ
ZA
ZB
ZC
ZD
ZE
ZF
ZG
ZH
ZI
ZJ
ZK
ZL
ZM
ZN
ZO
ZP
ZQ
ZR
ZS
ZT
ZU
ZV
ZW
ZX
ZY
ZZ

AB PINZETTEN FORCEPS PINZAS PINCES PINZE

Muskel-, Entropium- und Chalazionpinzetten
 Muscular, Entropium and Chalazion Forceps
 Pinzas musculares, Pinzas de entropion y de chalazión
 Pincés musculaires, Pincés à entropion et à chalazion
 Pinze muscolare, Pinze per palpebre (entropio) e per calazio



BERENS
 AB 835/09
 8,5 cm/3¹/₃"



ERHARDT
 AB 836/09
 9,0 cm/3¹/₂"



SNELLEN
 AB 837/01
 10,0 cm/4"



SNELLEN
 AB 837/02
 10,0 cm/4"



AYER
 AB 838/01
 9,0 cm/3¹/₂"



AYER
 AB 838/02
 9,0 cm/3¹/₂"

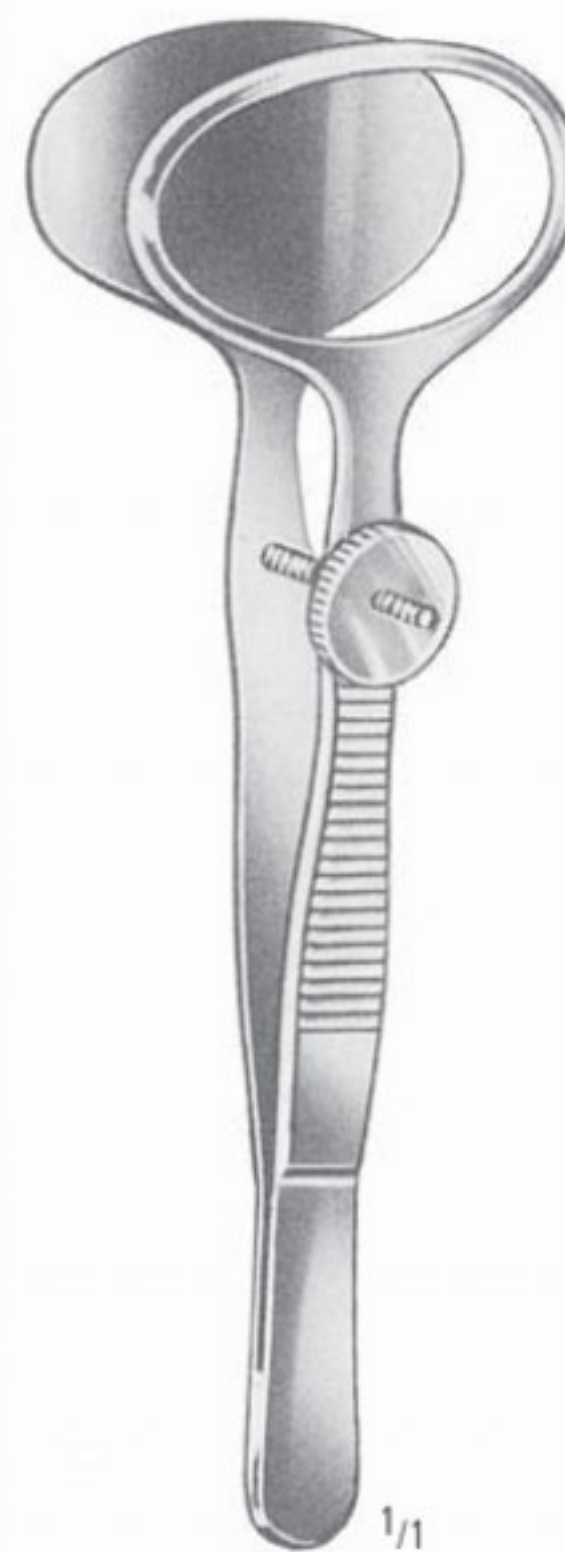

DESMARRES
 9,0 cm/3¹/₂"

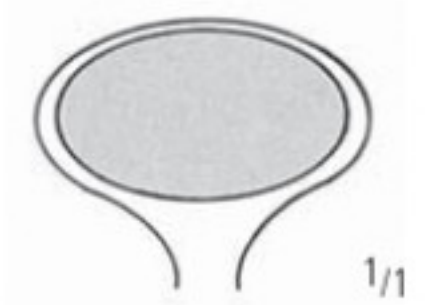

AB 840/01

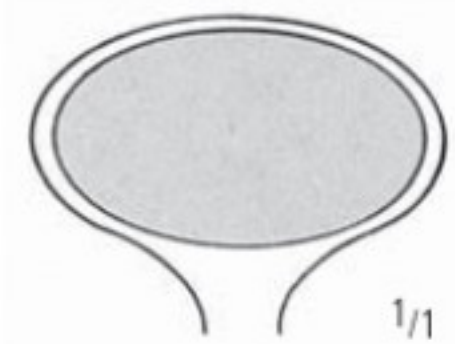

AB 840/02

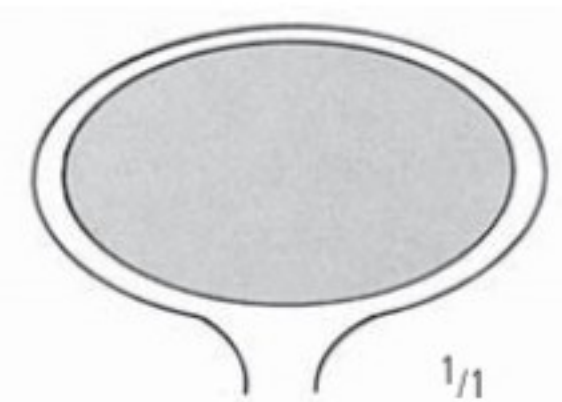

AB 840/03

PINZETTEN FORCEPS PINZAS PINCES PINZE

Chalazionpinzetten
Chalazion Forceps
Pinzas de chalazión
Pincès à chalazion
Pinze per calazio



LAMPERT
AB 841/01
9,0 cm/3¹/₂"



LAMPERT
AB 841/02
9,0 cm/3¹/₂"



BERKE
AB 844/20
11,0 cm/4¹/₃"
20 mm



BERKE
AB 844/27
11,0 cm/4¹/₃"
27 mm

AA
AB
AC
AD
AE
AF
AK
AL
AM
AO
AP
AR
KA
KB
KC
KD
KU
KY

Linsenhalte- und Kapsulorhexispinzetten
 Lens Holding and Capsulorhexis Forceps
 Pinzas para tener cristalino y capsulorhexis
 Pincès à tenir de cristallins et capsulorhexis
 Pinze per tenere il cristallino, Pinze capsulorhexis



FAULKNER
 AB 848/11
 11,0 cm/4¹/₃"



AB 852/01
 10,0 cm/4"



McDONALD
 AB 852/02
 10,0 cm/4"

PINZETTEN FORCEPS PINZAS PINCES PINZE

Atraumatische Pinzetten
 Non-traumatic Vascular Tissue Forceps
 Pinzas Atrauma
 Pincas Atrauma
 Pinze Atrauma

AA

AB

AC

AD

AE

AF

AK

AL

AM

AO

AP

AR

KA

KB

KC

KD

KU

KY

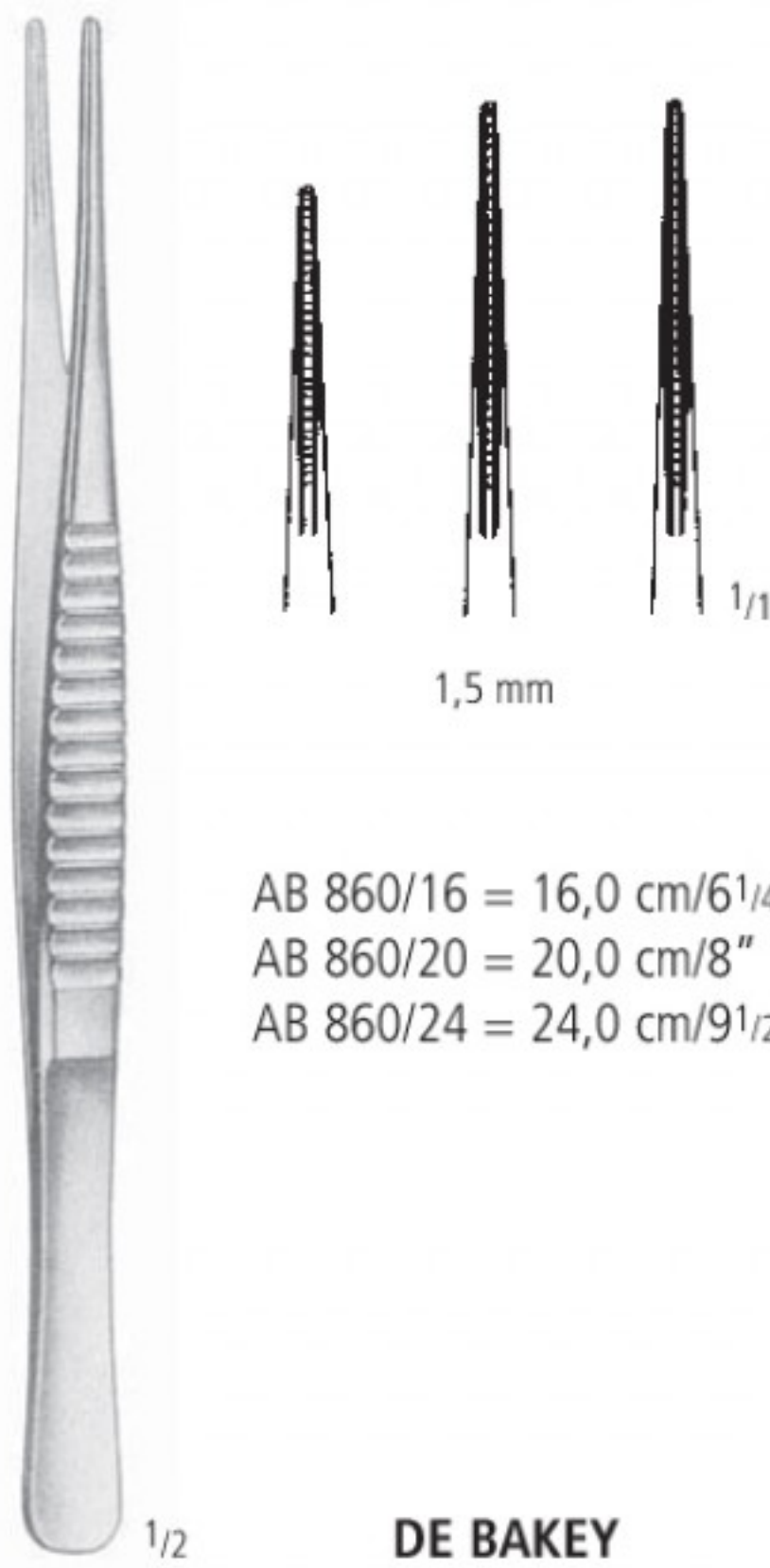

1,5 mm

AB 860/16 = 16,0 cm/6¹/₄"
 AB 860/20 = 20,0 cm/8"
 AB 860/24 = 24,0 cm/9¹/₂"

DE BAKAY

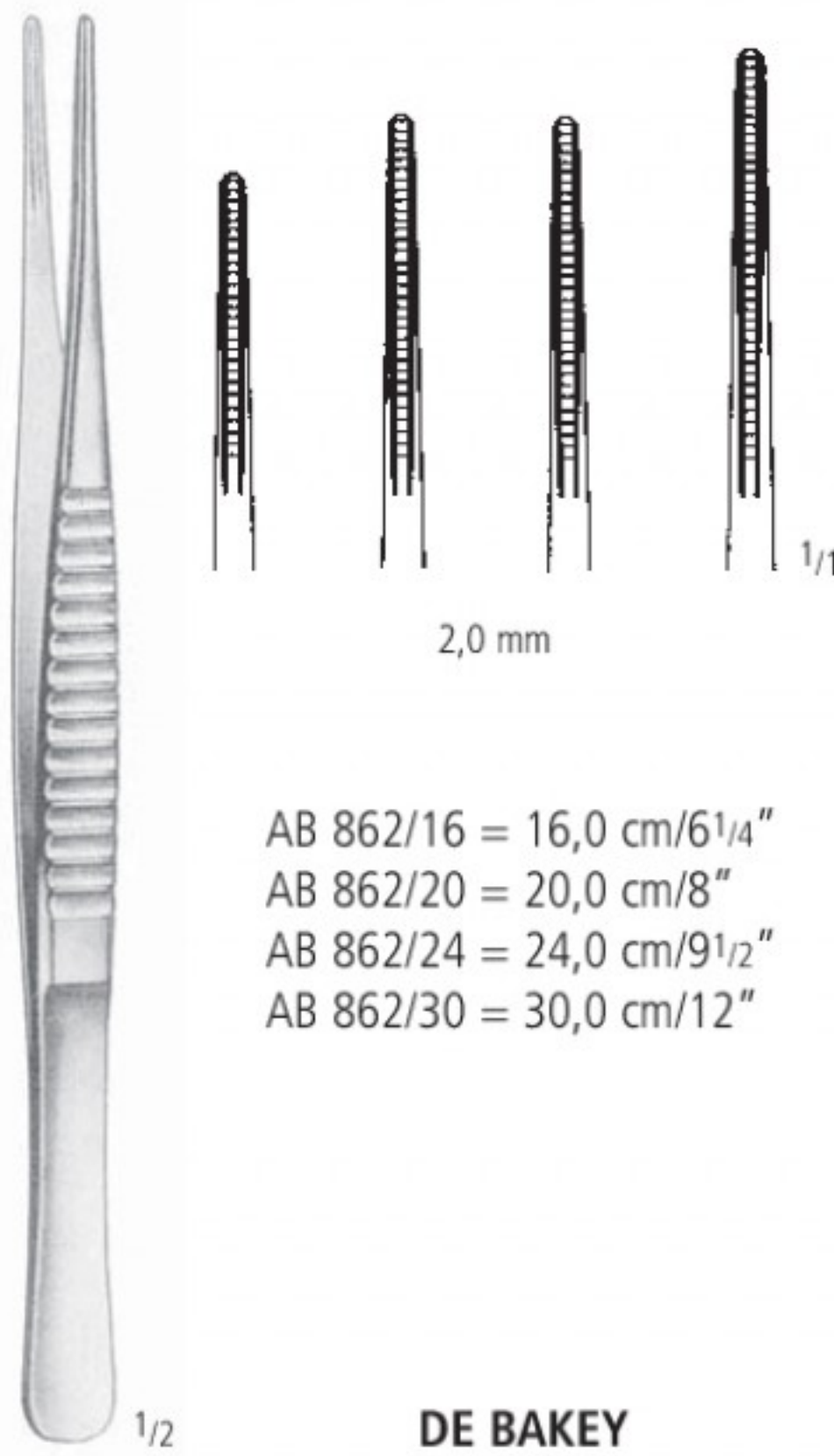

2,0 mm

AB 862/16 = 16,0 cm/6¹/₄"
 AB 862/20 = 20,0 cm/8"
 AB 862/24 = 24,0 cm/9¹/₂"
 AB 862/30 = 30,0 cm/12"

DE BAKAY

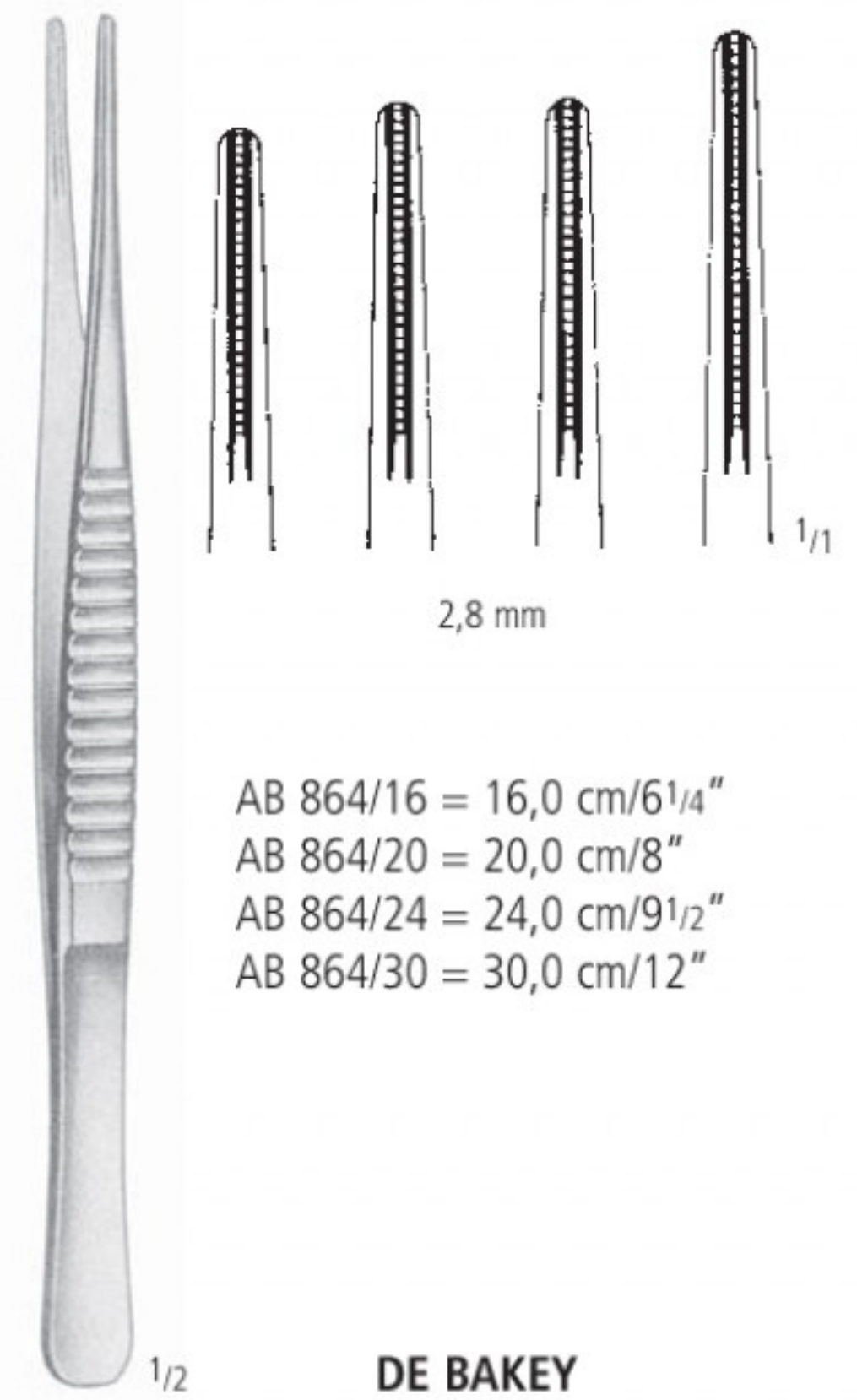

2,8 mm

AB 864/16 = 16,0 cm/6¹/₄"
 AB 864/20 = 20,0 cm/8"
 AB 864/24 = 24,0 cm/9¹/₂"
 AB 864/30 = 30,0 cm/12"

DE BAKAY

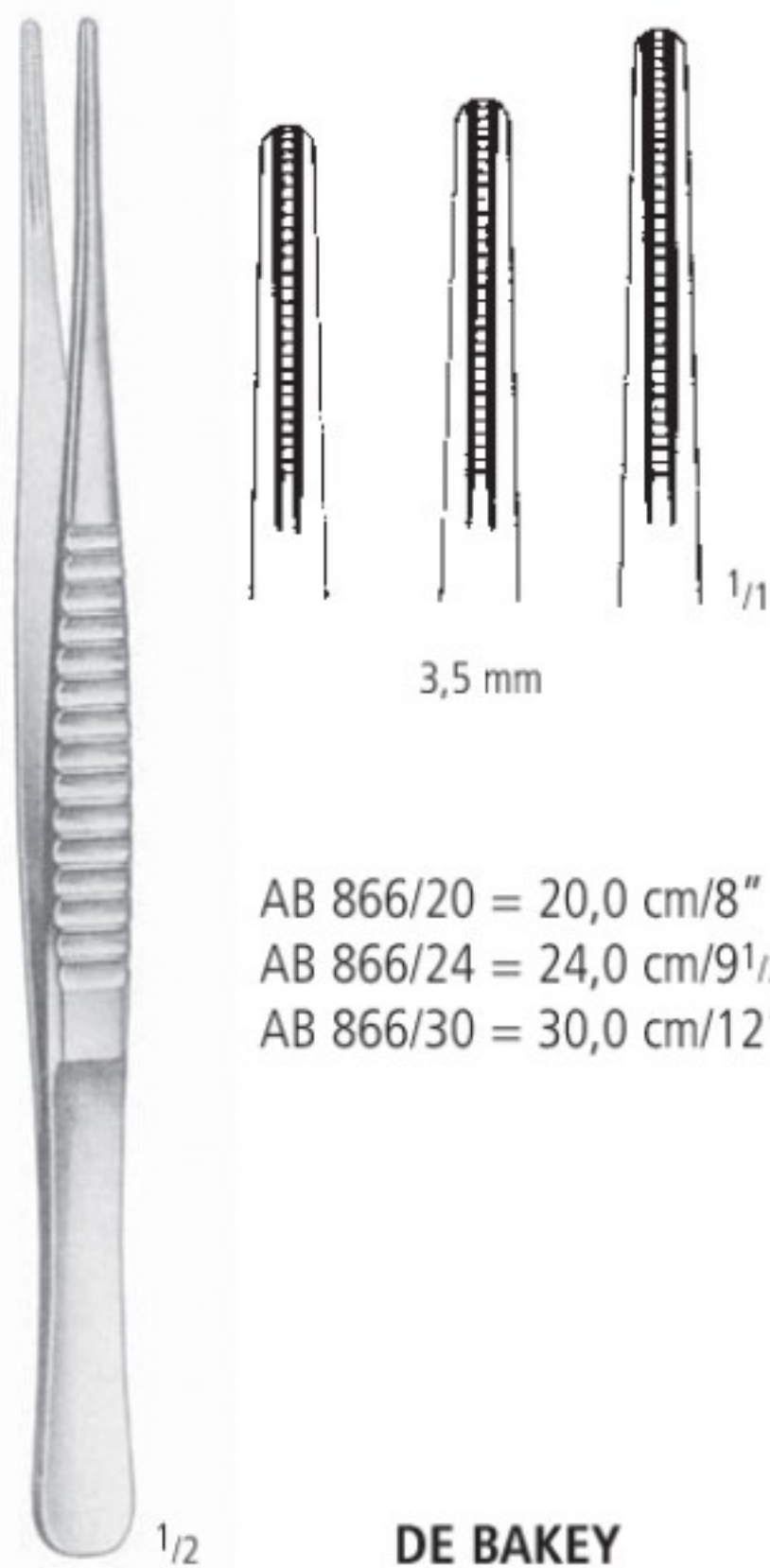

3,5 mm

AB 866/20 = 20,0 cm/8"
 AB 866/24 = 24,0 cm/9¹/₂"
 AB 866/30 = 30,0 cm/12"

DE BAKAY

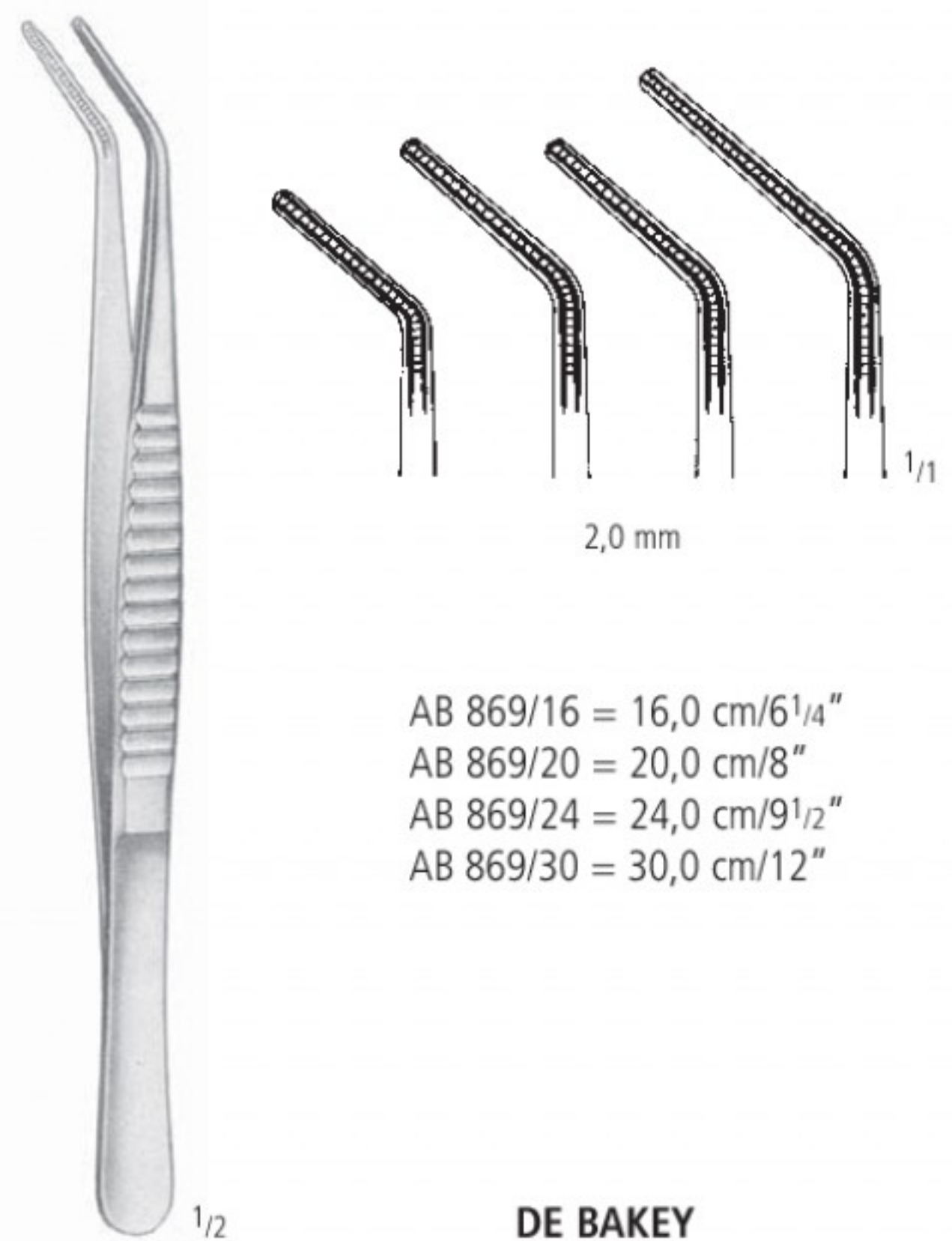

2,0 mm

AB 869/16 = 16,0 cm/6¹/₄"
 AB 869/20 = 20,0 cm/8"
 AB 869/24 = 24,0 cm/9¹/₂"
 AB 869/30 = 30,0 cm/12"

DE BAKAY

AB PINZETTEN FORCEPS PINZAS PINCES PINZE

Pinzetten mit Hartmetalleinsätzen
 Dissecting Forceps with Tungsten Carbide Inserts
 Pinzas de disección con bocas de carburo de tungsteno
 Pincés à dissection avec mors en carbure de tungstène
 Pinze per dissezione con punte di carburo di tungsteno



1/2

POTTS-SMITH



AB 880/15
15,0 cm/6"



AB 880/18
18,0 cm/7"



AB 880/20
20,0 cm/8"



AB 880/23
23,0 cm/9"



AB 880/25
25,0 cm/10"



1/2

OEHLER 1:2



AB 882/14
14,0 cm/5 1/2"



AB 882/16
16,0 cm/6 1/4"



AB 882/18
18,0 cm/7"



AB 882/20
20,0 cm/8"



AB 882/25
25,0 cm/10"



AB 882/30
30,0 cm/12"



1/2

SEMKEN

AB 890/12
AB 890/15



AB 890/12

12,5 cm/5"
15,5 cm/6"



1/2

GILLIES 1:2

AB 900/15
15,0 cm/6"



1/2

JEWELER

AB 902/15
15,0 cm/6"



PINZETTEN FORCEPS PINZAS PINCES PINZE

Pinzetten mit Hartmetalleinsätzen
 Dissecting Forceps with Tungsten Carbide Inserts
 Pinzas de disección con bocas de carburo de tungsteno
 Pincés à dissection avec mors en carbure de tungstène
 Pinze per dissezione con punte di carburo di tungsteno

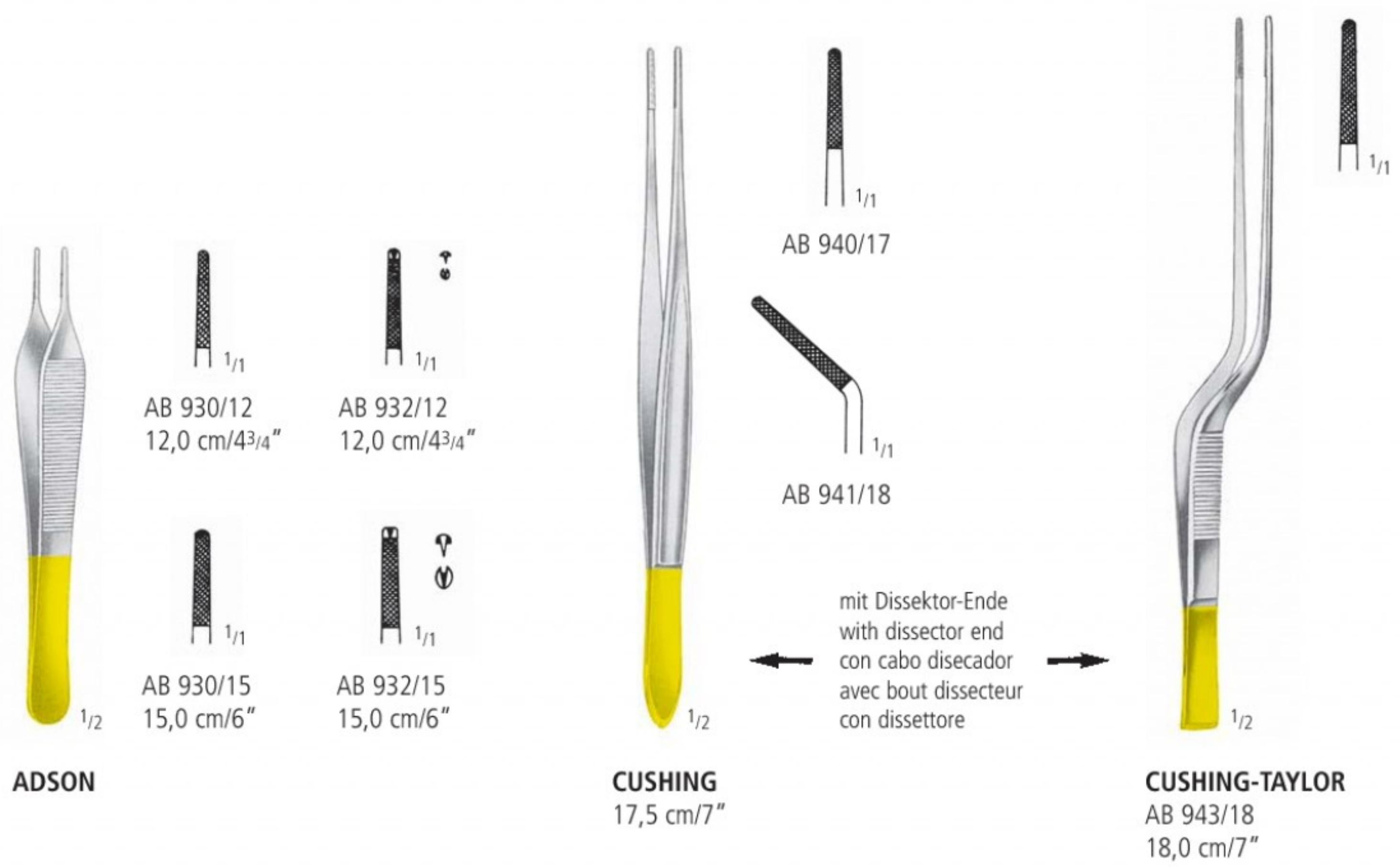

AA
 AB
 AC
 AD
 AE
 AF
 AG
 AH
 AI
 AJ
 AK
 AL
 AM
 AN
 AO
 AP
 AQ
 AR
 AS
 AT
 AU
 AV
 AW
 AX
 AY
 AZ

AB PINZETTEN FORCEPS PINZAS PINCES PINZE

Pinzetten mit Hartmetalleinsätzen
 Dissecting Forceps with Tungsten Carbide Inserts
 Pinzas de disección con bocas de carburo de tungsteno
 Pincés à dissection avec mors en carbure de tungstène
 Pinze per dissezione con punte di carburo di tungsteno



DE BAKEY
 16,0 cm/6¹/₄"
 20,0 cm/8"
 24,0 cm/9¹/₂"

1,5 mm	2,0 mm
AB 944/16	AB 946/16
AB 944/20	AB 946/20
AB 944/24	AB 946/24



BONNEY 1:2
 18,0 cm/7"



WANGENSTEEN



PINZETTEN FORCEPS PINZAS PINCES PINZE

Zahnpinzetten
 Cotton and Dressing Pliers
 Pinzas para algodón y curaciones
 Précelles (Brucelles) pour coton
 Pinze per cotone

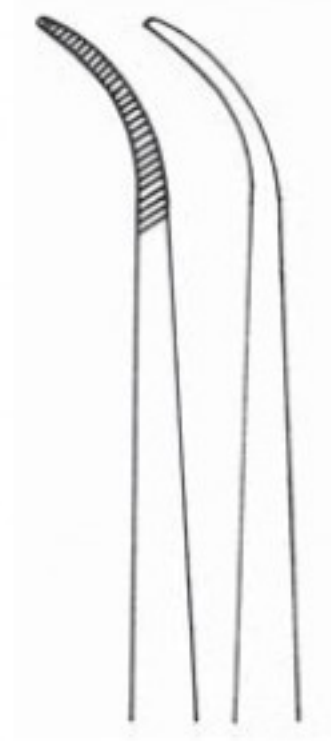
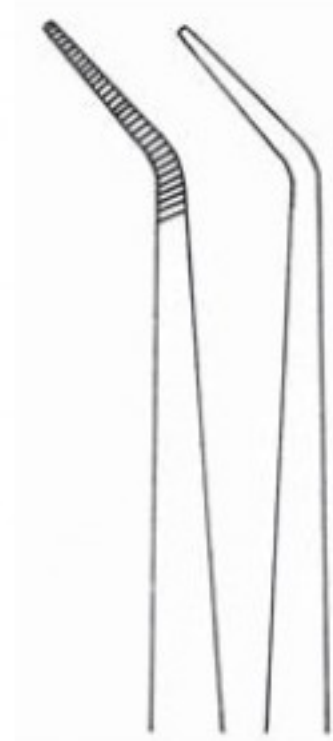
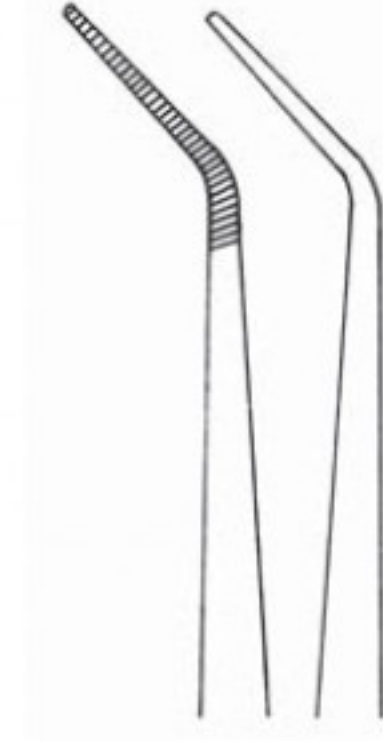

Fig. 1



3



5



2/3

LONDON COLLEGE

15,0 cm/6"

AB 970/01

Fig. 1

Fig. 3

Fig. 5

AB 970/03

AB 970/05



2/3

LONDON COLLEGE

15,0 cm/6"

AB 971/01

AB 971/03

AB 971/05



2/3

LONDON COLLEGE

15,0 cm/6"

AB 973/01

AB 973/03

AB 973/05

AA

AB

AC

AD

AE

AF

AK

AL

AM

AO

AP

AR

KA

KB

KC

KD

KU

KY

AB PINZETTEN FORCEPS PINZAS PINCES PINZE

Zahnpinzetten
 Cotton and Dressing Pliers
 Pinzas para algodón y curaciones
 Précelles (Brucelles) pour coton
 Pinze per cotone

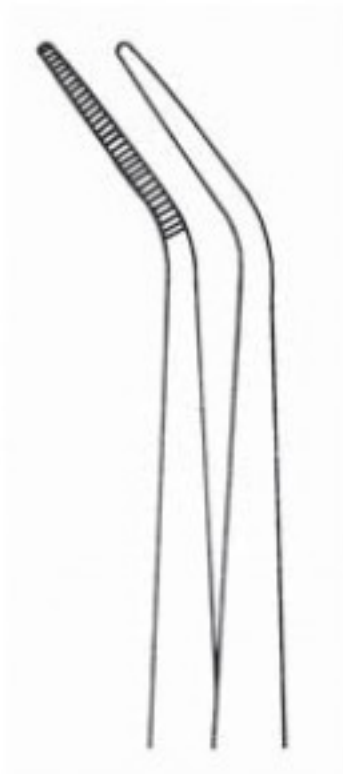
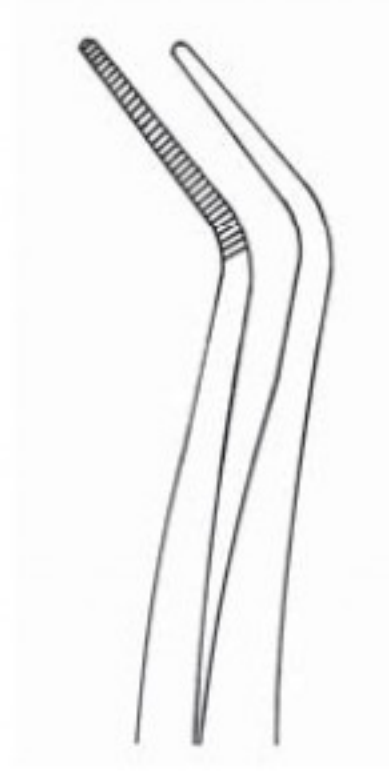
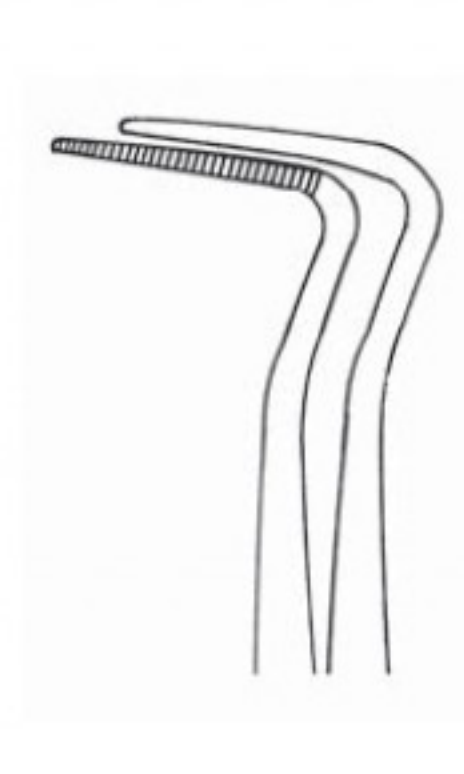

Fig. 1



3



5



MERIAM
 16,0 cm/6¹/₄"
 AB 976/01
 AB 976/03
 AB 976/05



MERIAM
 16,0 cm/6¹/₄"
 AB 977/01
 AB 977/03
 AB 977/05

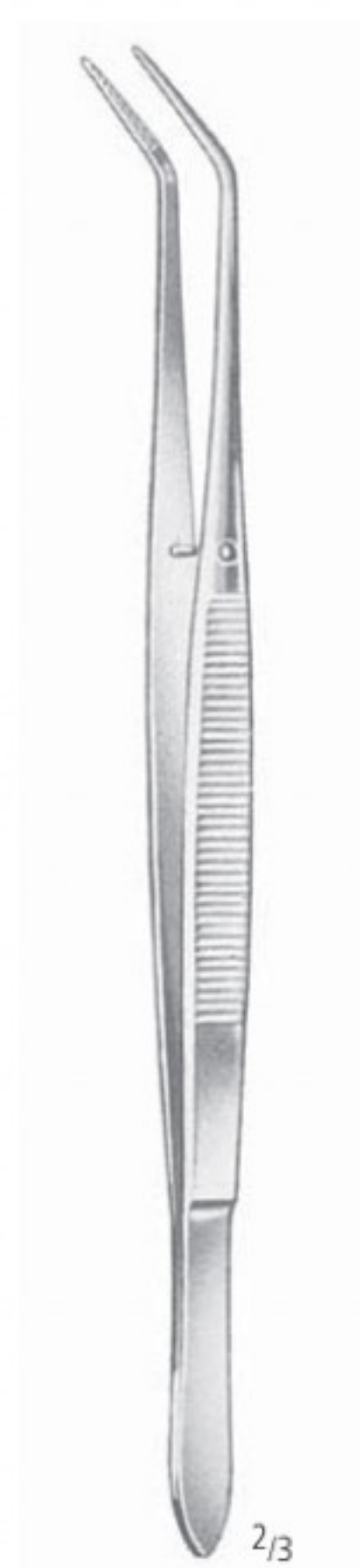

FLAGG
 16,0 cm/6¹/₄"
 AB 978/01
 AB 978/03

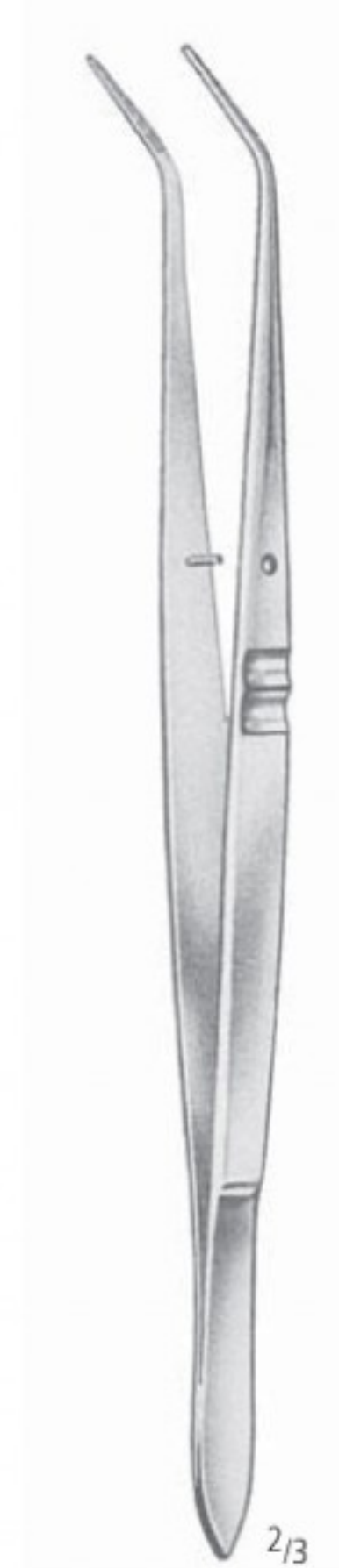

FLAGG
 16,0 cm/6¹/₄"
 AB 979/01
 AB 979/03

Fig. 1
 Fig. 3
 Fig. 5

PINZETTEN FORCEPS PINZAS PINCES PINZE

Zahnpinzetten, Nahtpinzetten
 Cotton and Dressing Pliers, Suture Tweezers
 Pinzas para algodón y curaciones, Pinzas de sutura
 Précelles (Brucelles) pour coton, Pincés de suture
 Pinze per cotone, Pinze per sutura

AA

AB

AC

AD

AE

AF

AK

AL

AM

AO

AP

AR

KA

KB

KC

KD

KU

KY



LANDGRAF
 15,0 cm/6"

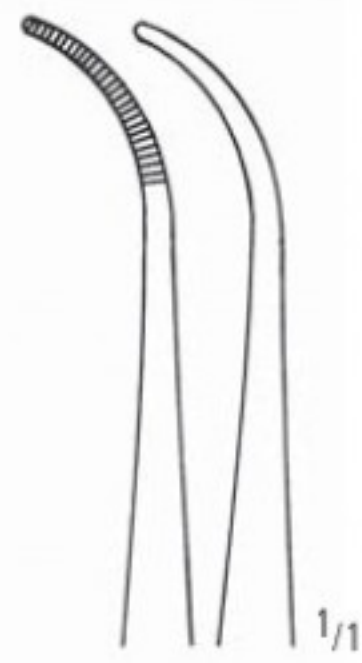

Fig. 1
 AB 981/01

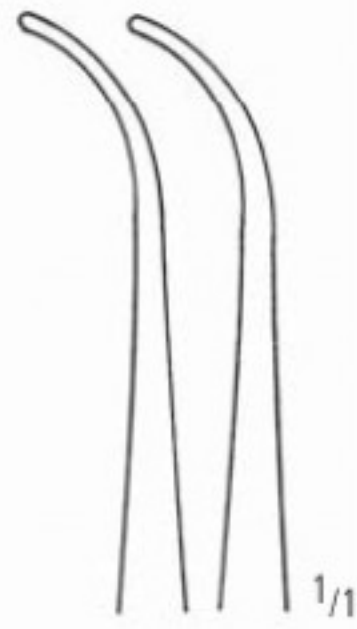

Fig. 2
 AB 981/02

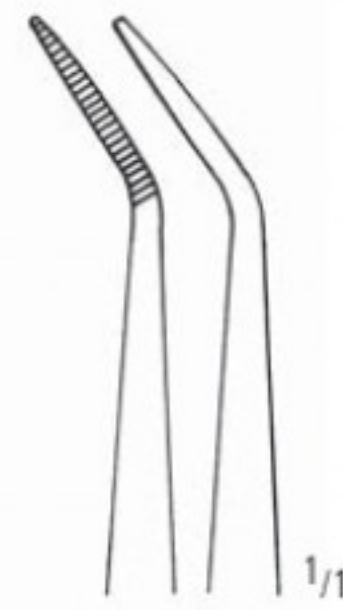

Fig. 3
 AB 981/03

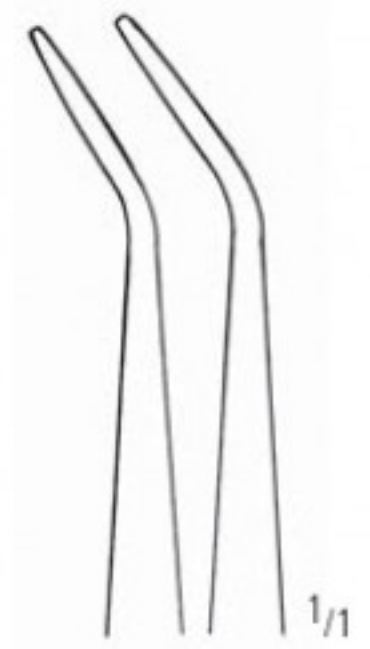

Fig. 4
 AB 981/04



PERRY
 12,5 cm/5"

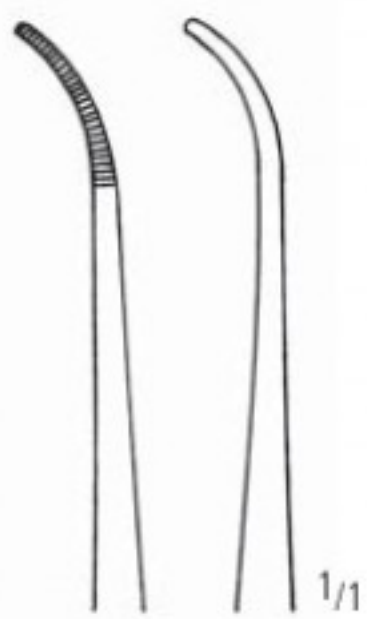

Fig. 1
 AB 983/01

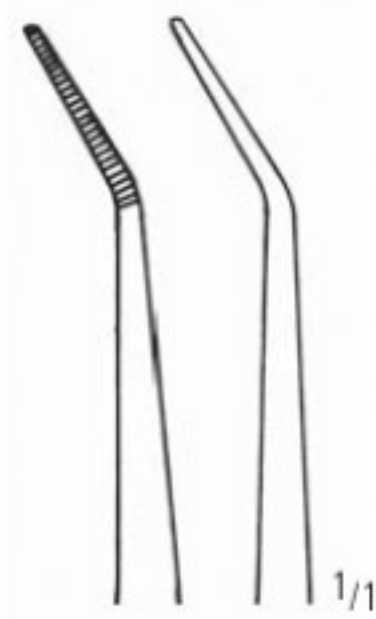
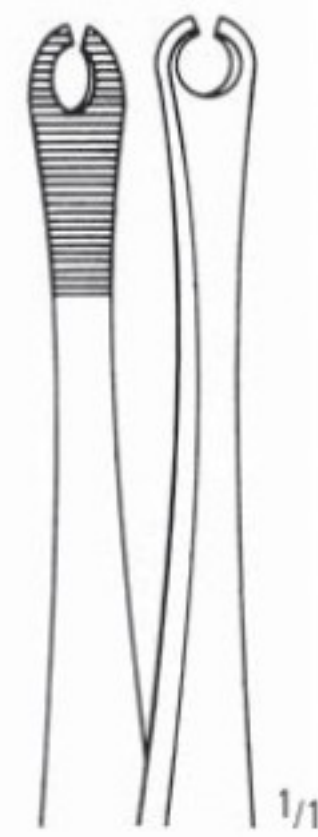

Fig. 2
 AB 983/02



15,0 cm/6"



AB 988/01

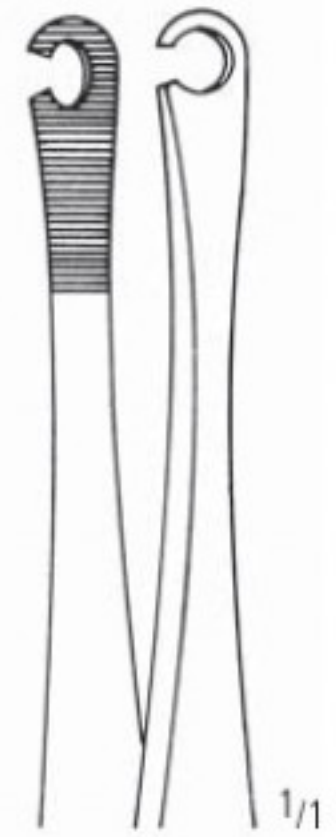

AB 988/02

AB PINZETTEN FORCEPS PINZAS PINCES PINZE

Markierungspinzetten, Artikulationspapier-Pinzetten
 Pocket Markers, Articulating Paper Forceps
 Pinzas para bolsas, Pinzas para papel de articular
 Pincés pour cul-de-sac, Pincés pour papier à articulation
 Pinze per marcazione, Pinze per carta di articolazione

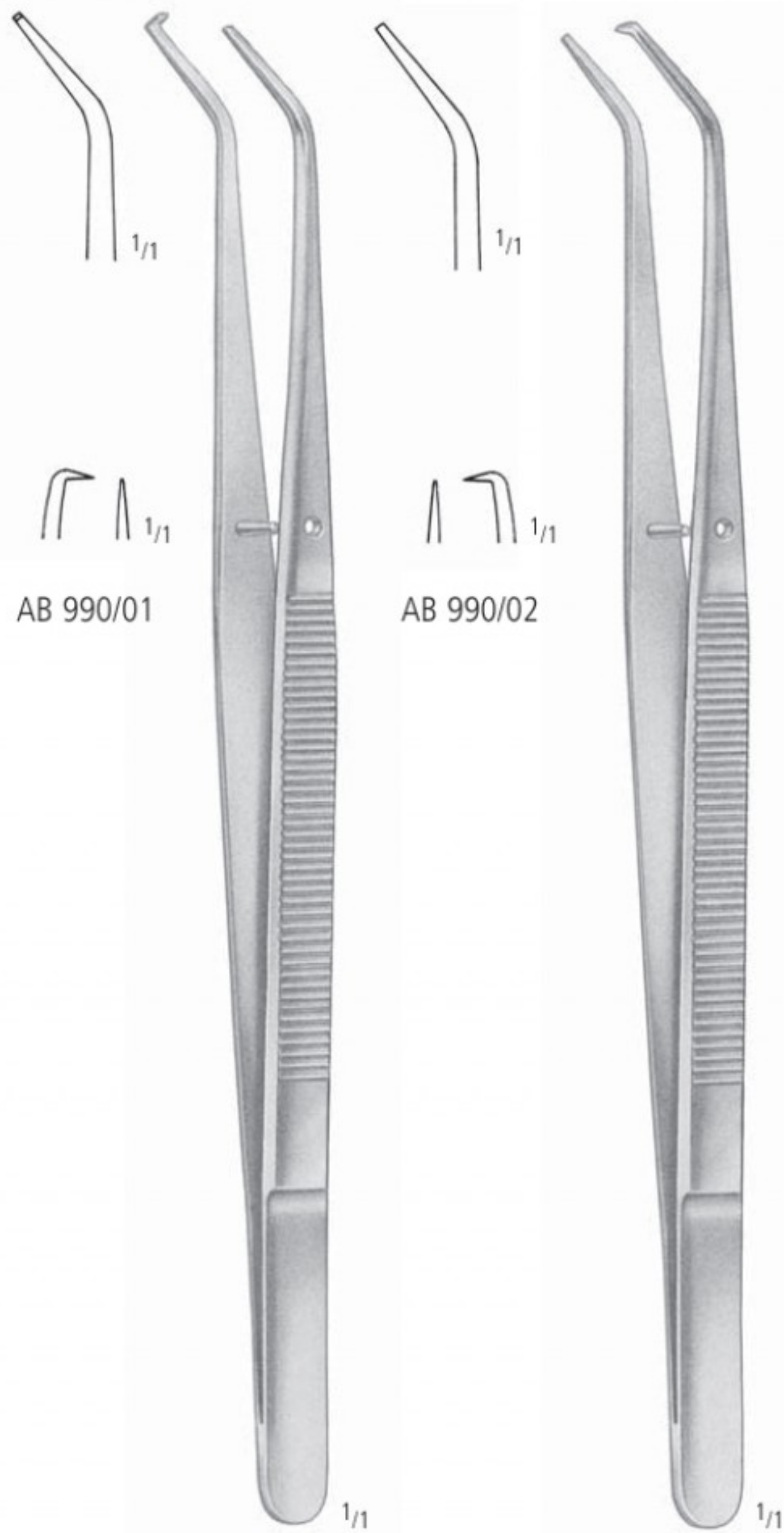

CRANE-KAPLAN

AB 990/01
15,0 cm/6"

AB 990/02
15,0 cm/6"

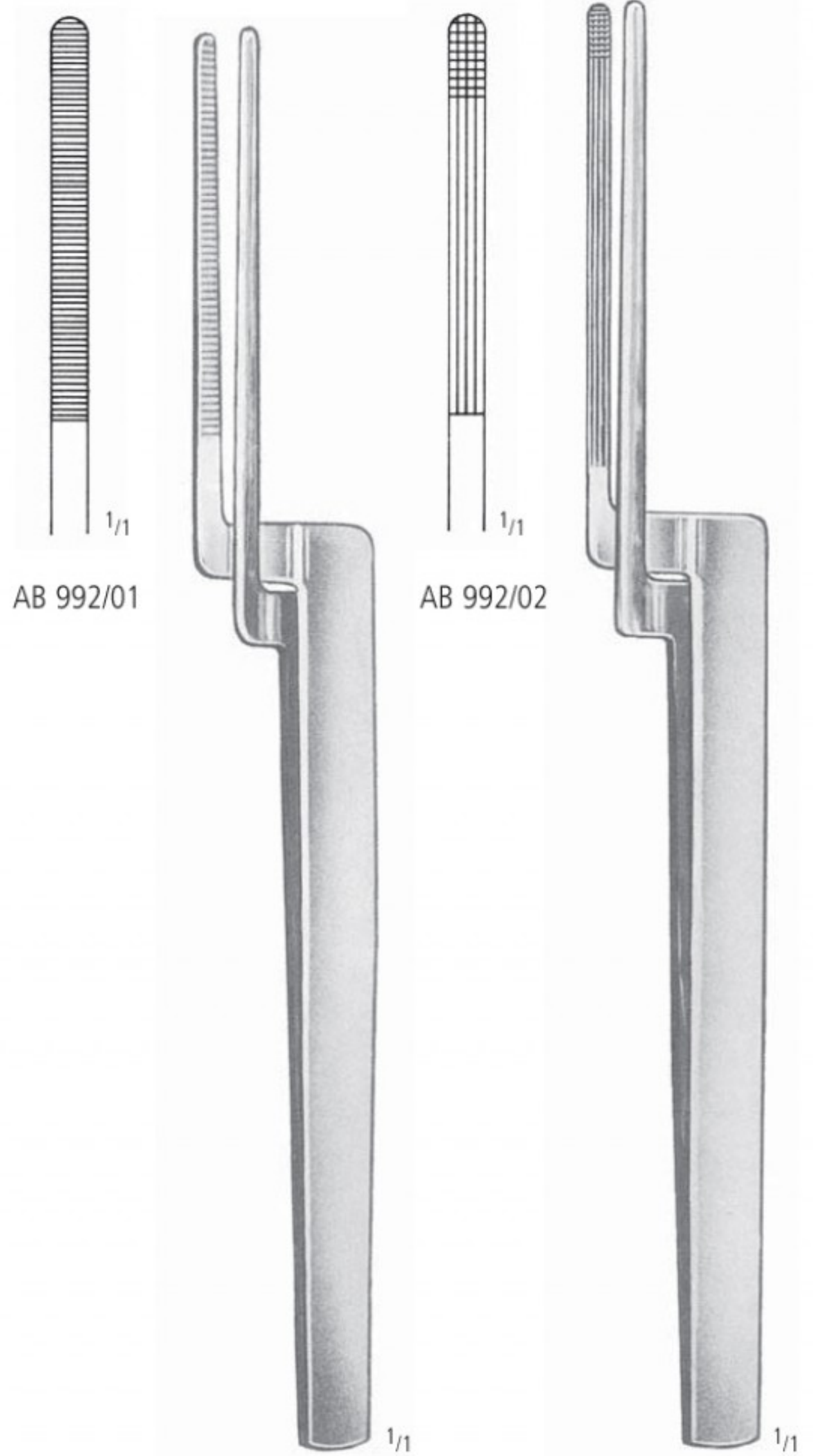

MILLER

15,0 cm/6"