SCHEREN
SCISSORS
TIJERAS
CISEAUX
FORBICI

AC

nopa[®] instruments



nopa® SC
SUPER CUT



SUPER CUT

Besonderheit:

nopa Super Cut Scheren haben eine rasierklingenscharfe Schneide, kombiniert mit einer mikrogezahnten Schneide.

>> Diese Scheren sind durch schwarze Ringe gekennzeichnet.

Features:

nopa Super Cut scissors have a razor-like edge combined with one micro serrated blade.

>> Black rings for easy identification.

Verfügbare Modelle / Available Patterns

Im Katalog durch * markiert. / Marked in catalog with *.

AC 020/13	SC	STANDARD OPER.SCS STR. SH/BL	13,0 CM	SC
AC 020/14	SC	STANDARD OPER.SCS STR. SH/BL	14,0 CM	SC
AC 021/13	SC	STANDARD OPER.SCS CVD. SH/BL	13,0 CM	SC
AC 021/14	SC	STANDARD OPER.SCS CVD. SH/BL	14,0 CM	SC
AC 070/14	SC	MAYO OPER. SCS STR. BL/BL	14,5 CM	SC
AC 070/17	SC	MAYO OPER. SCS STR. BL/BL	17,0 CM	SC
AC 070/23	SC	MAYO OPER. SCS STR. BL/BL	23,0 CM	SC
AC 071/14	SC	MAYO OPER. SCS CVD. BL/BL	14,5 CM	SC
AC 071/17	SC	MAYO OPER. SCS CVD. BL/BL	17,0 CM	SC
AC 071/23	SC	MAYO OPER. SCS CVD. BL/BL	23,0 CM	SC
AC 073/17	SC	MAYO-STILLE OPER. SCS CVD. BL/BL	17,0 CM	SC
AC 100/14	SC	METZENBAUM SCS STR. BL/BL	14,0 CM	SC
AC 101/14	SC	METZENBAUM SCS CVD. BL/BL	14,0 CM	SC
AC 110/18	SC	METZENBAUM-NELSON SCS STR. BL/BL	18,0 CM	SC
AC 110/20	SC	METZENBAUM-NELSON SCS STR. BL/BL	20,0 CM	SC
AC 110/23	SC	METZENBAUM-NELSON SCS STR. BL/BL	23,0 CM	SC
AC 111/18	SC	METZENBAUM-NELSON SCS CVD. BL/BL	18,0 CM	SC
AC 111/20	SC	METZENBAUM-NELSON SCS CVD. BL/BL	20,0 CM	SC
AC 111/23	SC	METZENBAUM-NELSON SCS CVD. BL/BL	23,0 CM	SC
AC 141/14	SC	METZENBAUM-DELICATE SCS BL/BL CVD.	14,5 CM	SC
AC 151/18	SC	METZENBAUM-DELICATE SCS BL/BL CVD.	18,0 CM	SC
AC 214/15	SC	REYNOLDS DISS. SCS STR. SH/SH	15,0 CM	SC
AC 214/18	SC	REYNOLDS DISS. SCS CVD. SH/SH	18,0 CM	SC
AC 450/11	SC	IRIS SCS STR. SH/SH	11,5 CM	SC
AC 451/11	SC	IRIS SCS CVD. SH/SH	11,5 CM	SC
AC 460/11	SC	STRABISMUS SCS STR. BL/BL	11,5 CM	SC
AC 461/11	SC	STRABISMUS SCS CVD. BL/BL	11,5 CM	SC
AC 476/11	SC	STEVENS TENOTOMY SCS STR. BL/BL	11,5 CM	SC
AC 477/11	SC	STEVENS TENOTOMY SCS CVD. BL/BL	11,5 CM	SC

AC SCHEREN SCISSORS TIJERAS CISEAUX FORBICI

Chirurgische Scheren
Operating Scissors
Tijeras para cirugía
Ciseaux à chirurgie
Forbici per chirurgia



Original 13,0 cm



STANDARD

Fig.1
gerade
straight
rectas
droits
rette

AC 010/10	10,5 cm/4 ¹ / ₄ "
AC 010/11	11,5 cm/4 ¹ / ₂ "
AC 010/13	13,0 cm/5"
AC 010/14	14,5 cm/5 ³ / ₄ "
AC 010/15	15,5 cm/6"
AC 010/16	16,5 cm/6 ¹ / ₂ "
AC 010/17	17,5 cm/7"
AC 010/18	18,5 cm/7 ¹ / ₃ "
AC 010/20	20,0 cm/8"

STANDARD

Fig.1
gebogen
curved
curvas
courbes
curve

Original 13,0 cm



Original 14,5 cm



STANDARD

Fig.2
gerade
straight
rectas
droits
rette

AC 020/10	10,5 cm/4 ¹ / ₄ "
AC 020/11	11,5 cm/4 ¹ / ₂ "
AC 020/13*	13,0 cm/5"
AC 020/14*	14,5 cm/5 ³ / ₄ "
AC 020/15	15,5 cm/6"
AC 020/16	16,5 cm/6 ¹ / ₂ "
AC 020/17	17,5 cm/7"
AC 020/18	18,5 cm/7 ¹ / ₃ "
AC 020/20	20,0 cm/8"

STANDARD

Fig.2
gebogen
curved
curvas
courbes
curve

Original 14,5 cm



Original 16,5 cm



STANDARD

Fig.3
gerade
straight
rectas
droits
rette

AC 030/10	10,5 cm/4 ¹ / ₄ "
AC 030/11	11,5 cm/4 ¹ / ₂ "
AC 030/13	13,0 cm/5"
AC 030/14	14,5 cm/5 ³ / ₄ "
AC 030/15	15,5 cm/6"
AC 030/16	16,5 cm/6 ¹ / ₂ "
AC 030/17	17,5 cm/7"
AC 030/18	18,5 cm/7 ¹ / ₃ "
AC 030/20	20,0 cm/8"

STANDARD

Fig.3
gebogen
curved
curvas
courbes
curve

Original 16,5 cm



SCHEREN SCISSORS TIJERAS CISEAUX FORBICI

Chirurgische Scheren
Operating Scissors
Tijeras para cirugía
Ciseaux à chirurgie
Forbici per chirurgia



Original 13,0 cm

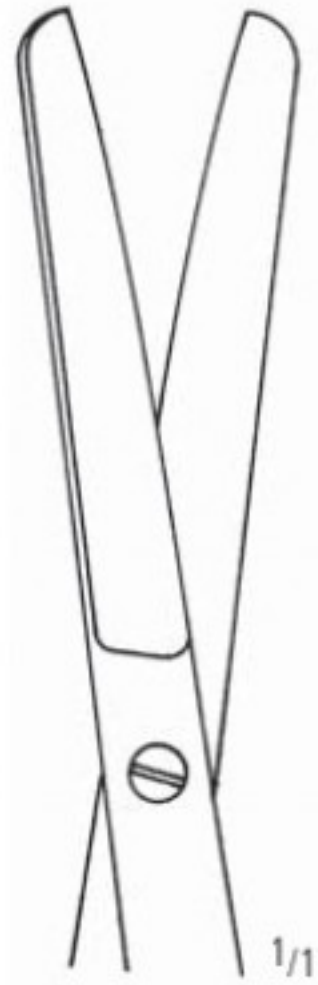

GRAZIL

Fig.1
gerade
straight
rectas
droits
rette

AC 040/13
AC 040/14

13,0 cm/5"
14,5 cm/5³/₄"

GRAZIL

Fig. 1
gebogen
curved
curvas
courbes
curve

AC 041/13
AC 041/14

Original 13,0 cm



Original 14,5 cm



GRAZIL

Fig.2
gerade
straight
rectas
droits
rette

AC 042/13
AC 042/14

13,0 cm/5"
14,5 cm/5³/₄"

GRAZIL

Fig. 2
gebogen
curved
curvas
courbes
curve

AC 043/13
AC 043/14

Original 14,5 cm



Original 14,5 cm



GRAZIL

Fig.3
gerade
straight
rectas
droits
rette

AC 046/13
AC 046/14

13,0 cm/5"
14,5 cm/5³/₄"

GRAZIL

Fig. 3
gebogen
curved
curvas
courbes
curve

AC 047/13
AC 047/14

Original 14,5 cm



AA
AB
AC
AD
AE
AF
AK
AL
AM
AO
AP
AR
KA
KB
KC
KD
KU
KY

AC SCHEREN SCISSORS TIJERAS CISEAUX FORBICI

Chirurgische Scheren
 Operating Scissors
 Tijeras para cirugía
 Ciseaux à chirurgie
 Forbici per chirurgia



Inzisionsscheren
 Incision Scissors
 Tijeras para incision
 Ciseaux à incision
 Forbici per incisioni

AC 052/13 = 13,0 cm/5"
 AC 052/14 = 14,5 cm/5³/₄"



AC 054/15
 15,5 cm/6"



RICHTER
 AC 056/14
 14,5 cm/5³/₄"

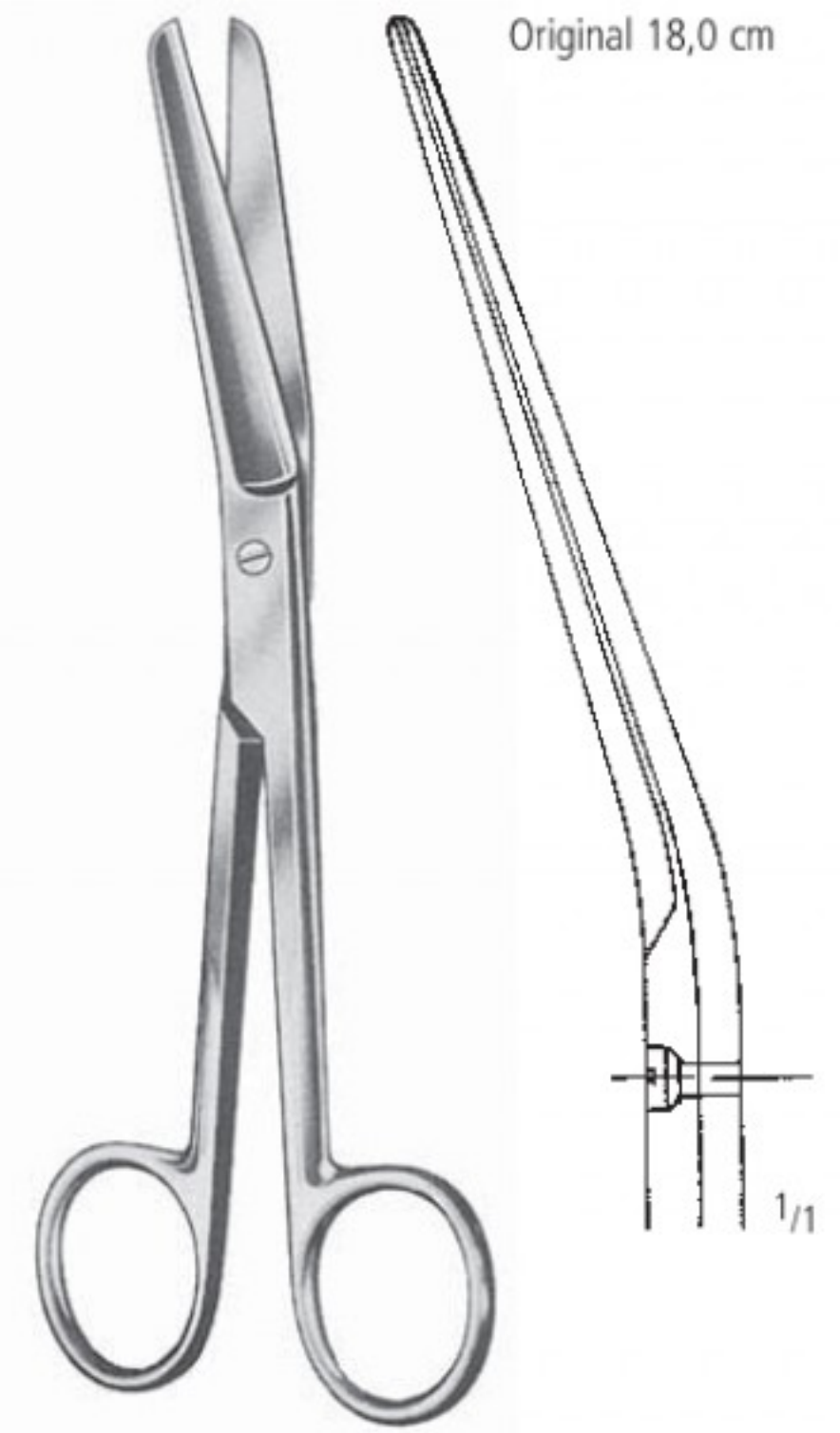

FERGUSSON
 AC 058/16 = 16,5 cm/6¹/₂"
 AC 058/18 = 18,0 cm/7"



DEAVER
 AC 060/14
 14,0 cm/5¹/₂"

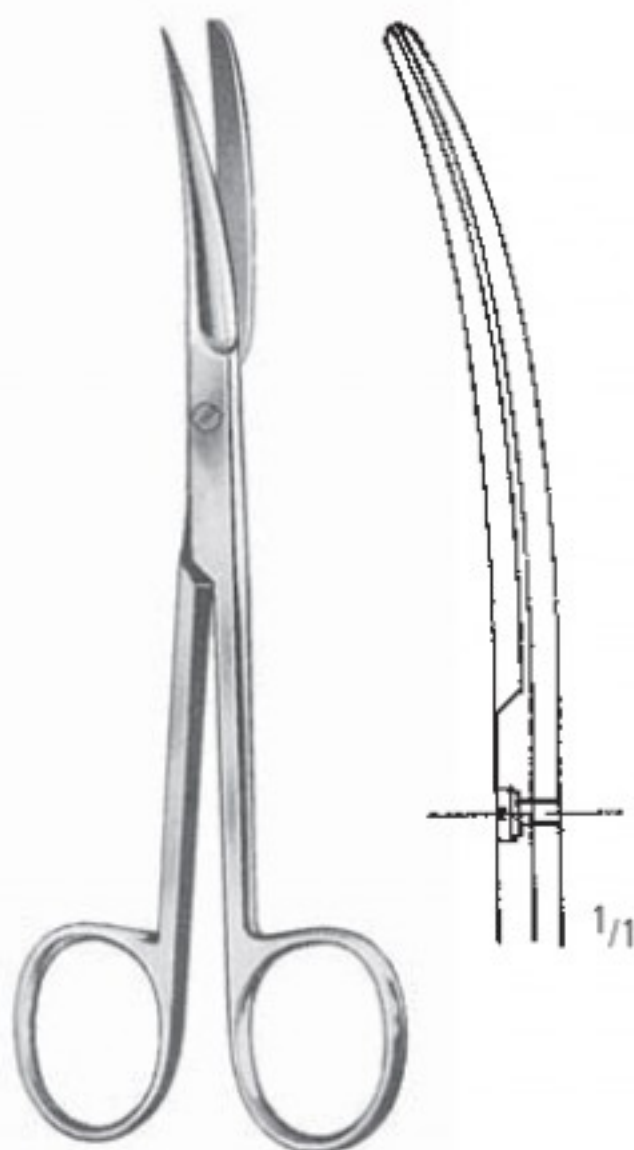

AC 061/14



MIXTER
 AC 062/15
 15,5 cm/6"

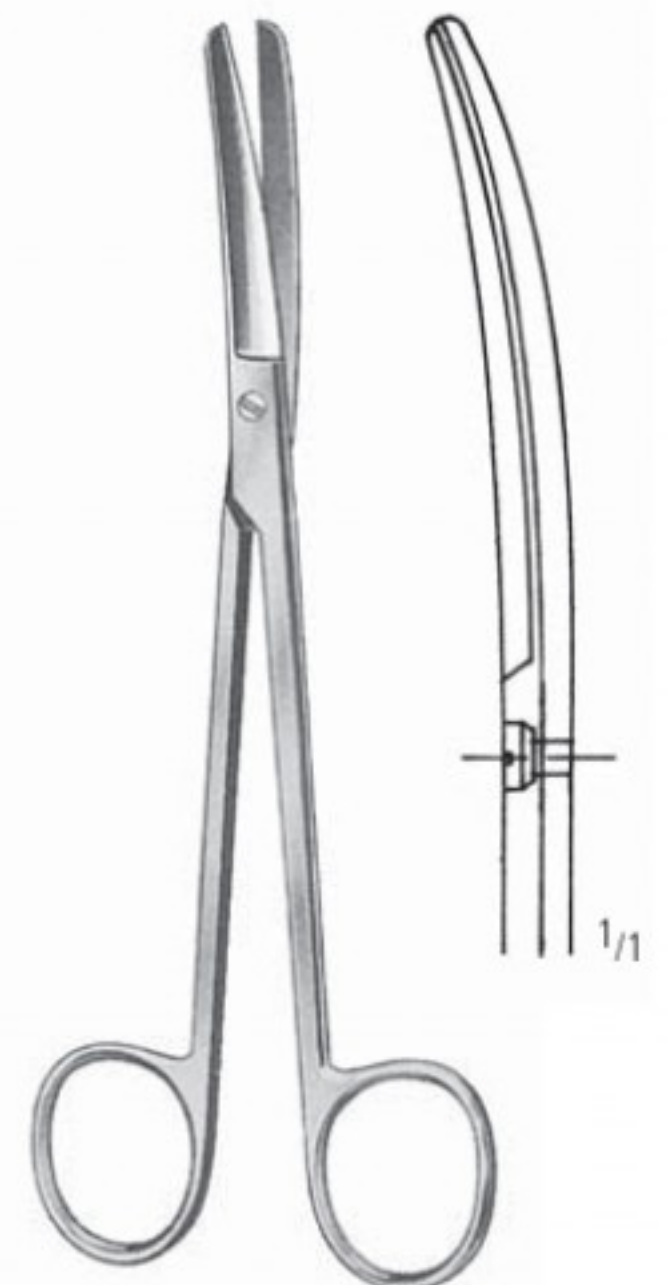

AC 063/15

SCHEREN SCISSORS TIJERAS CISEAUX FORBICI

Chirurgische und Gynäkologische Scheren
 Operating and Gynecological Scissors
 Tijeras para cirugía y ginecología
 Ciseaux à chirurgie et à gynécologie
 Forbici per chirurgia e ginecologia

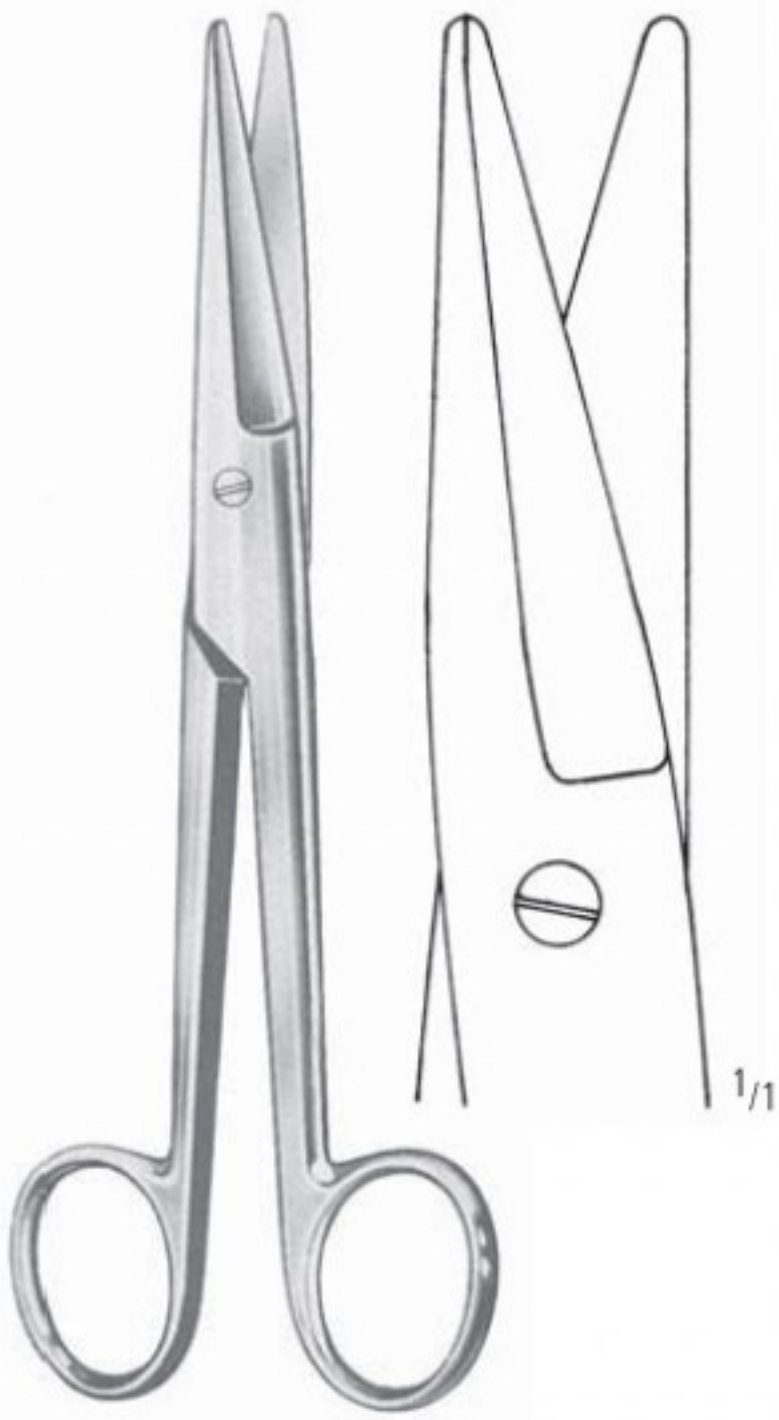

AC 064/17

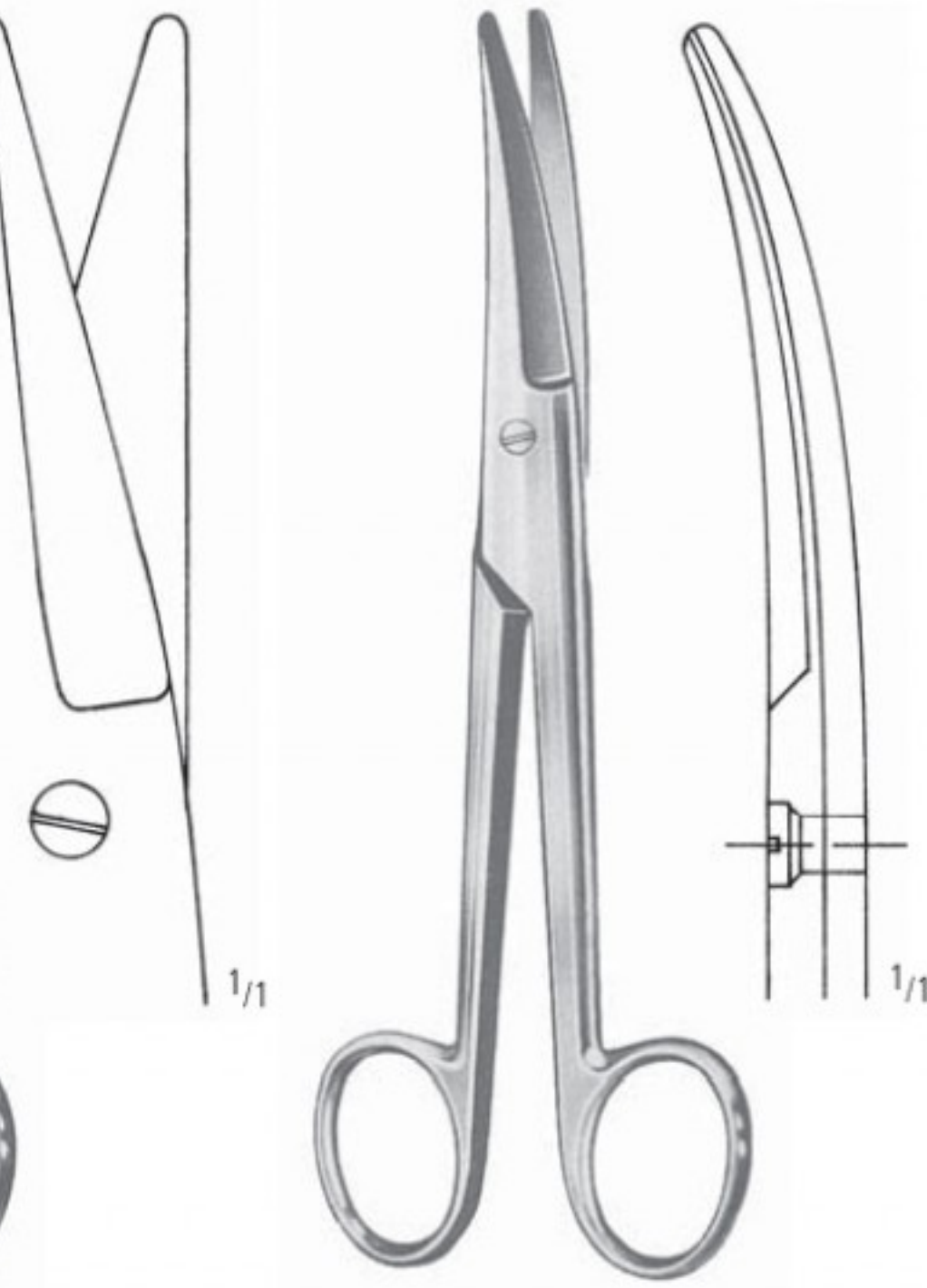

AC 065/17

MAYO-NOBLE
 17,0 cm/6³/₄"

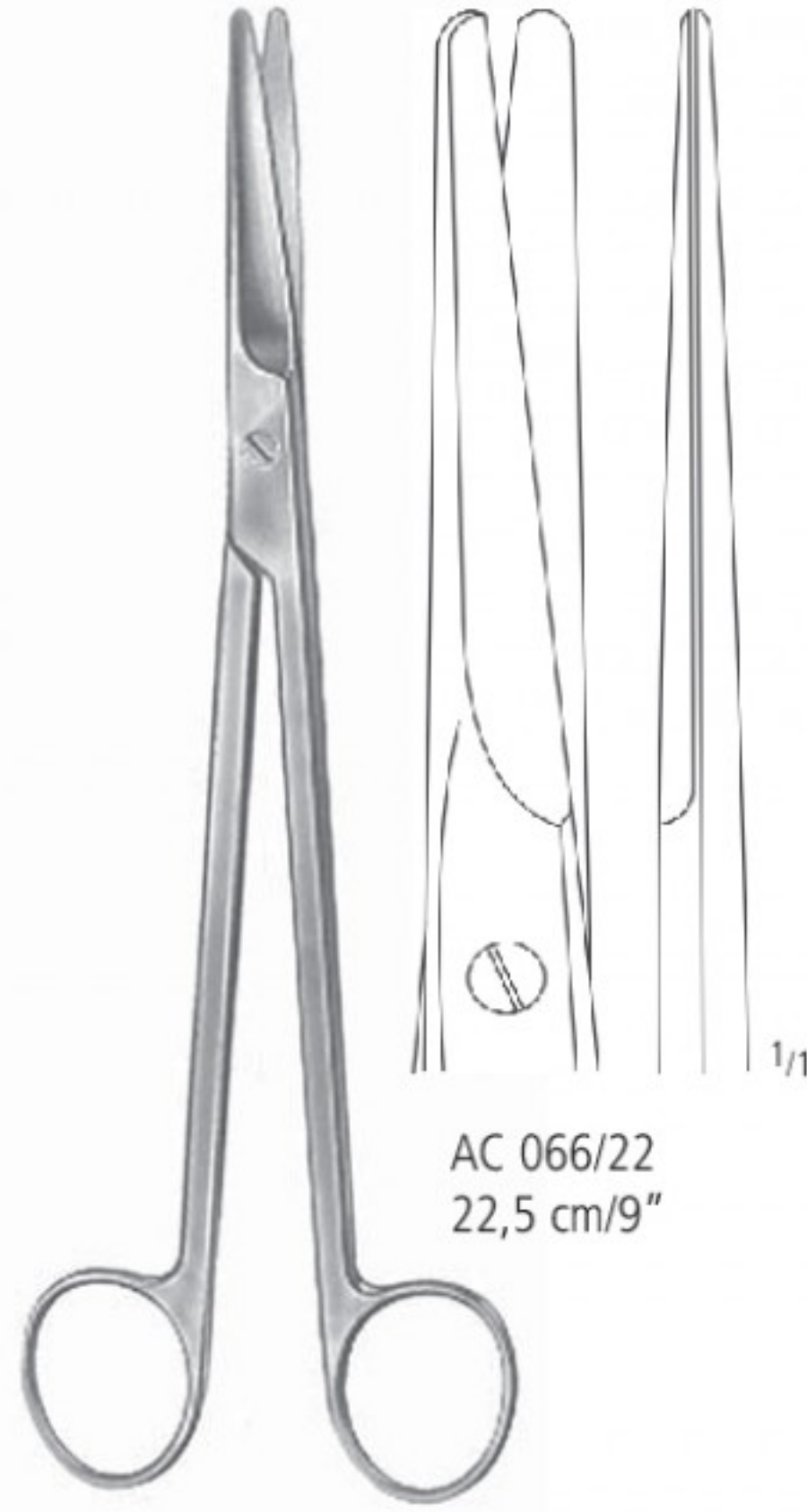

AC 066/22
 22,5 cm/9"

MAYO-HARRINGTON



AC 067/22
 22,5 cm/9"

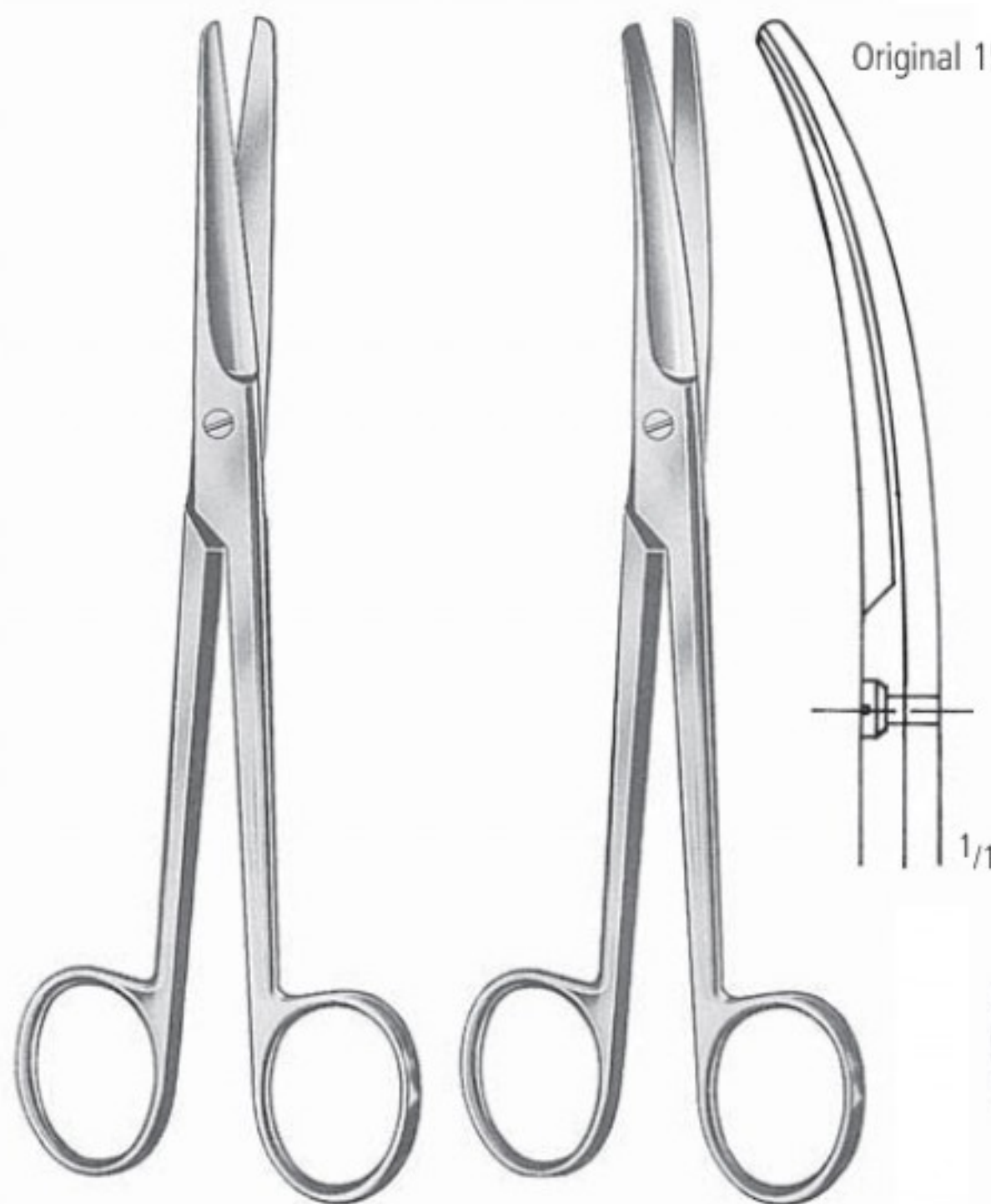

MAYO

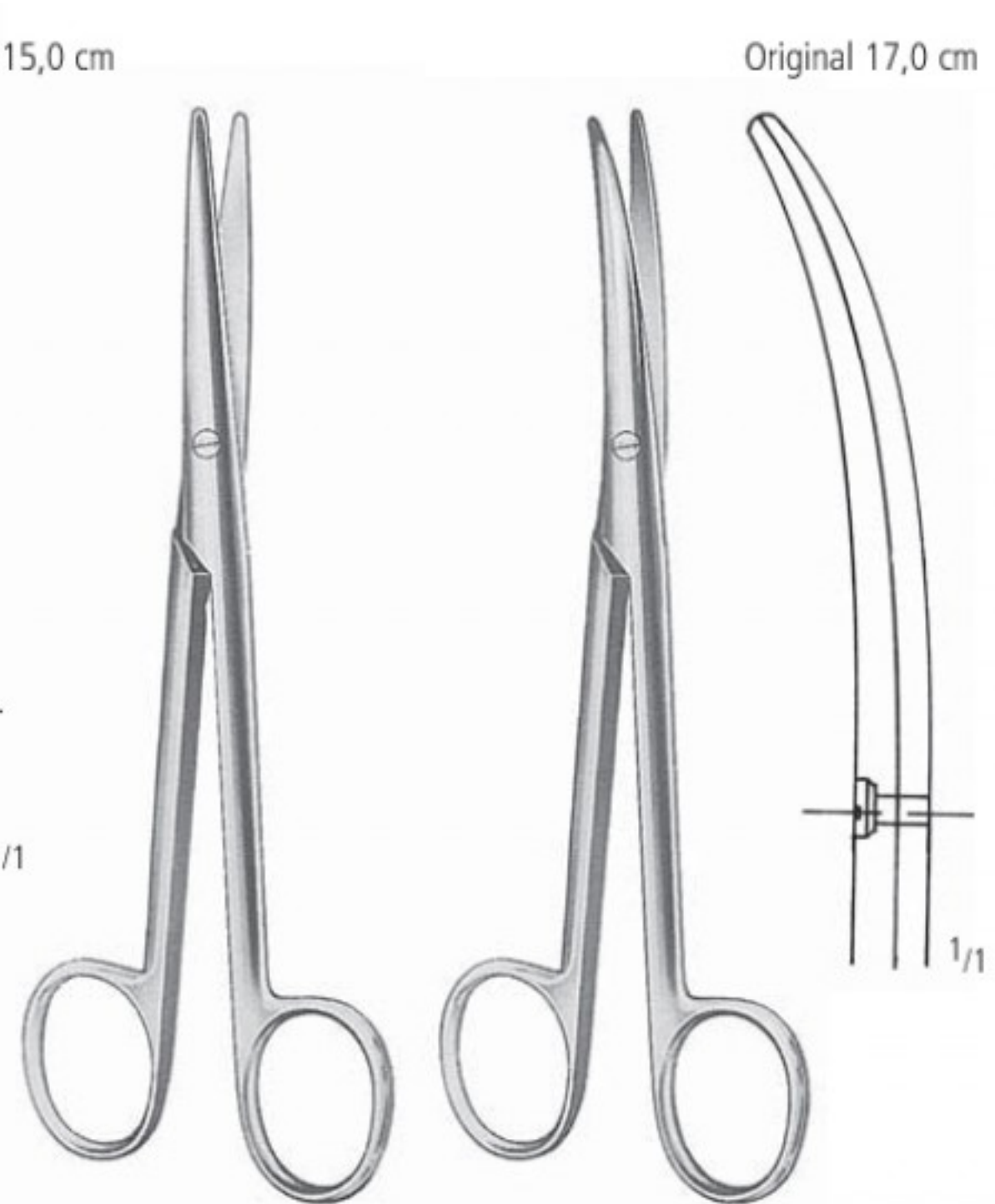

MAYO-STILLE

14,5 cm/5 ³ / ₄ "	AC 070/14*	AC 071/14*		
15,0 cm/6"			AC 072/15	AC 073/15
17,0 cm/6 ³ / ₄ "	AC 070/17*	AC 071/17*	AC 072/17	AC 073/17*
19,5 cm/7 ³ / ₄ "			AC 072/19	AC 073/19
21,0 cm/8 ¹ / ₄ "			AC 072/21	AC 073/21
23,0 cm/9"	AC 070/23*	AC 071/23*		
28,0 cm/11"	AC 070/28	AC 071/28		

* Auch erhältlich als SC

* Also available as SC

AA
 AB
AC
 AD
 AE
 AF
 AG
 AH
 AI
 AJ
 AK
 AL
 AM
 AN
 AO
 AP
 AQ
 AR
 AS
 AT
 AU
 AV
 AW
 AX
 AY
 AZ

AC SCHEREN SCISSORS TIJERAS CISEAUX FORBICI

Gynäkologische und Bauchdecken-Scheren
 Gynecological and Abdominal Scissors
 Tijeras para ginecología y Tijeras abdominales
 Ciseaux à gynécologie et Ciseaux abdominaux
 Forbici per ginecologia e Forbici addominali



DOYEN
 AC 080/16
 16,0 cm/6¹/₄"

DOYEN
 AC 082/16
 16,0 cm/6¹/₄"

DOYEN
 AC 083/16
 16,0 cm/6¹/₄"

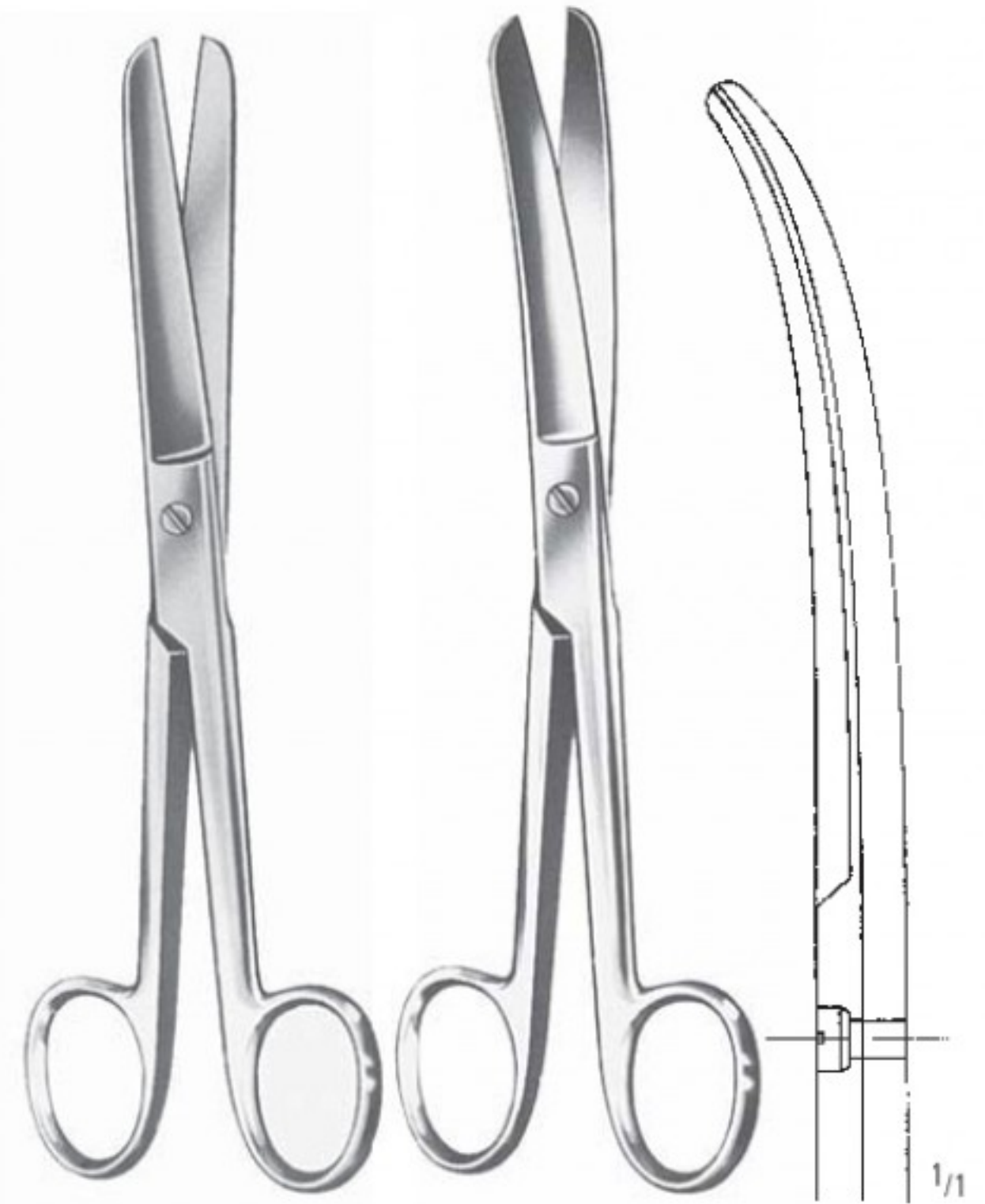

DOYEN
 AC 084/18
 17,5 cm/7"

DOYEN
 AC 085/18
 17,5 cm/7"

Fistelscheren
 Fistula Scissors
 Tijeras para fistulas
 Ciseaux pour fistules
 Forbici per fistole

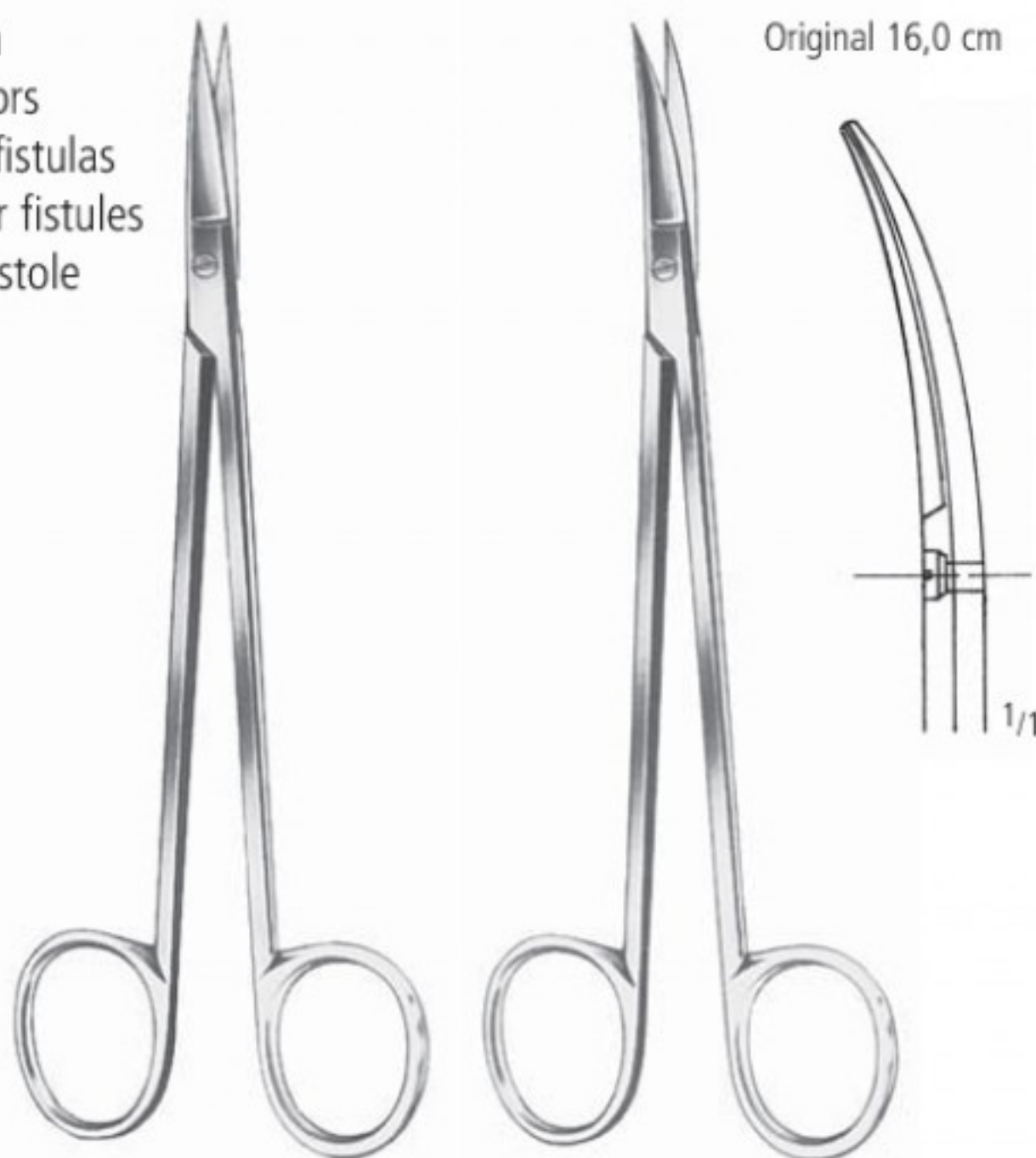

AC 086/16
 AC 086/18

KELLY
 16,0 cm/6¹/₄"
 18,0 cm/7"

AC 087/16
 AC 087/18

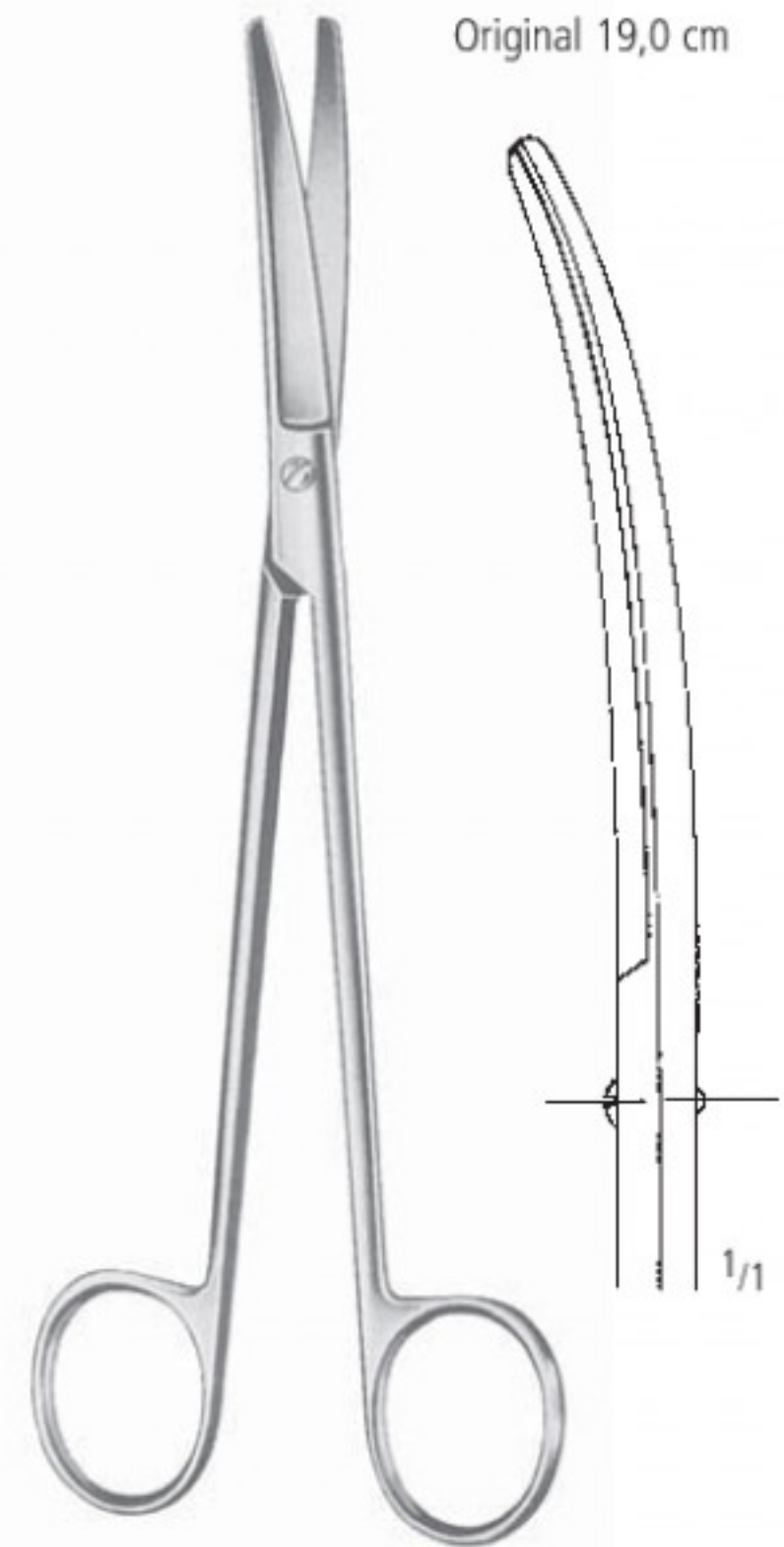

WERTHEIM
 14,5 cm/5³/₄"
 19,5 cm/7³/₄"
 22,5 cm/9"

AC 089/14
 AC 089/19
 AC 089/22

SCHEREN SCISSORS TIJERAS CISEAUX FORBICI

Gynäkologische Scheren
Gynecological Scissors
Tijeras para ginecología
Ciseaux à gynécologie
Forbici per ginecologia



20,0 cm/8" AC 090/20
23,0 cm/9" AC 090/23



AC 092/20
AC 092/23



AC 094/20
AC 094/23

SIMS
gerade
straight
rectas
droits
rette



AC 091/20
AC 091/23

Original 20,0 cm



AC 093/20
AC 093/23



AC 095/20
AC 095/23

SIMS
gebogen
curved
curvas
courbes
curve



DUBOIS
AC 096/27
27,0 cm/10³/₄"



DUBOIS
AC 097/27
27,0 cm/10³/₄"



SIEBOLD
AC 098/24
24,0 cm/9¹/₂"

S-gebogen
S-curved
curva forma S
courbes en S
curve in S



CARDINALE
AC 099/28
28,0 cm/11"

AA
AB
AC
AD
AE
AF
AK
AL
AM
AO
AP
AR
KA
KB
KC
KD
KU
KY

Präparierscheren
Dissecting Scissors
Tijeras para preparaciones
Ciseaux à dissection
Forbici per preparazioni

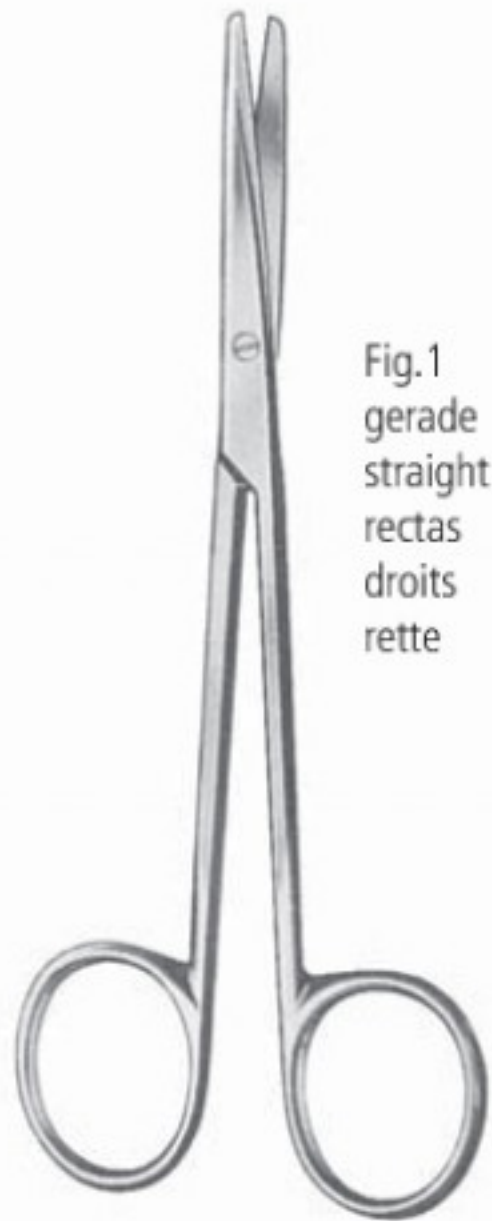

Fig.1
gerade
straight
rectas
droits
rette

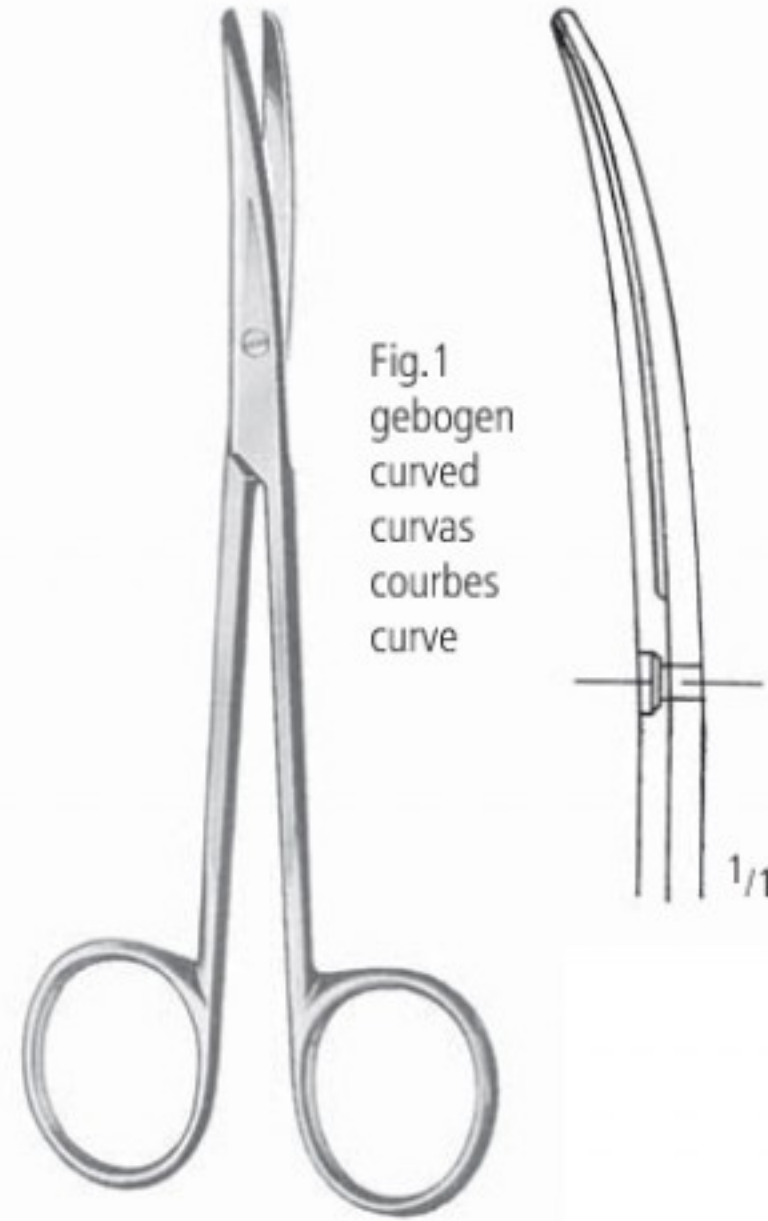

Fig.1
gebogen
curved
curvas
courbes
curve

METZENBAUM

AC 100/14*
14,5 cm/5³/₄"

AC 101/14*
14,5 cm/5³/₄"

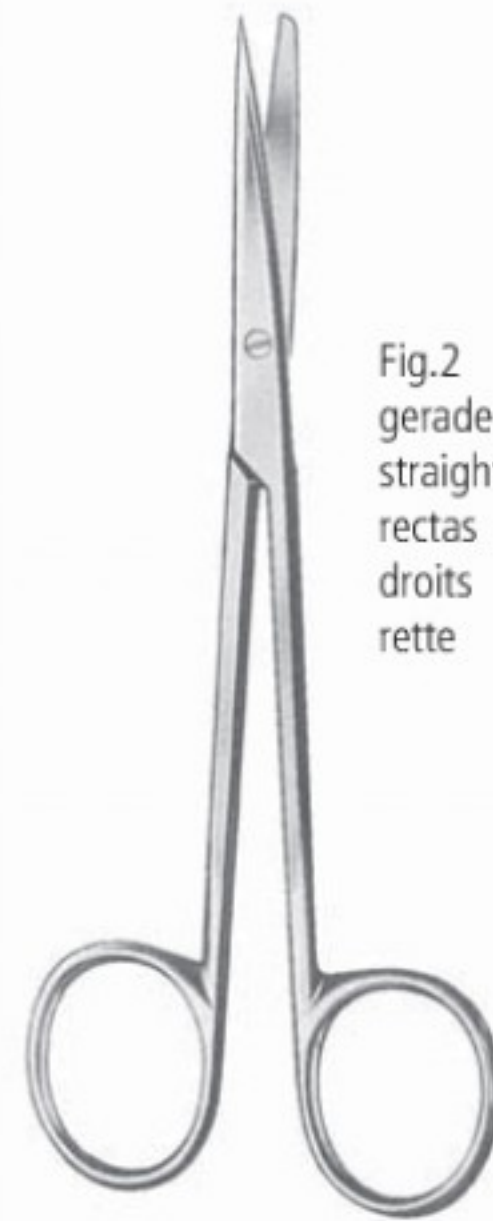

Fig.2
gerade
straight
rectas
droits
rette

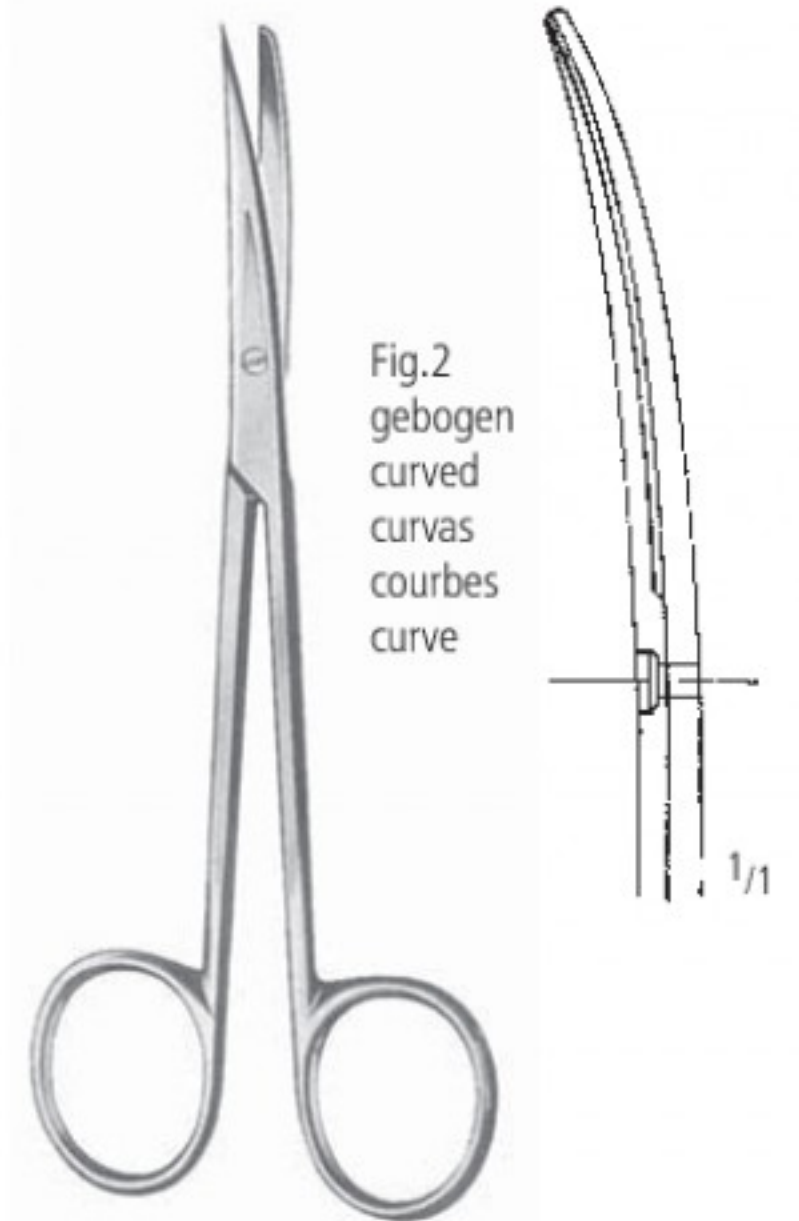

Fig.2
gebogen
curved
curvas
courbes
curve

METZENBAUM

AC 102/14
14,5 cm/5³/₄"

AC 103/14
14,5 cm/5³/₄"

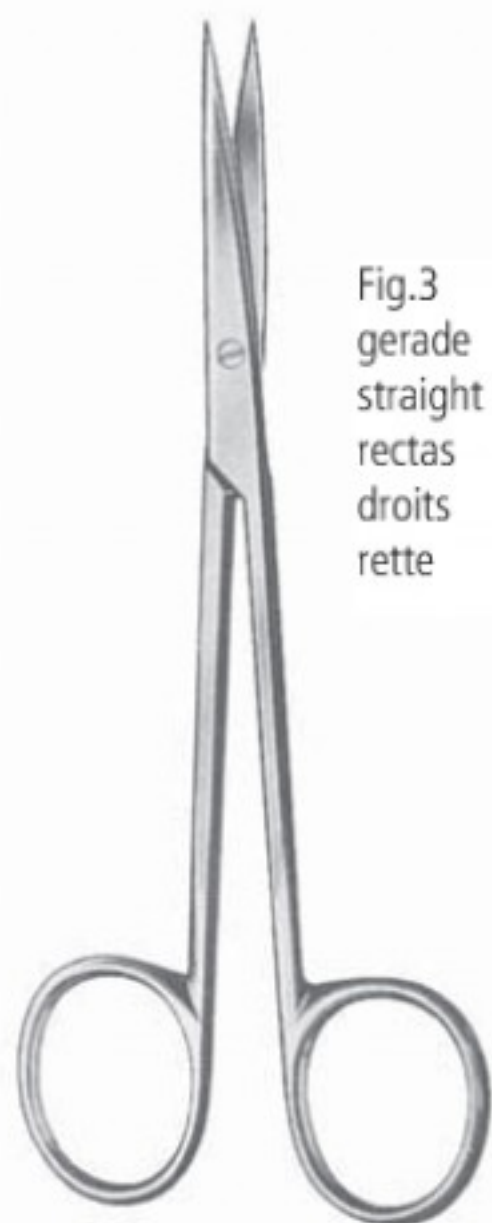

Fig.3
gerade
straight
rectas
droits
rette

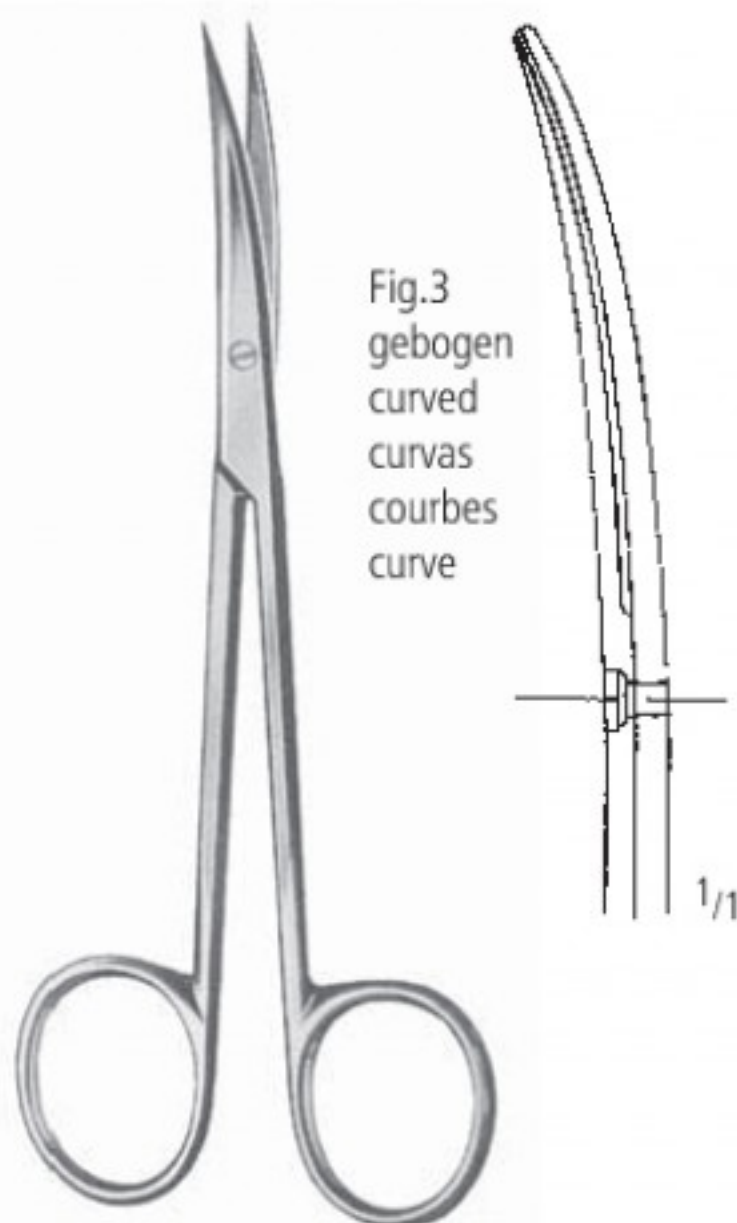
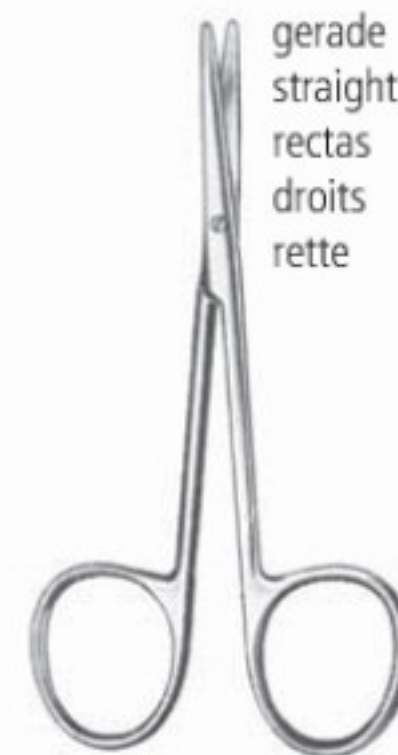

Fig.3
gebogen
curved
curvas
courbes
curve

METZENBAUM

AC 104/14
14,5 cm/5³/₄"

AC 105/14
14,5 cm/5³/₄"



gerade
straight
rectas
droits
rette

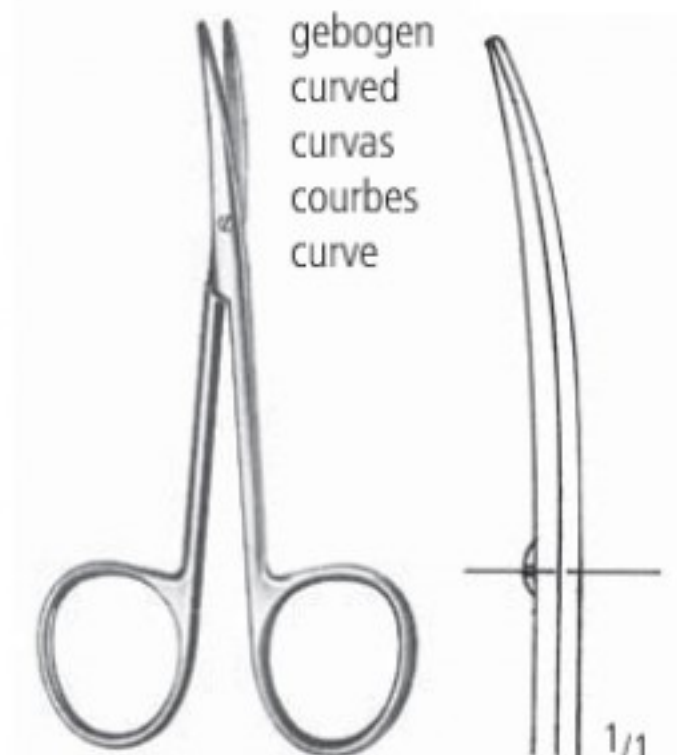

gebogen
curved
curvas
courbes
curve

METZENBAUM-BABY

AC 108/11

AC 109/11

11,5 cm/4¹/₂"

SCHEREN SCISSORS TIJERAS CISEAUX FORBICI

Präparierscheren
Dissecting Scissors
Tijeras para preparaciones
Ciseaux à dissection
Forbici per preparazioni

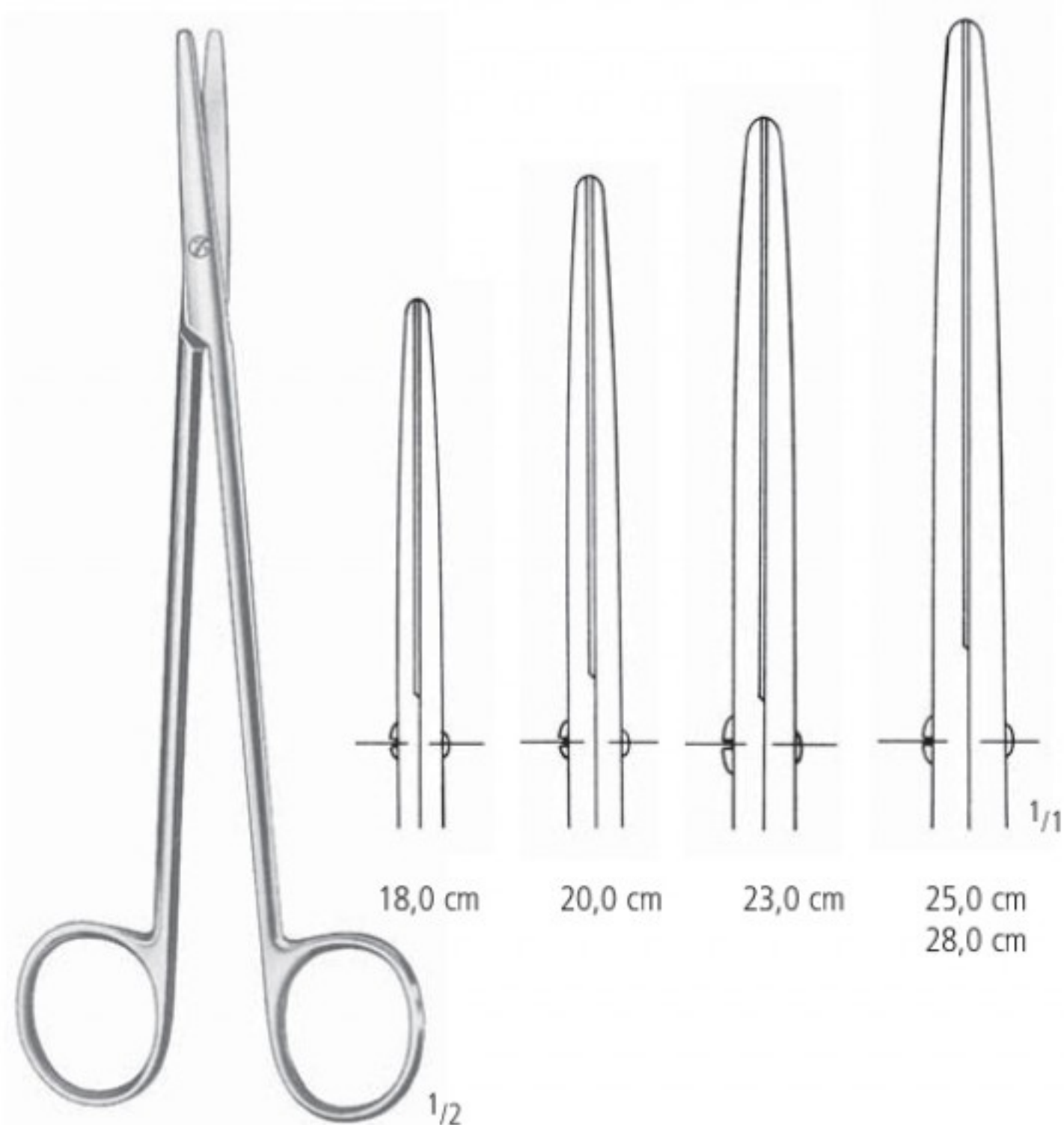

METZENBAUM-NELSON



METZENBAUM-NELSON



Fig. 1



Fig. 2



Fig. 3



18,0 cm/7"	AC 110/18*	AC 111/18*	AC 120/18	AC 121/18	AC 130/18	AC 131/18
20,0 cm/8"	AC 110/20*	AC 111/20*	AC 120/20	AC 121/20	AC 130/20	AC 131/20
23,0 cm/9"	AC 110/23*	AC 111/23*	AC 120/23	AC 121/23	AC 130/23	AC 131/23
25,0 cm/10"	AC 110/25	AC 111/25	AC 120/25	AC 121/25	AC 130/25	AC 131/25
28,0 cm/11"	AC 110/28	AC 111/28	AC 120/28	AC 121/28	AC 130/28	AC 131/28
30,0 cm/12"	AC 110/30	AC 111/30	AC 120/30	AC 121/30	AC 130/30	AC 131/30

* Auch erhältlich als SC * Also available as SC

AA
AB
AC
AD
AE
AF
AG
AH
AI
AJ
AK
AL
AM
AN
AO
AP
AQ
AR
AS
AT
AU
AV
AW
AX
AY
AZ
BA
BB
BC
BD
BE
BF
BG
BH
BI
BJ
BK
BL
BM
BN
BO
BP
BQ
BR
BS
BT
BU
BV
BW
BX
BY
BZ
CA
CB
CC
CD
CE
CF
CG
CH
CI
CJ
CK
CL
CM
CN
CO
CP
CQ
CR
CS
CT
CU
CV
CW
CX
CY
CZ
DA
DB
DC
DD
DE
DF
DG
DH
DI
DJ
DK
DL
DM
DN
DO
DP
DQ
DR
DS
DT
DU
DV
DW
DX
DY
DZ
EA
EB
EC
ED
EE
EF
EG
EH
EI
EJ
EK
EL
EM
EN
EO
EP
EQ
ER
ES
ET
EU
EV
EW
EX
EY
EZ
FA
FB
FC
FD
FE
FF
FG
FH
FI
FJ
FK
FL
FM
FN
FO
FP
FQ
FR
FS
FT
FU
FV
FW
FX
FY
FZ
GA
GB
GC
GD
GE
GF
GG
GH
GI
GJ
GK
GL
GM
GN
GO
GP
GQ
GR
GS
GT
GU
GV
GW
GX
GY
GZ
HA
HB
HC
HD
HE
HF
HG
HH
HI
HJ
HK
HL
HM
HN
HO
HP
HQ
HR
HS
HT
HU
HV
HW
HX
HY
HZ
IA
IB
IC
ID
IE
IF
IG
IH
II
IJ
IK
IL
IM
IN
IO
IP
IQ
IR
IS
IT
IU
IV
IW
IX
IY
IZ
JA
JB
JC
JD
JE
JF
JG
JH
JI
JJ
JK
JL
JM
JN
JO
JP
JQ
JR
JS
JT
JU
JV
JW
JX
JY
JZ
KA
KB
KC
KD
KE
KF
KG
KH
KI
KJ
KK
KL
KM
KN
KO
KP
KQ
KR
KS
KT
KU
KV
KW
KX
KY
KZ
LA
LB
LC
LD
LE
LF
LG
LH
LI
LJ
LK
LL
LM
LN
LO
LP
LQ
LR
LS
LT
LU
LV
LW
LX
LY
LZ
MA
MB
MC
MD
ME
MF
MG
MH
MI
MJ
MK
ML
MM
MN
MO
MP
MQ
MR
MS
MT
MU
MV
MW
MX
MY
MZ
NA
NB
NC
ND
NE
NF
NG
NH
NI
NJ
NK
NL
NM
NN
NO
NP
NQ
NR
NS
NT
NU
NV
NW
NX
NY
NZ
OA
OB
OC
OD
OE
OF
OG
OH
OI
OJ
OK
OL
OM
ON
OO
OP
OQ
OR
OS
OT
OU
OV
OW
OX
OY
OZ
PA
PB
PC
PD
PE
PF
PG
PH
PI
PJ
PK
PL
PM
PN
PO
PP
PQ
PR
PS
PT
PU
PV
PW
PX
PY
PZ
QA
QB
QC
QD
QE
QF
QG
QH
QI
QJ
QK
QL
QM
QN
QO
QP
QQ
QR
QS
QT
QU
QV
QW
QX
QY
QZ
RA
RB
RC
RD
RE
RF
RG
RH
RI
RJ
RK
RL
RM
RN
RO
RP
RQ
RR
RS
RT
RU
RV
RW
RX
RY
RZ
SA
SB
SC
SD
SE
SF
SG
SH
SI
SJ
SK
SL
SM
SN
SO
SP
SQ
SR
SS
ST
SU
SV
SW
SX
SY
SZ
TA
TB
TC
TD
TE
TF
TG
TH
TI
TJ
TK
TL
TM
TN
TO
TP
TQ
TR
TS
TT
TU
TV
TW
TX
TY
TZ
UA
UB
UC
UD
UE
UF
UG
UH
UI
UJ
UK
UL
UM
UN
UO
UP
UQ
UR
US
UT
UU
UV
UW
UX
UY
UZ
VA
VB
VC
VD
VE
VF
VG
VH
VI
VJ
VK
VL
VM
VN
VO
VP
VQ
VR
VS
VT
VU
VV
VW
VX
VY
VZ
WA
WB
WC
WD
WE
WF
WG
WH
WI
WJ
WK
WL
WM
WN
WO
WP
WQ
WR
WS
WT
WU
WV
WW
WX
WY
WZ
XA
XB
XC
XD
XE
XF
XG
XH
XI
XJ
XK
XL
XM
XN
XO
XP
XQ
XR
XS
XT
XU
XV
XW
XX
XY
XZ
YA
YB
YC
YD
YE
YF
YG
YH
YI
YJ
YK
YL
YM
YN
YO
YP
YQ
YR
YS
YT
YU
YV
YW
YX
YY
YZ
ZA
ZB
ZC
ZD
ZE
ZF
ZG
ZH
ZI
ZJ
ZK
ZL
ZM
ZN
ZO
ZP
ZQ
ZR
ZS
ZT
ZU
ZV
ZW
ZX
ZY
ZZ

Präparierscheren, DELICATE
 Dissecting Scissors, DELICATE
 Tijeras para preparaciones, DELICATE
 Ciseaux à dissection, DELICATE
 Forbici per preparazioni, DELICATE

METZENBAUM-DELICATE

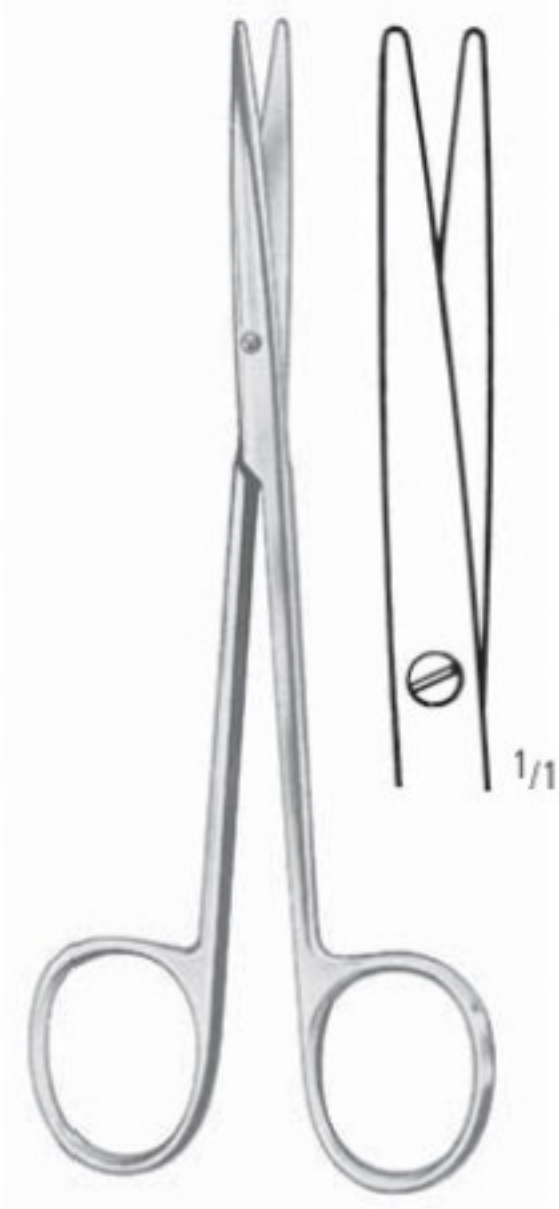

Fig. 1
 AC 140/14
 14,5 cm/5³/₄"



Fig. 1
 AC 141/14*
 14,5 cm/5³/₄"

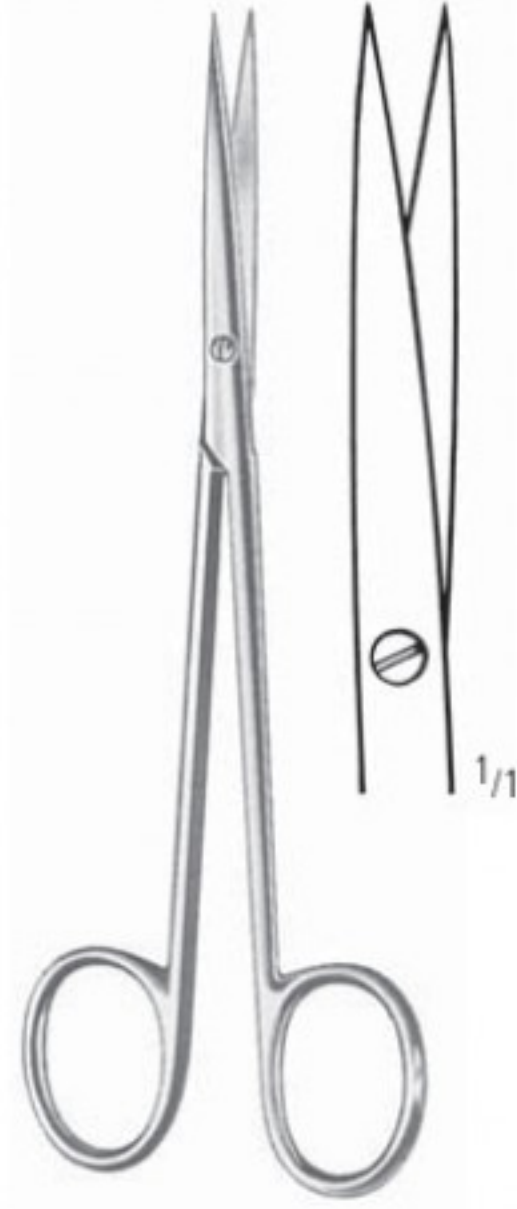

Fig. 3
 AC 142/14
 14,5 cm/5³/₄"

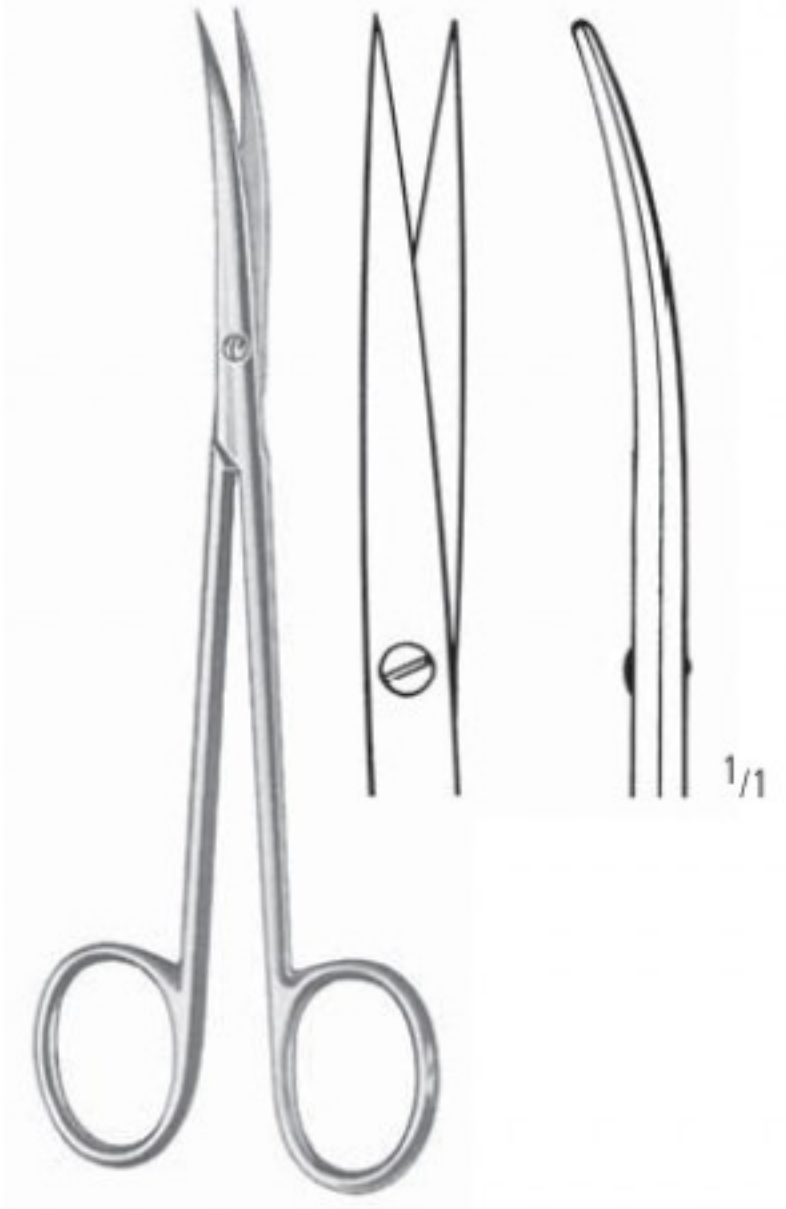

Fig. 3
 AC 143/14
 14,5 cm/5³/₄"

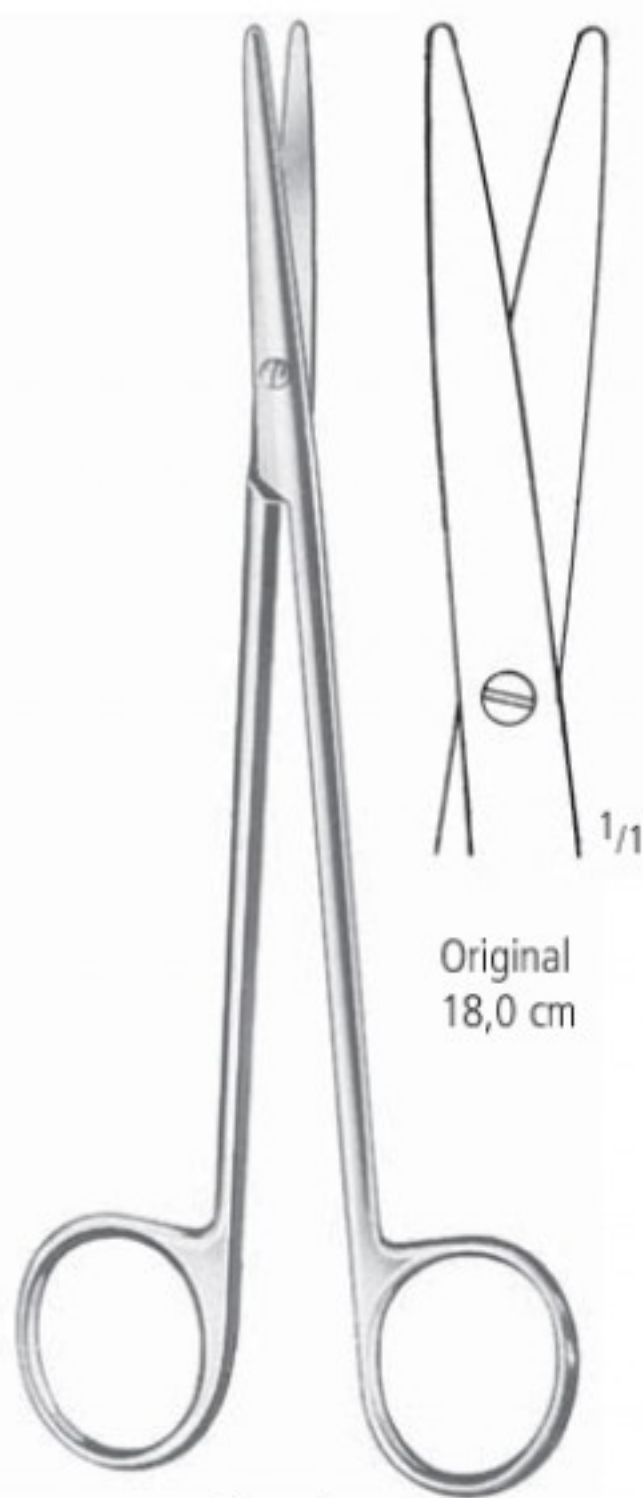

Fig. 1

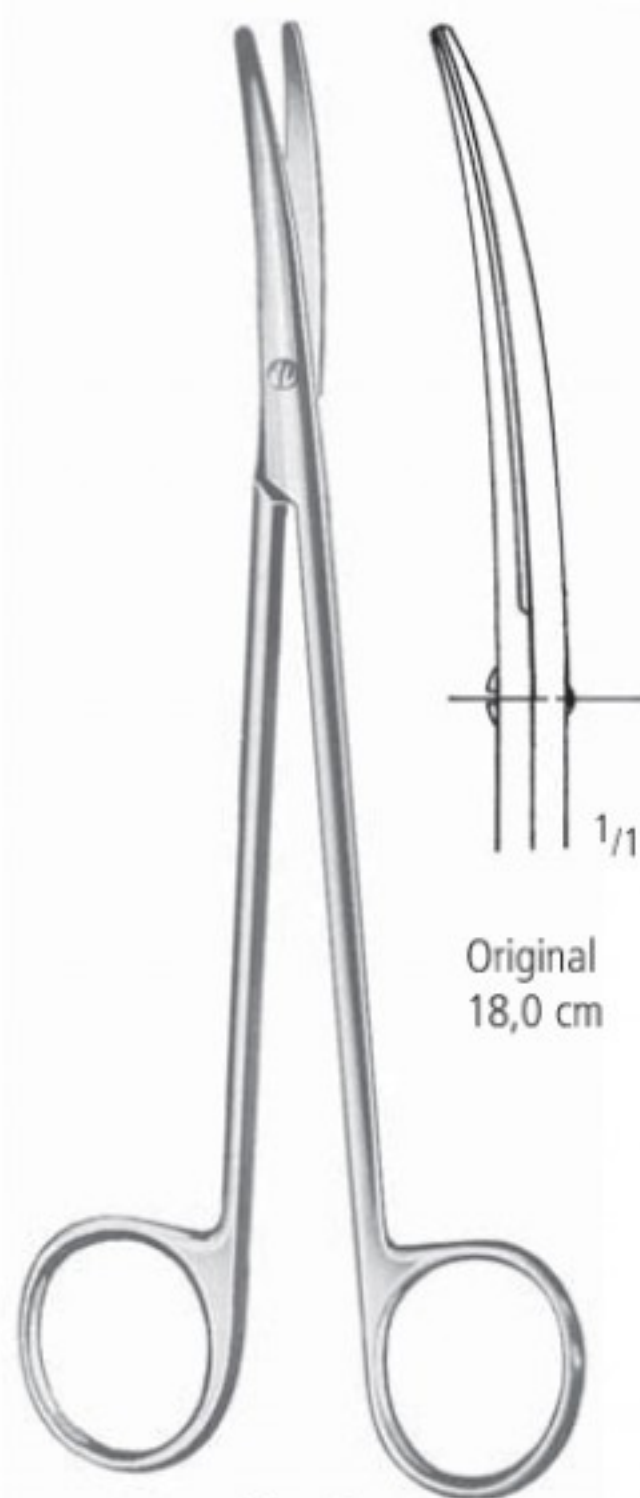

Fig. 1

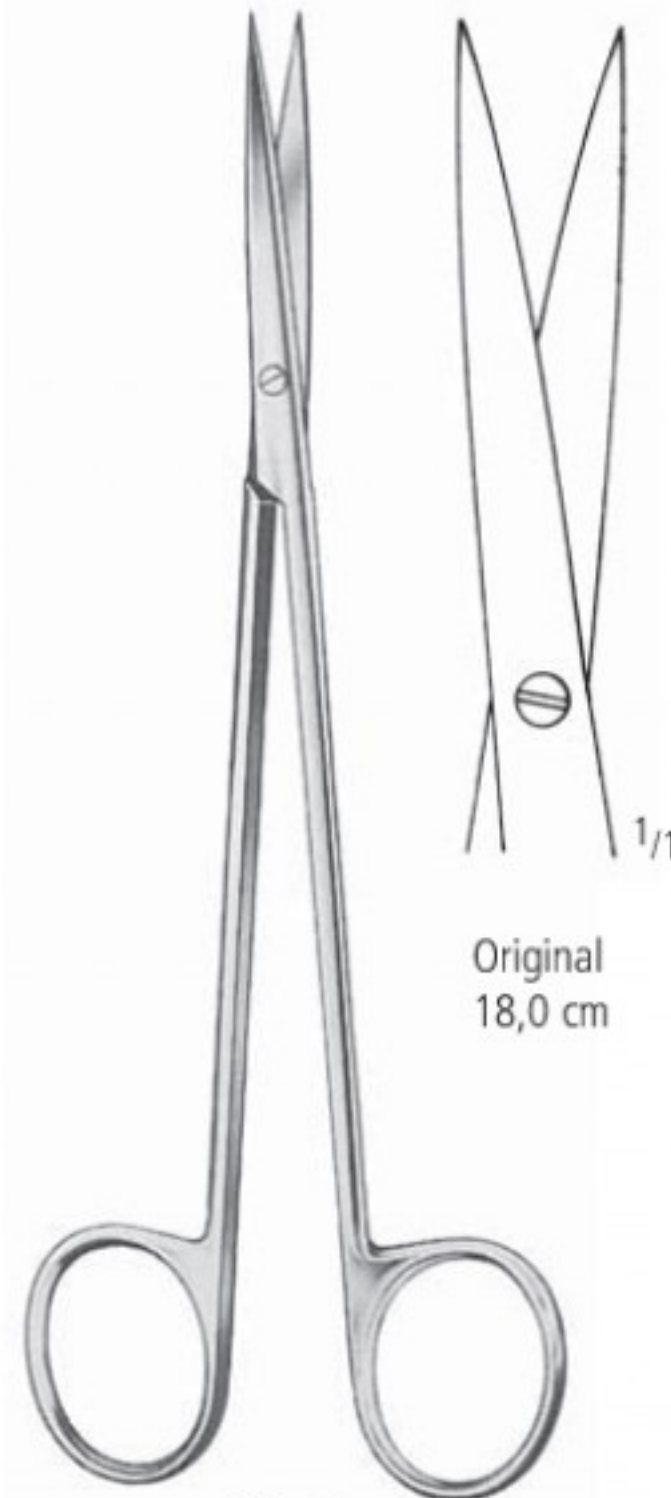

Fig. 3

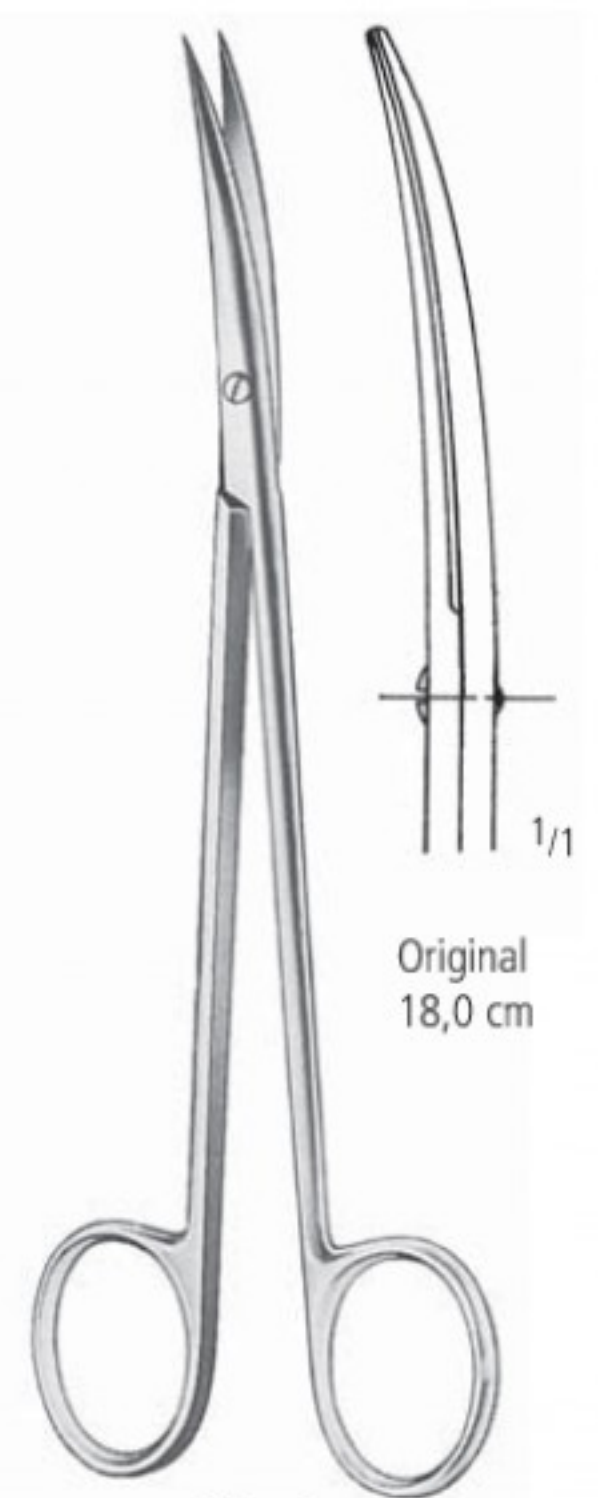

Fig. 3

18,0 cm/7"	AC 150/18	AC 151/18*	AC 152/18	AC 153/18
20,0 cm/8"	AC 150/20	AC 151/20	AC 152/20	AC 153/20
23,0 cm/9"	AC 150/23	AC 151/23	AC 152/23	AC 153/23
25,0 cm/10"			AC 152/25	AC 153/25
28,0 cm/11"			AC 152/28	AC 153/28
30,0 cm/12"			AC 152/30	AC 153/30

SCHEREN SCISSORS TIJERAS CISEAUX FORBICI

Präparierscheren
Dissecting Scissors
Tijeras para preparaciones
Ciseaux à dissection
Forbici per preparazioni

AA
AB
AC
AD
AE
AF
AG
AH
AI
AJ
AK
AL
AM
AN
AO
AP
AQ
AR
AS
AT
AU
AV
AW
AX
AY
AZ
BA
BB
BC
BD
BE
BF
BG
BH
BI
BJ
BK
BL
BM
BN
BO
BP
BQ
BR
BS
BT
BU
BV
BW
BX
BY
BZ
CA
CB
CC
CD
CE
CF
CG
CH
CI
CJ
CK
CL
CM
CN
CO
CP
CQ
CR
CS
CT
CU
CV
CW
CX
CY
CZ
DA
DB
DC
DD
DE
DF
DG
DH
DI
DJ
DK
DL
DM
DN
DO
DP
DQ
DR
DS
DT
DU
DV
DW
DX
DY
DZ
EA
EB
EC
ED
EE
EF
EG
EH
EI
EJ
EK
EL
EM
EN
EO
EP
EQ
ER
ES
ET
EU
EV
EW
EX
EY
EZ
FA
FB
FC
FD
FE
FF
FG
FH
FI
FJ
FK
FL
FM
FN
FO
FP
FQ
FR
FS
FT
FU
FV
FW
FX
FY
FZ
GA
GB
GC
GD
GE
GF
GG
GH
GI
GJ
GK
GL
GM
GN
GO
GP
GQ
GR
GS
GT
GU
GV
GW
GX
GY
GZ
HA
HB
HC
HD
HE
HF
HG
HH
HI
HJ
HK
HL
HM
HN
HO
HP
HQ
HR
HS
HT
HU
HV
HW
HX
HY
HZ
IA
IB
IC
ID
IE
IF
IG
IH
II
IJ
IK
IL
IM
IN
IO
IP
IQ
IR
IS
IT
IU
IV
IW
IX
IY
IZ
JA
JB
JC
JD
JE
JF
JG
JH
JI
JJ
JK
JL
JM
JN
JO
JP
JQ
JR
JS
JT
JU
JV
JW
JX
JY
JZ
KA
KB
KC
KD
KE
KF
KG
KH
KI
KJ
KK
KL
KM
KN
KO
KP
KQ
KR
KS
KT
KU
KV
KW
KX
KY
KZ
LA
LB
LC
LD
LE
LF
LG
LH
LI
LJ
LK
LL
LM
LN
LO
LP
LQ
LR
LS
LT
LU
LV
LW
LX
LY
LZ
MA
MB
MC
MD
ME
MF
MG
MH
MI
MJ
MK
ML
MM
MN
MO
MP
MQ
MR
MS
MT
MU
MV
MW
MX
MY
MZ
NA
NB
NC
ND
NE
NF
NG
NH
NI
NJ
NK
NL
NM
NN
NO
NP
NQ
NR
NS
NT
NU
NV
NW
NX
NY
NZ
OA
OB
OC
OD
OE
OF
OG
OH
OI
OJ
OK
OL
OM
ON
OO
OP
OQ
OR
OS
OT
OU
OV
OW
OX
OY
OZ
PA
PB
PC
PD
PE
PF
PG
PH
PI
PJ
PK
PL
PM
PN
PO
PP
PQ
PR
PS
PT
PU
PV
PW
PX
PY
PZ
QA
QB
QC
QD
QE
QF
QG
QH
QI
QJ
QK
QL
QM
QN
QO
QP
QQ
QR
QS
QT
QU
QV
QW
QX
QY
QZ
RA
RB
RC
RD
RE
RF
RG
RH
RI
RJ
RK
RL
RM
RN
RO
RP
RQ
RR
RS
RT
RU
RV
RW
RX
RY
RZ
SA
SB
SC
SD
SE
SF
SG
SH
SI
SJ
SK
SL
SM
SN
SO
SP
SQ
SR
SS
ST
SU
SV
SW
SX
SY
SZ
TA
TB
TC
TD
TE
TF
TG
TH
TI
TJ
TK
TL
TM
TN
TO
TP
TQ
TR
TS
TT
TU
TV
TW
TX
TY
TZ
UA
UB
UC
UD
UE
UF
UG
UH
UI
UJ
UK
UL
UM
UN
UO
UP
UQ
UR
US
UT
UU
UV
UW
UX
UY
UZ
VA
VB
VC
VD
VE
VF
VG
VH
VI
VJ
VK
VL
VM
VN
VO
VP
VQ
VR
VS
VT
VU
VV
VW
VX
VY
VZ
WA
WB
WC
WD
WE
WF
WG
WH
WI
WJ
WK
WL
WM
WN
WO
WP
WQ
WR
WS
WT
WU
WV
WW
WX
WY
WZ
XA
XB
XC
XD
XE
XF
XG
XH
XI
XJ
XK
XL
XM
XN
XO
XP
XQ
XR
XS
XT
XU
XV
XW
XX
XY
XZ
YA
YB
YC
YD
YE
YF
YG
YH
YI
YJ
YK
YL
YM
YN
YO
YP
YQ
YR
YS
YT
YU
YV
YW
YX
YZ
ZA
ZB
ZC
ZD
ZE
ZF
ZG
ZH
ZI
ZJ
ZK
ZL
ZM
ZN
ZO
ZP
ZQ
ZR
ZS
ZT
ZU
ZV
ZW
ZX
ZY
ZZ

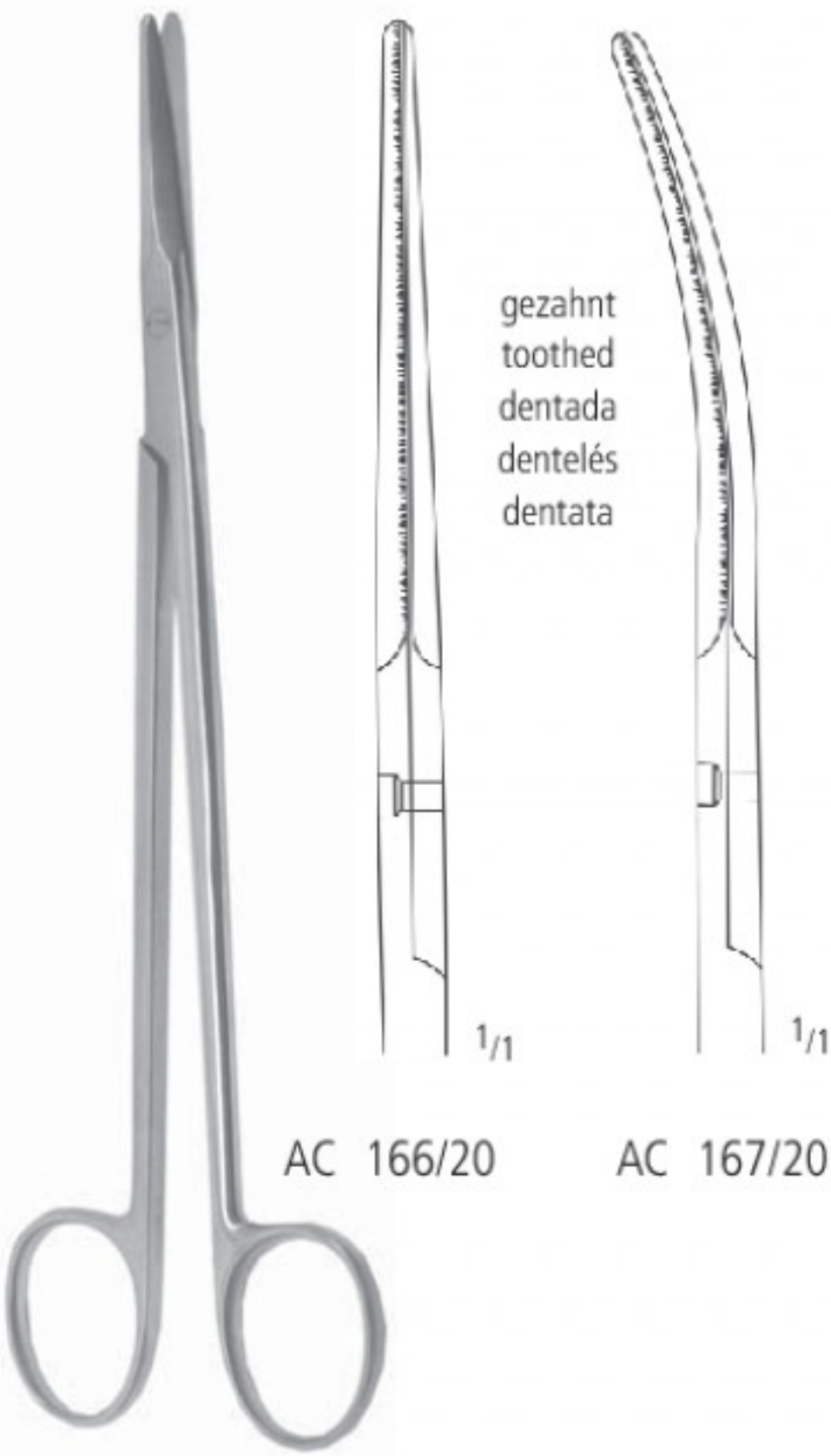

GORNEY
19,5 cm/7³/₄"

gezahnt
toothed
dentada
dentelés
dentata

Nerv-Präparierschere
Nerve dissecting scissors
Tijeras para nervios
Ciseaux pour nerfs
Forbici per nervi

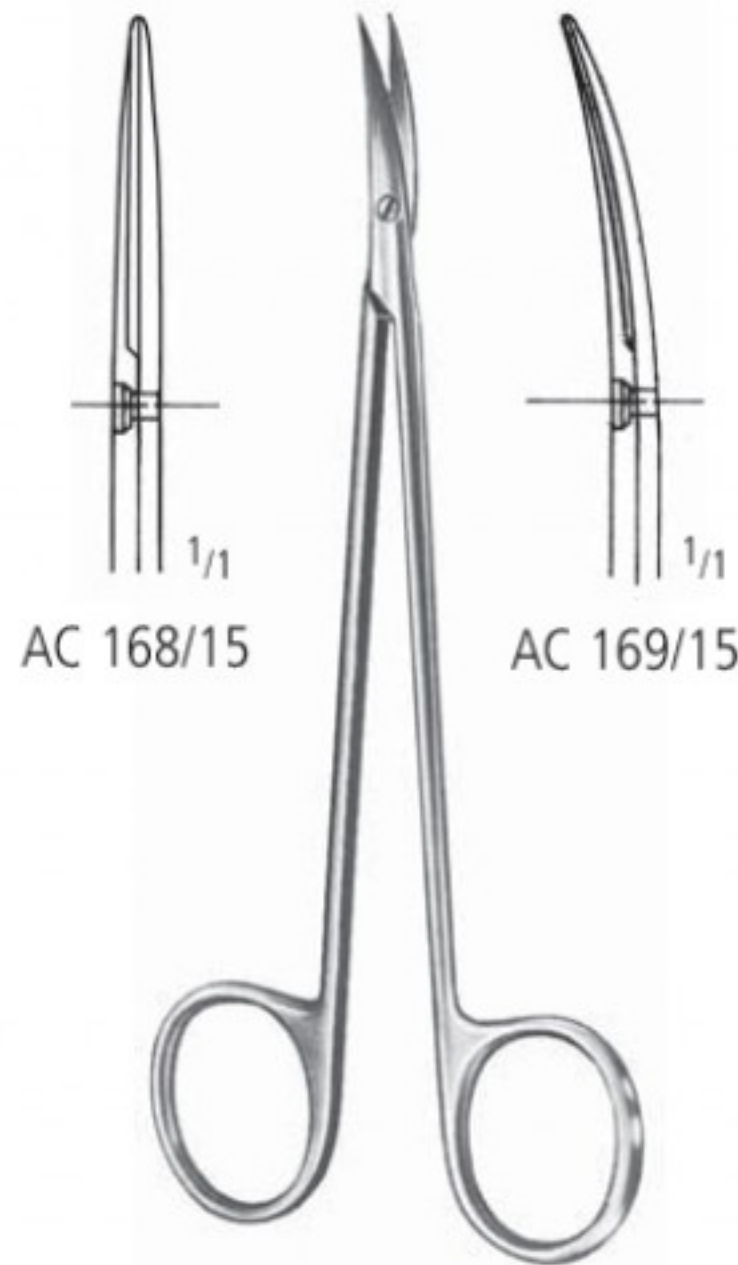

15,0 cm/6"



LEXER
AC 170/16
16,0 cm/6¹/₄"



LEXER
AC 171/16
16,0 cm/6¹/₄"



FOMON
AC 173/13
13,5 cm/5¹/₄"

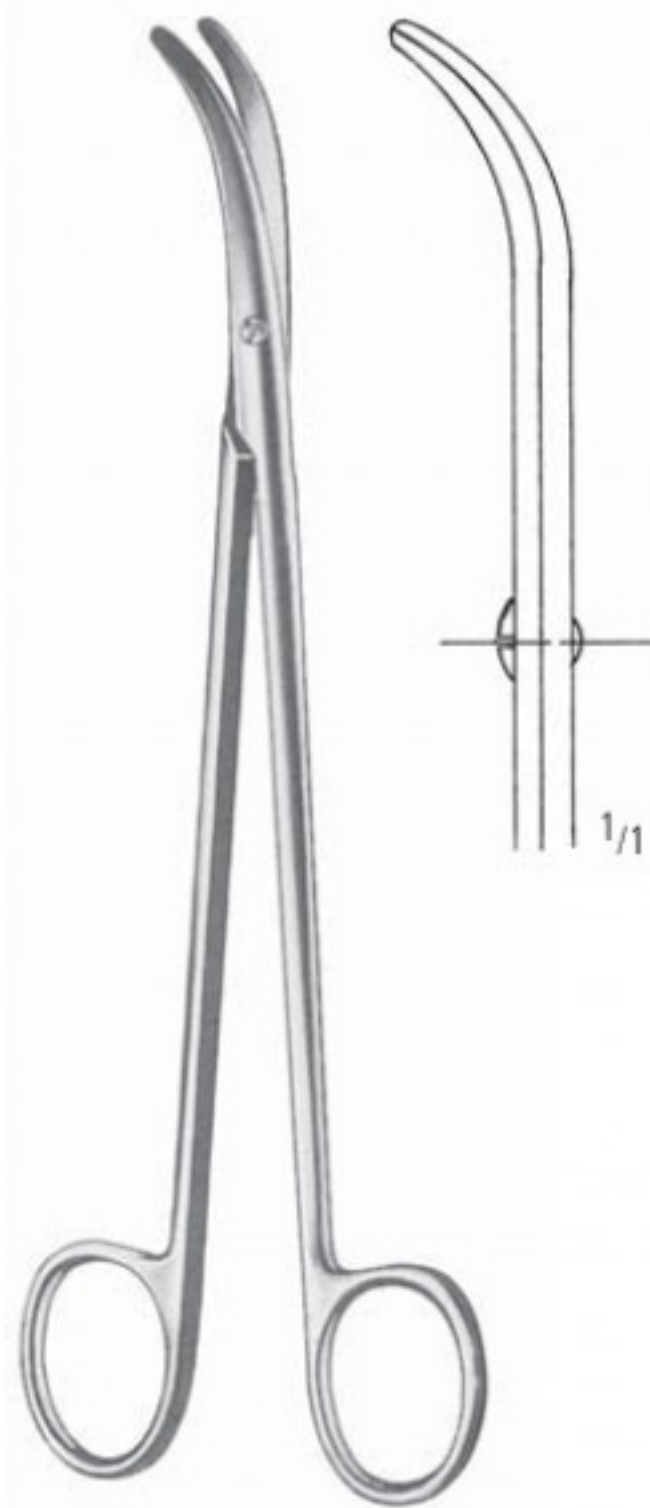

THOREK
AC 175/19
19,0 cm/7¹/₂"



LEXER-BABY
AC 176/10
10,0 cm/4"

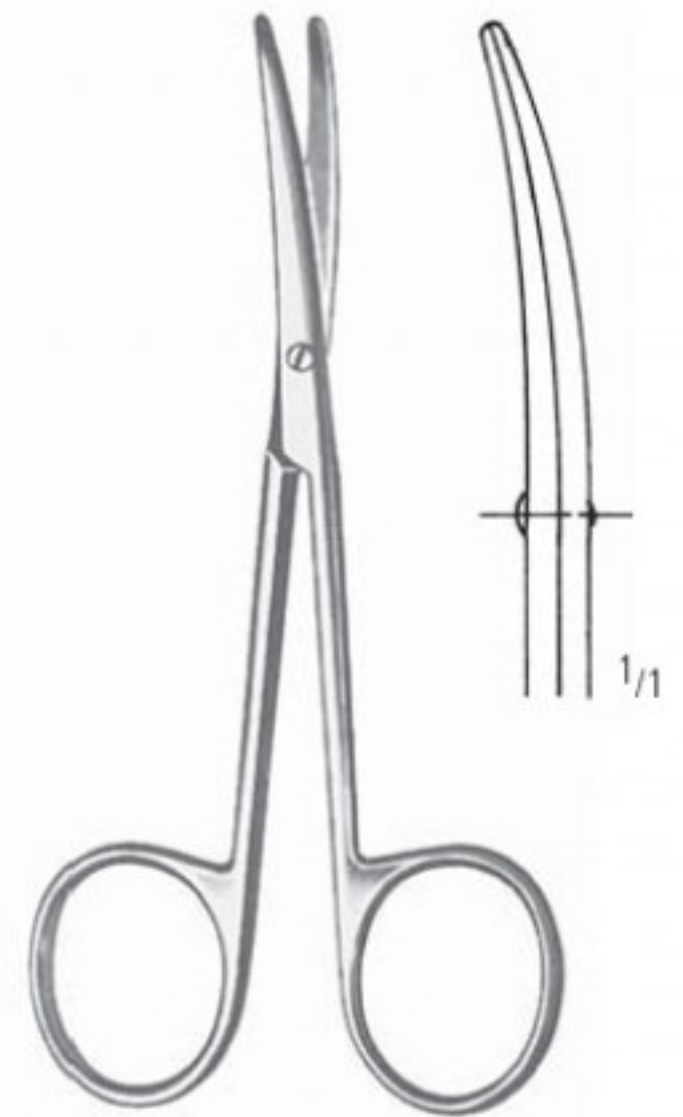

LEXER-BABY
AC 177/10
10,0 cm/4"

AC SCHEREN SCISSORS TIJERAS CISEAUX FORBICI

Präparierscheren
Dissecting Scissors
Tijeras para preparaciones
Ciseaux à dissection
Forbici per preparazioni

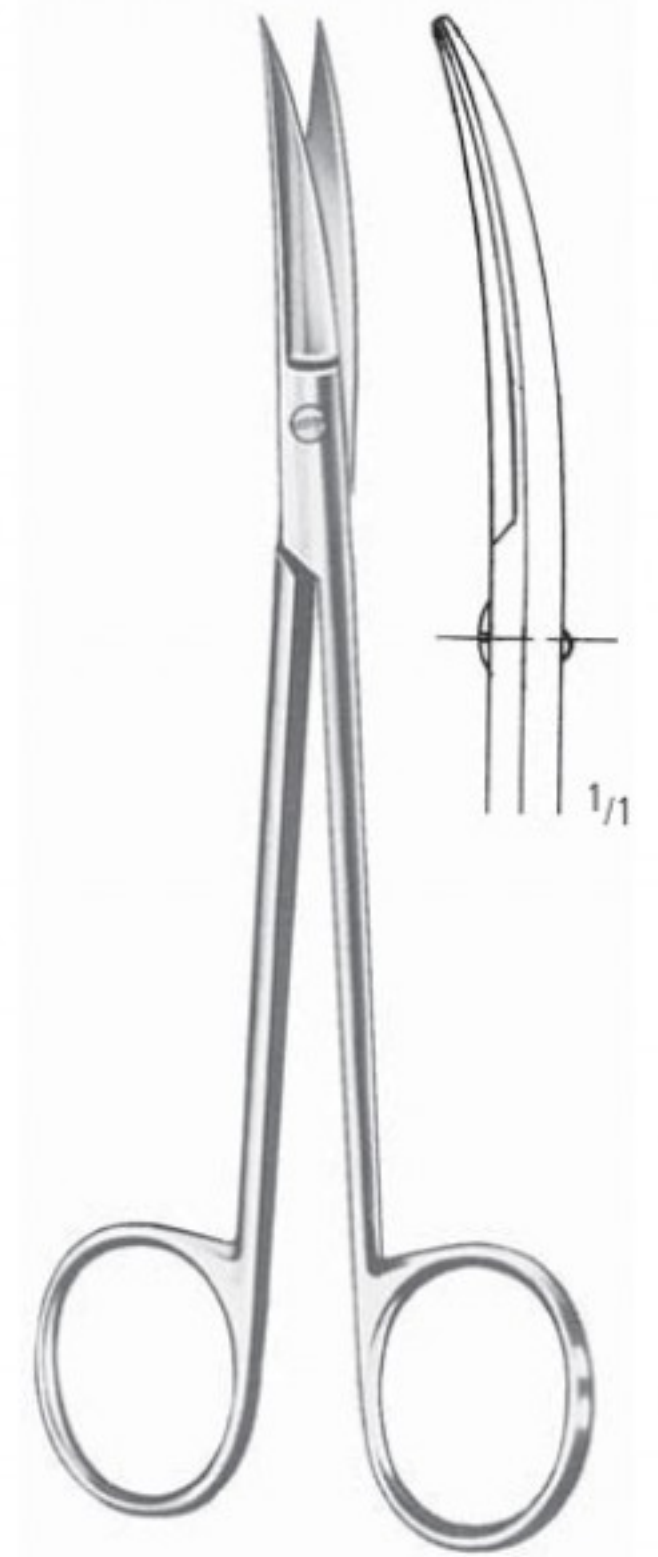
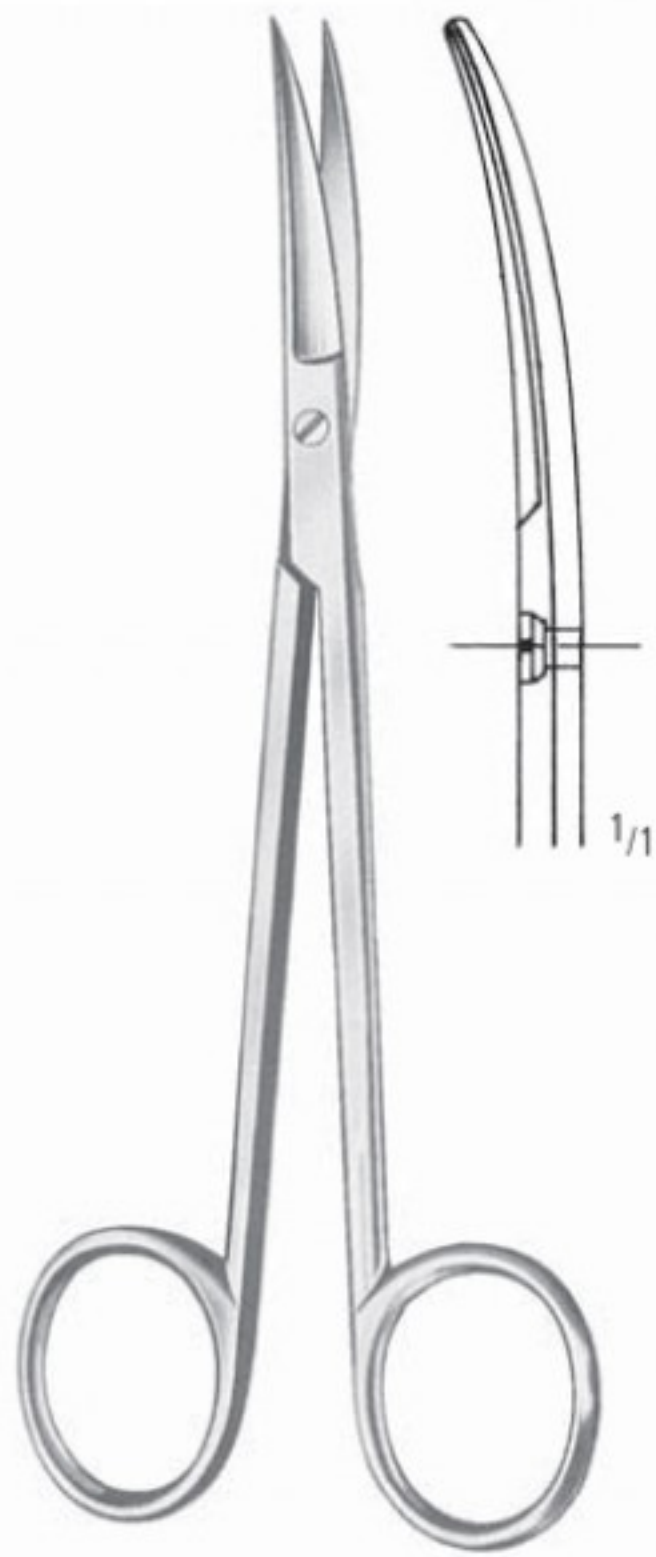

SANVENERO

AC 200/14
14,0 cm/5 1/2"

AC 201/14
14,0 cm/5 1/2"

JOSEPH

AC 204/14
14,0 cm/5 1/2"

AC 205/14
14,0 cm/5 1/2"

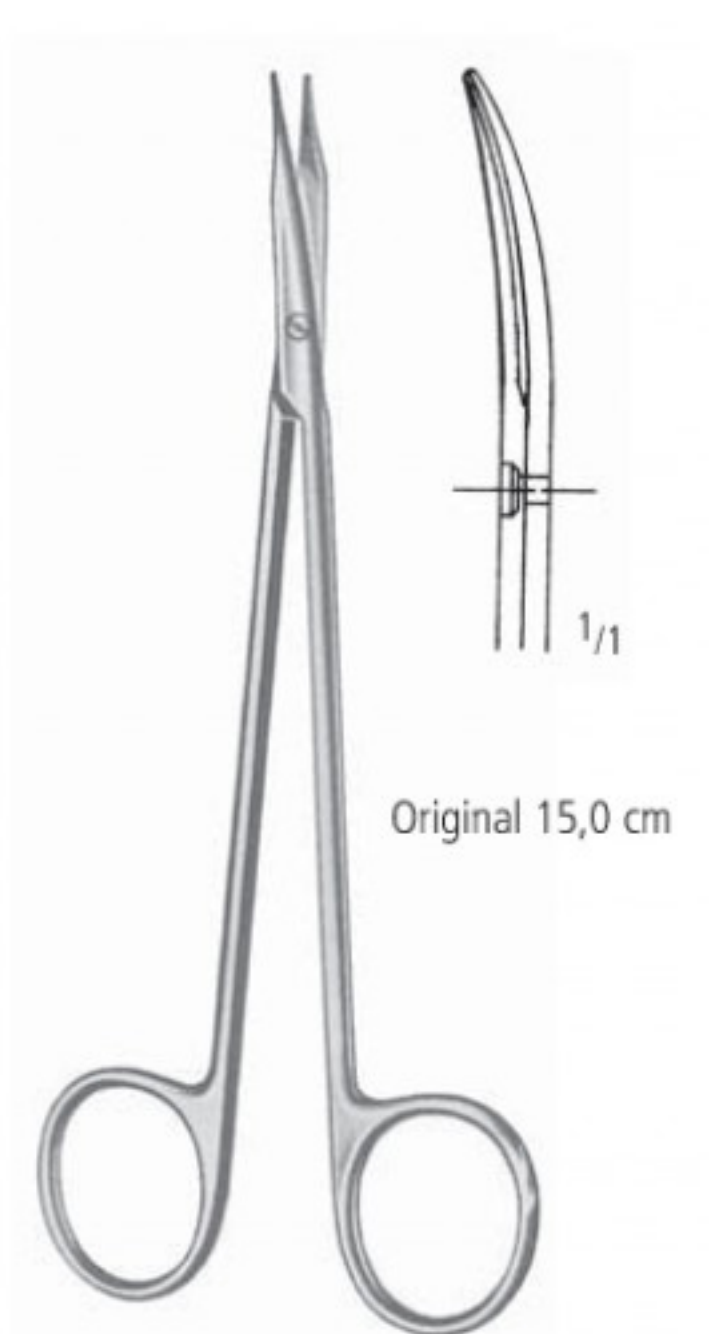
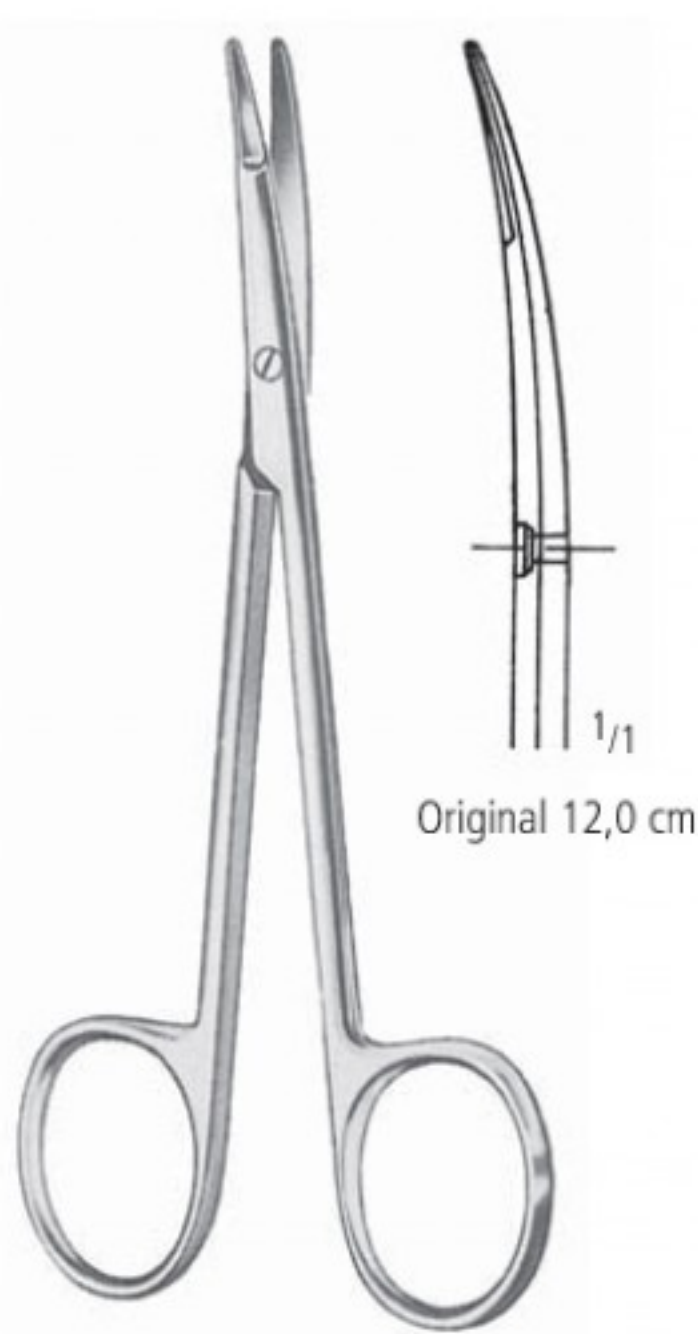

KILNER (RAGNELL)

AC 208/12	12,0 cm/4 3/4"	AC 210/12
AC 208/15	15,0 cm/6"	AC 210/15
AC 208/18	18,0 cm/7"	AC 210/18
AC 208/20	20,0 cm/8"	AC 210/20

REYNOLDS

AC 214/15*	15,0 cm/6"	AC 215/15
AC 214/18*	18,0 cm/7"	AC 215/18

SCHEREN SCISSORS TIJERAS CISEAUX FORBICI

Scheren für Gefäß-Chirurgie
 Scissors for Vascular Surgery
 Tijeras para cirugía vasculares
 Ciseaux pour chirurgie vasculaire
 Forbici per chirurgia vascolare

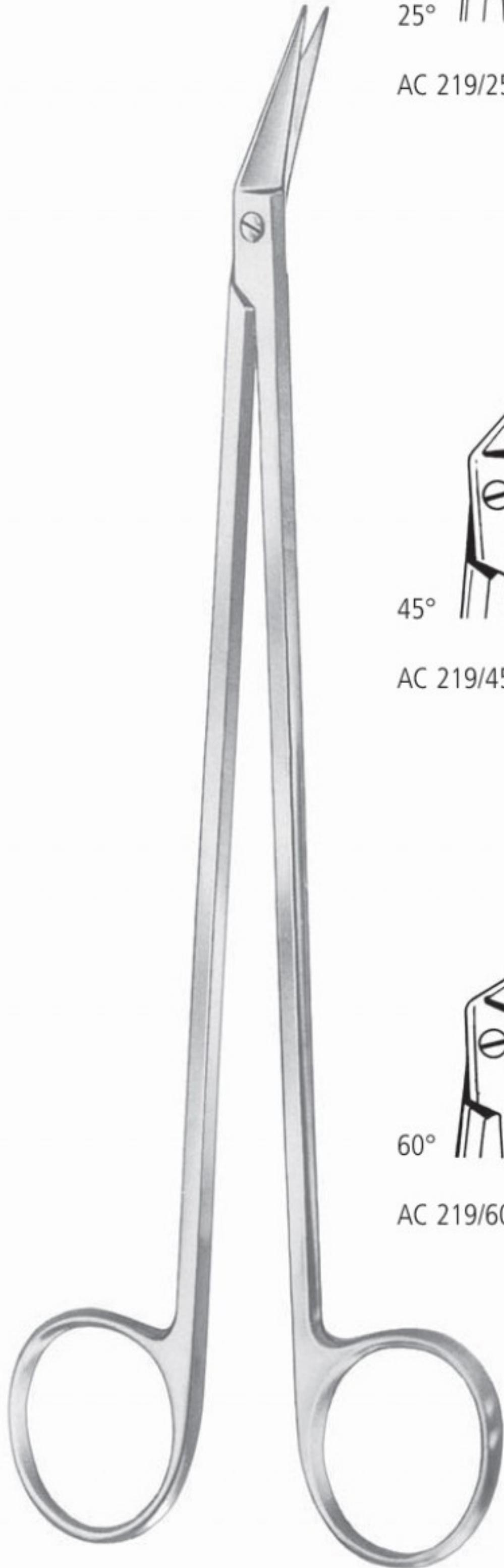

25°

AC 219/25



45°

AC 219/45

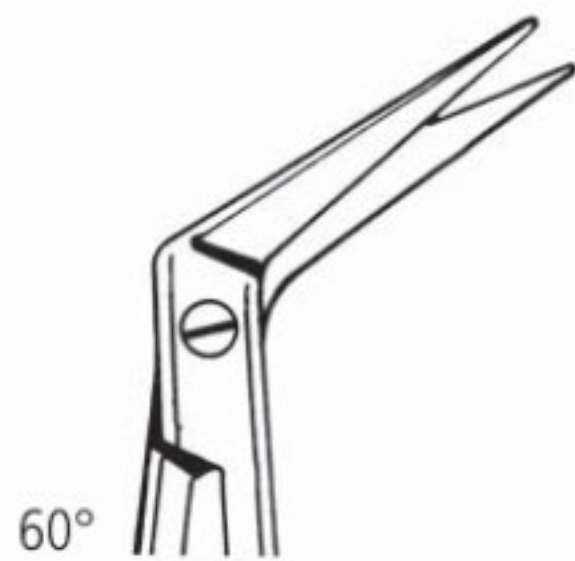

60°

AC 219/60

POTTS-SMITH
 19,0 cm/7¹/₂"



25°

AC 220/16 17,0 cm/6³/₄"
 AC 220/19 19,0 cm/7¹/₂"
 AC 220/23 23,0 cm/9"
 AC 220/28 28,0 cm/11"

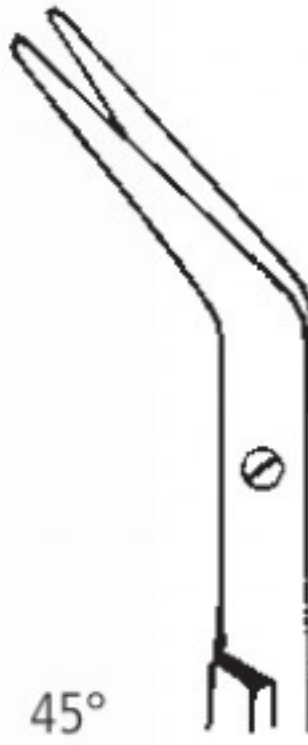

45°

AC 221/16 17,0 cm/6³/₄"
 AC 221/19 19,0 cm/7¹/₂"
 AC 221/23 23,0 cm/9"
 AC 221/28 28,0 cm/11"

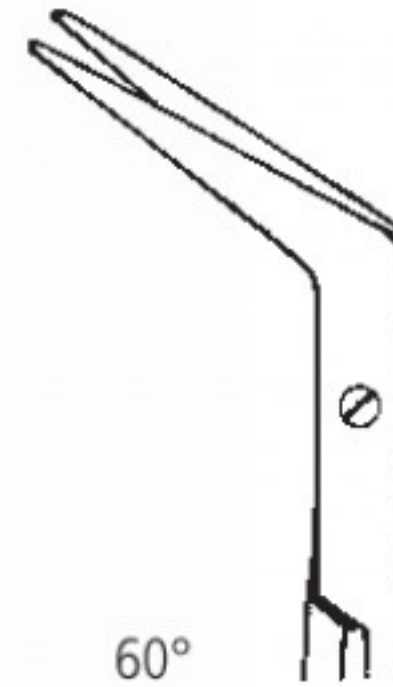

60°

AC 222/16 17,0 cm/6³/₄"
 AC 222/19 19,0 cm/7¹/₂"
 AC 222/23 23,0 cm/9"
 AC 222/28 28,0 cm/11"

DE BAKAY

AA
 AB
 AC
 AD
 AE
 AF
 AG
 AH
 AI
 AJ
 AK
 AL
 AM
 AN
 AO
 AP
 AQ
 AR
 AS
 AT
 AU
 AV
 AW
 AX
 AY
 AZ

AC SCHEREN SCISSORS TIJERAS CISEAUX FORBICI

Scheren für Gefäß-Chirurgie
 Scissors for Vascular Surgery
 Tijeras para cirugía vasculares
 Ciseaux pour chirurgie vasculaire
 Forbici per chirurgia vascolare

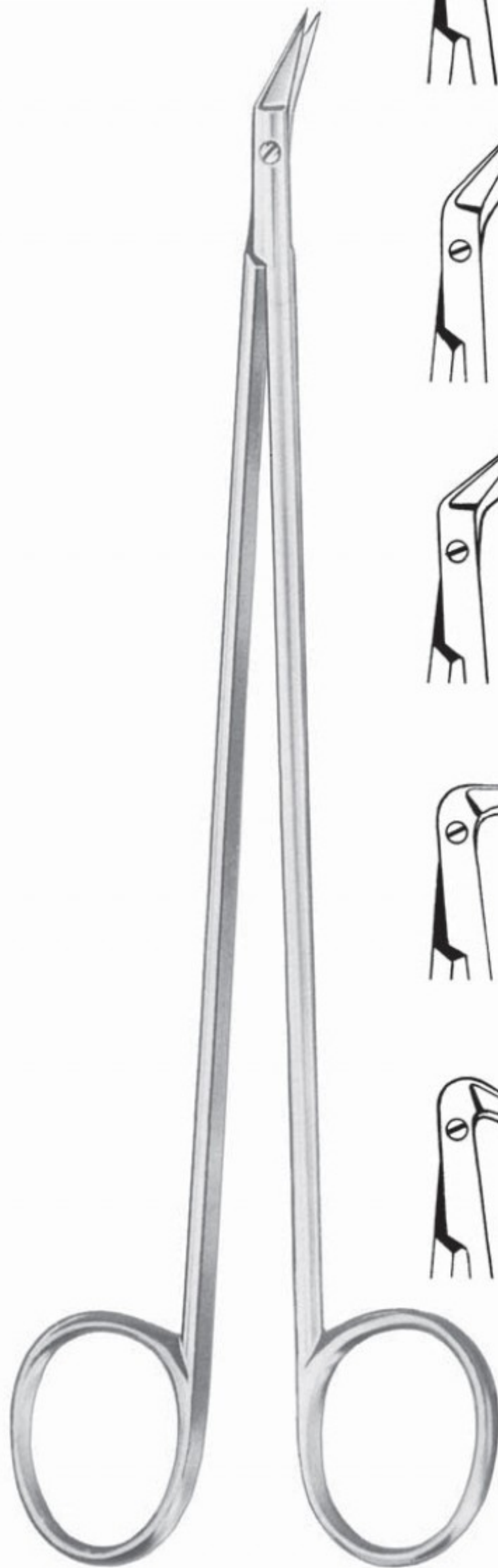

18,0 cm/7"



25°
 AC 223/01
 AC 224/01

18,0 cm/7"
 19,0 cm/7½"



45°
 AC 223/02
 AC 224/02

18,0 cm/7"
 19,0 cm/7½"

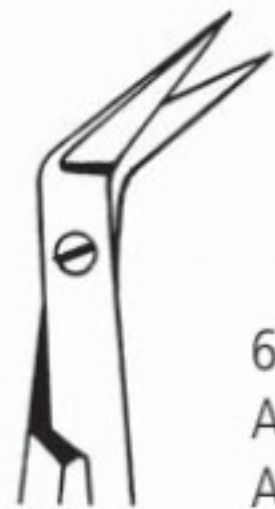

60°
 AC 223/03
 AC 224/03

17,5 cm/7"
 19,0 cm/7½"



90°
 AC 223/04
 AC 224/04

17,0 cm/6¾"
 18,0 cm/7"



125°
 AC 223/05
 AC 224/05

17,0 cm/6¾"
 18,0 cm/7"

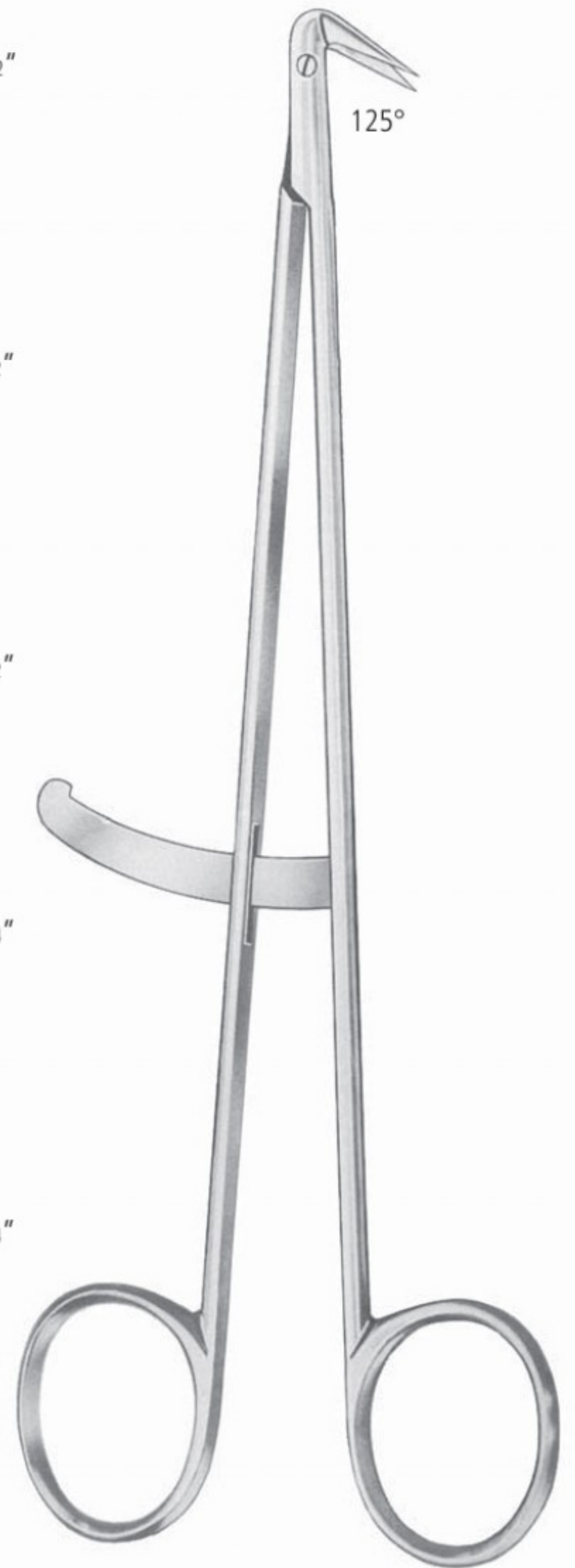

AC 225/19
 19,0 cm/7½"

HEGEMANN-DIETRICH

SCHEREN SCISSORS TIJERAS CISEAUX FORBICI

Scheren für Gefäß- und Neurochirurgie
 Scissors for Vascular and Neuro Surgery
 Tijeras para cirugía vasculares y neurocirugía
 Ciseaux pour chirurgie vasculaire et neurochirurgie
 Forbici vascolari, Forbici per neurochirurgia

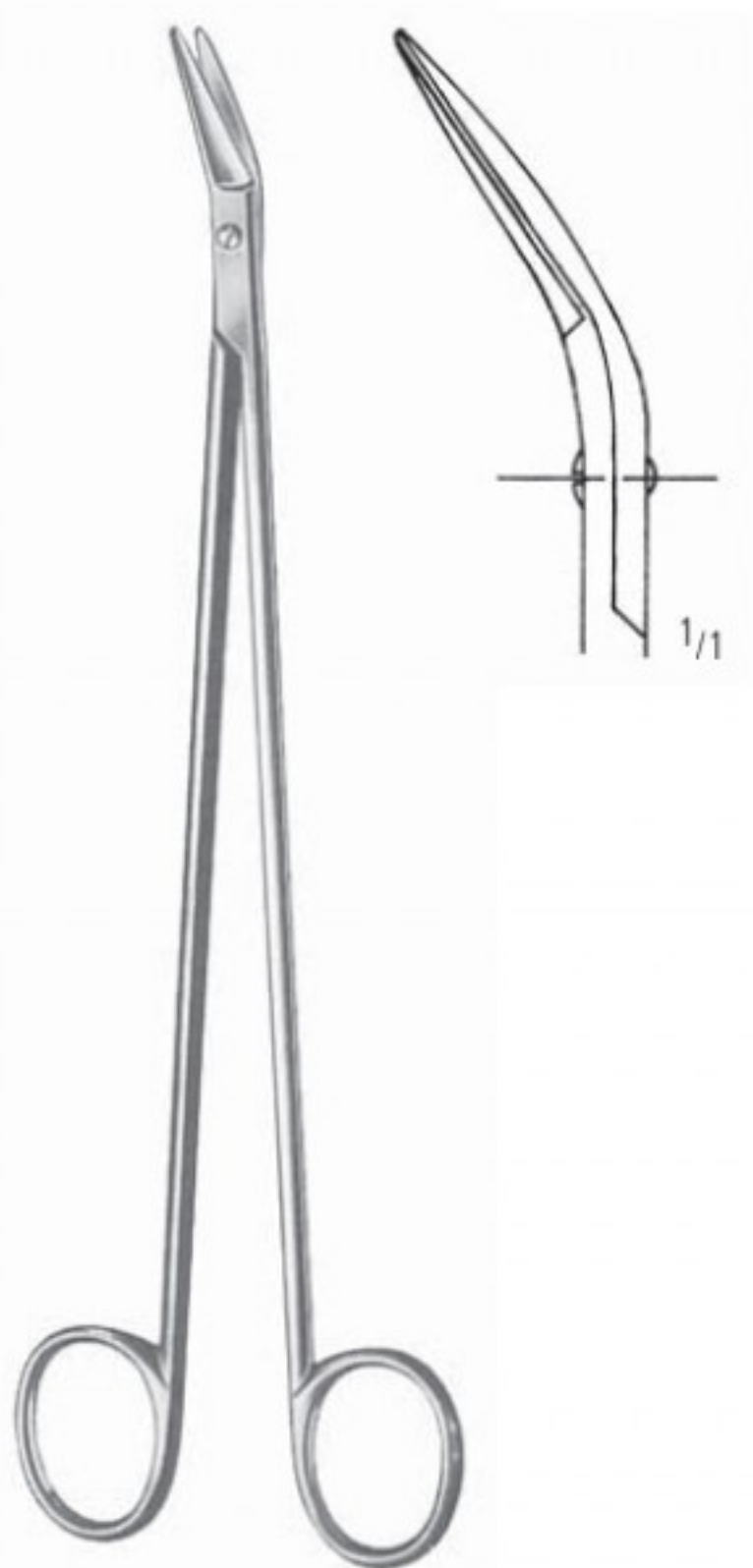

POTTS-SMITH
 AC 227/19
 19,5 cm/7³/₄"



Coronar-Schere
 Coronary-Scissors
 Tijeras coronarias
 Ciseaux coronaires
 Forbici coronaria

AC 228/11
 11,5 cm/4¹/₂"



AC 230/14
 14,5 cm/5³/₄"

geknöpft
 probe pointed
 con botón
 boutonne
 bottenuto



AC 231/22
 22,0 cm/8³/₄"

STRULLY



AC 232/22
 22,0 cm/8³/₄"

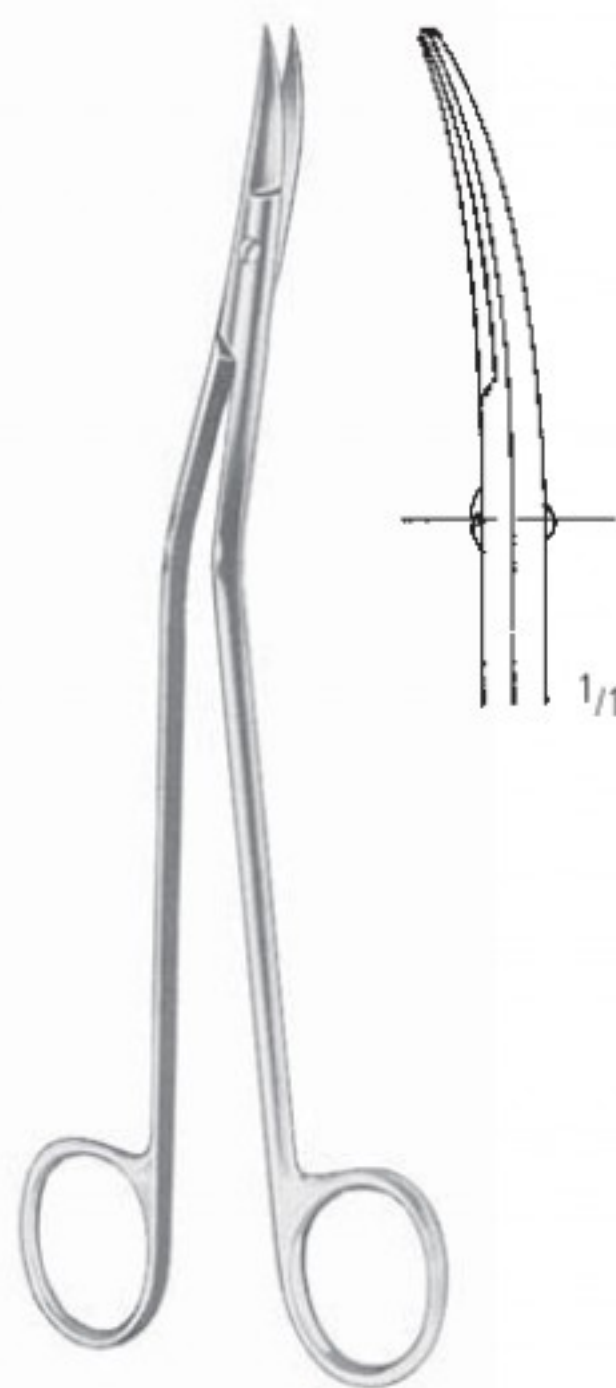

DANDY
 AC 233/17
 17,0 cm/6³/₄"

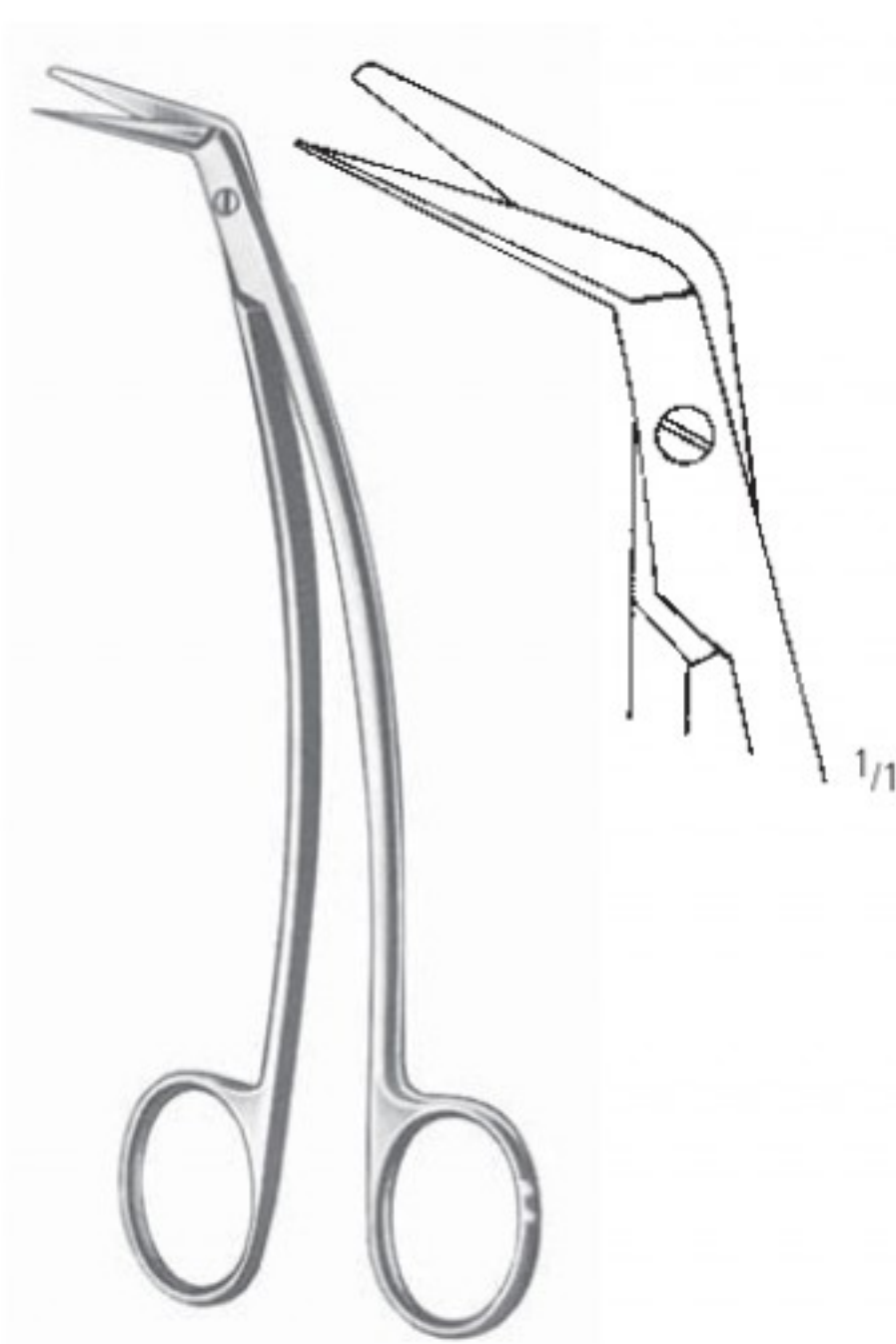

FAVALORO
 AC 234/15
 15,0 cm/6"

AA
 AB
 AC
 AD
 AE
 AF
 AG
 AH
 AI
 AJ
 AK
 AL
 AM
 AN
 AO
 AP
 AQ
 AR
 AS
 AT
 AU
 AV
 AW
 AX
 AY
 AZ
 BA
 BB
 BC
 BD
 BE
 BF
 BG
 BH
 BI
 BJ
 BK
 BL
 BM
 BN
 BO
 BP
 BQ
 BR
 BS
 BT
 BU
 BV
 BW
 BX
 BY
 BZ
 CA
 CB
 CC
 CD
 CE
 CF
 CG
 CH
 CI
 CJ
 CK
 CL
 CM
 CN
 CO
 CP
 CQ
 CR
 CS
 CT
 CU
 CV
 CW
 CX
 CY
 CZ
 DA
 DB
 DC
 DD
 DE
 DF
 DG
 DH
 DI
 DJ
 DK
 DL
 DM
 DN
 DO
 DP
 DQ
 DR
 DS
 DT
 DU
 DV
 DW
 DX
 DY
 DZ
 EA
 EB
 EC
 ED
 EE
 EF
 EG
 EH
 EI
 EJ
 EK
 EL
 EM
 EN
 EO
 EP
 EQ
 ER
 ES
 ET
 EU
 EV
 EW
 EX
 EY
 EZ
 FA
 FB
 FC
 FD
 FE
 FF
 FG
 FH
 FI
 FJ
 FK
 FL
 FM
 FN
 FO
 FP
 FQ
 FR
 FS
 FT
 FU
 FV
 FW
 FX
 FY
 FZ
 GA
 GB
 GC
 GD
 GE
 GF
 GG
 GH
 GI
 GJ
 GK
 GL
 GM
 GN
 GO
 GP
 GQ
 GR
 GS
 GT
 GU
 GV
 GW
 GX
 GY
 GZ
 HA
 HB
 HC
 HD
 HE
 HF
 HG
 HH
 HI
 HJ
 HK
 HL
 HM
 HN
 HO
 HP
 HQ
 HR
 HS
 HT
 HU
 HV
 HW
 HX
 HY
 HZ
 IA
 IB
 IC
 ID
 IE
 IF
 IG
 IH
 II
 IJ
 IK
 IL
 IM
 IN
 IO
 IP
 IQ
 IR
 IS
 IT
 IU
 IV
 IW
 IX
 IY
 IZ
 JA
 JB
 JC
 JD
 JE
 JF
 JG
 JH
 JI
 JJ
 JK
 JL
 JM
 JN
 JO
 JP
 JQ
 JR
 JS
 JT
 JU
 JV
 JW
 JX
 JY
 JZ
 KA
 KB
 KC
 KD
 KE
 KF
 KG
 KH
 KI
 KJ
 KK
 KL
 KM
 KN
 KO
 KP
 KQ
 KR
 KS
 KT
 KU
 KV
 KW
 KX
 KY
 KZ
 LA
 LB
 LC
 LD
 LE
 LF
 LG
 LH
 LI
 LJ
 LK
 LL
 LM
 LN
 LO
 LP
 LQ
 LR
 LS
 LT
 LU
 LV
 LW
 LX
 LY
 LZ
 MA
 MB
 MC
 MD
 ME
 MF
 MG
 MH
 MI
 MJ
 MK
 ML
 MM
 MN
 MO
 MP
 MQ
 MR
 MS
 MT
 MU
 MV
 MW
 MX
 MY
 MZ
 NA
 NB
 NC
 ND
 NE
 NF
 NG
 NH
 NI
 NJ
 NK
 NL
 NM
 NN
 NO
 NP
 NQ
 NR
 NS
 NT
 NU
 NV
 NW
 NX
 NY
 NZ
 OA
 OB
 OC
 OD
 OE
 OF
 OG
 OH
 OI
 OJ
 OK
 OL
 OM
 ON
 OO
 OP
 OQ
 OR
 OS
 OT
 OU
 OV
 OW
 OX
 OY
 OZ
 PA
 PB
 PC
 PD
 PE
 PF
 PG
 PH
 PI
 PJ
 PK
 PL
 PM
 PN
 PO
 PP
 PQ
 PR
 PS
 PT
 PU
 PV
 PW
 PX
 PY
 PZ
 QA
 QB
 QC
 QD
 QE
 QF
 QG
 QH
 QI
 QJ
 QK
 QL
 QM
 QN
 QO
 QP
 QQ
 QR
 QS
 QT
 QU
 QV
 QW
 QX
 QY
 QZ
 RA
 RB
 RC
 RD
 RE
 RF
 RG
 RH
 RI
 RJ
 RK
 RL
 RM
 RN
 RO
 RP
 RQ
 RR
 RS
 RT
 RU
 RV
 RW
 RX
 RY
 RZ
 SA
 SB
 SC
 SD
 SE
 SF
 SG
 SH
 SI
 SJ
 SK
 SL
 SM
 SN
 SO
 SP
 SQ
 SR
 SS
 ST
 SU
 SV
 SW
 SX
 SY
 SZ
 TA
 TB
 TC
 TD
 TE
 TF
 TG
 TH
 TI
 TJ
 TK
 TL
 TM
 TN
 TO
 TP
 TQ
 TR
 TS
 TT
 TU
 TV
 TW
 TX
 TY
 TZ
 UA
 UB
 UC
 UD
 UE
 UF
 UG
 UH
 UI
 UJ
 UK
 UL
 UM
 UN
 UO
 UP
 UQ
 UR
 US
 UT
 UY
 UZ
 VA
 VB
 VC
 VD
 VE
 VF
 VG
 VH
 VI
 VJ
 VK
 VL
 VM
 VN
 VO
 VP
 VQ
 VR
 VS
 VT
 VU
 VV
 VW
 VX
 VY
 VZ
 WA
 WB
 WC
 WD
 WE
 WF
 WG
 WH
 WI
 WJ
 WK
 WL
 WM
 WN
 WO
 WP
 WQ
 WR
 WS
 WT
 WU
 WV
 WW
 WX
 WY
 WZ
 XA
 XB
 XC
 XD
 XE
 XF
 XG
 XH
 XI
 XJ
 XK
 XL
 XM
 XN
 XO
 XP
 XQ
 XR
 XS
 XT
 XU
 XV
 XW
 XX
 XY
 XZ
 YA
 YB
 YC
 YD
 YE
 YF
 YG
 YH
 YI
 YJ
 YK
 YL
 YM
 YN
 YO
 YP
 YQ
 YR
 YS
 YT
 YU
 YV
 YW
 YX
 YZ
 ZA
 ZB
 ZC
 ZD
 ZE
 ZF
 ZG
 ZH
 ZI
 ZJ
 ZK
 ZL
 ZM
 ZN
 ZO
 ZP
 ZQ
 ZR
 ZS
 ZT
 ZU
 ZV
 ZW
 ZX
 ZY
 ZZ

AC SCHEREN SCISSORS TIJERAS CISEAUX FORBICI

Scheren für Gefäß- und Neurochirurgie
 Scissors for Vascular and Neuro Surgery
 Tijeras para cirugía vasculares y neurocirugía
 Ciseaux pour chirurgie vasculaire et neurochirurgie
 Forbici vascolari, Forbici per neurochirurgia

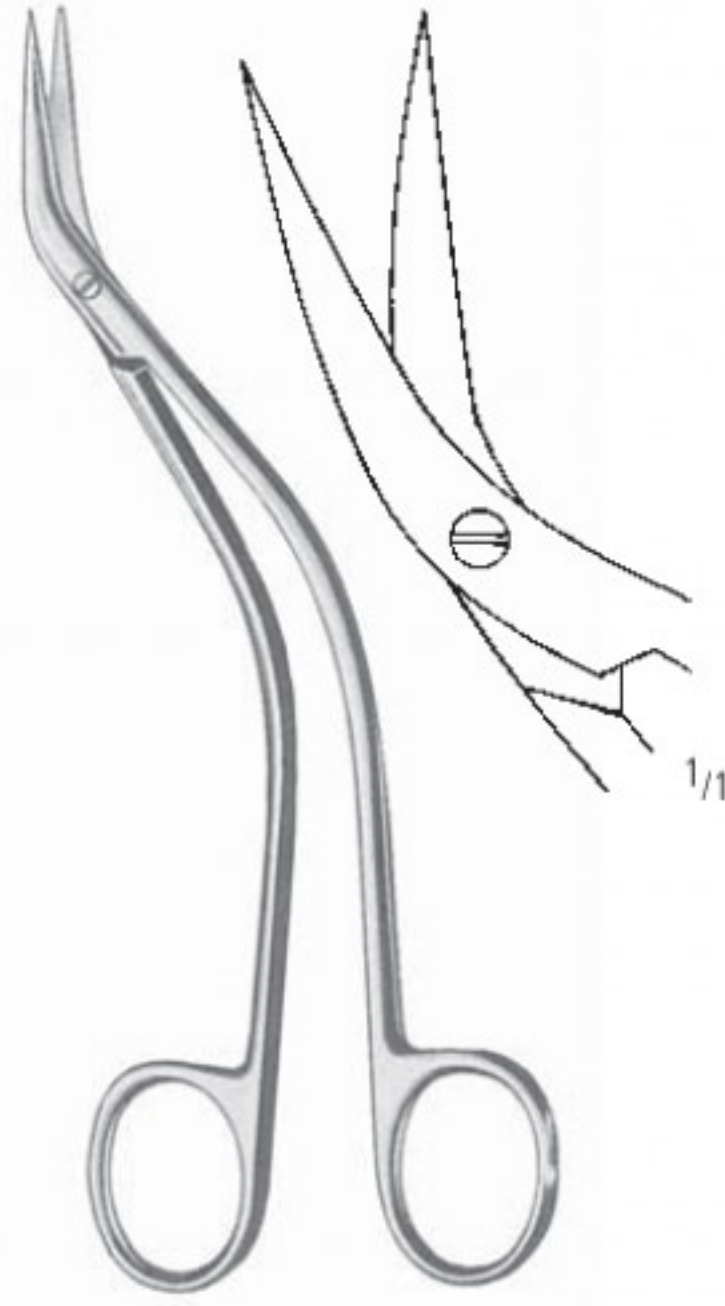
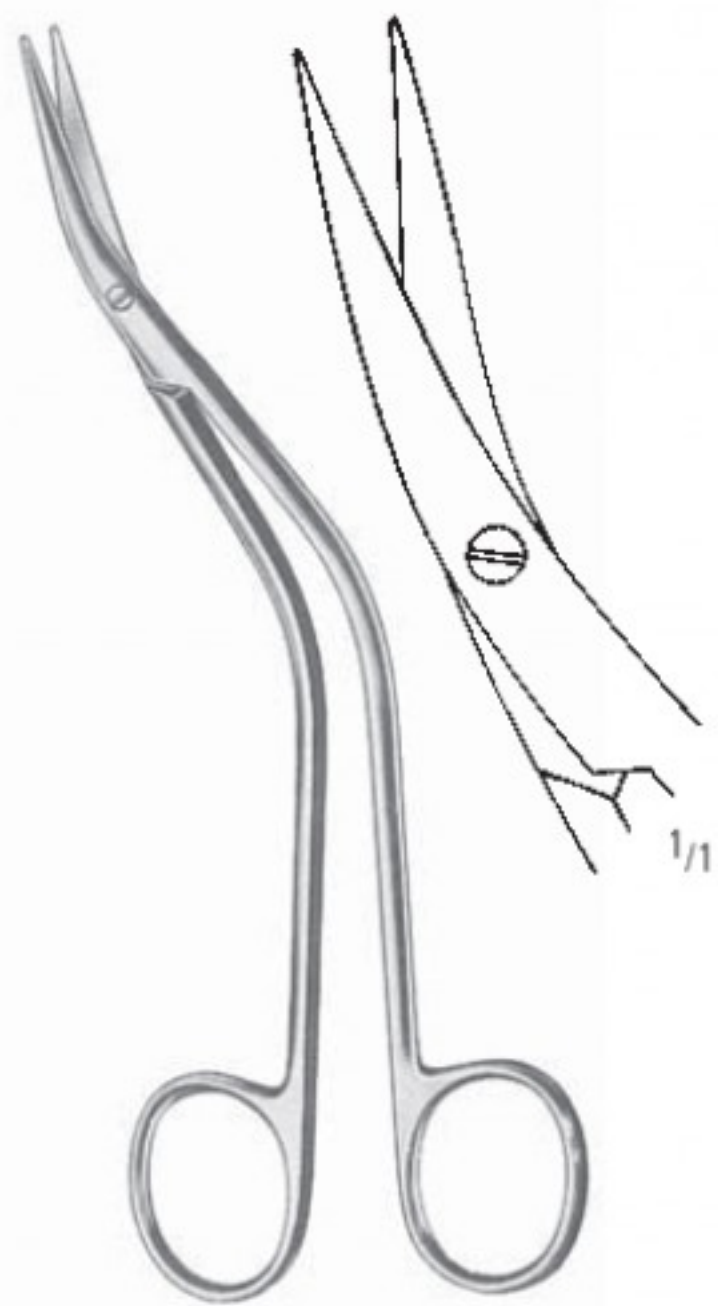

DE BAKKEY

AC 235/15
 15,5 cm/6"

AC 236/15
 15,5 cm/6"



POTTS-DE MARTEL

AC 237/21
 21,0 cm/8 1/4"

MILLS

AC 238/21
 21,0 cm/8 1/4"

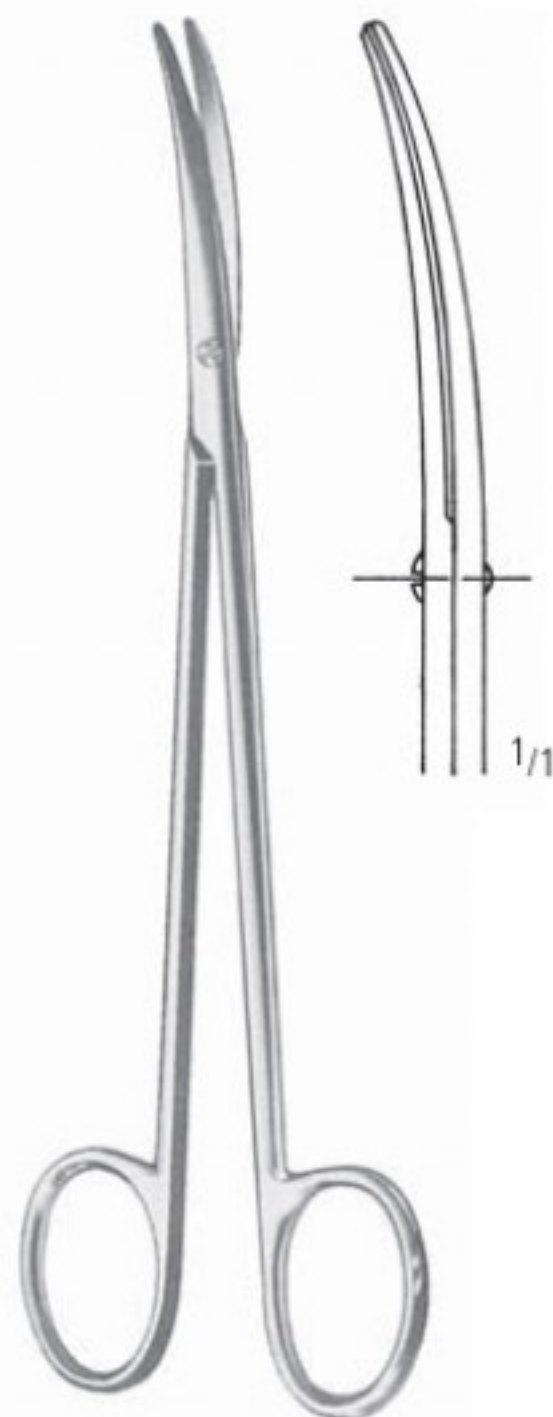

SCHMIEDEN-TAYLOR

14,5 cm/5 1/2" AC 241/15
 17,0 cm/6 3/4" AC 241/17

TOENNIS-ADSON

AC 247/17
 17,5 cm/7"

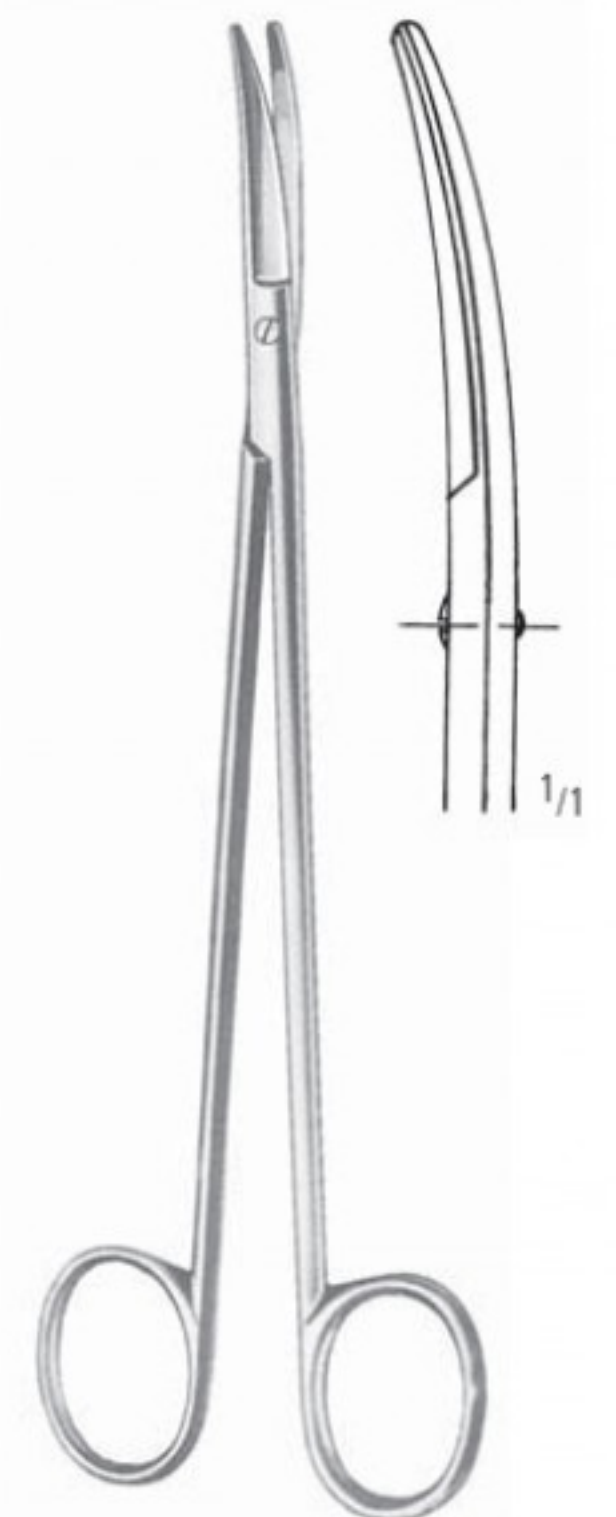
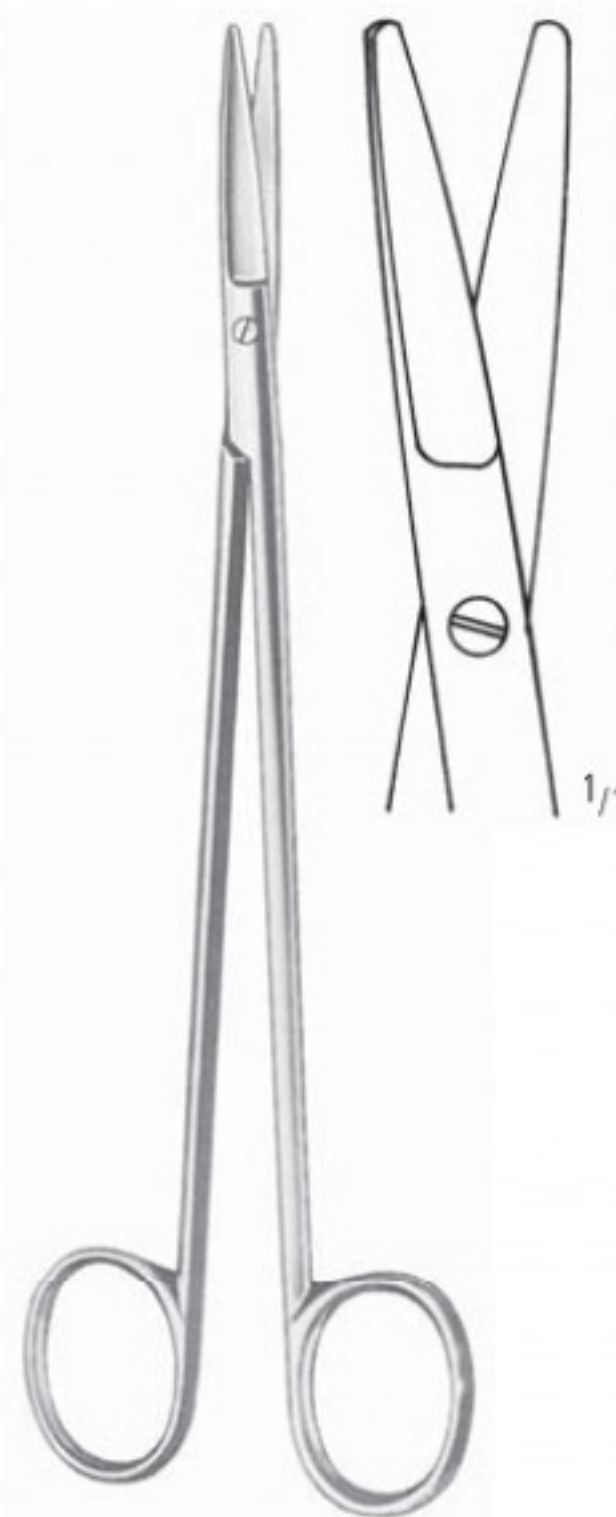

TOENNIS

AC 248/18
 18,0 cm/7"

AC 249/18
 18,0 cm/7"

SCHEREN SCISSORS TIJERAS CISEAUX FORBICI

Scheren für Gefäß- und Neurochirurgie
 Scissors for Vascular and Neuro Surgery
 Tijeras para cirugía vasculares y neurocirugía
 Ciseaux pour chirurgie vasculaire et neurochirurgie
 Forbici vascolari, Forbici per neurochirurgia

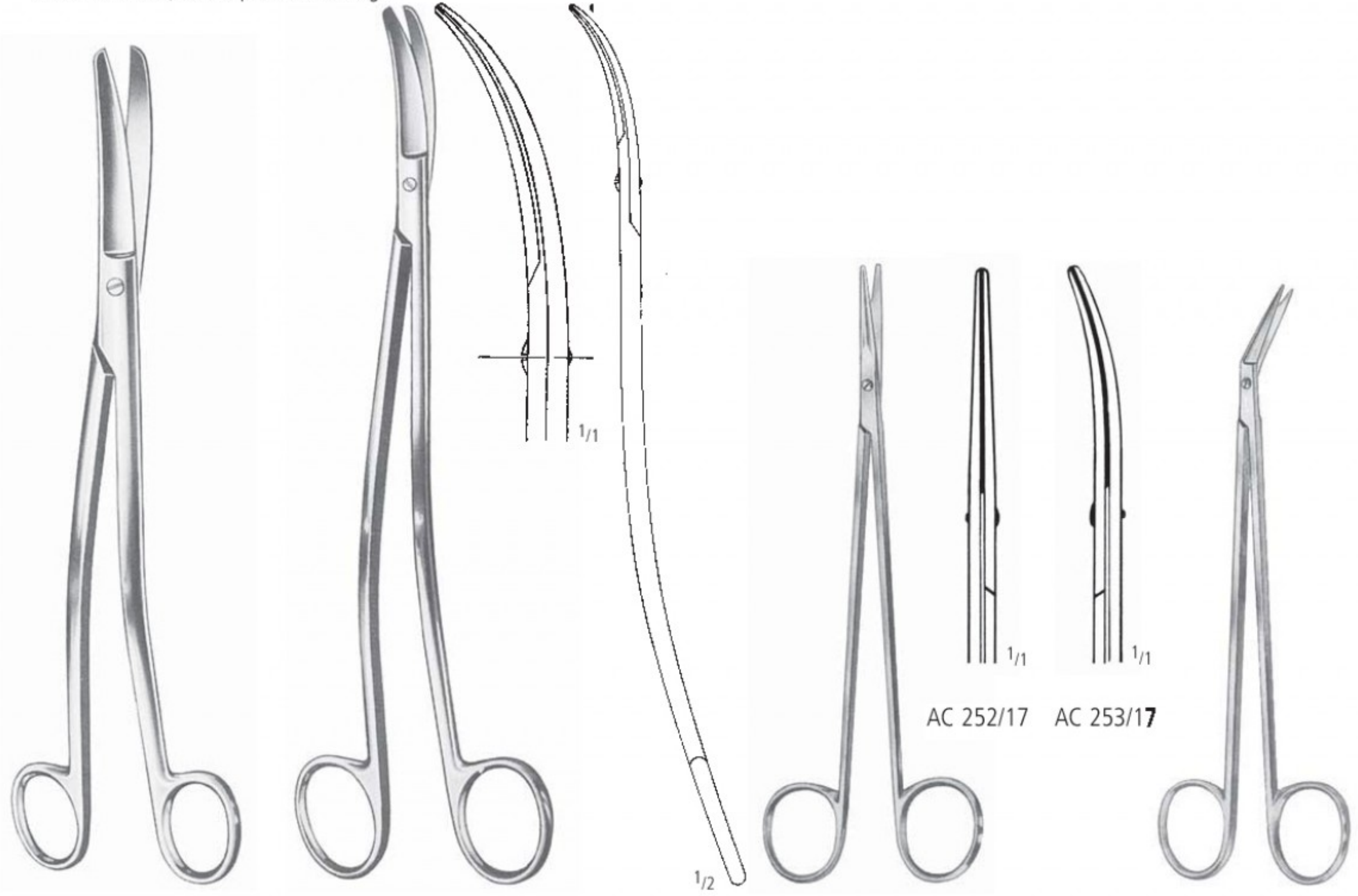

KLINKENBERGH-LOTH
 AC 250/23
 23,0 cm/9"

SATINSKY
 AC 251/24
 24,5 cm/9³/₄"

LINCOLN
 17,0 cm/6³/₄"

FULTON
 AC 255/17
 17,0 cm/6³/₄"

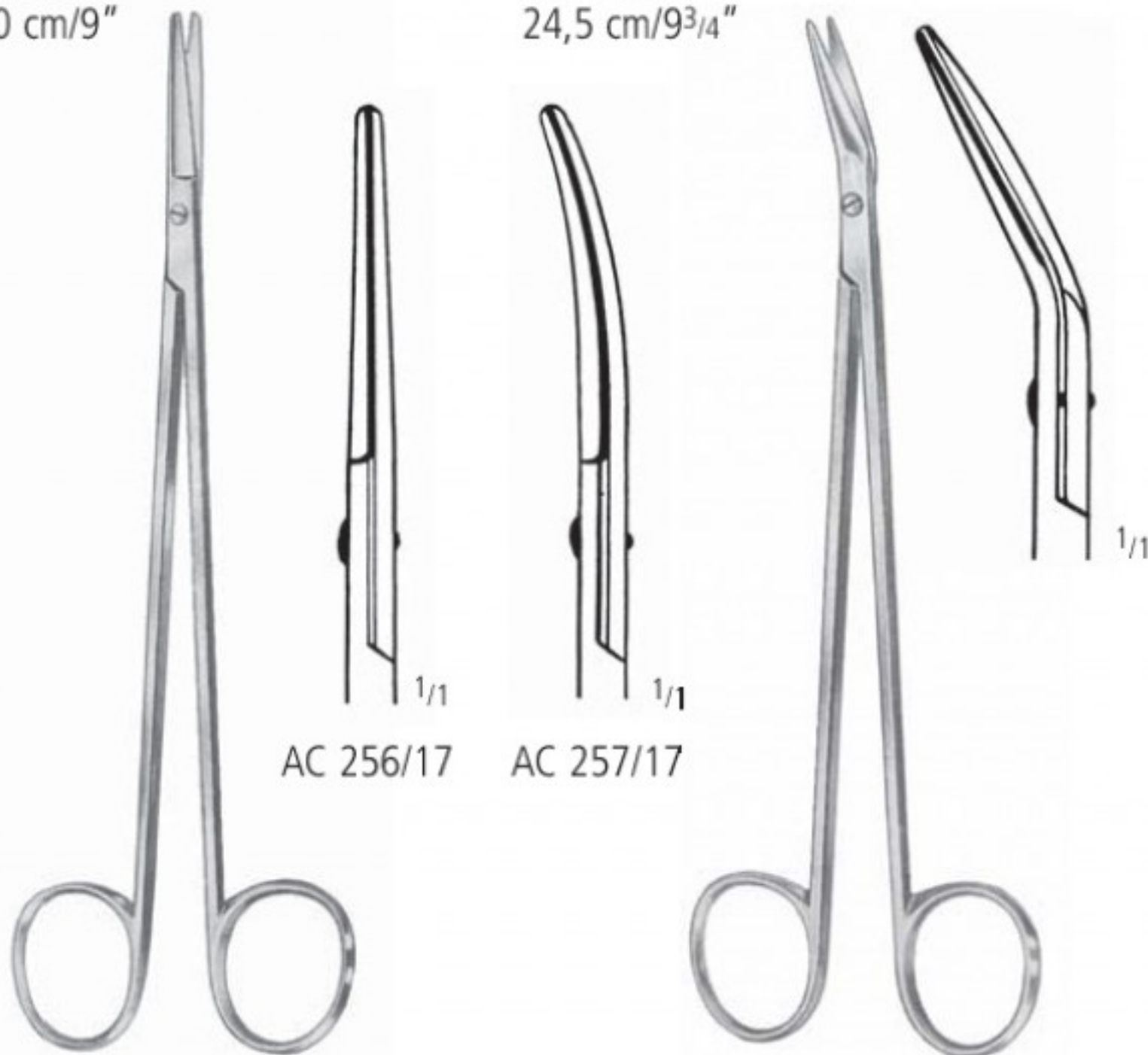

CHURCH
 17,0 cm/6³/₄"

CLASSON
 AC 258/17
 17,0 cm/6³/₄"

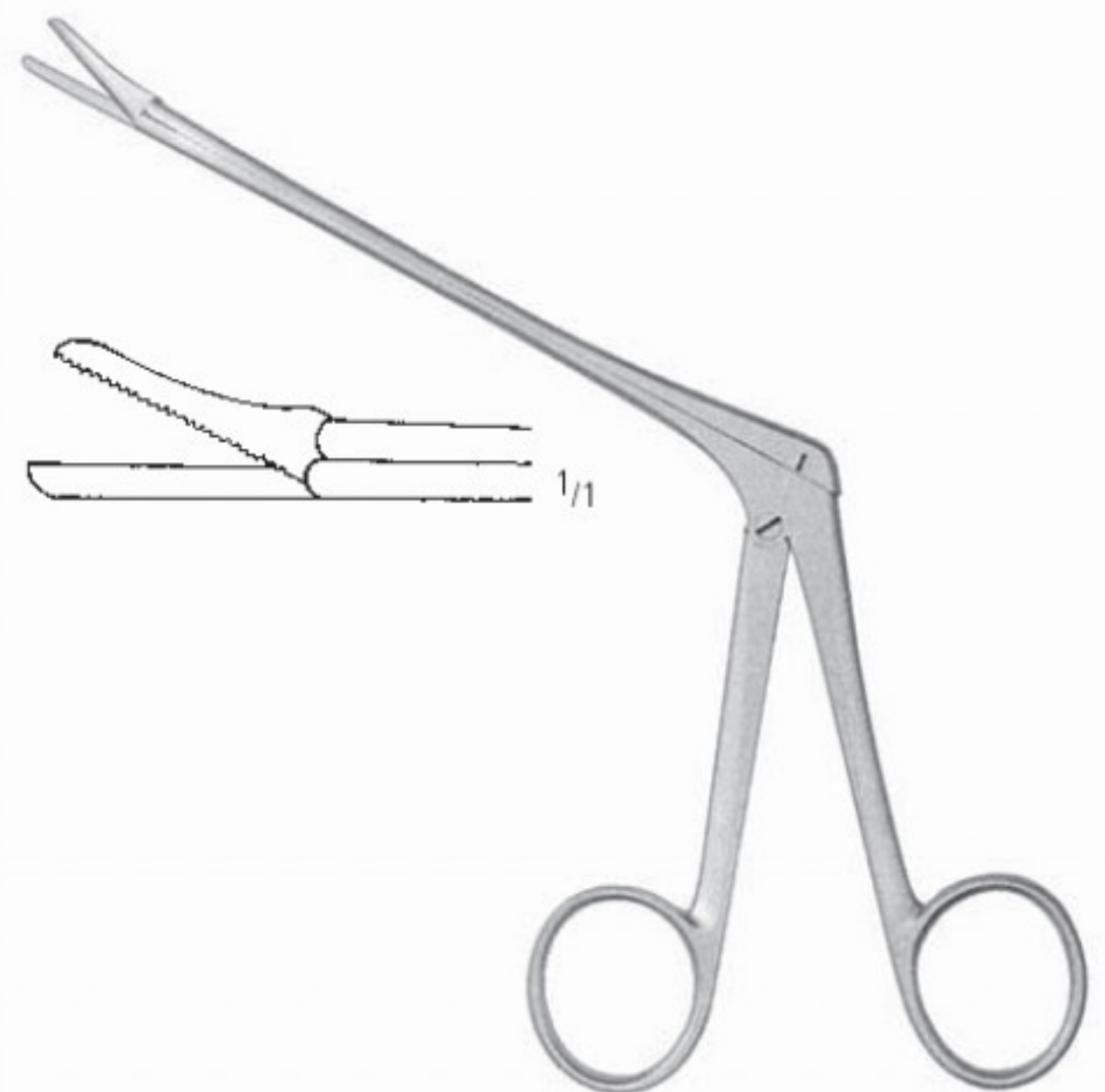

OLIVECRONA
 AC 259/23
 23,0 cm/9"

AA
 AB
 AC
 AD
 AE
 AF
 AK
 AL
 AM
 AO
 AP
 AR
 KA
 KB
 KC
 KD
 KU
 KY

AC SCHEREN SCISSORS TIJERAS CISEAUX FORBICI

Knorpel-, Lungenlappen-, Darm- und Anatomiescheren
 Cartilage-, Lobectomy-, Enterotomy- and Dissecting Scissors
 Tijeras para cartilago, lobectomia, enterótomos y disección
 Ciseaux pour le cartilage, à lobectomie, à episiotomie et à préparation
 Forbici per cartilagini, lobectomia, episiotomia e anatomia

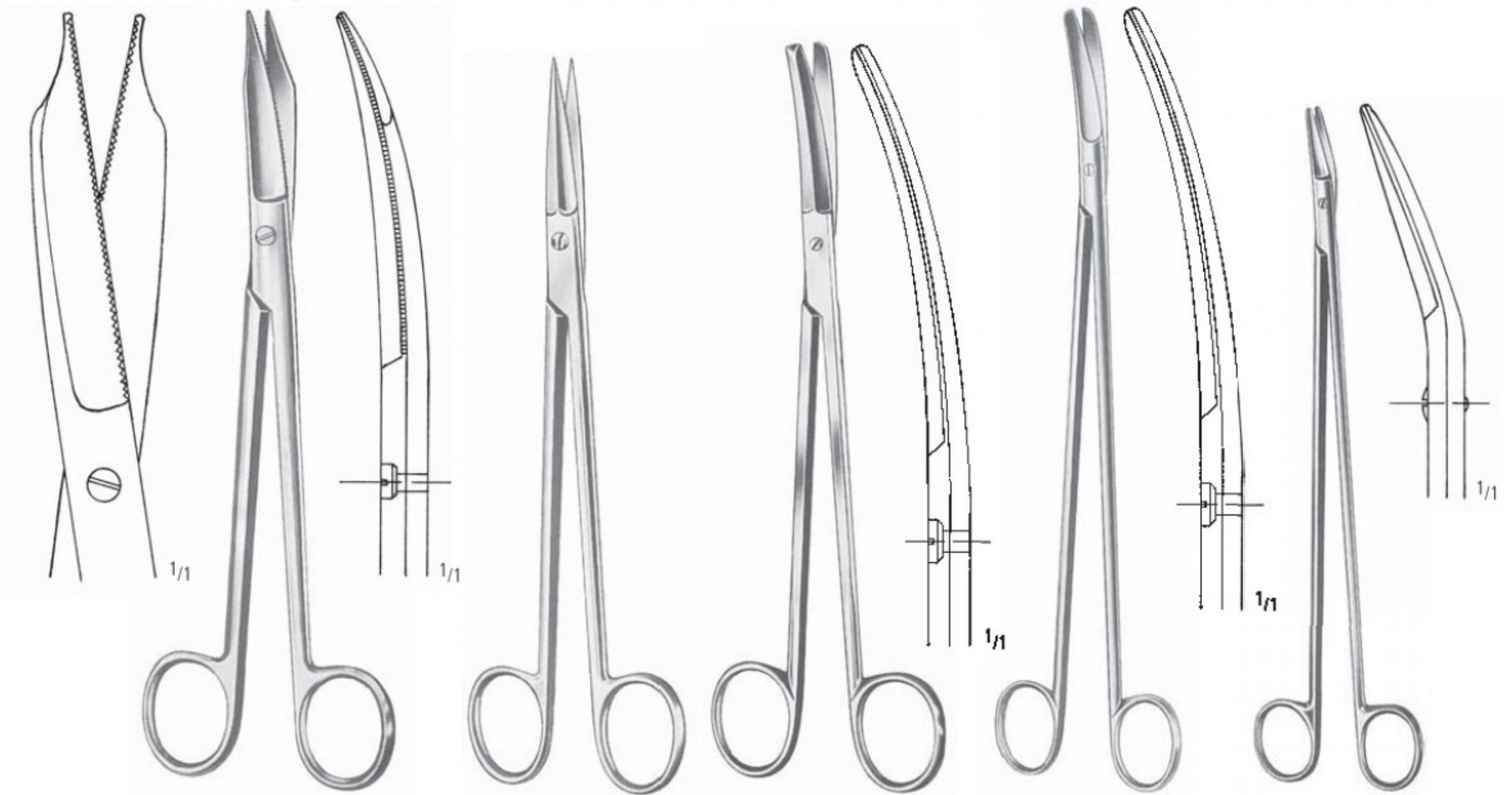

MARTIN-CARTILAGE
 AC 275/20
 20,0 cm/8"

MC INDOE
 AC 276/19
 19,0 cm/7¹/₂"

POTTS-SMITH
 AC 277/19
 19,0 cm/7¹/₂"

CRAFOORD
 AC 280/30
 30,0 cm/12"

FINOCHIETTO
 AC 281/27
 27,0 cm/10³/₄"



AC 285/21
 21,0 cm/8¹/₄"

AC 286/21
 21,0 cm/8¹/₄"

AC 287/21
 21,0 cm/8¹/₄"

AC 290/11 11,0 cm/4¹/₄"
 AC 290/13 13,0 cm/5"

AC 291/11
 AC 291/13

SCHEREN SCISSORS TIJERAS CISEAUX FORBICI

Tonsillen- und Nasenscheren, Kropfschere
 Tonsil and Nasal Scissors, Goitre Enucleation Scissors
 Tijeras para amígdalas, Tijeras nasales, Tijeras para bocio
 Ciseaux pour les amygdales, Ciseaux nasaux, Ciseaux à goitre
 Forbici per tonsille, Forbici nasali, Forbici per gozzo

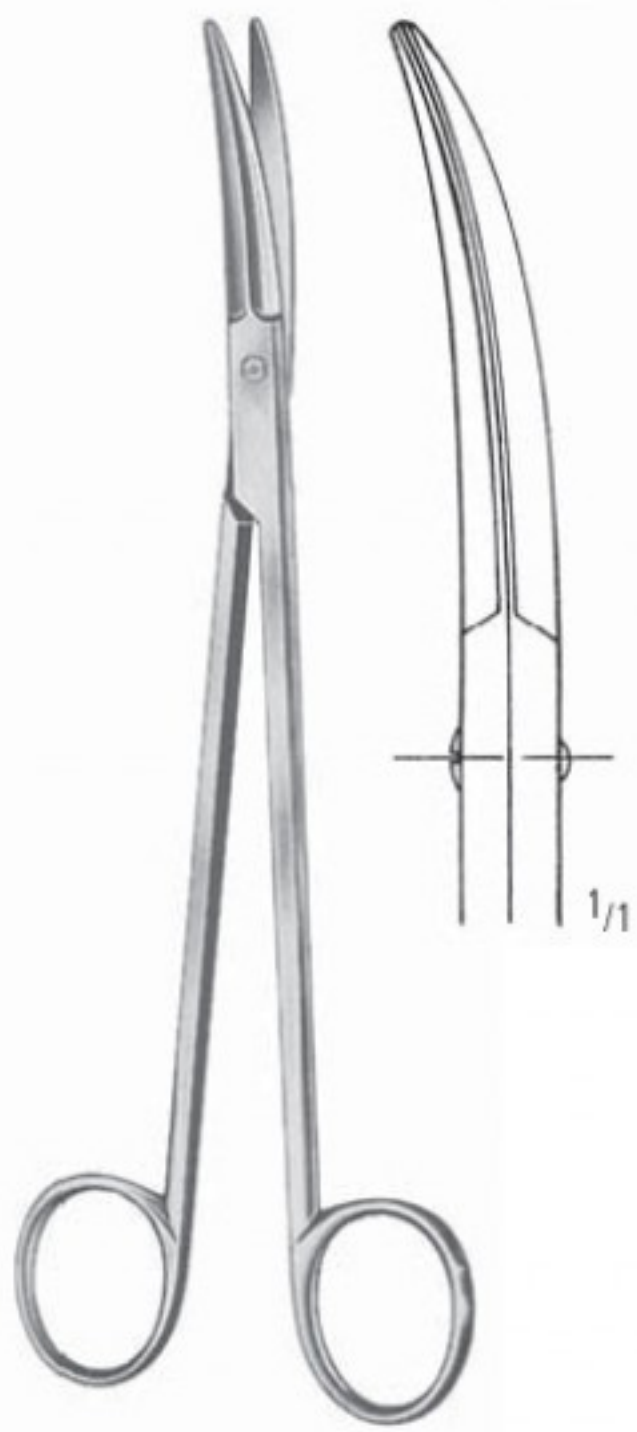

PRINCE
 AC 301/17
 17,5 cm/7"

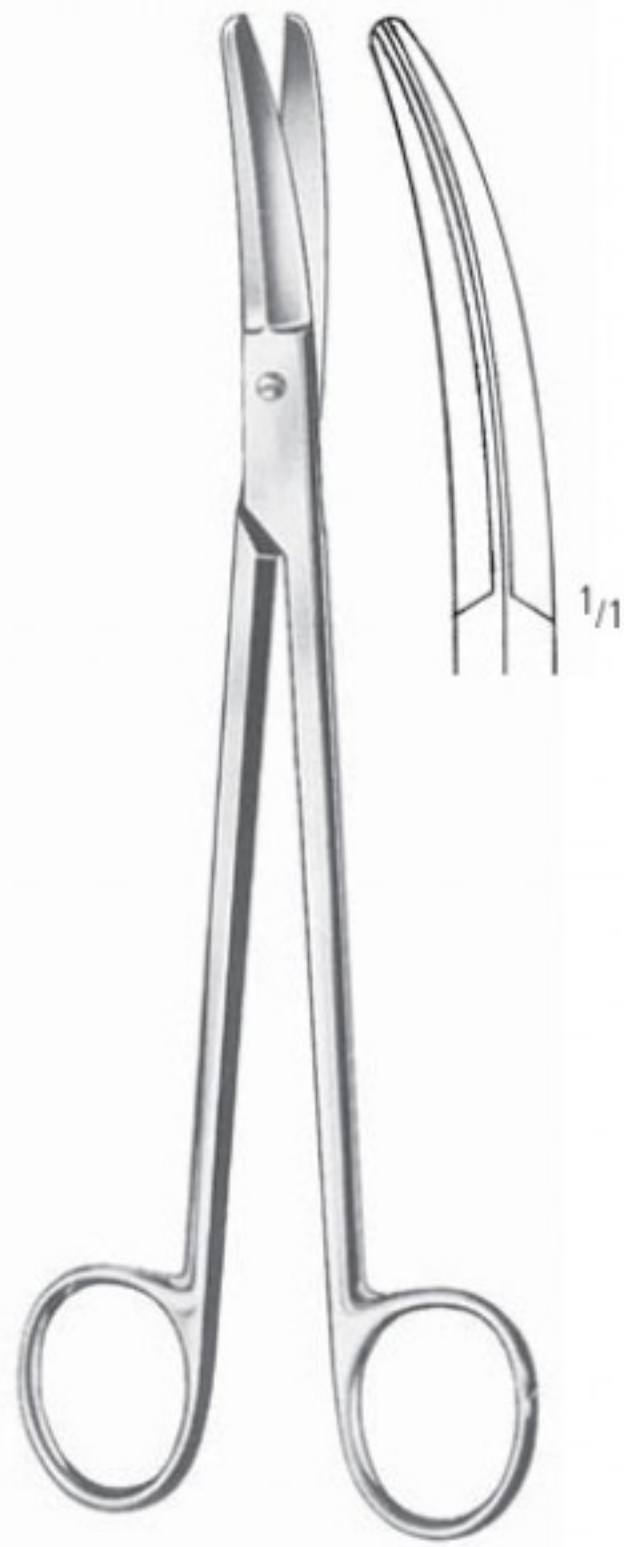

BÖTTCHER
 AC 302/18
 18,0 cm/7"



GOOD
 AC 303/19
 19,0 cm/7 1/2"



gezahnt
 saw edge
 dentadas
 dentelés
 dentata

GOOD-SCHWECKENDICK
 AC 304/19
 19,0 cm/7 1/2"



SCHOEMAKER
 AC 305/15
 15,0 cm/6"

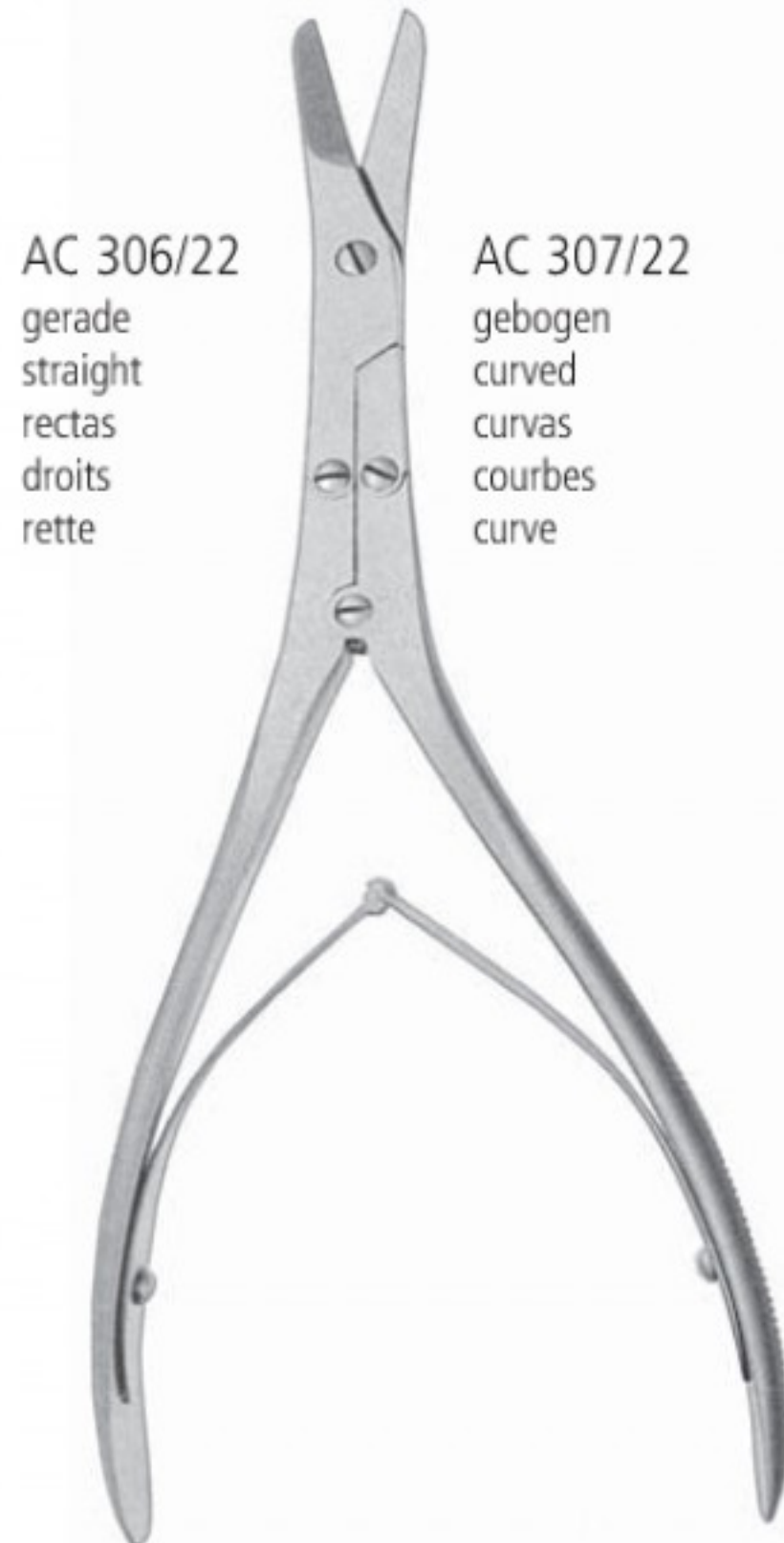

AC 306/22
 gerade
 straight
 rectas
 droits
 rette

AC 307/22
 gebogen
 curved
 curvas
 courbes
 curve

CAPLAN
 22,0 cm/9"



FOMON
 AC 309/13
 13,5 cm/5 1/4"

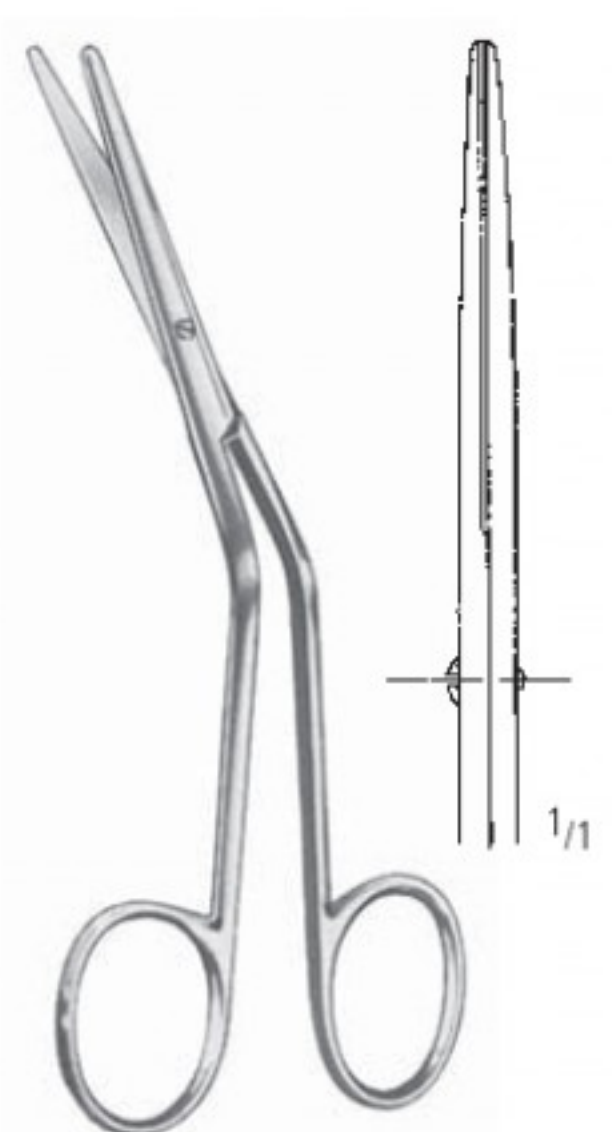

FOMON
 AC 310/13
 13,5 cm/5 1/4"

AA
 AB
 AC
 AD
 AE
 AF
 AG
 AH
 AI
 AJ
 AK
 AL
 AM
 AN
 AO
 AP
 AQ
 AR
 AS
 AT
 AU
 AV
 AW
 AX
 AY
 AZ

Nasenscheren
Nasal Scissors
Tijeras nasales
Ciseaux nasaux
Forbici nasale

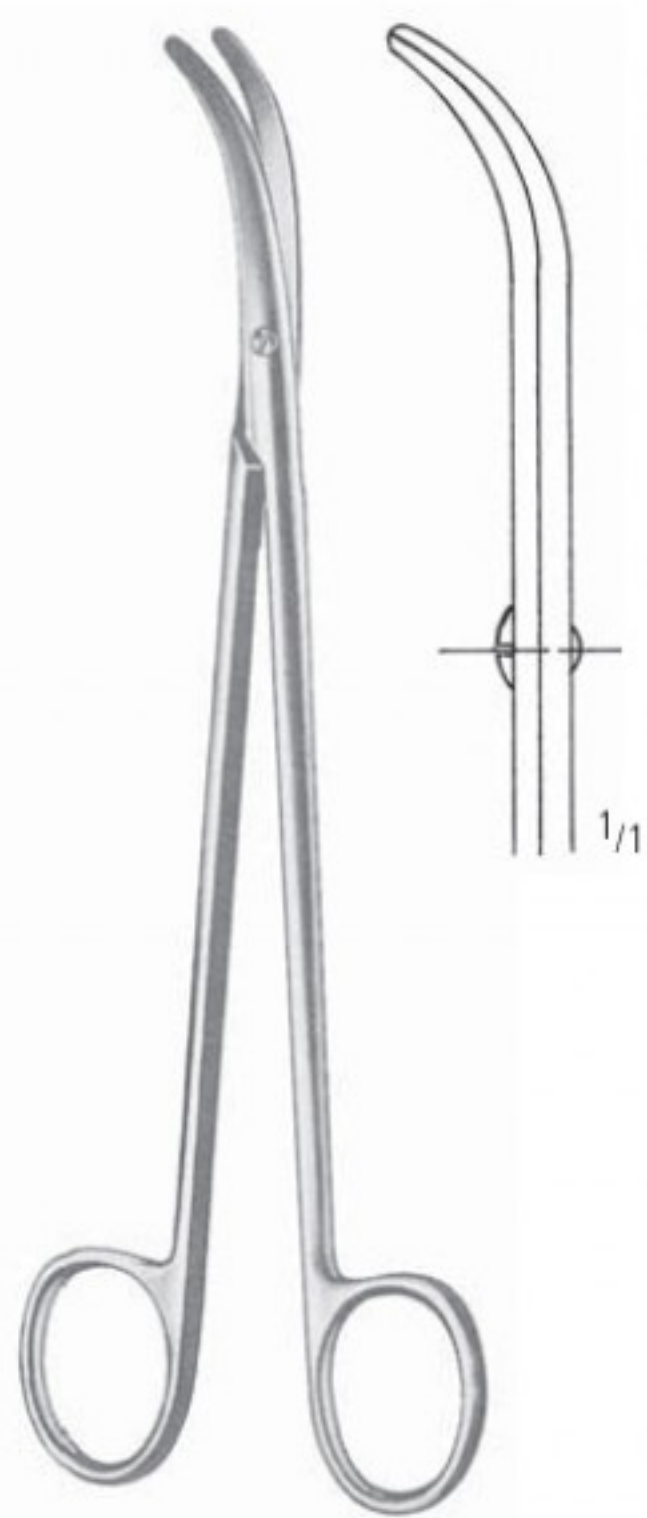

HALLE
AC 313/19
19,0 cm/7¹/₂"



COTTLE
AC 315/16
16,0 cm/6¹/₄"



HEYMANN
AC 317/18
18,0 cm/7"



HEYMANN
AC 318/19
19,5 cm/7³/₄"

SCHEREN SCISSORS TIJERAS CISEAUX FORBICI

Episiotomie- und Nabelschnurscheren
 Episiotomy and Umbilical Scissors
 Tijeras para episiotomia, Tijeras umbilicales
 Ciseaux à épisiotomie et pour le cordon ombilical
 Forbici per episiotomia, Forbici ombelicale

AA
AB
AC
AD
AE
AF
AK
AL
AM
AO
AP
AR
KA
KB
KC
KD
KU
KY

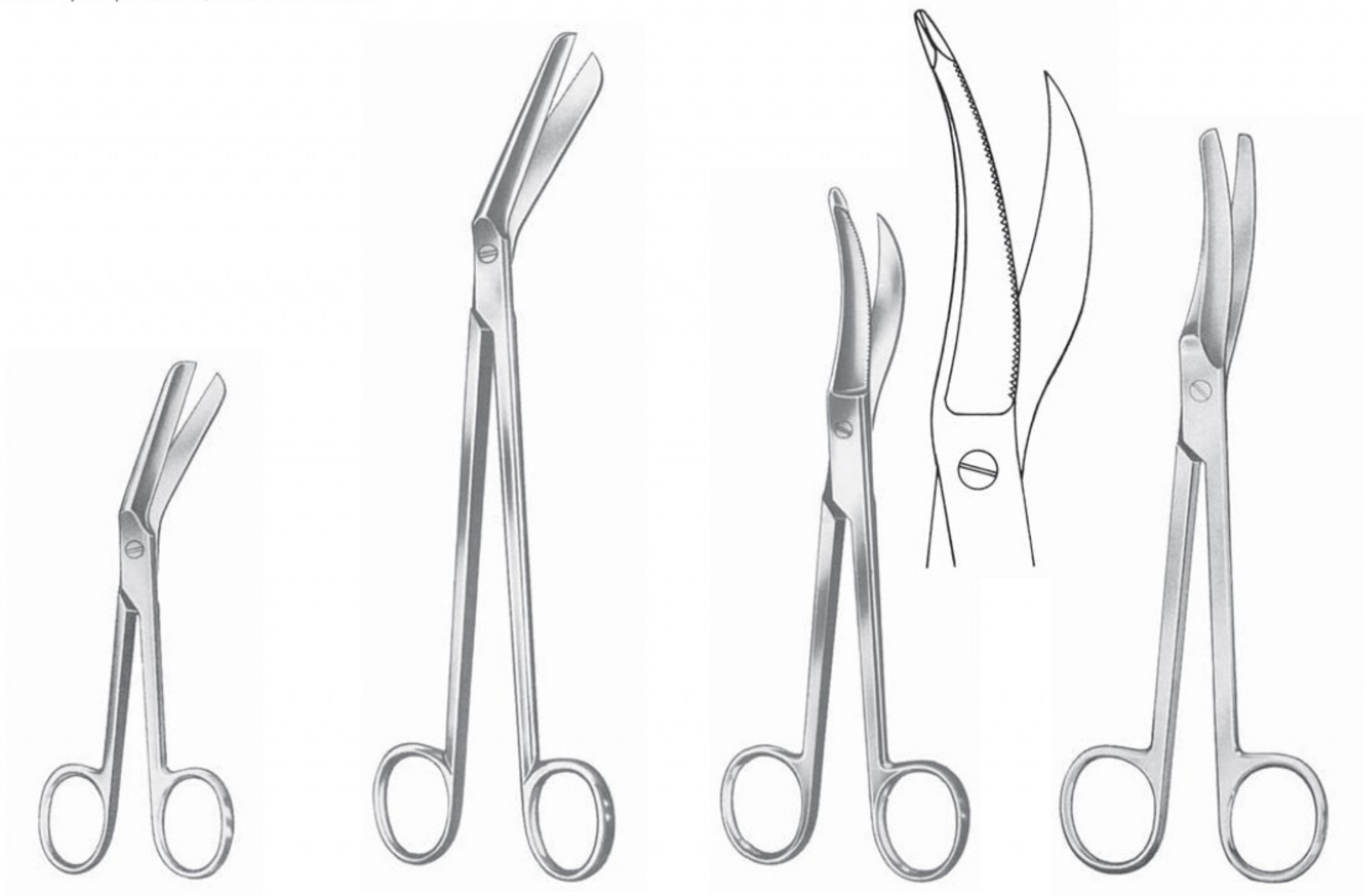

BRAUN-STADLER
 AC 351/14
 14,0 cm/5¹/₂"

BRAUN-STADLER
 20,0 cm/8" AC 351/20
 22,0 cm/8³/₄" AC 351/22

WALDMANN
 AC 353/18
 18,0 cm/7"

AC 354/20
 20,0 cm/8"



MOD. USA
 AC 360/10
 10,5 cm/4¹/₄"

SCHUMACHER
 AC 362/16
 16,0 cm/6¹/₄"

BUSCH
 13,0 cm/5" AC 365/13
 16,0 cm/6¹/₄" AC 365/16

Feine chirurgische Scheren
 Fine Operating Scissors
 Tijeras finas para cirugía
 Ciseaux fins à chirurgie
 Forbici fini per chirurgia



WAGNER
 12,0 cm/4³/₄"

gerade
 straight
 rectas
 droits
 rette



Fig. 1
 AC 404/01



Fig. 2
 AC 404/02



Fig. 3
 AC 404/03

gebogen
 curved
 curvas
 courbes
 curve



Fig. 1
 AC 405/01



Fig. 2
 AC 405/02



Fig. 3
 AC 405/03



AC 408/11
 11,0 cm/4¹/₃"



AC 409/11
 11,0 cm/4¹/₃"

SCHEREN SCISSORS TIJERAS CISEAUX FORBICI

Feine Scheren
 Fine Scissors
 Tijeras finas
 Ciseaux fins
 Forbici fini

AA
 AB
 AC
 AD
 AE
 AF
 AG
 AH
 AI
 AJ
 AK
 AL
 AM
 AN
 AO
 AP
 AQ
 AR
 AS
 AT
 AU
 AV
 AW
 AX
 AY
 AZ

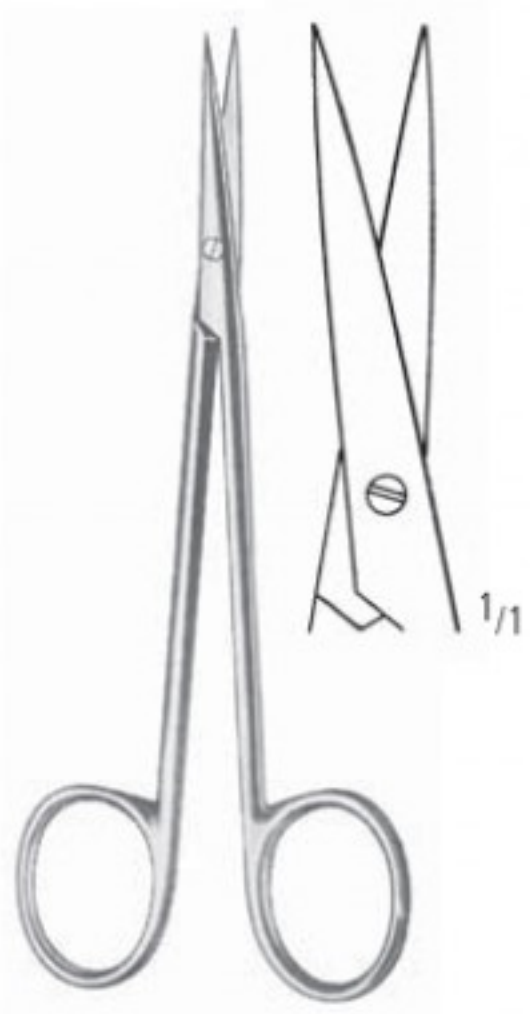

AC 410/11
 11,5 cm/4 1/2"

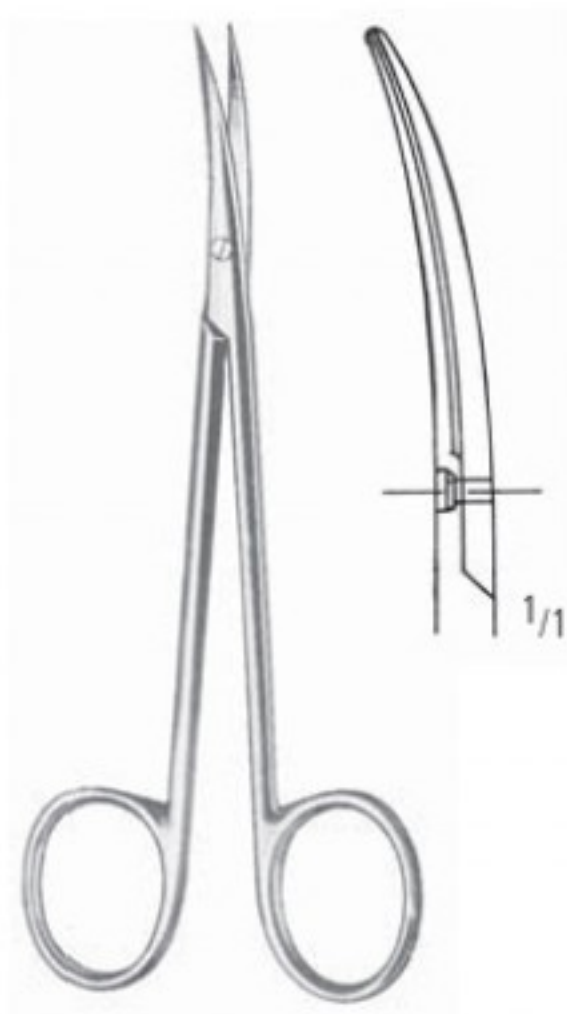

AC 411/11
 11,5 cm/4 1/2"

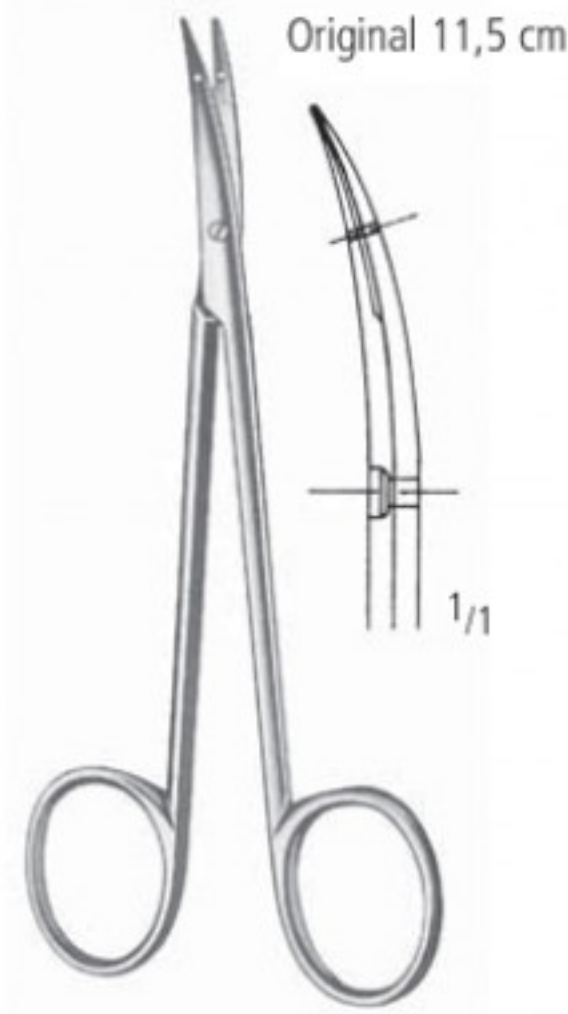

LITTLER
 AC 412/11 11,5 cm/4 1/2"
 AC 412/14 14,0 cm/5 1/2"

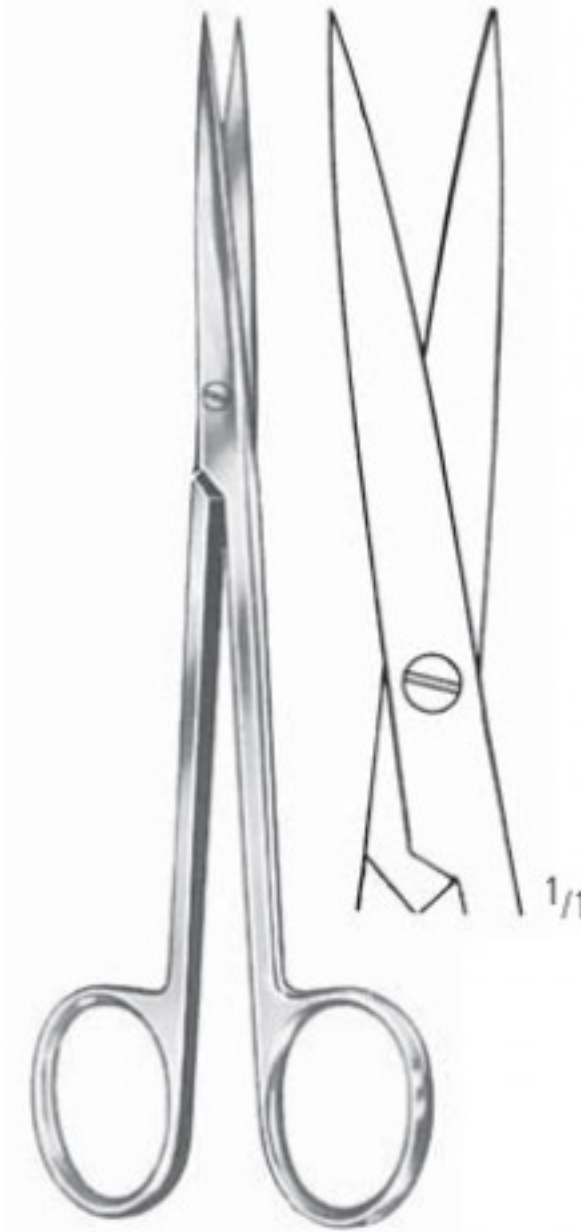

BROPHY (SULLIVAN)
 AC 414/14
 14,5 cm/5 3/4"

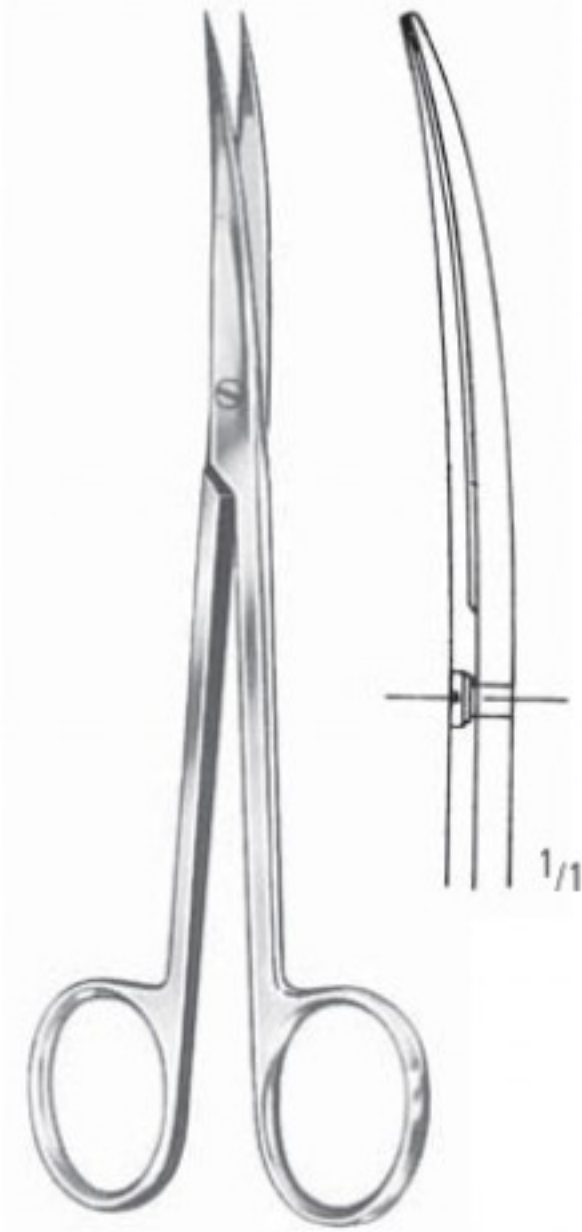

AC 415/14
 14,5 cm/5 3/4"

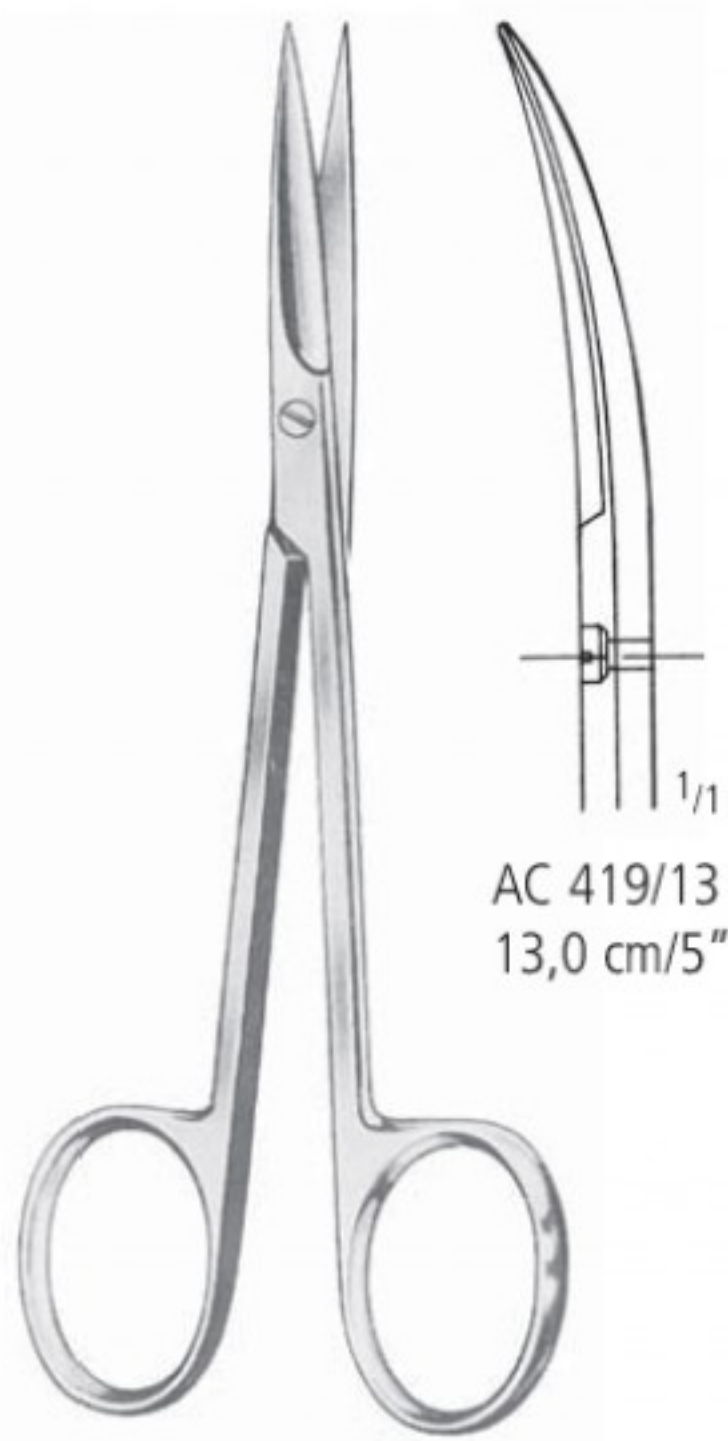

AC 418/13
 13,0 cm/5"

AC 419/13
 13,0 cm/5"



AC 422/10
 AC 422/11

10,5 cm/4 1/4"
 11,5 cm/4 1/2"



AC 423/10
 AC 423/11



AC 424/11
 11,5 cm/4 1/2"

AC SCHEREN SCISSORS TIJERAS CISEAUX FORBICI

Feine Scheren
 Fine Scissors
 Tijeras finas
 Ciseaux fins
 Forbici fini

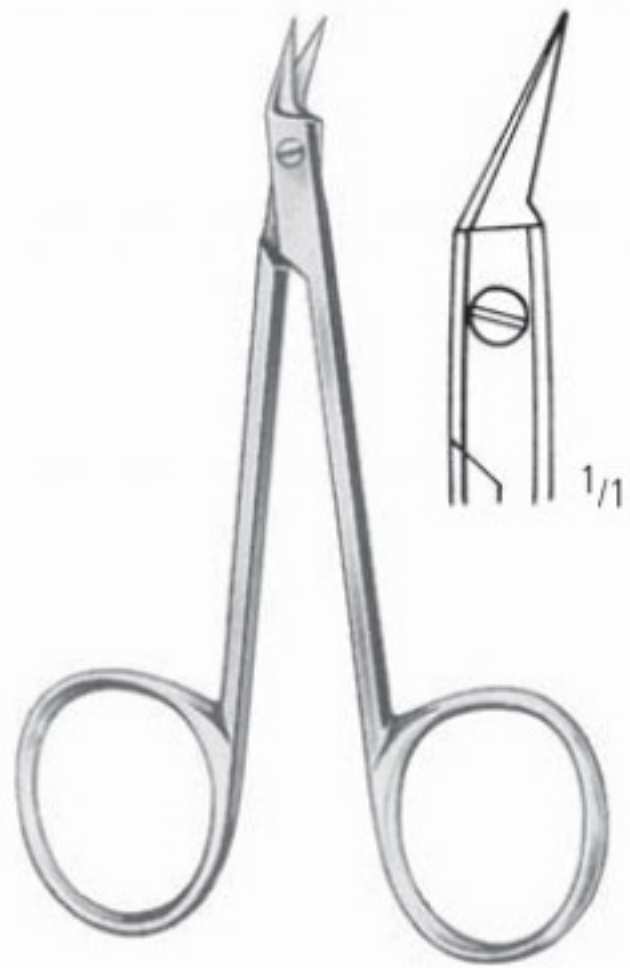

O'BRIEN
 AC 427/09
 9,0 cm/3 1/2"



WALTON
 AC 429/10
 10,0 cm/4"

sehr fein
 extra delicate
 muy finas
 très fin
 molto sottile



MOD. BONN
 AC 430/08
 8,0 cm/3"

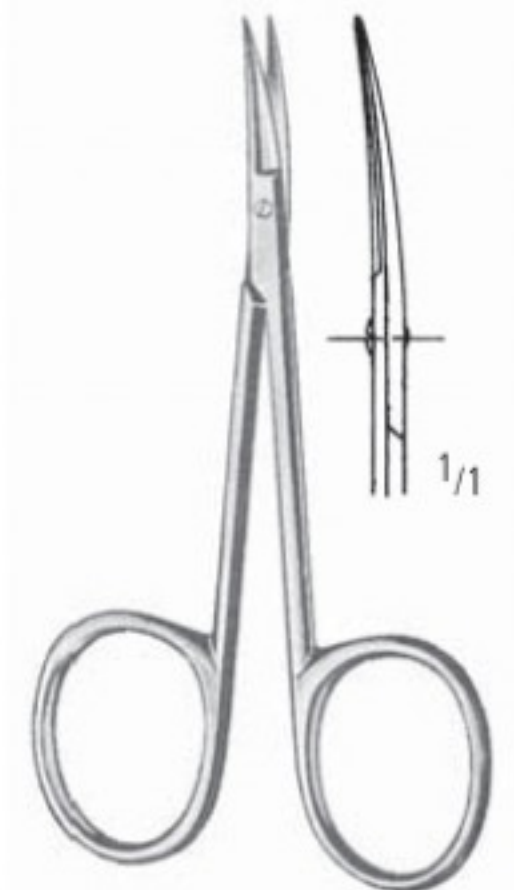

AC 431/08
 8,0 cm/3"

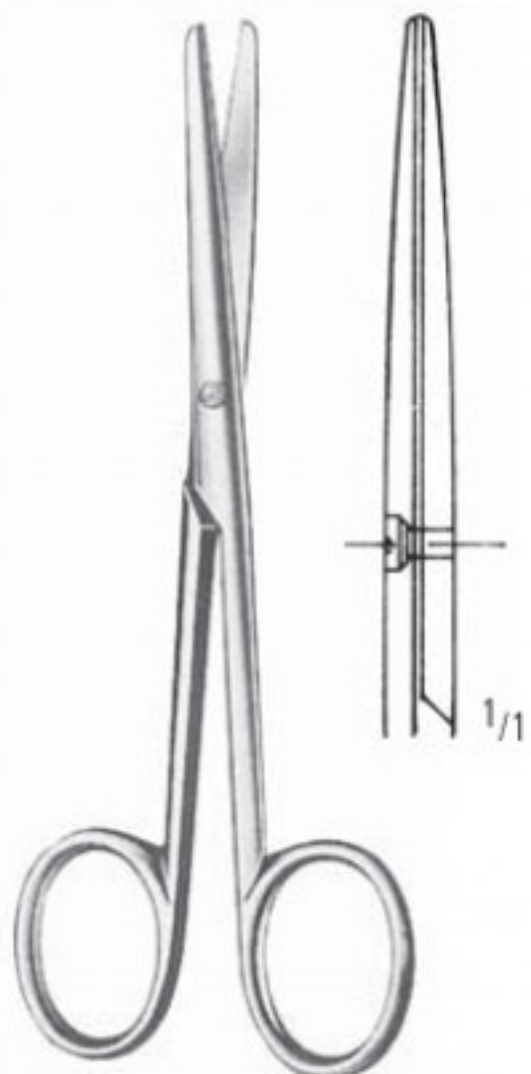

LANDOLT
 AC 434/12
 12,5 cm/5"

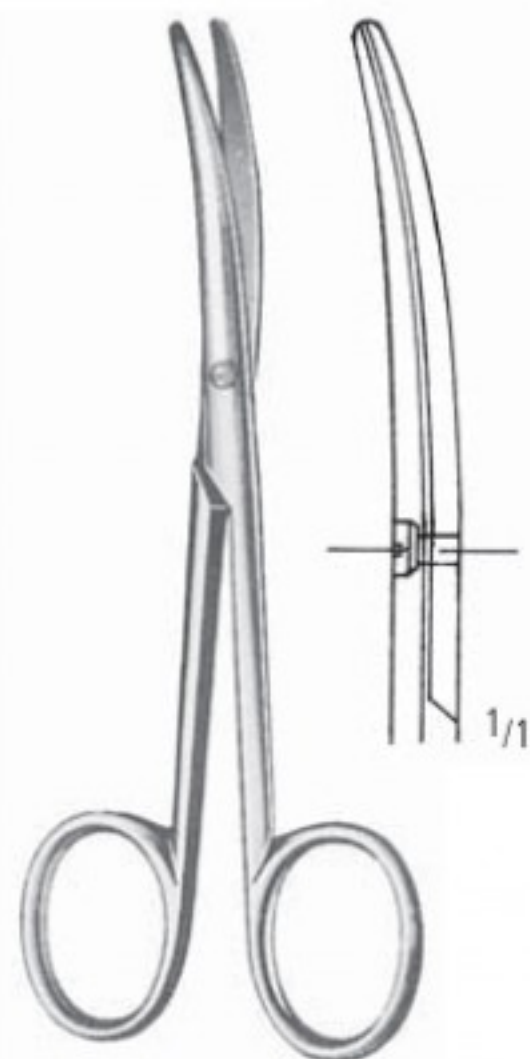

LANDOLT
 AC 435/12
 12,5 cm/5"

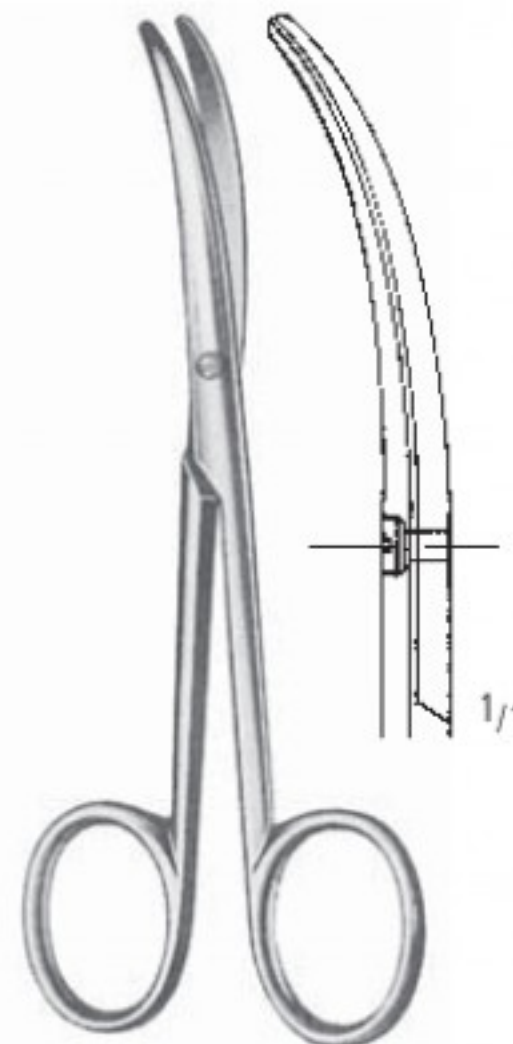

LANDOLT
 AC 436/12
 12,5 cm/5"

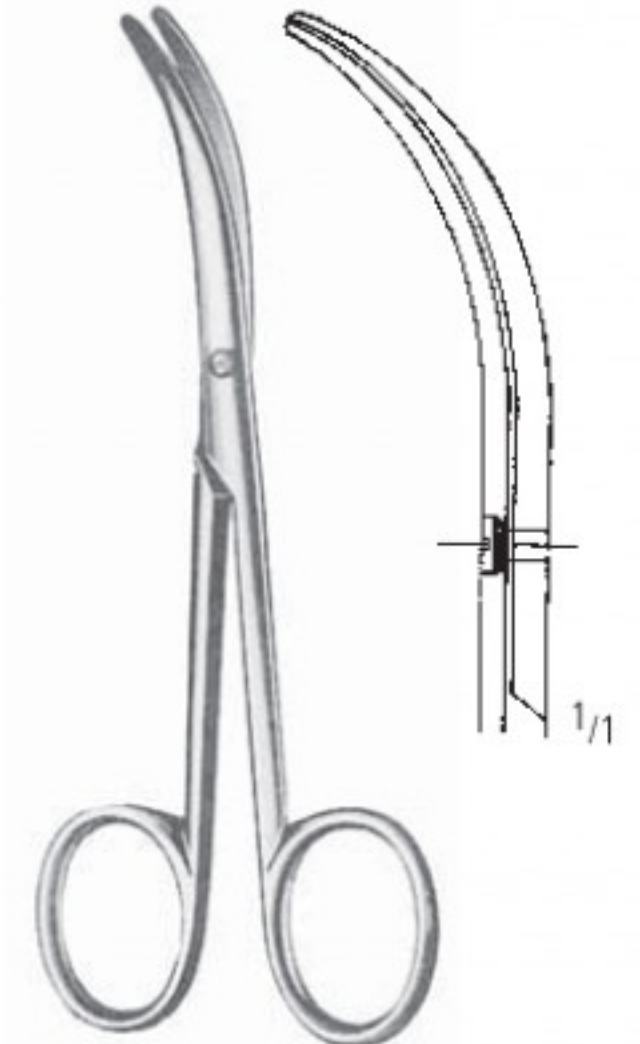

LANDOLT
 AC 437/12
 12,5 cm/5"

SCHEREN SCISSORS TIJERAS CISEAUX FORBICI

Augenscheren
Eye Scissors
Tijeras oculares
Ciseaux oculaires
Forbici oftalmologici



11,5 cm/4 1/2"

Fig. 1

gerade
straight
rectas
droits
rette

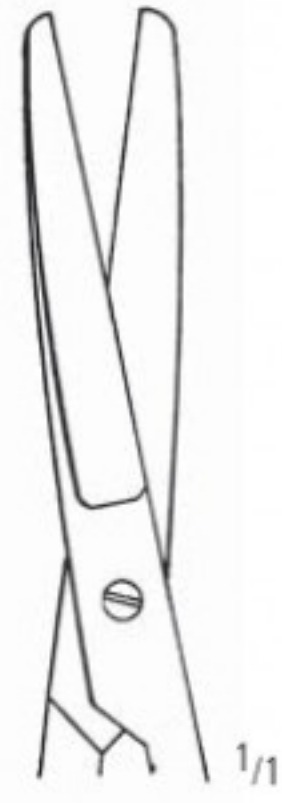

AC 446/01

Fig. 2



AC 446/02

Fig. 1

gebogen
curved
curvas
courbes
curve



AC 447/01

Fig. 2



AC 447/02



AC 448/11
11,5 cm/4 1/2"



AC 449/11
11,5 cm/4 1/2"

Irisscheren
Iris Scissors
Tijeras para iridectomía
Ciseaux à iridectomie
Forbici per iridectomia



Original 10,5 cm



Original 10,5 cm

9,0 cm/3 1/2"	AC 450/09	AC 451/09
10,5 cm/4 1/4"	AC 450/10	AC 451/10
11,5 cm/4 1/2"	AC 450/11*	AC 451/11*

AA
AB
AC
AD
AE
AF
AG
AH
AI
AJ
AK
AL
AM
AN
AO
AP
AQ
AR
AS
AT
AU
AV
AW
AX
AY
AZ
BA
BB
BC
BD
BE
BF
BG
BH
BI
BJ
BK
BL
BM
BN
BO
BP
BQ
BR
BS
BT
BU
BV
BW
BX
BY
BZ
CA
CB
CC
CD
CE
CF
CG
CH
CI
CJ
CK
CL
CM
CN
CO
CP
CQ
CR
CS
CT
CU
CV
CW
CX
CY
CZ
DA
DB
DC
DD
DE
DF
DG
DH
DI
DJ
DK
DL
DM
DN
DO
DP
DQ
DR
DS
DT
DU
DV
DW
DX
DY
DZ
EA
EB
EC
ED
EE
EF
EG
EH
EI
EJ
EK
EL
EM
EN
EO
EP
EQ
ER
ES
ET
EU
EV
EW
EX
EY
EZ
FA
FB
FC
FD
FE
FF
FG
FH
FI
FJ
FK
FL
FM
FN
FO
FP
FQ
FR
FS
FT
FU
FV
FW
FX
FY
FZ
GA
GB
GC
GD
GE
GF
GG
GH
GI
GJ
GK
GL
GM
GN
GO
GP
GQ
GR
GS
GT
GU
GV
GW
GX
GY
GZ
HA
HB
HC
HD
HE
HF
HG
HH
HI
HJ
HK
HL
HM
HN
HO
HP
HQ
HR
HS
HT
HU
HV
HW
HX
HY
HZ
IA
IB
IC
ID
IE
IF
IG
IH
II
IJ
IK
IL
IM
IN
IO
IP
IQ
IR
IS
IT
IU
IV
IW
IX
IY
IZ
JA
JB
JC
JD
JE
JF
JG
JH
JI
JJ
JK
JL
JM
JN
JO
JP
JQ
JR
JS
JT
JU
JV
JW
JX
JY
JZ
KA
KB
KC
KD
KE
KF
KG
KH
KI
KJ
KK
KL
KM
KN
KO
KP
KQ
KR
KS
KT
KU
KV
KW
KX
KY
KZ
LA
LB
LC
LD
LE
LF
LG
LH
LI
LJ
LK
LL
LM
LN
LO
LP
LQ
LR
LS
LT
LU
LV
LW
LX
LY
LZ
MA
MB
MC
MD
ME
MF
MG
MH
MI
MJ
MK
ML
MM
MN
MO
MP
MQ
MR
MS
MT
MU
MV
MW
MX
MY
MZ
NA
NB
NC
ND
NE
NF
NG
NH
NI
NJ
NK
NL
NM
NN
NO
NP
NQ
NR
NS
NT
NU
NV
NW
NX
NY
NZ
OA
OB
OC
OD
OE
OF
OG
OH
OI
OJ
OK
OL
OM
ON
OO
OP
OQ
OR
OS
OT
OU
OV
OW
OX
OY
OZ
PA
PB
PC
PD
PE
PF
PG
PH
PI
PJ
PK
PL
PM
PN
PO
PP
PQ
PR
PS
PT
PU
PV
PW
PX
PY
PZ
QA
QB
QC
QD
QE
QF
QG
QH
QI
QJ
QK
QL
QM
QN
QO
QP
QQ
QR
QS
QT
QU
QV
QW
QX
QY
QZ
RA
RB
RC
RD
RE
RF
RG
RH
RI
RJ
RK
RL
RM
RN
RO
RP
RQ
RR
RS
RT
RU
RV
RW
RX
RY
RZ
SA
SB
SC
SD
SE
SF
SG
SH
SI
SJ
SK
SL
SM
SN
SO
SP
SQ
SR
SS
ST
SU
SV
SW
SX
SY
SZ
TA
TB
TC
TD
TE
TF
TG
TH
TI
TJ
TK
TL
TM
TN
TO
TP
TQ
TR
TS
TT
TU
TV
TW
TX
TY
TZ
UA
UB
UC
UD
UE
UF
UG
UH
UI
UJ
UK
UL
UM
UN
UO
UP
UQ
UR
US
UT
UU
UV
UW
UX
UY
UZ
VA
VB
VC
VD
VE
VF
VG
VH
VI
VJ
VK
VL
VM
VN
VO
VP
VQ
VR
VS
VT
VU
VV
VW
VX
VY
VZ
WA
WB
WC
WD
WE
WF
WG
WH
WI
WJ
WK
WL
WM
WN
WO
WP
WQ
WR
WS
WT
WU
WV
WW
WX
WY
WZ
XA
XB
XC
XD
XE
XF
XG
XH
XI
XJ
XK
XL
XM
XN
XO
XP
XQ
XR
XS
XT
XU
XV
XW
XX
XY
XZ
YA
YB
YC
YD
YE
YF
YG
YH
YI
YJ
YK
YL
YM
YN
YO
YP
YQ
YR
YS
YT
YU
YV
YW
YX
YY
YZ
ZA
ZB
ZC
ZD
ZE
ZF
ZG
ZH
ZI
ZJ
ZK
ZL
ZM
ZN
ZO
ZP
ZQ
ZR
ZS
ZT
ZU
ZV
ZW
ZX
ZY
ZZ

AC SCHEREN SCISSORS TIJERAS CISEAUX FORBICI

Augenscheren
Eye Scissors
Tijeras oculares
Ciseaux oculaires
Forbici oftalmologici

mit großen Ringen
with large bows
con anillos grandes
avec grands anneaux
con anelli grandi

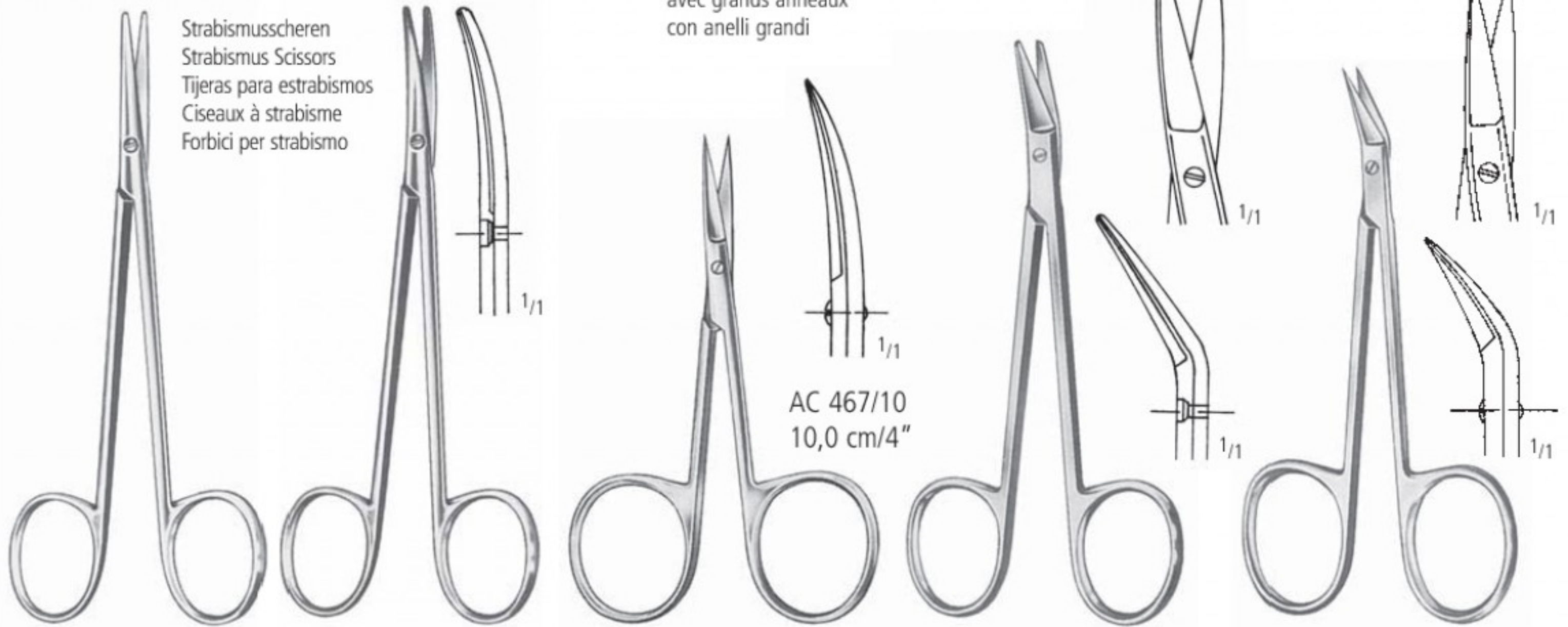

Strabimusscheren
Strabismus Scissors
Tijeras para estrabismos
Ciseaux à strabisme
Forbici per strabismo

AC 460/11*
11,5 cm/4¹/₂"

AC 461/11*
11,5 cm/4¹/₂"

AC 466/10
10,0 cm/4"

GRAEFE
AC 469/10
10,5 cm/4¹/₄"

WILMER
AC 471/10
10,0 cm/4"



Sehnenscheren
Tenotomy Scissors
Tijeras para tenotomía
Ciseaux à ténatomie
Forbici per tenotomia

Original 11,5 cm

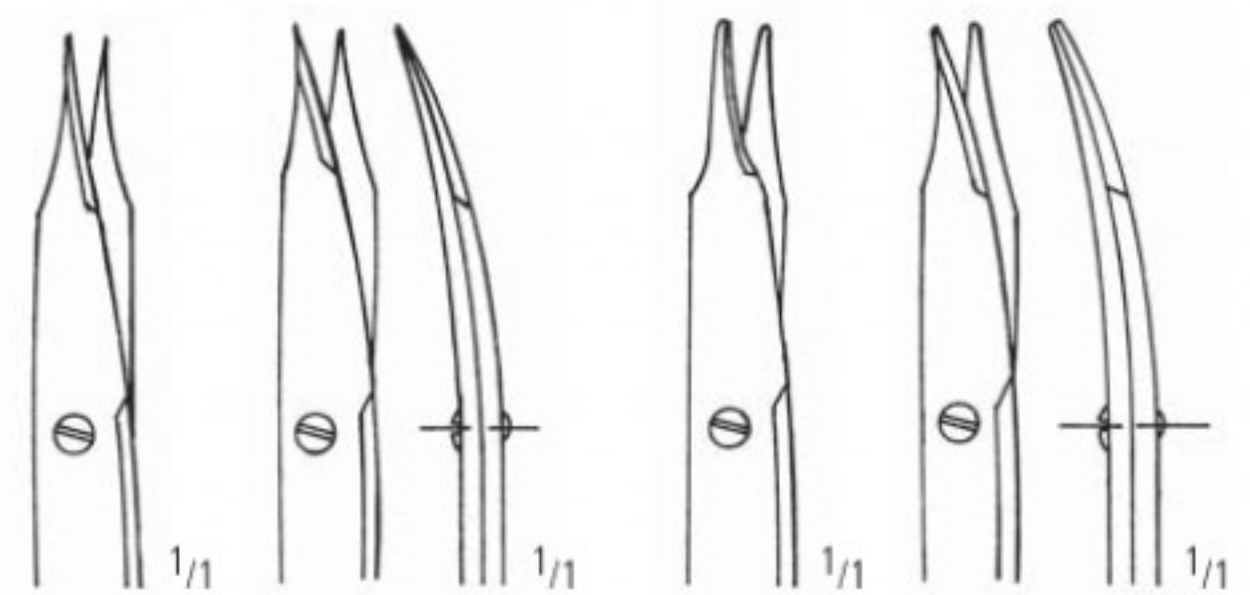

spitz
pointed
agudas
pointues
acuta

stumpf
blunt
romas
mousses
smussa

gerade
straight
rectas
droits
rette

gebogen
curved
curvas
courbes
curve

gerade
straight
rectas
droits
rette

gebogen
curved
curvas
courbes
curve

LA GRANGE
AC 472/11
11,5 cm/4¹/₂"

CHADWICK
AC 473/11
11,0 cm/4¹/₃"

STEVENS
10,5 cm/4¹/₄"
11,5 cm/4¹/₂"

AC 474/10
AC 474/11

AC 475/10
AC 475/11

AC 476/10
AC 476/11*

AC 477/10
AC 477/11*

SCHEREN SCISSORS TIJERAS CISEAUX FORBICI

Augenscheren
Eye Scissors
Tijeras oculares
Ciseaux oculaires
Forbici oftalmologici

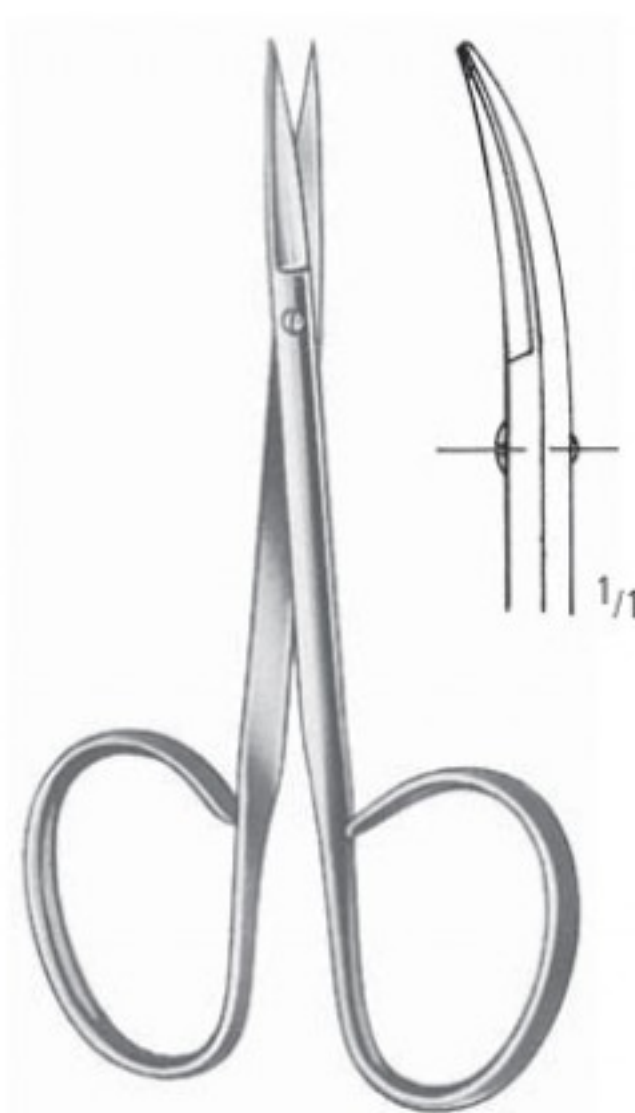

gerade
straight
rectas
droits
rette

gebogen
curved
curvas
courbes
curve

RIBBON

AC 488/10 AC 489/10
10,0 cm/4"



gerade
straight
rectas
droits
rette

gebogen
curved
curvas
courbes
curve

RIBBON

AC 490/10 AC 491/10
10,0 cm/4"



gerade
straight
rectas
droits
rette

gebogen
curved
curvas
courbes
curve

RIBBON

AC 492/10 AC 493/10
10,0 cm/4"

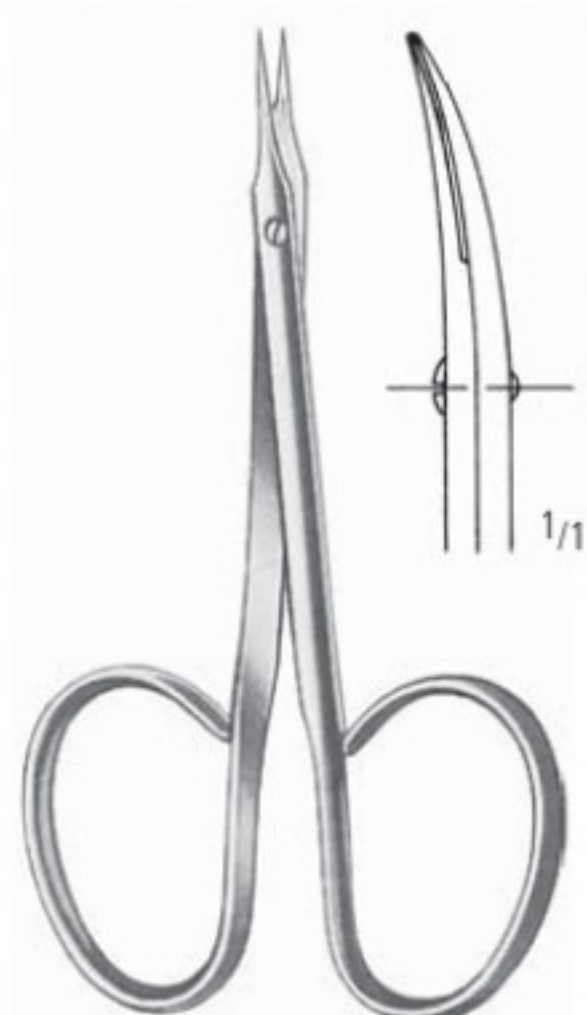

gerade
straight
rectas
droits
rette

gebogen
curved
curvas
courbes
curve

RIBBON

AC 494/09 AC 495/09
9,5 cm/3³/₄"

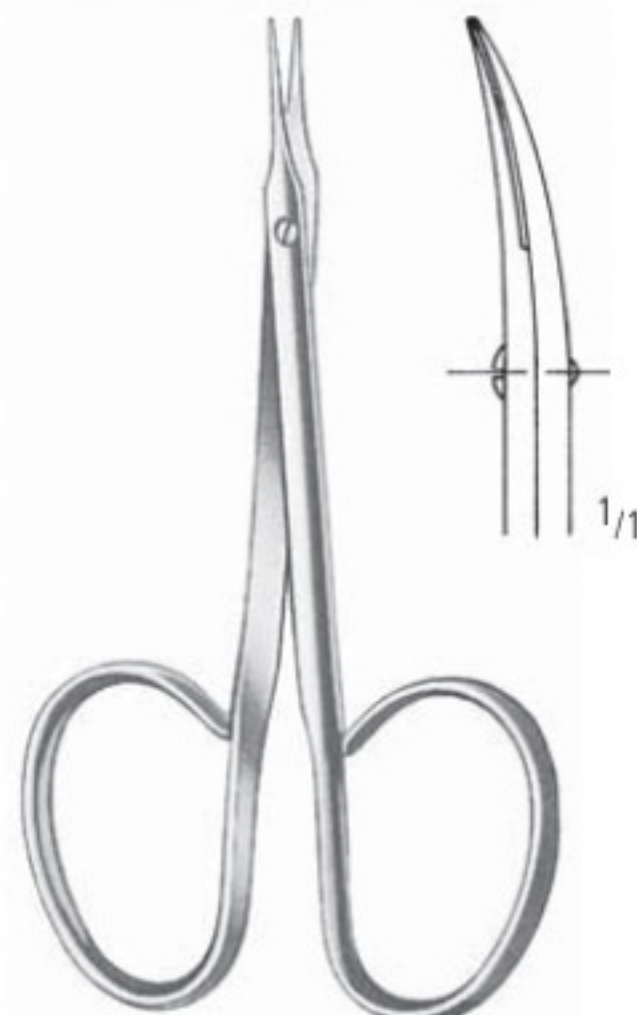

gerade
straight
rectas
droits
rette

gebogen
curved
curvas
courbes
curve

RIBBON

AC 496/09 AC 497/09
9,5 cm/3³/₄"

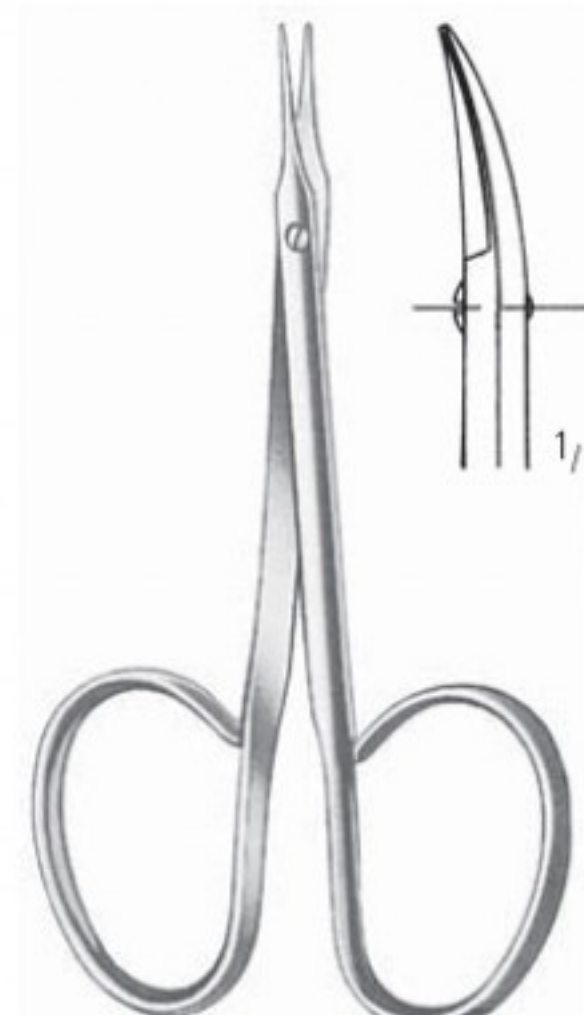

gerade
straight
rectas
droits
rette

gebogen
curved
curvas
courbes
curve

RIBBON

AC 498/09 AC 499/09
9,5 cm/3³/₄"

AA
AB
AC
AD
AE
AF
AG
AH
AI
AJ
AK
AL
AM
AN
AO
AP
AQ
AR
AS
AT
AU
AV
AW
AX
AY
AZ
BA
BB
BC
BD
BE
BF
BG
BH
BI
BJ
BK
BL
BM
BN
BO
BP
BQ
BR
BS
BT
BU
BV
BW
BX
BY
BZ
CA
CB
CC
CD
CE
CF
CG
CH
CI
CJ
CK
CL
CM
CN
CO
CP
CQ
CR
CS
CT
CU
CV
CW
CX
CY
CZ
DA
DB
DC
DD
DE
DF
DG
DH
DI
DJ
DK
DL
DM
DN
DO
DP
DQ
DR
DS
DT
DU
DV
DW
DX
DY
DZ
EA
EB
EC
ED
EE
EF
EG
EH
EI
EJ
EK
EL
EM
EN
EO
EP
EQ
ER
ES
ET
EU
EV
EW
EX
EY
EZ
FA
FB
FC
FD
FE
FF
FG
FH
FI
FJ
FK
FL
FM
FN
FO
FP
FQ
FR
FS
FT
FU
FV
FW
FX
FY
FZ
GA
GB
GC
GD
GE
GF
GG
GH
GI
GJ
GK
GL
GM
GN
GO
GP
GQ
GR
GS
GT
GU
GV
GW
GX
GY
GZ
HA
HB
HC
HD
HE
HF
HG
HH
HI
HJ
HK
HL
HM
HN
HO
HP
HQ
HR
HS
HT
HU
HV
HW
HX
HY
HZ
IA
IB
IC
ID
IE
IF
IG
IH
II
IJ
IK
IL
IM
IN
IO
IP
IQ
IR
IS
IT
IU
IV
IW
IX
IY
IZ
JA
JB
JC
JD
JE
JF
JG
JH
JI
JJ
JK
JL
JM
JN
JO
JP
JQ
JR
JS
JT
JU
JV
JW
JX
JY
JZ
KA
KB
KC
KD
KE
KF
KG
KH
KI
KJ
KK
KL
KM
KN
KO
KP
KQ
KR
KS
KT
KU
KV
KW
KX
KY
KZ
LA
LB
LC
LD
LE
LF
LG
LH
LI
LJ
LK
LL
LM
LN
LO
LP
LQ
LR
LS
LT
LU
LV
LW
LX
LY
LZ
MA
MB
MC
MD
ME
MF
MG
MH
MI
MJ
MK
ML
MM
MN
MO
MP
MQ
MR
MS
MT
MU
MV
MW
MX
MY
MZ
NA
NB
NC
ND
NE
NF
NG
NH
NI
NJ
NK
NL
NM
NN
NO
NP
NQ
NR
NS
NT
NU
NV
NW
NX
NY
NZ
OA
OB
OC
OD
OE
OF
OG
OH
OI
OJ
OK
OL
OM
ON
OO
OP
OQ
OR
OS
OT
OU
OV
OW
OX
OY
OZ
PA
PB
PC
PD
PE
PF
PG
PH
PI
PJ
PK
PL
PM
PN
PO
PP
PQ
PR
PS
PT
PU
PV
PW
PX
PY
PZ
QA
QB
QC
QD
QE
QF
QG
QH
QI
QJ
QK
QL
QM
QN
QO
QP
QQ
QR
QS
QT
QU
QV
QW
QX
QY
QZ
RA
RB
RC
RD
RE
RF
RG
RH
RI
RJ
RK
RL
RM
RN
RO
RP
RQ
RR
RS
RT
RU
RV
RW
RX
RY
RZ
SA
SB
SC
SD
SE
SF
SG
SH
SI
SJ
SK
SL
SM
SN
SO
SP
SQ
SR
SS
ST
SU
SV
SW
SX
SY
SZ
TA
TB
TC
TD
TE
TF
TG
TH
TI
TJ
TK
TL
TM
TN
TO
TP
TQ
TR
TS
TT
TU
TV
TW
TX
TY
TZ
UA
UB
UC
UD
UE
UF
UG
UH
UI
UJ
UK
UL
UM
UN
UO
UP
UQ
UR
US
UT
UU
UV
UW
UX
UY
UZ
VA
VB
VC
VD
VE
VF
VG
VH
VI
VJ
VK
VL
VM
VN
VO
VP
VQ
VR
VS
VT
VU
VV
VW
VX
VY
VZ
WA
WB
WC
WD
WE
WF
WG
WH
WI
WJ
WK
WL
WM
WN
WO
WP
WQ
WR
WS
WT
WU
WV
WW
WX
WY
WZ
XA
XB
XC
XD
XE
XF
XG
XH
XI
XJ
XK
XL
XM
XN
XO
XP
XQ
XR
XS
XT
XU
XV
XW
XX
XY
XZ
YA
YB
YC
YD
YE
YF
YG
YH
YI
YJ
YK
YL
YM
YN
YO
YP
YQ
YR
YS
YT
YU
YV
YW
YX
YY
YZ
ZA
ZB
ZC
ZD
ZE
ZF
ZG
ZH
ZI
ZJ
ZK
ZL
ZM
ZN
ZO
ZP
ZQ
ZR
ZS
ZT
ZU
ZV
ZW
ZX
ZY
ZZ

Ligaturscheren
Ligature Scissors
Tijeras para ligaduras
Ciseaux à ligatures
Forbici per legatura



SPENCER

9,0 cm/3¹/₂" AC 500/09
10,5 cm/4¹/₄" AC 500/10
12,5 cm/5" AC 500/13



SPENCER-DELICATE

AC 501/11
11,0 cm/4¹/₃"



LITTAUER

AC 502/14
14,0 cm/5¹/₂"



AC 503/16
16,0 cm/6¹/₄"



EISELSBERG

AC 504/12
11,0 cm/4¹/₃"



SCHOEMAKER-LOTH

AC 505/12
12,5 cm/5"



AC 506/11
11,5 cm/4¹/₂"

SCHEREN SCISSORS TIJERAS CISEAUX FORBICI

Ligaturscheren
Ligature Scissors
Tijeras para ligaduras
Ciseaux à ligatures
Forbici per legatura

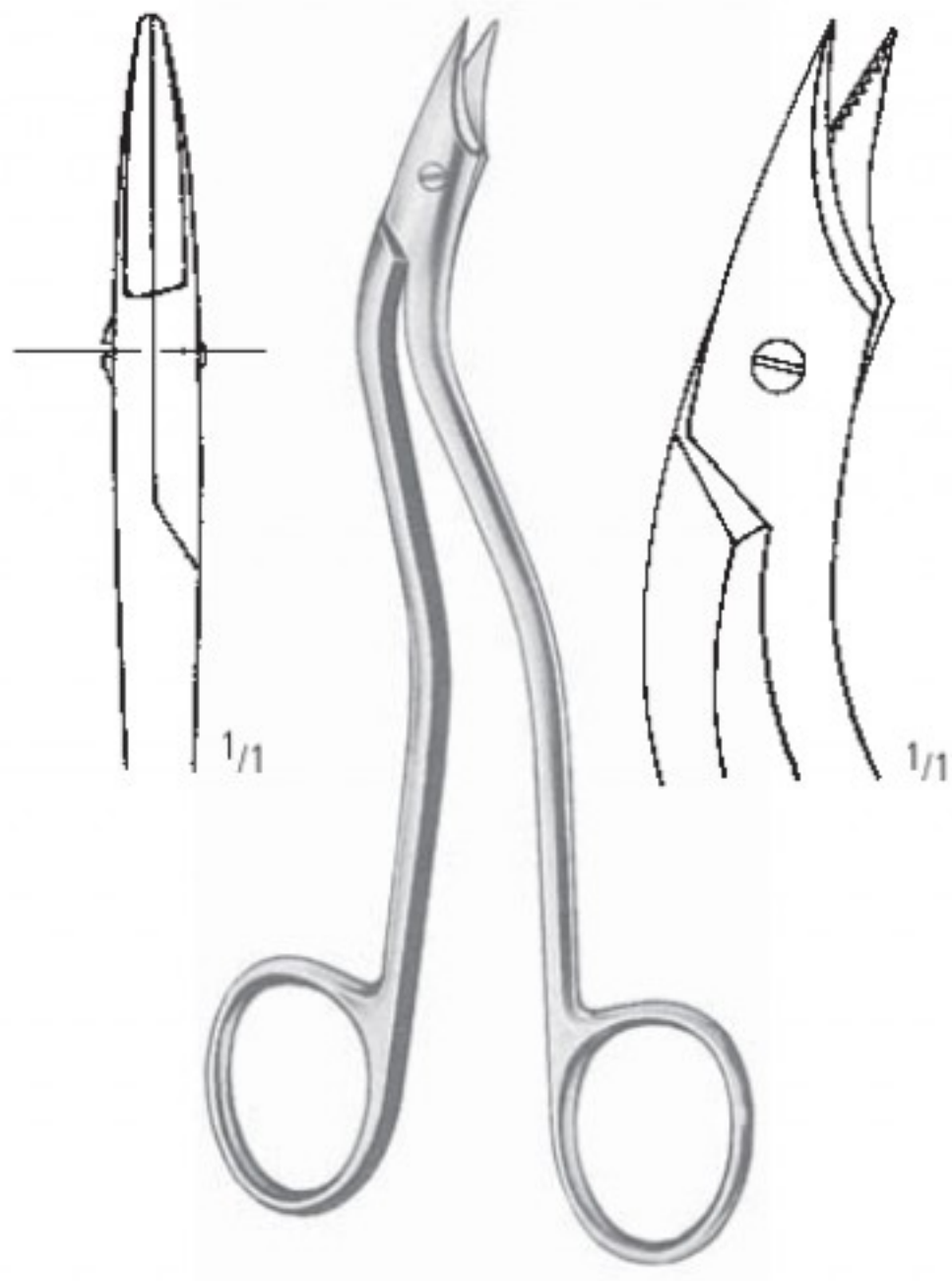

HEATH
AC 507/15
15,0 cm/6"



gezahnt
saw edge
dentadas
dentelés
dentata

AC 509/12
12,0 cm/4³/₄"



SHORTBENT
AC 513/09
9,0 cm/3¹/₂"



NORTHBENT
AC 514/12
12,5 cm/5"



BUCK
14,5 cm/5³/₄" AC 516/14
18,0 cm/7" AC 516/18

AA
AB
AC
AD
AE
AF
AK
AL
AM
AO
AP
AR
KA
KB
KC
KD
KU
KY

AC SCHEREN SCISSORS TIJERAS CISEAUX FORBICI

Draht- und Kronenscheren
 Wire Cutting and Crown Scissors
 Cizallas para cortar alambre, Tijeras para coronas
 Cisailles pour fils, Ciseaux à couronnes
 Forbici per filo metallico e per corone



HARVEY
 AC 520/12
 12,5 cm/5"

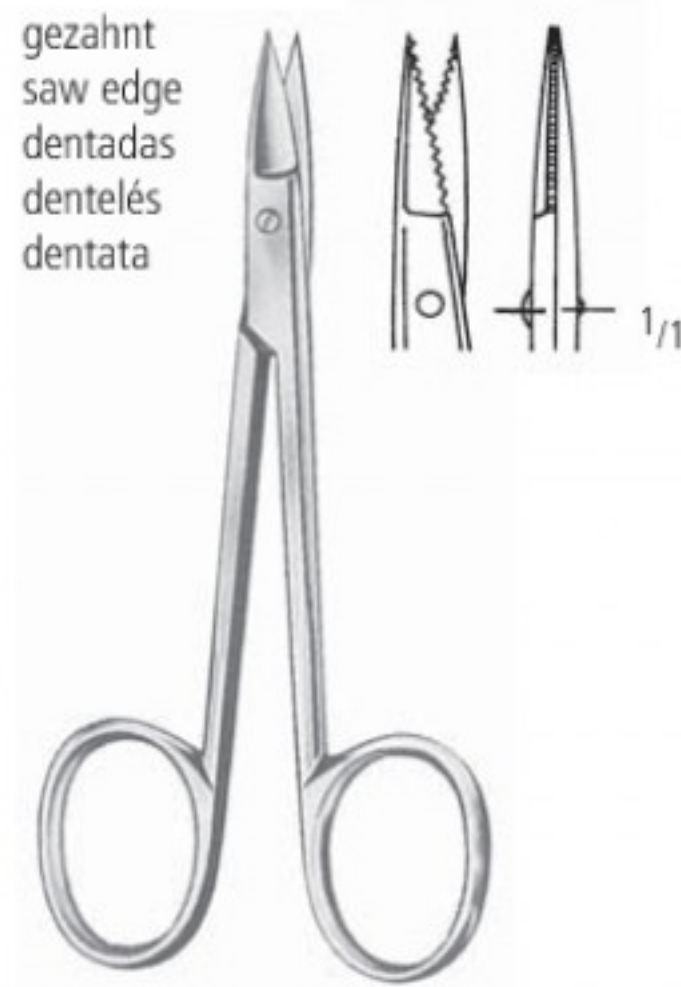

SCHUKNECHT
 AC 521/10
 10,0 cm/4"

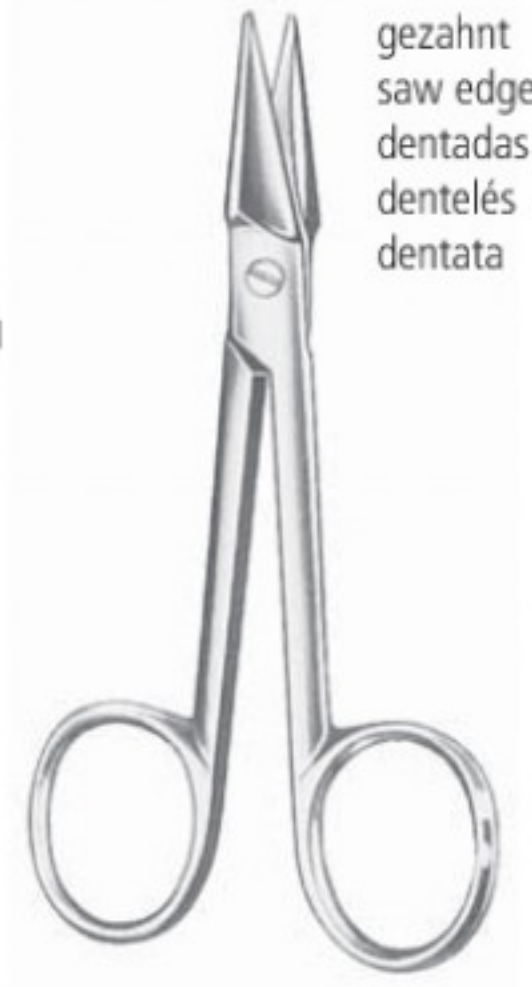

AC 522/11
 11,0 cm/4¹/₃"



UNIVERSAL
 AC 524/12
 12,0 cm/4³/₄"



SMITH
 AC 525/17
 17,5 cm/7"



BEEBEE
 10,5 cm/4¹/₄"
 gerade - straight - rectas - droits - rette



BEEBEE
 10,5 cm/4¹/₄"
 gebogen - curved - curvas - courbes - curve

SCHEREN SCISSORS TIJERAS CISEAUX FORBICI

Kronenschere
 Crown Scissors
 Tijeras para coronas
 Ciseaux à couronnes
 Forbici per corone

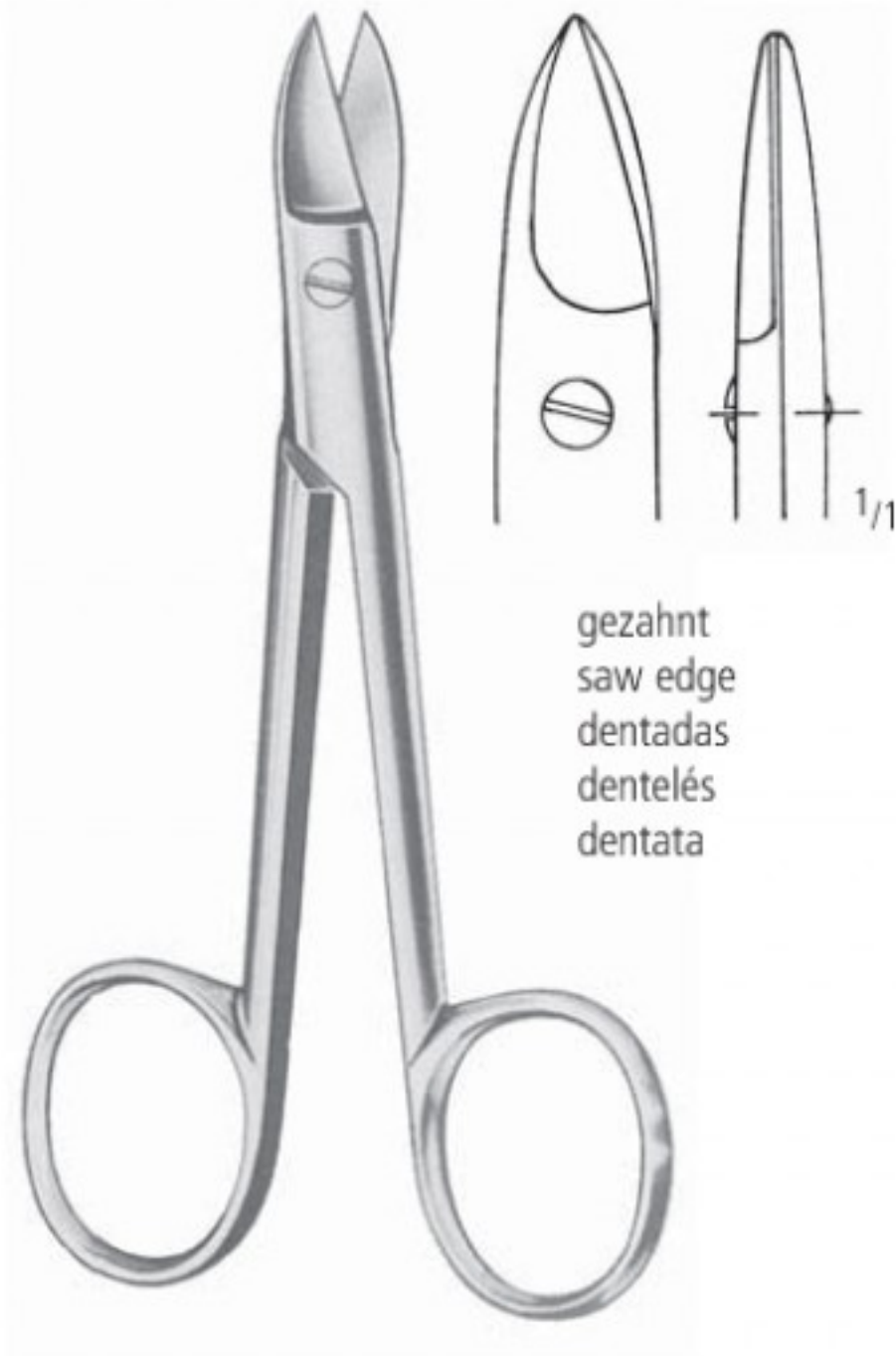

gezahnt
 saw edge
 dentadas
 dentelés
 dentata

BEEBEE
 AC 530/12
 12,0 cm/4³/₄"

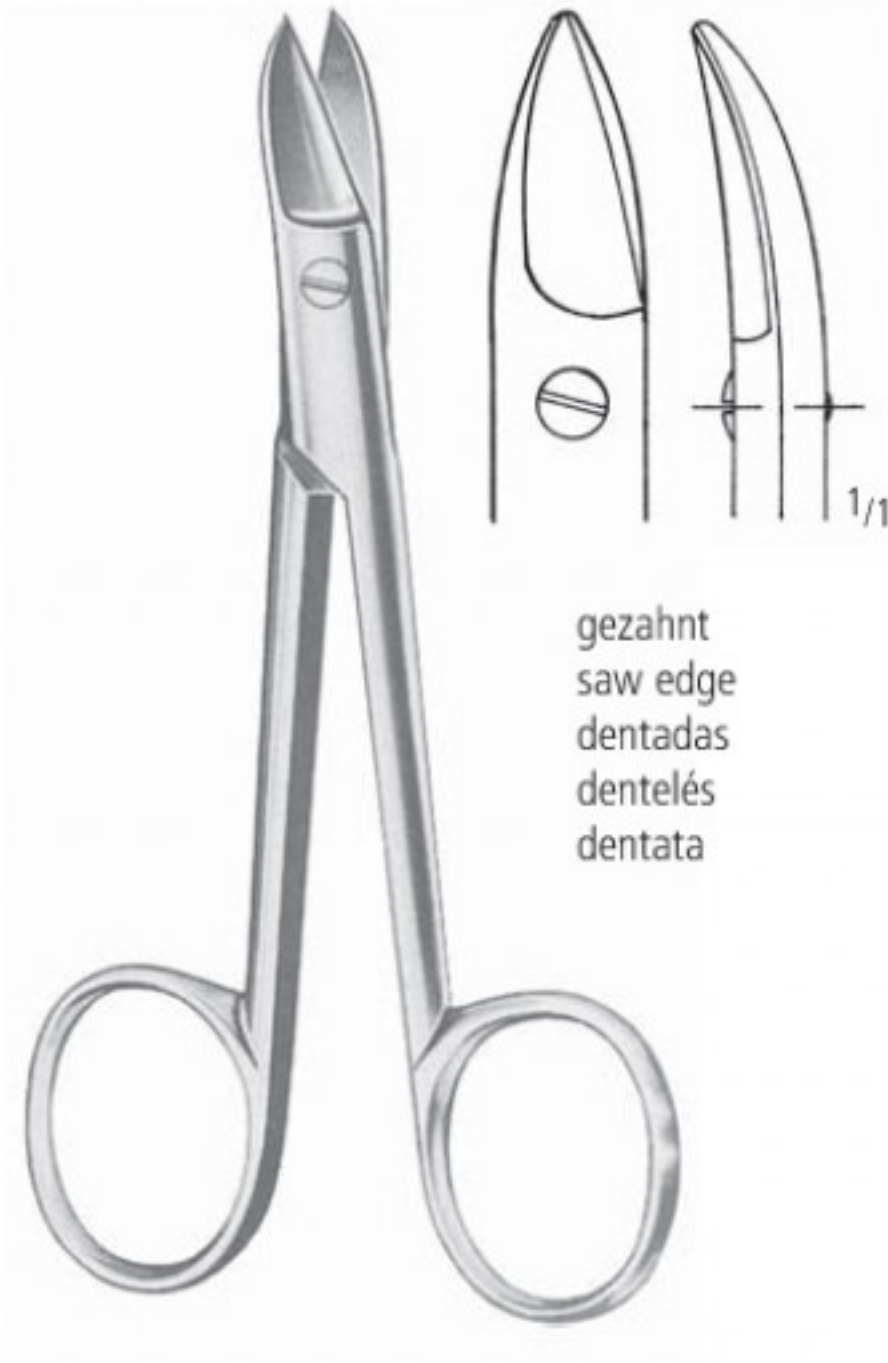

gezahnt
 saw edge
 dentadas
 dentelés
 dentata

BEEBEE
 AC 531/12
 12,0 cm/4³/₄"



AC 535/10
 10,5 cm/4¹/₄"



AC 536/09
 9,0 cm/3¹/₂"



AC 537/09
 9,0 cm/3¹/₂"



AC 538/11
 11,0 cm/4¹/₃"



AC 539/11
 11,0 cm/4¹/₃"

AA
 AB
 AC
 AD
 AE
 AF
 AK
 AL
 AM
 AO
 AP
 AR
 KA
 KB
 KC
 KD
 KU
 KY

Verband- und Kleiderscheren
 Bandage and Clothing Scissors
 Tijeras para vendajes y vestidos
 Ciseaux pour pansements
 Forbici per bendaggi



AC 551/14
 14,5 cm/5³/₄"

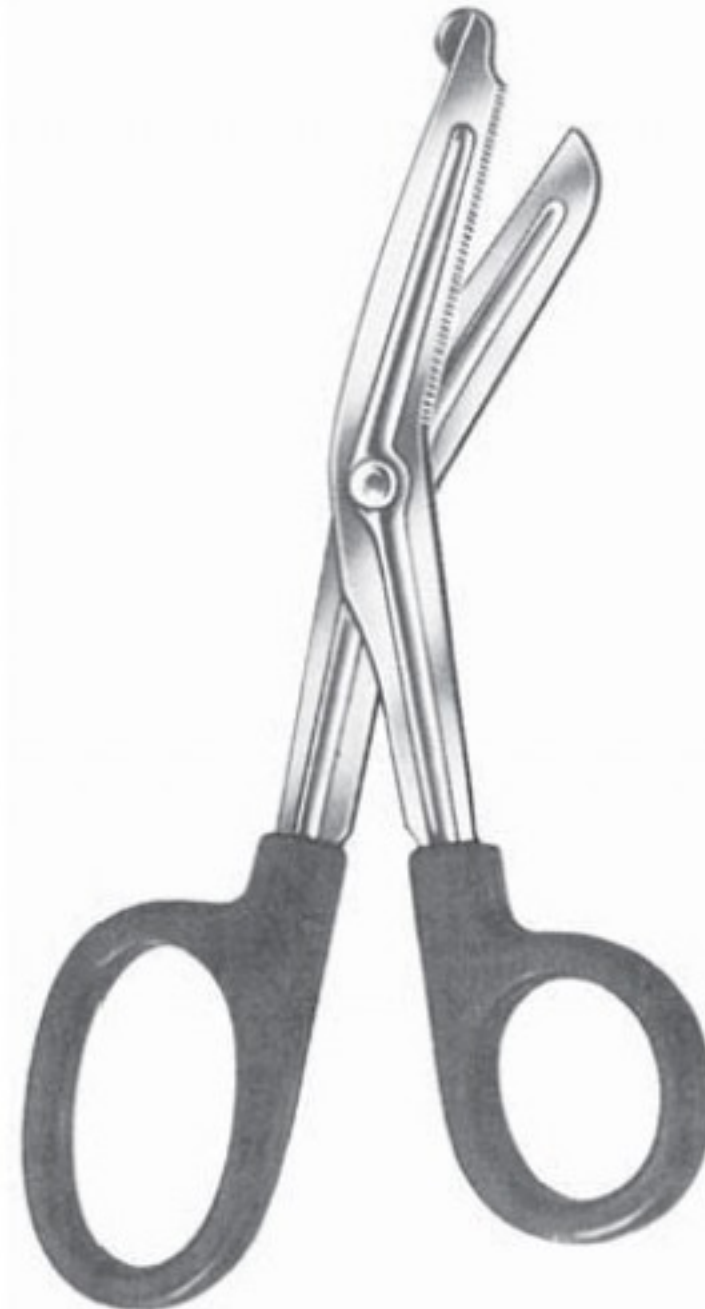

AC 551/16
 16,0 cm/6¹/₄"



143° C/290° F
 autoclavable

UNIVERSAL
 AC 551/18
 18,0 cm/7"



BERGMANN
 AC 553/23
 23,0 cm/9"



LANGE
 AC 554/18
 18,0 cm/7"



gezahnt
 saw edge
 dentadas
 dentelés
 dentata

AC 555/17
 17,0 cm/6³/₄"

SCHEREN SCISSORS TIJERAS CISEAUX FORBICI

Verband- und Kleiderscheren
 Bandage and Clothing Scissors
 Tijeras para vendajes y vestidos
 Ciseaux pour pansements
 Forbici per bendaggi



SMITH (Mod. USA)
 18,0 cm/7"
 20,0 cm/8"
 23,0 cm/9"
 AC 560/18
 AC 560/20
 AC 560/23



LORENZ
 AC 561/23
 23,0 cm/9"



KNOWLES
 AC 563/14
 14,0 cm/5½"



für Finger
 for fingers
 para dedos
 pour doigts
 per dita

KNOWLES
 AC 564/14
 14,0 cm/5½"



LISTER
 18,5 cm/7¼"
 21,0 cm/8¼"
 AC 565/18
 AC 565/21



gezahnt
 saw edge
 dentadas
 dentelés
 dentata

LISTER-EXCENTRIC
 16,0 cm/6¼"
 19,0 cm/7½"
 AC 566/16
 AC 566/19

AA
 AB
 AC
 AD
 AE
 AF
 AG
 AH
 AI
 AJ
 AK
 AL
 AM
 AN
 AO
 AP
 AQ
 AR
 AS
 AT
 AU
 AV
 AW
 AX
 AY
 AZ

AC SCHEREN SCISSORS TIJERAS CISEAUX FORBICI

Verbandscheren, Gipsscheren
 Bandage Scissors, Plaster-of-Paris Shears
 Tijeras para vendajes, Cizallas para vendajes enyesados
 Ciseaux pour pansements, Cisailles pour appareils plâtrés
 Forbici per bendaggi e per apparecchi gessati



9,0 cm/3 1/2"
 11,0 cm/4 1/3"
 14,0 cm/5 1/2"
 15,5 cm/6"
 18,0 cm/7"
 20,0 cm/8"

AC 567/09
 AC 567/11
 AC 567/14
 AC 567/15
 AC 567/18
 AC 567/20

LISTER



20,0 cm/8"
 22,0 cm/8 3/4"

AC 569/20
 AC 569/22

ESMARCH



SEUTIN
 AC 571/23
 23,0 cm/9"



gezahnt
 saw edge
 dentadas
 dentelés
 dentata

AC 573/20
 20,0 cm/8"



gezahnt
 saw edge
 dentadas
 dentelés
 dentata

AC 579/24

glatt
 smooth
 liso
 lisse
 liscio

AC 580/24

BRUNS
 24,0 cm/9 1/2"

SCHEREN SCISSORS TIJERAS CISEAUX FORBICI

Nagelscheren, Hautscheren, Nagelspaltscheren
 Nail Scissors, Cuticle Scissors, Nail Splitting Scissors
 Tijeras para uñas, Tijeras cuticulares, Tijeras para uñas encarnadas
 Ciseaux à ongles, Ciseaux à envies, Ciseaux pour ongles incarnés
 Forbici per unghie, Forbici per pelle, Forbici per unghie incarnate

AA
AB
AC
AD
AE
AF
AK
AL
AM
AO
AP
AR
KA
KB
KC
KD
KU
KY



9,0 cm/3 1/2"
10,5 cm/4 1/4"

AC 608/09
AC 608/10

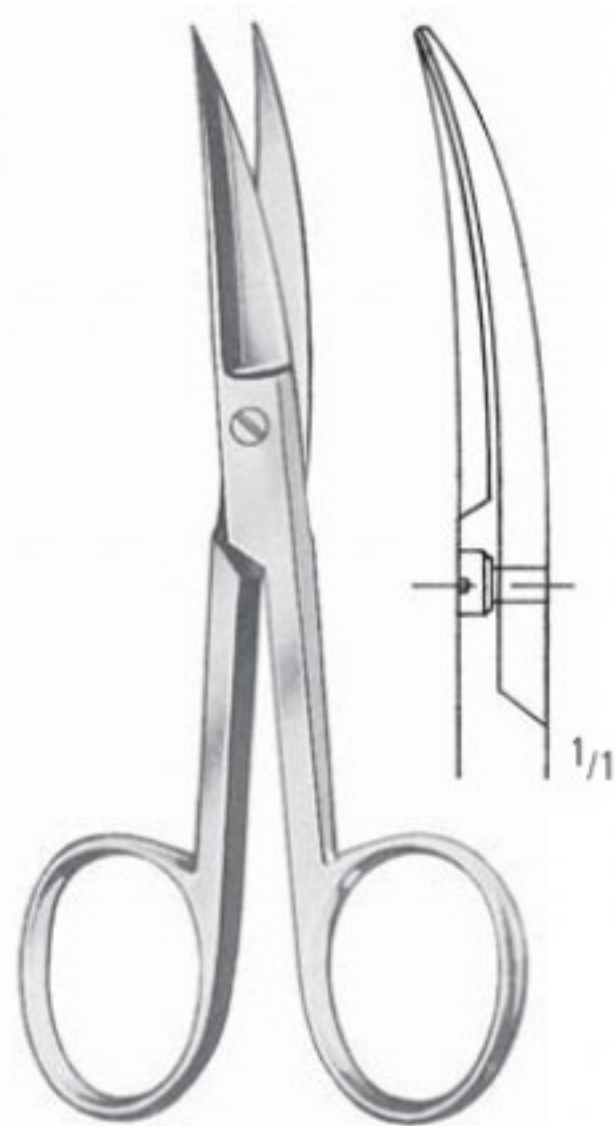

AC 609/09
AC 609/10



AC 610/09
AC 610/10

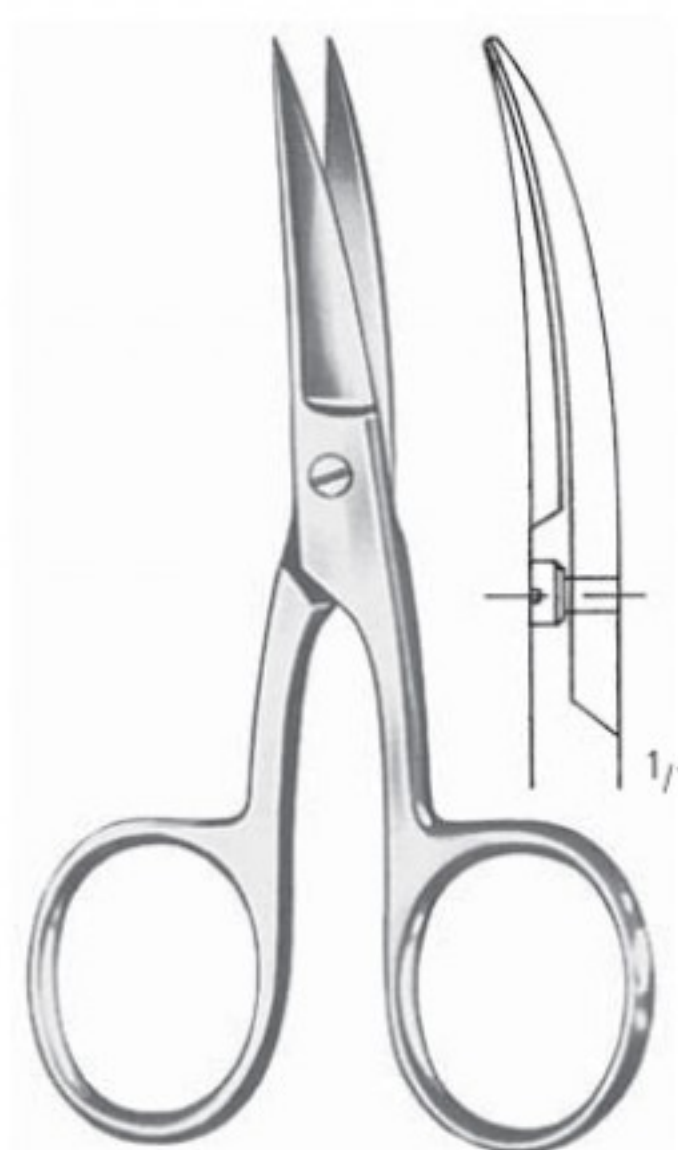

AC 611/09
AC 611/10



AC 612/10
AC 612/11

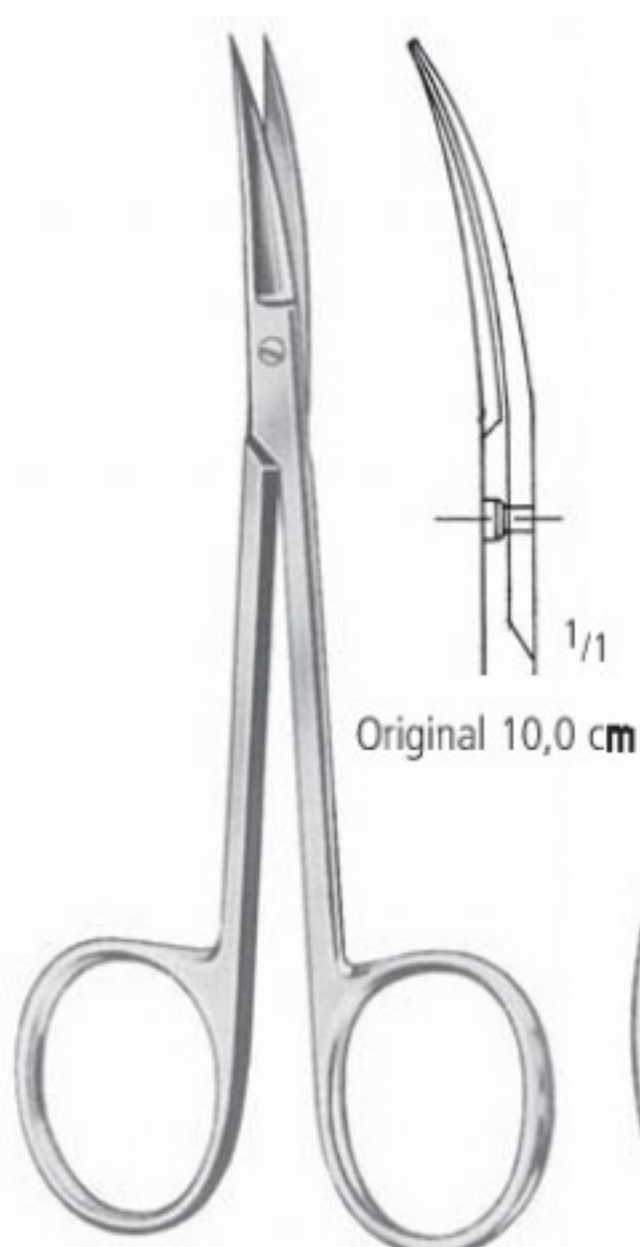

10,0 cm/4"
11,0 cm/4 1/3"

AC 613/10
AC 613/11



AC 624/11
10,5 cm/4 1/4"



AC 626/11
10,5 cm/4 1/4"



KÖNIG
AC 628/13 13,0 cm/5"
AC 628/15 15,0 cm/6"

AC SCHEREN SCISSORS TIJERAS CISEAUX FORBICI

Zahnfleischscheren
Gum Scissors
Tijeras para encias
Ciseaux à gencives
Forbici per gengiva

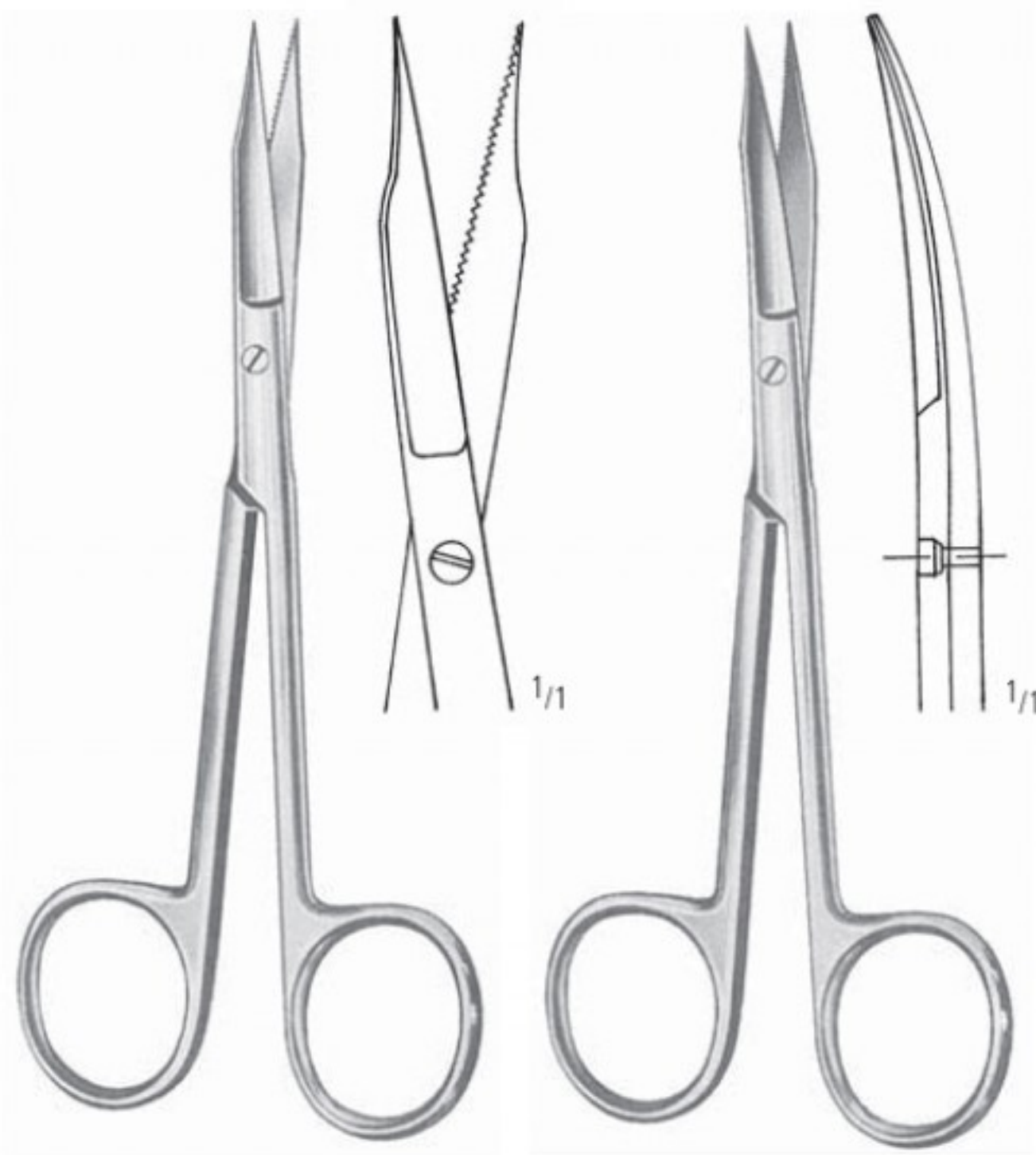

GOLDMAN-FOX

AC 630/13
13,0 cm/5"

AC 631/13
13,0 cm/5"

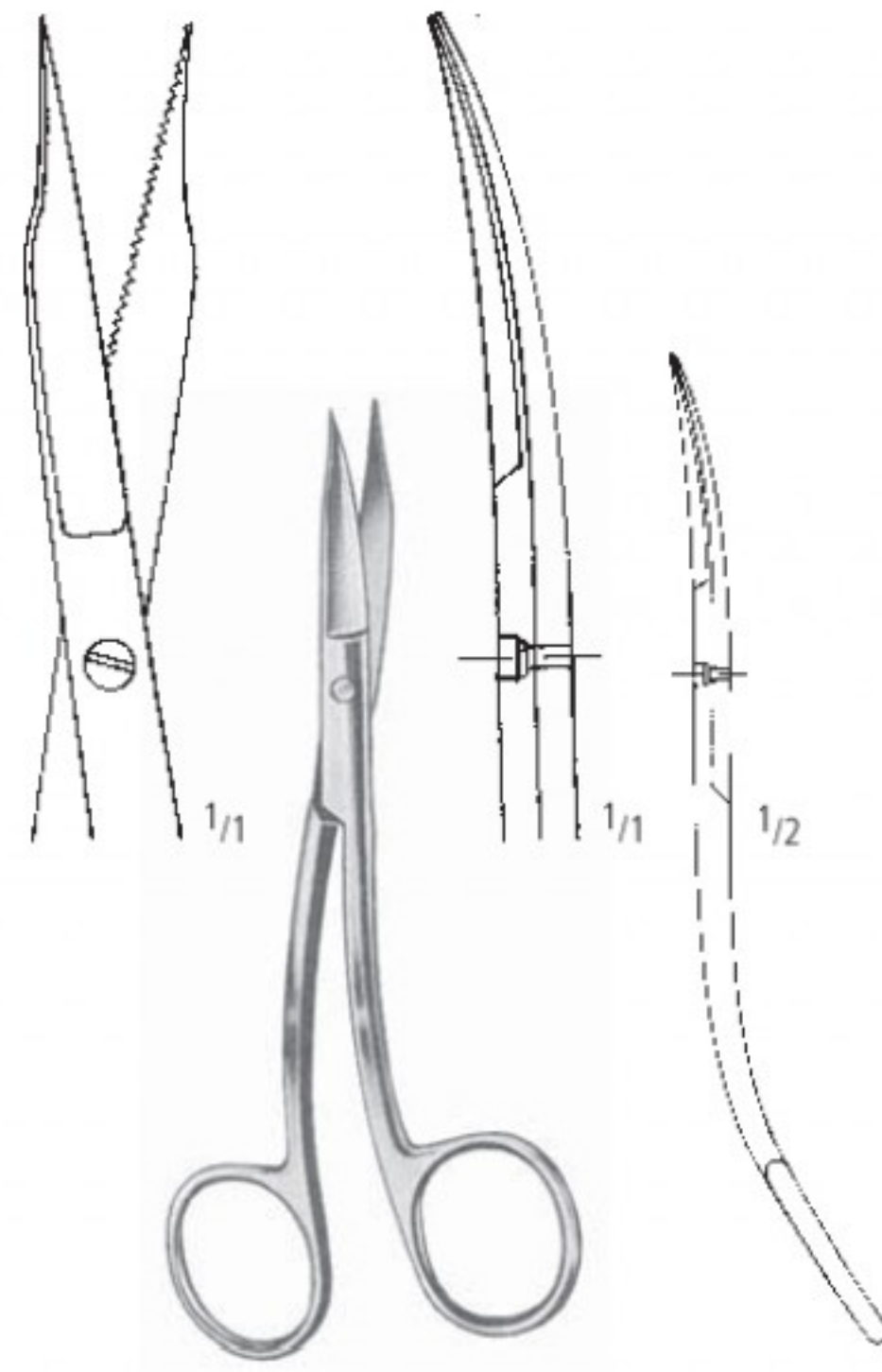

GOLDMAN-FOX (SPEZIAL)

AC 635/13
13,0 cm/5"

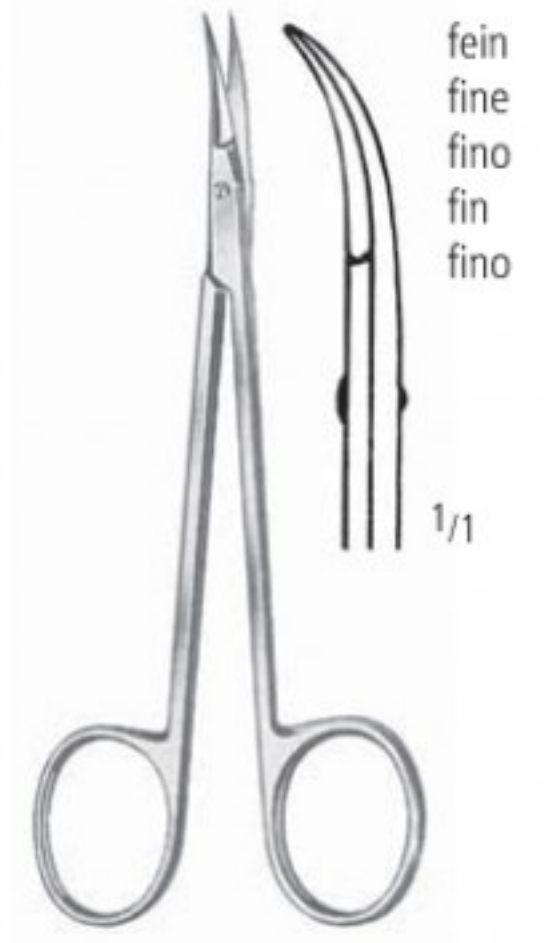

AC 637/11
11,5 cm/4 1/2"

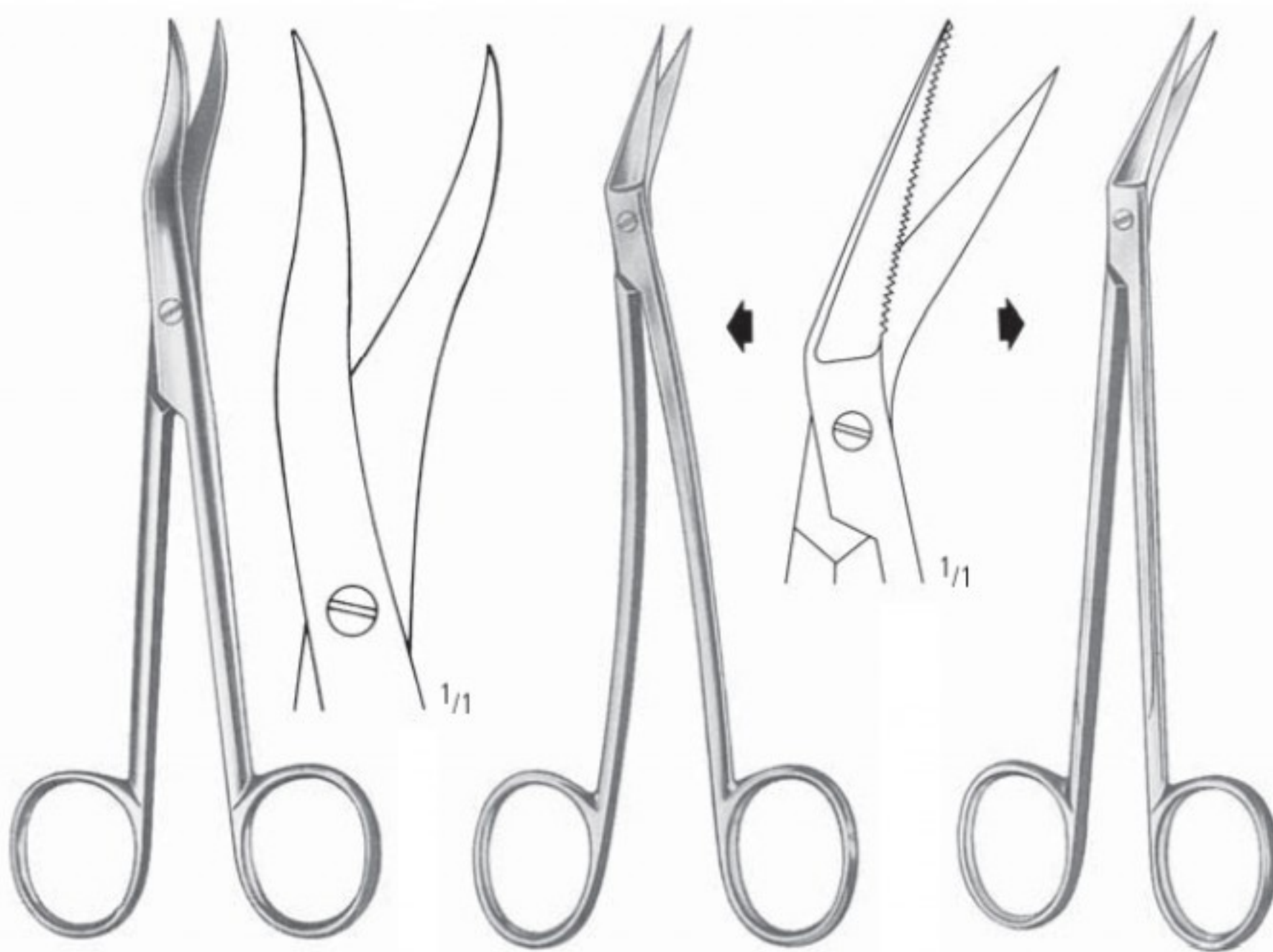

AC 639/16
16,0 cm/6 1/4"

LOCKLIN
AC 640/16
16,5 cm/6 1/2"

LOCKLIN
AC 641/16
16,5 cm/6 1/2"

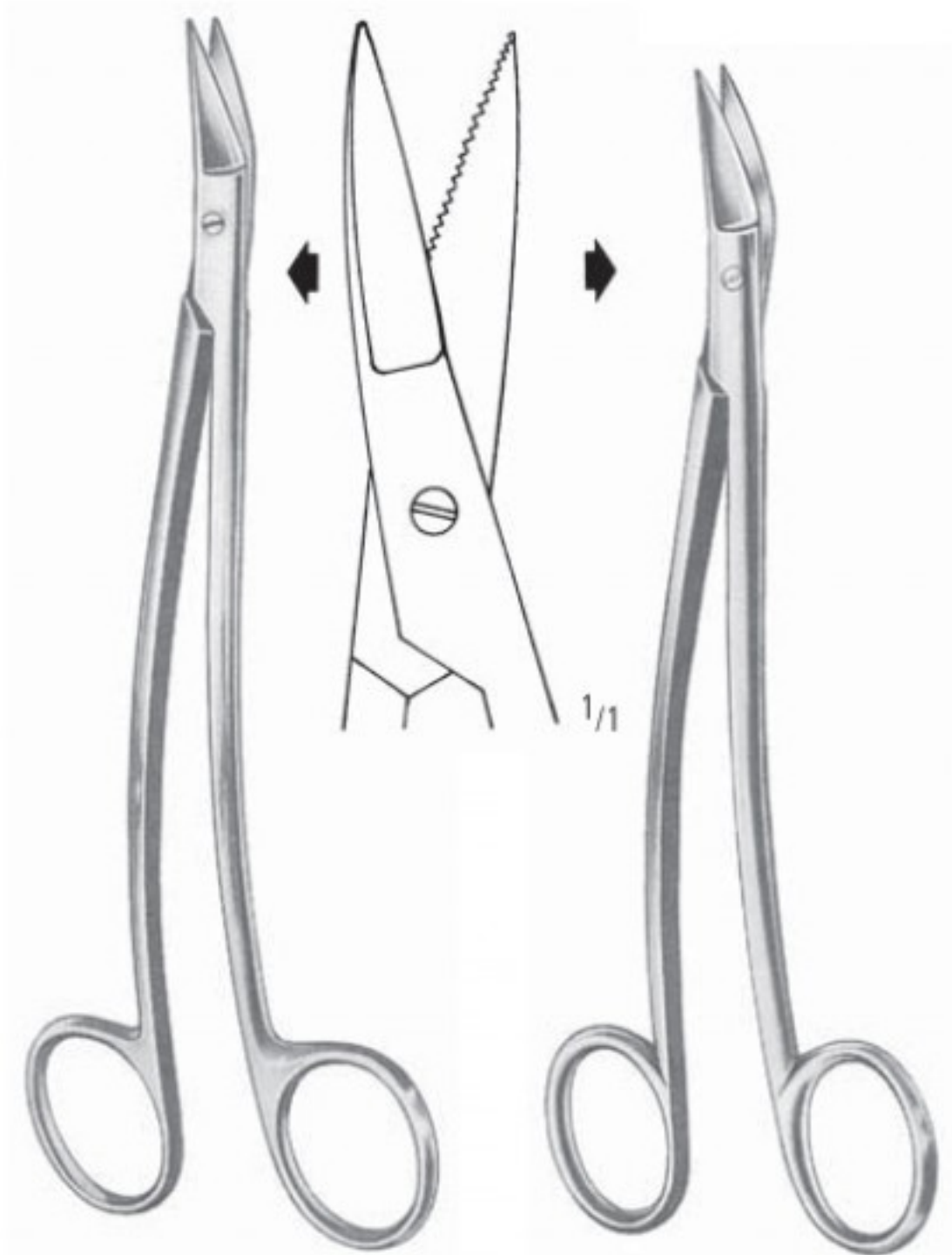

DEAN-DELICATE
AC 642/17
17,0 cm/6 3/4"

DEAN
AC 643/17
17,0 cm/6 3/4"

SCHEREN SCISSORS TIJERAS CISEAUX FORBICI

Zahnfleischscheren
 Gum Scissors
 Tijeras para encias
 Ciseaux à gencives
 Forbici per gengiva

AA
 AB
 AC
 AD
 AE
 AF
 AG
 AH
 AI
 AJ
 AK
 AL
 AM
 AN
 AO
 AP
 AQ
 AR
 AS
 AT
 AU
 AV
 AW
 AX
 AY
 AZ



QUINBY

AC 646/12
 12,0 cm/4³/₄"

AC 647/12
 12,0 cm/4³/₄"



STANDARD

AC 648/11
 11,0 cm/4¹/₃"

AC 649/11
 11,0 cm/4¹/₃"

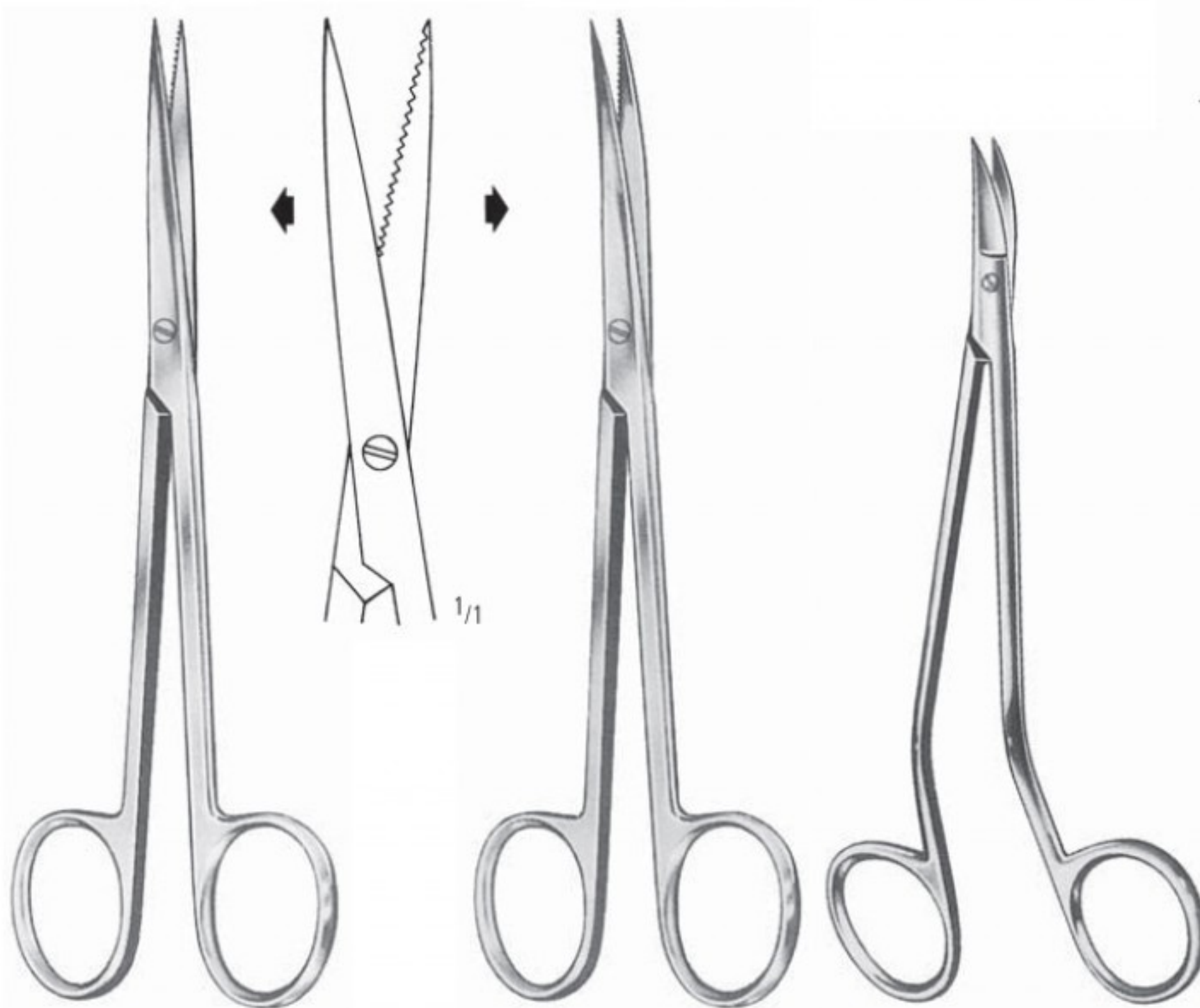

SULLIVAN

AC 650/14
 14,5 cm/5³/₄"

AC 651/14
 14,5 cm/5³/₄"

NEUMANN

AC 653/12
 12,5 cm/5"

Weitere Zahnfleischscheren, siehe Seiten
 108, 110, 112, 124, 127, 128, 161, 162

Other Gum Scissors see pages
 108, 110, 112, 124, 127, 128, 161, 162

Tijeras para encias similares véanse páginas
 108, 110, 112, 124, 127, 128, 161, 162

Ciseaux à gencives ultérieure voir pages
 108, 110, 112, 124, 127, 128, 161, 162

Forbici per gengiva ulteriori vedere pagine
 108, 110, 112, 124, 127, 128, 161, 162

AC SCHEREN SCISSORS TIJERAS CISEAUX FORBICI

Iridektomiescheren
Iris Scissors
Pinzas-tijeras para iridectomía
Ciseaux à iridectomie
Forbici per iridectomia

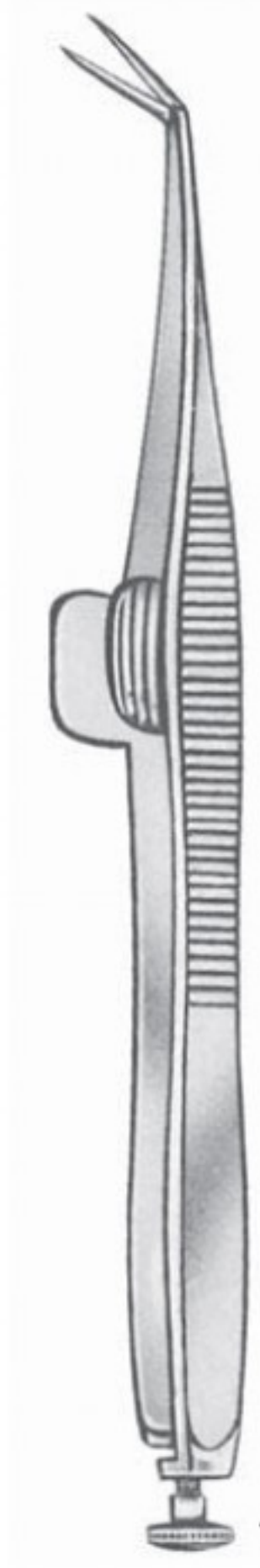
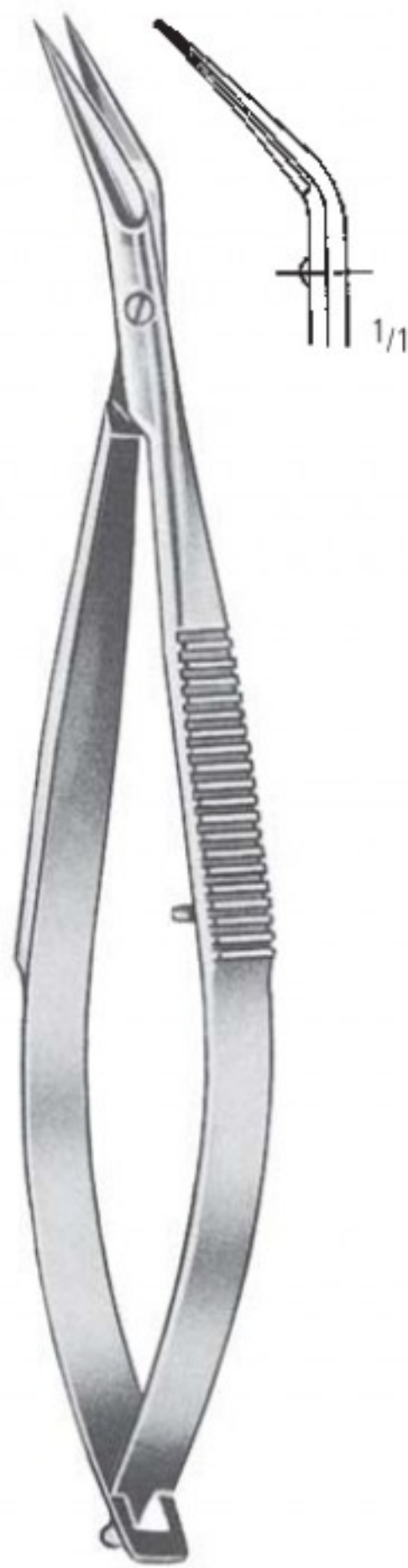
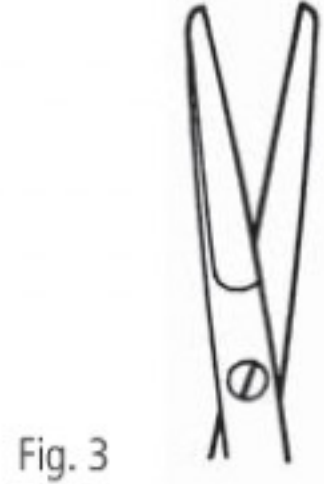
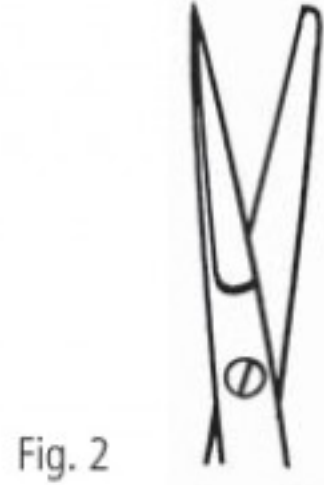
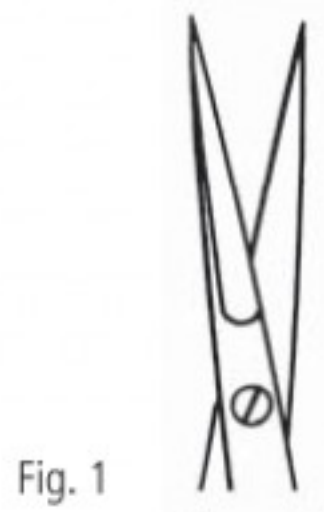
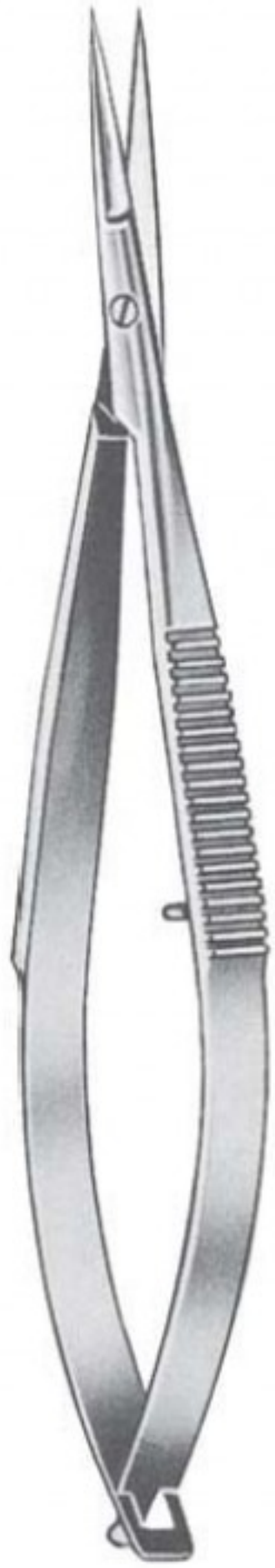

AC 760/11

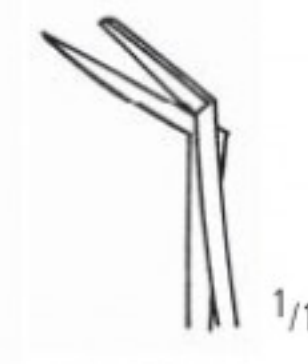

AC 762/11



AC 764/11



BARRAQUER
5,5 cm/2¹/₄"

- 5 mm AC 768/05
- 7 mm AC 768/07
- 10 mm AC 768/10

WECKER
11,0 cm/4¹/₃"

NOYES
12,0 cm/4³/₄"

- Fig. 1 AC 750/12
- Fig. 2 AC 752/12
- Fig. 3 AC 754/12

- Fig. 1 AC 751/12
- Fig. 2 AC 753/12
- Fig. 3 AC 755/12

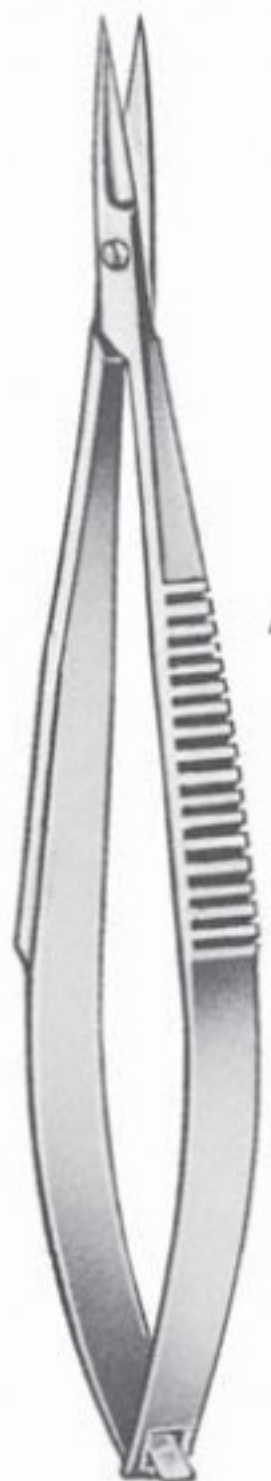

CASTROVIEJO
AC 770/00
9,0 cm/3¹/₂"



AC 770/02

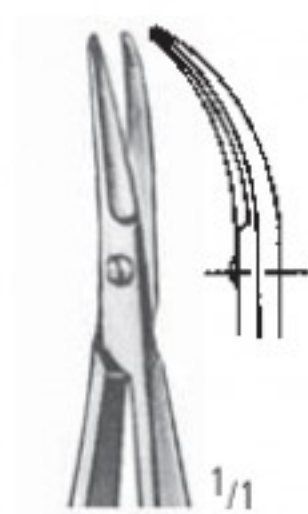

AC 770/03



AC 771/09



AC 772/09

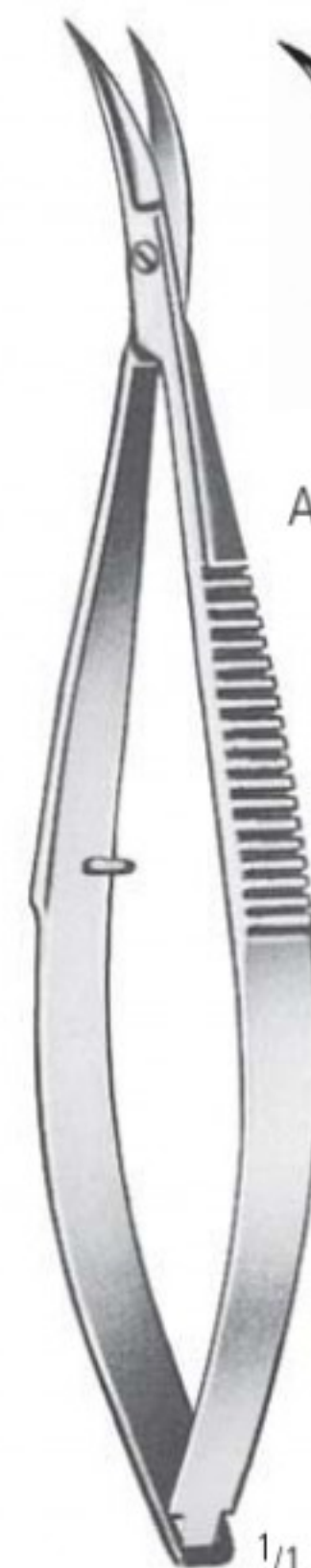

CASTROVIEJO
10,0 cm/4"



AC 773/10
spitz
pointed
agudas
pointues
acute

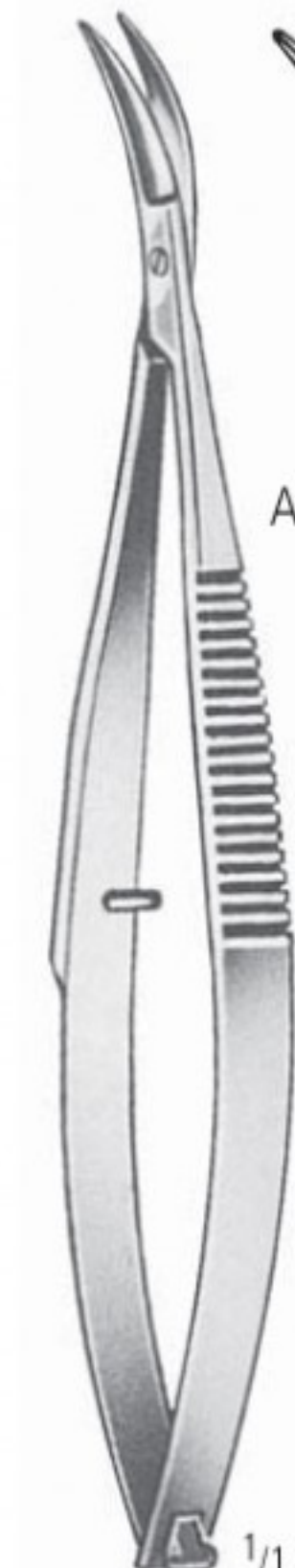

CASTROVIEJO
10,0 cm/4"



AC 775/10
stumpf
blunt
romas
mousses
smusse

SCHEREN SCISSORS TIJERAS CISEAUX FORBICI

Nachstarscheren
 Secondary Cataract Scissors
 Pinzas-tijeras para catarata secundaria
 Pincis ciseaux pour le cataracte secondaire
 Pinze-forbici per cataratta secundaria

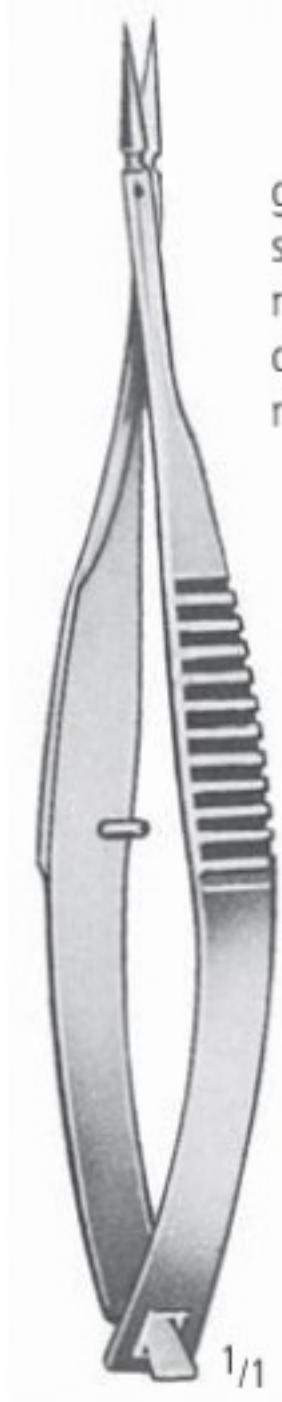

gerade
 straight
 rectas
 droits
 rette

AC 776/01
 8,5 cm/3 1/3"

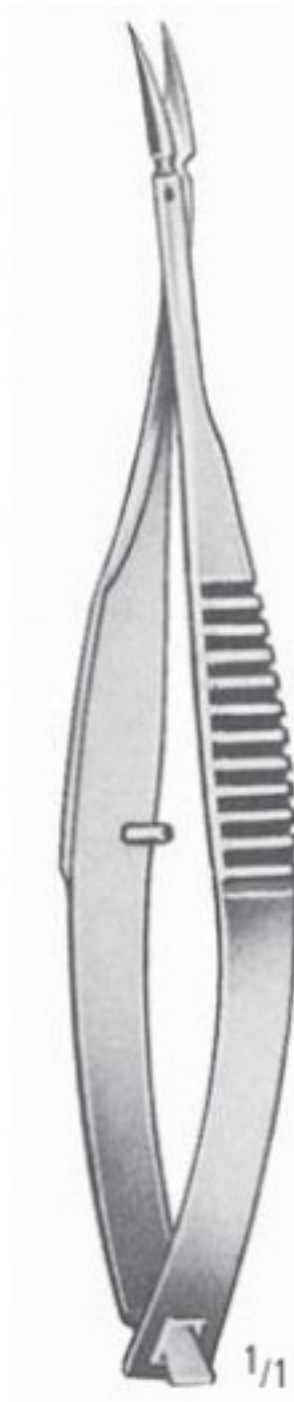

gebogen
 curved
 curvas
 courbes
 curve

AC 776/02
 8,5 cm/3 1/3"

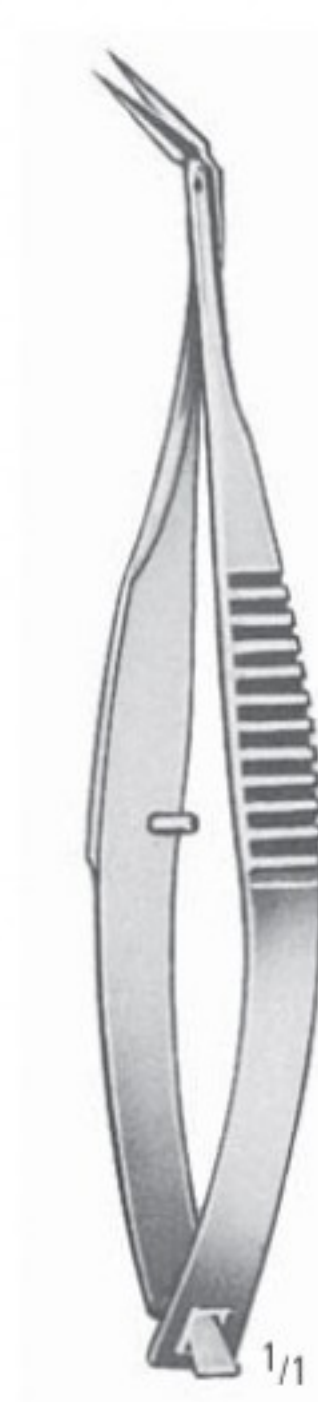

kniegebogen
 angular
 acodadas
 coudés
 angolato

AC 776/03
 8,5 cm/3 1/3"

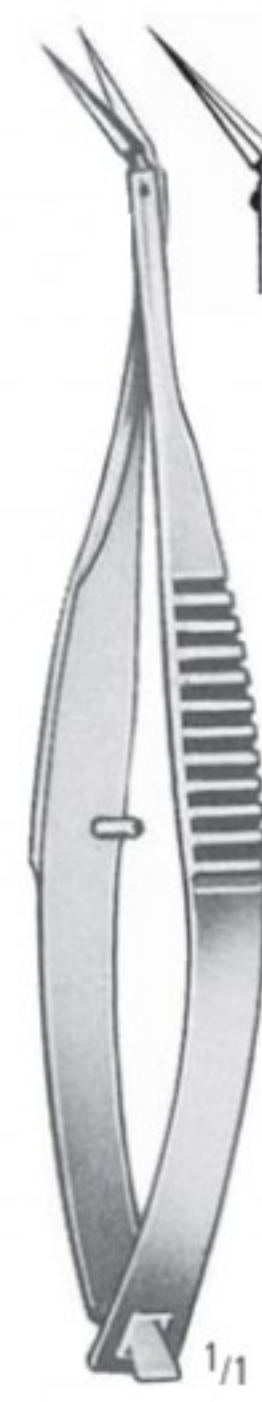

aufgewinkelt
 angled on flat
 acodadas hacia arriba
 coudés vers le haut
 angolato in alto

AC 776/04
 8,5 cm/3 1/3"

VANNAS MOD. TÜBINGEN

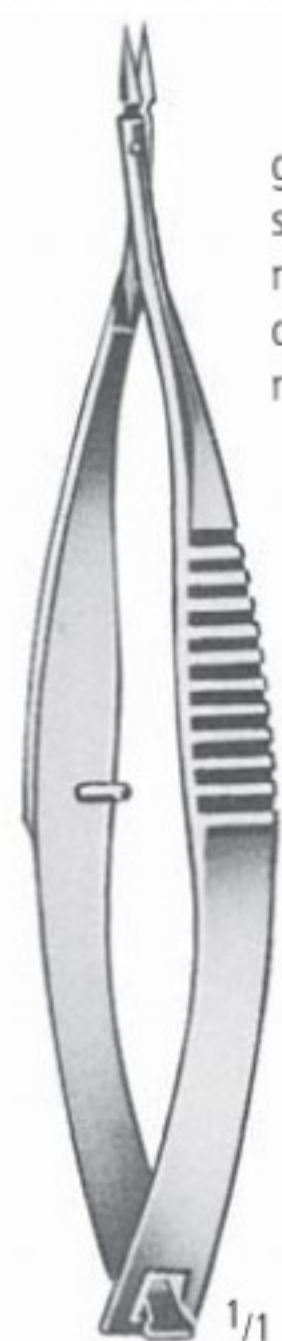

gerade
 straight
 rectas
 droits
 rette

VANNAS
 AC 778/01
 8,0 cm/3"

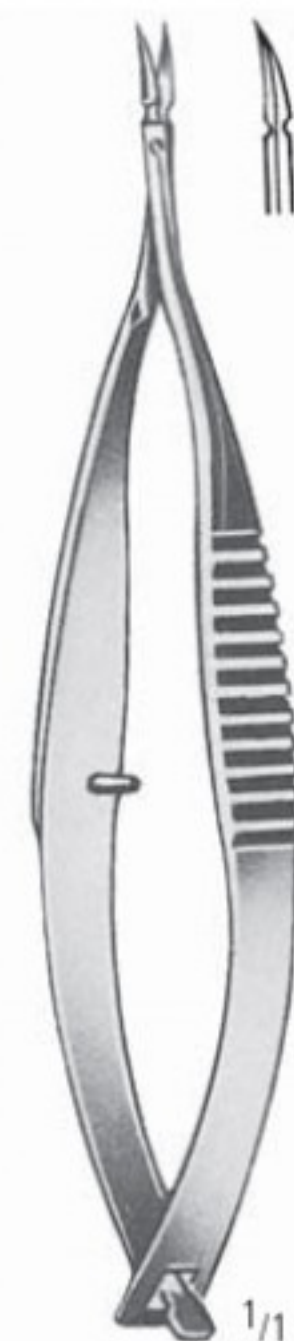

gebogen
 curved
 curvas
 courbes
 curve

VANNAS
 AC 778/02
 8,0 cm/3"

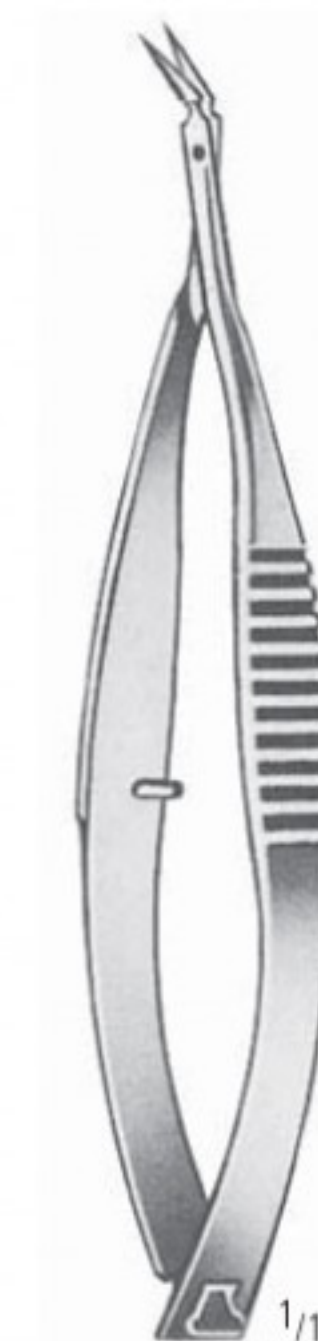

kniegebogen
 angular
 acodadas
 coudés
 angolato

VANNAS
 AC 778/03
 8,0 cm/3"

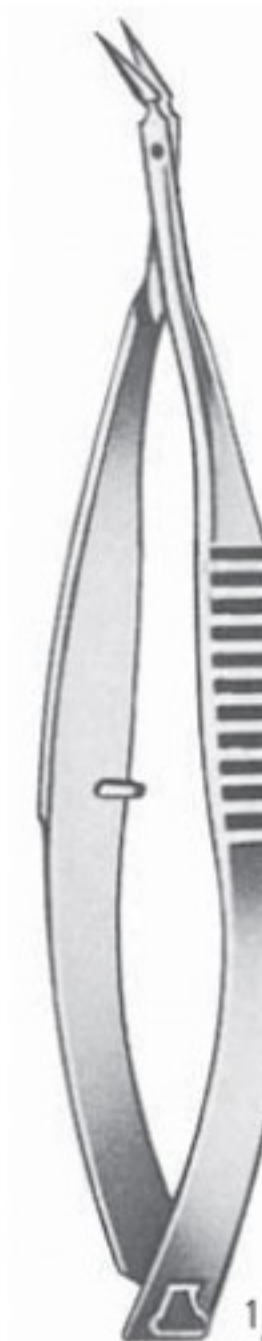

aufgewinkelt
 angled on flat
 acodadas hacia arriba
 coudés vers le haut
 angolato in alto

VANNAS
 AC 778/04
 8,0 cm/3"

AA
 AB
 AC
 AD
 AE
 AF
 AG
 AH
 AI
 AJ
 AK
 AL
 AM
 AN
 AO
 AP
 AQ
 AR
 AS
 AT
 AU
 AV
 AW
 AX
 AY
 AZ

AC SCHEREN SCISSORS TIJERAS CISEAUX FORBICI

Sehnenscheren, Kapsulotomiescheren
 Tenotomy Scissors, Capsulotomy Scissors
 Tijeras para tenotomía, Tijeras para capsulotomía
 Ciseaux à ténnotomie, Ciseaux pour capsulotomie
 Forbici per tenotomia, Forbici per capsulotomia



GILLS-WELSH
 8,5 cm/3¹/₃"



AC 779/01



AC 779/02



AC 779/03

kniegebogen
 angular
 acodadas
 coudés
 angolato



AC 779/04

aufgewinkelt
 angled on flat
 acodadas hacia arriba
 coudés vers le haut
 angolato in alto

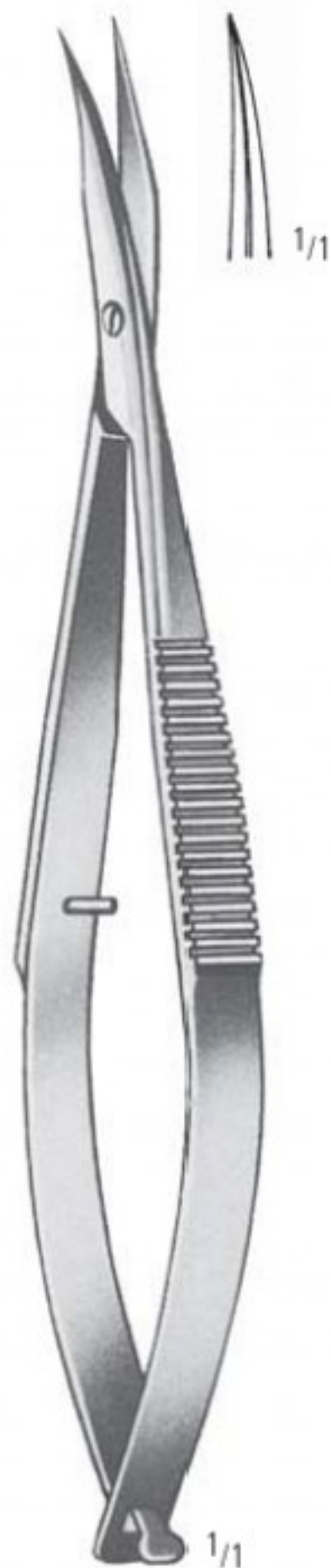

WESTCOTT
 AC 780/11
 11,0 cm/4¹/₃"



WESTCOTT
 AC 782/11
 11,0 cm/4¹/₃"

SCHEREN SCISSORS TIJERAS CISEAUX FORBICI

Hornhautscheren
 Corneal Section Scissors
 Pinzas-tijeras para córnea
 Pincis ciseaux corneales
 Forbici per cornea

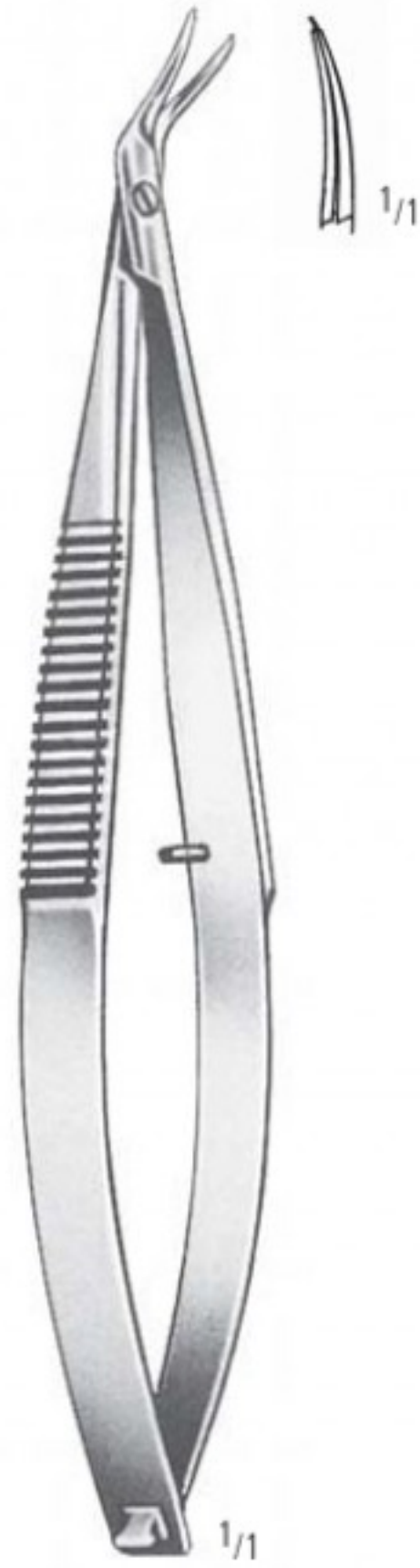

CASTROVIEJO
 AC 785/01
 10,0 cm/4"

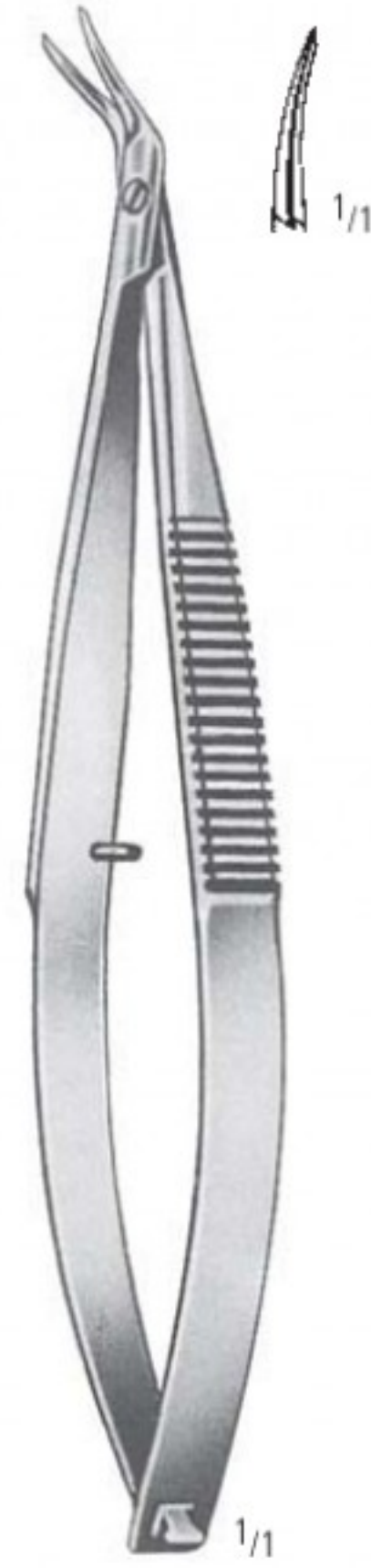

CASTROVIEJO
 AC 785/02
 10,0 cm/4"

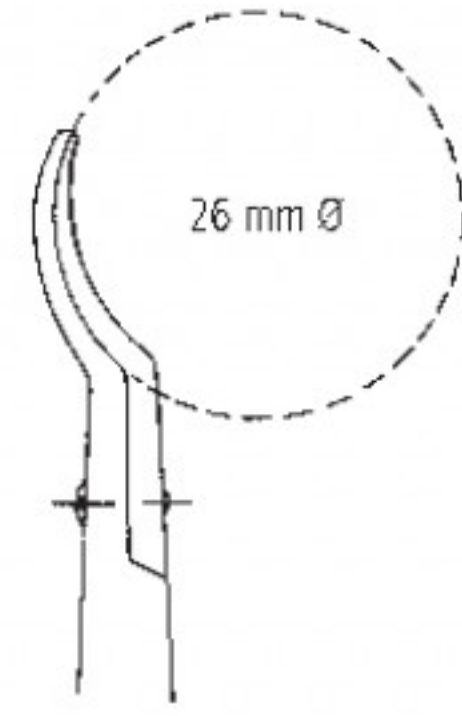

CASTROVIEJO
 AC 786/01
 11,0 cm/4 1/3"



CASTROVIEJO
 AC 786/02
 11,0 cm/4 1/3"



TROUTMAN
 AC 788/01
 10,0 cm/4"



TROUTMAN
 AC 788/02
 10,0 cm/4"

AA
 AB
AC
 AD
 AE
 AF
 AG
 AH
 AI
 AJ
 AK
 AL
 AM
 AN
 AO
 AP
 AQ
 AR
 AS
 AT
 AU
 AV
 AW
 AX
 AY
 AZ

AC SCHEREN SCISSORS TIJERAS CISEAUX FORBICI

Hornhautscheren
 Corneal Section Scissors
 Pinzas-tijeras para córnea
 Pincers ciseaux corneales
 Forbici per cornea



KATZIN
 AC 790/01
 10,0 cm/4"

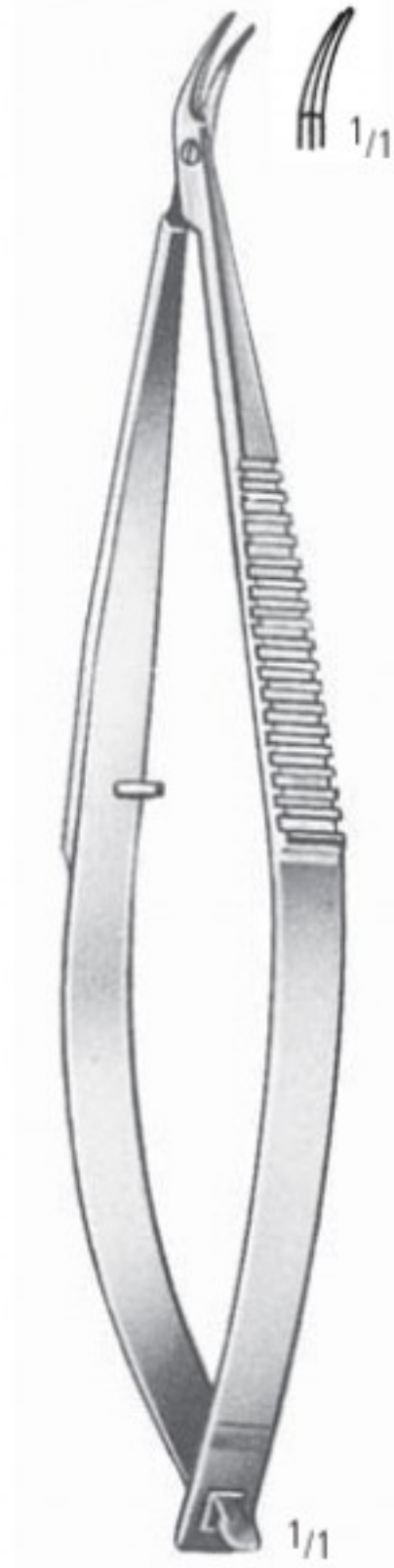

KATZIN
 AC 790/02
 10,0 cm/4"

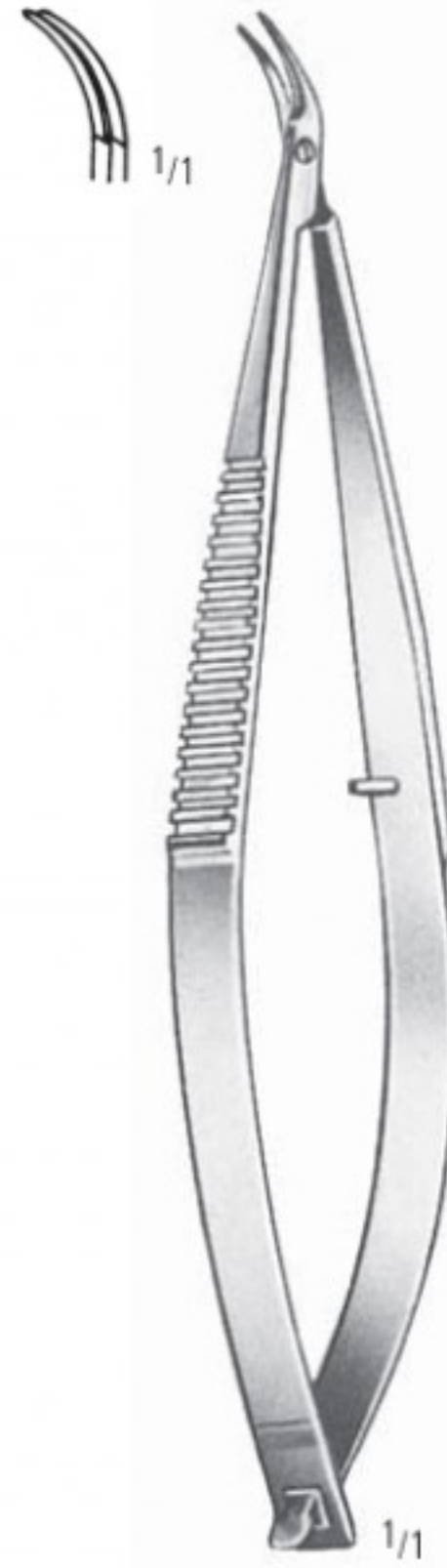

KATZIN
 AC 791/01
 11,0 cm/4¹/₃"

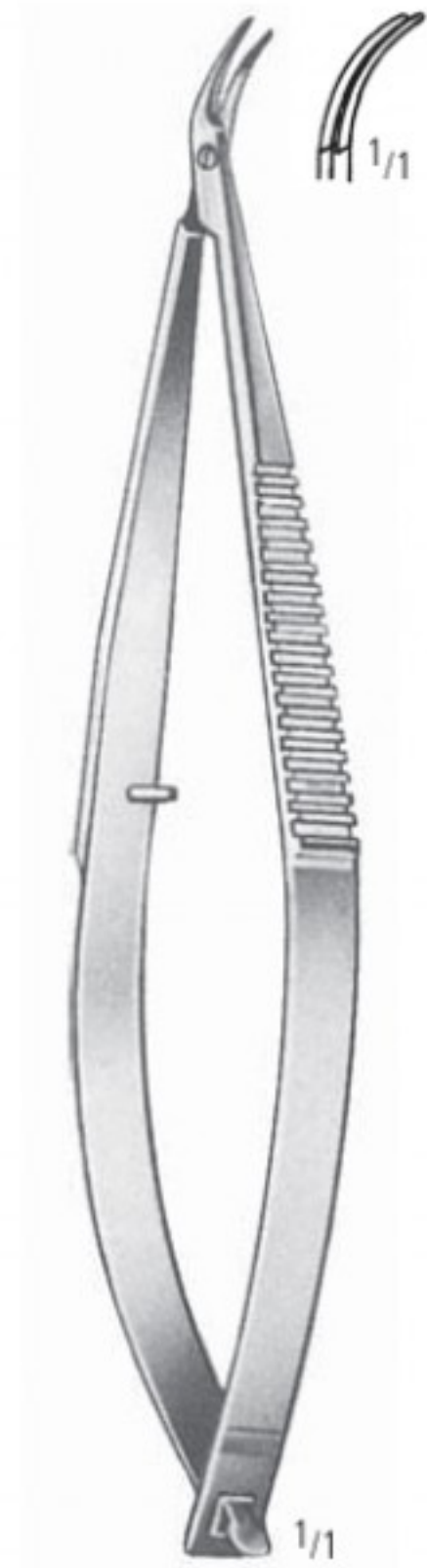

KATZIN
 AC 791/02
 11,0 cm/4¹/₃"

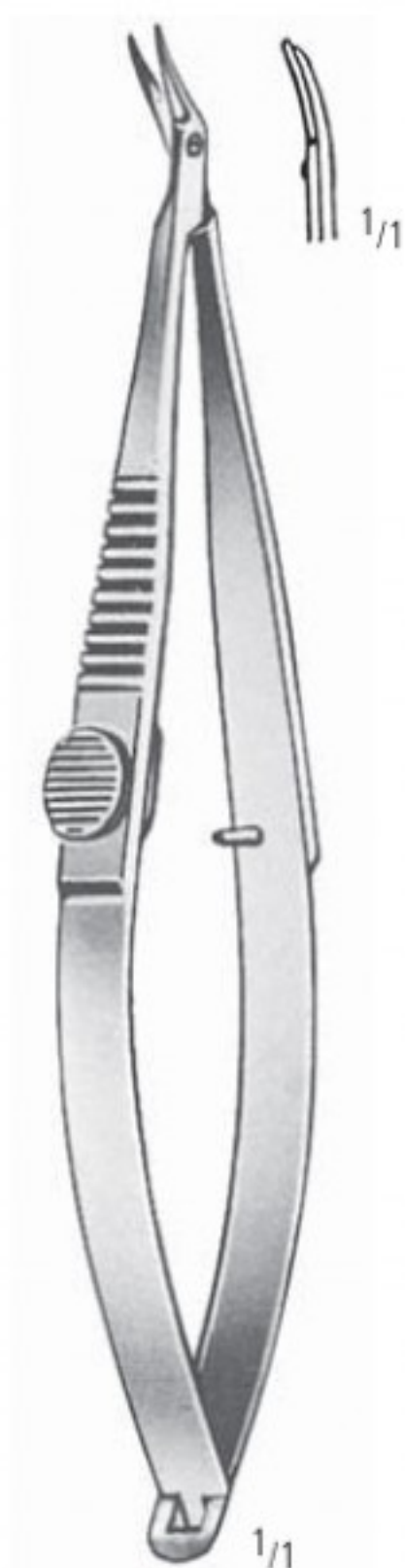

KATZIN-BARRAQUER
 AC 792/01
 10,0 cm/4"

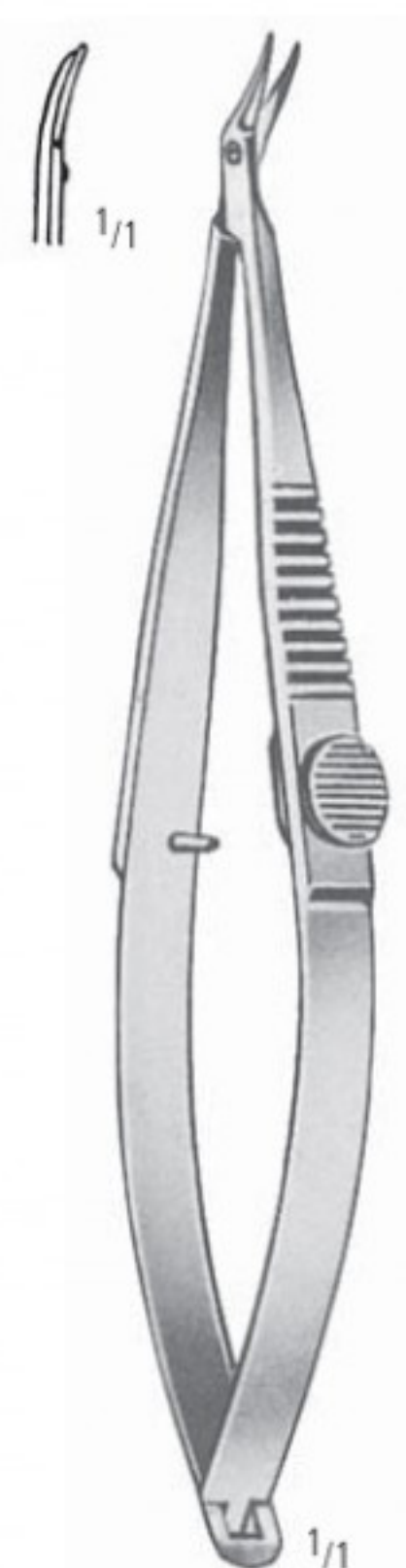

KATZIN-BARRAQUER
 AC 792/02
 10,0 cm/4"

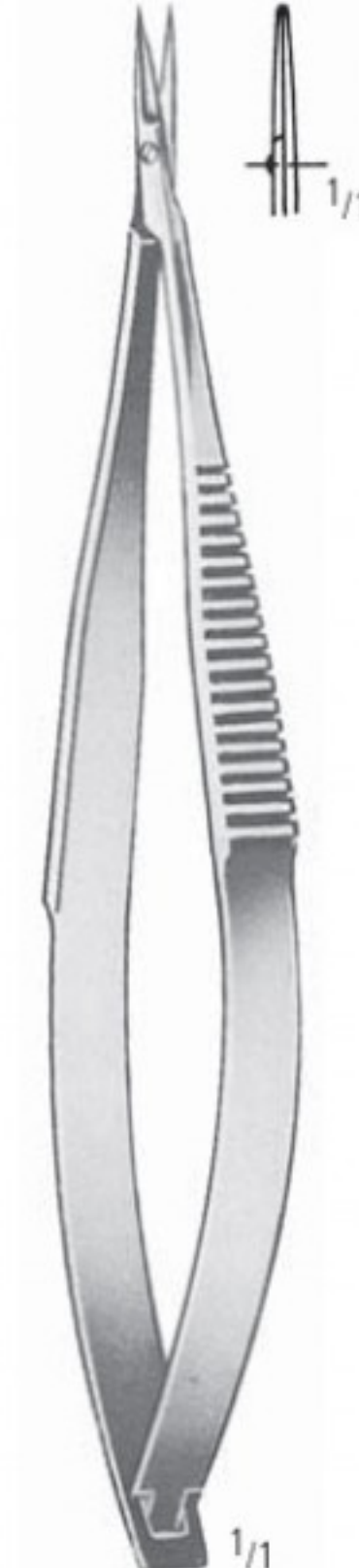

KATZIN
 AC 793/00
 10,0 cm/4"

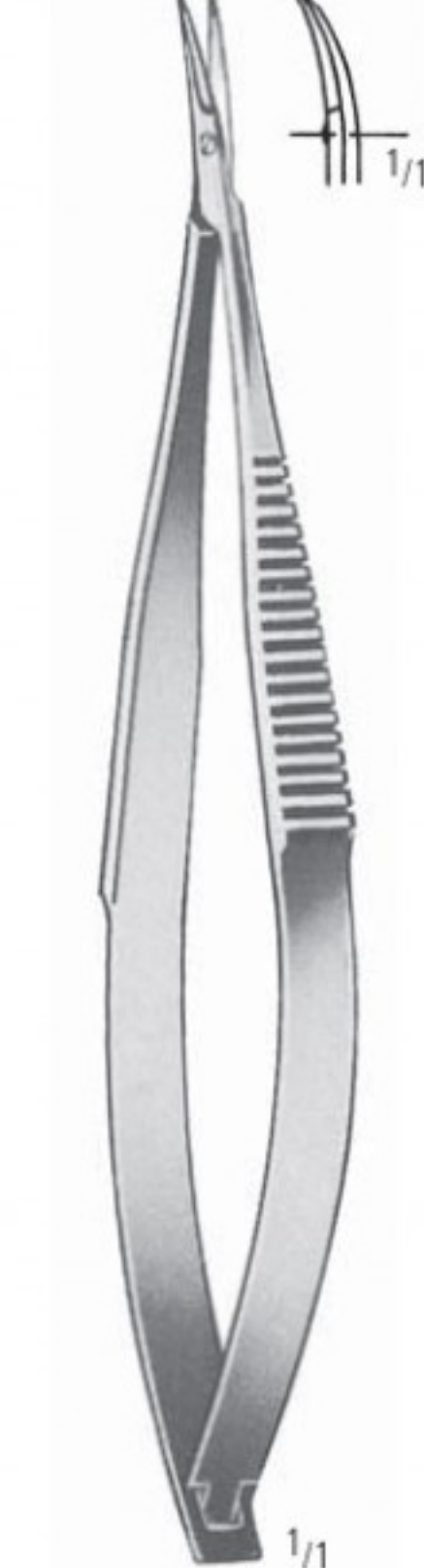

KATZIN
 AC 793/01
 10,0 cm/4"

SCHEREN SCISSORS TIJERAS CISEAUX FORBICI

Hornhautscheren, Mikroscheren
 Corneal Section Scissors, Micro Scissors
 Pinzas-tijeras para córnea, Micro Tijeras
 Pincers ciseaux corneales, Micro-ciseaux
 Forbici per cornea, Micro forbici

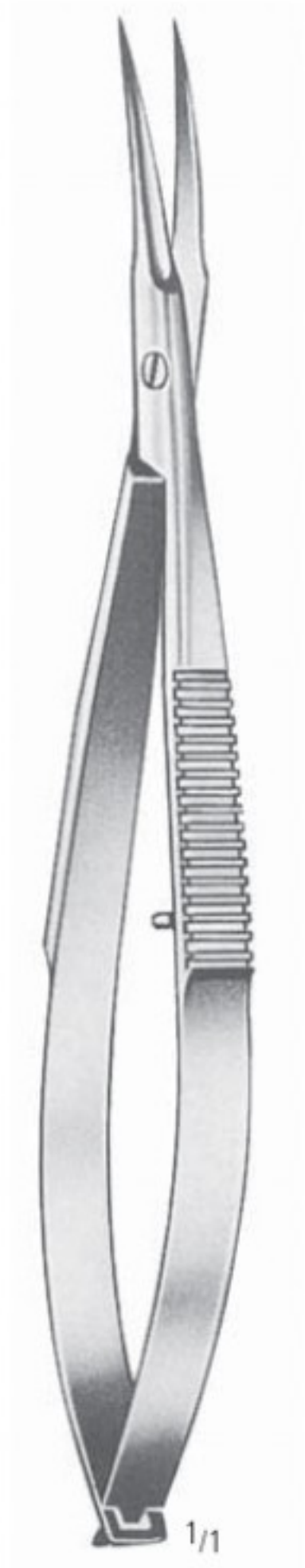

AC 794/12
 12,0 cm/4³/₄"



NOYES
 AC 795/15
 15,0 cm/6"



WESTCOTT
 AC 797/01
 11,5 cm/4¹/₂"

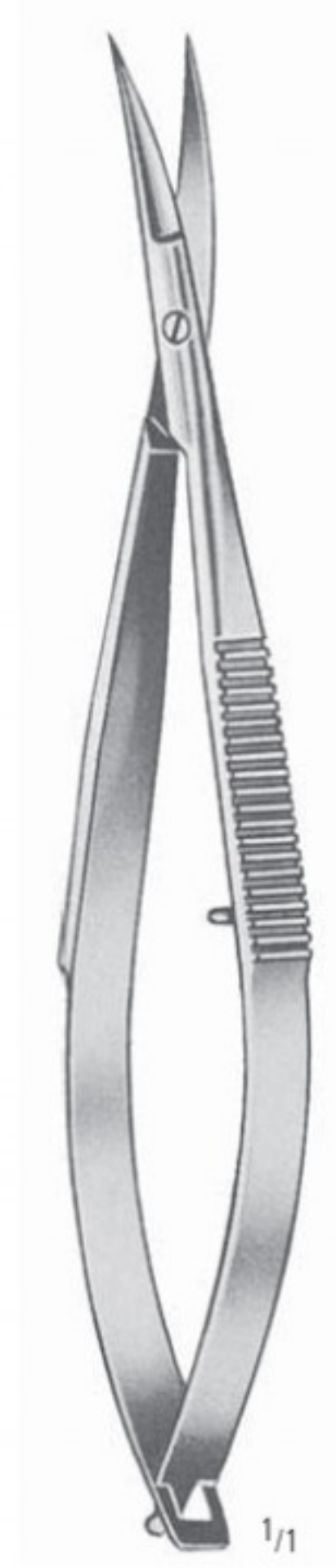

WESTCOTT
 AC 797/02
 11,5 cm/4¹/₂"

AA
 AB
AC
 AD
 AE
 AF
 AG
 AH
 AI
 AJ
 AK
 AL
 AM
 AN
 AO
 AP
 AQ
 AR
 AS
 AT
 AU
 AV
 AW
 AX
 AY
 AZ
 BA
 BB
 BC
 BD
 BE
 BF
 BG
 BH
 BI
 BJ
 BK
 BL
 BM
 BN
 BO
 BP
 BQ
 BR
 BS
 BT
 BU
 BV
 BW
 BX
 BY
 BZ
 CA
 CB
 CC
 CD
 CE
 CF
 CG
 CH
 CI
 CJ
 CK
 CL
 CM
 CN
 CO
 CP
 CQ
 CR
 CS
 CT
 CU
 CV
 CW
 CX
 CY
 CZ
 DA
 DB
 DC
 DD
 DE
 DF
 DG
 DH
 DI
 DJ
 DK
 DL
 DM
 DN
 DO
 DP
 DQ
 DR
 DS
 DT
 DU
 DV
 DW
 DX
 DY
 DZ
 EA
 EB
 EC
 ED
 EE
 EF
 EG
 EH
 EI
 EJ
 EK
 EL
 EM
 EN
 EO
 EP
 EQ
 ER
 ES
 ET
 EU
 EV
 EW
 EX
 EY
 EZ
 FA
 FB
 FC
 FD
 FE
 FF
 FG
 FH
 FI
 FJ
 FK
 FL
 FM
 FN
 FO
 FP
 FQ
 FR
 FS
 FT
 FU
 FV
 FW
 FX
 FY
 FZ
 GA
 GB
 GC
 GD
 GE
 GF
 GG
 GH
 GI
 GJ
 GK
 GL
 GM
 GN
 GO
 GP
 GQ
 GR
 GS
 GT
 GU
 GV
 GW
 GX
 GY
 GZ
 HA
 HB
 HC
 HD
 HE
 HF
 HG
 HH
 HI
 HJ
 HK
 HL
 HM
 HN
 HO
 HP
 HQ
 HR
 HS
 HT
 HU
 HV
 HW
 HX
 HY
 HZ
 IA
 IB
 IC
 ID
 IE
 IF
 IG
 IH
 II
 IJ
 IK
 IL
 IM
 IN
 IO
 IP
 IQ
 IR
 IS
 IT
 IU
 IV
 IW
 IX
 IY
 IZ
 JA
 JB
 JC
 JD
 JE
 JF
 JG
 JH
 JI
 JJ
 JK
 JL
 JM
 JN
 JO
 JP
 JQ
 JR
 JS
 JT
 JU
 JV
 JW
 JX
 JY
 JZ
 KA
 KB
 KC
 KD
 KE
 KF
 KG
 KH
 KI
 KJ
 KK
 KL
 KM
 KN
 KO
 KP
 KQ
 KR
 KS
 KT
 KU
 KV
 KW
 KX
 KY
 KZ
 LA
 LB
 LC
 LD
 LE
 LF
 LG
 LH
 LI
 LJ
 LK
 LL
 LM
 LN
 LO
 LP
 LQ
 LR
 LS
 LT
 LU
 LV
 LW
 LX
 LY
 LZ
 MA
 MB
 MC
 MD
 ME
 MF
 MG
 MH
 MI
 MJ
 MK
 ML
 MM
 MN
 MO
 MP
 MQ
 MR
 MS
 MT
 MU
 MV
 MW
 MX
 MY
 MZ
 NA
 NB
 NC
 ND
 NE
 NF
 NG
 NH
 NI
 NJ
 NK
 NL
 NM
 NN
 NO
 NP
 NQ
 NR
 NS
 NT
 NU
 NV
 NW
 NX
 NY
 NZ
 OA
 OB
 OC
 OD
 OE
 OF
 OG
 OH
 OI
 OJ
 OK
 OL
 OM
 ON
 OO
 OP
 OQ
 OR
 OS
 OT
 OU
 OV
 OW
 OX
 OY
 OZ
 PA
 PB
 PC
 PD
 PE
 PF
 PG
 PH
 PI
 PJ
 PK
 PL
 PM
 PN
 PO
 PP
 PQ
 PR
 PS
 PT
 PU
 PV
 PW
 PX
 PY
 PZ
 QA
 QB
 QC
 QD
 QE
 QF
 QG
 QH
 QI
 QJ
 QK
 QL
 QM
 QN
 QO
 QP
 QQ
 QR
 QS
 QT
 QU
 QV
 QW
 QX
 QY
 QZ
 RA
 RB
 RC
 RD
 RE
 RF
 RG
 RH
 RI
 RJ
 RK
 RL
 RM
 RN
 RO
 RP
 RQ
 RR
 RS
 RT
 RU
 RV
 RW
 RX
 RY
 RZ
 SA
 SB
 SC
 SD
 SE
 SF
 SG
 SH
 SI
 SJ
 SK
 SL
 SM
 SN
 SO
 SP
 SQ
 SR
 SS
 ST
 SU
 SV
 SW
 SX
 SY
 SZ
 TA
 TB
 TC
 TD
 TE
 TF
 TG
 TH
 TI
 TJ
 TK
 TL
 TM
 TN
 TO
 TP
 TQ
 TR
 TS
 TT
 TU
 TV
 TW
 TX
 TY
 TZ
 UA
 UB
 UC
 UD
 UE
 UF
 UG
 UH
 UI
 UJ
 UK
 UL
 UM
 UN
 UO
 UP
 UQ
 UR
 US
 UT
 UY
 UZ
 VA
 VB
 VC
 VD
 VE
 VF
 VG
 VH
 VI
 VJ
 VK
 VL
 VM
 VN
 VO
 VP
 VQ
 VR
 VS
 VT
 VU
 VV
 VW
 VX
 VY
 VZ
 WA
 WB
 WC
 WD
 WE
 WF
 WG
 WH
 WI
 WJ
 WK
 WL
 WM
 WN
 WO
 WP
 WQ
 WR
 WS
 WT
 WU
 WV
 WW
 WX
 WY
 WZ
 XA
 XB
 XC
 XD
 XE
 XF
 XG
 XH
 XI
 XJ
 XK
 XL
 XM
 XN
 XO
 XP
 XQ
 XR
 XS
 XT
 XU
 XV
 XW
 XX
 XY
 XZ
 YA
 YB
 YC
 YD
 YE
 YF
 YG
 YH
 YI
 YJ
 YK
 YL
 YM
 YN
 YO
 YP
 YQ
 YR
 YS
 YT
 YU
 YV
 YW
 YX
 YZ
 ZA
 ZB
 ZC
 ZD
 ZE
 ZF
 ZG
 ZH
 ZI
 ZJ
 ZK
 ZL
 ZM
 ZN
 ZO
 ZP
 ZQ
 ZR
 ZS
 ZT
 ZU
 ZV
 ZW
 ZX
 ZY
 ZZ

Mikroscheren
Micro Scissors
Micro Tijeras
Micro Ciseaux
Micro Forbici

- >> Alle unsere Mikroscheren werden von Fachkräften mit jahrelanger Erfahrung hergestellt. Die Endkontrolle findet unter dem Mikroskop statt. Um Ihnen ein ermüdungsfreies Arbeiten zu ermöglichen, wird dem Federdruck größte Aufmerksamkeit gewidmet.
- >> Bitte wählen Sie unter Rund- oder Flachgriffscheren.

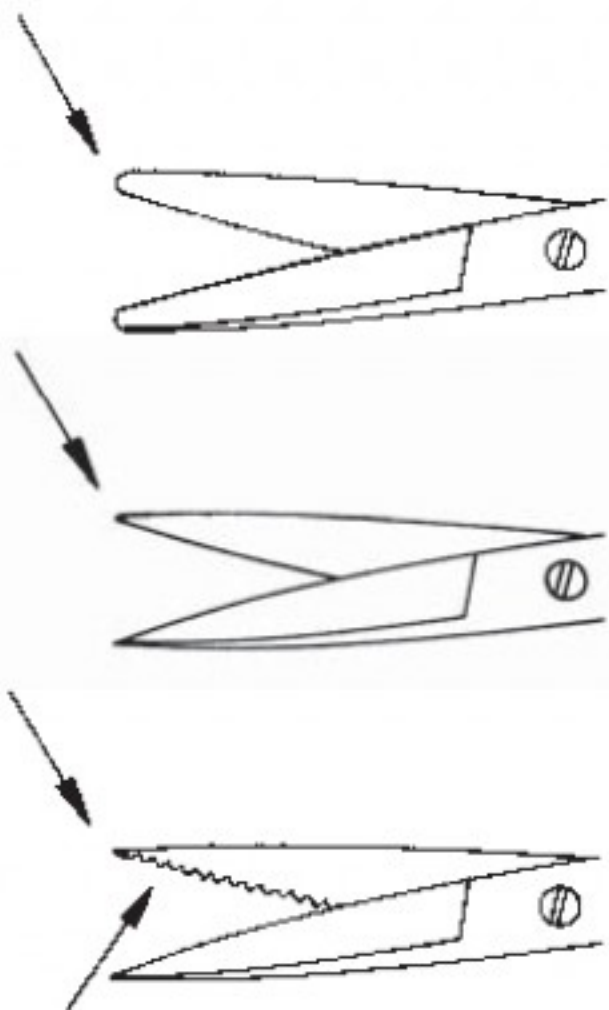

Dissection: **Gebogene Blätter, abgerundete Spitzen** ermöglichen eine gute und sichere Dissektion, ohne Nerven und Blutgefäße zu beschädigen.

Adventitia: **Gerade Blätter, sehr scharfe Spitzen** gewährleisten präzises Anfrischen von Gefäßenden.

Nerve: Ein Blatt ist **fein gezahnt**, um ein Herausgleiten des Nervs zu vermeiden.

- >> All our Micro Scissors are manufactured by skilled craftsmen with many years of experience. Final inspection is carried out under a microscope. Careful attention is paid to the closing pressure of the spring handle, to ensure precise work during surgeries, without fatigue.
- >> Round or flat handle scissors according to your preference.

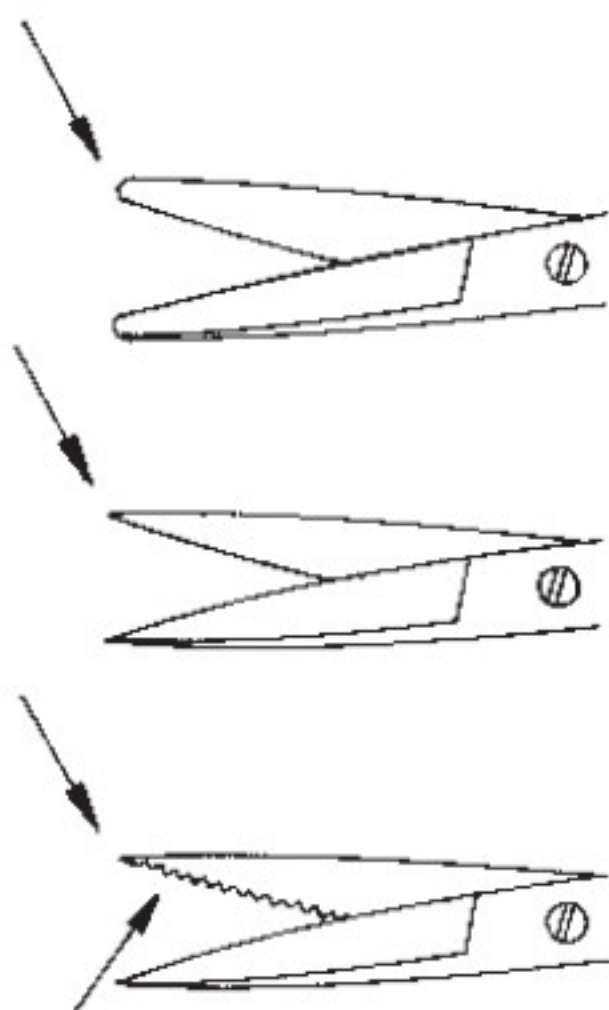

Dissection: **Curved blades, slightly rounded tips** ensure safe dissection without damage to nerves and vessels.

Adventitia: **Straight blades, very sharp tips** for finest trimming of vessel ends.

Nerve: One blade is **fine-toothed** to avoid slipping of the nerve.

SCHEREN SCISSORS TIJERAS CISEAUX FORBICI

Mikroscheren
Micro Scissors
Micro Tijeras
Micro Ciseaux
Micro Forbici

AA

AB

AC

AD

AE

AF

AK

AL

AM

AO

AP

AR

KA

KB

KC

KD

KU

KY

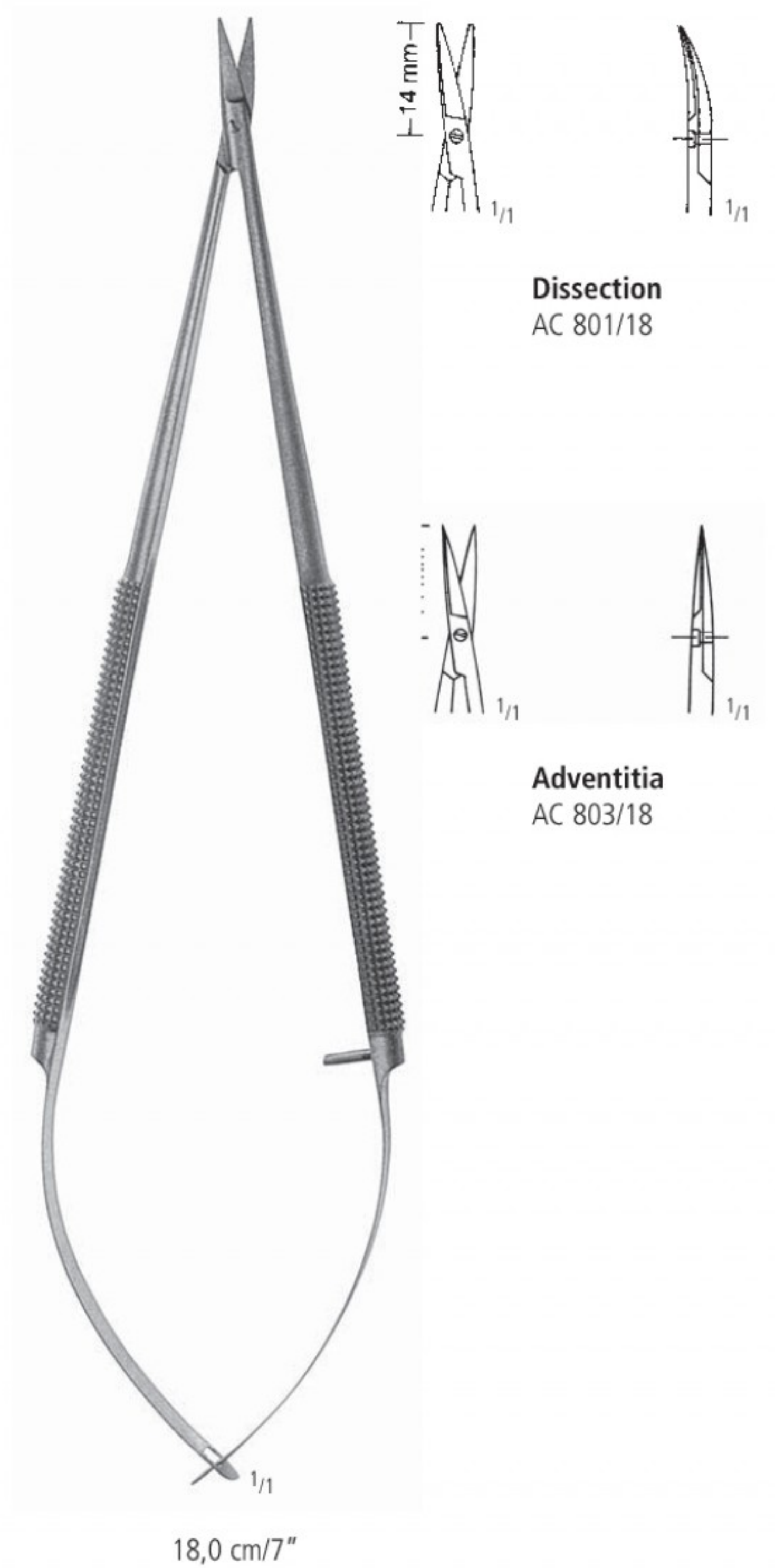
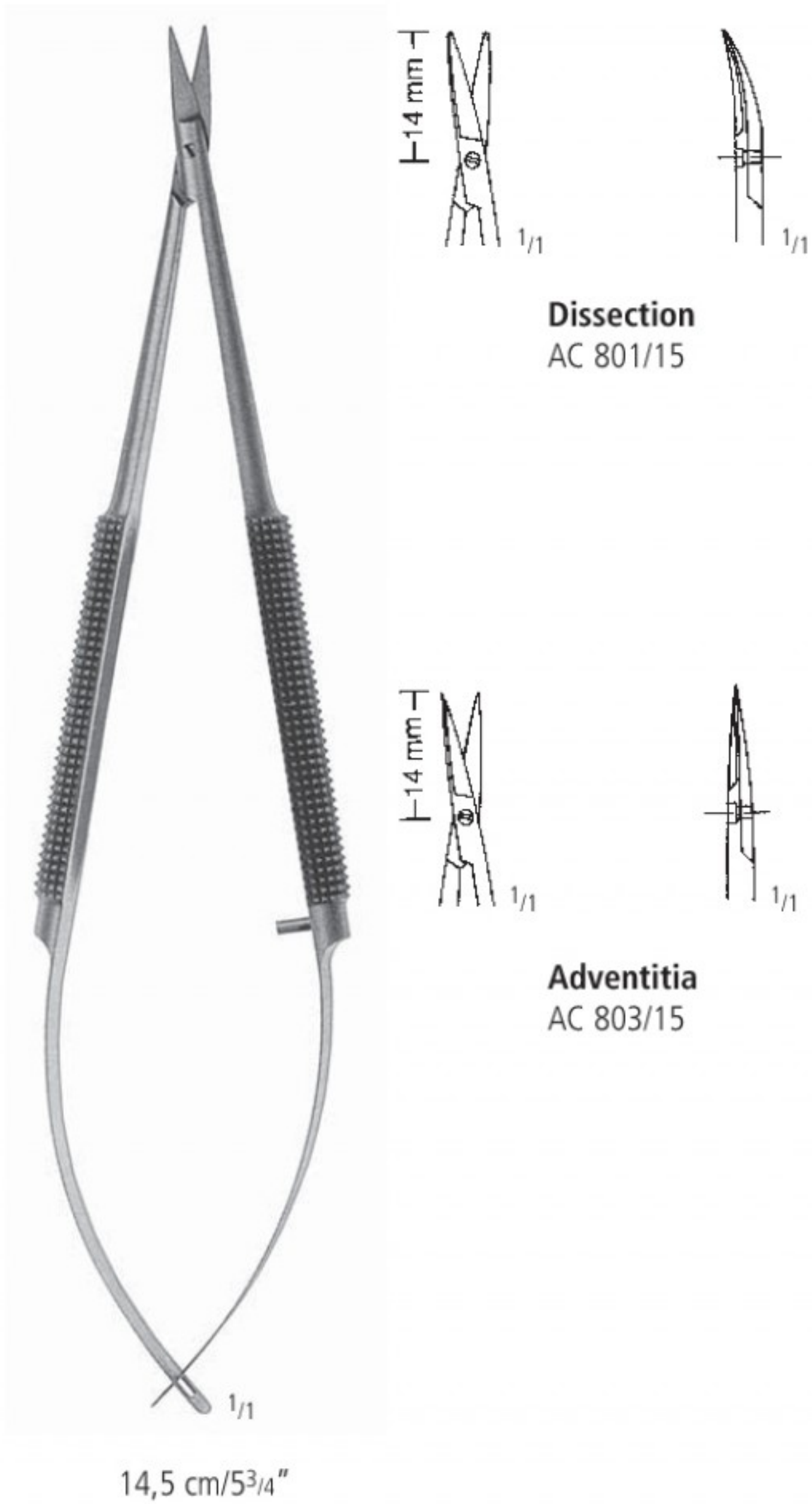

Mikroscheren
 Micro Scissors
 Micro Tijeras
 Micro Ciseaux
 Micro Forbici



AC 807/14
 14,5 cm/5³/₄"



AC 812/18
 18,0 cm/7"



AC 817/18
 18,0 cm/7"

SCHEREN SCISSORS TIJERAS CISEAUX FORBICI

Mikroscheren
Micro Scissors
Micro Tijeras
Micro Ciseaux
Micro Forbici

AA
AB
AC
AD
AE
AF
AK
AL
AM
AO
AP
AR
KA
KB
KC
KD
KU
KY



11,0 cm/4¹/₃"

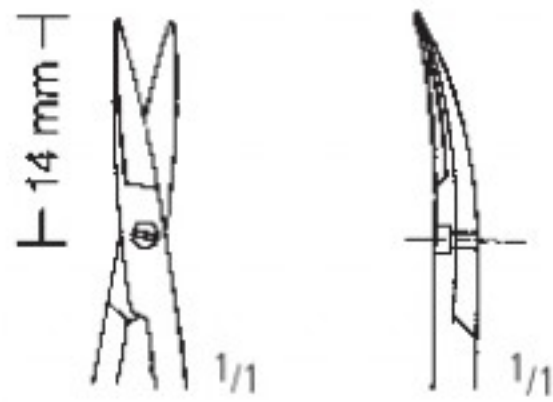

Dissection
AC 821/11

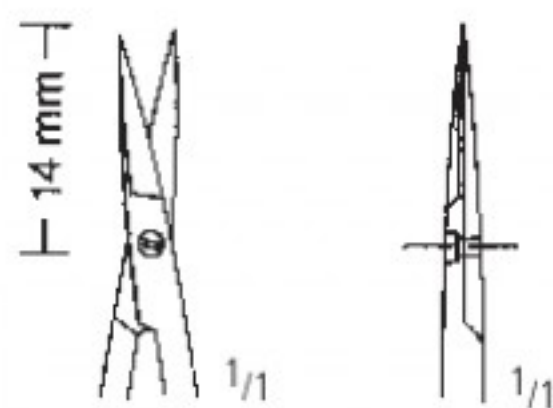

Adventitia
AC 830/11

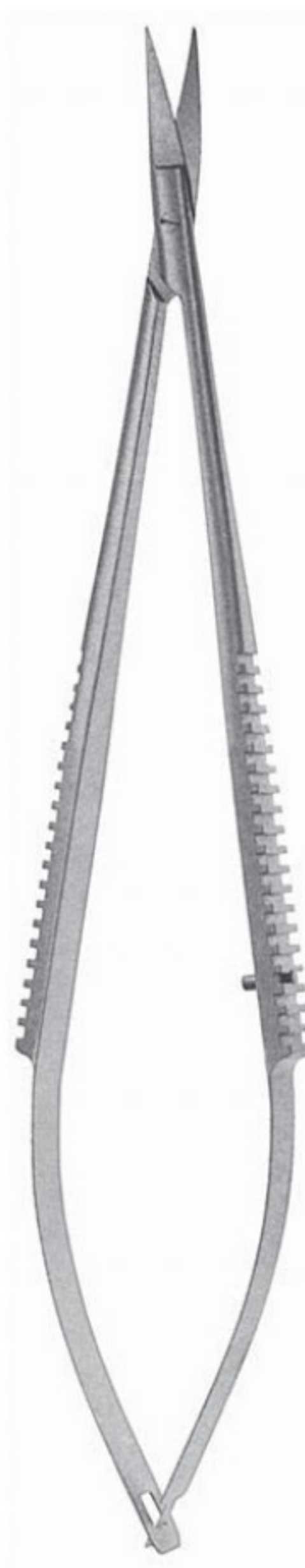

15,0 cm/6"

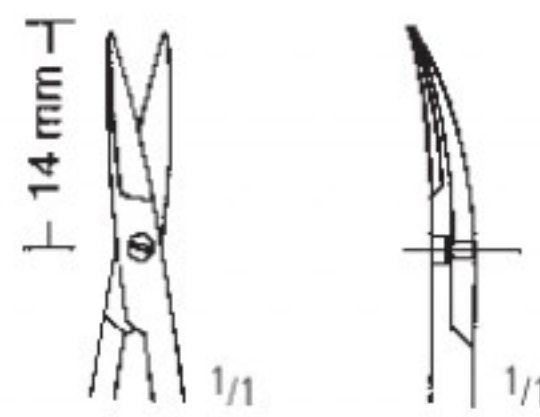

Dissection
AC 823/15

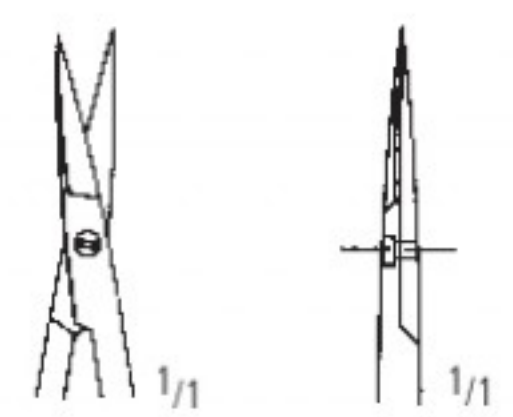

Adventitia
AC 832/15

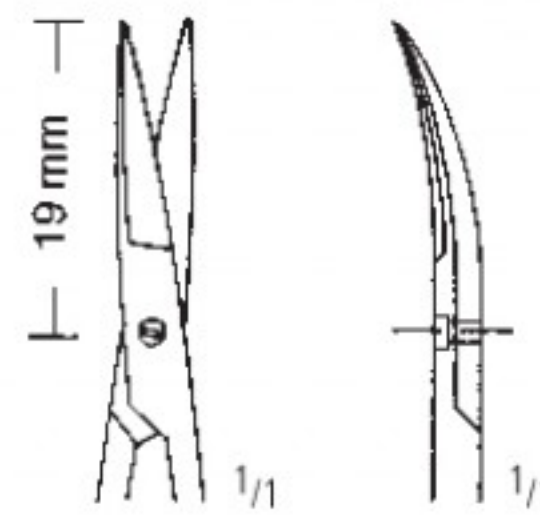

Dissection
AC 825/15

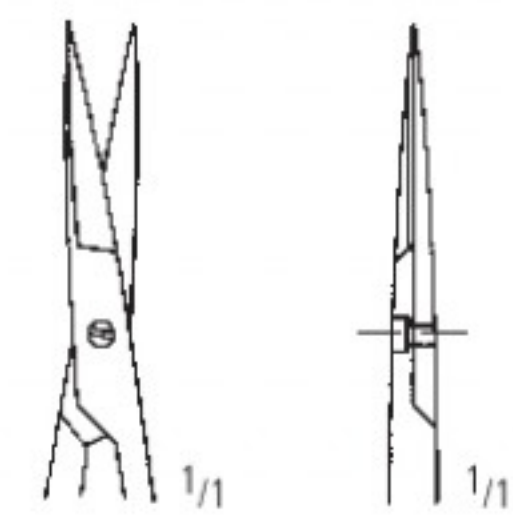

Adventitia
AC 834/15

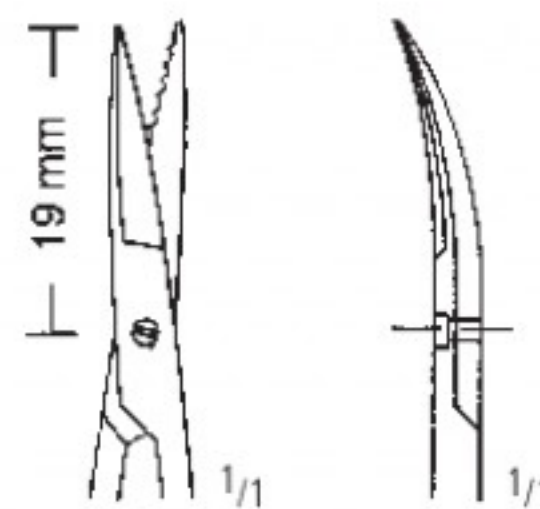

Dissection >> Nerve >> Adventitia
AC 827/15

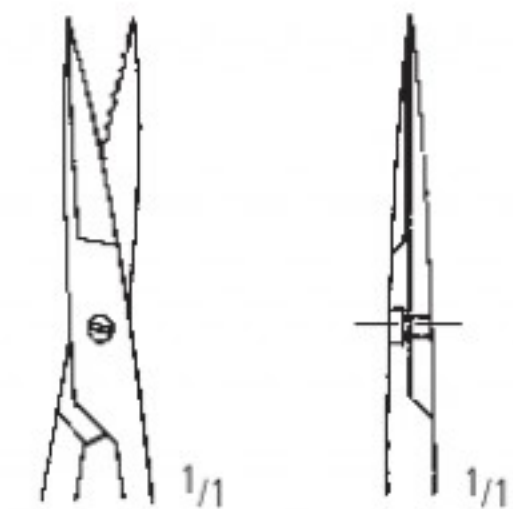

Adventitia
AC 836/15

AC SCHEREN SCISSORS TIJERAS CISEAUX FORBICI

Mikroscheren
Micro Scissors
Micro Tijeras
Micro Ciseaux
Micro Forbici

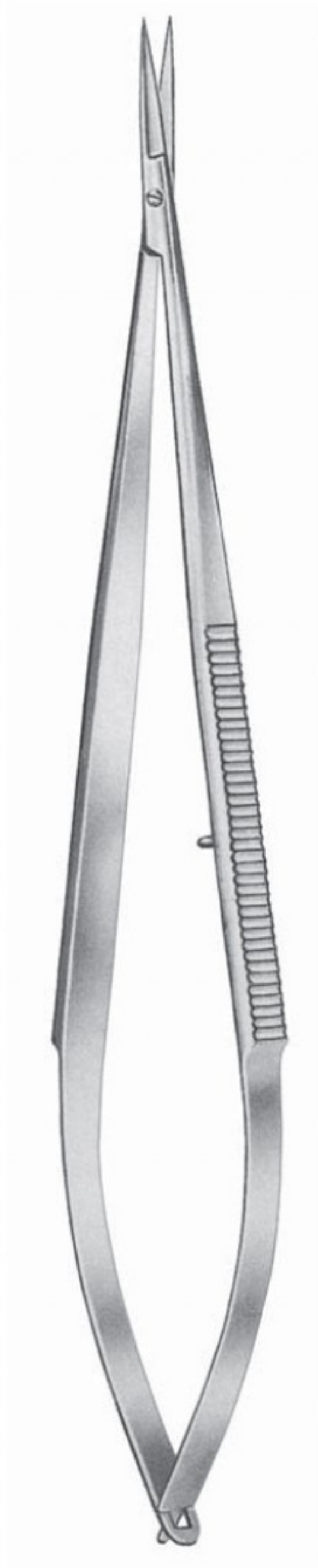

18,5 cm/7¹/₃"



AC 850/19



AC 851/19



16,0 cm/6¹/₄"
20,0 cm/8"
22,5 cm/9"



AC 860/16
AC 860/20
AC 860/22



AC 861/16
AC 861/20
AC 861/22



AC 862/16
AC 862/20
AC 862/22



AC 863/16
AC 863/20
AC 863/22



AC 864/16
AC 864/20
AC 864/22



AC 865/16
AC 865/20
AC 865/22

SCHEREN SCISSORS TIJERAS CISEAUX FORBICI

Mikroscheren
Micro Scissors
Micro Tijeras
Micro Ciseaux
Micro Forbici

AA
AB
AC
AD
AE
AF
AK
AL
AM
AO
AP
AR
KA
KB
KC
KD
KU
KY



18,0 cm/7"

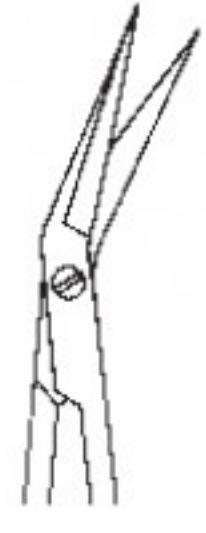

AC 870/01
25°

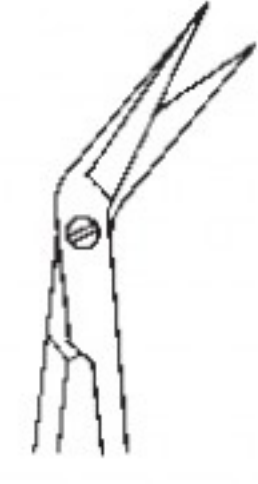

AC 870/02
45°

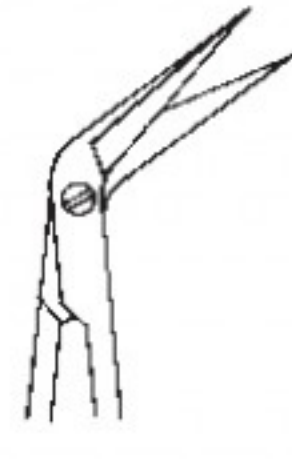

AC 870/03
60°



AC 870/04
90°

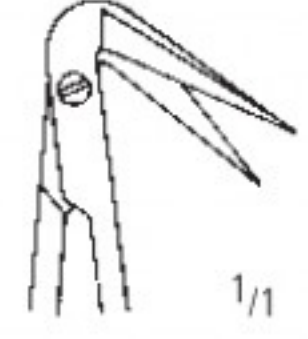

AC 870/05
125°



18,0 cm/7"



AC 871/01
25°



AC 871/02
45°

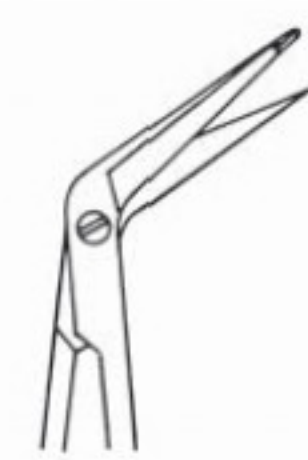

AC 871/03
60°



AC 871/04
90°

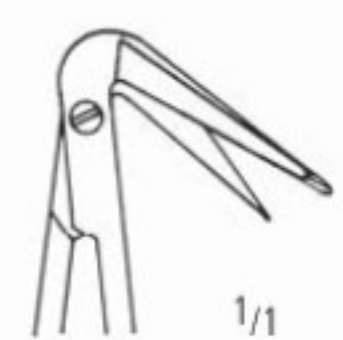

AC 871/05
125°



nopa® TUC®

SC Super Cut

SUPER CUT TUC



Besonderheit:

Nutzen Sie die Vorteile von Hartmetalleinsätzen.

nopa TUC Super Cut Scheren haben eine rasierklingscharfe Schneide, kombiniert mit einer mikrogezahnten Schneide.

>> Diese Scheren sind durch schwarz/goldene Ringe gekennzeichnet.

Features:

Use the advantages of Tungsten Carbide.

nopa TUC Super Cut scissors have a razor-like edge combined with one micro serrated blade.

>> Black/golden rings for easy identification.

Verfügbare Modelle / Available Patterns

Im Katalog durch * markiert. / Marked in catalog with *.

AC 902/14	SC	STANDARD SCS TUC STR.	SH/BL 14,5 CM	SC
AC 903/14	SC	STANDARD SCS TUC CVD.	SH/BL 14,5 CM	SC
AC 910/14	SC	MAYO DISS. SCS TUC STR.	BL/BL 14,5 CM	SC
AC 910/17	SC	MAYO DISS. SCS TUC STR.	BL/BL 17,0 CM	SC
AC 911/14	SC	MAYO DISS. SCS TUC CVD.	BL/BL 14,5 CM	SC
AC 911/17	SC	MAYO DISS. SCS TUC CVD.	BL/BL 17,0 CM	SC
AC 916/15	SC	MAYO-STILLE SCS TUC STR.	BL/BL 15,0 CM	SC
AC 916/17	SC	MAYO-STILLE SCS TUC STR.	BL/BL 17,0 CM	SC
AC 917/15	SC	MAYO-STILLE SCS TUC CVD.	BL/BL 15,0 CM	SC
AC 917/17	SC	MAYO-STILLE SCS TUC CVD.	BL/BL 17,0 CM	SC
AC 930/14	SC	METZENBAUM SCS TUC STR.	BL/BL 14,5 CM	SC
AC 931/14	SC	METZENBAUM SCS TUC CVD.	BL/BL 14,5 CM	SC
AC 940/18	SC	METZENBAUM SCS TUC STR.	BL/BL 18,0 CM	SC
AC 940/20	SC	METZENBAUM SCS TUC STR.	BL/BL 20,0 CM	SC
AC 941/18	SC	METZENBAUM SCS TUC CVD.	BL/BL 18,0 CM	SC
AC 941/20	SC	METZENBAUM SCS TUC CVD.	BL/BL 20,0 CM	SC
AC 941/23	SC	METZENBAUM SCS TUC CVD.	BL/BL 23,0 CM	SC
AC 941/25	SC	METZENBAUM SCS TUC CVD.	BL/BL 25,0 CM	SC
AC 941/28	SC	METZENBAUM SCS TUC CVD.	BL/BL 28,0 CM	SC
AC 960/14	SC	METZENBAUM-DEL. SCS TUC STR.	BL/BL 14,5 CM	SC
AC 961/14	SC	METZENBAUM-DEL. SCS TUC CVD.	BL/BL 14,5 CM	SC
AC 970/18	SC	METZENBAUM-DEL. SCS TUC STR.	BL/BL 18,0 CM	SC
AC 970/20	SC	METZENBAUM-DEL. SCS TUC STR.	BL/BL 20,0 CM	SC
AC 971/18	SC	METZENBAUM-DEL. SCS TUC CVD.	BL/BL 18,0 CM	SC
AC 971/20	SC	METZENBAUM-DEL. SCS TUC CVD.	BL/BL 20,0 CM	SC
AC 974/11	SC	STEVENS TENOTOMY SCS STR.	POINTED 11,5 CM	SC
AC 975/11	SC	STEVENS TENOTOMY SCS CVD.	POINTED 11,5 CM	SC
AC 984/11	SC	IRIS SCS TUC STR.	SH/SH 11,5 CM	SC
AC 985/11	SC	IRIS SCS TUC CVD.	SH/SH 11,5 CM	SC

Scheren mit Hartmetalleinlagen
 Scissors with Tungsten Carbide Inserts
 Tijeras con filos de carburo de tungsteno
 Ciseaux avec plaquettes en carbure de tungstène
 Forbici con taglio al carburo di tungsteno

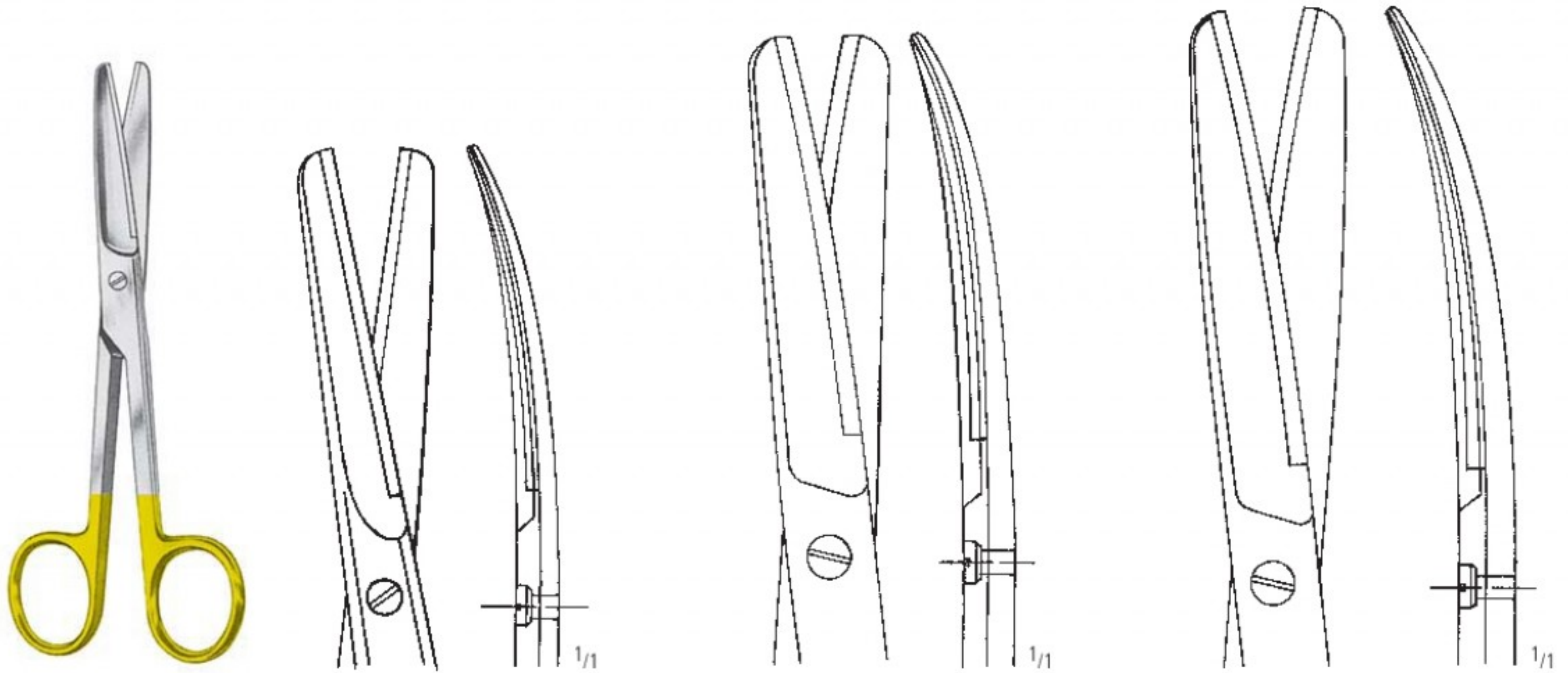

STANDARD
 Fig. 1

14,5 cm/5³/₄"
 straight: AC 900/14
 curved: AC 901/14

16,5 cm/6¹/₂"
 AC 900/16
 AC 901/16

18,5 cm/7¹/₃"
 AC 900/18
 AC 901/18

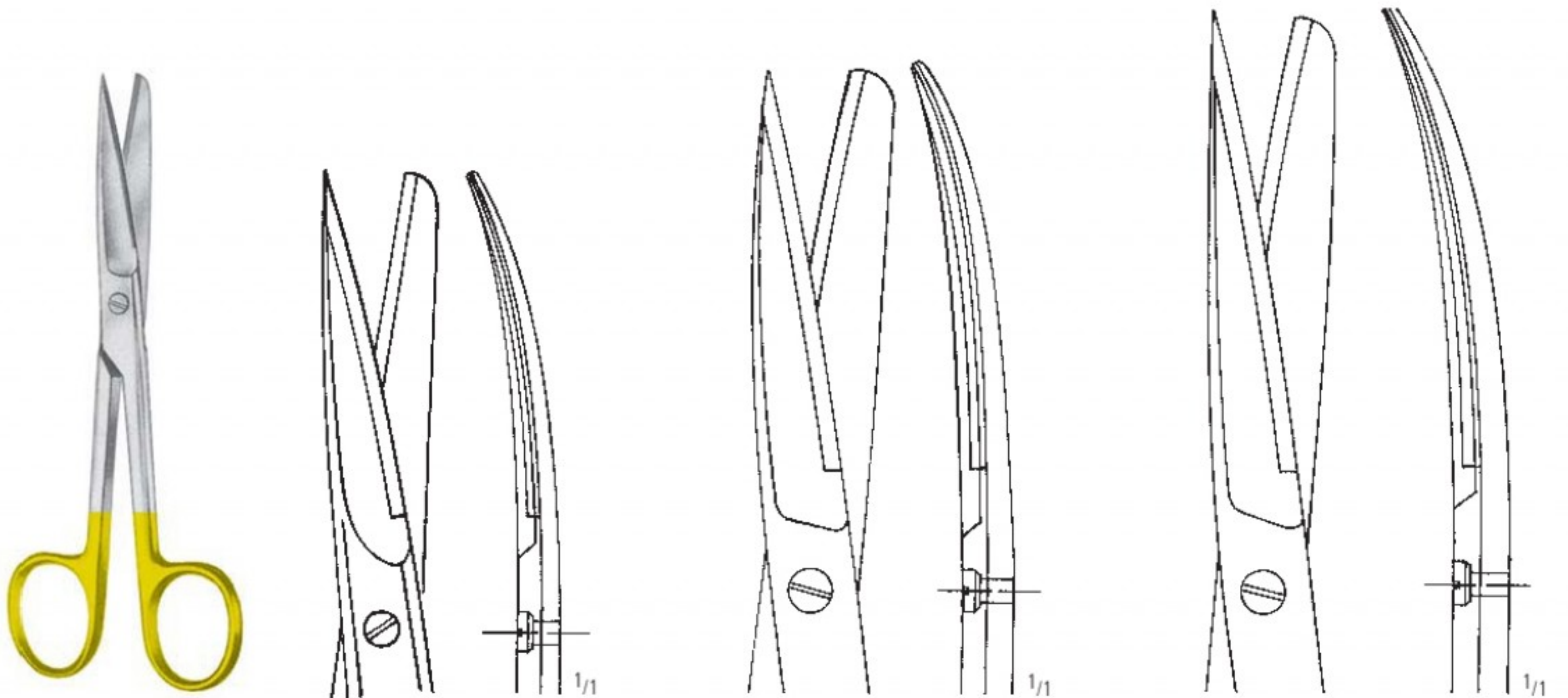

STANDARD
 Fig. 2

14,5 cm/5³/₄"
 straight: AC 902/14*
 curved: AC 903/14*

16,5 cm/6¹/₂"
 AC 902/16
 AC 903/16

18,5 cm/7¹/₃"
 AC 902/18
 AC 903/18

SCHEREN SCISSORS TIJERAS CISEAUX FORBICI

Scheren mit Hartmetalleinlagen
 Scissors with Tungsten Carbide Inserts
 Tijeras con filos de carburo de tungsteno
 Ciseaux avec plaquettes en carbure de tungstène
 Forbici con taglio al carburo di tungsteno

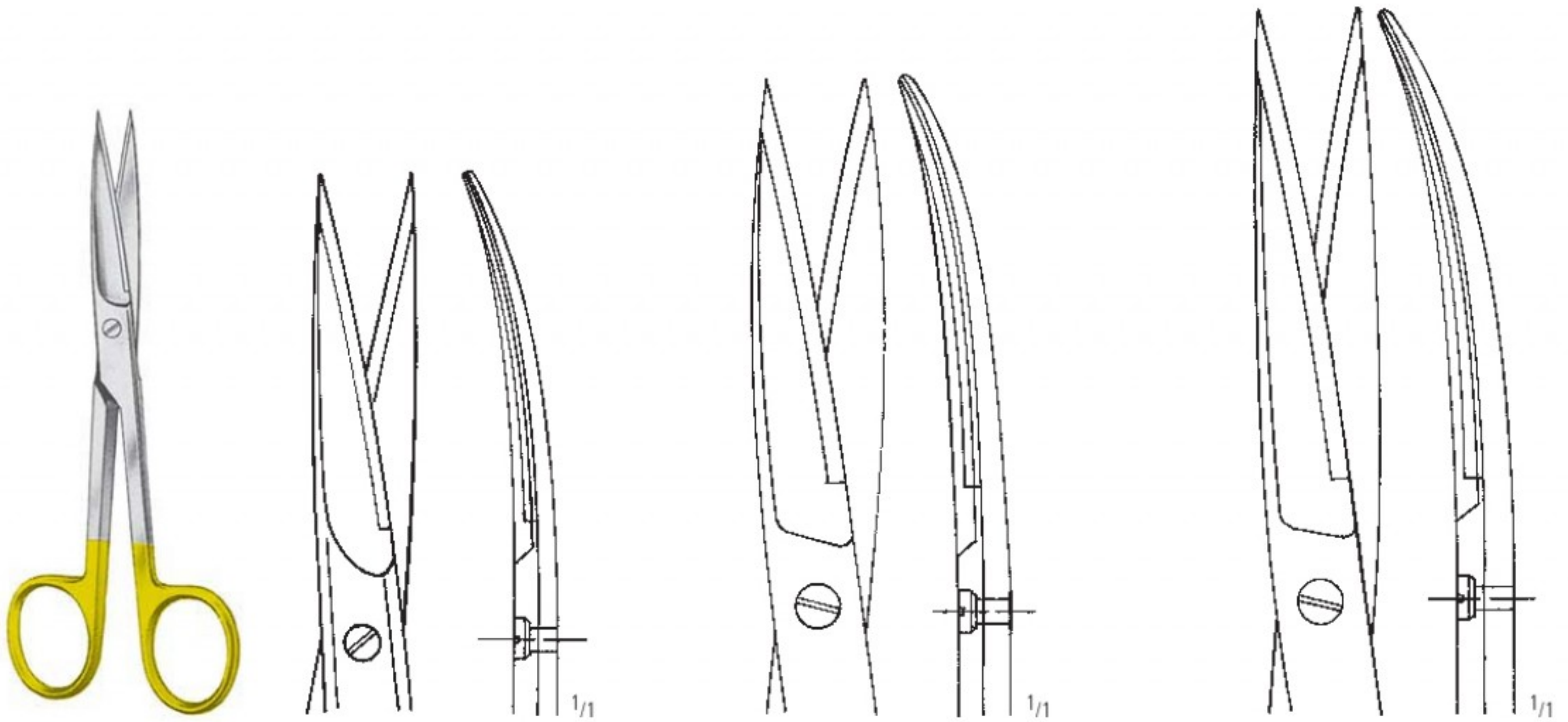

STANDARD
 Fig. 3

14,5 cm/5³/₄"
 straight: AC 904/14
 curved: AC 905/14

16,5 cm/6¹/₂"
 AC 904/16
 AC 905/16

18,5 cm/7¹/₃"
 AC 904/18
 AC 905/18

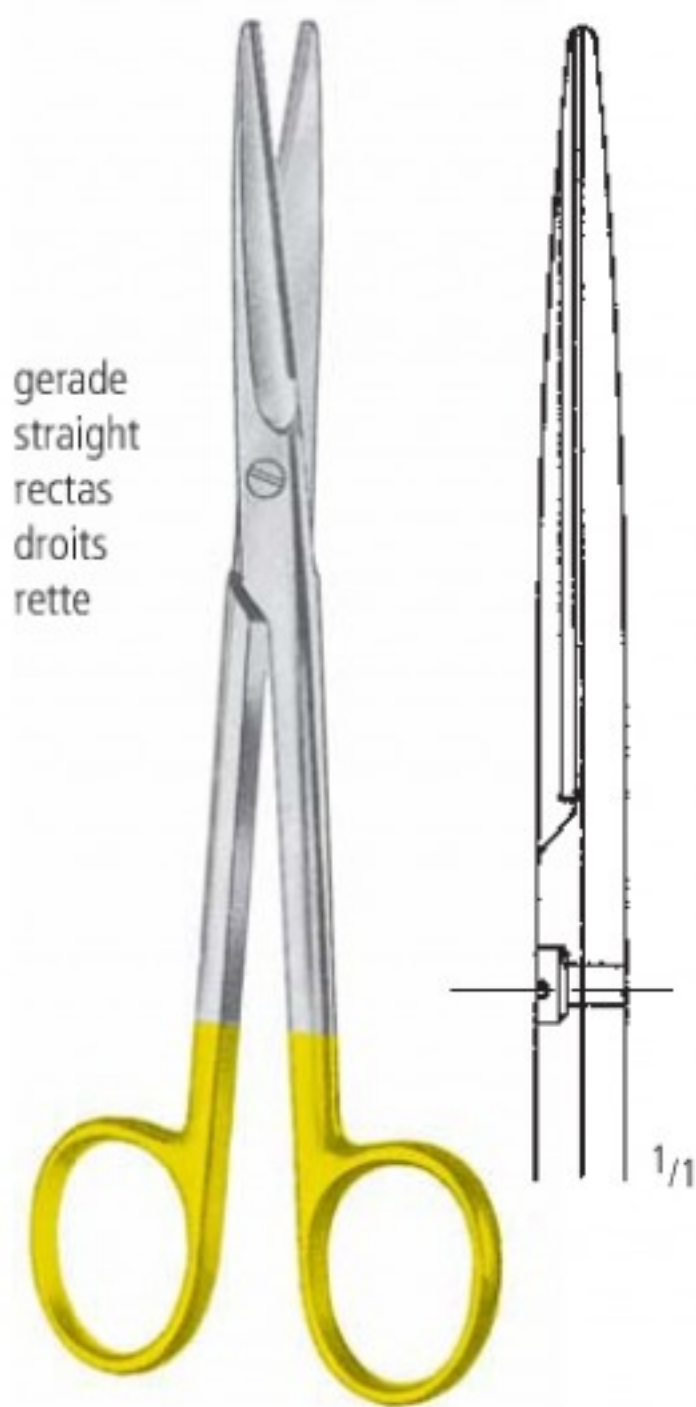

gerade
 straight
 rectas
 droits
 rette

MAYO
 AC 910/14*
 AC 910/17*
 AC 910/23

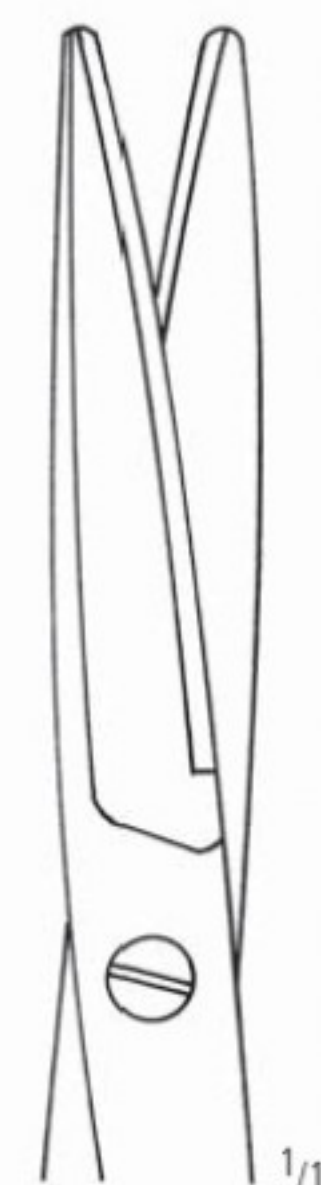

Original 17,0 cm

14,5 cm/5¹/₂"
 17,0 cm/6³/₄"
 23,0 cm/9"



gebogen
 curved
 curvas
 courbes
 curve



MAYO
 AC 911/14*
 AC 911/17*
 AC 911/23

AA
 AB
 AC
 AD
 AE
 AF
 AG
 AH
 AI
 AJ
 AK
 AL
 AM
 AN
 AO
 AP
 AQ
 AR
 AS
 AT
 AU
 AV
 AW
 AX
 AY
 AZ

AC SCHEREN SCISSORS TIJERAS CISEAUX FORBICI

Scheren mit Hartmetalleinlagen
 Scissors with Tungsten Carbide Inserts
 Tijeras con filos de carburo de tungsteno
 Ciseaux avec plaquettes en carbure de tungstène
 Forbici con taglio al carburo di tungsteno



PARAMETRIUM

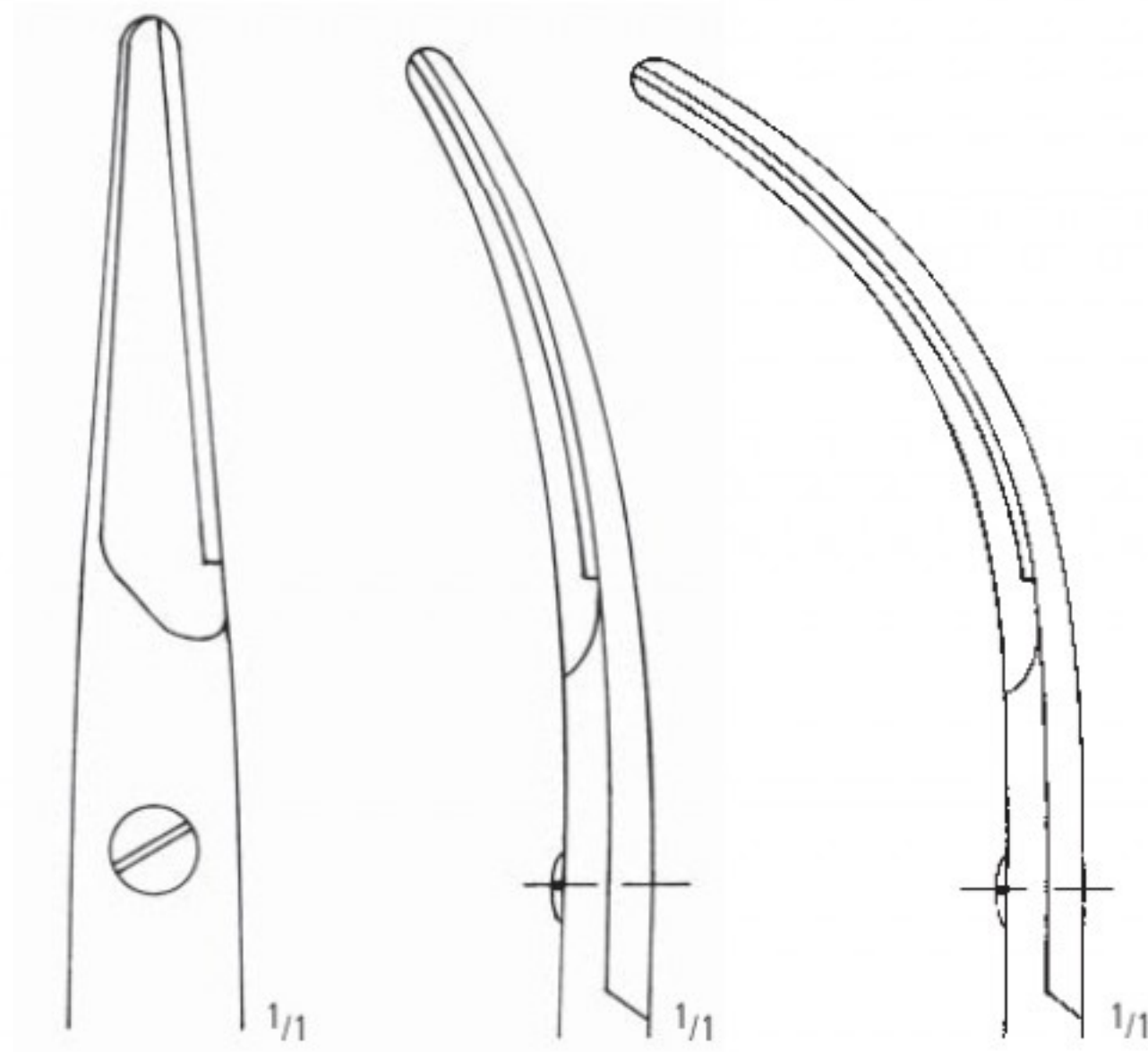

AC 915/01
22,5 cm/9"

AC 915/02
23,0 cm/9"



MAYO-STILLE
 AC 916/15*
 AC 916/17*

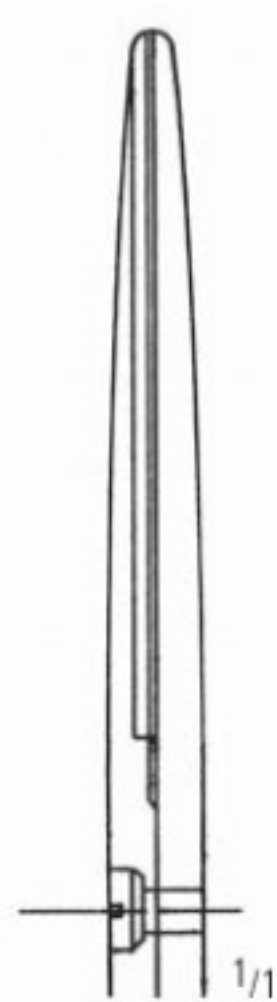

Original 17,0 cm

15,0 cm/6"
 17,0 cm/6³/₄"



MAYO-STILLE
 AC 917/15*
 AC 917/17*

SCHEREN SCISSORS TIJERAS CISEAUX FORBICI

Scheren mit Hartmetalleinlagen
 Scissors with Tungsten Carbide Inserts
 Tijeras con filos de carburo de tungsteno
 Ciseaux avec plaquettes en carbure de tungstène
 Forbici con taglio al carburo di tungsteno

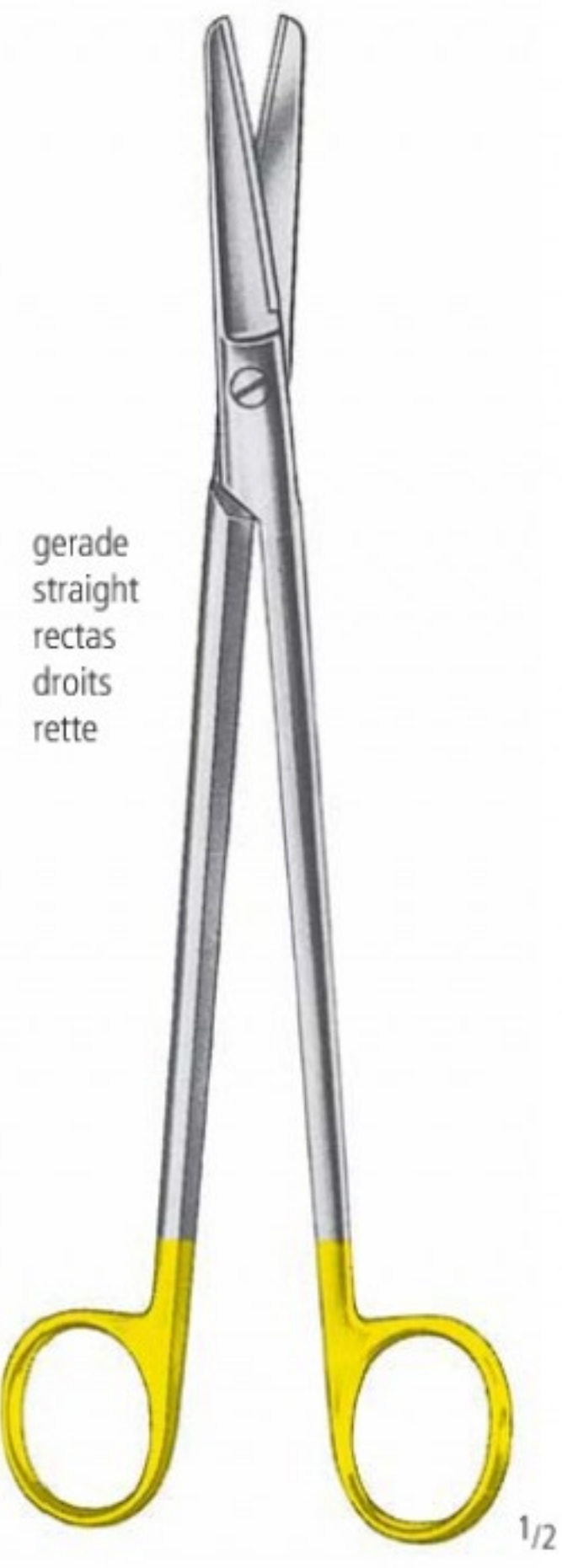

gerade
 straight
 rectas
 droits
 rette

SIMS
 AC 918/23
 23,0 cm/9"

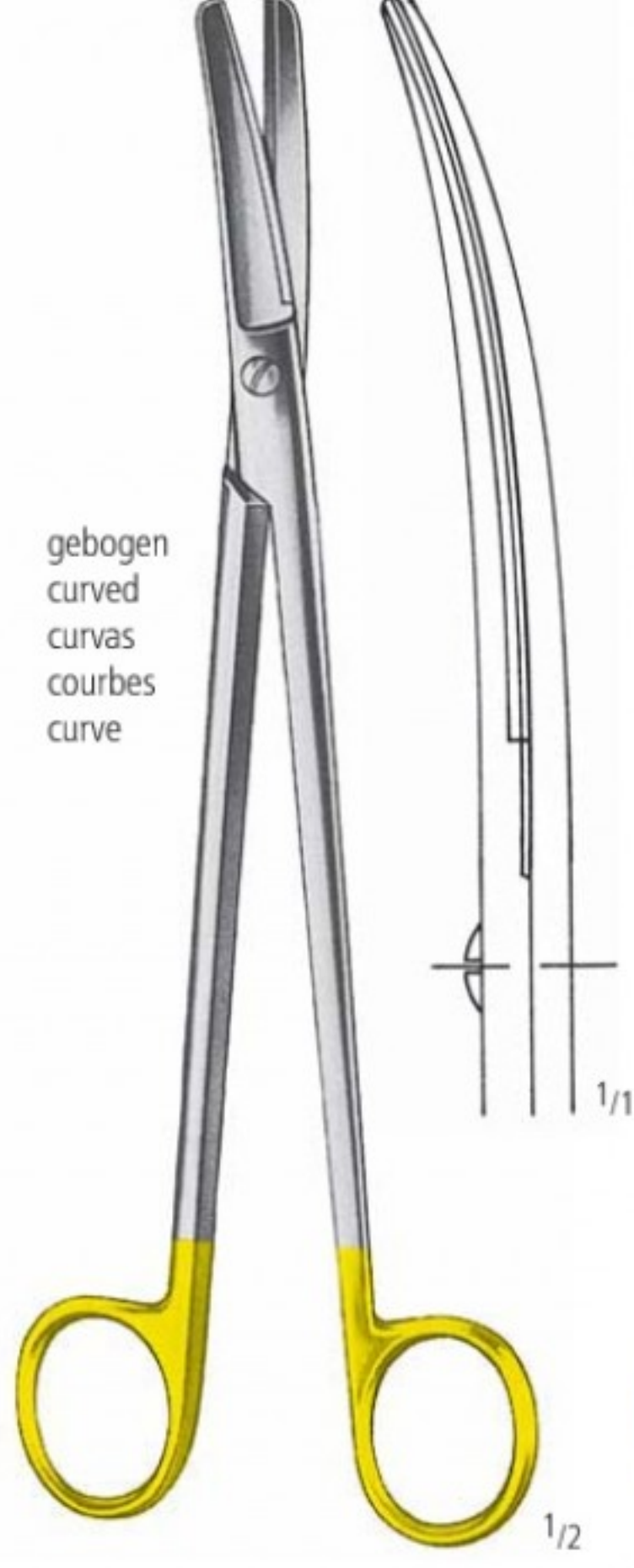

gebogen
 curved
 curvas
 courbes
 curve

SIMS
 AC 919/23
 23,0 cm/9"



AC 920/20
 20,0 cm/8"

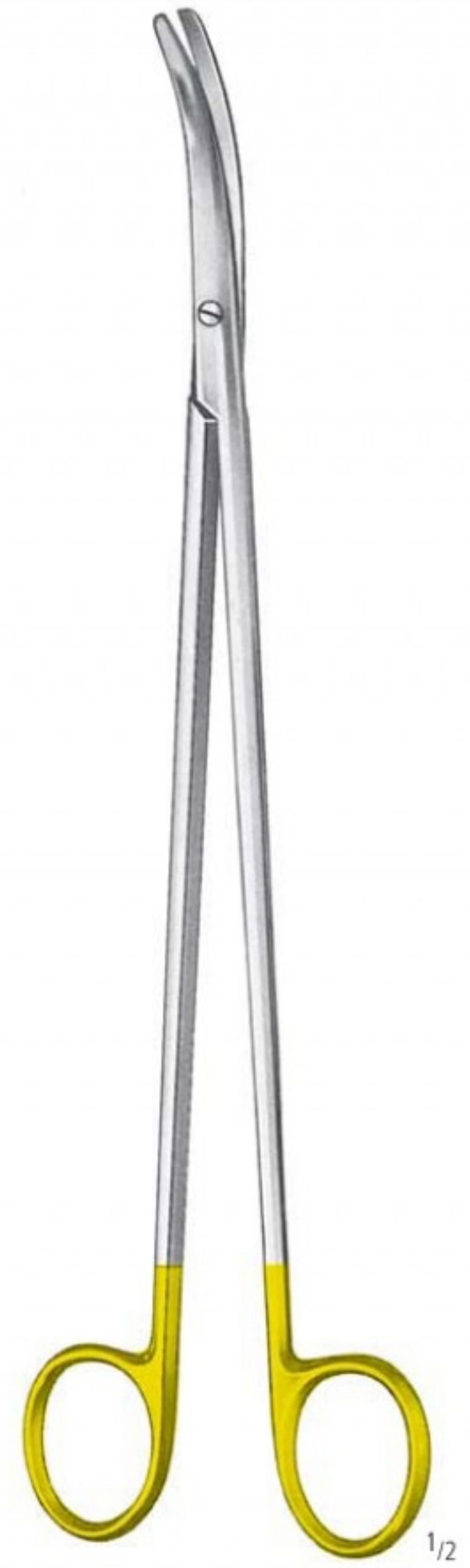

CARDINALE
 AC 921/28
 28,0 cm/11"

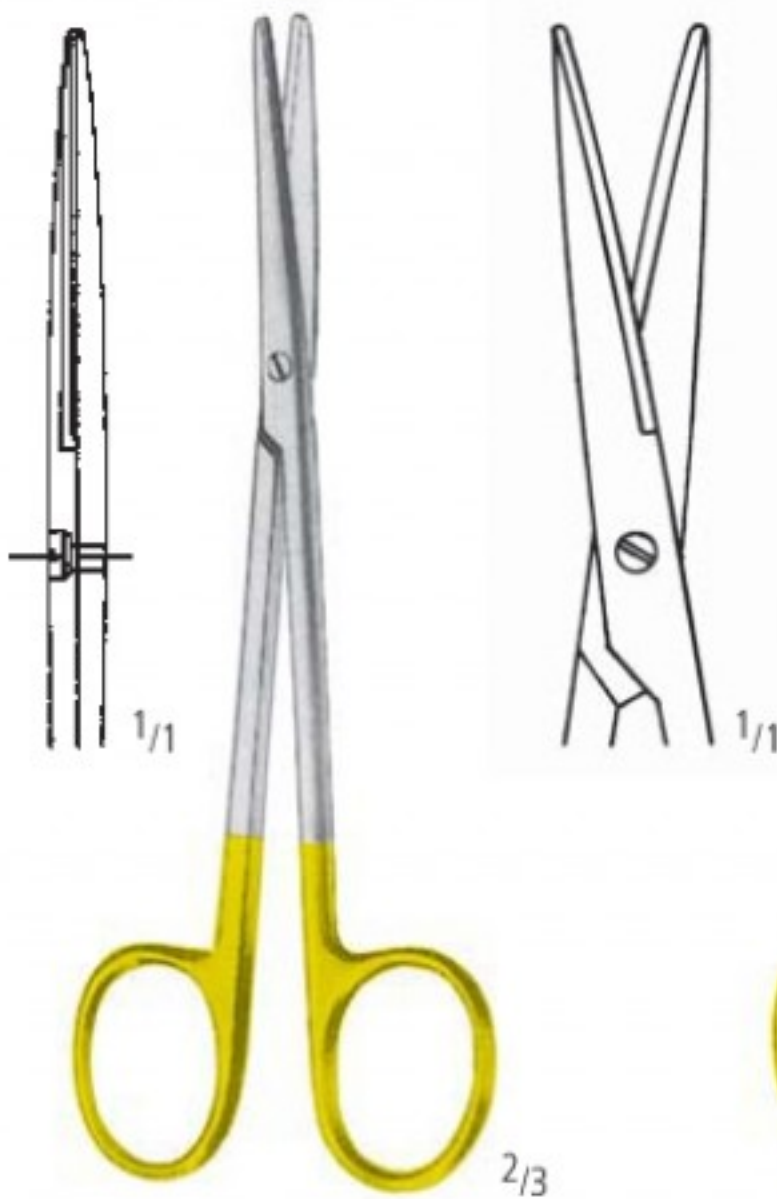

METZENBAUM
 AC 922/11
 11,5 cm/4 1/2"

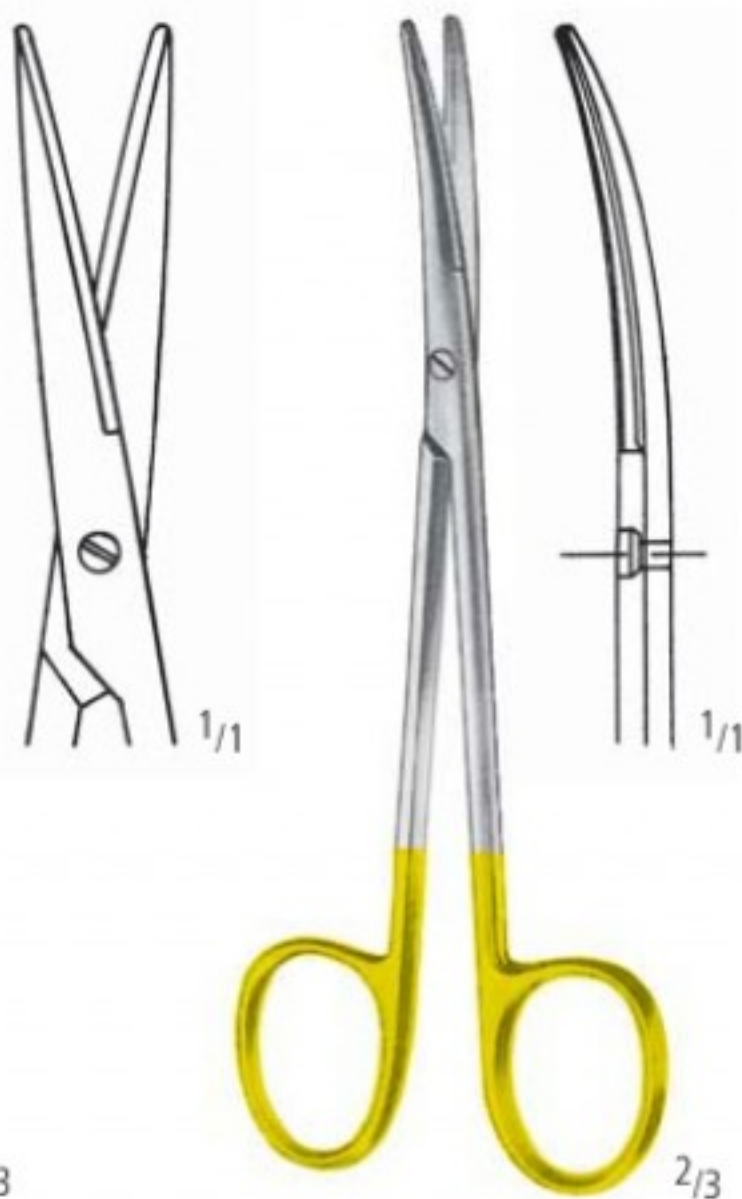

METZENBAUM
 AC 923/11
 11,5 cm/4 1/2"



METZENBAUM
 AC 930/14*
 14,5 cm/5 3/4"



METZENBAUM
 AC 931/14*
 14,5 cm/5 3/4"

* Auch erhältlich als SC * Also available as SC

AA
 AB
 AC
 AD
 AE
 AF
 AG
 AH
 AI
 AJ
 AK
 AL
 AM
 AN
 AO
 AP
 AQ
 AR
 AS
 AT
 AU
 AV
 AW
 AX
 AY
 AZ

AC SCHEREN SCISSORS TIJERAS CISEAUX FORBICI

Scheren mit Hartmetalleinlagen
 Scissors with Tungsten Carbide Inserts
 Tijeras con filos de carburo de tungsteno
 Ciseaux avec plaquettes en carbure de tungstène
 Forbici con taglio al carburo di tungsteno

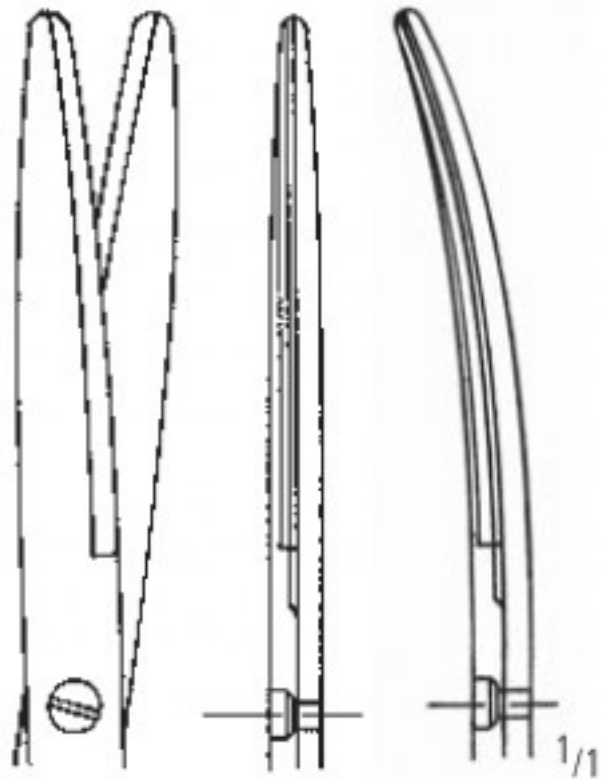

Original 18,0 cm

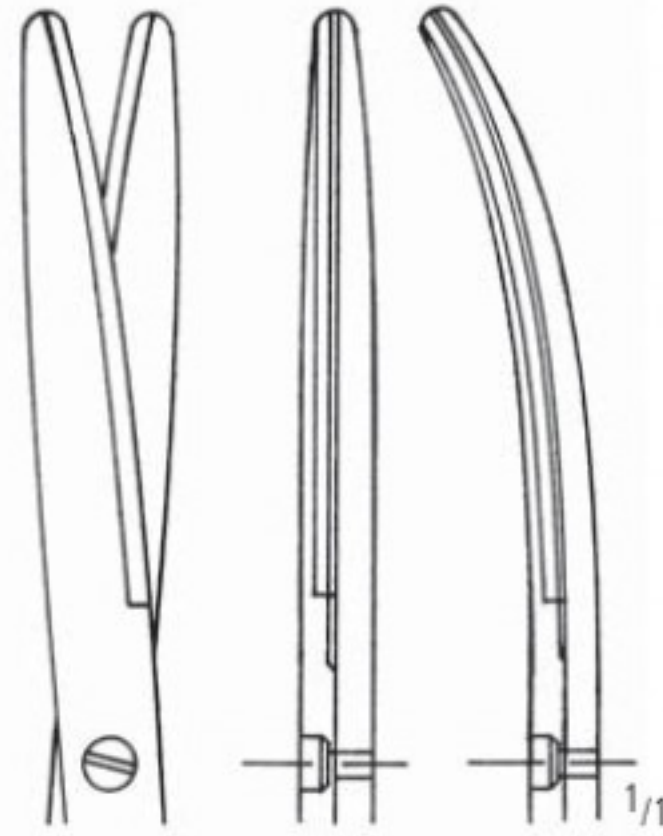

Original 20,0 cm

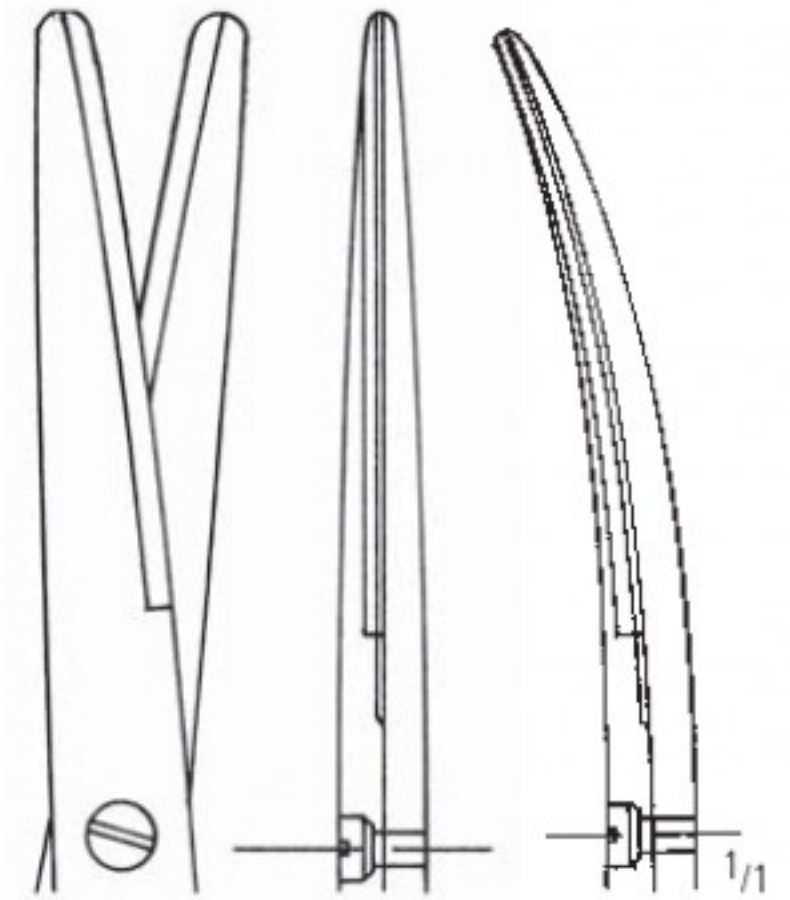

Original 23,0 cm



nopa
TUC[®]

gerade
 straight
 rectas
 droits
 rette

gebogen
 curved
 curvas
 courbes
 curve

AC 940/18*	18,0 cm/7"	AC 941/18*
AC 940/20*	20,0 cm/8"	AC 941/20*
AC 940/23	23,0 cm/9"	AC 941/23*
AC 940/25	25,0 cm/10"	AC 941/25*
AC 940/28	28,0 cm/11"	AC 941/28*
AC 940/30	30,0 cm/12"	AC 941/30

METZENBAUM

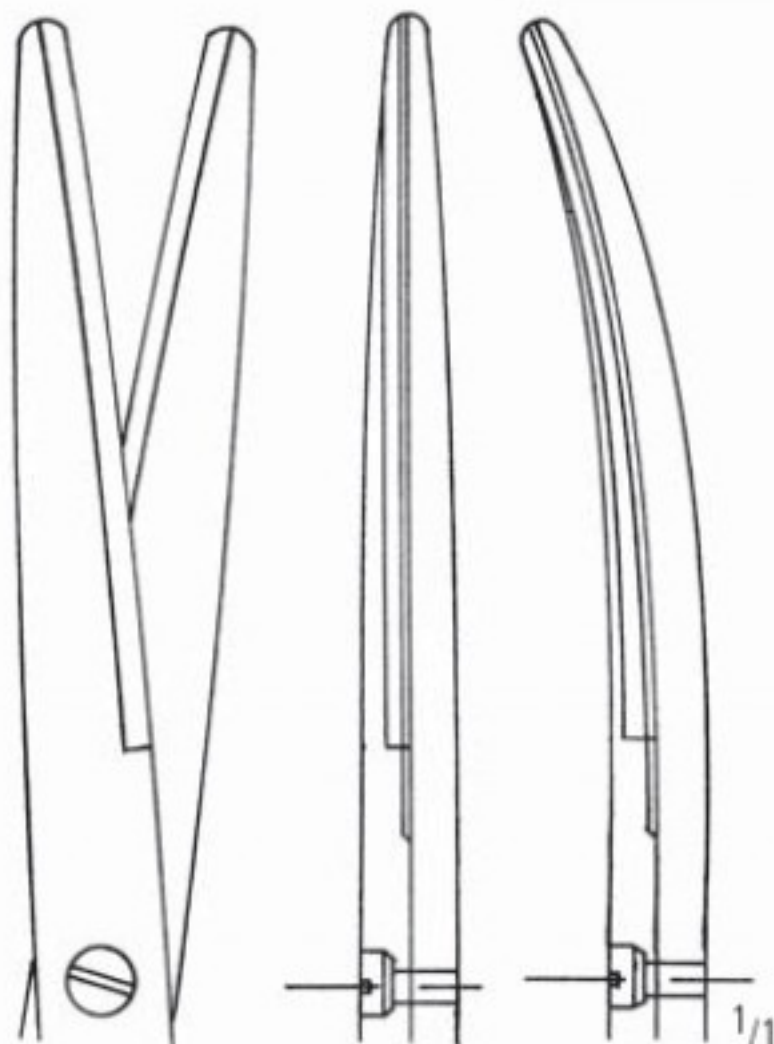

Original 25,0 cm

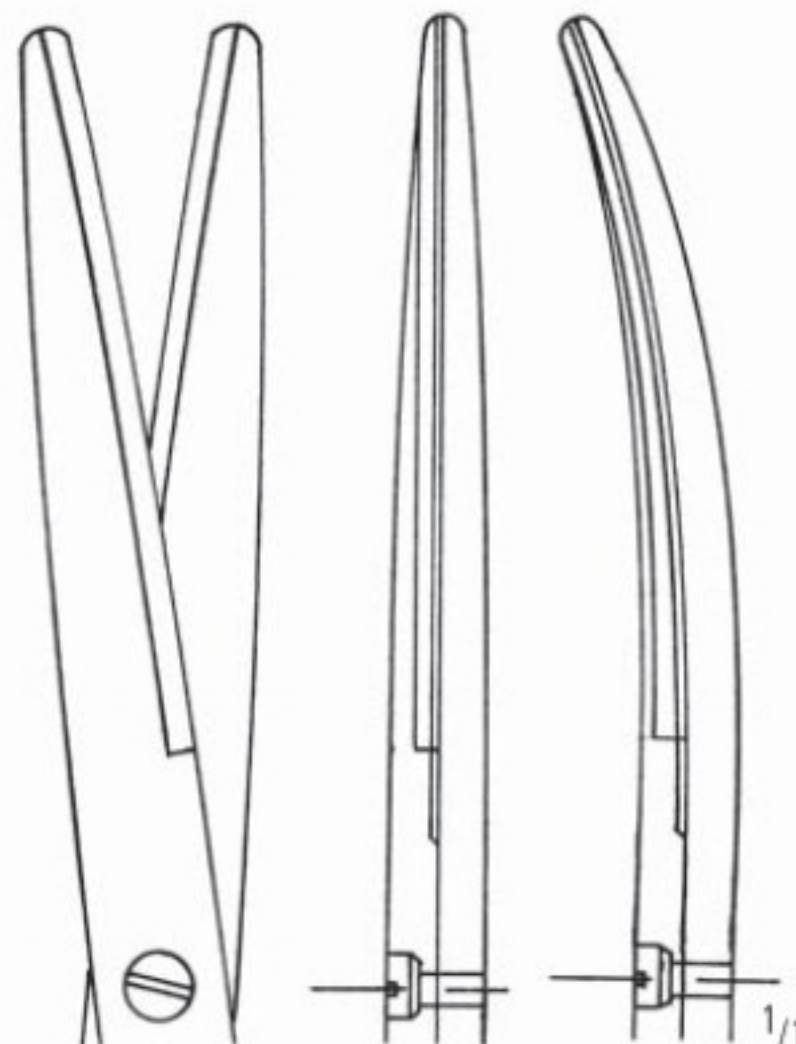

Original 28,0 cm

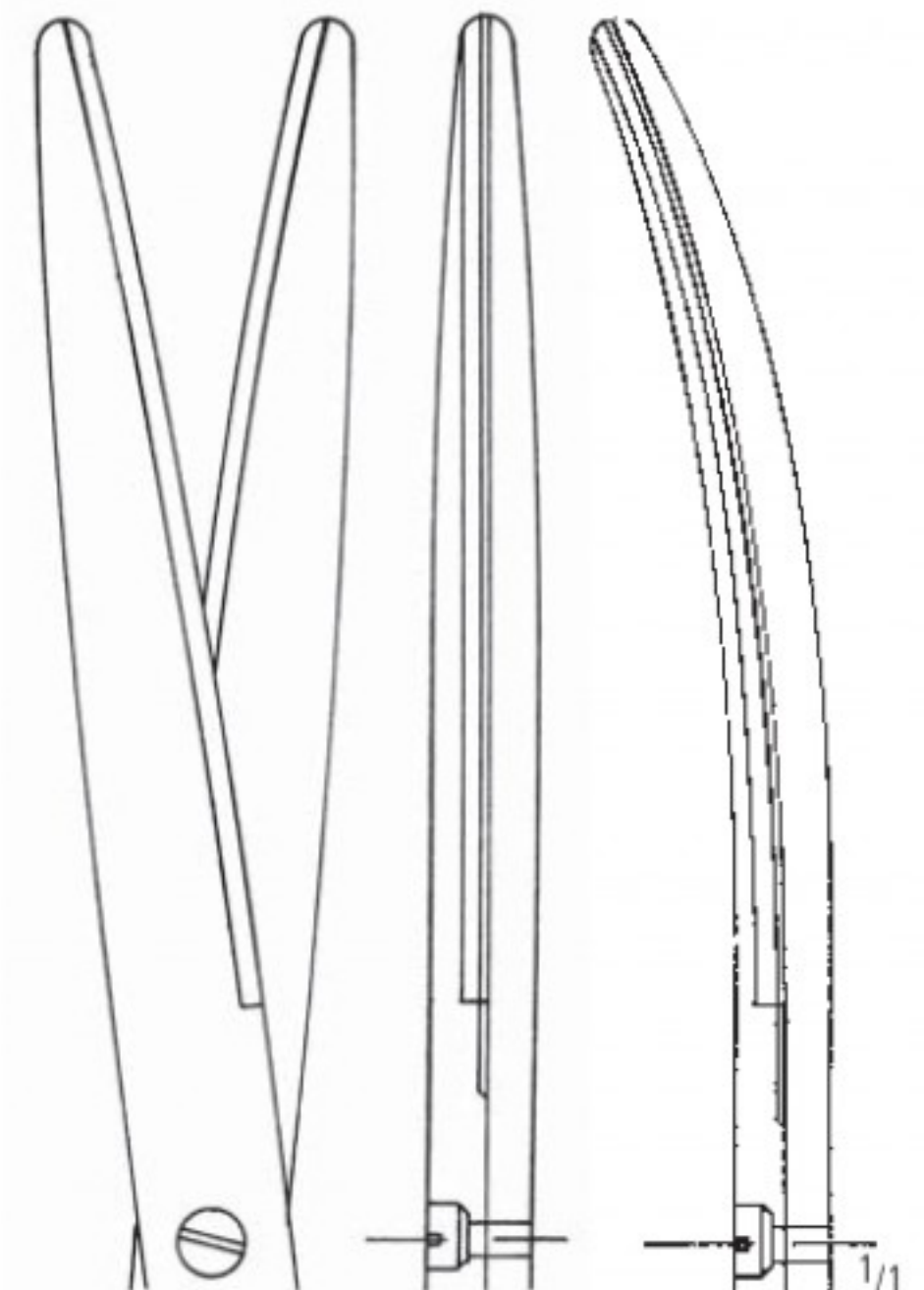

Original 30,0 cm

SCHEREN SCISSORS TIJERAS CISEAUX FORBICI

Scheren mit Hartmetalleinlagen
 Scissors with Tungsten Carbide Inserts
 Tijeras con filos de carburo de tungsteno
 Ciseaux avec plaquettes en carbure de tungstène
 Forbici con taglio al carburo di tungsteno



POTTS-SMITH
 19,0 cm/7¹/₂"



25°
 AC 948/25

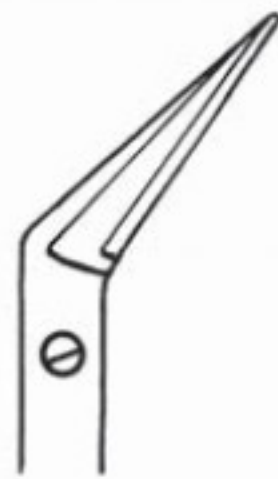

45°
 AC 948/45

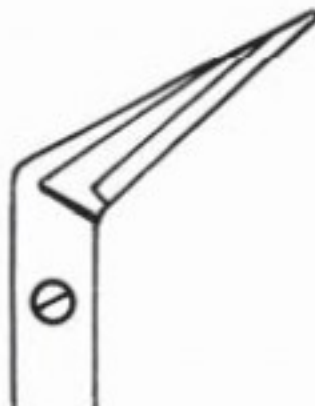

60°
 AC 948/60

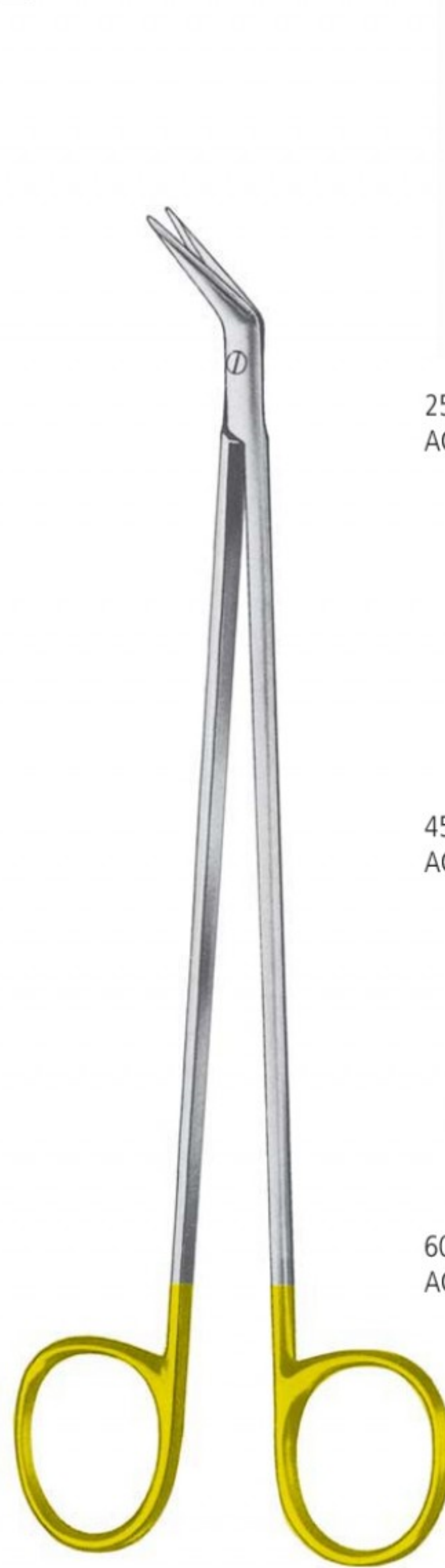

DE BAKEY
 18,0 cm/7"



25°
 AC 949/25

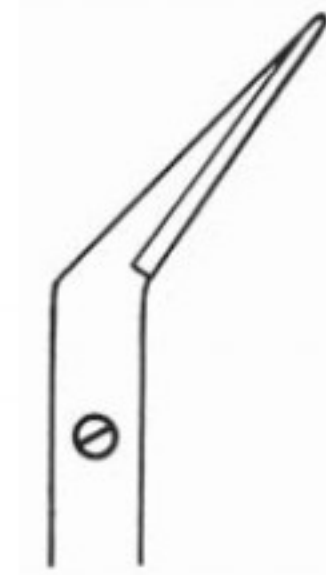

45°
 AC 949/45



60°
 AC 949/60

AA
 AB
 AC
 AD
 AE
 AF
 AK
 AL
 AM
 AO
 AP
 AR
 KA
 KB
 KC
 KD
 KU
 KY

AC SCHEREN SCISSORS TIJERAS CISEAUX FORBICI

Scheren mit Hartmetalleinlagen
 Scissors with Tungsten Carbide Inserts
 Tijeras con filos de carburo de tungsteno
 Ciseaux avec plaquettes en carbure de tungstène
 Forbici con taglio al carburo di tungsteno



LEXER
 AC 952/16
 16,0 cm/6¹/₄"

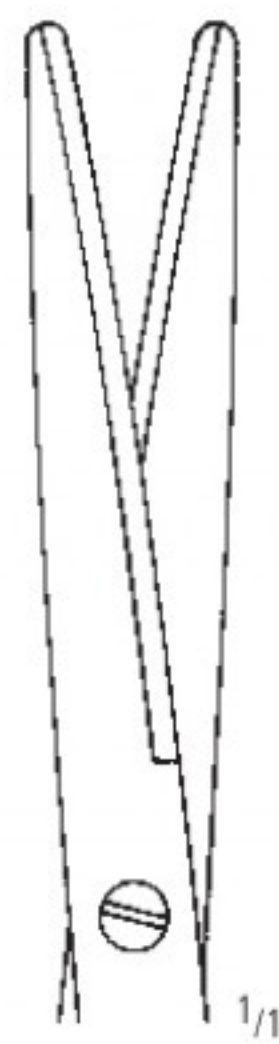

LEXER
 AC 953/16
 16,0 cm/6¹/₄"

nopa
TUC[®]



AC 960/14*
 14,5 cm/5³/₄"

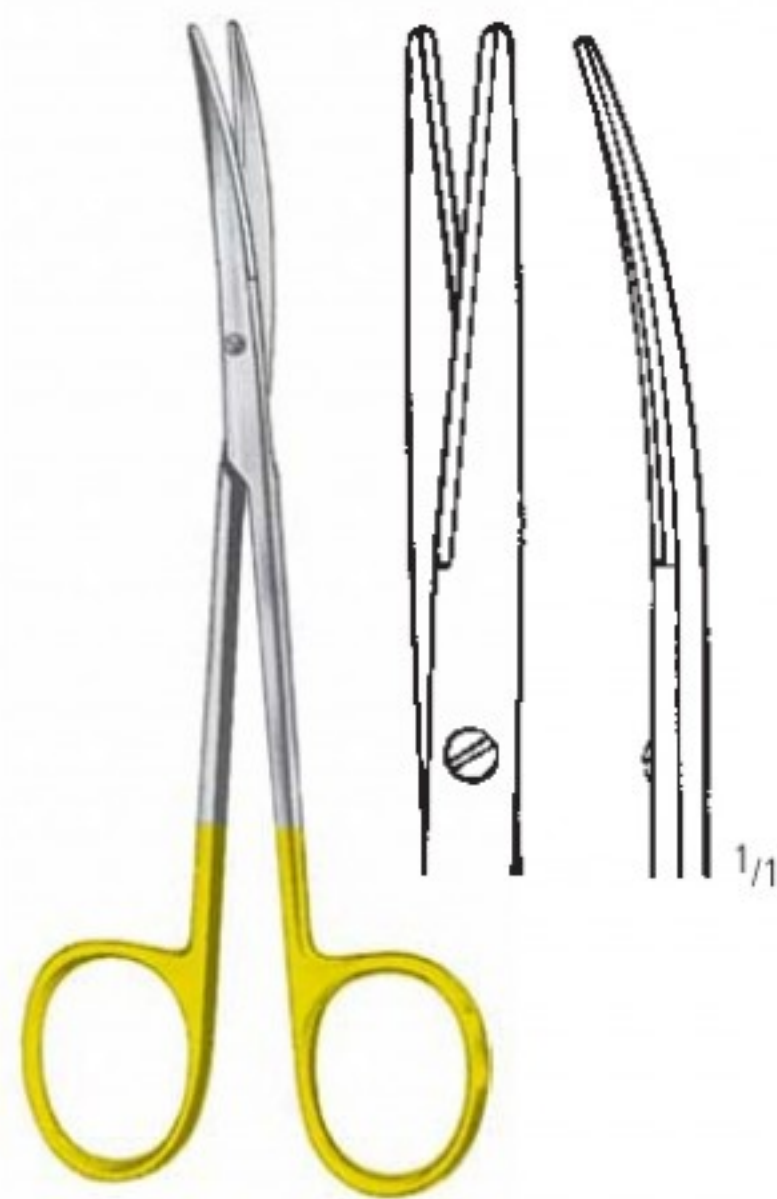

AC 961/14*
 14,5 cm/5³/₄"

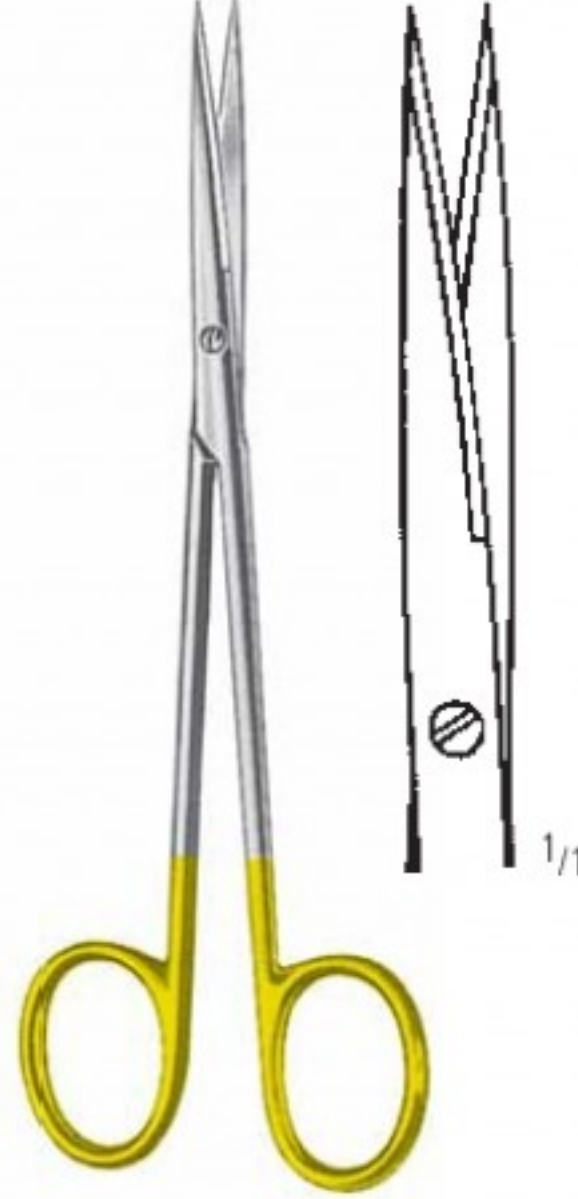

AC 962/14
 14,5 cm/5³/₄"

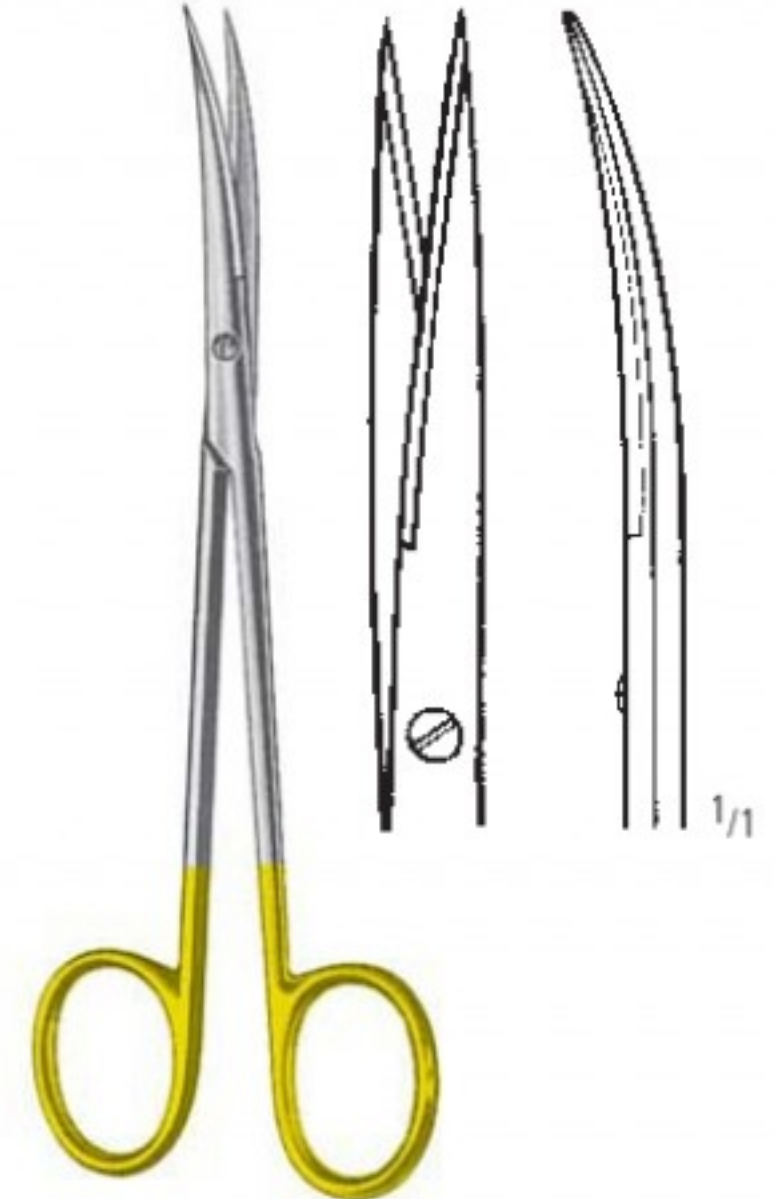

AC 963/14
 14,5 cm /5³/₄"

METZENBAUM-DELICATE

SCHEREN SCISSORS TIJERAS CISEAUX FORBICI

Scheren mit Hartmetalleinlagen
 Scissors with Tungsten Carbide Inserts
 Tijeras con filos de carburo de tungsteno
 Ciseaux avec plaquettes en carbure de tungstène
 Forbici con taglio al carburo di tungsteno

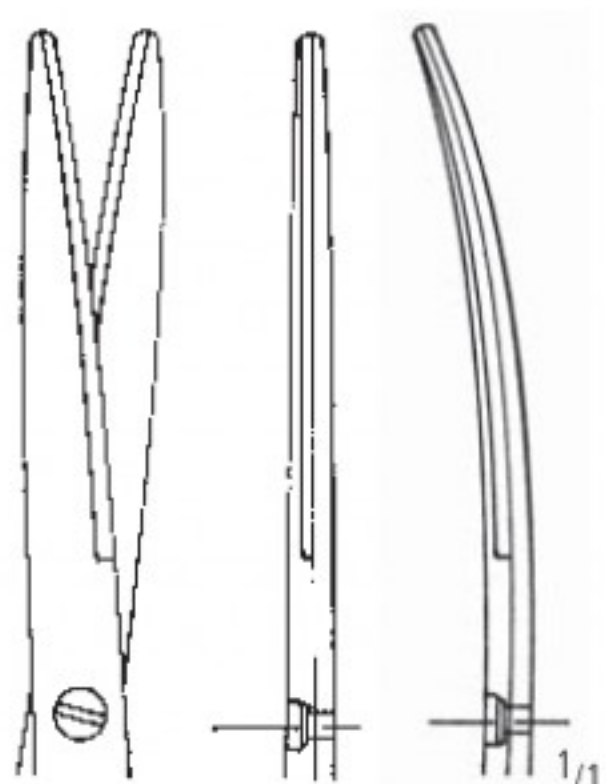

Original 18,0 cm

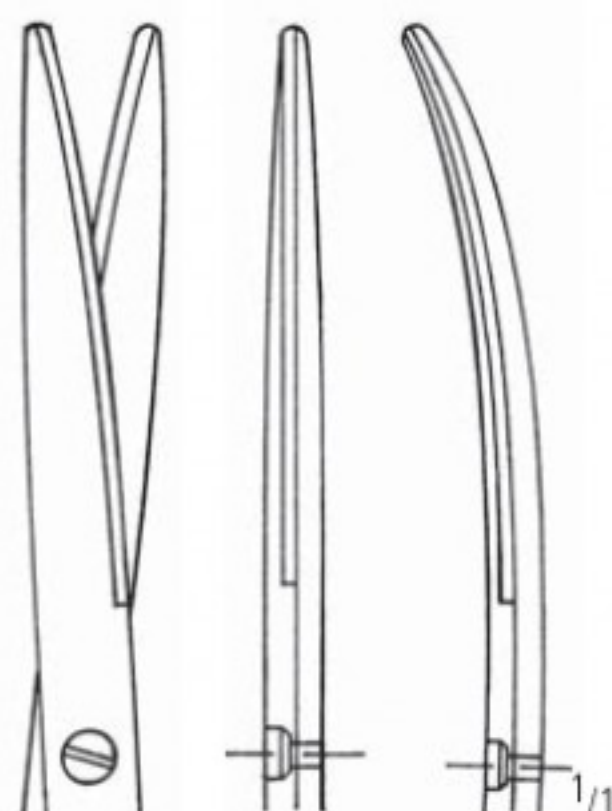

Original 20,0 cm

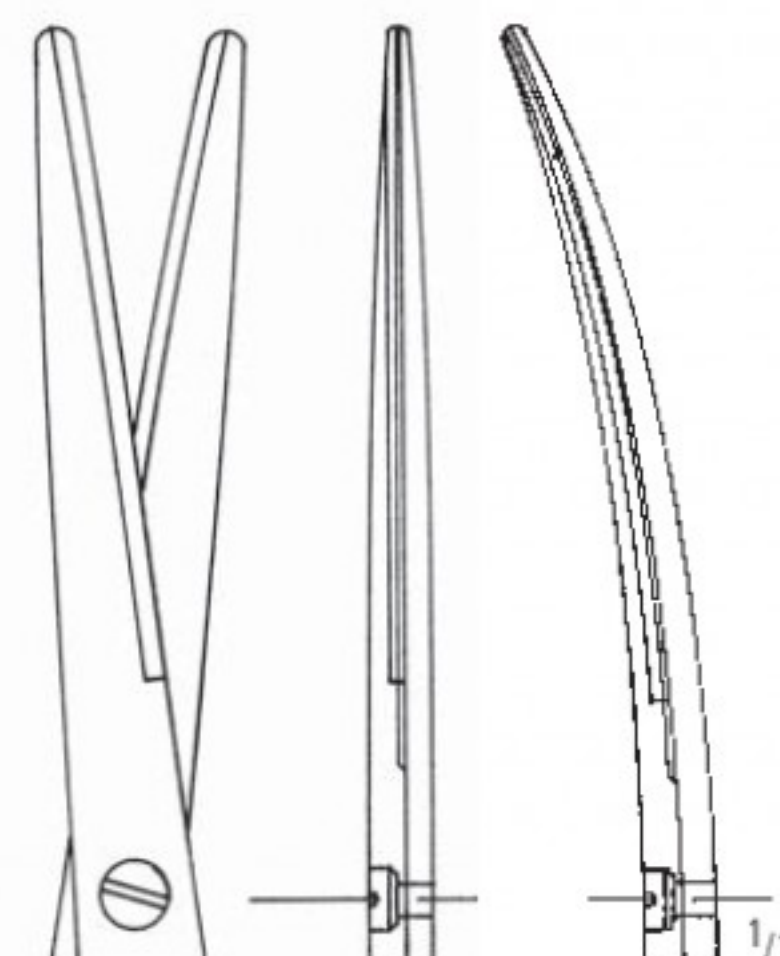

Original 23,0 cm



METZENBAUM-DELICATE

nopa
TUC[®]

gerade
 straight
 rectas
 droits
 rette

gebogen
 curved
 curvas
 courbes
 curve

AC 970/18*	18,0 cm/7"	AC 971/18*
AC 970/20*	20,0 cm/8"	AC 971/20*
AC 970/23	23,0 cm/9"	AC 971/23
AC 970/25	25,0 cm/10"	AC 971/25
AC 970/28	28,0 cm/11"	AC 971/28

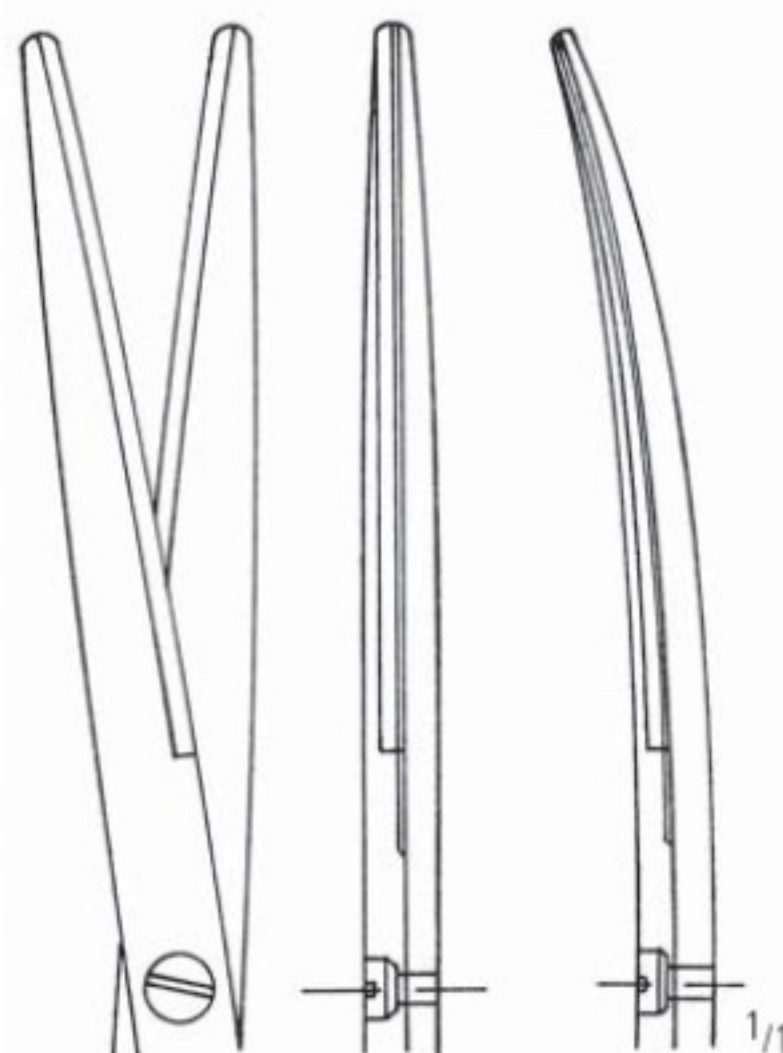

Original 25,0 cm

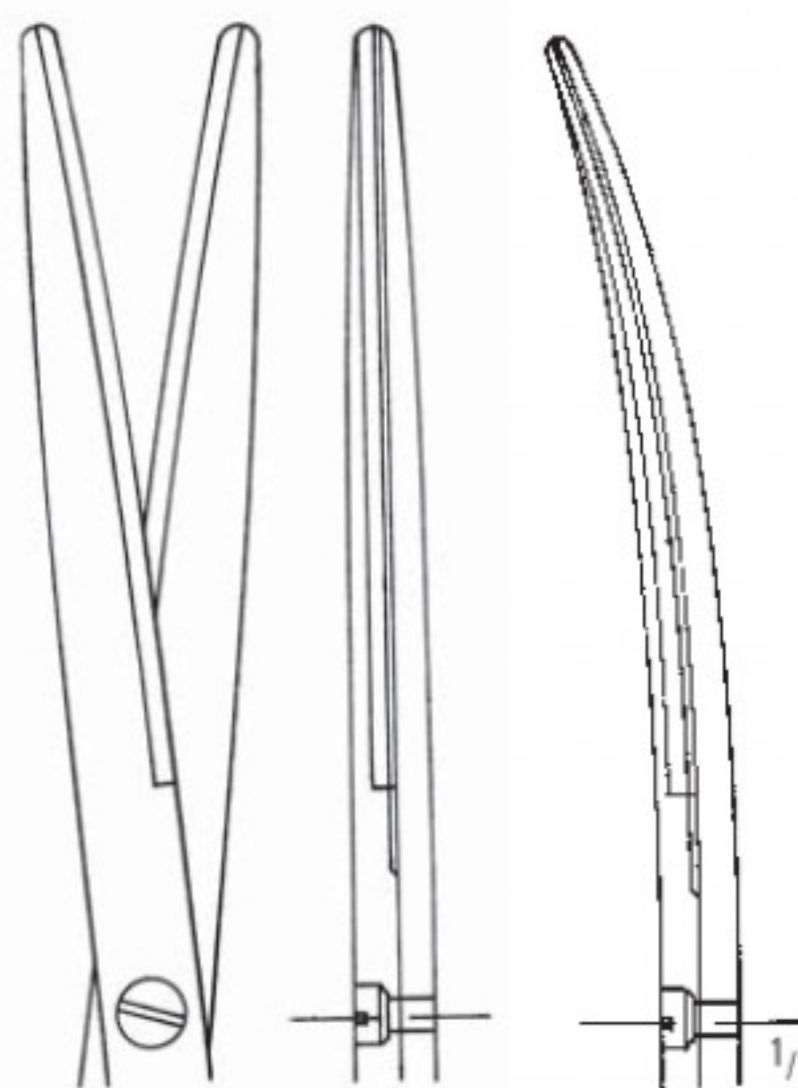

Original 28,0 cm

AC SCHEREN SCISSORS TIJERAS CISEAUX FORBICI

Scheren mit Hartmetalleinlagen
 Scissors with Tungsten Carbide Inserts
 Tijeras con filos de carburo de tungsteno
 Ciseaux avec plaquettes en carbure de tungstène
 Forbici con taglio al carburo di tungsteno

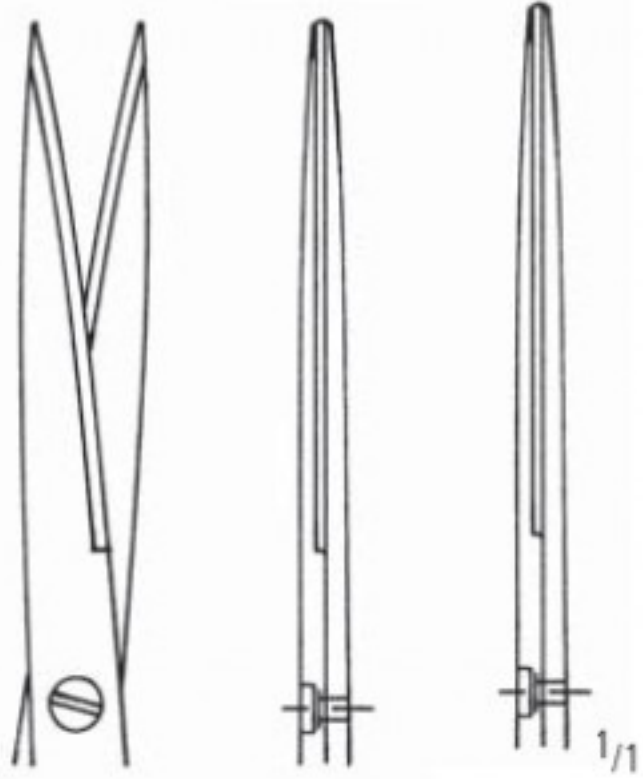

Original 18,0 cm

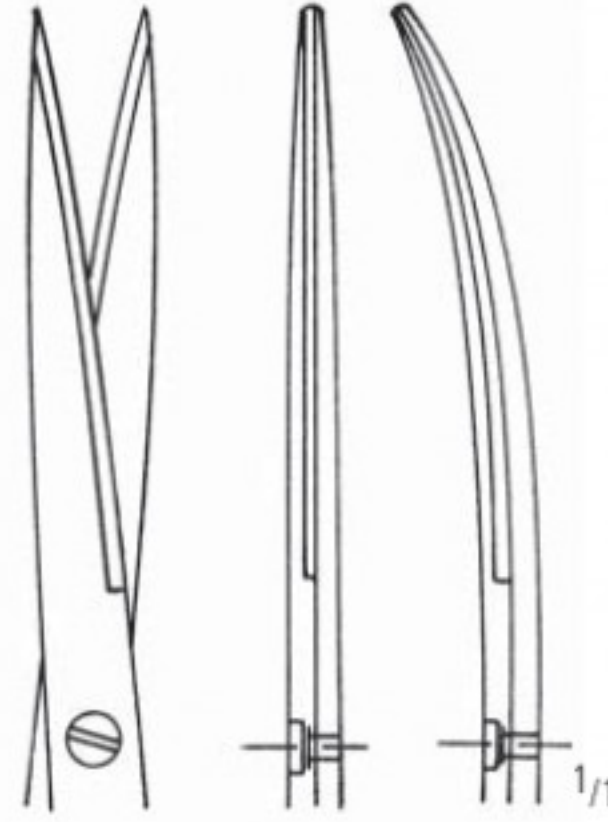

Original 20,0 cm

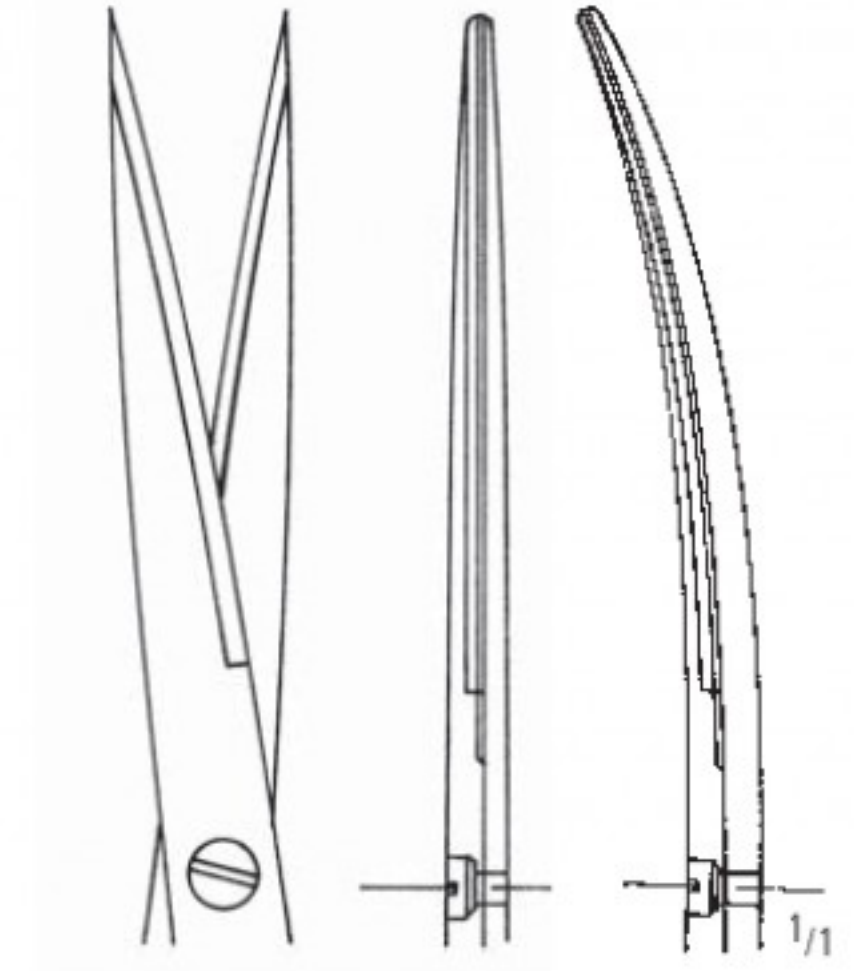

Original 23,0 cm



nopa
TUC[®]

gerade
 straight
 rectas
 droits
 rette

gebogen
 curved
 curvas
 courbes
 curve

AC 972/18	18,0 cm/7"	AC 973/18
AC 972/20	20,0 cm/8"	AC 973/20
AC 972/23	23,0 cm/9"	AC 973/23
AC 972/25	25,0 cm/10"	AC 973/25
AC 972/28	28,0 cm/11"	AC 973/28

METZENBAUM-DELICATE

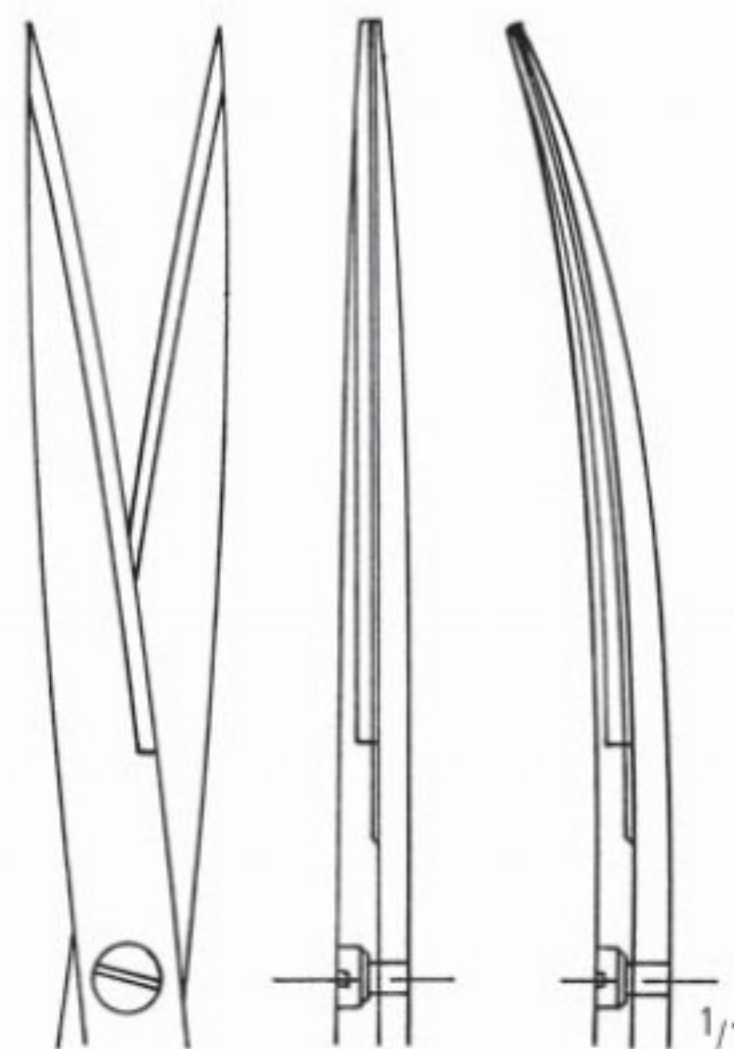

Original 25,0 cm

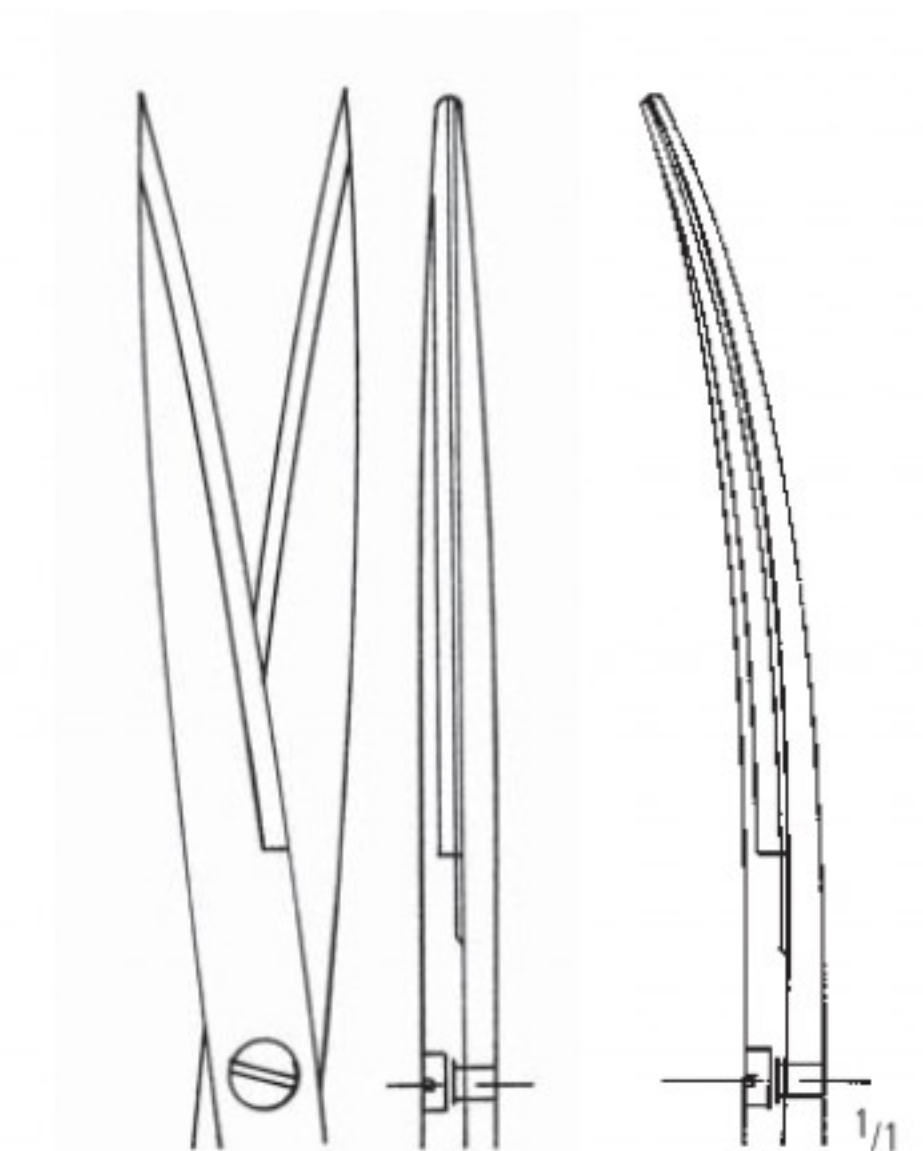

Original 28,0 cm

SCHEREN SCISSORS TIJERAS CISEAUX FORBICI

Scheren mit Hartmetalleinlagen
 Scissors with Tungsten Carbide Inserts
 Tijeras con filos de carburo de tungsteno
 Ciseaux avec plaquettes en carbure de tungstène
 Forbici con taglio al carburo di tungsteno



Original 11,5 cm

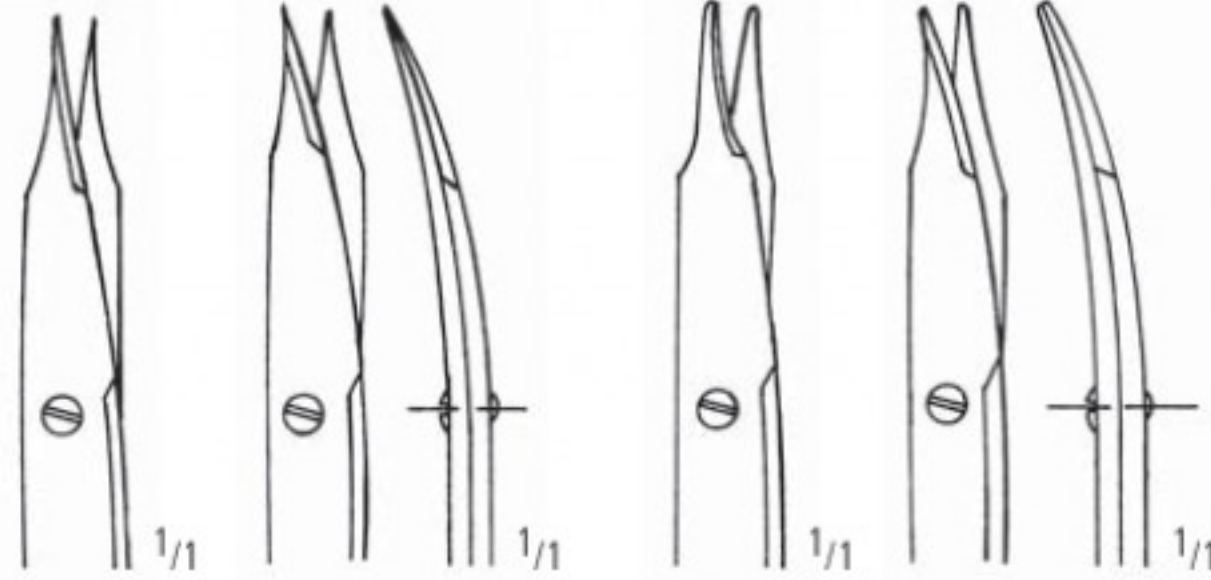

	spitz pointed agudas pointues acuta		stumpf blunt romas mousses smussa
gerade straight rectas droits rette	gebogen curved curvas courbes curve	gerade straight rectas droits rette	gebogen curved curvas courbes curve

STEVENS

10,5 cm/4 ¹ / ₄ "	AC 974/10	AC 975/10	AC 976/10	AC 977/10
11,5 cm/4 ¹ / ₂ "	AC 974/11*	AC 975/11*	AC 976/11	AC 977/11

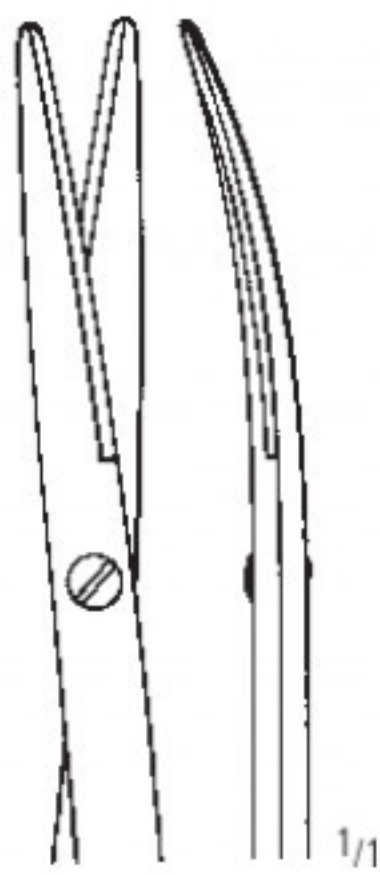

TOENNIS-ADSON-DELICATE

AC 977/17
 17,5 cm/7"



GOLDMAN-FOX

AC 980/13
 13,0 cm/5"



AC 981/13
 13,0 cm/5"

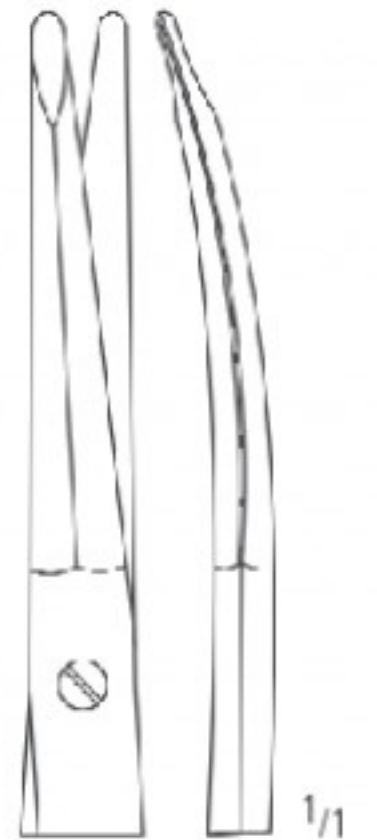

KAYE

AC 983/15
 15,0 cm/6"

gebogen
curved
curvas
courbes
curve

gezahnt
toothed
dentada
dentelés
dentata

* Auch erhältlich als SC * Also available as SC

AA
AB
AC
AD
AE
AF
AG
AH
AI
AJ
AK
AL
AM
AN
AO
AP
AQ
AR
AS
AT
AU
AV
AW
AX
AY
AZ
BA
BB
BC
BD
BE
BF
BG
BH
BI
BJ
BK
BL
BM
BN
BO
BP
BQ
BR
BS
BT
BU
BV
BW
BX
BY
BZ
CA
CB
CC
CD
CE
CF
CG
CH
CI
CJ
CK
CL
CM
CN
CO
CP
CQ
CR
CS
CT
CU
CV
CW
CX
CY
CZ
DA
DB
DC
DD
DE
DF
DG
DH
DI
DJ
DK
DL
DM
DN
DO
DP
DQ
DR
DS
DT
DU
DV
DW
DX
DY
DZ
EA
EB
EC
ED
EE
EF
EG
EH
EI
EJ
EK
EL
EM
EN
EO
EP
EQ
ER
ES
ET
EU
EV
EW
EX
EY
EZ
FA
FB
FC
FD
FE
FF
FG
FH
FI
FJ
FK
FL
FM
FN
FO
FP
FQ
FR
FS
FT
FU
FV
FW
FX
FY
FZ
GA
GB
GC
GD
GE
GF
GG
GH
GI
GJ
GK
GL
GM
GN
GO
GP
GQ
GR
GS
GT
GU
GV
GW
GX
GY
GZ
HA
HB
HC
HD
HE
HF
HG
HH
HI
HJ
HK
HL
HM
HN
HO
HP
HQ
HR
HS
HT
HU
HV
HW
HX
HY
HZ
IA
IB
IC
ID
IE
IF
IG
IH
II
IJ
IK
IL
IM
IN
IO
IP
IQ
IR
IS
IT
IU
IV
IW
IX
IY
IZ
JA
JB
JC
JD
JE
JF
JG
JH
JI
JJ
JK
JL
JM
JN
JO
JP
JQ
JR
JS
JT
JU
JV
JW
JX
JY
JZ
KA
KB
KC
KD
KE
KF
KG
KH
KI
KJ
KK
KL
KM
KN
KO
KP
KQ
KR
KS
KT
KU
KV
KW
KX
KY
KZ
LA
LB
LC
LD
LE
LF
LG
LH
LI
LJ
LK
LL
LM
LN
LO
LP
LQ
LR
LS
LT
LU
LV
LW
LX
LY
LZ
MA
MB
MC
MD
ME
MF
MG
MH
MI
MJ
MK
ML
MM
MN
MO
MP
MQ
MR
MS
MT
MU
MV
MW
MX
MY
MZ
NA
NB
NC
ND
NE
NF
NG
NH
NI
NJ
NK
NL
NM
NN
NO
NP
NQ
NR
NS
NT
NU
NV
NW
NX
NY
NZ
OA
OB
OC
OD
OE
OF
OG
OH
OI
OJ
OK
OL
OM
ON
OO
OP
OQ
OR
OS
OT
OU
OV
OW
OX
OY
OZ
PA
PB
PC
PD
PE
PF
PG
PH
PI
PJ
PK
PL
PM
PN
PO
PP
PQ
PR
PS
PT
PU
PV
PW
PX
PY
PZ
QA
QB
QC
QD
QE
QF
QG
QH
QI
QJ
QK
QL
QM
QN
QO
QP
QQ
QR
QS
QT
QU
QV
QW
QX
QY
QZ
RA
RB
RC
RD
RE
RF
RG
RH
RI
RJ
RK
RL
RM
RN
RO
RP
RQ
RR
RS
RT
RU
RV
RW
RX
RY
RZ
SA
SB
SC
SD
SE
SF
SG
SH
SI
SJ
SK
SL
SM
SN
SO
SP
SQ
SR
SS
ST
SU
SV
SW
SX
SY
SZ
TA
TB
TC
TD
TE
TF
TG
TH
TI
TJ
TK
TL
TM
TN
TO
TP
TQ
TR
TS
TT
TU
TV
TW
TX
TY
TZ
UA
UB
UC
UD
UE
UF
UG
UH
UI
UJ
UK
UL
UM
UN
UO
UP
UQ
UR
US
UT
UU
UV
UW
UX
UY
UZ
VA
VB
VC
VD
VE
VF
VG
VH
VI
VJ
VK
VL
VM
VN
VO
VP
VQ
VR
VS
VT
VU
VV
VW
VX
VY
VZ
WA
WB
WC
WD
WE
WF
WG
WH
WI
WJ
WK
WL
WM
WN
WO
WP
WQ
WR
WS
WT
WU
WV
WW
WX
WY
WZ
XA
XB
XC
XD
XE
XF
XG
XH
XI
XJ
XK
XL
XM
XN
XO
XP
XQ
XR
XS
XT
XU
XV
XW
XX
XY
XZ
YA
YB
YC
YD
YE
YF
YG
YH
YI
YJ
YK
YL
YM
YN
YO
YP
YQ
YR
YS
YT
YU
YV
YW
YX
YZ
ZA
ZB
ZC
ZD
ZE
ZF
ZG
ZH
ZI
ZJ
ZK
ZL
ZM
ZN
ZO
ZP
ZQ
ZR
ZS
ZT
ZU
ZV
ZW
ZX
ZY
ZZ

Scheren mit Hartmetalleinlagen
 Scissors with Tungsten Carbide Inserts
 Tijeras con filos de carburo de tungsteno
 Ciseaux avec plaquettes en carbure de tungstène
 Forbici con taglio al carburo di tungsteno



AC 984/11*
 11,5 cm/4 1/2"



AC 985/11*
 11,5 cm/4 1/2"

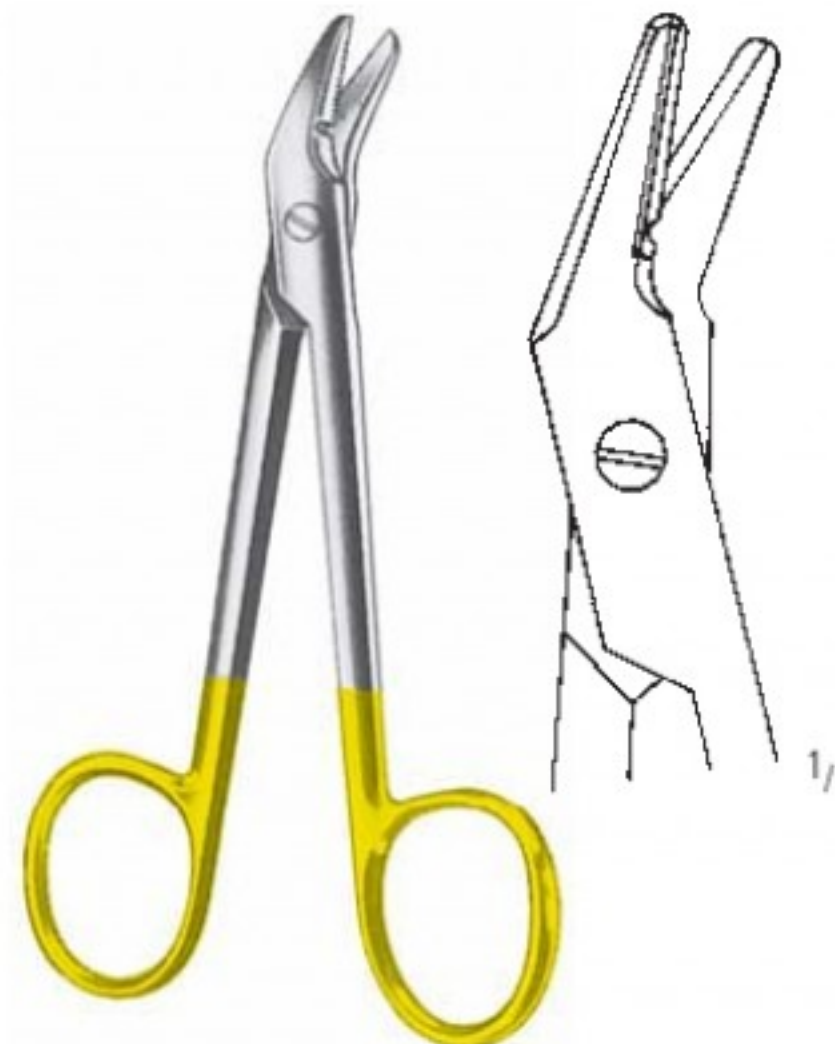

UNIVERSAL
 AC 987/12
 12,0 cm/4 3/4"



LISTER
 AC 999/18
 18,0 cm/7"