NAHT
SUTURE
SUTURA
SUTURE
SUTURA

AE

nopa[®] instruments



AE NAHT SUTURE SUTURA SUTURE SUTURA

Nadelhalter
Needle Holders
Porta-agujas
Porte-aiguilles
Portaghi



BOYNTON
AE 036/12
12,0 cm/4³/₄"

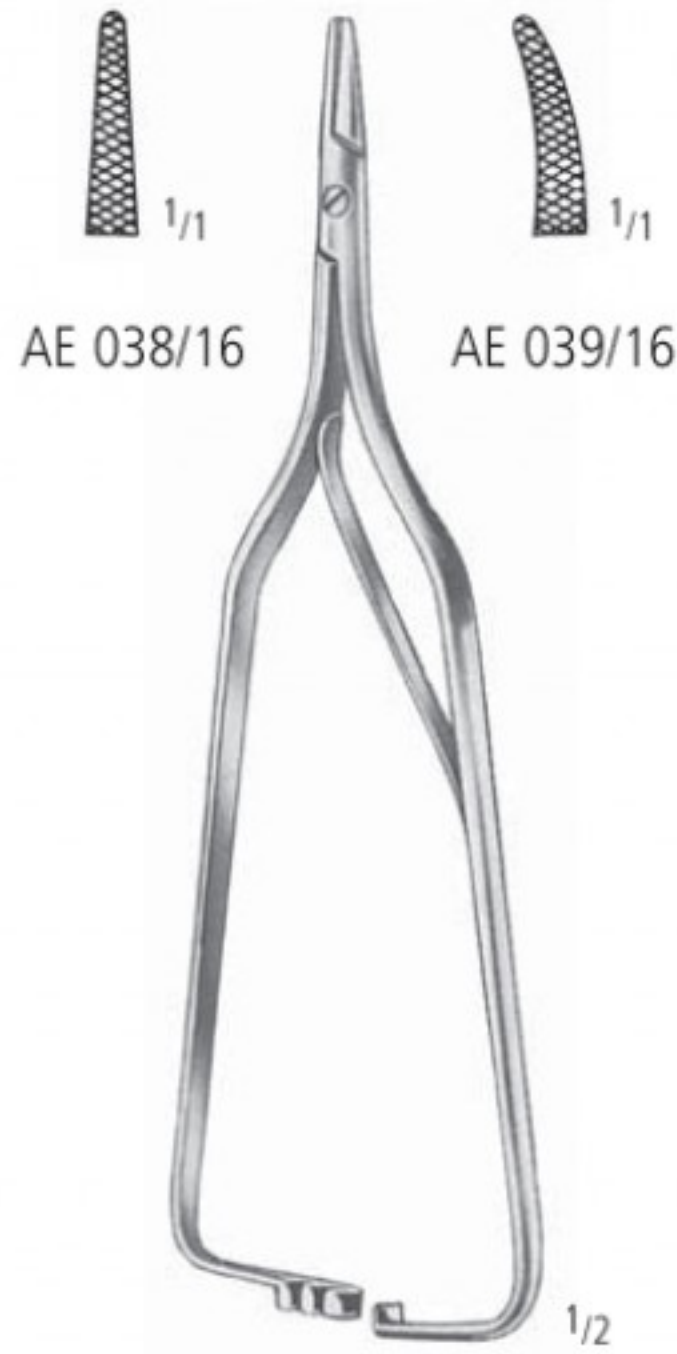

ARRUGA
16,0 cm/6¹/₄"



DERF
AE 050/12
12,0 cm/4³/₄"



DERF-CONVERSE
AE 052/12
12,5 cm/5"

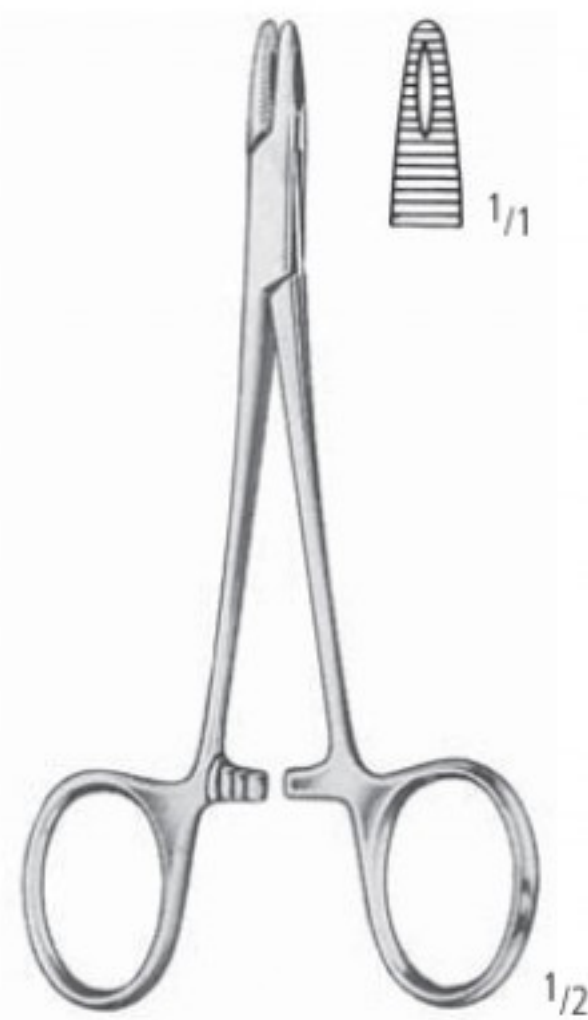

COLLIER
AE 056/12
12,5 cm/5"

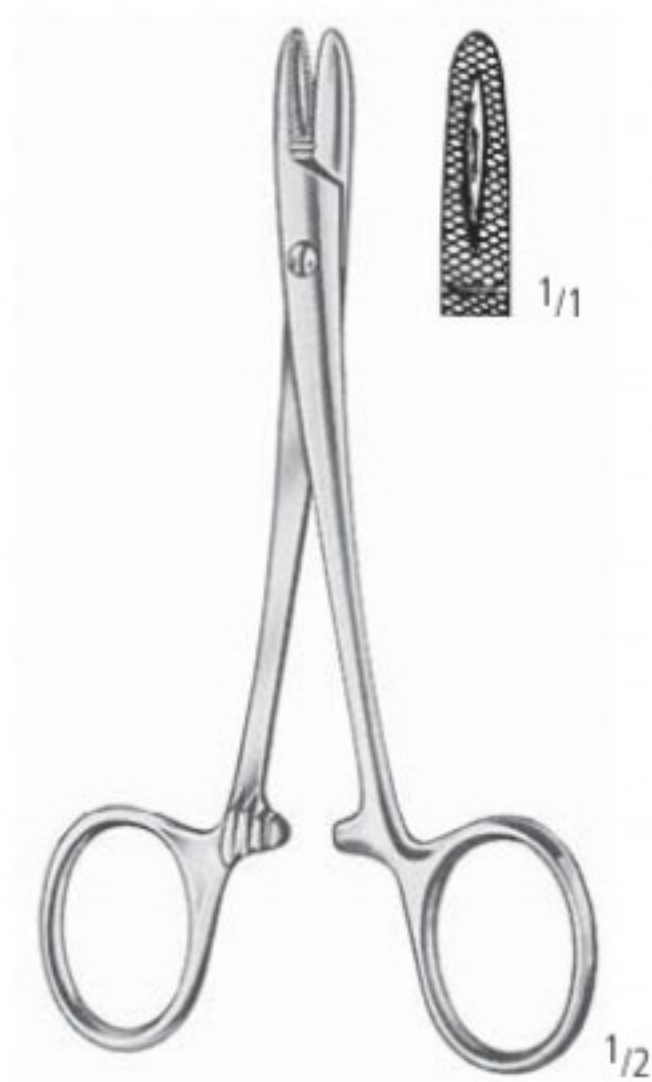

DOYEN
AE 058/12
12,5 cm/5"

NAHT SUTURE SUTURA SUTURE SUTURA

Nadelhalter
Needle Holders
Porta-agujas
Porte-aiguilles
Portaghi

AA
AB
AC
AD
AE
AF
AK
AL
AM
AO
AP
AR
KA
KB
KC
KD
KU
KY

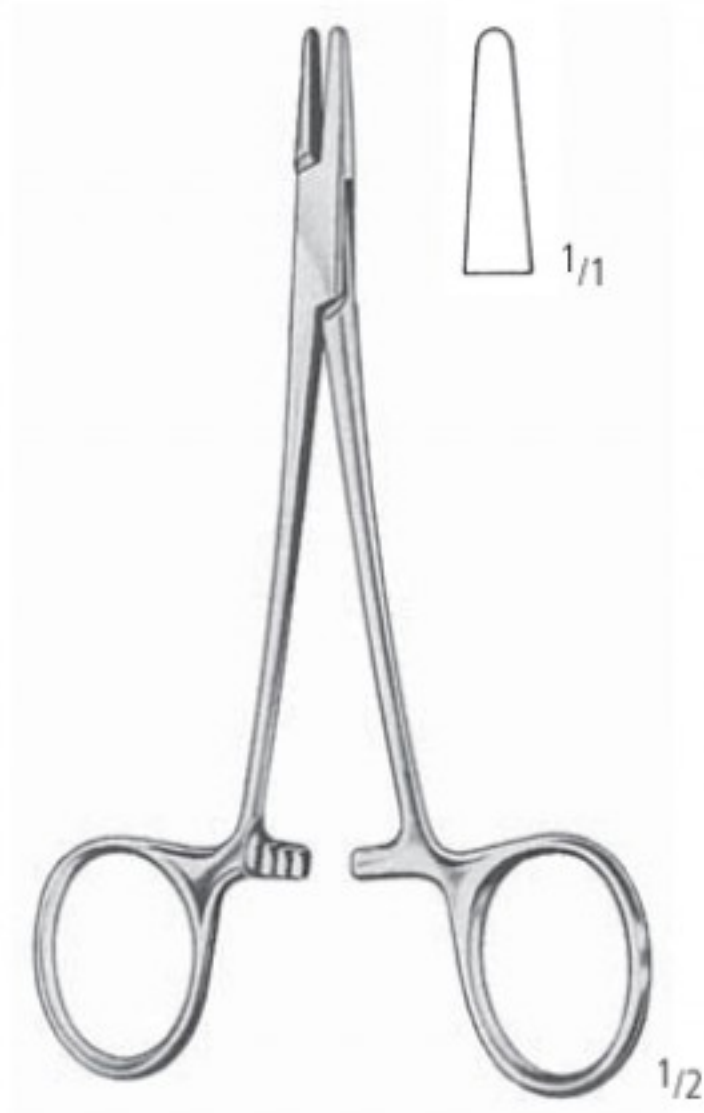

WEBSTER
AE 060/13
13,0 cm/5"

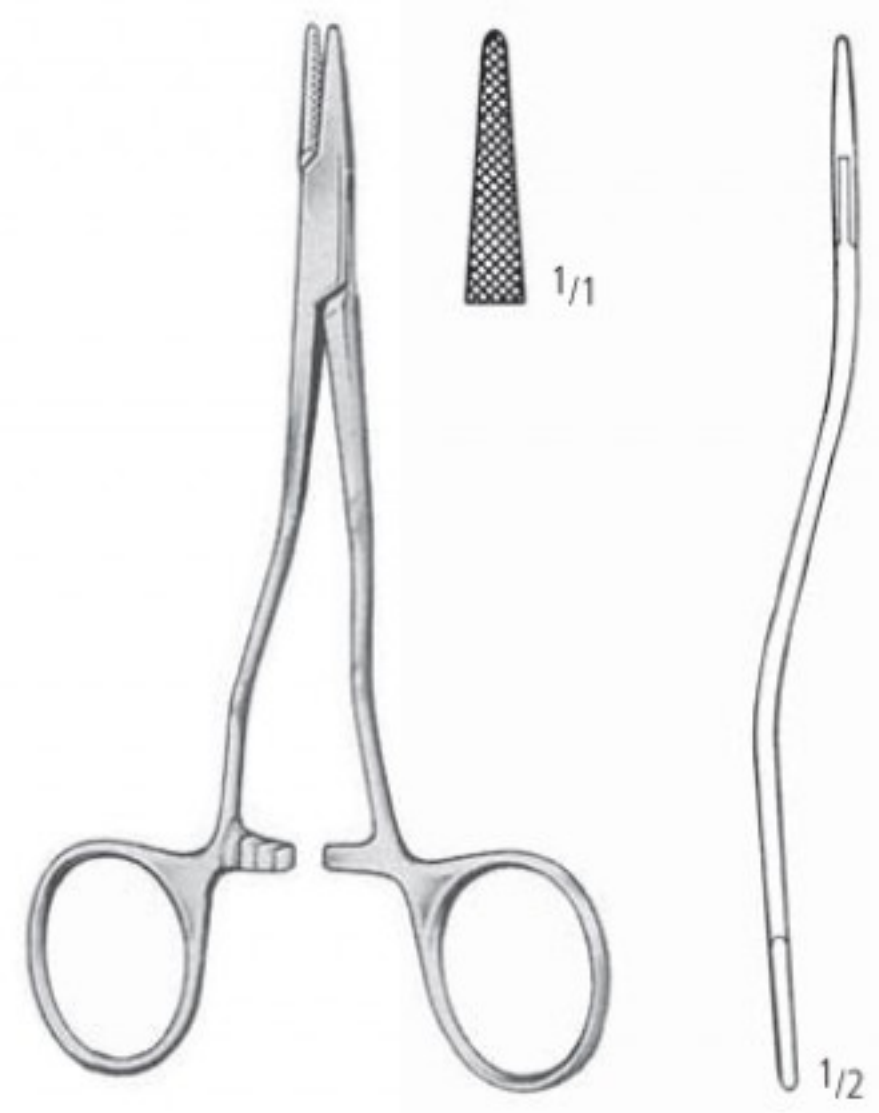

KILNER
AE 063/13
13,0 cm/5"

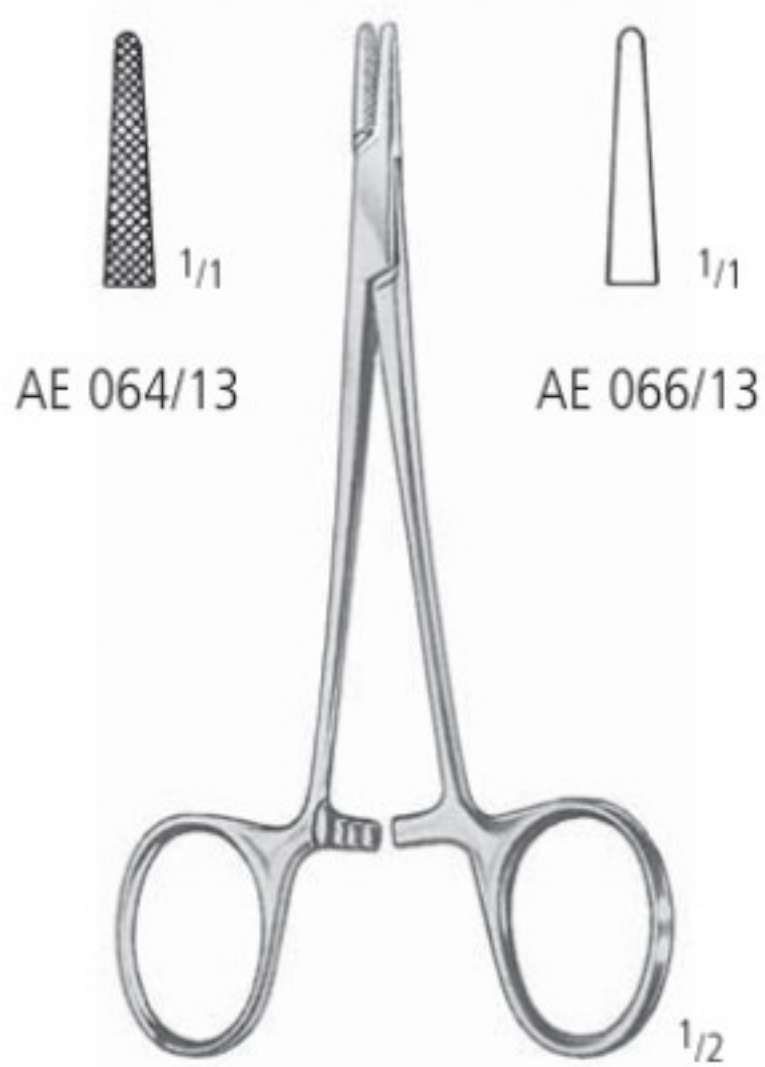

HALSEY
13,0 cm/5"

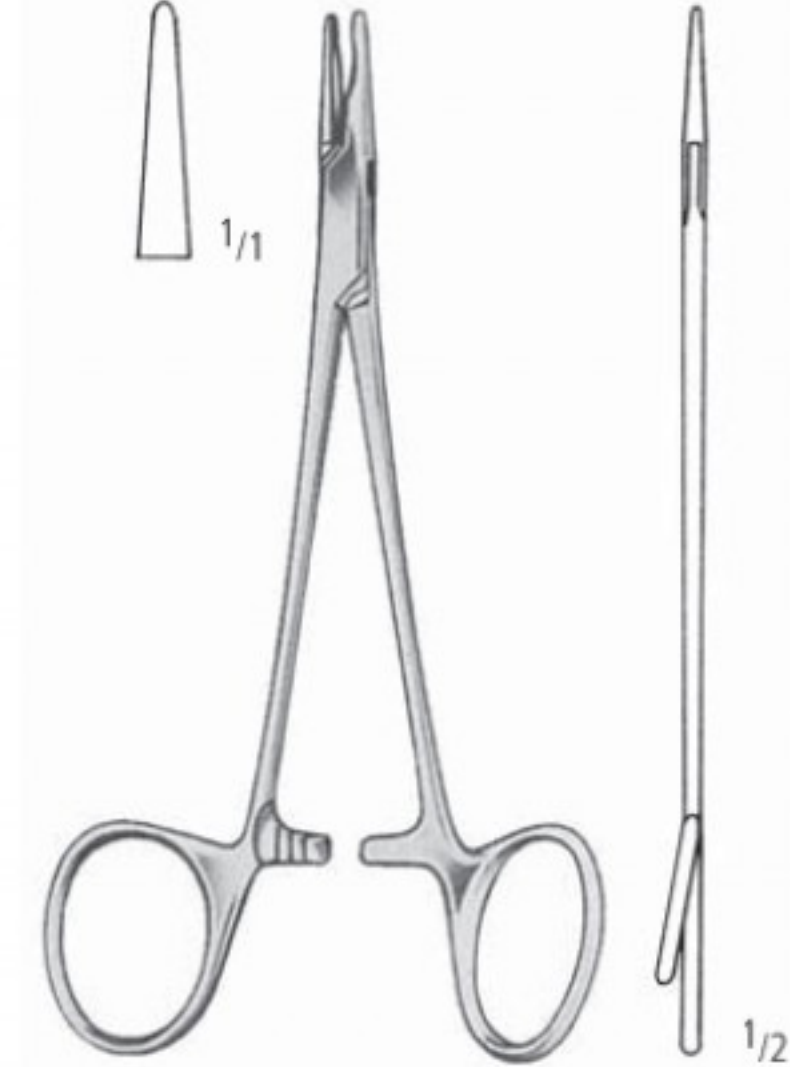

NEIVERT
AE 068/13
13,0 cm/5"

AE NAHT SUTURE SUTURA SUTURE SUTURA

Nadelhalter
Needle Holders
Porta-agujas
Porte-aiguilles
Portaghi



CRILE-WOOD
15,0 cm/6"
18,0 cm/7"
AE 070/15
AE 070/18



BABY-CRILE-WOOD
AE 072/15
15,0 cm/6"



CARROLL
AE 074/15
15,0 cm/6"



CRILE-MURRAY
AE 076/15
15,0 cm/6"

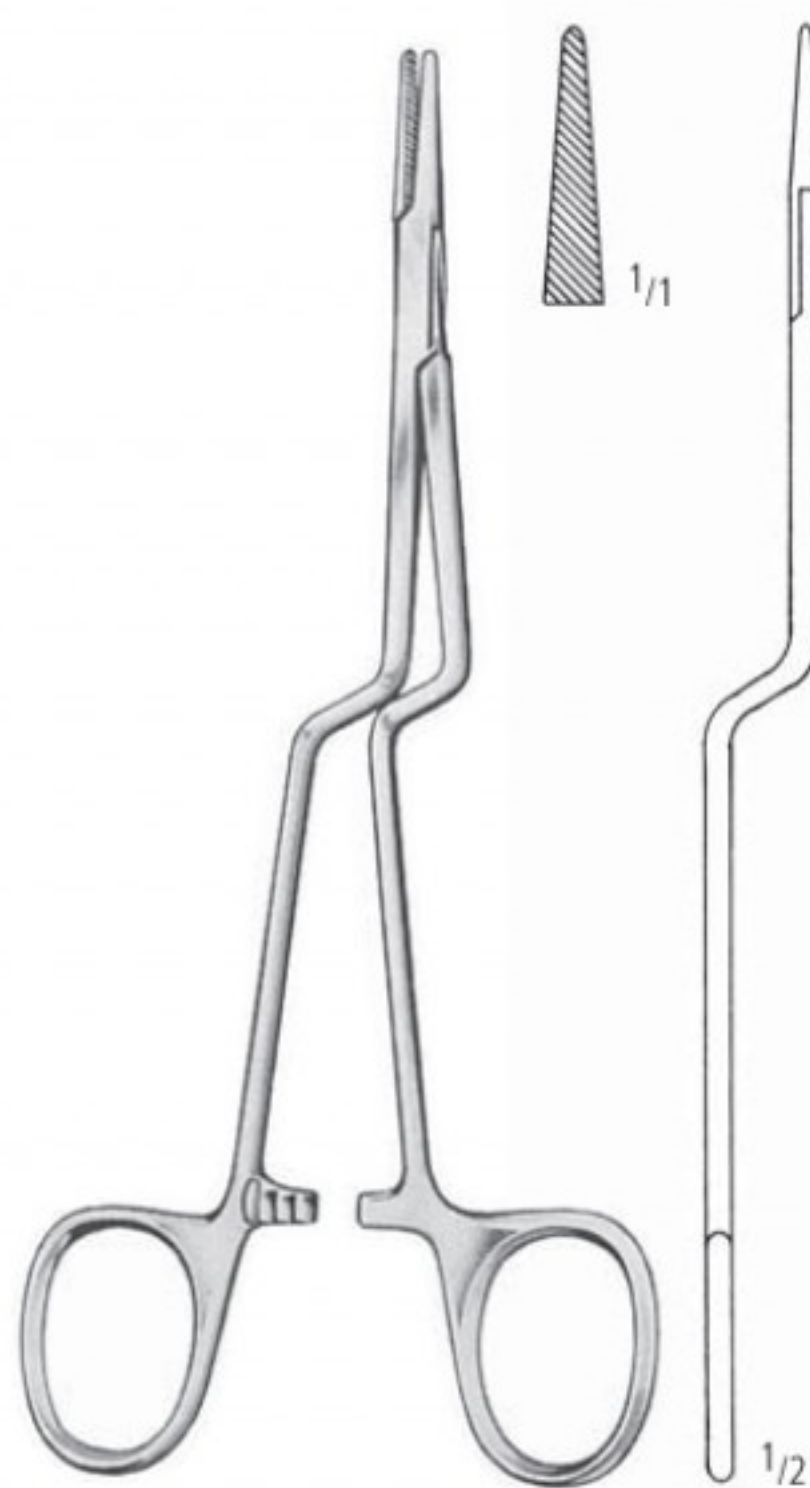

JACOBSON
AE 077/18
18,0 cm/7"

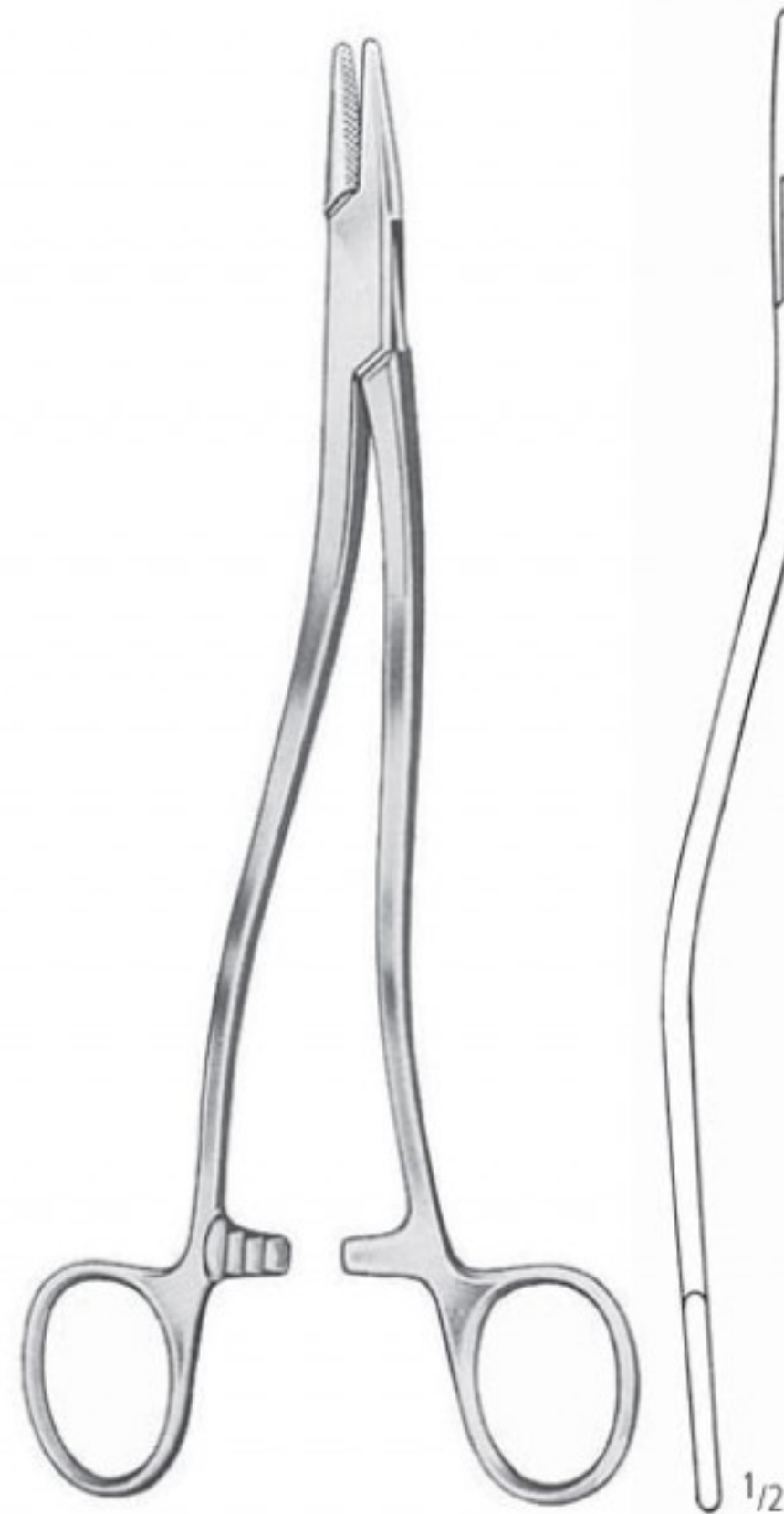

BOZEMANN



AE 079/20
20,0 cm/8"



AE 079/24
24,0 cm/9 1/2"



AE 079/26
26,0 cm/10 1/2"

NAHT SUTURE SUTURA SUTURE SUTURA

Nadelhalter
Needle Holders
Porta-agujas
Porte-aiguilles
Portaghi

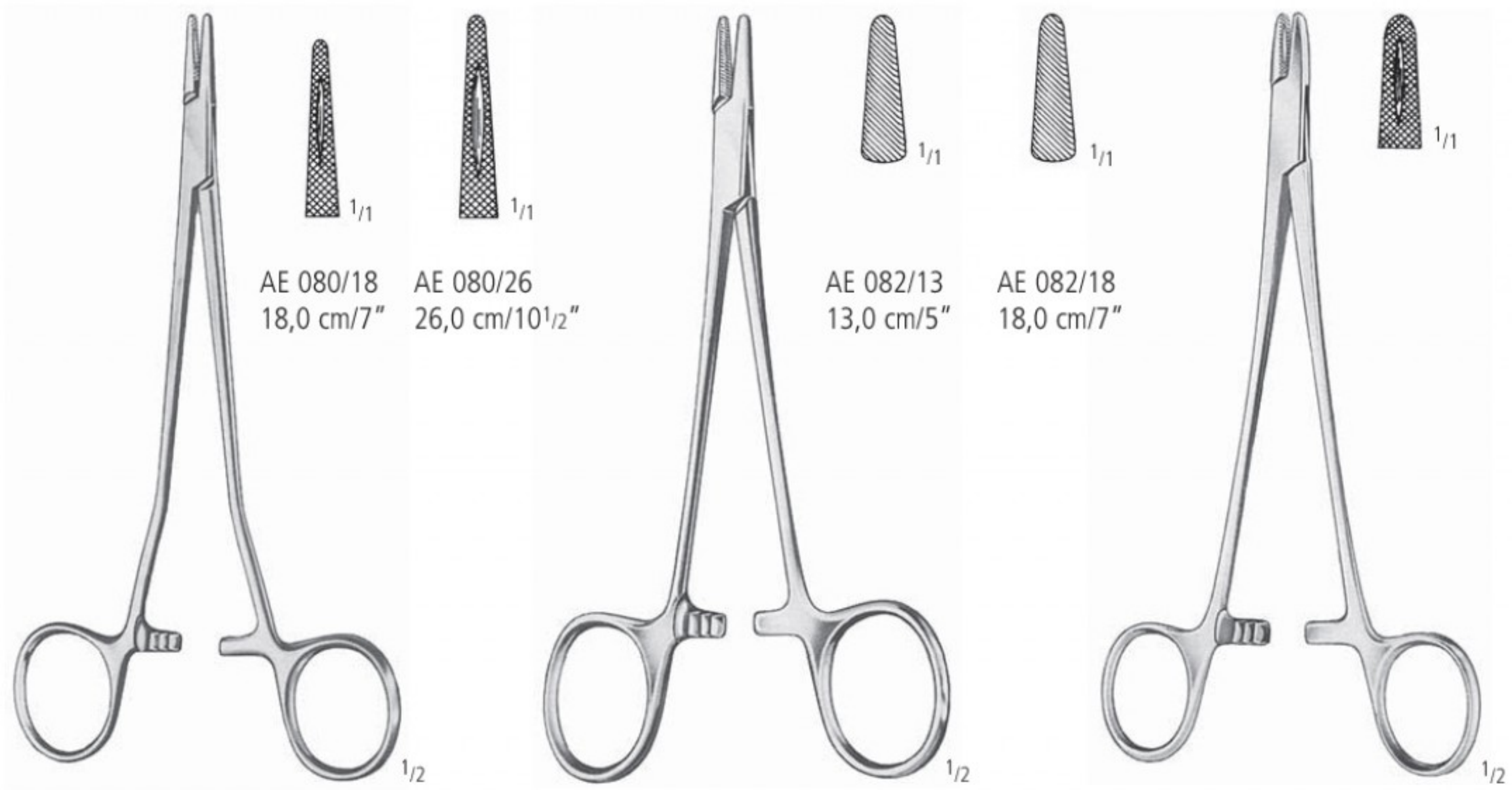

AE 080/18
18,0 cm/7"
AE 080/26
26,0 cm/10¹/₂"

AE 082/13
13,0 cm/5"
AE 082/18
18,0 cm/7"

NEW ORLEANS
AE 086/18
18,0 cm/7"

SAROT

BROWN

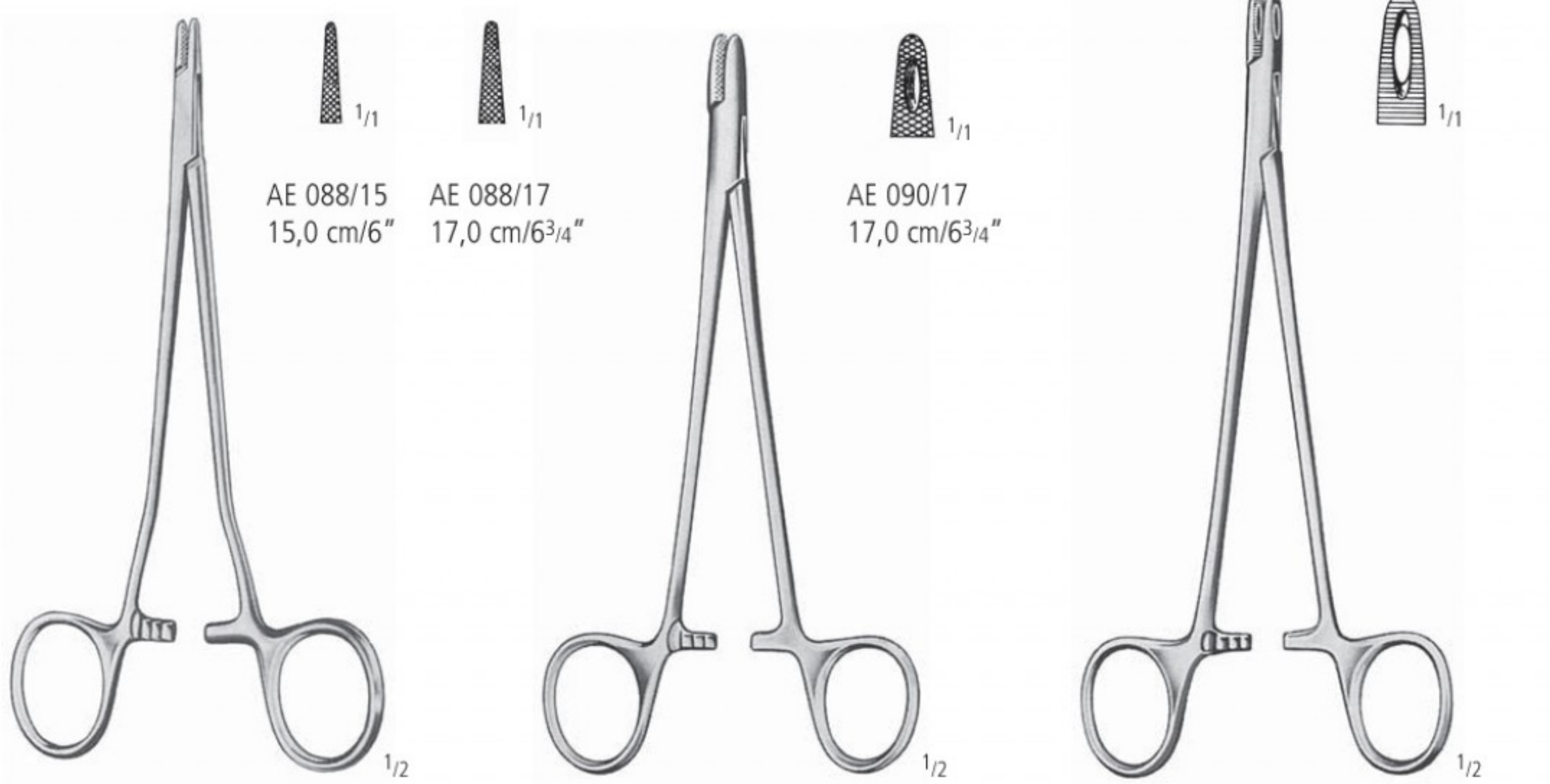

AE 088/15
15,0 cm/6"
AE 088/17
17,0 cm/6³/₄"

AE 090/17
17,0 cm/6³/₄"

ADSON
AE 094/18
18,0 cm/7"

SENNING
(Schwed. Modell)

M.G.H.
(Mass.-General-Hospital)

AA
AB
AC
AD
AE
AF
AK
AL
AM
AO
AP
AR
KA
KB
KC
KD
KU
KY

AE NAHT SUTURE SUTURA SUTURE SUTURA

Nadelhalter
Needle Holders
Porta-agujas
Porte-aiguilles
Portaghi



MAYO-HEGAR



AE 100/14
14,0 cm/5¹/₂"



AE 100/16
16,0 cm/6¹/₄"

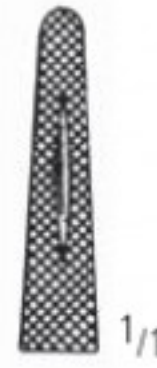

AE 100/18
18,0 cm/7"



AE 100/20
20,0 cm/8"



AE 100/24
24,0 cm/9¹/₂"



AE 100/26
26,0 cm/10¹/₄"

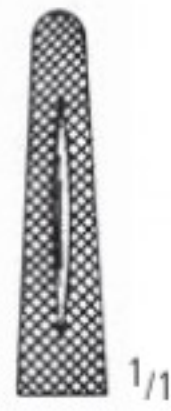

AE 100/30
30,0 cm/12"

MAYO-HEGAR-DELICATE



AE 110/16
16,0 cm/6¹/₄"

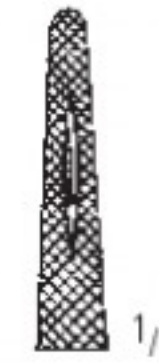

AE 110/18
18,0 cm/7"



AE 110/20
20,0 cm/8"



BAUMGARTNER
AE 112/14
14,0 cm/5¹/₂"

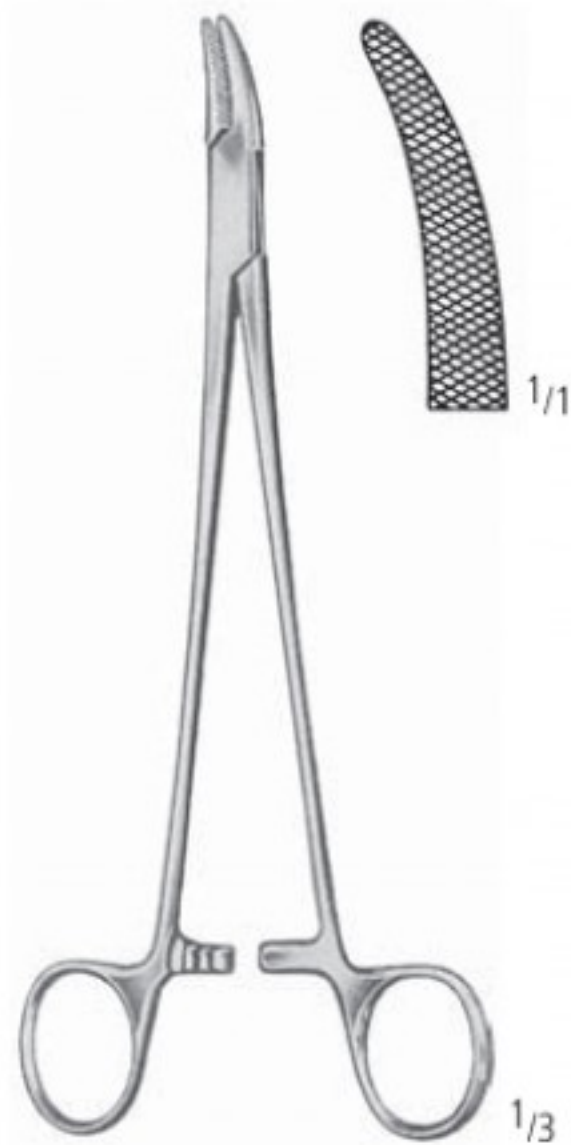

HEANEY
AE 113/21
21,0 cm/8¹/₄"



JAMESON
AE 126/23
23,5 cm/9¹/₃"



MASSON
AE 130/27
27,0 cm/10³/₄"

NAHT SUTURE SUTURA SUTURE SUTURA

Nadelhalter
Needle Holders
Porta-agujas
Porte-aiguilles
Portaghi



FINOCCHIETTO
AE 136/27
27,0 cm/10³/₄"



WANGENSTEEN
AE 140/27
27,0 cm/10³/₄"



WANGENSTEEN-DELICATE
AE 142/27
27,5 cm/10¹/₂"

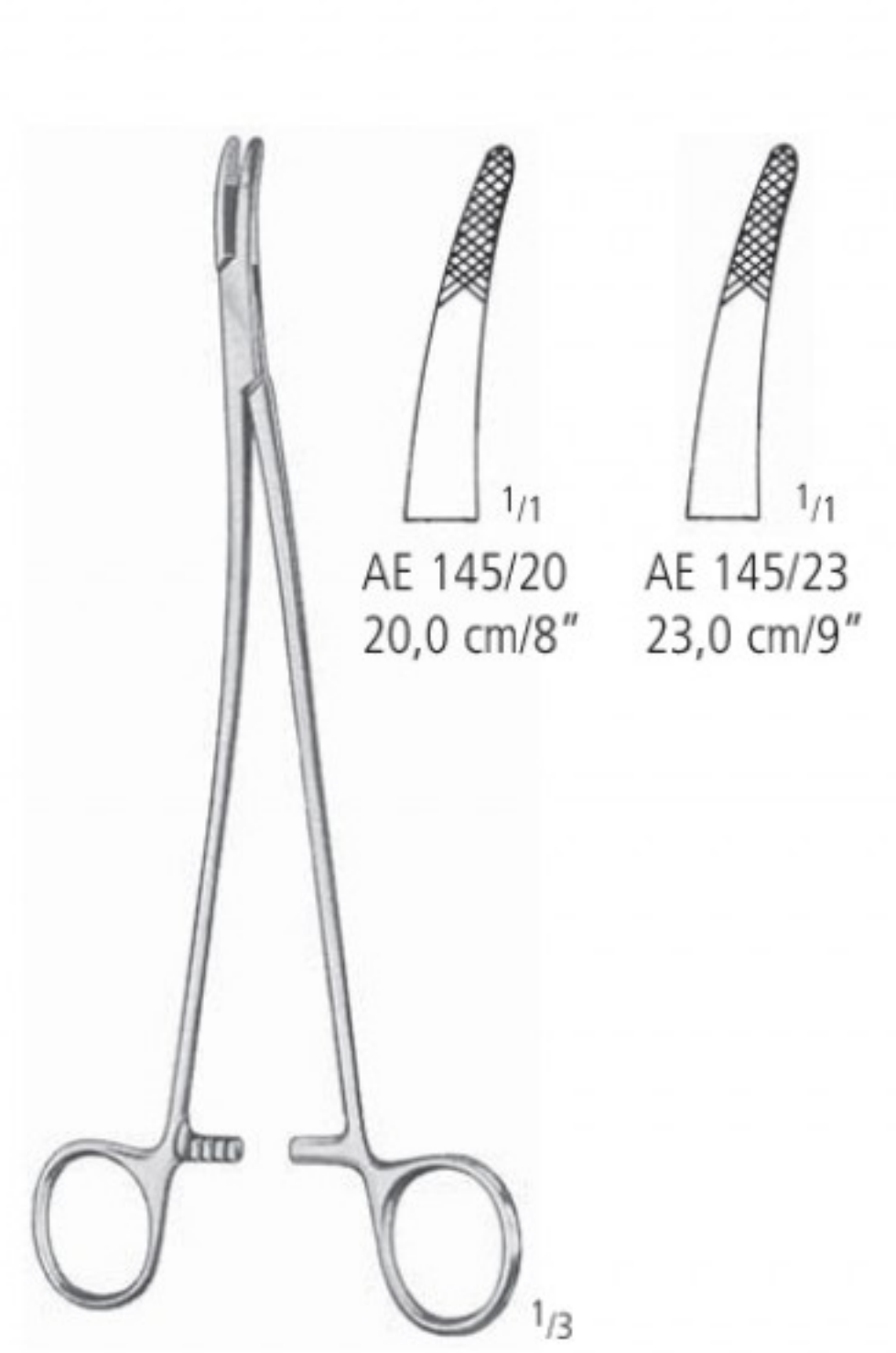

STRATTE



WERTHEIM
20,0 cm/8" AE 147/20
24,0 cm/9¹/₂" AE 147/24

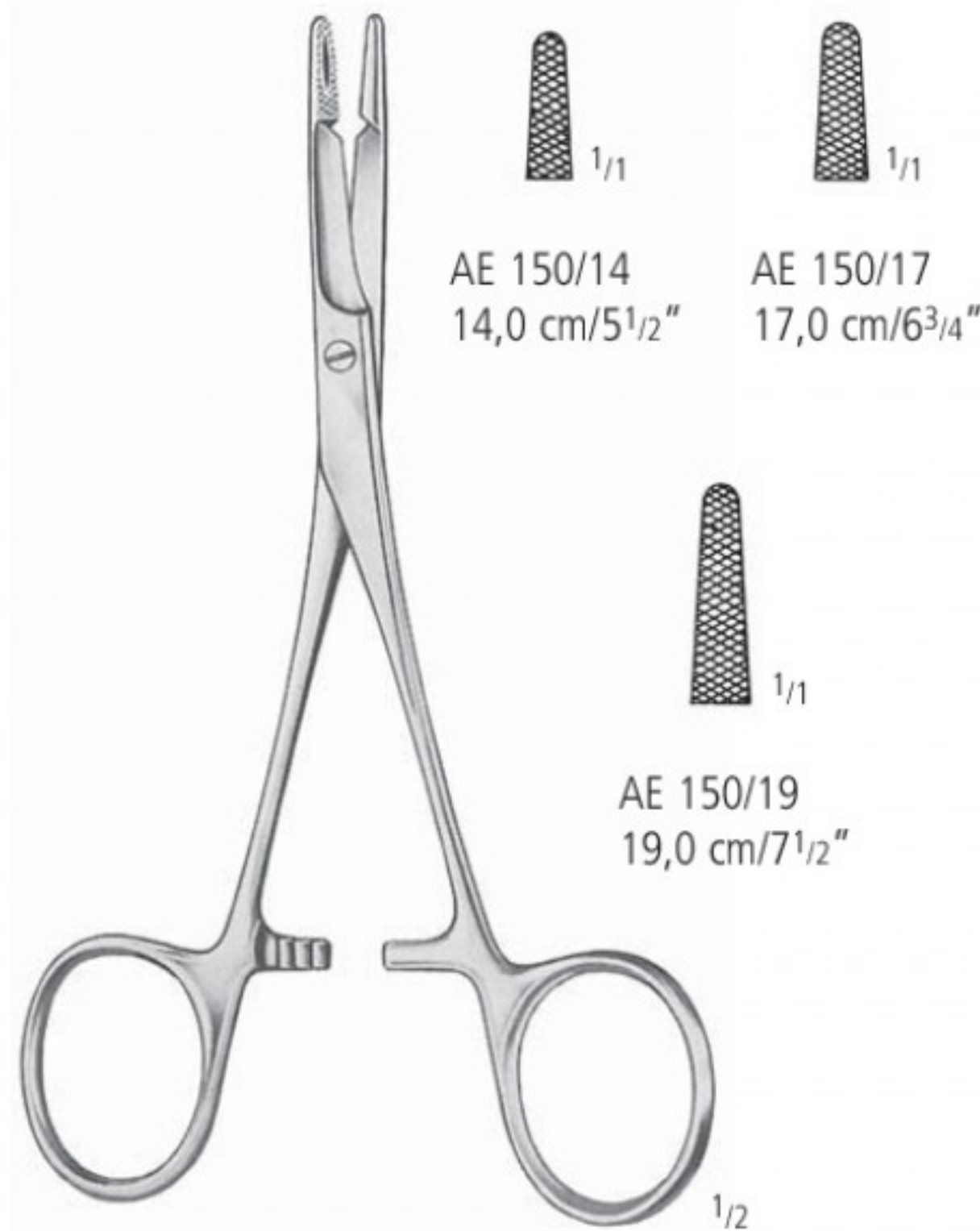

OLSEN-HEGAR

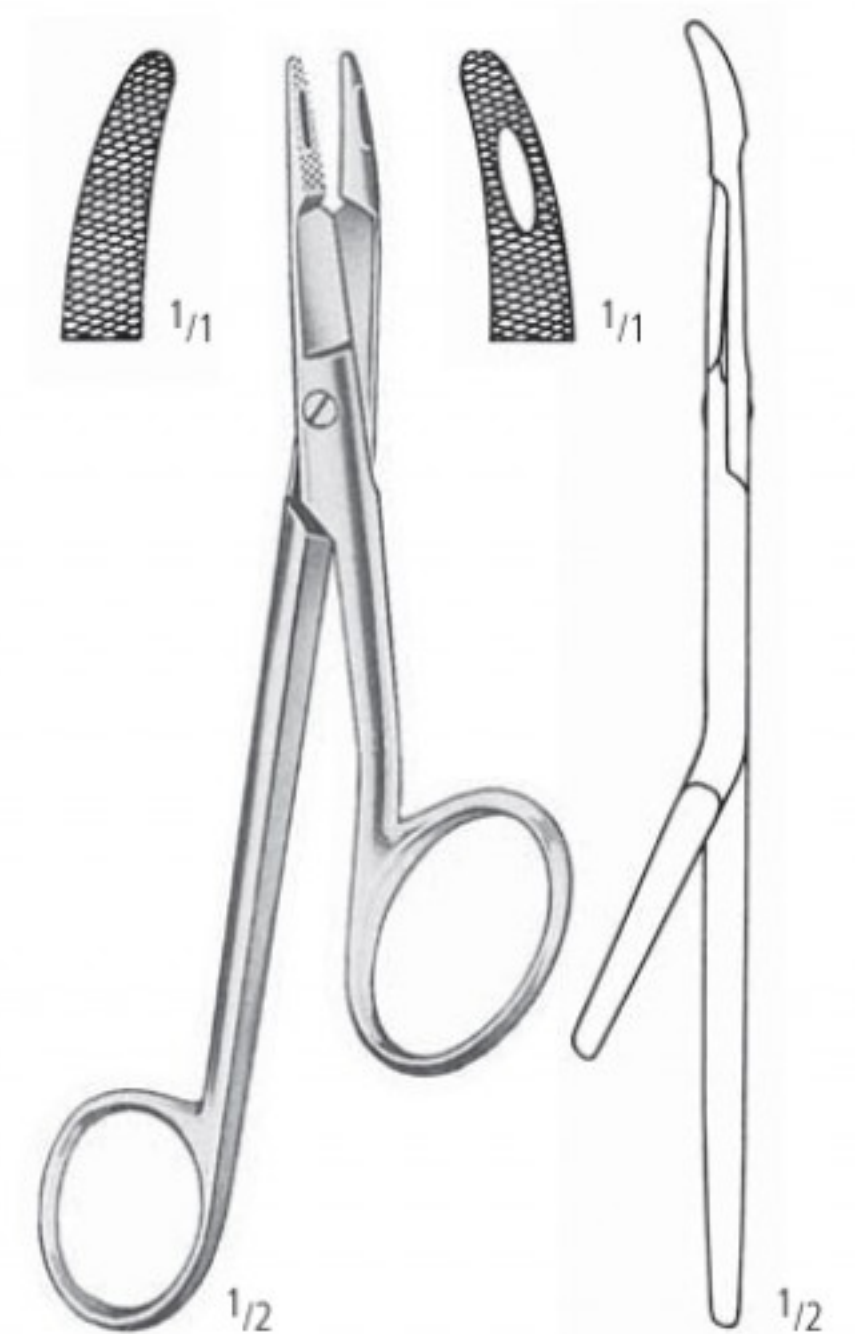

GILLIES
AE 155/16
16,0 cm/6¹/₄"

AA
AB
AC
AD
AE
AF
AK
AL
AM
AO
AP
AR
KA
KB
KC
KD
KU
KY

AE NAHT SUTURE SUTURA SUTURE SUTURA

Nadelhalter
Needle Holders
Porta-agujas
Porte-aiguilles
Portaghi



MATHIEU



1/1

AE 200/14
14,0 cm/5¹/₂"



1/1

AE 200/17
17,0 cm/6³/₄"



1/1

AE 200/20
20,0 cm/8"



1/1

AE 200/24
24,0 cm/9¹/₂"



MATHIEU-DELICATE



1/1

AE 210/14
14,0 cm/5¹/₂"



1/1

AE 210/17
17,0 cm/6³/₄"

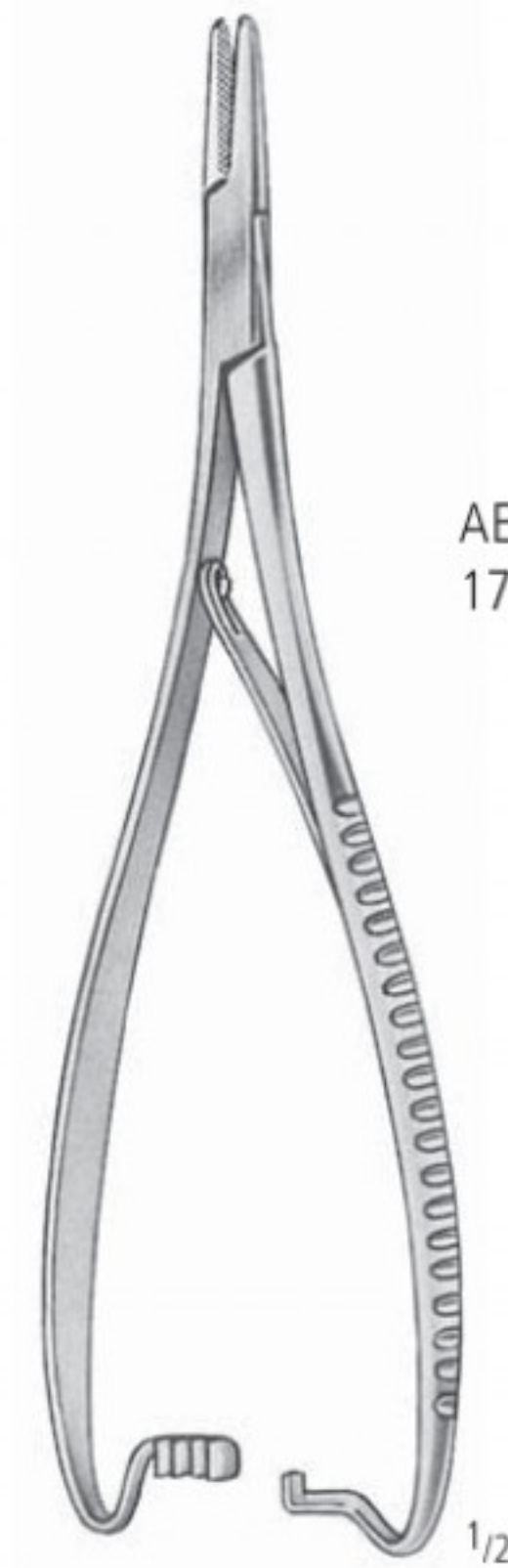

MATHIEU



1/1

AE 214/17
17,0 cm/6³/₄"



1/1

AE 214/20
20,0 cm/8"



1/1

AE 214/24
24,0 cm/9¹/₂"

NAHT SUTURE SUTURA SUTURE SUTURA

Nadelhalter
Needle Holders
Porta-agujas
Porte-aiguilles
Portaghi



LICHTENBERG



AE 216/20
20,0 cm/8"



AE 216/25
25,0 cm/10"

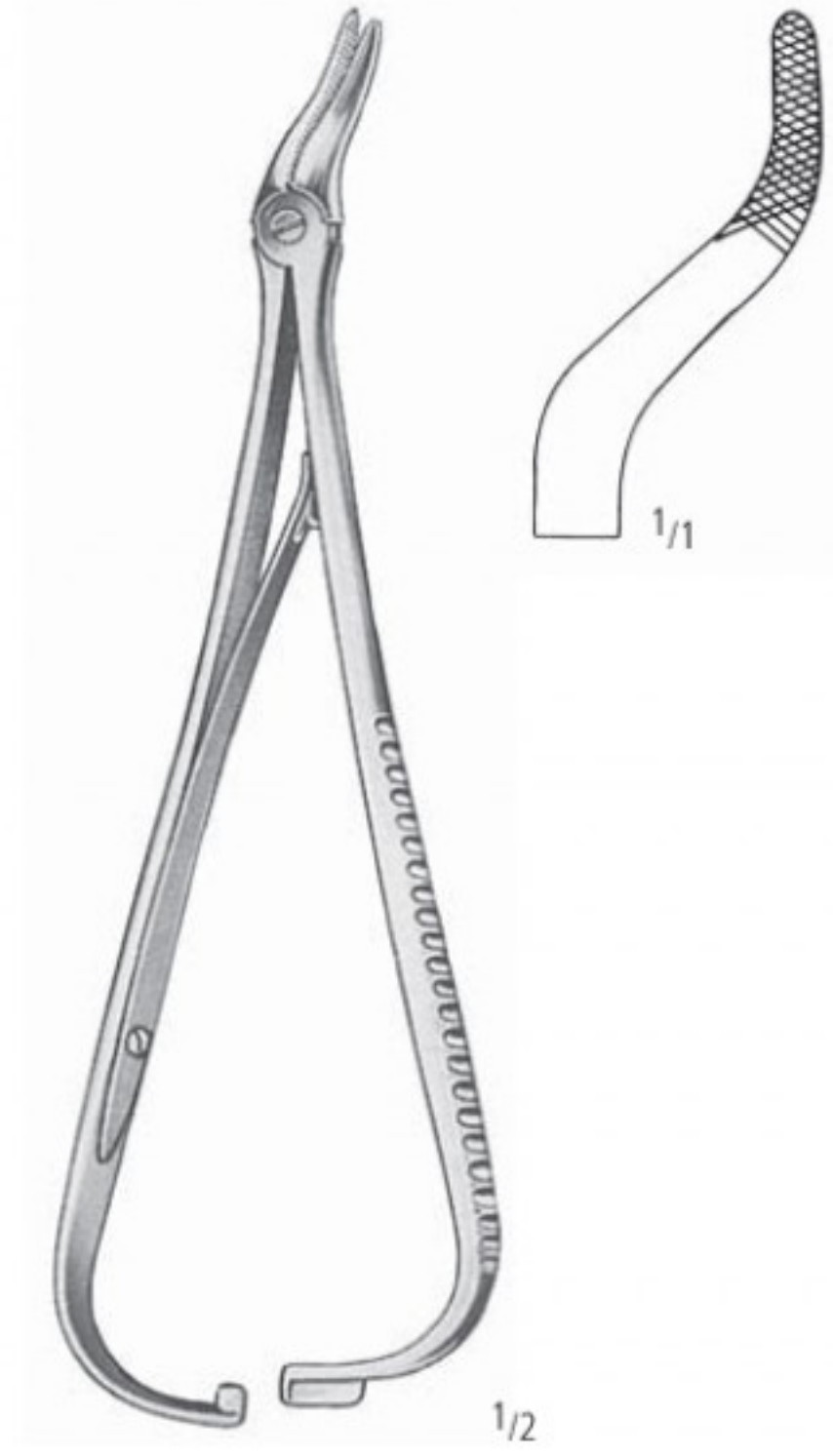

EISELSBERG-MATHIEU

AE 219/18
18,5 cm/7¹/₃"



ZWEIFEL



AE 222/20
20,0 cm/8"



AE 222/23
23,0 cm/9"



CRILE

AE 224/15
15,0 cm/6"



AA
AB
AC
AD
AE
AF
AK
AL
AM
AO
AP
AR
KA
KB
KC
KD
KU
KY

AE NAHT SUTURE SUTURA SUTURE SUTURA

Nadelhalter
Needle Holders
Porta-agujas
Porte-aiguilles
Portaghi



TOENNIS
AE 226/18
18,0 cm/7"



LANGENBECK

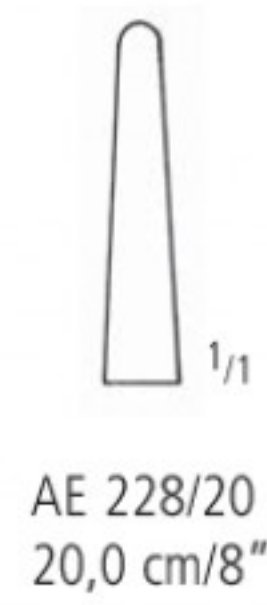
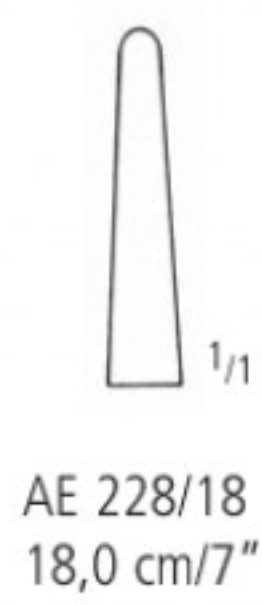
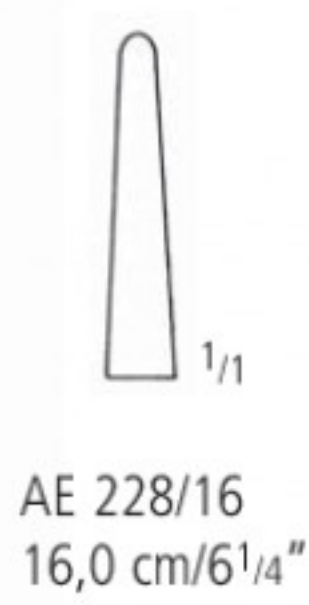

HÖSEL
AE 230/25
25,0 cm/10"

NAHT SUTURE SUTURA SUTURE SUTURA

Nadelhalter
Needle Holders
Porta-agujas
Porte-aiguilles
Portaghi



YOUNG-MILLIN

AE 300/20

20,0 cm/8"

mit 1 Nadel AE 301/01
with 1 needle AE 301/01
con 1 aguja AE 301/01
avec 1 aiguille AE 301/01
con 1 ago AE 301/01



YOUNG-HYRNTSCHAK

AE 300/24

24,0 cm/9 1/2"

mit 1 Nadel AE 301/01
with 1 needle AE 301/01
con 1 aguja AE 301/01
avec 1 aiguille AE 301/01
con 1 ago AE 301/01



AE 301/01



AE 301/02



AE 301/03

AA
AB
AC
AD
AE
AF
AK
AL
AM
AO
AP
AR
KA
KB
KC
KD
KU
KY

AE NAHT SUTURE SUTURA SUTURE SUTURA

Hartmetalleinsatzplättchen mit Pyramidenprofil
 Tungsten Carbide Tips with pyramidal profile
 Bocas de carburo de tungsteno con perfil de estructura piramidal
 Plaquettes en carbure de tungstène avec profil pyramidal
 Placche di carburo di tungsteno con profilo in forma piramidale

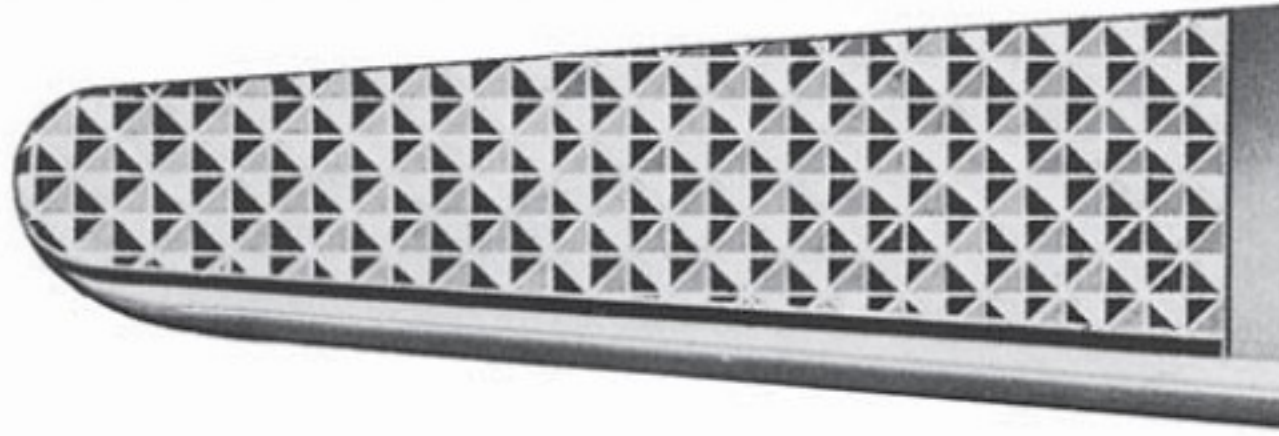

Teilung:	0,5 mm	Für Nahtmaterial 3/0 und größer
Serration:	0,5 mm	For suture sizes 3/0 and larger
Graduación:	0,5 mm	Para sutura 3/0 y más grande
Graduation:	0,5 mm	Pour suture 3/0 et plus grand
Graduazione:	0,5 mm	Per sutura 3/0 e più grande

"STANDARD"

(Mayo-Hegar, Mathieu, Bozeman, New Orleans, Stratte, etc.)

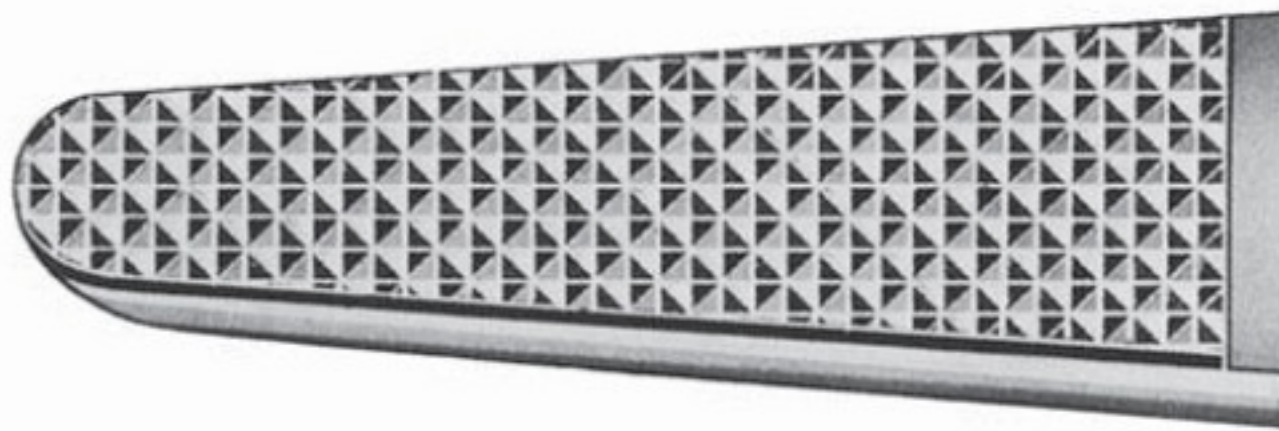

Teilung:	0,4 mm	Für Nahtmaterial zwischen 3/0 und 6/0
Serration:	0,4 mm	For sutures sizes between 3/0 and 6/0
Graduación:	0,4 mm	Para suturas entre 3/0 y 6/0
Graduation:	0,4 mm	Pour sutures entre 3/0 et 6/0
Graduazione:	0,4 mm	Per sutura tra 3/0 e 6/0

"FINE"

(Crile-Wood, Halsey, DeBakey, Ryder, etc.)

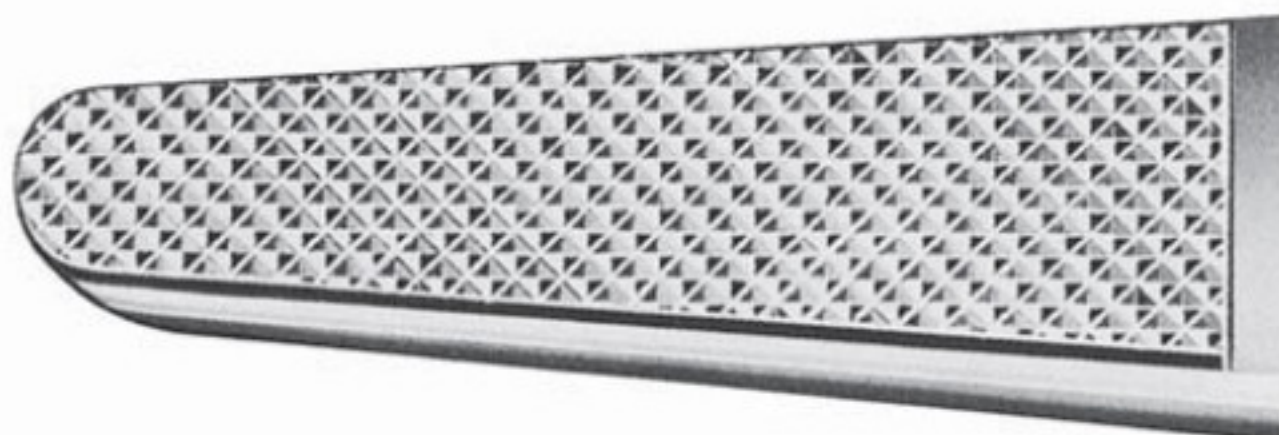

Teilung:	0,2 mm	Für Nahtmaterial zwischen 7/0 und 10/0
Serration:	0,2 mm	For sutures sizes between 7/0 and 10/0
Graduación:	0,2 mm	Para suturas entre 7/0 y 10/0
Graduation:	0,2 mm	Pour sutures entre 7/0 et 10/0
Graduazione:	0,2 mm	Per sutura tra 7/0 e 10/0

"MICRO"

(Micro Ryder, Microvascular, Castroviejo, etc.)

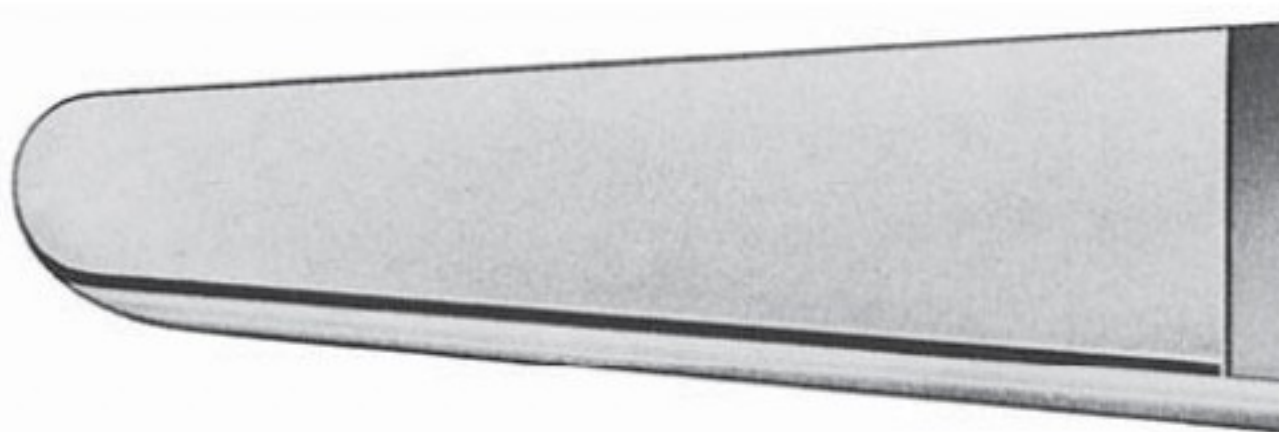

glatt	Für extrem feines Nahtmaterial
smooth	For the smallest suture sizes available
lisa	Para suturas extremamente finas
lisses	Pour matériel de suture extrêmement fin
liscio	Per materiale di sutura finissima

"SMOOTH"

(Eufrate Pasqué, Castroviejo, Jacobson, etc.)

NAHT SUTURE SUTURA SUTURE SUTURA

nopa-Service, Ersatzteile und Aufarbeitung aller Fabrikate
 nopa-Service, Spare Inserts and Refurbishing of all brands
 Servicio-nopa, piezas de recambio y renovar de todas las marcas
 Service-nopa, pièces de rechange et remise à neuf de toutes les marques
 Servizio-nopa, pezzi di ricambio e riparazione di tutte le marche

TUC-Einsätze
TUC-Inserts
TUC-Bocas
TUC-Plaquettes
TUC-Placche

AE 380/15	Smooth, 15 mm
AE 380/17	Smooth, 17 mm
AE 380/19	Smooth, 19 mm
AE 382/15	Micro, 0.2, 15 mm
AE 382/17	Micro, 0.2, 17 mm
AE 382/19	Micro, 0.2, 19 mm
AE 384/15	Fine, 0.4, 15 mm
AE 384/17	Fine, 0.4, 17 mm
AE 384/19	Fine, 0.4, 19 mm
AE 385/15	Standard, 0.5, 15 mm
AE 385/17	Standard, 0.5, 17 mm
AE 385/19	Standard, 0.5, 19 mm

Reparaturservice
Repair-Service
Servicio de reparación
Service de réparation
Servizio di riparazione

AE 390/00
 neue Plättchen einsetzen, aufarbeiten, Ringe vergolden
 replacement of inserts, refurbishing, gold handles refinished
 soldar bocas nuevas, reparar, dorar los anillos
 brasage des nouvelles plaquettes, remise à neuf, redorer les anneaux
 saldare placche nuove, rinnovare, dorare gli anelli

AE 390/01
 neue Plättchen einsetzen, aufarbeiten
 replacement of inserts, refurbishing
 soldar bocas nuevas, reparar
 brasage des nouvelles plaquettes, remise à neuf
 saldare placche nuove, rinnovare

AE 390/02
 neue Plättchen einsetzen
 replacement of inserts
 soldar bocas nuevas
 brasage des nouvelles plaquettes
 saldare placche nuove

AE 390/03
 aufarbeiten
 refurbishing
 reparar
 remise à neuf
 rinnovare

AE 390/04
 Ringe vergolden
 gold handles refinished
 dorar los anillos
 redorer les anneaux
 dorare gli anelli

AA
 AB
 AC
 AD
 AE
 AF
 AG
 AH
 AI
 AJ
 AK
 AL
 AM
 AN
 AO
 AP
 AQ
 AR
 AS
 AT
 AU
 AV
 AW
 AX
 AY
 AZ

AE NAHT SUTURE SUTURA SUTURE SUTURA

Nadelhalter mit Hartmetalleinsätzen
 Needle Holders with Tungsten Carbide Inserts
 Porta-agujas con bocas de carburo de Tungsteno
 Porte-aiguilles à mors en carbure de tungstène
 Portaghi con placche di carburo di tungsteno



MAYO-HEGAR



AE 400/14
14,0 cm/5¹/₂"



AE 400/16
16,0 cm/6¹/₄"



AE 400/18
18,0 cm/7"



AE 400/20
20,0 cm/8"



AE 400/24
24,0 cm/9¹/₂"



AE 400/26
26,0 cm/10¹/₂"



AE 400/30
30,0 cm/12"



**DE-BAKEY
 (MAYO-HEGAR-DELICATE)**



AE 420/18
18,0 cm/7"



AE 420/20
20,0 cm/8"



AE 420/23
23,0 cm/9"



AE 420/26
26,0 cm/10¹/₂"



AE 420/31
31,0 cm/12¹/₄"

NAHT SUTURE SUTURA SUTURE SUTURA

Nadelhalter mit Hartmetalleinsätzen
 Needle Holders with Tungsten Carbide Inserts
 Porta-agujas con bocas de carburo de Tungsteno
 Porte-aiguilles à mors en carbure de tungstène
 Portaghi con placche di carburo di tungsteno

AA
AB
AC
AD
AE
AF
AK
AL
AM
AO
AP
AR
KA
KB
KC
KD
KU
KY

RYDER/FRENCH-EYE

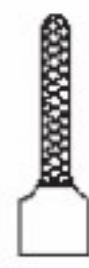

AE 430/13
13,0 cm/5"



AE 430/15
15,0 cm/6"



AE 430/18
18,0 cm/7"



AE 430/20
20,0 cm/8"



AE 430/23
23,0 cm/9"

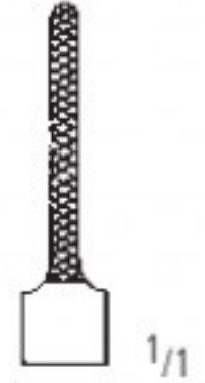

AE 430/26
26,0 cm/10¹/₂"

MICRO RYDER



AE 434/13
13,0 cm/5"



AE 434/15
15,0 cm/6"



AE 434/18
18,0 cm/7"



AE 434/20
20,0 cm/8"



AE 434/23
23,0 cm/9"



AE 434/26
26,0 cm/10¹/₂"



AE 436/14
14,0 cm/5¹/₂"



AE 436/18
18,0 cm/7"



AE 436/20
20,0 cm/8"



AE 436/23
23,0 cm/9"



AE 438/14
14,0 cm/5¹/₂"



AE 438/18
18,0 cm/7"



AE 438/20
20,0 cm/8"



AE 438/23
23,0 cm/9"



EUFRATE PASQUÉ

MICROVASCULAR

extrem fein
 extremely delicate
 muy fino
 très fin
 molto fino

AE NAHT SUTURE SUTURA SUTURE SUTURA

Nadelhalter mit Hartmetalleinsätzen
 Needle Holders with Tungsten Carbide Inserts
 Porta-agujas con bocas de carburo de Tungsteno
 Porte-aiguilles à mors en carbure de tungstène
 Portaghi con placche di carburo di tungsteno

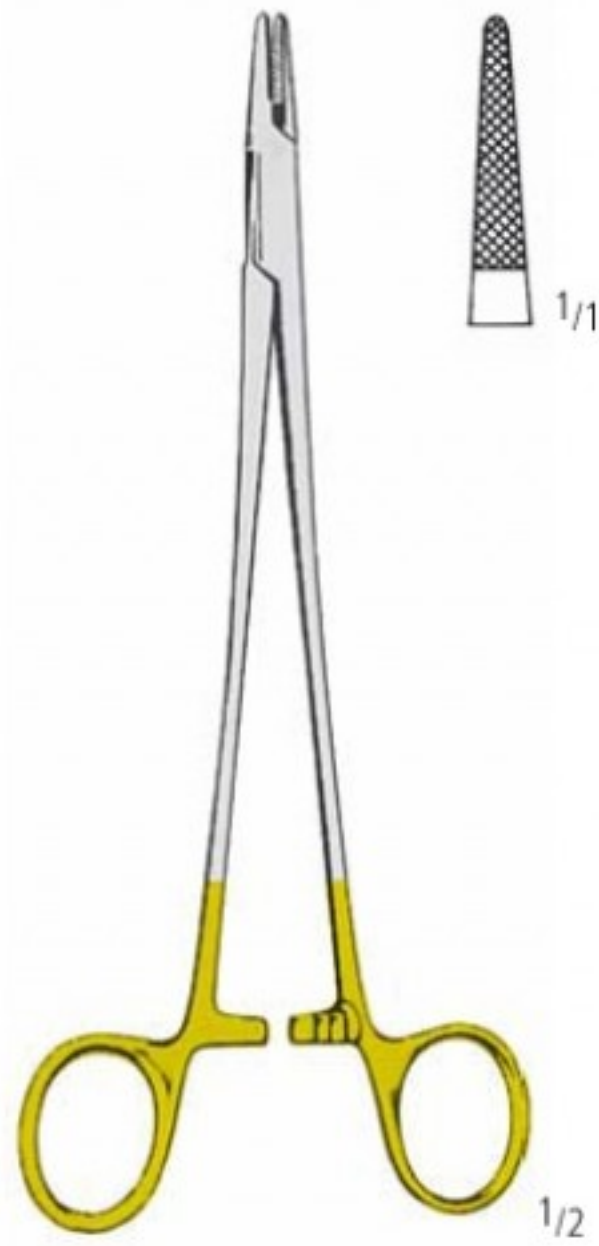

CARROLL
 AE 440/15
 15,0 cm/6"

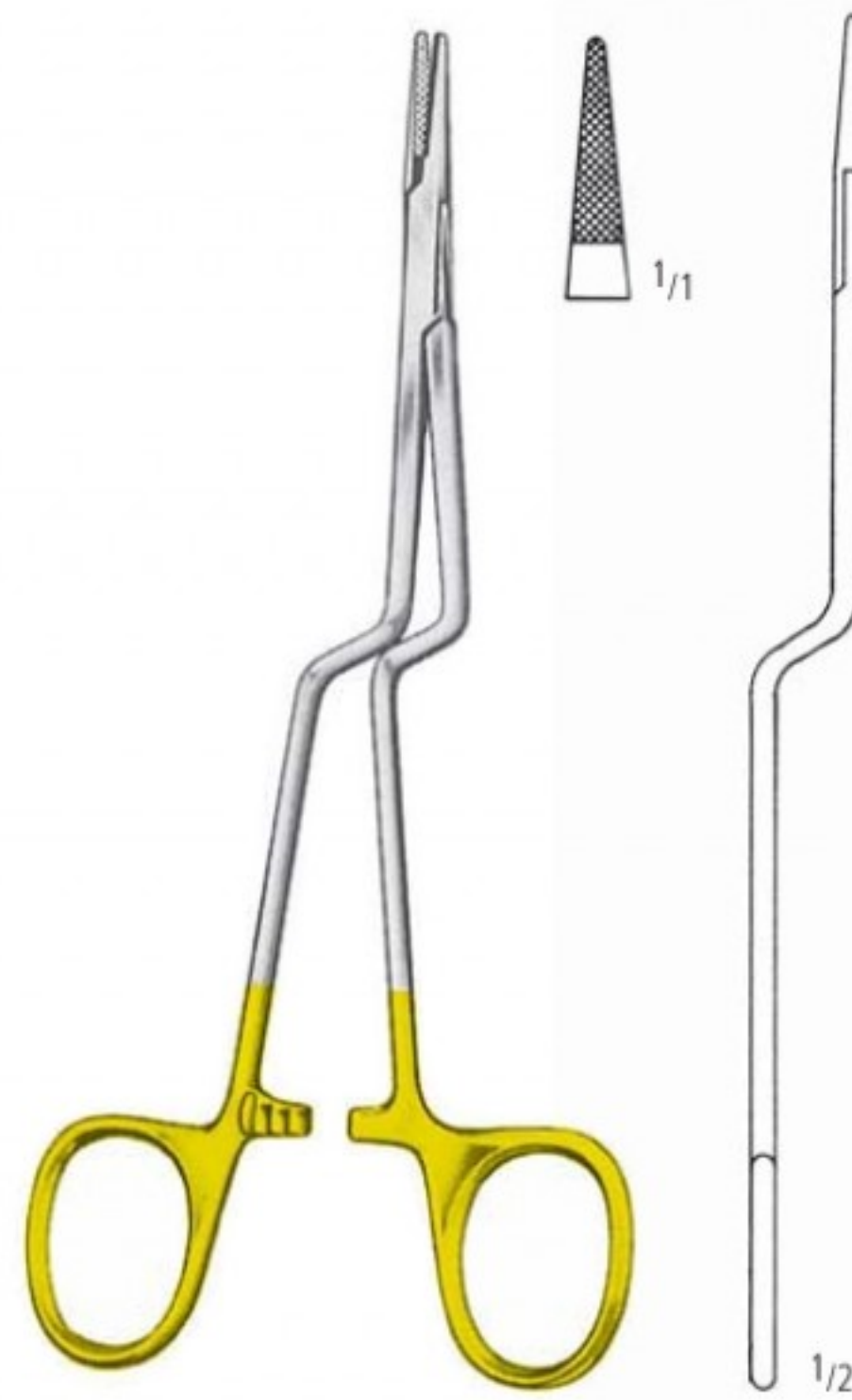

JACOBSON
 AE 444/18
 18,0 cm/7"



NEW ORLEANS
 AE 446/18
 18,0 cm/7"



SENNING
 (SWEDISH PATTERN)

AE 448/15
 15,0 cm/6"

AE 448/17
 17,0 cm/6³/₄"

NAHT SUTURE SUTURA SUTURE SUTURA

Nadelhalter mit Hartmetalleinsätzen
 Needle Holders with Tungsten Carbide Inserts
 Porta-agujas con bocas de carburo de Tungsteno
 Porte-aiguilles à mors en carbure de tungstène
 Portaghi con placche di carburo di tungsteno



DERF
 AE 450/12
 12,5 cm/5"

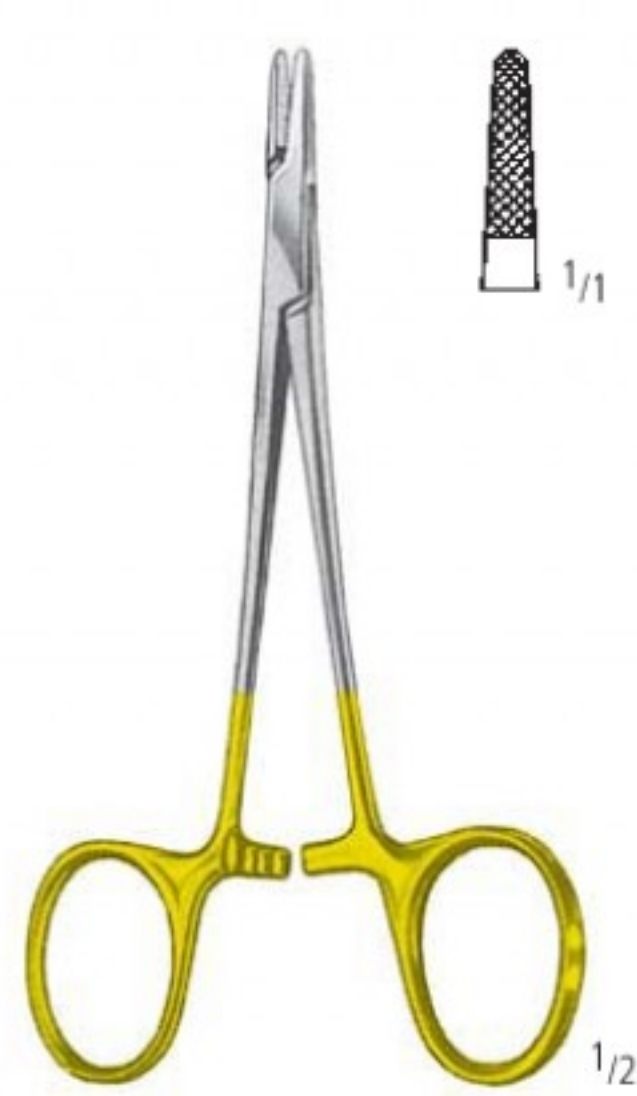

CONVERSE
 AE 452/12
 12,5 cm/5"

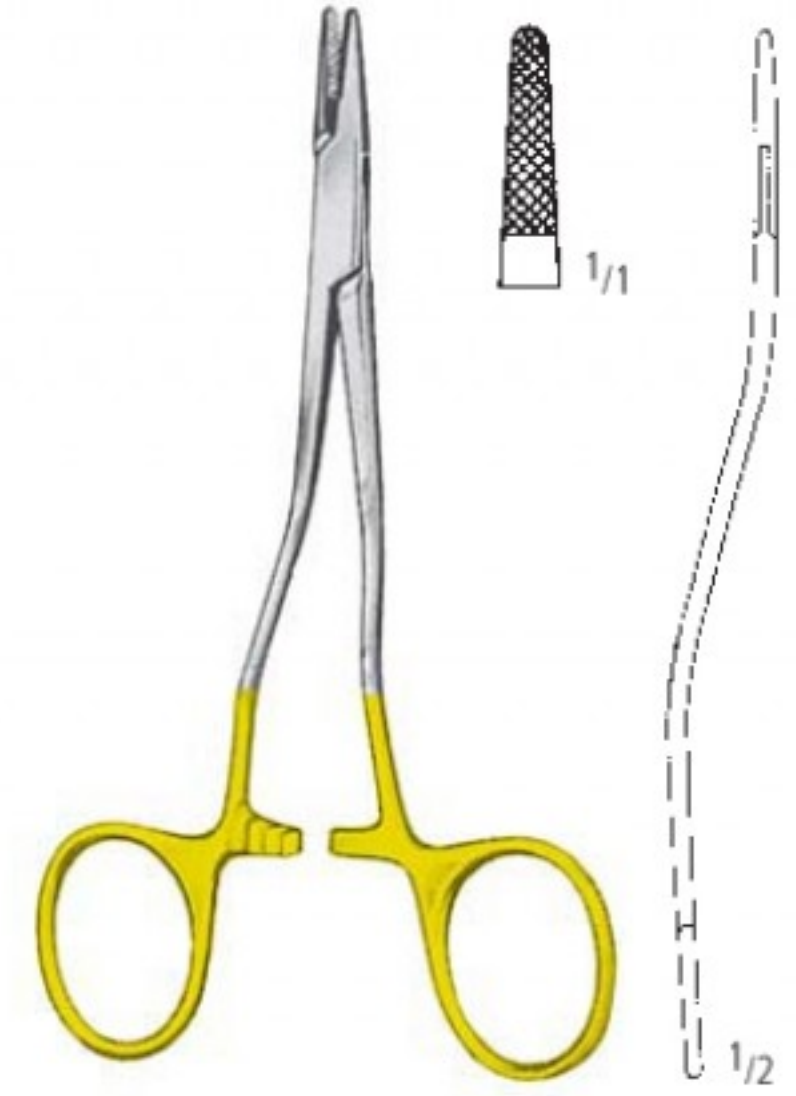

KILNER
 AE 455/13
 13,5 cm/5 1/4"

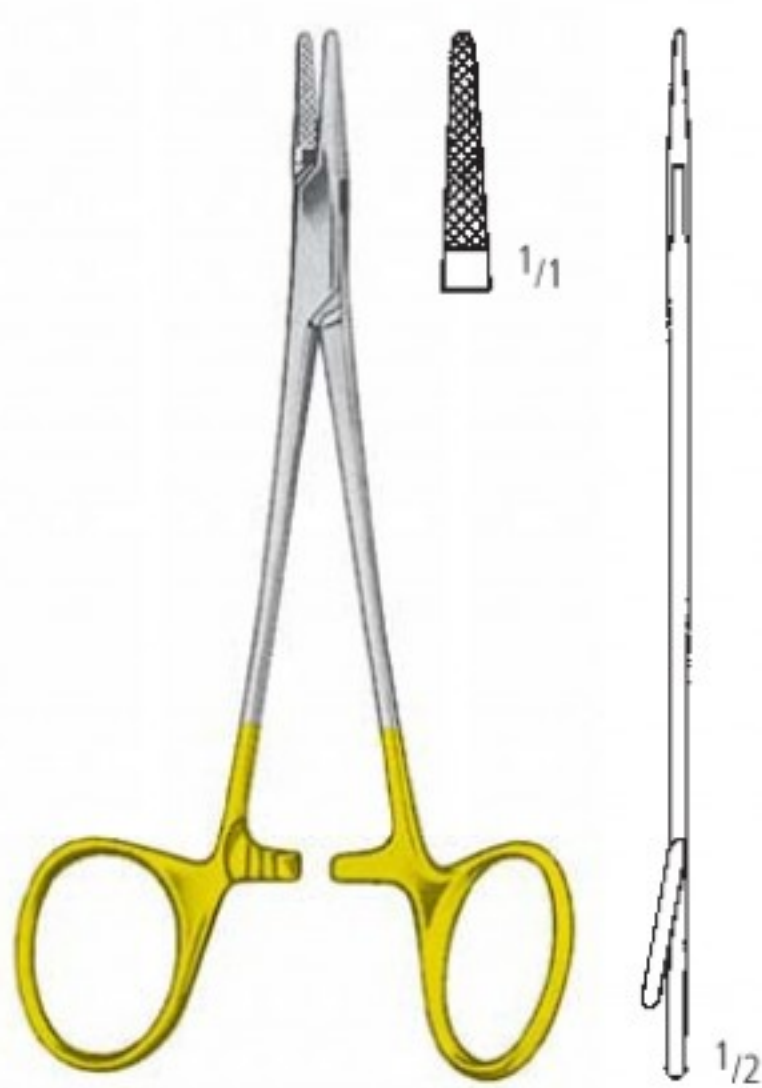

NEIVERT
 AE 456/13
 13,0 cm/5"



WEBSTER
 AE 460/13
 13,0 cm/5"

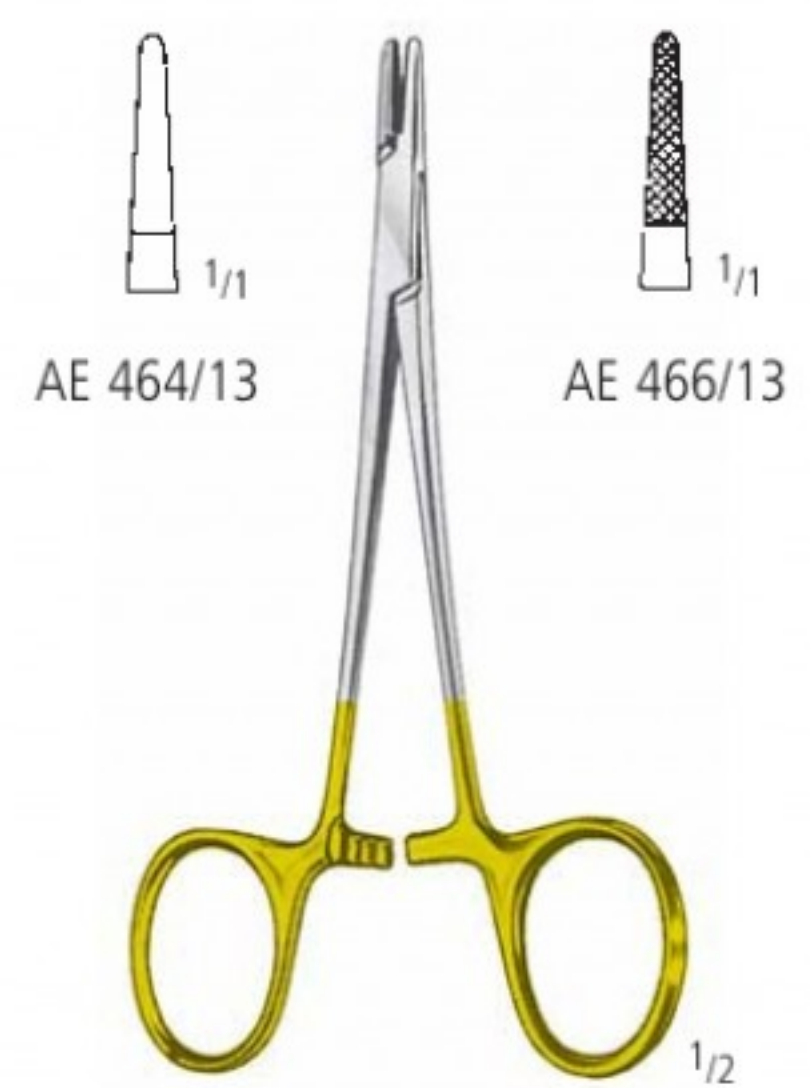

HALSEY
 13,0 cm/5"

AA
 AB
 AC
 AD
AE
 AF
 AG
 AH
 AI
 AJ
 AK
 AL
 AM
 AN
 AO
 AP
 AQ
 AR
 AS
 AT
 AU
 AV
 AW
 AX
 AY
 AZ

AE NAHT SUTURE SUTURA SUTURE SUTURA

Nadelhalter mit Hartmetalleinsätzen
 Needle Holders with Tungsten Carbide Inserts
 Porta-agujas con bocas de carburo de Tungsteno
 Porte-aiguilles à mors en carbure de tungstène
 Portaghi con placche di carburo di tungsteno



BABY-CRILE-WOOD
 AE 468/15
 15,0 cm/6"



CRILE-WOOD
 AE 469/15
 15,0 cm/6"

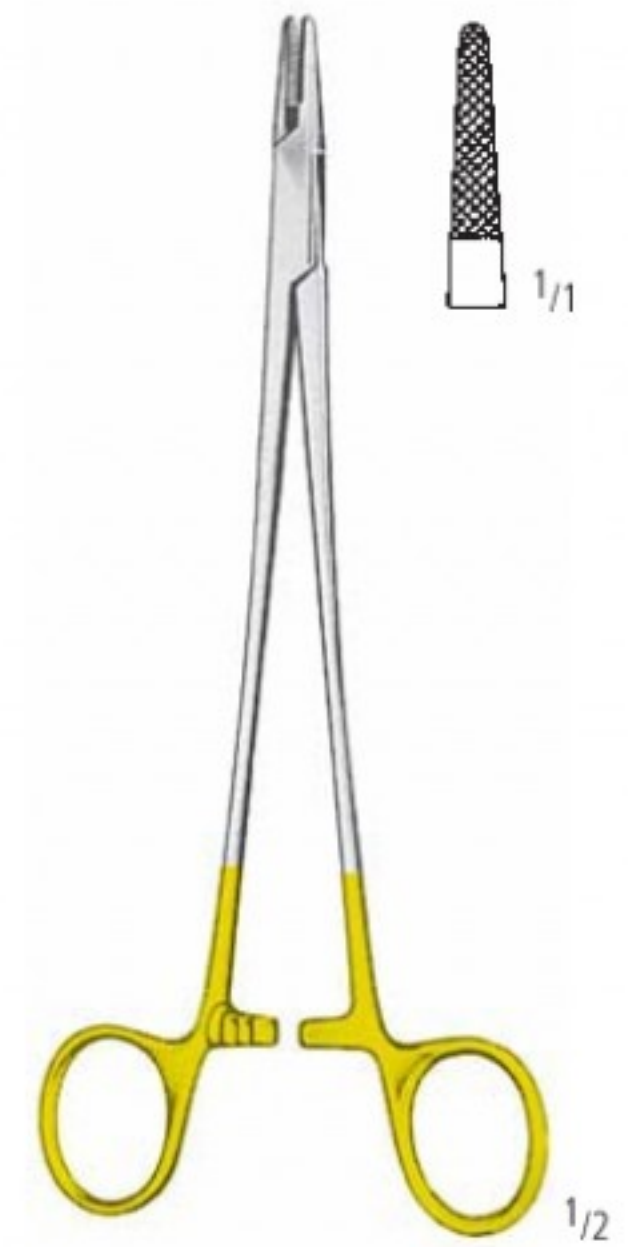

CRILE-WOOD
 AE 470/15
 15,0 cm/6"

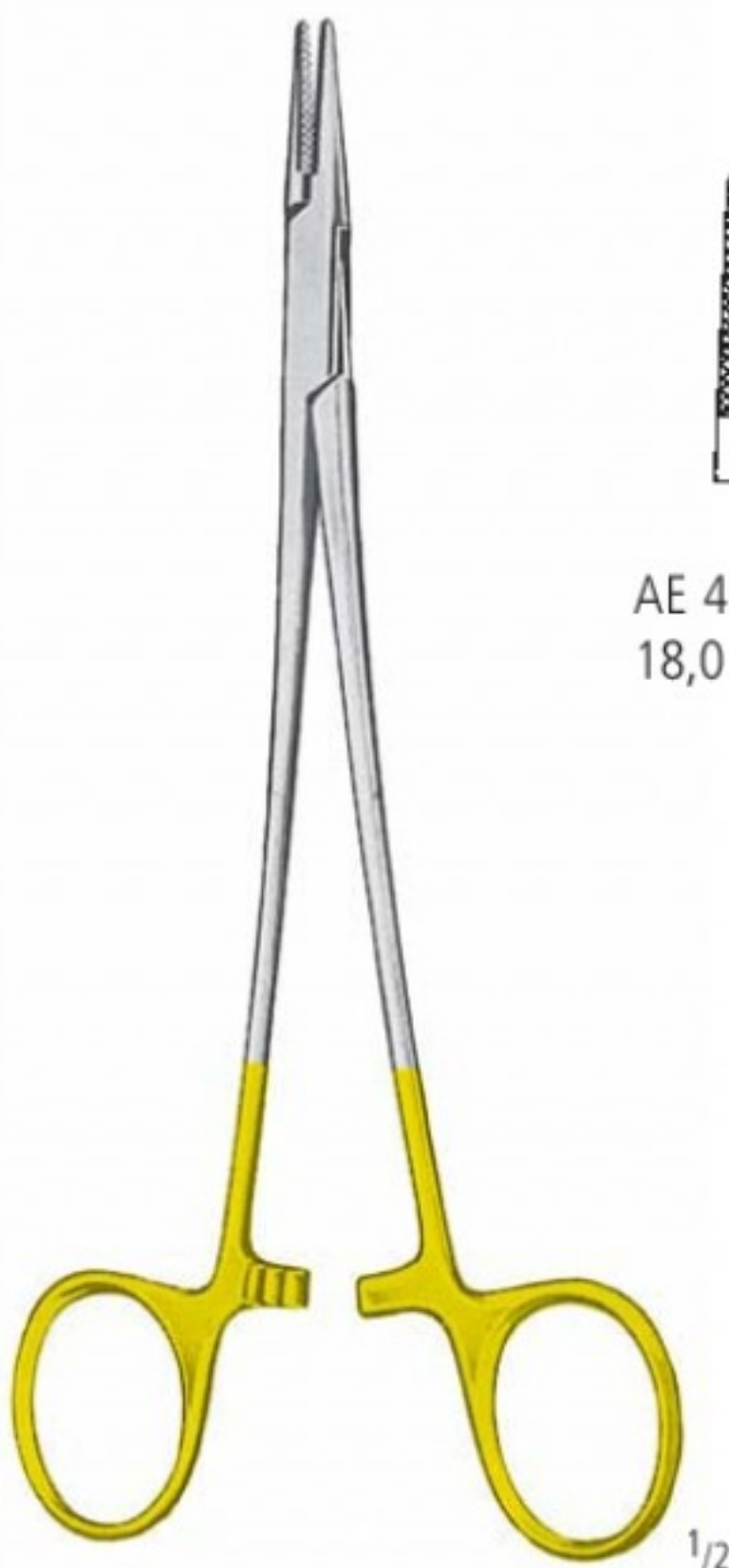

CRILE-WOOD



AE 470/18
 18,0 cm/7"



AE 470/20
 20,0 cm/8"



AE 470/23
 23,0 cm/9"



AE 471/18
 18,0 cm/7"



AE 471/23
 23,0 cm/9"

NAHT SUTURE SUTURA SUTURE SUTURA

Nadelhalter mit Hartmetalleinsätzen
 Needle Holders with Tungsten Carbide Inserts
 Porta-agujas con bocas de carburo de Tungsteno
 Porte-aiguilles à mors en carbure de tungstène
 Portaghi con placche di carburo di tungsteno



FINOCCHIETTO
 AE 472/27
 27,0 cm/10³/₄"

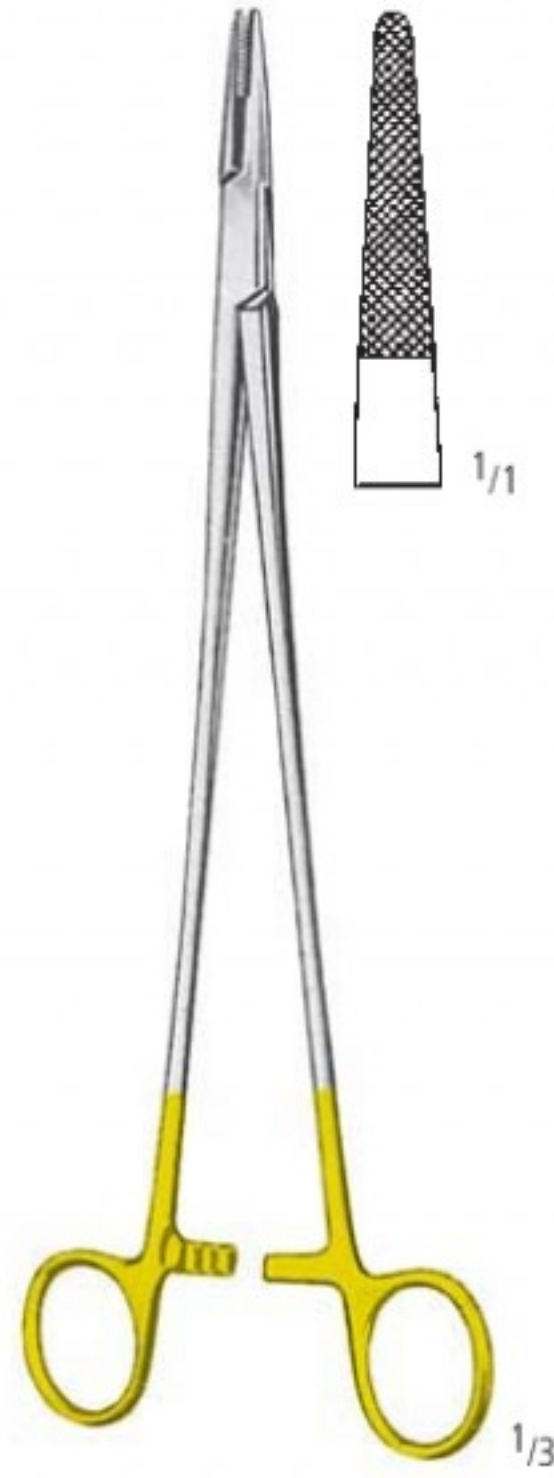

WANGENSTEEN
 AE 474/27
 27,0 cm/10³/₄"



BOZEMANN

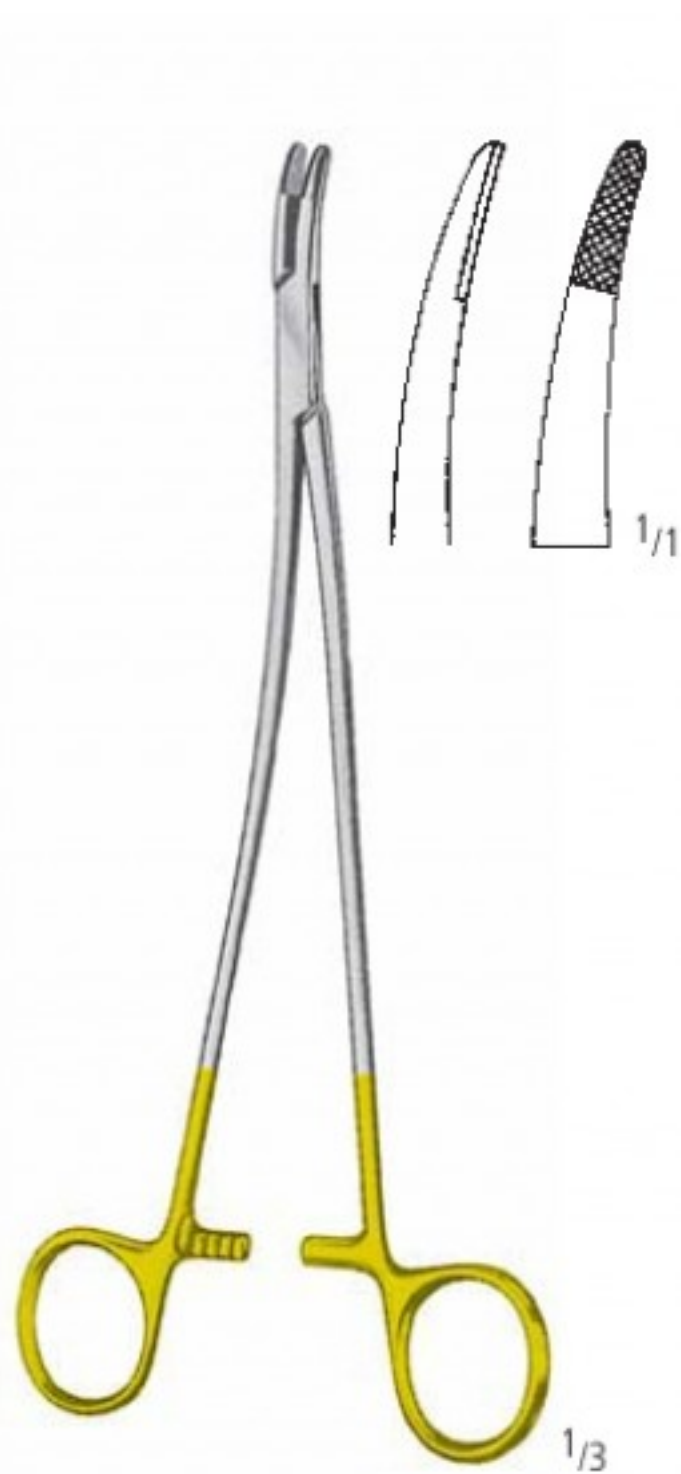
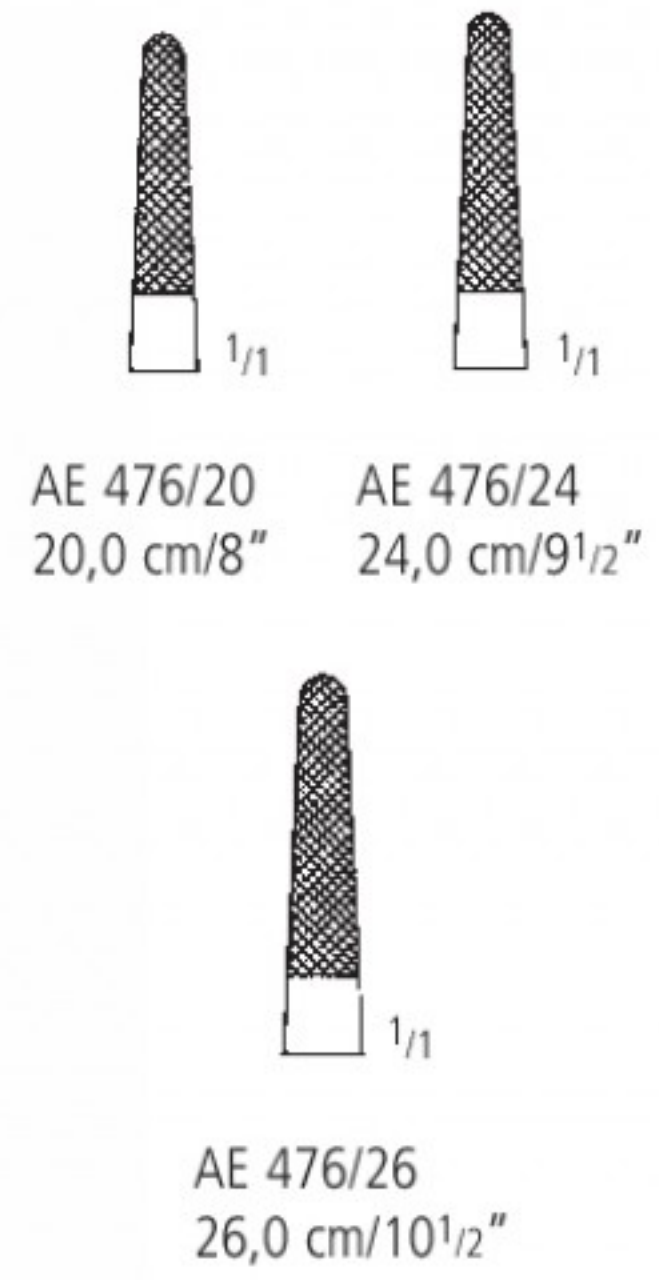

STRATTE
 AE 478/23
 23,0 cm/9"



SAROT

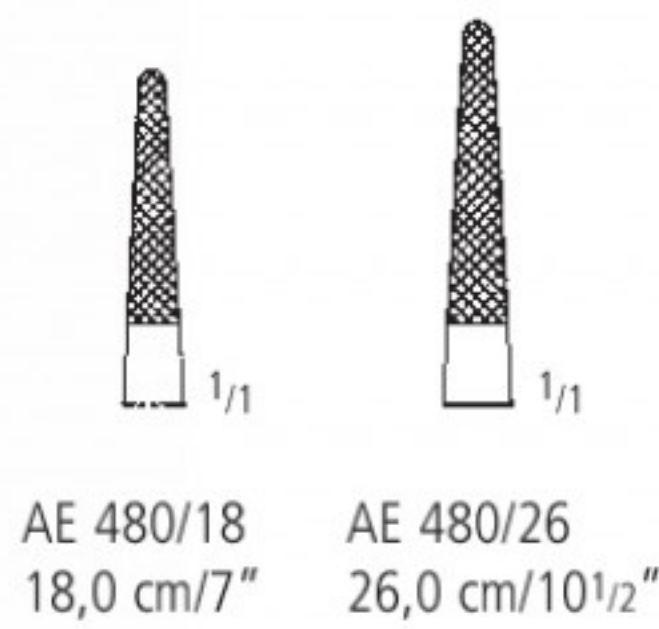

MASSON
 AE 482/27
 27,0 cm/10³/₄"

AA
 AB
 AC
 AD
AE
 AF
 AG
 AH
 AI
 AJ
 AK
 AL
 AM
 AN
 AO
 AP
 AQ
 AR
 AS
 AT
 AU
 AV
 AW
 AX
 AY
 AZ

AE NAHT SUTURE SUTURA SUTURE SUTURA

Nadelhalter mit Hartmetalleinsätzen
 Needle Holders with Tungsten Carbide Inserts
 Porta-agujas con bocas de carburo de Tungsteno
 Porte-aiguilles à mors en carbure de tungstène
 Portaghi con placche di carburo di tungsteno



WERTHEIM



AE 487/20
20,0 cm/8"



AE 487/24
24,0 cm/9¹/₂"



AE 487/30
30,0 cm/12"



OLSEN-HEGAR



AE 488/14
14,0 cm/5¹/₂"



AE 488/17
17,0 cm/6³/₄"



AE 488/19
19,0 cm/7¹/₂"



AE 490/16
16,0 cm/6¹/₄"

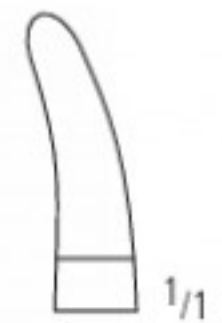

AE 491/16
16,0 cm/6¹/₄"



GILLIES

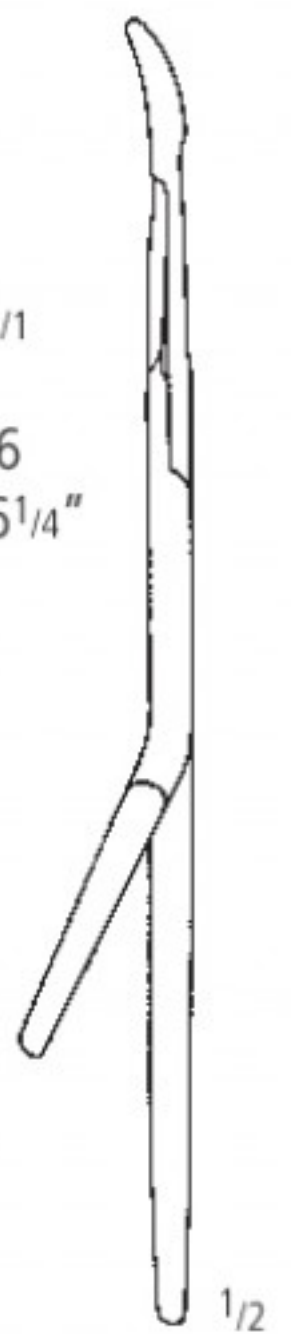

NAHT SUTURE SUTURA SUTURE SUTURA

Nadelhalter mit Hartmetalleinsätzen
 Needle Holders with Tungsten Carbide Inserts
 Porta-agujas con bocas de carburo de Tungsteno
 Porte-aiguilles à mors en carbure de tungstène
 Portaghi con placche di carburo di tungsteno

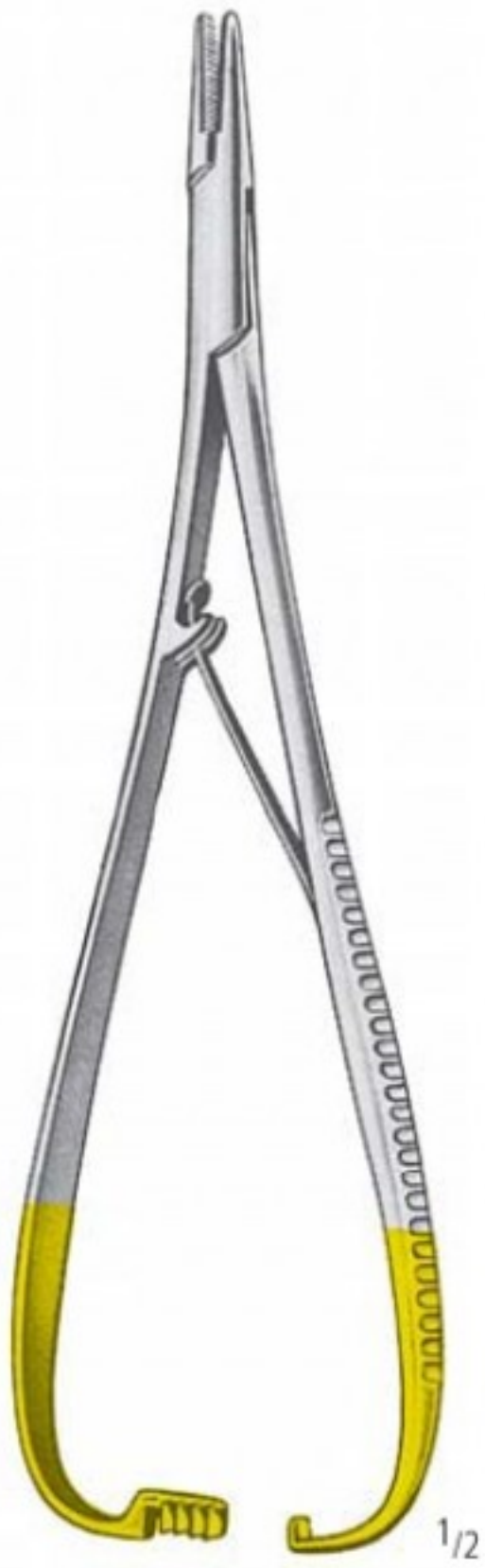

MATHIEU



AE 500/14
14,0 cm/5¹/₂"



AE 500/17
17,0 cm/6³/₄"



AE 500/20
20,0 cm/8"



AE 500/24
24,0 cm/9¹/₂"



MATHIEU



AE 501/14
14,0 cm/5¹/₂"



MATHIEU



AE 502/17
17,0 cm/6³/₄"



AE 502/20
20,0 cm/8"



AE 502/23
23,0 cm/9"



MATHIEU-DELICATE



AE 504/14
14,0 cm/5¹/₂"



AE 504/17
17,0 cm/6³/₄"



AE 504/20
20,0 cm/8"



METZENBAUM



AE 507/17
17,0 cm/6³/₄"



AE 507/19
19,5 cm/7¹/₂"

AA
AB
AC
AD
AE
AF
AG
AH
AI
AJ
AK
AL
AM
AN
AO
AP
AQ
AR
AS
AT
AU
AV
AW
AX
AY
AZ
BA
BB
BC
BD
BE
BF
BG
BH
BI
BJ
BK
BL
BM
BN
BO
BP
BQ
BR
BS
BT
BU
BV
BW
BX
BY
BZ
CA
CB
CC
CD
CE
CF
CG
CH
CI
CJ
CK
CL
CM
CN
CO
CP
CQ
CR
CS
CT
CU
CV
CW
CX
CY
CZ
DA
DB
DC
DD
DE
DF
DG
DH
DI
DJ
DK
DL
DM
DN
DO
DP
DQ
DR
DS
DT
DU
DV
DW
DX
DY
DZ
EA
EB
EC
ED
EE
EF
EG
EH
EI
EJ
EK
EL
EM
EN
EO
EP
EQ
ER
ES
ET
EU
EV
EW
EX
EY
EZ
FA
FB
FC
FD
FE
FF
FG
FH
FI
FJ
FK
FL
FM
FN
FO
FP
FQ
FR
FS
FT
FU
FV
FW
FX
FY
FZ
GA
GB
GC
GD
GE
GF
GG
GH
GI
GJ
GK
GL
GM
GN
GO
GP
GQ
GR
GS
GT
GU
GV
GW
GX
GY
GZ
HA
HB
HC
HD
HE
HF
HG
HH
HI
HJ
HK
HL
HM
HN
HO
HP
HQ
HR
HS
HT
HU
HV
HW
HX
HY
HZ
IA
IB
IC
ID
IE
IF
IG
IH
II
IJ
IK
IL
IM
IN
IO
IP
IQ
IR
IS
IT
IU
IV
IW
IX
IY
IZ
JA
JB
JC
JD
JE
JF
JG
JH
JI
JJ
JK
JL
JM
JN
JO
JP
JQ
JR
JS
JT
JU
JV
JW
JX
JY
JZ
KA
KB
KC
KD
KE
KF
KG
KH
KI
KJ
KK
KL
KM
KN
KO
KP
KQ
KR
KS
KT
KU
KV
KW
KX
KY
KZ
LA
LB
LC
LD
LE
LF
LG
LH
LI
LJ
LK
LL
LM
LN
LO
LP
LQ
LR
LS
LT
LU
LV
LW
LX
LY
LZ
MA
MB
MC
MD
ME
MF
MG
MH
MI
MJ
MK
ML
MN
MO
MP
MQ
MR
MS
MT
MU
MV
MW
MX
MY
MZ
NA
NB
NC
ND
NE
NF
NG
NH
NI
NJ
NK
NL
NM
NO
NP
NQ
NR
NS
NT
NU
NV
NW
NX
NY
NZ
OA
OB
OC
OD
OE
OF
OG
OH
OI
OJ
OK
OL
OM
ON
OO
OP
OQ
OR
OS
OT
OU
OV
OW
OX
OY
OZ
PA
PB
PC
PD
PE
PF
PG
PH
PI
PJ
PK
PL
PM
PN
PO
PP
PQ
PR
PS
PT
PU
PV
PW
PX
PY
PZ
QA
QB
QC
QD
QE
QF
QG
QH
QI
QJ
QK
QL
QM
QN
QO
QP
QQ
QR
QS
QT
QU
QV
QW
QX
QY
QZ
RA
RB
RC
RD
RE
RF
RG
RH
RI
RJ
RK
RL
RM
RN
RO
RP
RQ
RR
RS
RT
RU
RV
RW
RX
RY
RZ
SA
SB
SC
SD
SE
SF
SG
SH
SI
SJ
SK
SL
SM
SN
SO
SP
SQ
SR
SS
ST
SU
SV
SW
SX
SY
SZ
TA
TB
TC
TD
TE
TF
TG
TH
TI
TJ
TK
TL
TM
TN
TO
TP
TQ
TR
TS
TT
TU
TV
TW
TX
TY
TZ
UA
UB
UC
UD
UE
UF
UG
UH
UI
UJ
UK
UL
UM
UN
UO
UP
UQ
UR
US
UT
UU
UV
UW
UX
UY
UZ
VA
VB
VC
VD
VE
VF
VG
VH
VI
VJ
VK
VL
VM
VN
VO
VP
VQ
VR
VS
VT
VU
VV
VW
VX
VY
VZ
WA
WB
WC
WD
WE
WF
WG
WH
WI
WJ
WK
WL
WM
WN
WO
WP
WQ
WR
WS
WT
WU
WV
WW
WX
WY
WZ
XA
XB
XC
XD
XE
XF
XG
XH
XI
XJ
XK
XL
XM
XN
XO
XP
XQ
XR
XS
XT
XU
XV
XW
XX
XY
XZ
YA
YB
YC
YD
YE
YF
YG
YH
YI
YJ
YK
YL
YM
YN
YO
YP
YQ
YR
YS
YT
YU
YV
YW
YX
YY
YZ
ZA
ZB
ZC
ZD
ZE
ZF
ZG
ZH
ZI
ZJ
ZK
ZL
ZM
ZN
ZO
ZP
ZQ
ZR
ZS
ZT
ZU
ZV
ZW
ZX
ZY
ZZ

AE NAHT SUTURE SUTURA SUTURE SUTURA

Nadelhalter mit Hartmetalleinsätzen
 Needle Holders with Tungsten Carbide Inserts
 Porta-agujas con bocas de carburo de Tungsteno
 Porte-aiguilles à mors en carbure de tungstène
 Portaghi con placche di carburo di tungsteno



MATHIEU-RYDER



AE 510/17
17,0 cm/6³/₄"



AE 510/20
20,0 cm/8"

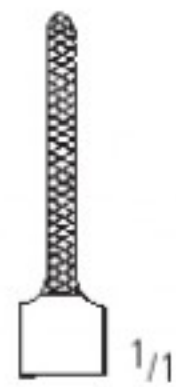

AE 510/24
24,0 cm/9¹/₂"



MATHIEU-RYDER VASCULAR

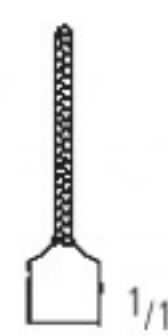

AE 512/17
17,0 cm/6³/₄"



AE 512/20
20,0 cm/8"



AE 512/24
24,0 cm/9¹/₂"

NAHT SUTURE SUTURA SUTURE SUTURA

Nadelhalter mit Hartmetalleinsätzen
 Needle Holders with Tungsten Carbide Inserts
 Porta-agujas con bocas de carburo de Tungsteno
 Porte-aiguilles à mors en carbure de tungstène
 Portaghi con placche di carburo di tungsteno



BOYNTON
12,0 cm/4³/₄"

ARRUGA
16,0 cm/6¹/₄"



HÖSEL
AE 520/25
25,0 cm/10"



TOENNIS
AE 522/18
18,0 cm/7"



LICHTENBERG
AE 524/20
20,0 cm/8"

AA
AB
AC
AD
AE
AF
AK
AL
AM
AO
AP
AR
KA
KB
KC
KD
KU
KY

AE NAHT SUTURE SUTURA SUTURE SUTURA

Nadelhalter mit Hartmetalleinsätzen
 Needle Holders with Tungsten Carbide Inserts
 Porta-agujas con bocas de carburo de Tungsteno
 Porte-aiguilles à mors en carbure de tungstène
 Portaghi con placche di carburo di tungsteno



AE 530/20
20,0 cm/8"



AE 530/23
23,0 cm/9"



EISELSBERG-MATHIEU
 AE 533/18
 18,5 cm/7¹/₃"



LUETHY-BECK
 AE 535/20
 20,0 cm/8"



AE 540/16
16,0 cm/6¹/₄"



AE 540/18
18,0 cm/7"



AE 540/20
20,0 cm/8"



AE 542/18
18,0 cm/7"



AE 542/20
20,0 cm/8"



AE 542/23
23,0 cm/9"



AE 544/18
18,0 cm/7"

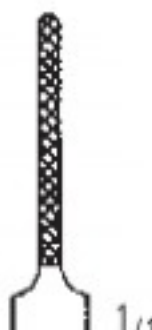

AE 544/20
20,0 cm/8"



AE 544/23
23,0 cm/9"

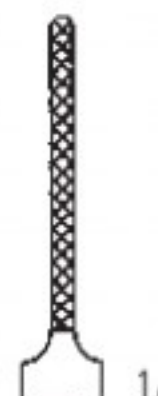

LANGENBECK

LANGENBECK-DELICATE

LANGENBECK-RYDER

NAHT SUTURE SUTURA SUTURE SUTURA

Drahtzangen mit Hartmetalleinsätzen
 Wire Twisting Forceps with Tungsten Carbide Inserts
 Pinzas para torcer hilos con bocas de carburo de Tungsteno
 Pinces à torsader le fil à mors en carbure de tungstène
 Pinze per ritorcere fili con placche di carburo di tungsteno



AE 550/13
13,0 cm/5"

STERNUM



AE 551/01
15,0 cm/6"



AE 552/18

18,5 cm/7¹/₄"



AE 554/01
5,0 mm

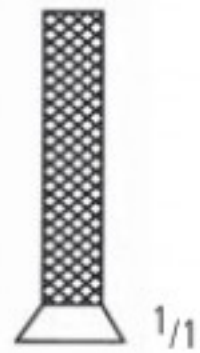

AE 554/02
3,0 mm



AE 554/03
7,0 mm

18,0 cm/7"



AE 556/01
16,5 cm/6¹/₂"

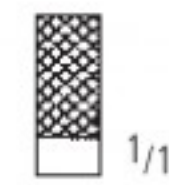

AE 556/02
15,0 cm/6"

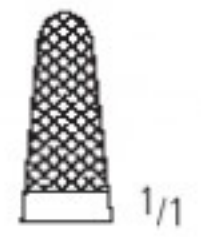

AE 556/03
15,0 cm/6"

CORWIN

AA
AB
AC
AD
AE
AF
AG
AH
AI
AJ
AK
AL
AM
AN
AO
AP
AQ
AR
AS
AT
AU
AV
AW
AX
AY
AZ
BA
BB
BC
BD
BE
BF
BG
BH
BI
BJ
BK
BL
BM
BN
BO
BP
BQ
BR
BS
BT
BU
BV
BW
BX
BY
BZ
CA
CB
CC
CD
CE
CF
CG
CH
CI
CJ
CK
CL
CM
CN
CO
CP
CQ
CR
CS
CT
CU
CV
CW
CX
CY
CZ
DA
DB
DC
DD
DE
DF
DG
DH
DI
DJ
DK
DL
DM
DN
DO
DP
DQ
DR
DS
DT
DU
DV
DW
DX
DY
DZ
EA
EB
EC
ED
EE
EF
EG
EH
EI
EJ
EK
EL
EM
EN
EO
EP
EQ
ER
ES
ET
EU
EV
EW
EX
EY
EZ
FA
FB
FC
FD
FE
FF
FG
FH
FI
FJ
FK
FL
FM
FN
FO
FP
FQ
FR
FS
FT
FU
FV
FW
FX
FY
FZ
GA
GB
GC
GD
GE
GF
GG
GH
GI
GJ
GK
GL
GM
GN
GO
GP
GQ
GR
GS
GT
GU
GV
GW
GX
GY
GZ
HA
HB
HC
HD
HE
HF
HG
HH
HI
HJ
HK
HL
HM
HN
HO
HP
HQ
HR
HS
HT
HU
HV
HW
HX
HY
HZ
IA
IB
IC
ID
IE
IF
IG
IH
II
IJ
IK
IL
IM
IN
IO
IP
IQ
IR
IS
IT
IU
IV
IW
IX
IY
IZ
JA
JB
JC
JD
JE
JF
JG
JH
JI
JJ
JK
JL
JM
JN
JO
JP
JQ
JR
JS
JT
JU
JV
JW
JX
JY
JZ
KA
KB
KC
KD
KE
KF
KG
KH
KI
KJ
KK
KL
KM
KN
KO
KP
KQ
KR
KS
KT
KU
KV
KW
KX
KY
KZ
LA
LB
LC
LD
LE
LF
LG
LH
LI
LJ
LK
LL
LM
LN
LO
LP
LQ
LR
LS
LT
LU
LV
LW
LX
LY
LZ
MA
MB
MC
MD
ME
MF
MG
MH
MI
MJ
MK
ML
MN
MO
MP
MQ
MR
MS
MT
MU
MV
MW
MX
MY
MZ
NA
NB
NC
ND
NE
NF
NG
NH
NI
NJ
NK
NL
NM
NO
NP
NQ
NR
NS
NT
NU
NV
NW
NX
NY
NZ
OA
OB
OC
OD
OE
OF
OG
OH
OI
OJ
OK
OL
OM
ON
OO
OP
OQ
OR
OS
OT
OU
OV
OW
OX
OY
OZ
PA
PB
PC
PD
PE
PF
PG
PH
PI
PJ
PK
PL
PM
PN
PO
PP
PQ
PR
PS
PT
PU
PV
PW
PX
PY
PZ
QA
QB
QC
QD
QE
QF
QG
QH
QI
QJ
QK
QL
QM
QN
QO
QP
QQ
QR
QS
QT
QU
QV
QW
QX
QY
QZ
RA
RB
RC
RD
RE
RF
RG
RH
RI
RJ
RK
RL
RM
RN
RO
RP
RQ
RR
RS
RT
RU
RV
RW
RX
RY
RZ
SA
SB
SC
SD
SE
SF
SG
SH
SI
SJ
SK
SL
SM
SN
SO
SP
SQ
SR
SS
ST
SU
SV
SW
SX
SY
SZ
TA
TB
TC
TD
TE
TF
TG
TH
TI
TJ
TK
TL
TM
TN
TO
TP
TQ
TR
TS
TT
TU
TV
TW
TX
TY
TZ
UA
UB
UC
UD
UE
UF
UG
UH
UI
UJ
UK
UL
UM
UN
UO
UP
UQ
UR
US
UT
UU
UV
UW
UX
UY
UZ
VA
VB
VC
VD
VE
VF
VG
VH
VI
VJ
VK
VL
VM
VN
VO
VP
VQ
VR
VS
VT
VU
VV
VW
VX
VY
VZ
WA
WB
WC
WD
WE
WF
WG
WH
WI
WJ
WK
WL
WM
WN
WO
WP
WQ
WR
WS
WT
WU
WV
WW
WX
WY
WZ
XA
XB
XC
XD
XE
XF
XG
XH
XI
XJ
XK
XL
XM
XN
XO
XP
XQ
XR
XS
XT
XU
XV
XW
XX
XY
XZ
YA
YB
YC
YD
YE
YF
YG
YH
YI
YJ
YK
YL
YM
YN
YO
YP
YQ
YR
YS
YT
YU
YV
YW
YX
YY
YZ
ZA
ZB
ZC
ZD
ZE
ZF
ZG
ZH
ZI
ZJ
ZK
ZL
ZM
ZN
ZO
ZP
ZQ
ZR
ZS
ZT
ZU
ZV
ZW
ZX
ZY
ZZ

AE NAHT SUTURE SUTURA SUTURE SUTURA

Mikro-Nadelhalter mit Hartmetalleinsätzen
 Micro-Needle Holders with Tungsten Carbide Inserts
 Micro-Porta-agujas con bocas de carburo de Tungsteno
 Micro-Porte-aiguilles à mors en carbure de tungstène
 Micro-Portaghi con placche di carburo di tungsteno

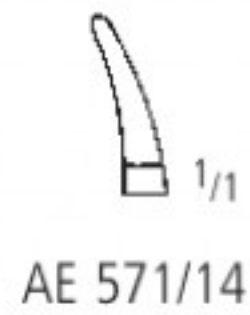

CASTROVIEJO
 14,0 cm/5 1/2"



CASTROVIEJO
 14,0 cm/5 1/2"



18,0 cm/7"

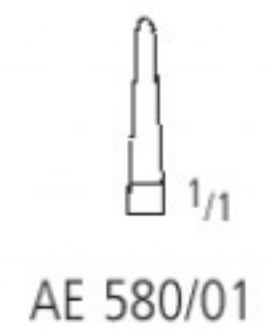
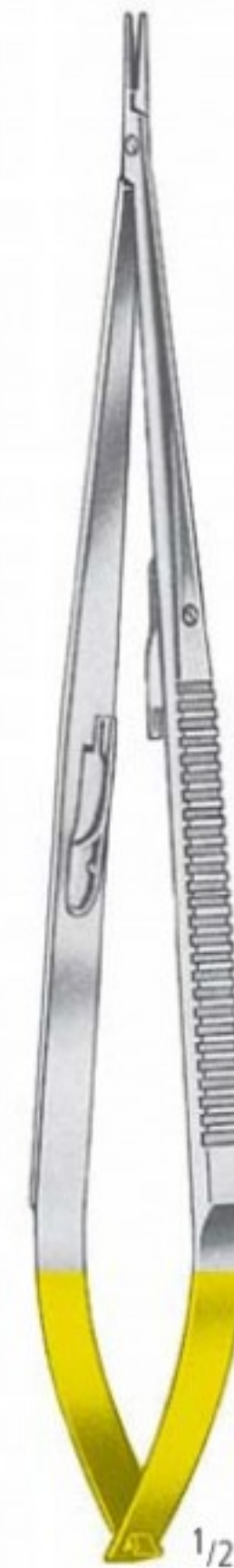

JACOBSON
 21,0 cm/8 1/4"

NAHT SUTURE SUTURA SUTURE SUTURA

Mikro-Nadelhalter mit Hartmetalleinsätzen
 Micro-Needle Holders with Tungsten Carbide Inserts
 Micro-Porta-agujas con bocas de carburo de Tungsteno
 Micro-Porte-aiguilles à mors en carbure de tungstène
 Micro-Portaghi con placche di carburo di tungsteno



DIETRICH



AE 582/16
16,0 cm/6¹/₄"



AE 582/18
18,0 cm/7"



AE 582/20
20,0 cm/8"

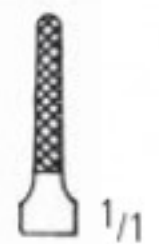

AE 582/23
23,0 cm/9"



AE 582/26
26,0 cm/10¹/₂"



KALT
AE 584/14
13,5 cm/5¹/₄"



CASTROVIEJO
AE 586/13
13,0 cm/5"

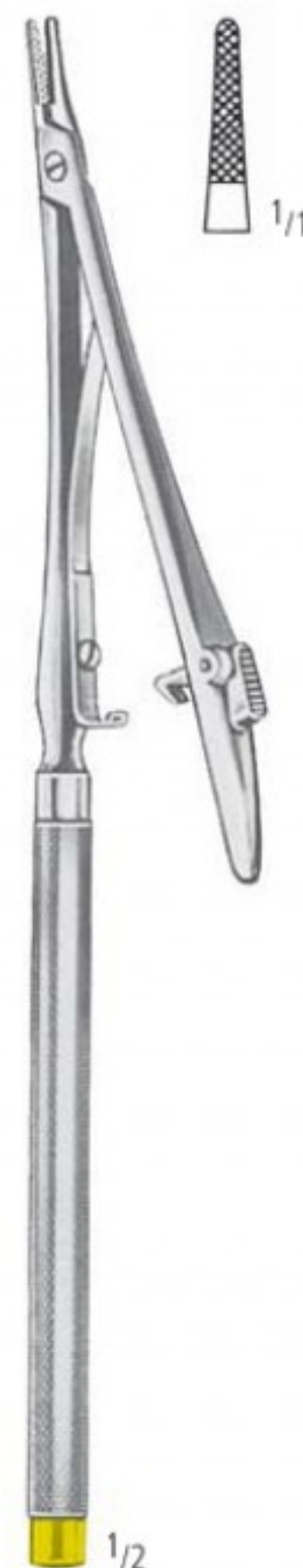

POTTS-SMITH
AE 588/22
22,0 cm/8³/₄"

AA
AB
AC
AD
AE
AF
AK
AL
AM
AO
AP
AR
KA
KB
KC
KD
KU
KY

AE NAHT SUTURE SUTURA SUTURE SUTURA

Mikro-Nadelhalter mit Rundgriff
 Micro-Needle Holders with Pen-Type Handle
 Micro-Porta-agujas con mango redondo
 Micro-Porte-aiguilles à manches rondes
 Micro-Portaghi con manici rotondi

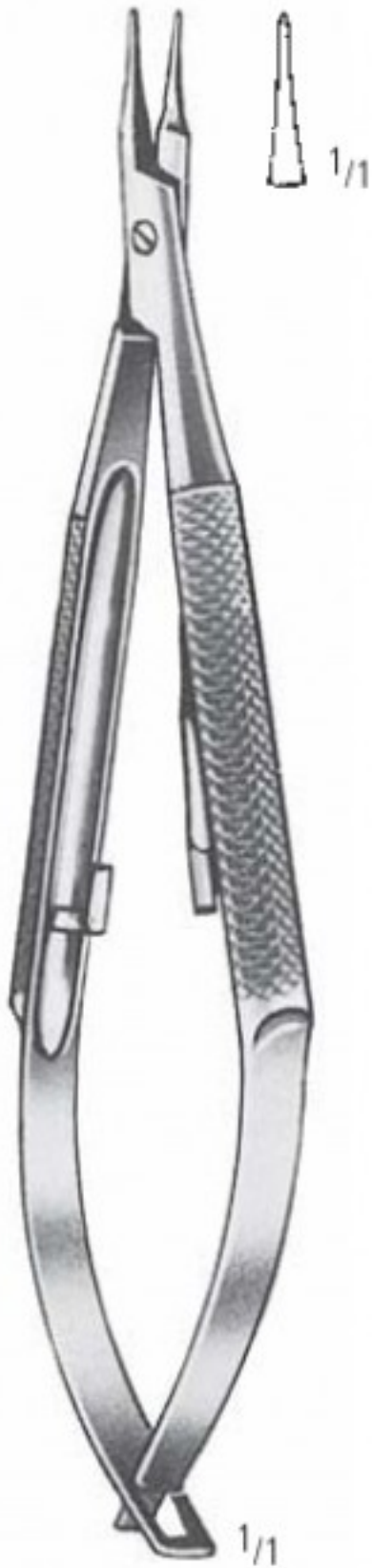

BARRAQUER-TROUTMAN
 AE 600/10
 10,0 cm/4"

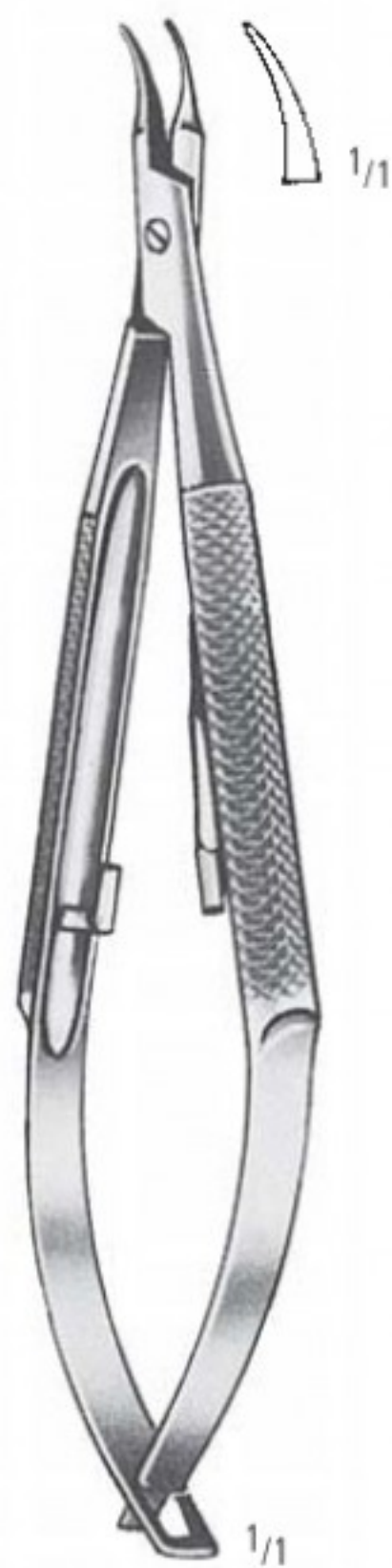

BARRAQUER-TROUTMAN
 AE 601/10
 10,0 cm/4"



BARRAQUER-TROUTMAN
 AE 602/10
 10,0 cm/4"



BARRAQUER-TROUTMAN
 AE 603/10
 10,0 cm/4"



BARRAQUER
 AE 605/11
 11,0 cm/4¹/₃"



BARRAQUER
 AE 605/13
 13,0 cm/5"



BARRAQUER
 AE 605/14
 14,0 cm/5¹/₂"



BARRAQUER
 AE 606/14
 14,0 cm/5¹/₂"



BARRAQUER
 AE 607/14
 14,0 cm/5¹/₂"

NAHT SUTURE SUTURA SUTURE SUTURA

Mikro-Nadelhalter mit Rundgriff
 Micro-Needle Holders with Pen-Type Handle
 Micro-Porta-agujas con mango redondo
 Micro-Porte-aiguilles à manches rondes
 Micro-Portaghi con manici rotondi

AA
 AB
 AC
 AD
 AE
 AF
 AK
 AL
 AM
 AO
 AP
 AR
 KA
 KB
 KC
 KD
 KU
 KY



TROUTMAN
 AE 609/01
 12,0 cm/4³/₄"



TROUTMAN
 AE 609/02
 12,0 cm/4³/₄"



 1/1
 AE 610/15

 1/1
 AE 611/15



 1/1
 AE 612/15

 1/1
 AE 613/15

REILL
 15,0 cm/6"

REILL
 15,0 cm/6"

AE NAHT SUTURE SUTURA SUTURE SUTURA

Mikro-Nadelhalter mit Rundgriff
 Micro-Needle Holders with Pen-Type Handle
 Micro-Porta-agujas con mango redondo
 Micro-Porte-aiguilles à manches rondes
 Micro-Portaghi con manici rotondi



AE 621/14
 14,0 cm/5 1/2"



AE 623/14
 14,0 cm/5 1/2"

...für Rechtshänder
 ...for right handed surgeons
 ...para diestros
 ...pour des droitiers
 ...per destrimani

Maulteil konkav/konvex
 Jaws concave/convex
 Bocas concavas/convexas
 Mors concave/convexe
 Morso concavo/convesso



AE 625/14
 14,0 cm/5 1/2"

...für Linkshänder
 ...for left handed surgeons
 ...para zurdos
 ...pour gaucher
 ...per mancini

NAHT SUTURE SUTURA SUTURE SUTURA

Mikro-Nadelhalter mit Rundgriff
 Micro-Needle Holders with Pen-Type Handle
 Micro-Porta-agujas con mango redondo
 Micro-Porte-aiguilles à manches rondes
 Micro-Portaghi con manici rotondi



AE 630/18
 18,0 cm/7"



AE 631/18
 18,0 cm/7"



AE 632/18
 18,0 cm/7"



AE 633/18
 18,0 cm/7"

- AA
- AB
- AC
- AD
- AE**
- AF
- AK
- AL
- AM
- AO
- AP
- AR
- KA
- KB
- KC
- KD
- KU
- KY

AE NAHT SUTURE SUTURA SUTURE SUTURA

Mikro-Nadelhalter
 Micro-Needle Holders
 Micro-Porta-agujas
 Micro-Porte-aiguilles
 Micro-Portaghi

	AE 650/09	AE 651/09		AE 652/09	AE 653/09		AE 656/14	AE 657/14		AE 660/14	AE 661/14
							AE 658/14	AE 659/14		AE 662/14	AE 663/14
CASTROVIEJO 9,0 cm/3 ¹ / ₂ "			CASTROVIEJO 9,0 cm/3 ¹ / ₂ "			CASTROVIEJO 14,0 cm/5 ¹ / ₂ "			CASTROVIEJO 14,0 cm/5 ¹ / ₂ "		

	AE 670/14	AE 671/14		AE 672/14	AE 673/14		AE 678/18 18,0 cm/7"	AE 678/21 21,0 cm/8 ¹ / ₄ "
CASTROVIEJO 14,0 cm/5 ¹ / ₂ "			CASTROVIEJO 14,0 cm/5 ¹ / ₂ "			JACOBSON		

breiter Griff
 wide handle
 mango ancho
 manche large
 manico largo

NAHT SUTURE SUTURA SUTURE SUTURA

Mikro-Nadelhalter
 Micro-Needle Holders
 Micro-Porta-agujas
 Micro-Porte-aiguilles
 Micro-Portaghi



AE 680/16
 AE 680/18
 AE 680/20
 AE 680/22

16,5 cm/6¹/₂"
 18,0 cm/7"
 20,0 cm/8"
 22,0 cm/8³/₄"

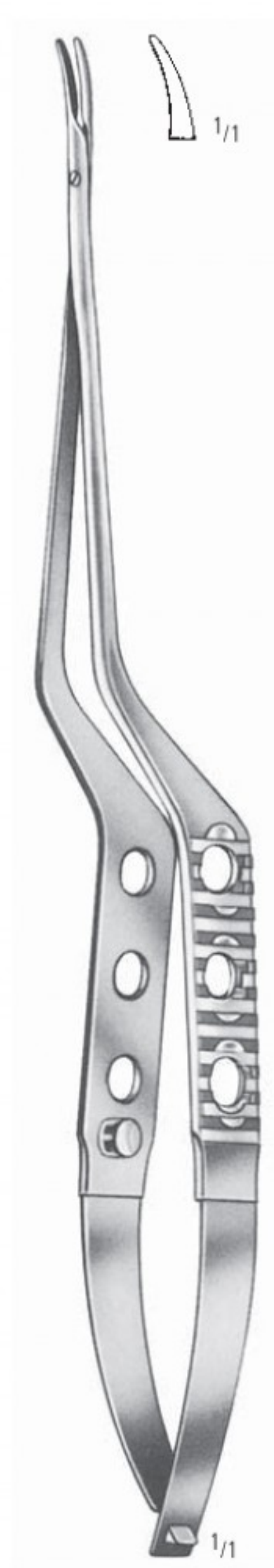

AE 681/16
 AE 681/18
 AE 681/20
 AE 681/22

AA
 AB
 AC
 AD
 AE
 AF
 AK
 AL
 AM
 AO
 AP
 AR
 KA
 KB
 KC
 KD
 KU
 KY

AE NAHT SUTURE SUTURA SUTURE SUTURA

Mikro-Nadelhalter
 Micro-Needle-Holders
 Micro-Porta-agujas
 Micro-Porte-aiguilles
 Micro-Portaghi



PATON
 AE 684/11
 11,0 cm/4¹/₃"



PATON
 AE 685/11
 11,0 cm/4¹/₃"

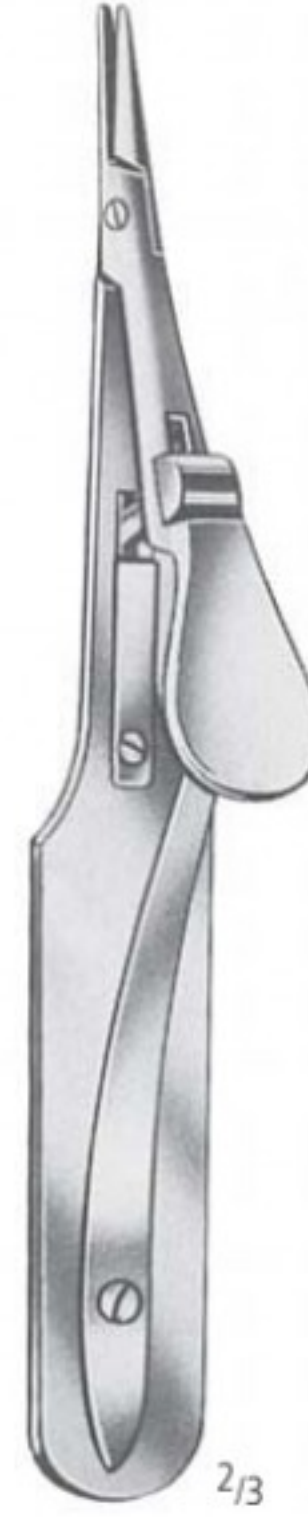

ARRUGA
 14,0 cm/5¹/₂"



AE 686/14
 AE 687/14



KALT
 AE 688/14
 14,0 cm/5¹/₂"

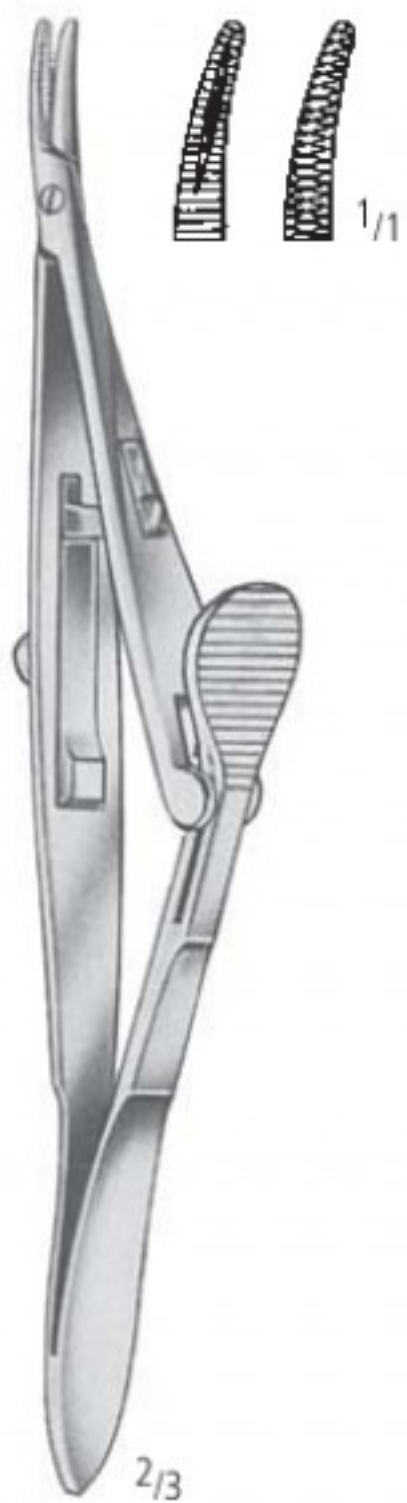

KALT-ARRUGA
 AE 689/14
 14,0 cm/5¹/₂"

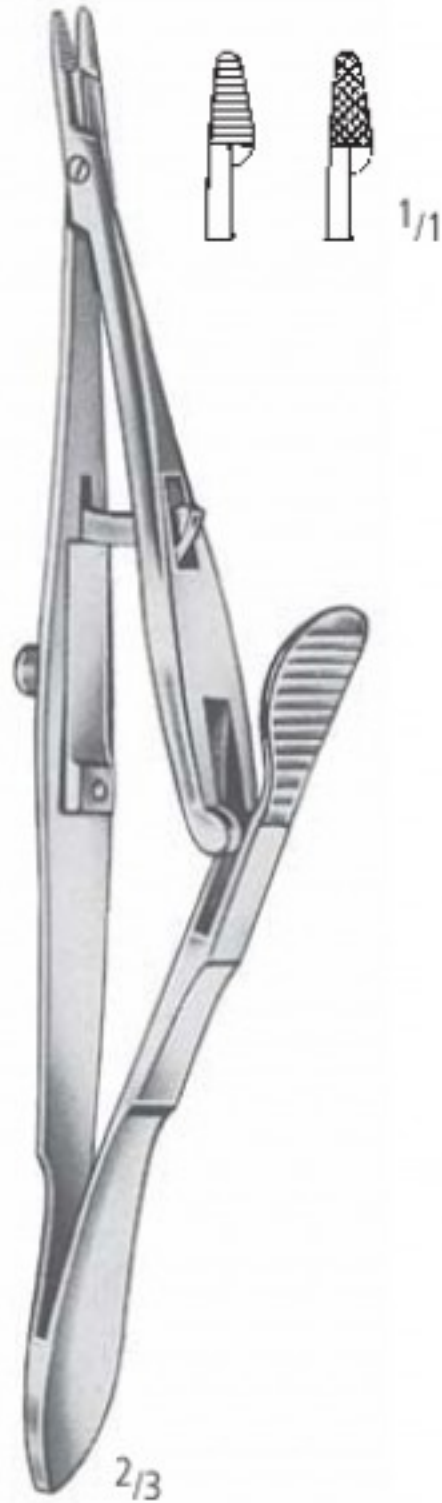

CASTROVIEJO-KALT
 AE 690/14
 13,5 cm/5¹/₄"



STEVENS
 AE 692/13 AE 692/15
 13,0 cm/5" 15,0 cm/6"

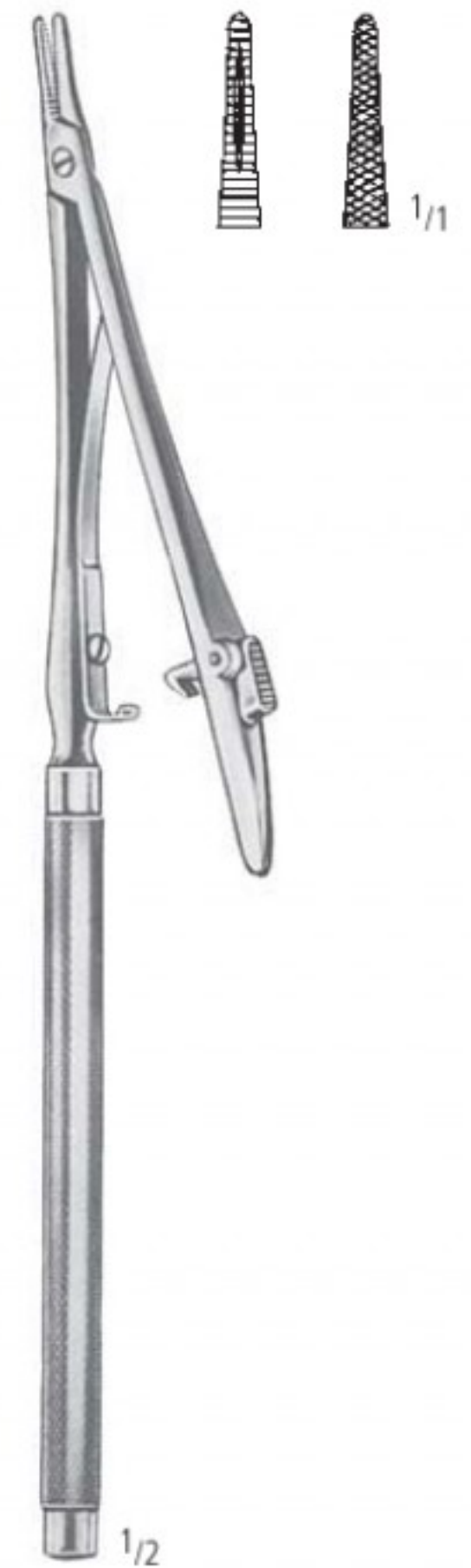

POTTS-SMITH
 AE 694/22
 22,0 cm/8³/₄"

NAHT SUTURE SUTURA SUTURE SUTURA

Mikro-Nadelhalter
 Micro-Needle Holders
 Micro-Porta-agujas
 Micro-Porte-aiguilles
 Micro-Portaghi

AA
 AB
 AC
 AD
 AE
 AF
 AK
 AL
 AM
 AO
 AP
 AR
 KA
 KB
 KC
 KD
 KU
 KY



CASTROVIEJO
 13,0 cm/5"

Griff 8 mm Ø
 Handle 8 mm Ø
 Mango 8 mm Ø
 Manche 8 mm Ø
 Manico 8 mm Ø



CASTROVIEJO
 13,0 cm/5"



CASTROVIEJO
 13,0 cm/5"

Griff 10 mm Ø
 Handle 10 mm Ø
 Mango 10 mm Ø
 Manche 10 mm Ø
 Manico 10 mm Ø



CASTROVIEJO
 13,0 cm/5"

AE NAHT SUTURE SUTURA SUTURE SUTURA

Reverdin-Nadeln
 Reverdin Needles
 Agujas de Reverdin
 Aiguilles de Reverdin
 Aghi di Reverdin



1/2

REVERDIN
 14,0 cm/5 1/2"



1/1

Fig. 1
 AE 700/01



1/1

2
 AE 700/02



1/1

3
 AE 700/03



1/1

4
 AE 700/04



1/2

REVERDIN
 19,5 cm/7 3/4"
 22,5 cm/9"



1/1

Fig. 1
 AE 701/01
 AE 702/01



1/1

2
 AE 701/02
 AE 702/02



1/1

3
 AE 701/03
 AE 702/03



1/1

4
 AE 701/04
 AE 702/04

NAHT SUTURE SUTURA SUTURE SUTURA

Unterbindungsnadeln
Ligature Needles
Agujas para ligaduras
Aiguilles à ligatures
Aghi per legatura

DESCHAMPS

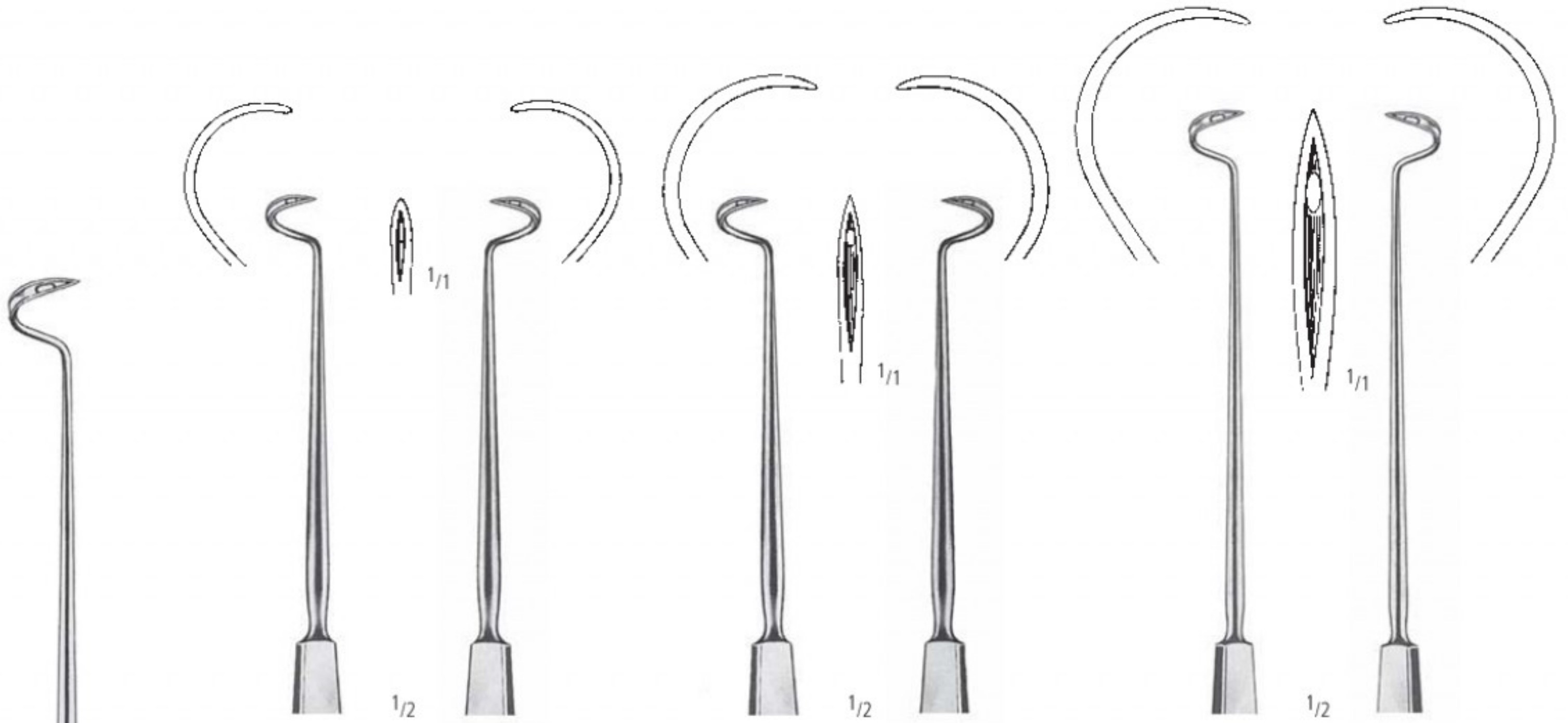

spitz • pointed • agudas • pointues • acuta

20,0 cm/8"	AE 720/20	AE 721/20	AE 722/20	AE 723/20		
21,0 cm/8 ¹ / ₄ "					AE 724/21	AE 725/21
27,0 cm/10 ³ / ₄ "					AE 724/27	AE 725/27

DESCHAMPS

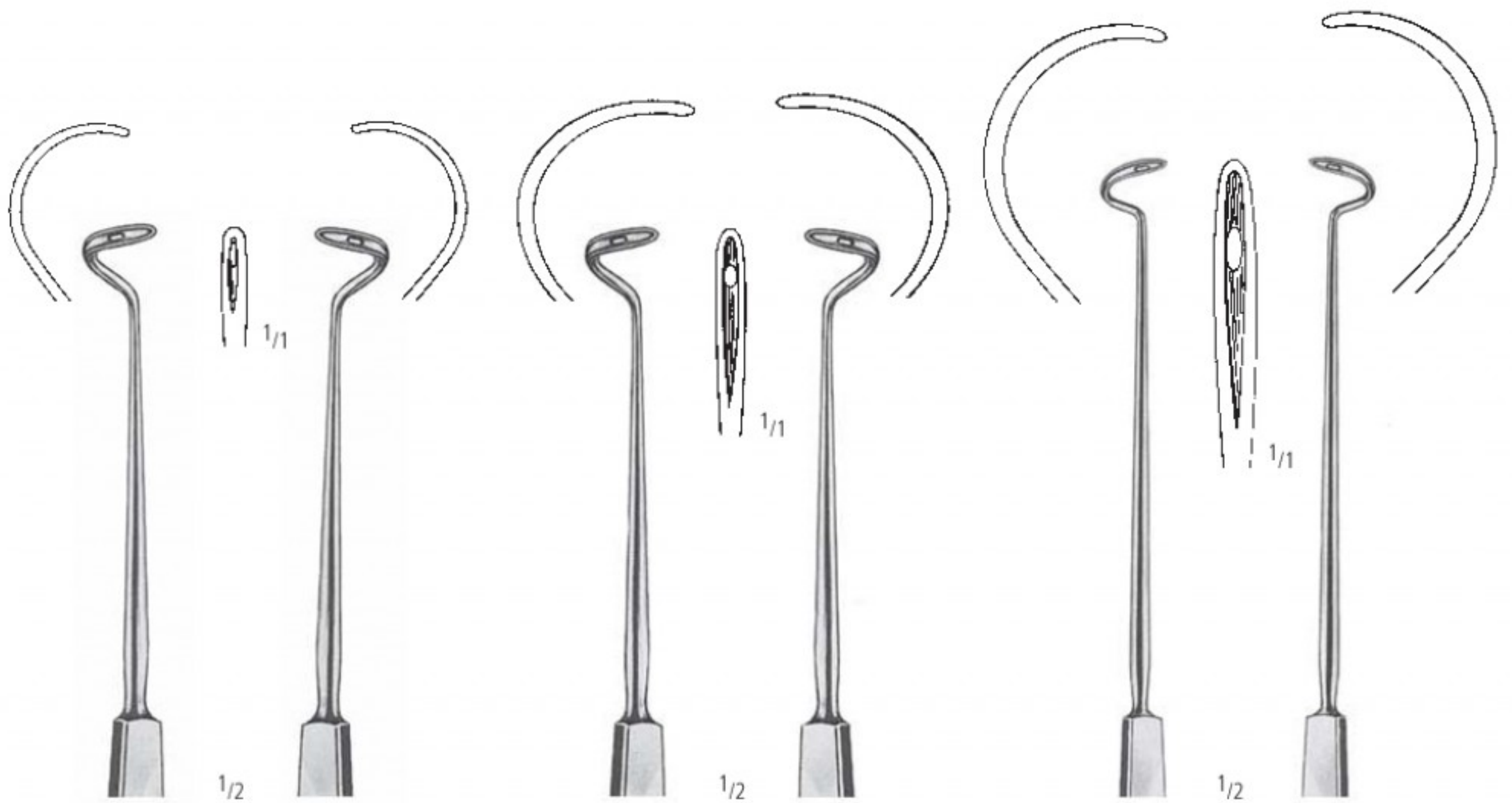

stumpf • blunt • romas • mousses • smussa

20,0 cm/8"	AE 728/20	AE 729/20	AE 730/20	AE 731/20		
21,0 cm/8 ¹ / ₄ "					AE 732/21	AE 733/21
27,0 cm/10 ³ / ₄ "					AE 732/27	AE 733/27

AA
AB
AC
AD
AE
AF
AK
AL
AM
AO
AP
AR
KA
KB
KC
KD
KU
KY

AE NAHT SUTURE SUTURA SUTURE SUTURA

Unterbindungsadeln
Ligature Needles
Agujas para ligaduras
Aiguilles à ligatures
Aghi per legatura

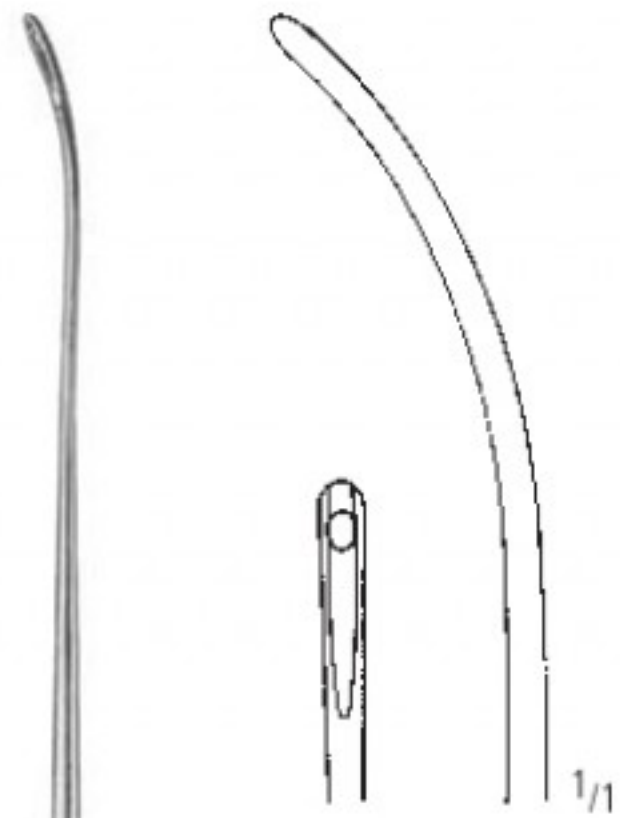

biegsam
flexible
maleable
malléable
malleabile

1/2

AE 750/20
20,0 cm/8"

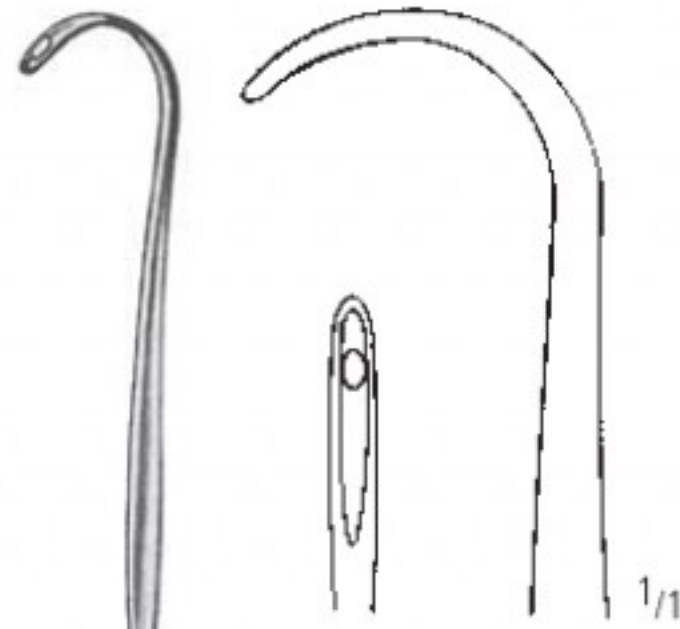

1/2

COOPER
AE 751/19
19,0 cm/7 1/2"

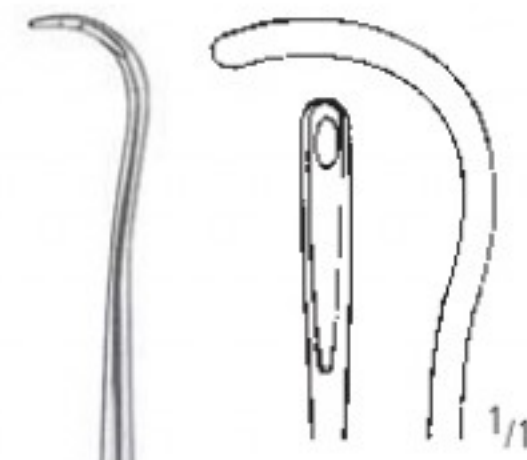

1/2

COOPER
AE 751/20
20,0 cm/8"

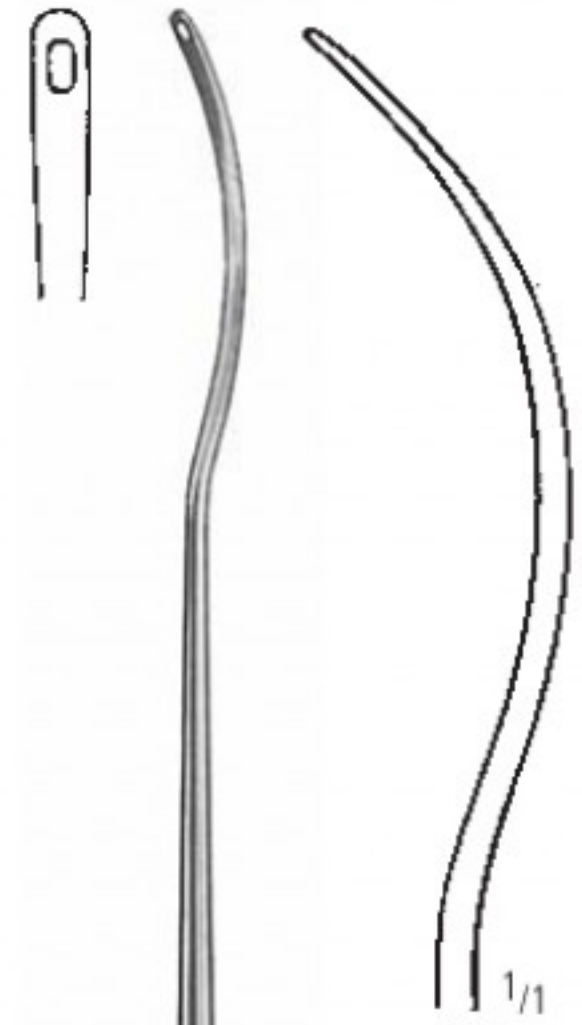

1/1

AE 754/01



1/1

AE 752/01

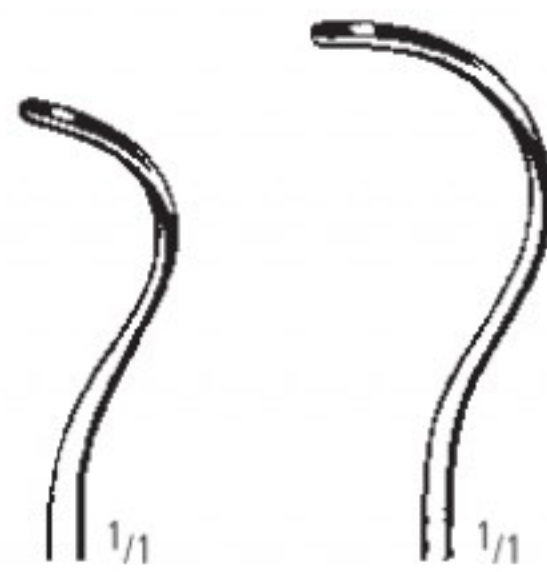

1/1

AE 752/02



1/1

AE 752/03



1/1

SYME
AE 753/17
17,0 cm/6 3/4"



1/1

AE 754/02

BRUNNER
30,0 cm/12"

KOCHER
19,0 cm/7 1/2"

NAHT SUTURE SUTURA SUTURE SUTURA

Unterbindungsnadeln
 Ligature Needles
 Agujas para ligaduras
 Aiguilles à ligatures
 Aghi per legatura

AA
 AB
 AC
 AD
 AE
 AF
 AK
 AL
 AM
 AO
 AP
 AR
 KA
 KB
 KC
 KD
 KU
 KY



BRUNNER
 AE 755/25
 25,0 cm/10"



SCHMIEDEN
 AE 758/21
 21,0 cm/8¹/₄"



DE LA ROZA
 AE 767/01
 12,0 cm/4³/₄"



DE LA ROZA
 AE 767/02
 12,0 cm/4³/₄"



HESSBERG
 AE 768/15
 15,0 cm/6"



JACOBI
 AE 769/14
 14,0 cm/5¹/₂"

Unterbindungsadeln
 Ligature Needles
 Agujas para ligaduras
 Aiguilles à ligatures
 Aghi per legatura



KRONECKER
 AE 770/01
 15,0 cm/6"



KRONECKER
 AE 770/02
 15,0 cm/6"



TRÉLAT
 AE 772/23
 23,0 cm/9"



CLAUS
 AE 773/23
 23,0 cm/9"



HURD
 AE 774/01
 21,0 cm/8¹/₄"



HURD
 AE 774/02
 21,0 cm/8¹/₄"

NAHT SUTURE SUTURA SUTURE SUTURA

Unterbindungsnadeln
 Ligature Needles
 Agujas para ligaduras
 Aiguilles à ligatures
 Aghi per legatura

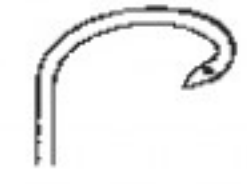

AE 775/01

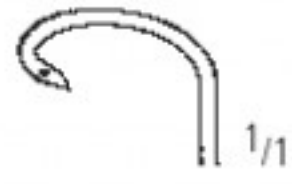

AE 776/01

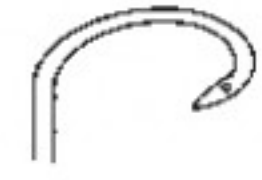

AE 775/02



AE 776/02



ROTTER
 26,0 cm/10¹/₂"



ROTTER
 26,0 cm/10¹/₂"



NAGER
 AE 777/24
 24,0 cm/9¹/₂"



FALK
 AE 780/01
 24,0 cm/9¹/₂"



FALK
 AE 780/02
 24,0 cm/9¹/₂"



CLAUS-EICKEN
 AE 781/23
 23,0 cm/9"

AA
 AB
 AC
 AD
AE
 AF
 AK
 AL
 AM
 AO
 AP
 AR
 KA
 KB
 KC
 KD
 KU
 KY

AE NAHT SUTURE SUTURA SUTURE SUTURA

Führungshohlsonden
 Ligature Conductors
 Sondas Conductoras
 Sondes Conductrices
 Sonde conduttrice



BRUNNER
 30,0 cm/12"

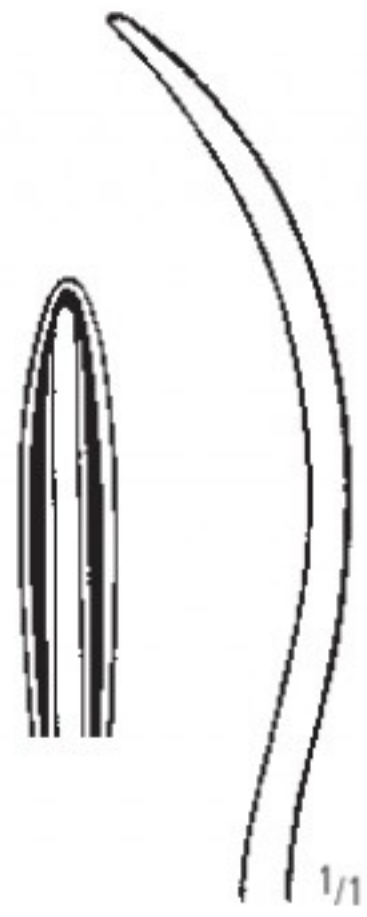

AE 800/01



AE 800/03

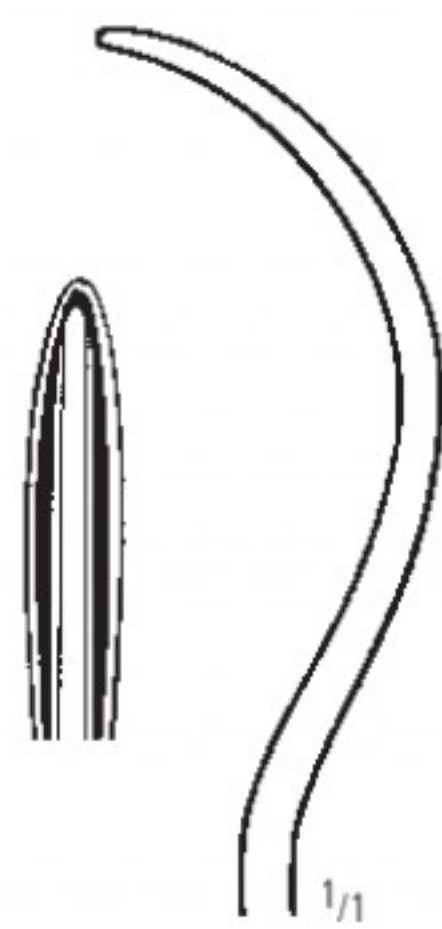

AE 800/02



AE 800/04

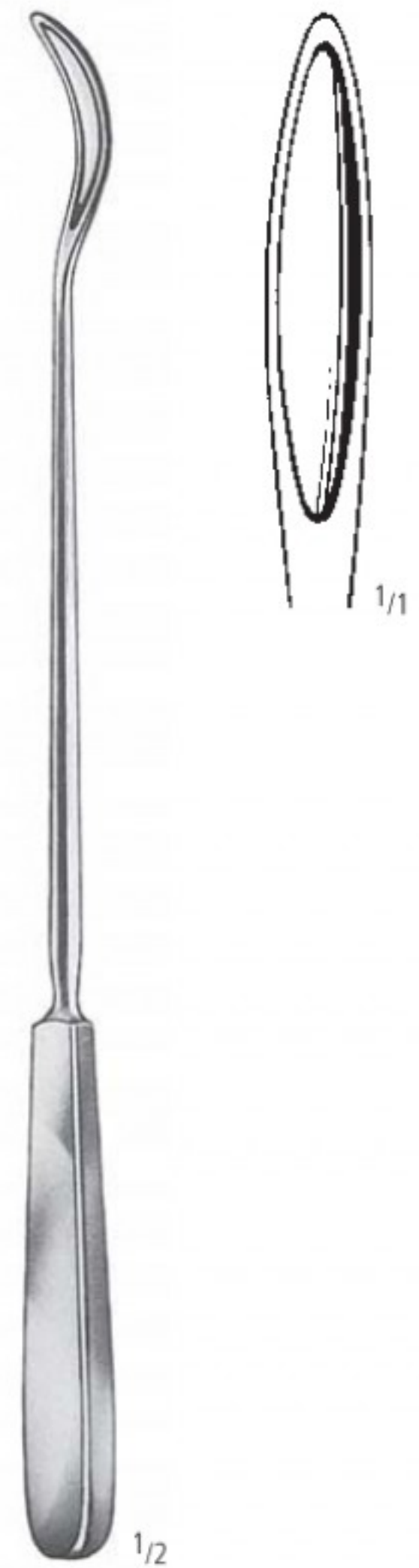

BRUNNER
 AE 801/25
 25,0 cm/10"

NAHT SUTURE SUTURA SUTURE SUTURA

Führungshohlsonden
Ligature Conductors
Sondas Conductoras
Sondes Conductrices
Sonde conduttrice



PAYR
AE 802/22
22,0 cm/8³/₄"



PAYR
AE 803/22
22,0 cm/8³/₄"

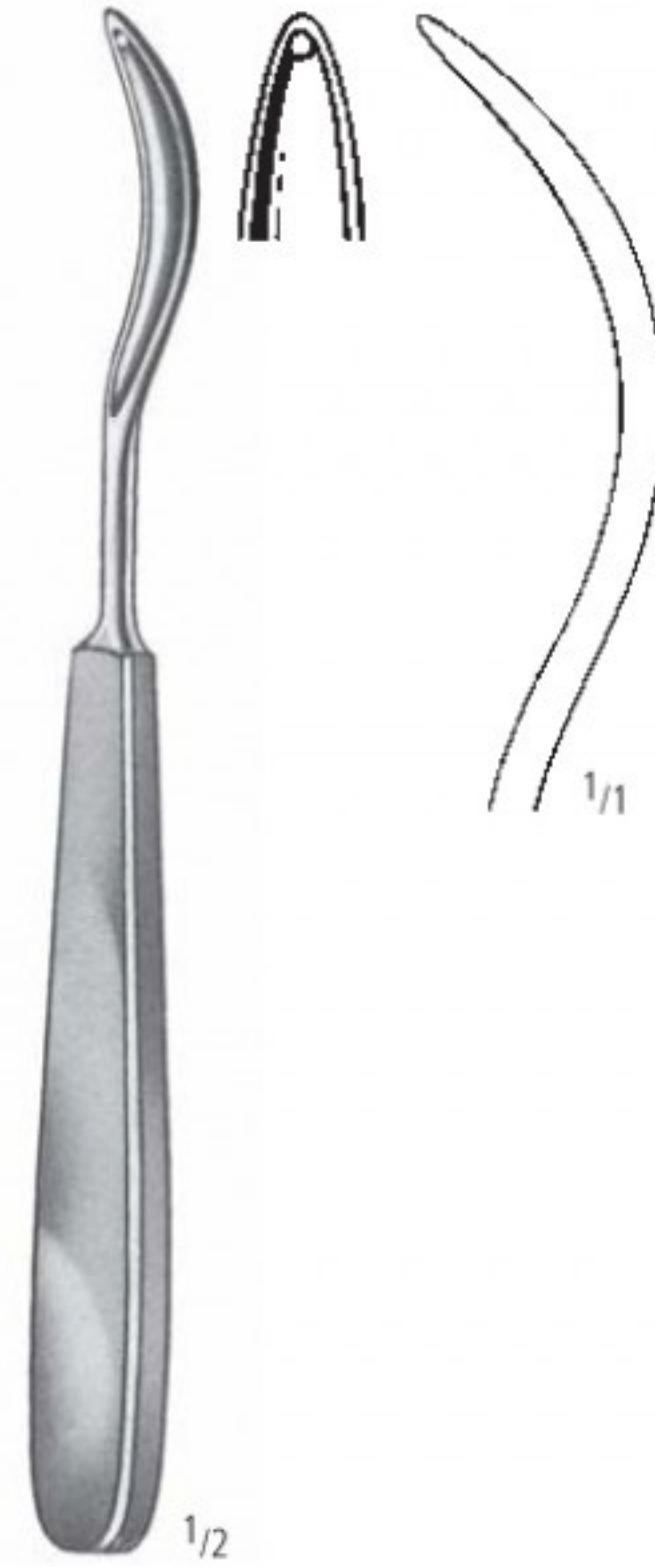

SCHMIEDEN-PAYR
AE 806/19
19,0 cm/7¹/₂"

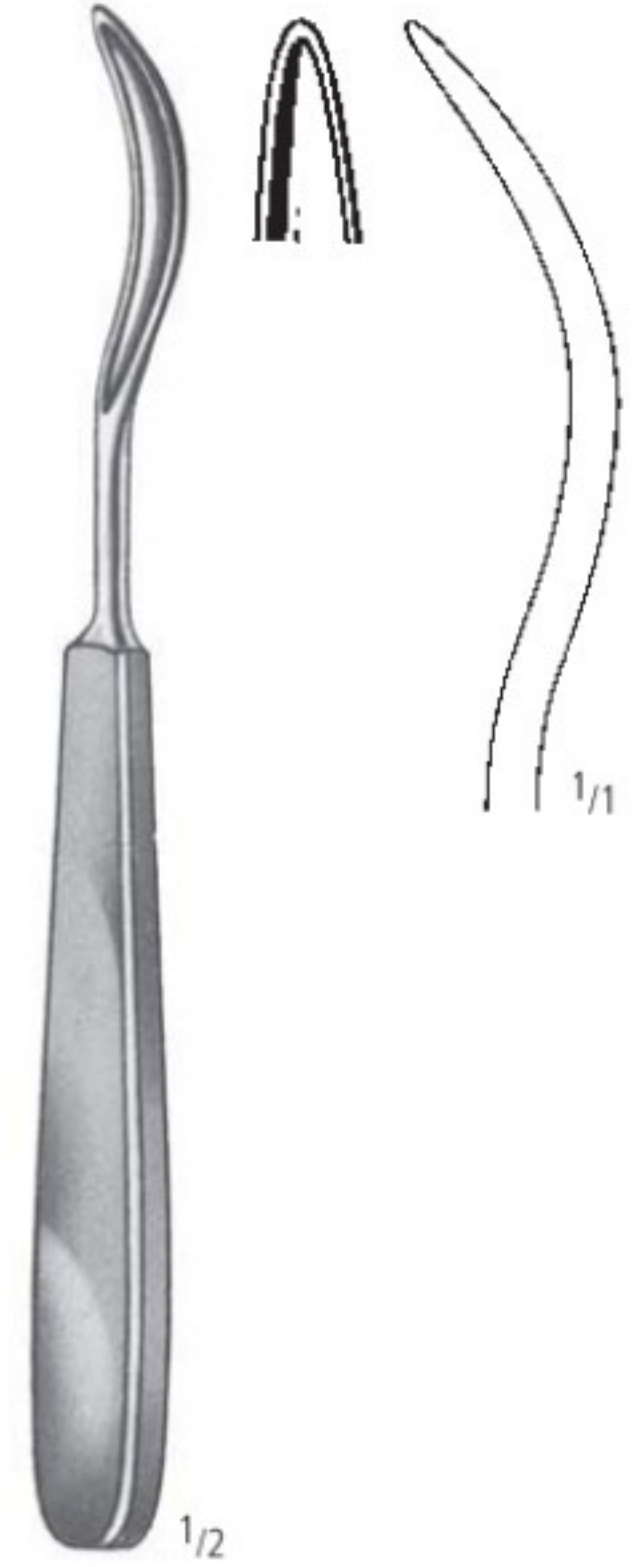

SCHMIEDEN-PAYR
AE 807/19
19,0 cm/7¹/₂"

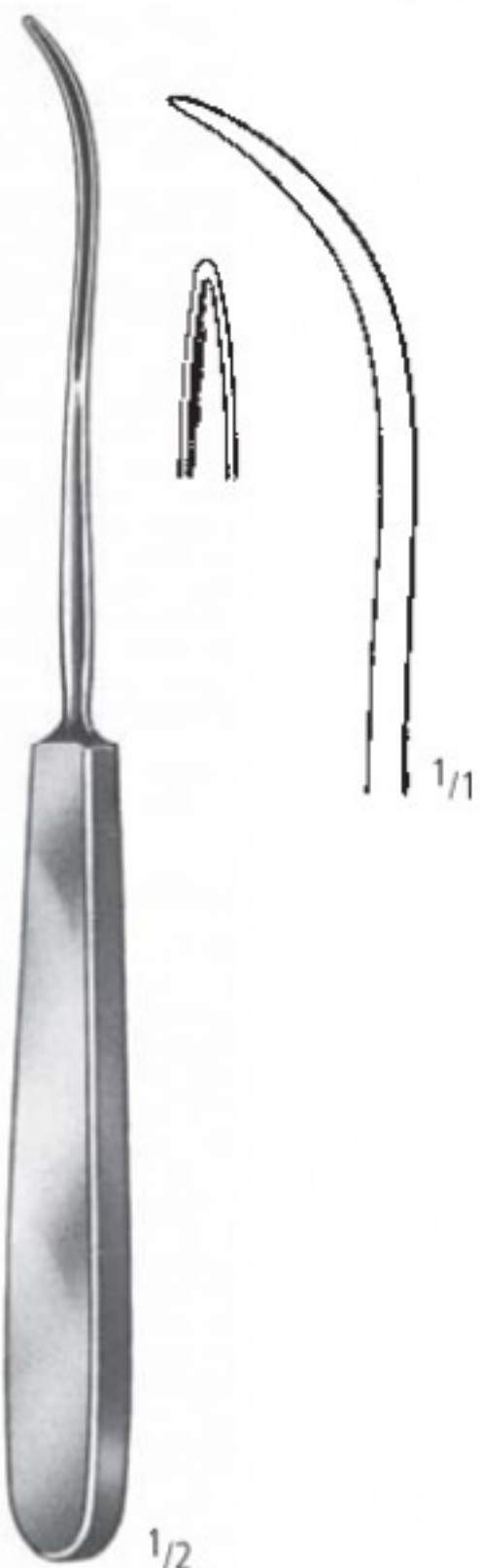

KÖNIG
AE 808/03
19,5 cm/7³/₄"

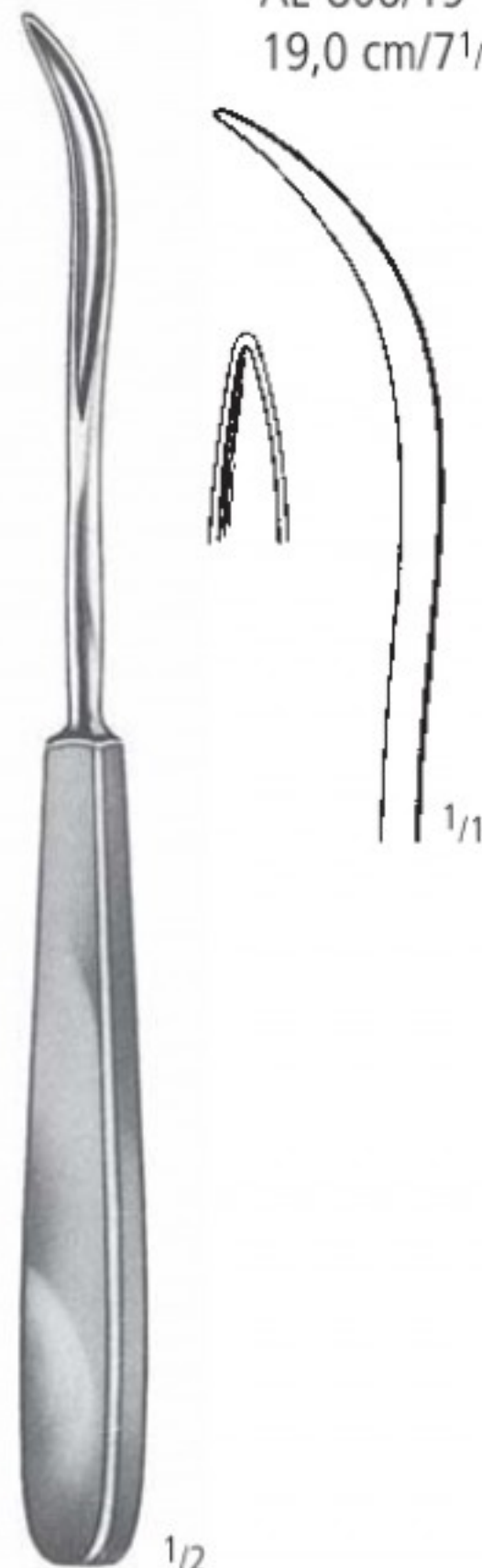

KÖNIG
AE 808/05
19,5 cm/7³/₄"

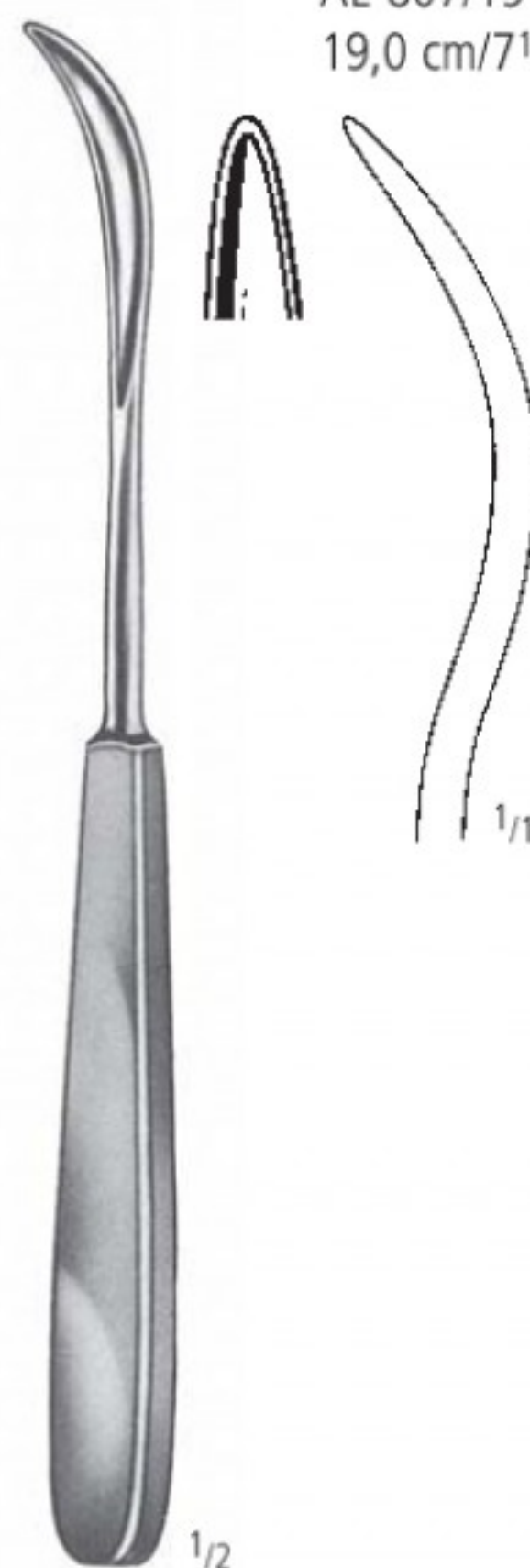

KÖNIG
AE 808/07
19,5 cm/7³/₄"

AA
AB
AC
AD
AE
AF
AK
AL
AM
AO
AP
AR
KA
KB
KC
KD
KU
KY

AE NAHT SUTURE SUTURA SUTURE SUTURA

Führungshohlsonden
Ligature Conductors
Sondas Conductoras
Sondes Conductrices
Sonde conduttrice



KIRSCHNER

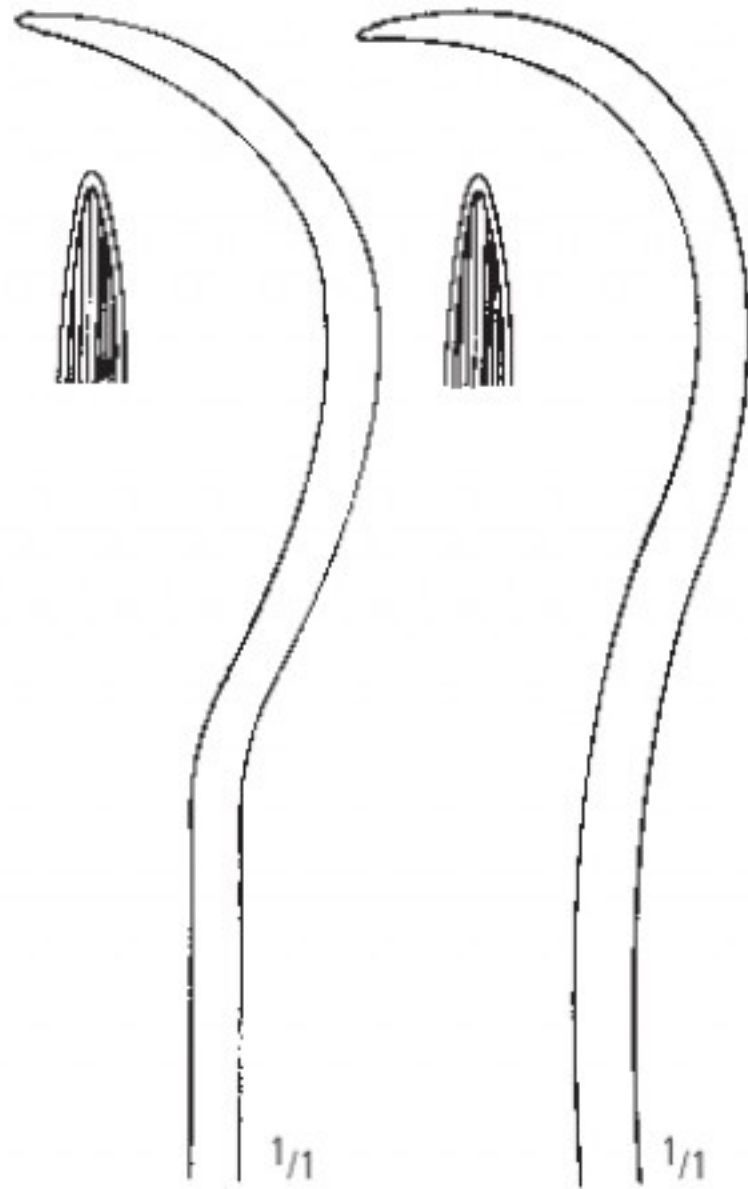

AE 810/25
25,0 cm/10"

AE 811/28
28,0 cm/11"



KOCHER

15,0 cm/6"
16,0 cm/6¹/₄"
18,0 cm/7"



AE 813/15
AE 813/16

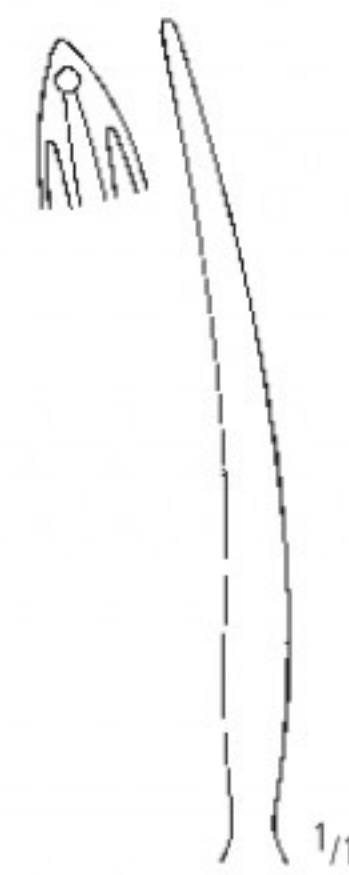

AE 814/15
AE 814/16

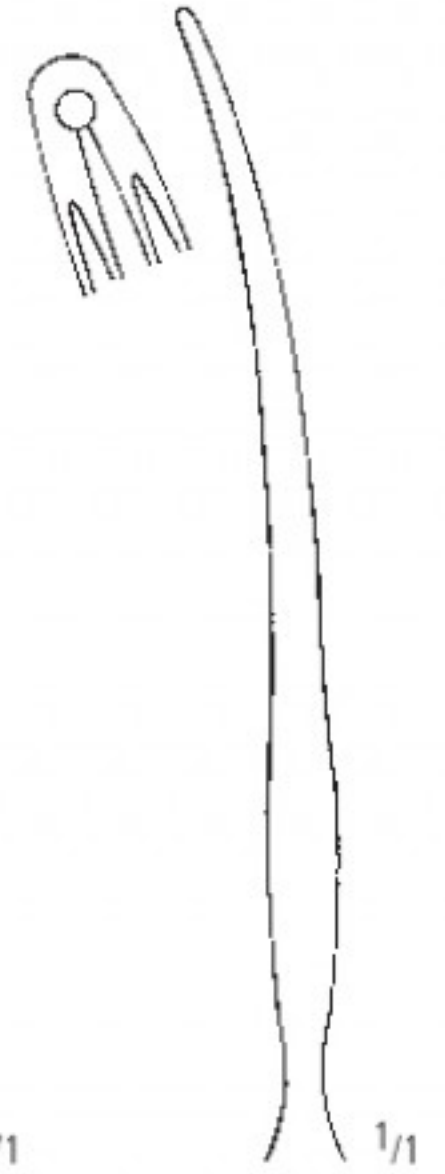

AE 816/18



FERROZELL
AE 820/24
24,0 cm/9¹/₂"



BRUNNER-FERROZELL
AE 821/18 AE 821/27
18,0 cm/7" 27,0 cm/10³/₄"



KIRSCHNER-FERROZELL
AE 822/27
27,0 cm/10³/₄"



AE 823/01
gerade
straight
recta
droite
retta

AE 823/02
gebogen
curved
curva
courbe
curva

FERROZELL
18,0 cm/7"

NAHT SUTURE SUTURA SUTURE SUTURA

Fadenknoter, -fänger, -schlingendreher
 Knot-Tiers, Ligature Catcher, Loop Twisters
 Tuerce-hilos, Porta-ligaduras
 Instruments à noeds, Porte-ligature, Tords-fil
 Strumenti per nodi, Portalegature, Torcifilo

Nahtpinzetten und Fadenscheren
 finden Sie in den Gruppen AB und AC.

For Suture Forceps and Ligature Scissors
 please refer to groups AB and AC.



AE 830/23
 23,0 cm/9"



BOZEMANN
 AE 831/21
 21,0 cm/8¹/₄"



MOD. WIEN
 AE 832/23
 23,5 cm/9¹/₃"



FRIEDRICH
 AE 833/16
 16,0 cm/6¹/₄"

AA
 AB
 AC
 AD
AE
 AF
 AK
 AL
 AM
 AO
 AP
 AR
 KA
 KB
 KC
 KD
 KU
 KY

AE NAHT SUTURE SUTURA SUTURE SUTURA

Wundklammerzängchen
 Suture Forceps
 Pinzas para agrafes
 Pincers pour agrafes
 Pinze per agrafes



MICHEL
 AE 850/12
 12,0 cm/4³/₄"



COLLIN
 AE 852/13
 13,0 cm/5"



RICHTER-HEATH
 AE 853/14
 14,0 cm/5¹/₂"



WACHENFELDT
 AE 855/01
 12,5 cm/5"



HEGENBARTH
 AE 856/12
 12,5 cm/5"



MICHEL
 AE 858/12
 12,0 cm/4³/₄"

NAHT SUTURE SUTURA SUTURE SUTURA

Wundklammerzängchen, -pinzetten und Wundklammern
 Suture Forceps and Clips
 Pinzas para agrafes y agrafes
 Pincés pour agrafes et agrafes
 Pinze per agrafes ed agrafes



LANGE
 AE 859/10
 10,0 cm/4"



CHILDE
 AE 860/01
 18,0 cm/7"



CHILDE
 AE 860/02
 18,0 cm/7"

Verkaufseinheit: 1000 Stück
 Unit for Sale: 1000 each
 Unidad de venta: 1000 piezas
 Unité de vente: 1000 pièces
 Unità di vendita: 1000 pezzi



MICHEL

Artikel Nr.	Größen sizes tamaños dimensions dimensioni mm	
AE 870/08	7,5 x 1,75	
AE 870/11	11 x 2,5	
AE 870/12	12 x 3	
AE 870/14	14 x 3	
AE 870/16	16 x 3	
AE 870/18	18 x 3	
AE 870/20	20 x 3	
AE 870/22	22 x 3	

1/1

AA
 AB
 AC
 AD
AE
 AF
 AG
 AH
 AI
 AJ
 AK
 AL
 AM
 AN
 AO
 AP
 AQ
 AR
 AS
 AT
 AU
 AV
 AW
 AX
 AY
 AZ

