ORTHOPÄDIE
ORTHOPAEDIC
ORTOPEDIA
ORTHOPEDIE
ORTOPEDIA

KA

nopa[®] instruments



Amputations- und Resektionssägen
 Amputating and Resection Saws
 Sierras para amputación y resección
 Scies à amputation et résection
 Seghe per amputazione e resezione

Ersatzsägeblatt
 Spare saw blade
 Hoja de sierra de repuesto
 Lame de scie de rechange
 Lama di sega di ricambio

12 mm KA 011/12
 15 mm KA 011/15



CHARRIERE
 KA 010/35
 35,0 cm/14"

Ersatzsägeblatt
 Spare saw blade
 Hoja de sierra de repuesto
 Lame de scie de rechange
 Lama di sega di ricambio

3 mm KA 013/03
 5 mm KA 013/05
 7 mm KA 013/07



HELFERICH-BIER
 KA 012/39
 39,0 cm/15¹/₂"



LINDEMANN
 KA 017/20
 20,0 cm/8"



LANGENBECK
 KA 018/23
 23,0 cm/9"



CHARRIERE
 27,0 cm/10¹/₂" KA 020/27
 30,0 cm/12" KA 020/30
 34,0 cm/13¹/₂" KA 020/34



SATTERLEE
 KA 025/31
 31,0 cm/12¹/₄"

Handbohrapparate
 Hand Drills
 Perforadores de mano
 Perforateurs à main
 Perforatori a mano



STILLE-SHERMAN

KA 050/24
 24,0 cm/9¹/₂"

komplett
 complete
 completo
 complet
 completo



KA 051/25
 Ø 2,5 mm



KA 051/30
 Ø 3,0 mm



KA 051/35
 Ø 3,5 mm

AA
 AB
 AC
 AD
 AE
 AF
 AK
 AL
 AM
 AO
 AP
 AR
 KA
 KB
 KC
 KD
 KU
 KY

Handbohrapparate
Hand Drills
Perforadores de mano
Perforateurs à main
Perforatori a mano



STILLE
KA 060/00
20,0 cm/8"

komplett mit
complete with
completo con
complet avec
completo con

Fig. 1-9
Fig. 1-9
Fig. 1-9
Fig. 1-9
Fig. 1-9



Fig. 1
KA 060/01
Ø 2,5 mm



Fig. 2
KA 060/02
Ø 3,0 mm



Fig. 3
KA 060/03
Ø 3,5 mm



Fig. 4
KA 060/04
Ø 4,0 mm



Fig. 5
KA 060/05
Ø 10,0 mm



Fig. 6
KA 060/06
Ø 5,0 mm



Fig. 7
KA 060/07
Ø 8,0 mm



Fig. 8
KA 060/08
Ø 12,0 mm



Fig. 9
KA 060/09
Ø 16,0 mm



Fig. 10
KA 060/10
Ø 1,0 mm



Fig. 11
KA 060/11
Ø 1,5 mm



Fig. 12
KA 060/12
Ø 2,0 mm

ORTHOPÄDIE ORTHOPAEDIC ORTOPEDIA ORTHOPEDIE ORTOPEDIA

Handbohrapparate
Hand Drills
Perforadores de mano
Perforateurs à main
Perforatori a mano

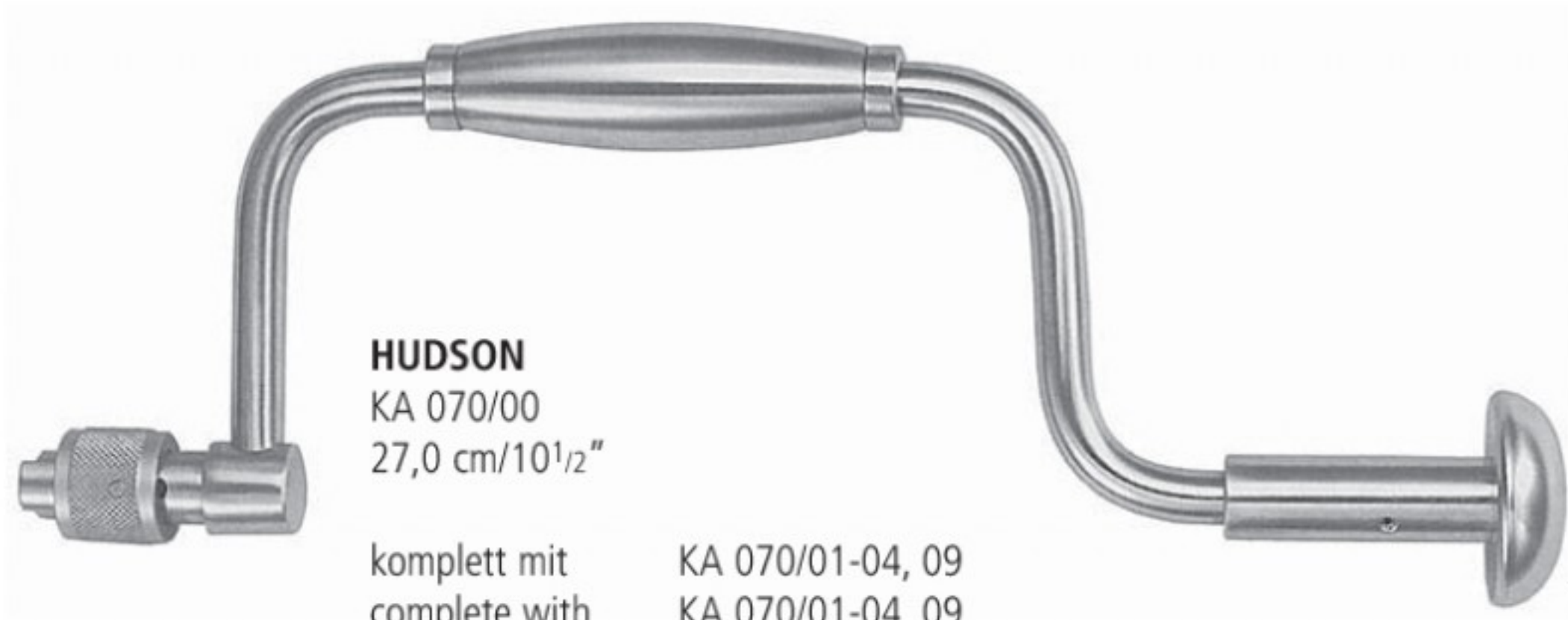

HUDSON
KA 070/00
27,0 cm/10 1/2"

komplett mit
complete with
completo con
complet avec
completo con

KA 070/01-04, 09
KA 070/01-04, 09
KA 070/01-04, 09
KA 070/01-04, 09
KA 070/01-04, 09

1/2



1/2

KA 070/01
Ø 9,0 mm



1/2

KA 070/02
Ø 14,0 mm



1/2

KA 070/03
Ø 16,0 mm



1/2

KA 070/04
Ø 22,0 mm



1/2

CUSHING
KA 070/05
Ø 14,0 mm



1/2

KA 070/09



1/2

Ø 3,2 mm
9,0 cm



1/2

Ø 3,2 mm
7,0 cm

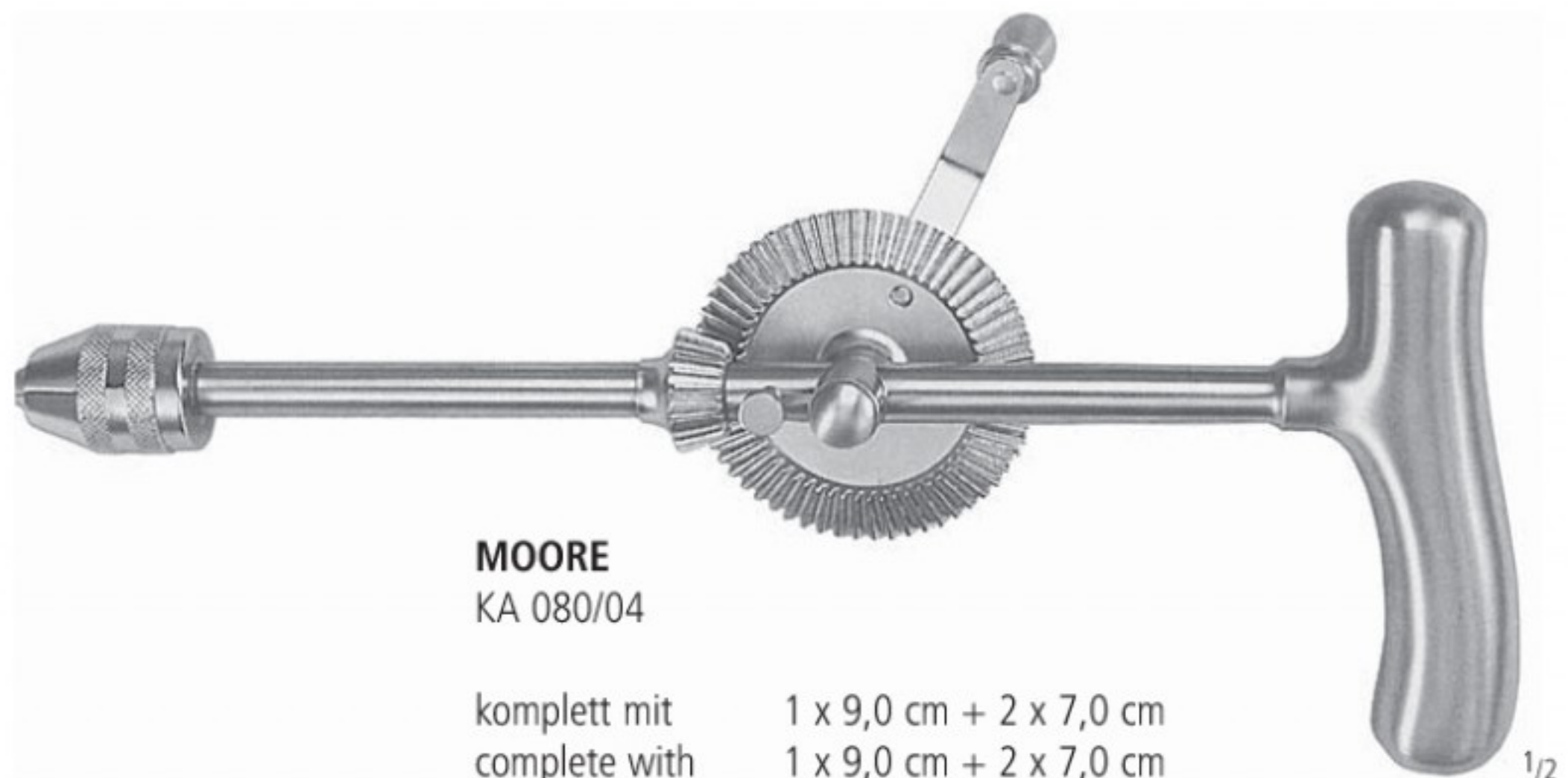

MOORE
KA 080/04

komplett mit
complete with
completo con
complet avec
completo con

1 x 9,0 cm + 2 x 7,0 cm
1 x 9,0 cm + 2 x 7,0 cm
1 x 9,0 cm + 2 x 7,0 cm
1 x 9,0 cm + 2 x 7,0 cm
1 x 9,0 cm + 2 x 7,0 cm

1/2

AA
AB
AC
AD
AE
AF
AK
AL
AM
AO
AP
AR
KA
KB
KC
KD
KU
KY

Handbohrapparate
 Hand Drills
 Perforadores de mano
 Perforateurs à main
 Perforatori a mano

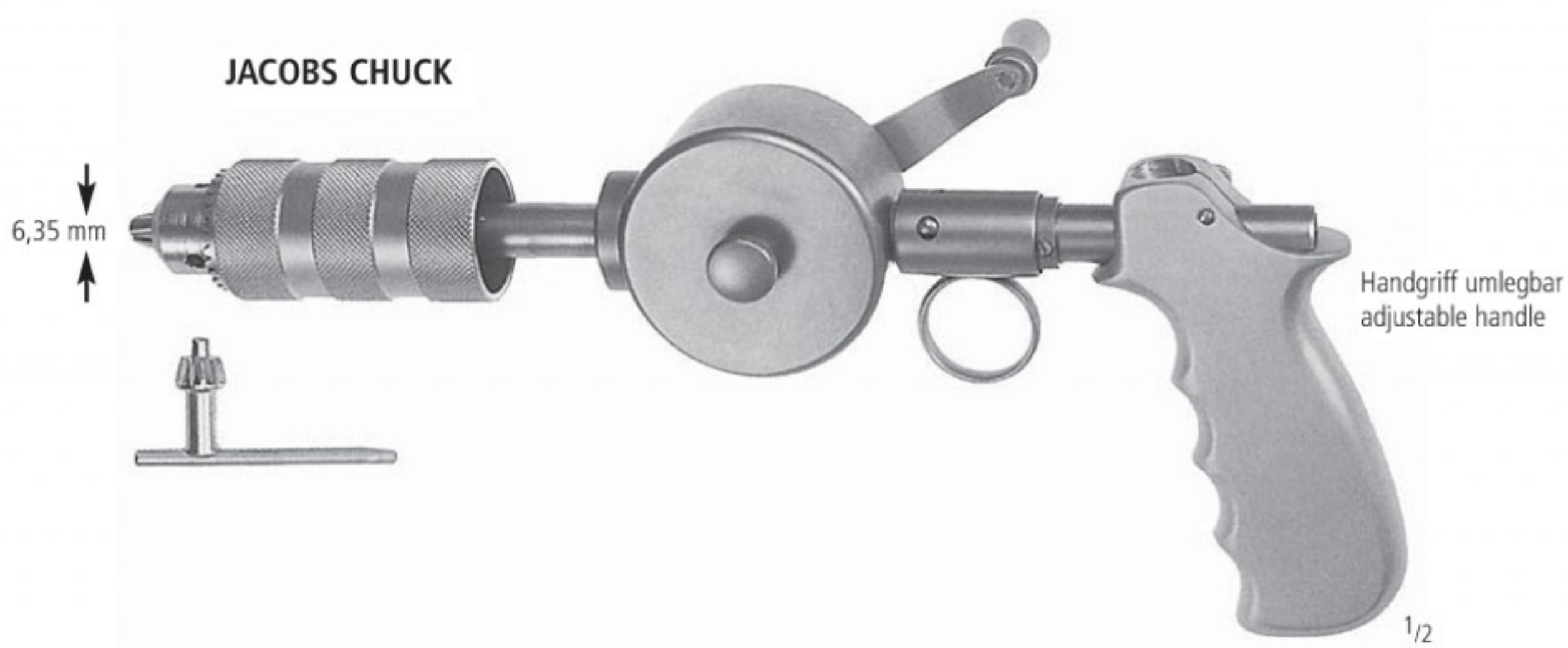

KA 094/00

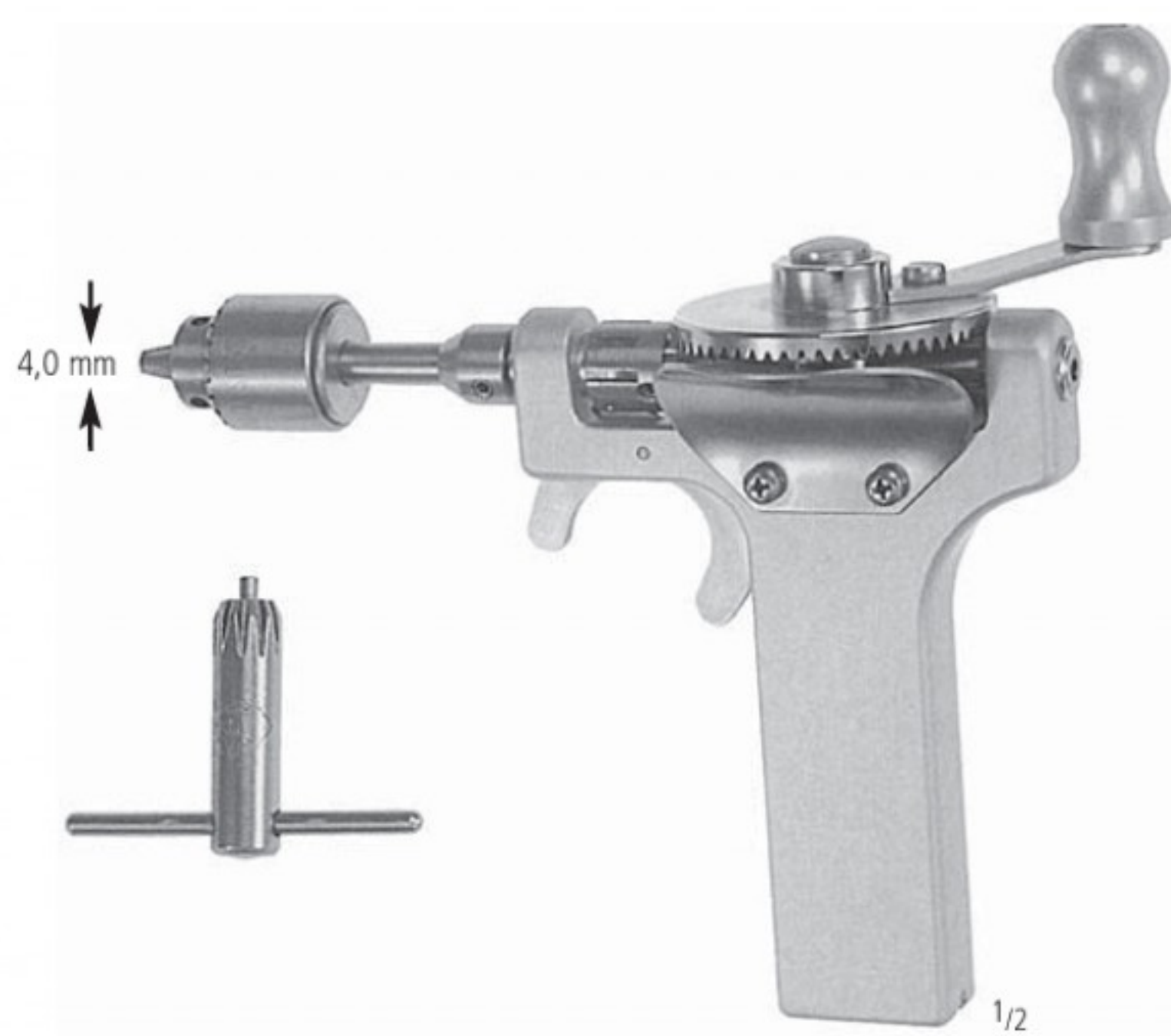

BUNNELL
 KA 096/00

Handbohrapparate
Hand Drills
Perforadores de mano
Perforateurs à main
Perforatori a mano

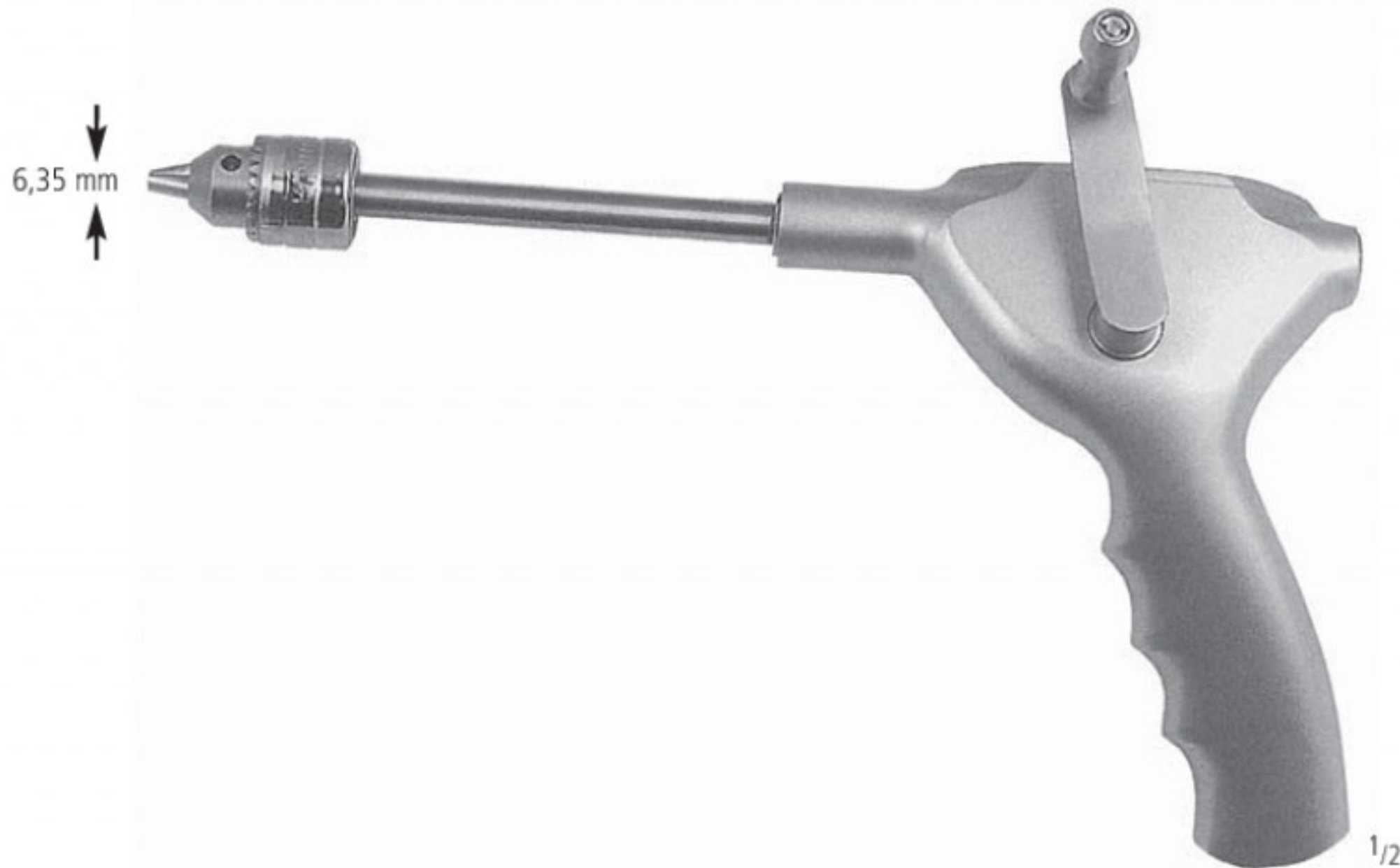

UNIVERSAL 11"
KA 098/00



RALK
KA 100/00



Ø 1,0 mm	KA 102/10
Ø 1,5 mm	KA 102/15
Ø 2,0 mm	KA 102/20
Ø 2,7 mm	KA 102/27
Ø 3,0 mm	KA 102/30
Ø 3,2 mm	KA 102/32
Ø 3,5 mm	KA 102/35
Ø 4,0 mm	KA 102/40
Ø 4,5 mm	KA 102/45
Ø 5,0 mm	KA 102/50
Ø 6,0 mm	KA 102/60
Ø 7,0 mm	KA 102/70
Ø 8,0 mm	KA 102/80
Ø 9,0 mm	KA 102/90
Ø 10,0 mm	KA 102/99

AA
AB
AC
AD
AE
AF
AK
AL
AM
AO
AP
AR
KA
KB
KC
KD
KU
KY

Handbohrapparate
 Hand Drills
 Perforadores de mano
 Perforateurs à main
 Perforatori a mano



KA 103/00



KA 103/10



KA 104/00
 16,0 cm/6¹/₄"



PERTHES
 KA 104/01
 21,0 cm/8¹/₄"



KA 104/02
 14,0 cm/5¹/₂"

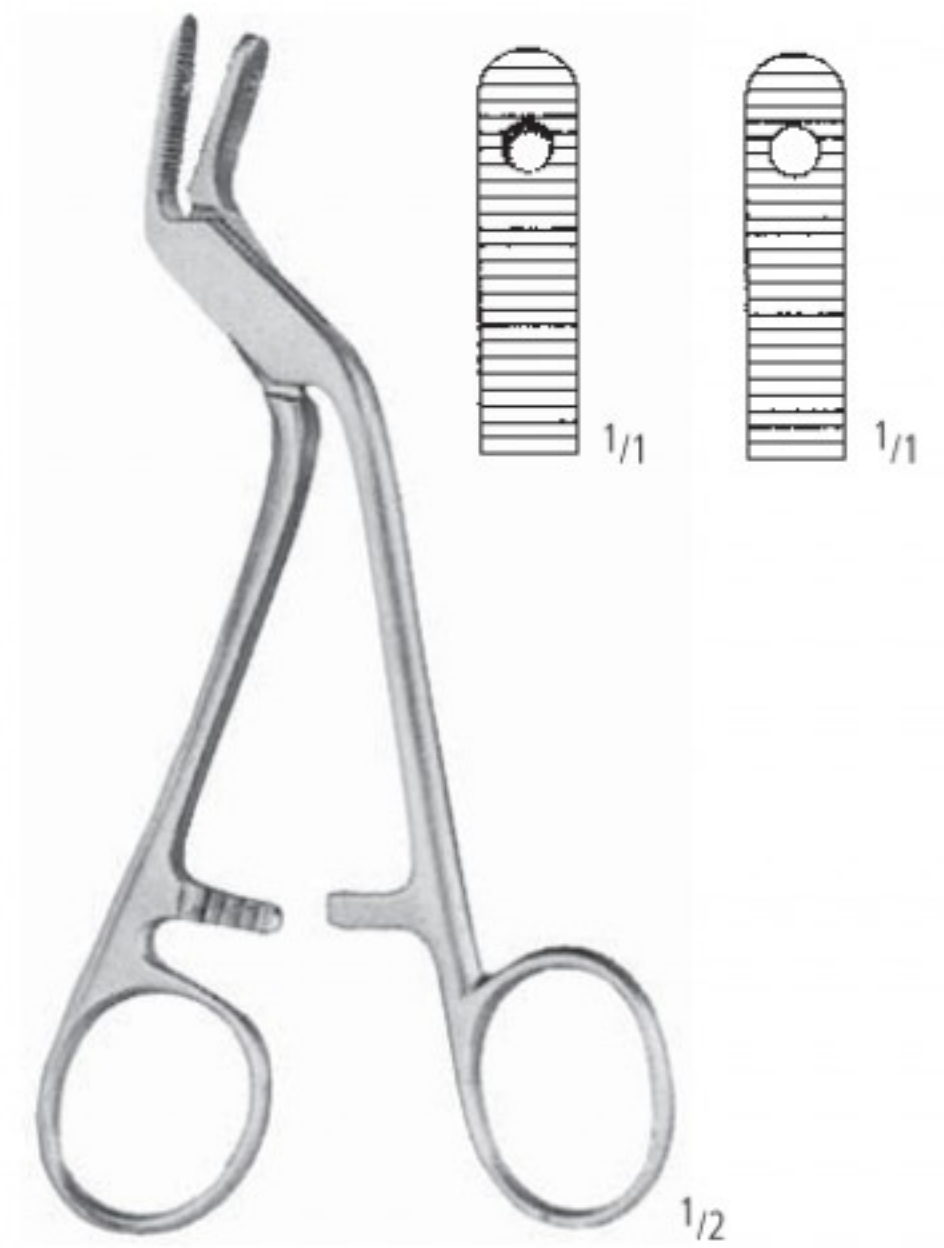

ADISON
 KA 104/03
 15,0 cm/6"



KA 120/00
Akku Bohrrapparat / Accu power drill

Spannung / Voltage	9,6 Volt
Drehzahl / Revolutions	0-750 U/min
Leistung / Power	130/200 Watt



KA 121/00
Luft Bohrrapparat / Air power drill

Drehzahl / Revolutions	600 U/min
Druck / Compression	6,5 bar

AA
AB
AC
AD
AE
AF
AK
AL
AM
AO
AP
AR
KA
KB
KC
KD
KU
KY

Zubehör für KA 120/00 und KA 121/00
 Accessories for KA 120/00 and KA 121/00
 Accesorios para KA 120/00 y KA 121/00
 Accessoires pour KA 120/00 et KA 121/00
 Accessori per KA 120/00 e KA 121/00



KA 122/10
 Adapter mit Jacobs Spannfutter
 Adapter with Jacobs chuck



KA 122/16
 Schnellspannfutter für Kirschnerdrähte 0,8 bis 3mm
 Quick-action chuck for Kirschner wires 0,8 to 3mm



KA 122/11
 Adapter für AO Schaft
 Adapter for AO shank



KA 123/01
 Osteotomie Säge oszillierend
 Sagittal saw oscillating



KA 122/13
 Adapter für DIN Schaft
 Adapter for DIN shank



KA 123/02
 Sternum Säge
 Sternum Saw



KA 122/14
 Adapter für Harris Schaft
 Adapter for Harris shank



KA 122/15
 Adapter für Hudson Schaft
 Adapter for Hudson shank

Ladegerät / Akku
 Charger / Battery
 Cargador / acumulador
 Chargeur d'accus / accumulateur
 Caricabatteria / accumulatore



KA 124/01
 Ladegerät Netzspannung 115V / 240V Ladezeit 60 min
 Charger main voltage 115V / 240V charging time 60 min



KA 124/02
 Ladegerät für 2 Akkus Netzspannung 115V / 240V
 Ladezeit 60 min
 Charger for 2 batteries main voltage 115V / 240V
 Charging time 60 min



KA 124/10
 9,6V 2600mAh



KA 124/11
 12V 2600mAh

AA
 AB
 AC
 AD
 AE
 AF
 AK
 AL
 AM
 AO
 AP
 AR
 KA
 KB
 KC
 KD
 KU
 KY

Knochenhalteklammern
 Bone Holding Clamps
 Clamp sujetador de huesos
 Daviers à os
 Tenaglie per ossa



1/2

GERSTER-LOWMANN

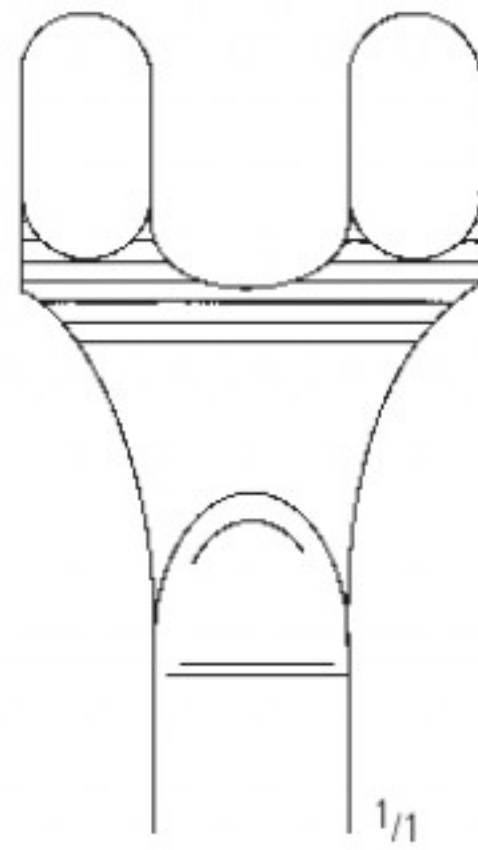

1/1

KA 155/18
 18,0 cm/7"

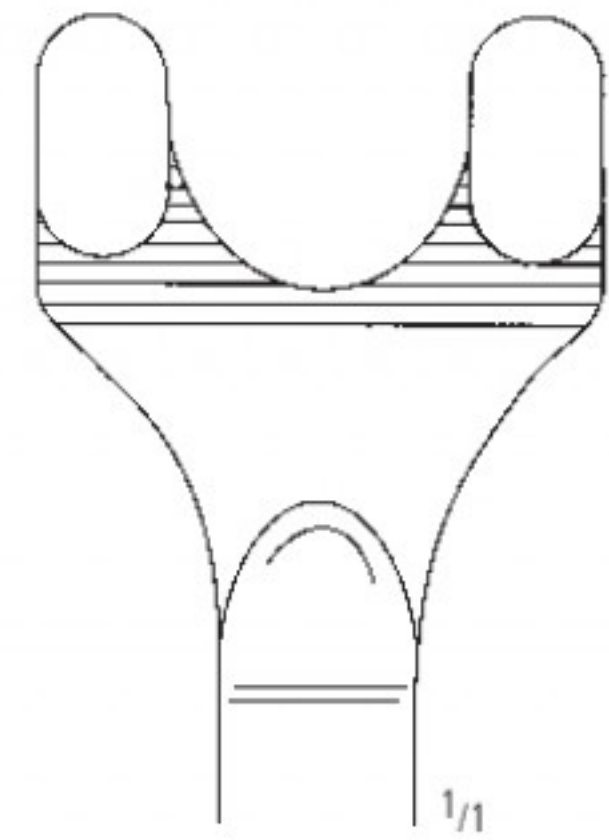

1/1

KA 155/20
 20,0 cm/8"

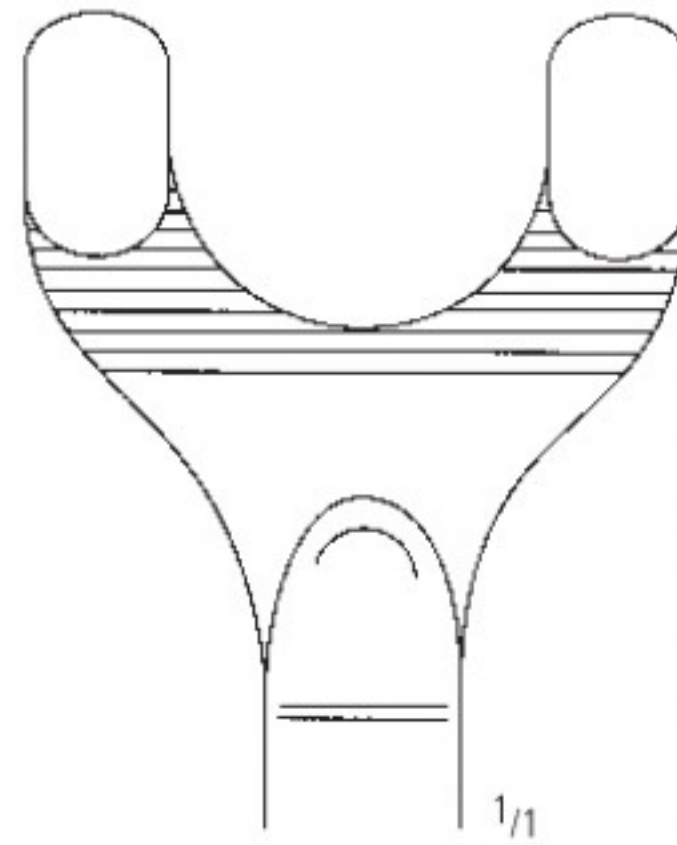

1/1

KA 155/22
 22,0 cm/8³/₄"



1/2

GERSTER
 KA 155/90

Knochenhebel
 Bone Levers
 Elevadores para huesos
 Leviers à os
 Elevatori per ossa

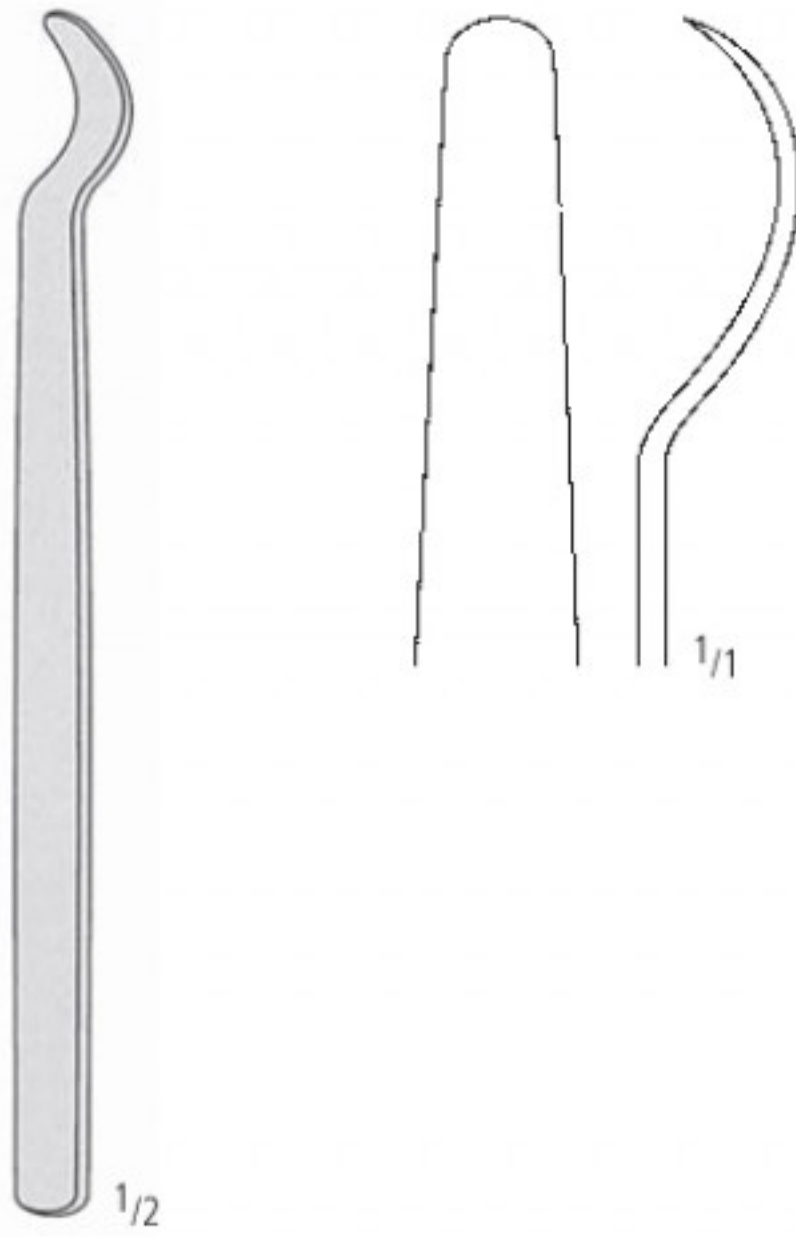

KA 170/00
 14,0 cm/5¹/₂"

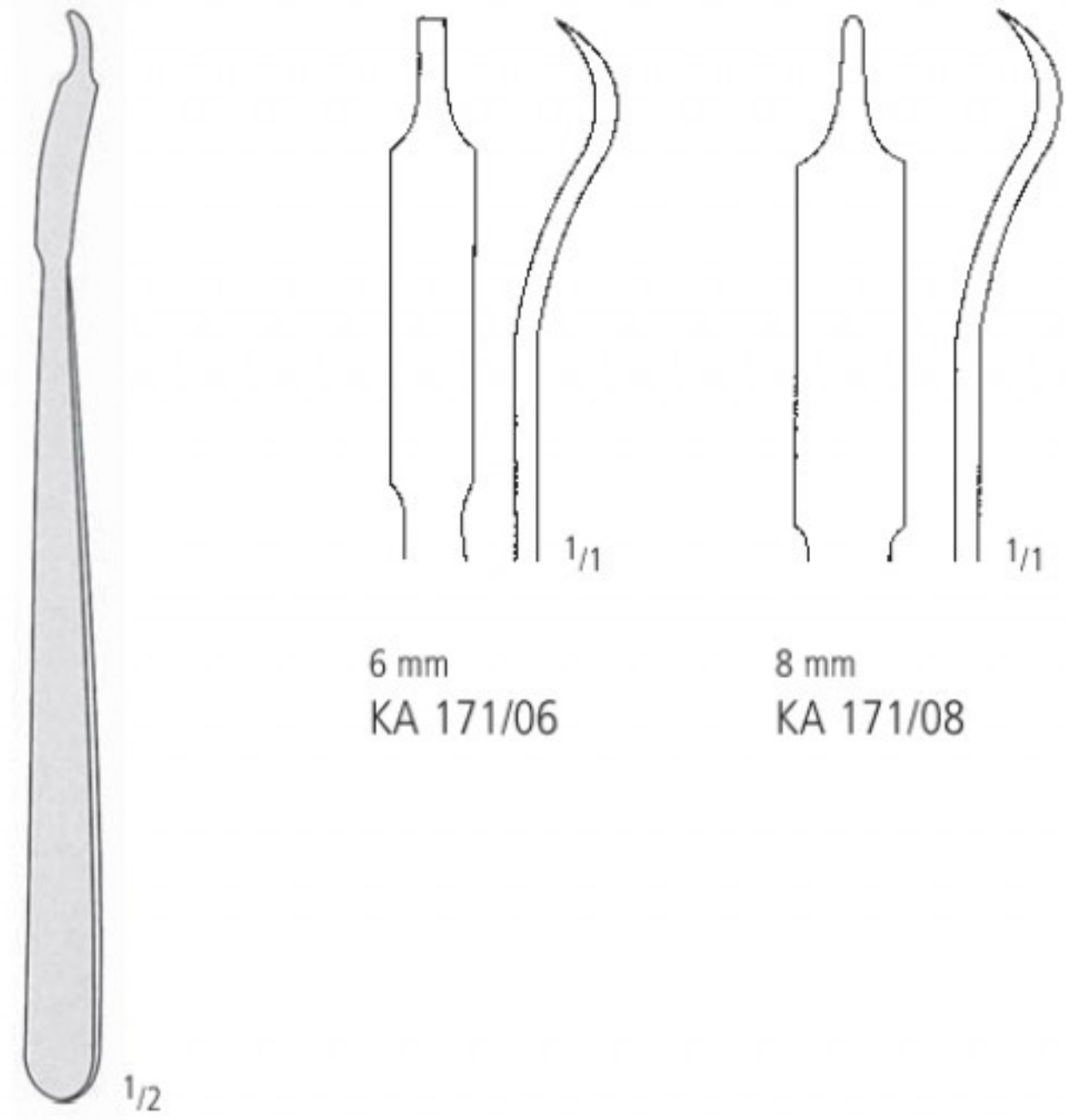

MINI-HOHMANN
 16,0 cm/6¹/₄"

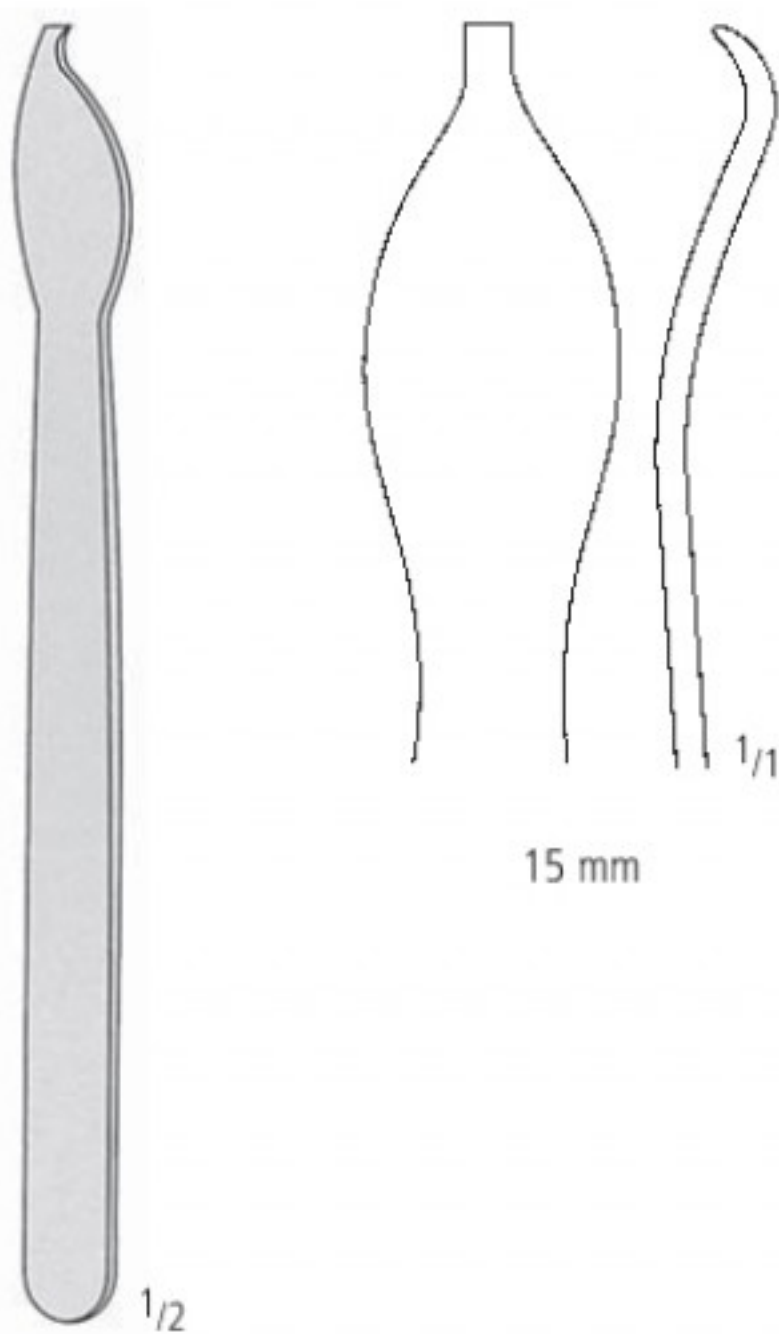

KA 171/15
 17,0 cm/6³/₄"

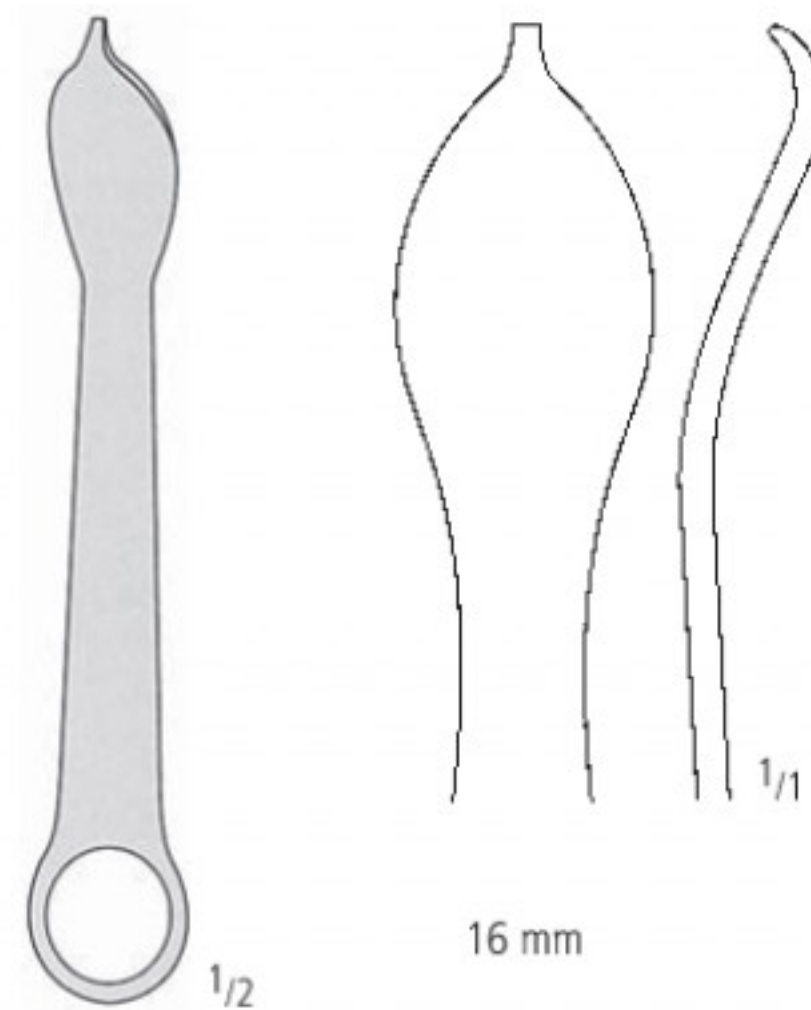

KA 171/16
 12,0 cm/4³/₄"

AA
 AB
 AC
 AD
 AE
 AF
 AG
 AH
 AI
 AJ
 AK
 AL
 AM
 AN
 AO
 AP
 AQ
 AR
 AS
 AT
 AU
 AV
 AW
 AX
 AY
 AZ

KA

KB
 KC
 KD
 KE
 KF
 KG
 KH
 KI
 KJ
 KK
 KL
 KM
 KN
 KO
 KP
 KQ
 KR
 KS
 KT
 KU
 KV
 KW
 KY

Knochenhebel
 Bone Levers
 Elevadores para huesos
 Leviers à os
 Elevatori per ossa



HOHMANN
 KA 172/08
 22,0 cm/8³/₄"

HOHMANN
 KA 172/18
 24,0 cm/9¹/₂"

HOHMANN
 KA 172/43
 26,0 cm/10¹/₄"

HOHMANN
 KA 172/70
 29,0 cm/11¹/₂"

Knochenhebel
 Bone Levers
 Elevadores para huesos
 Leviers à os
 Elevatori per ossa

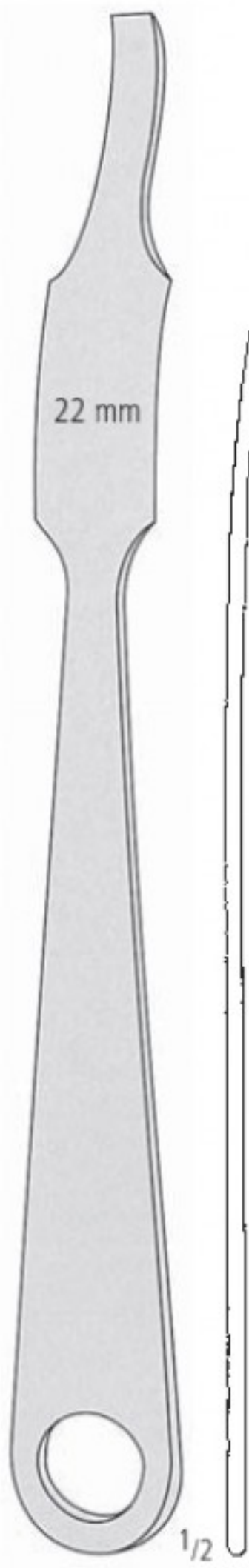

HOHMANN
 KA 173/22
 25,0 cm/9³/₄"

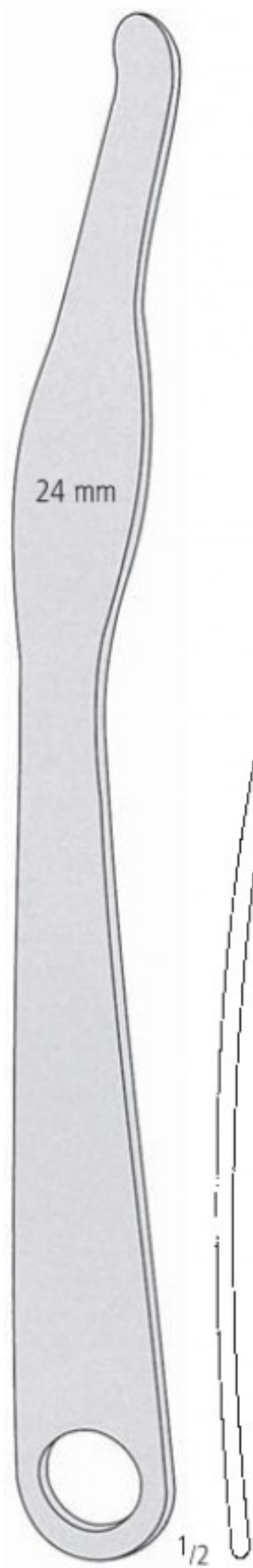

HOHMANN
 KA 173/24
 28,0 cm/11"

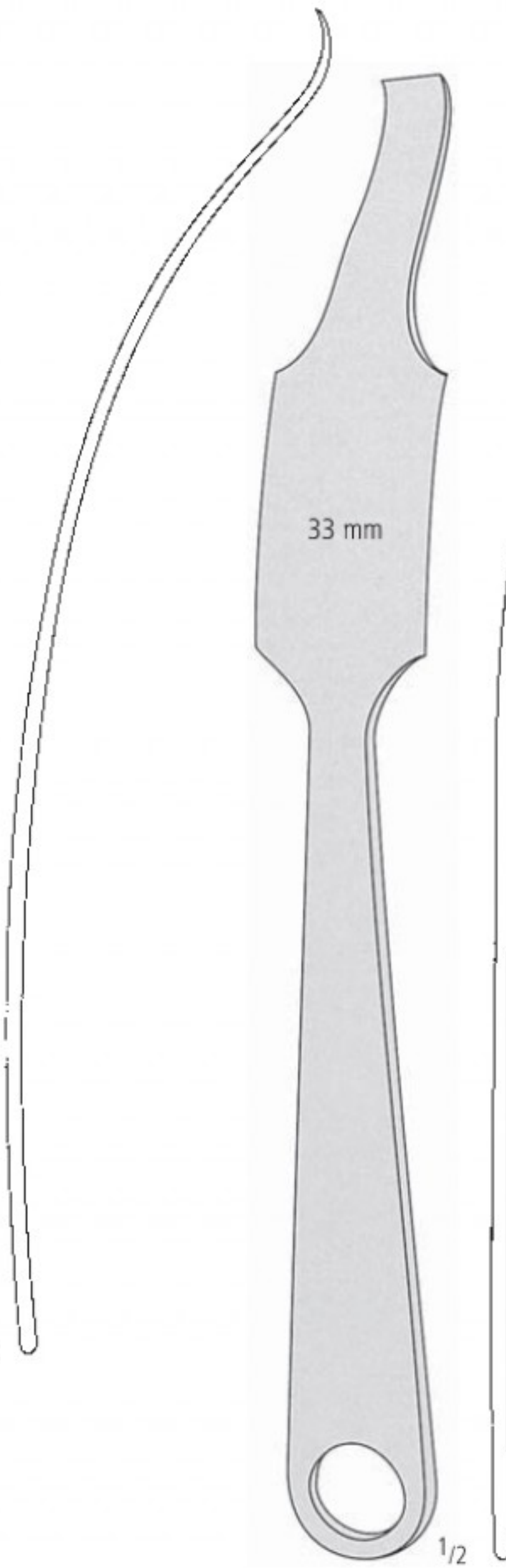

HOHMANN
 KA 173/35
 29,0 cm/11¹/₂"

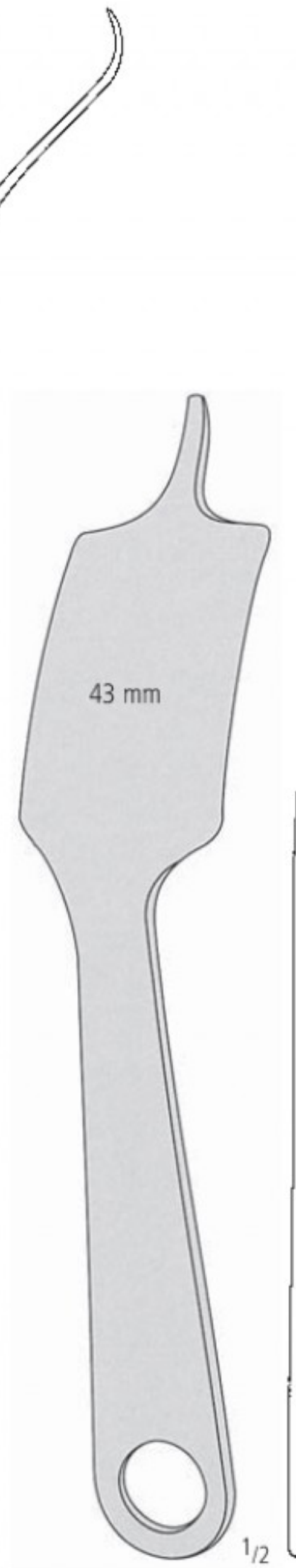

HOHMANN
 KA 173/43
 25,0 cm/9³/₄"

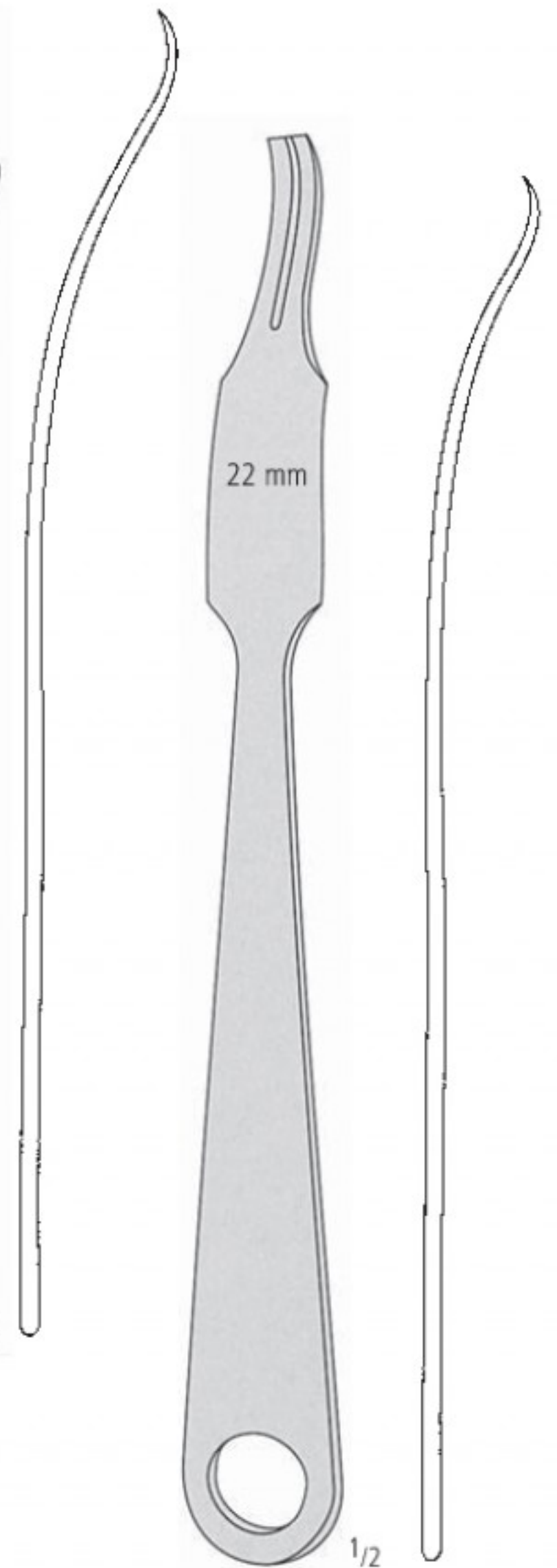

LANGE-HOHMANN
 KA 174/22
 26,0 cm/10¹/₄"

AA
 AB
 AC
 AD
 AE
 AF
 AG
 AH
 AI
 AJ
 AK
 AL
 AM
 AN
 AO
 AP
 AQ
 AR
KA
 KB
 KC
 KD
 KE
 KF
 KG
 KH
 KI
 KJ
 KK
 KL
 KM
 KN
 KO
 KP
 KQ
 KR
 KS
 KT
 KU
 KV
 KW
 KY

Knochenhebel
 Bone Levers
 Elevadores para huesos
 Leviers à os
 Elevatori per ossa



BLOUNT
 KA 175/26
 26,0 cm/10¹/₄"



BLOUNT
 KA 176/26
 26,0 cm/10¹/₄"



TAYLOR
 16,5 cm/6¹/₂"

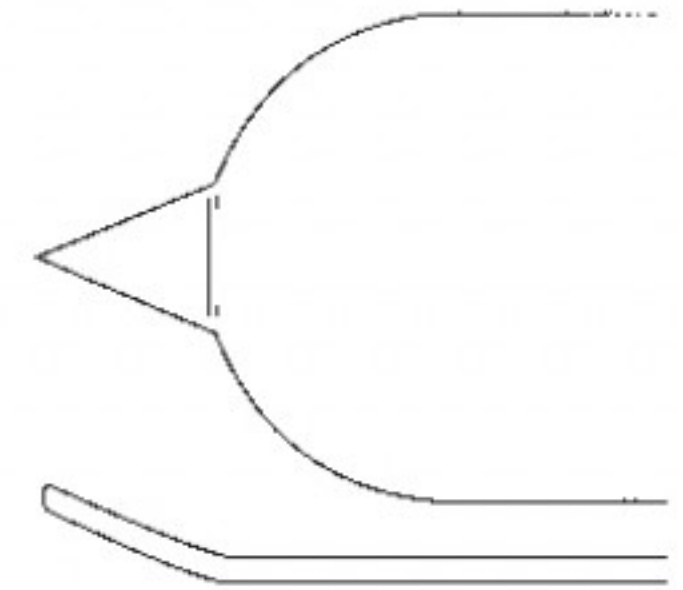

KA 177/01
 75 x 30 mm

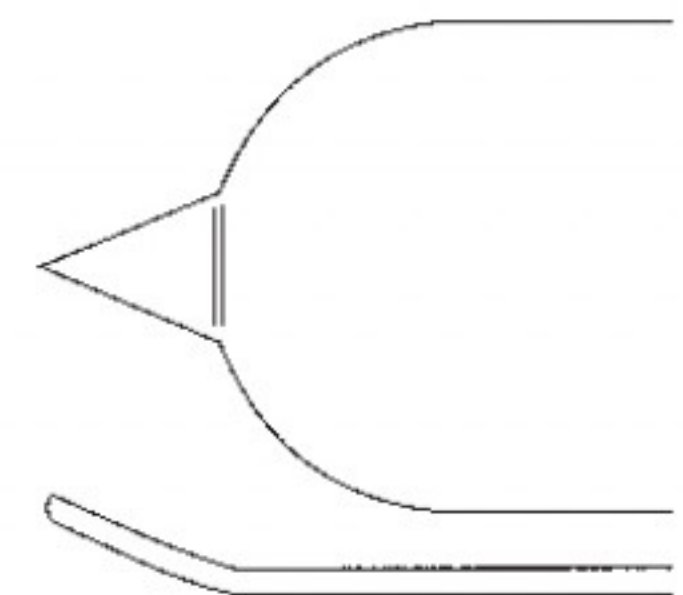

KA 177/02
 100 x 30 mm

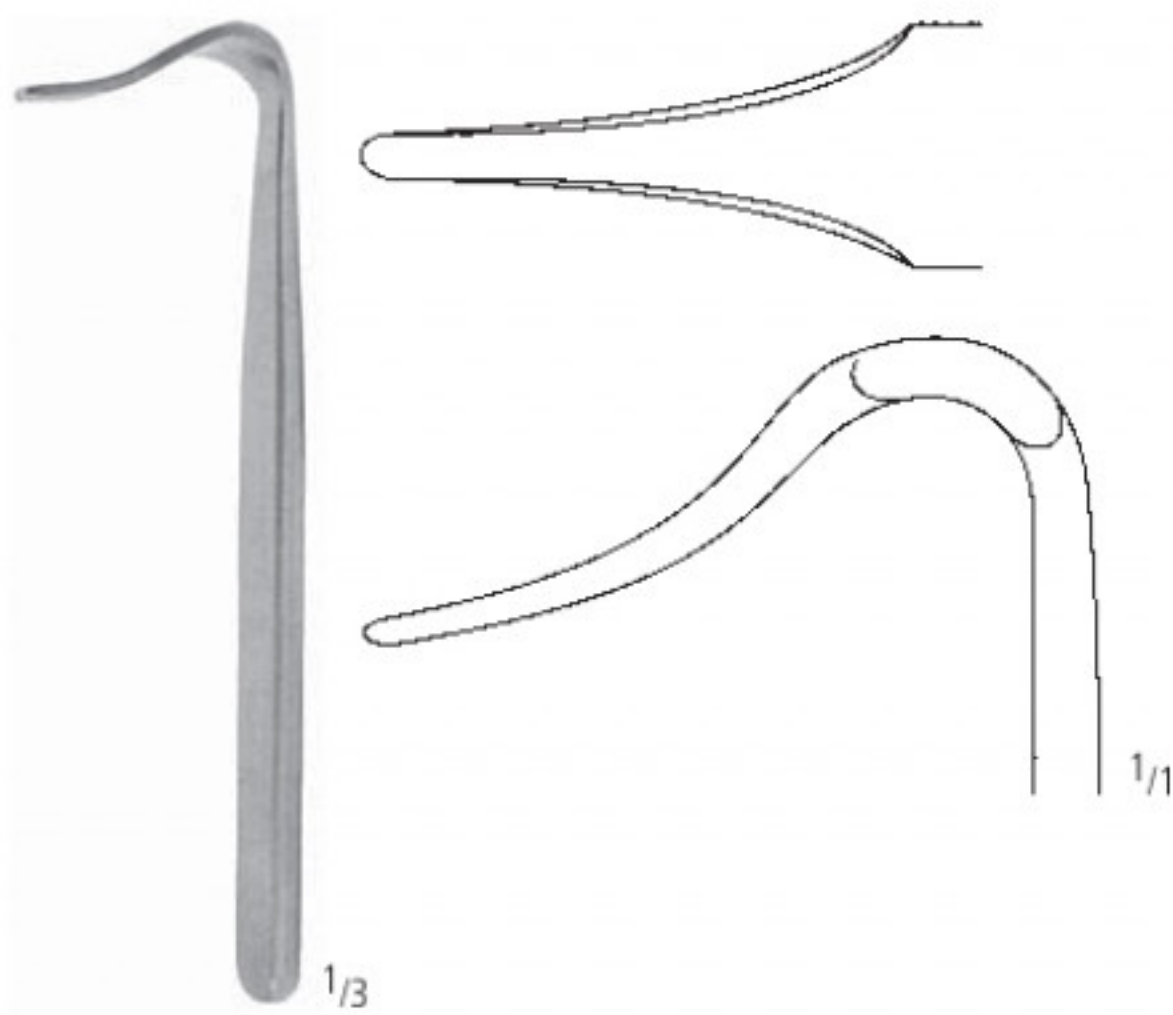

BLOUNT
 KA 177/17
 17,5 cm/7"



CREGO
 KA 178/01
 19,0 cm/7¹/₂"



CREGO
 KA 178/02
 19,0 cm/7¹/₂"



CREGO
 KA 178/03
 19,0 cm/7¹/₂"



CREGO
 KA 178/04
 19,0 cm/7¹/₂"

Extensionsbügel
 Extension Bows
 Estribos para extensión
 Etriers à extension
 Archi per estensione

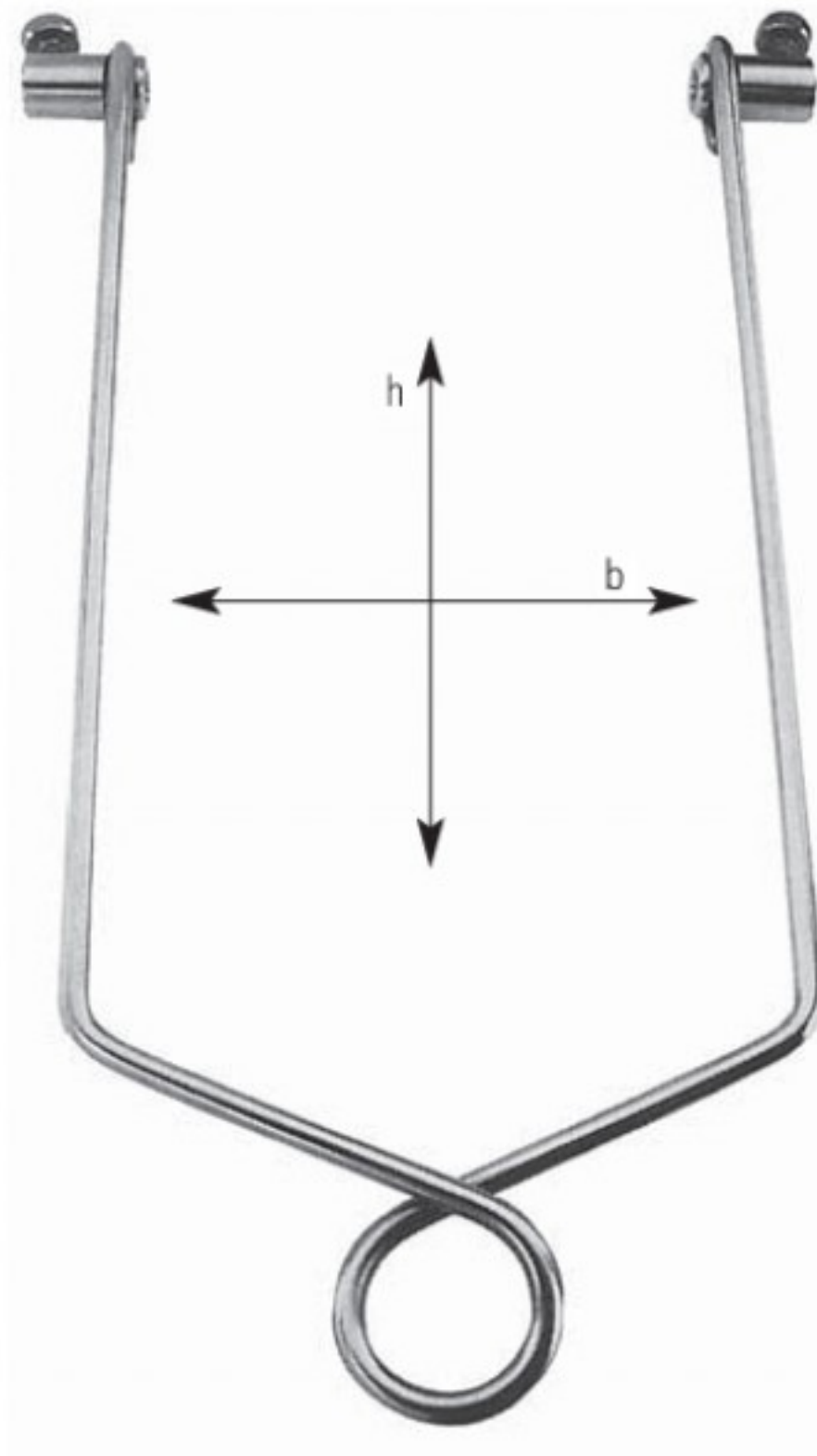

BÖHLER

cm h x b	in. h x b	
16 x 9	6 ¹ / ₄ x 3 ¹ / ₂	KA 200/01
21 x 11	8 ¹ / ₄ x 4 ¹ / ₃	KA 200/02
21 x 15	8 ¹ / ₄ x 6	KA 200/03

für Arm
 for arm
 para brazo
 pour bras
 per braccio

für Oberschenkel und Knie
 for thigh and knee
 para muslo y rodilla
 pour fémur et genou
 per femore e ginocchio

für Oberschenkel und Knie
 for thigh and knee
 para muslo y rodilla
 pour fémur et genou
 per femore e ginocchio

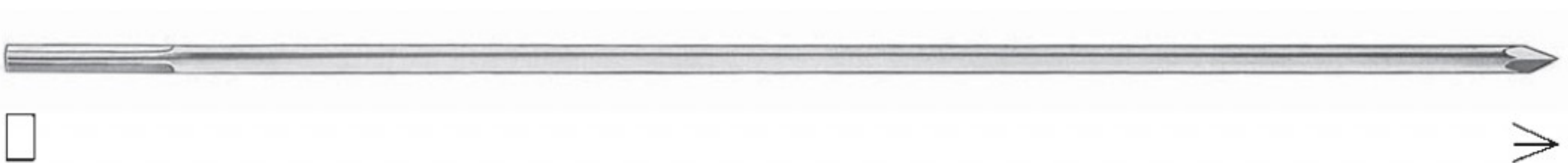

STEINMANN

Ø	L	
4 mm	130 mm	KA 201/13
4 mm	140 mm	KA 201/14
4 mm	150 mm	KA 201/15
4 mm	160 mm	KA 201/16
4 mm	180 mm	KA 201/18
4 mm	200 mm	KA 201/20
4 mm	210 mm	KA 201/21

AA
AB
AC
AD
AE
AF
AK
AL
AM
AO
AP
AR
KA
KB
KC
KD
KU
KY

Extensionsbügel
 Extension Bows
 Estribos para extensión
 Etriers à extension
 Archi per estensione

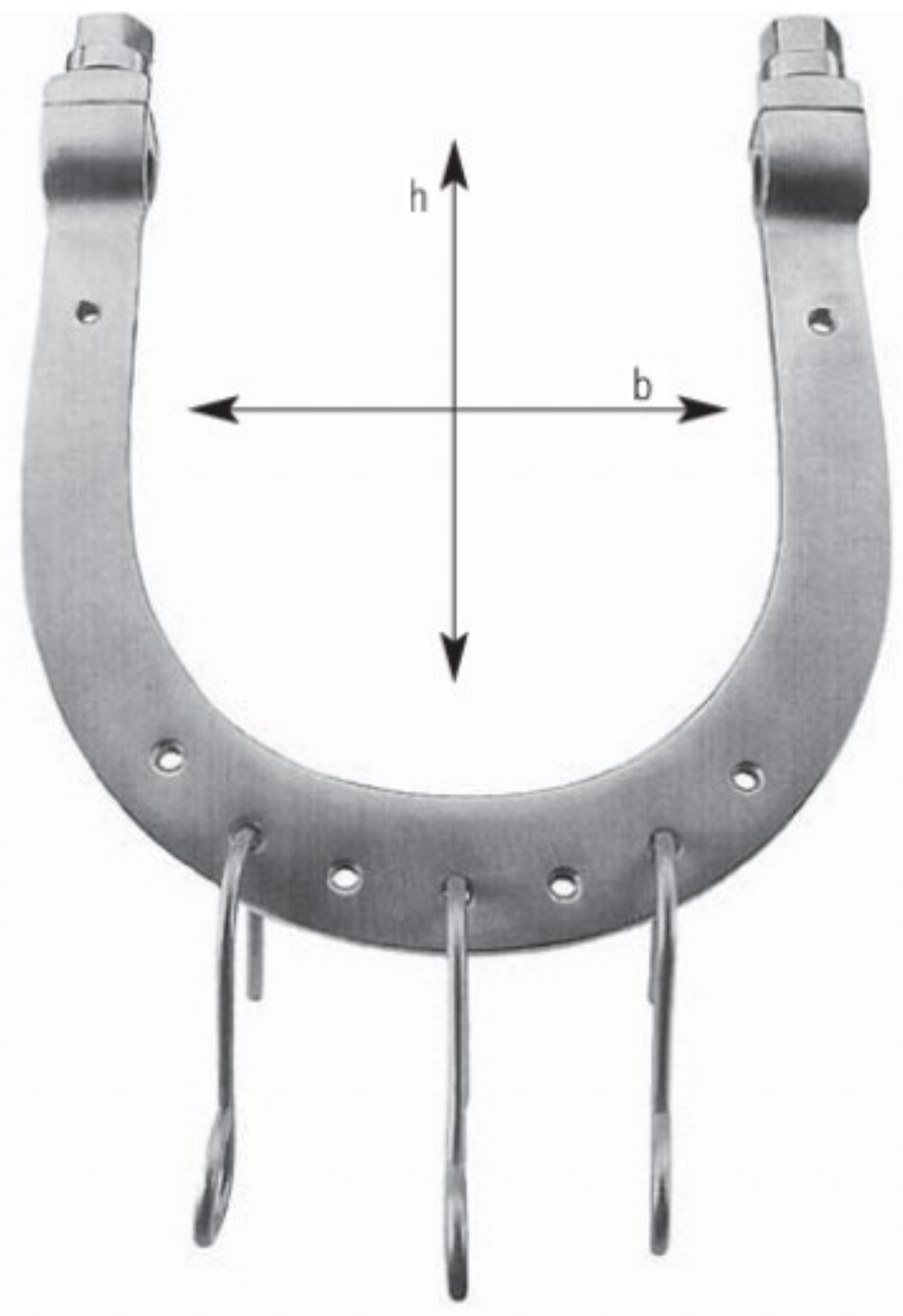

KIRSCHNER

cm h x b	in. h x b	
6 x 6	2 ¹ / ₂ x 2 ¹ / ₂	KA 220/00
7 x 9,5	2 ³ / ₄ x 3 ³ / ₄	KA 220/01
10,5 x 10,5	4 ¹ / ₄ x 4 ¹ / ₄	KA 220/02
12 x 12	4 ³ / ₄ x 4 ³ / ₄	KA 220/03
15,5 x 15,5	6 x 6	KA 220/04
15,5 x 20	6 x 8	KA 220/05



KA 220/90

Drahtzangen
Wire Forceps
Pinzas para hilos
Pinces à fil
Tenaglie fili

AA
AB
AC
AD
AE
AF
AK
AL
AM
AO
AP
AR
KA
KB
KC
KD
KU
KY



NIRO
KA 250/00
15,0 cm/6"



KA 250/14
14,0 cm/5 1/2"



KA 251/14
14,0 cm/5 1/2"



KA 252/16
16,0 cm/6 1/4"

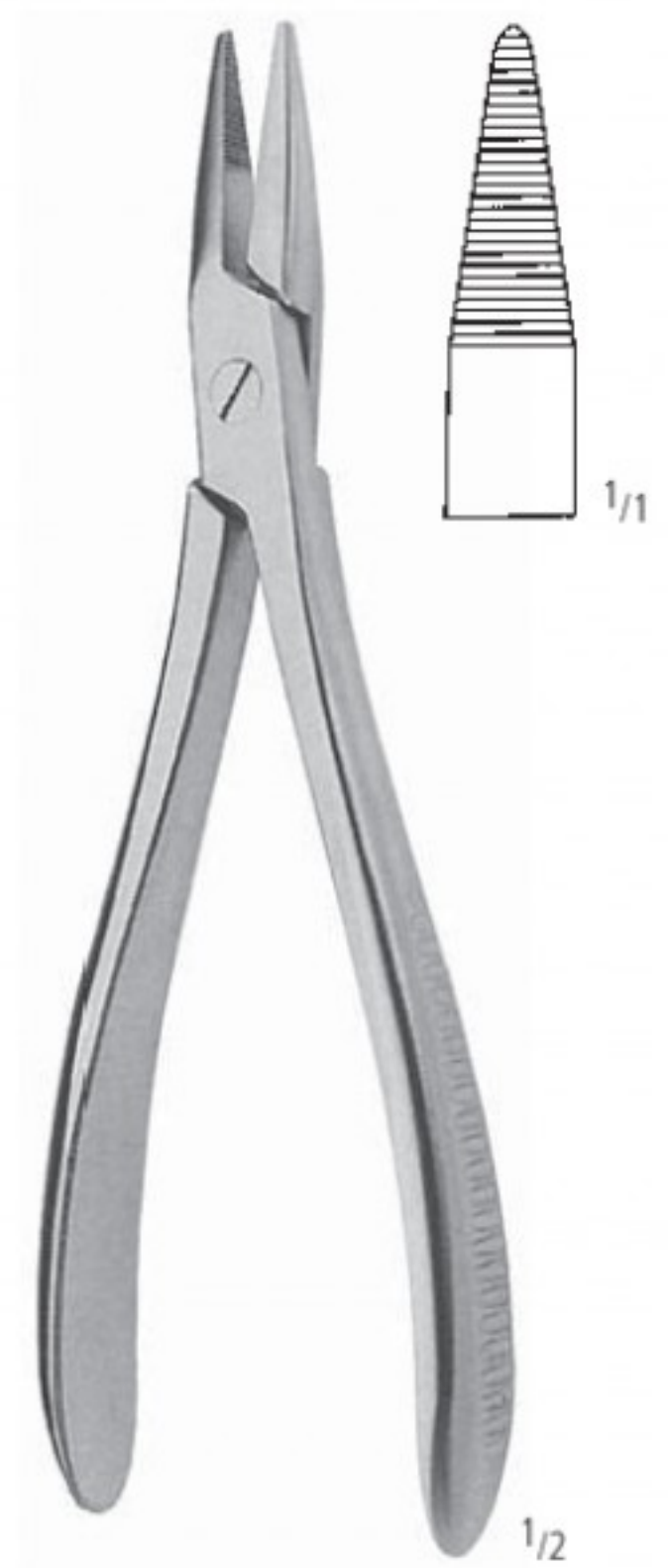

KA 253/19
19,0 cm/7 1/2"

Drahtzangen
Wire Forceps
Pinzas para hilos
Pincers à fil
Tenaglie fili



1/2

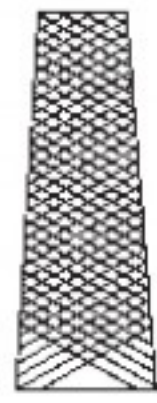

1/1

KA 255/01

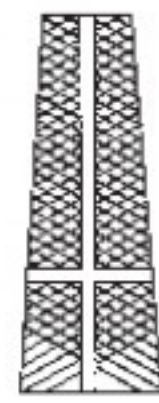

1/1

KA 255/02



1/2



1/1

KA 257/15
15,0 cm/6"

17,0 cm/6³/₄"



1/2



1/1

KA 260/18



1/1

KA 261/18



1/1

KA 262/18



1/1

KA 263/18

18,0 cm/7"

Drahtzangen
Wire Forceps
Pinzas para hilos
Pinces à fil
Tenaglie fili



STERNUM

nopa
TUC[®]

18,5 cm/7¹/₄"

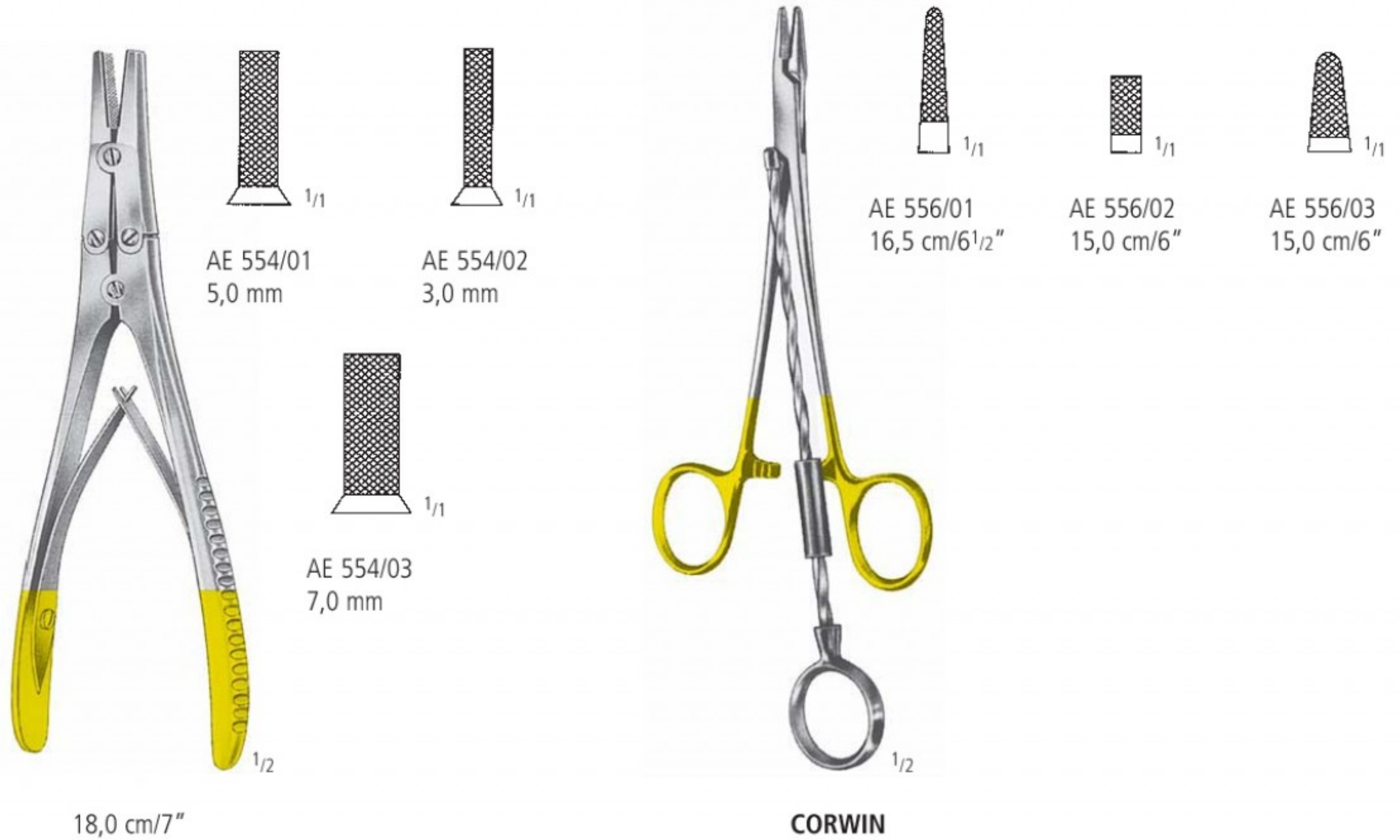

18,0 cm/7"

CORWIN

AA
AB
AC
AD
AE
AF
AK
AL
AM
AO
AP
AR
KA
KB
KC
KD
KU
KY

Flachzangen
 Flat Nose Pliers
 Alicates planos
 Pinces plates
 Tenaglie piate

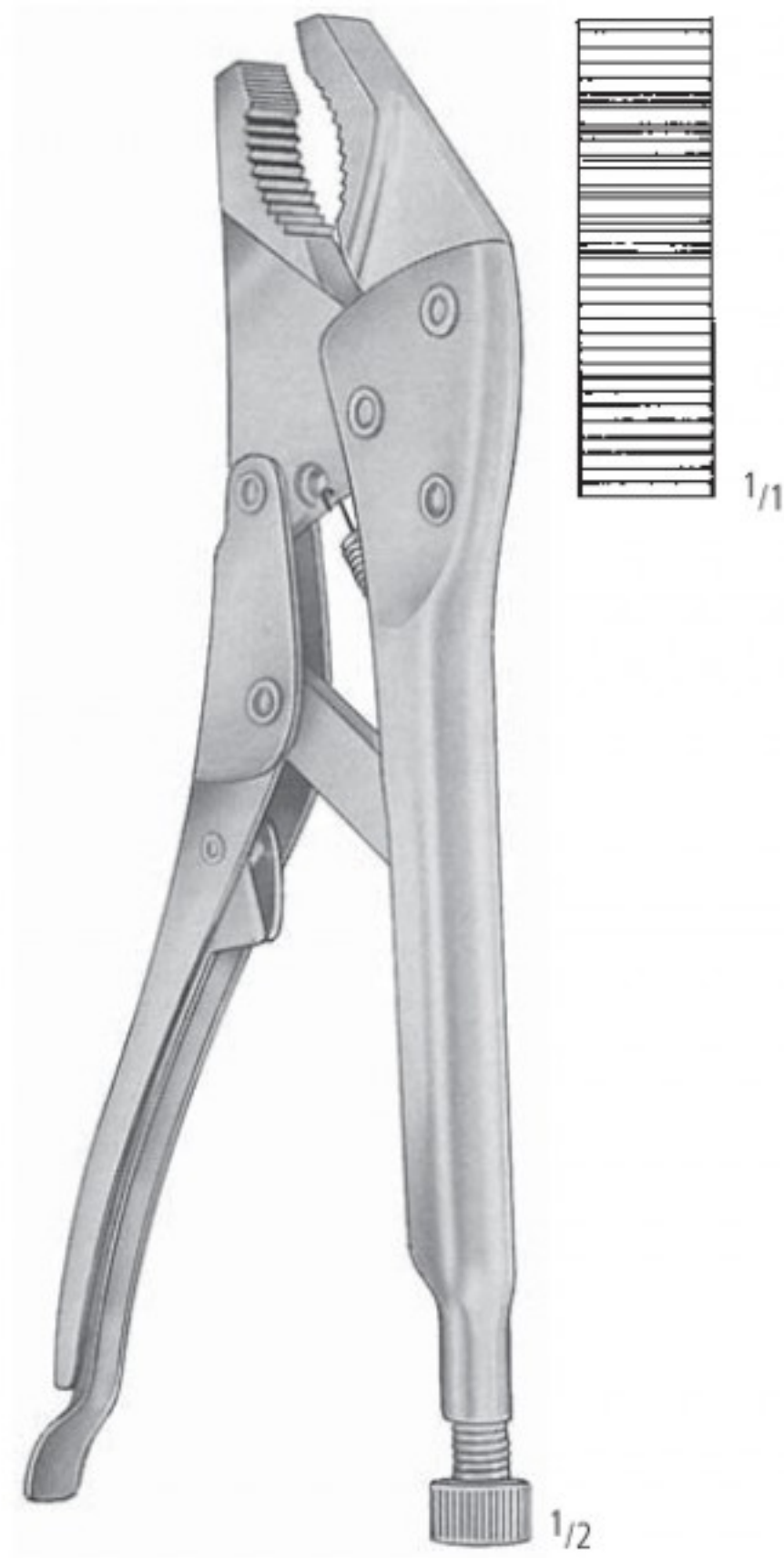

KA 265/18
 18,0 cm/7"

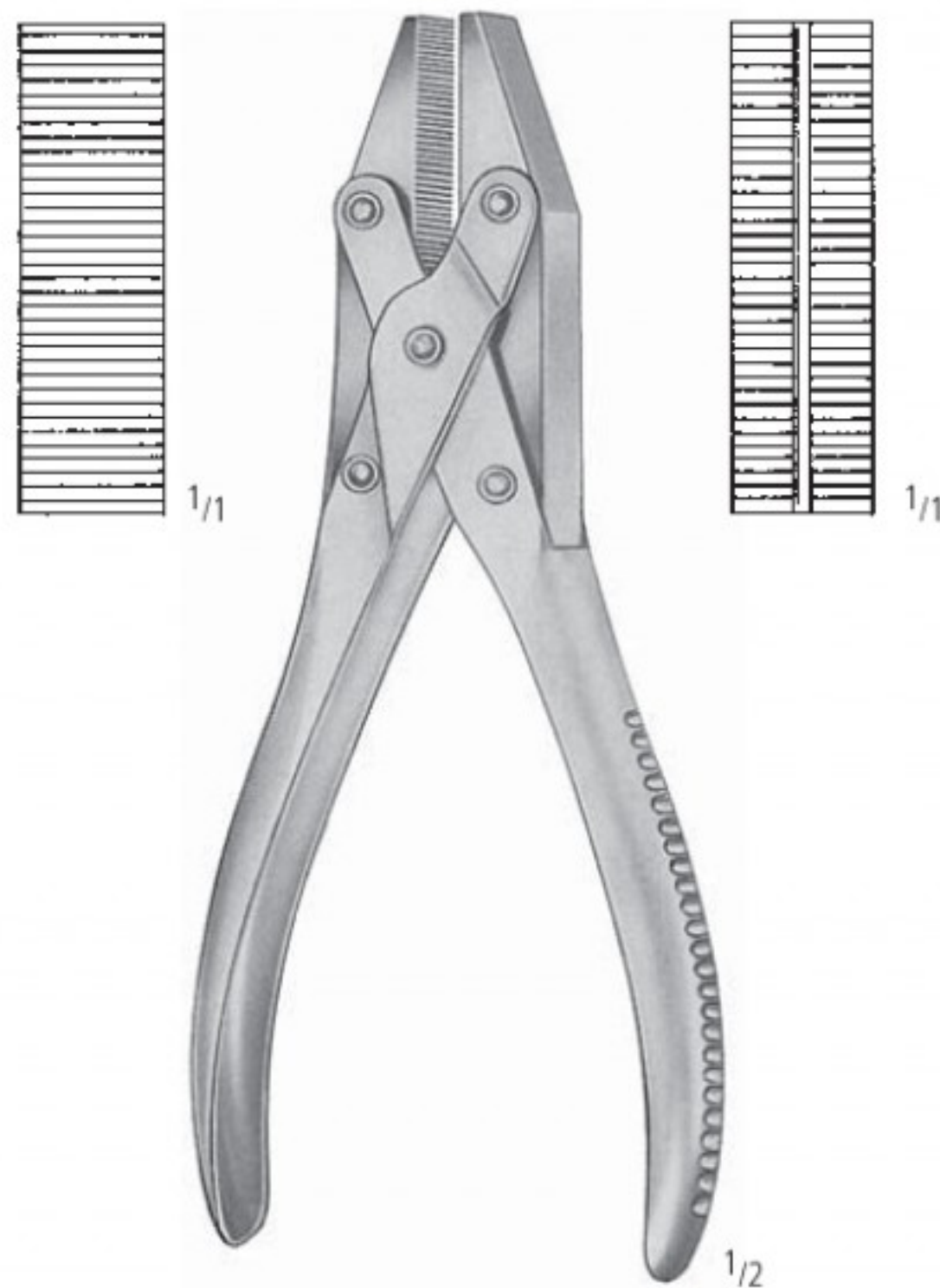

KA 266/17
 17,0 cm/6³/₄"

Drahtzangen
Wire Forceps
Pinzas para hilos
Pinces à fil
Tenaglie fili



KA 270/15
15,0 cm/6"



KA 271/16
16 cm/6¹/₄"



KA 272/18
18,0 cm/7"

für weiche Drähte bis 2,0 mm Ø
for soft wires up to 2,0 mm Ø
para hilos blandos hasta 2,0 mm de Ø
pour fils mous jusqu'à 2,0 mm de Ø
per fili morbidi sino a mm. 2,0 di Ø

für harte Drähte bis 1,5 mm Ø
for hard wires up to 1,5 mm Ø
para hilos duros hasta 1,5 mm de Ø
pour fils durs jusqu'à 1,5 mm de Ø
per fili duri sino a mm. 1,5 di Ø



KA 273/17
17,0 cm/6³/₄"



für weiche Drähte bis 2,0 mm Ø
for soft wires up to 2,0 mm Ø
para hilos blandos hasta 2,0 mm de Ø
pour fils mous jusqu'à 2,0 mm de Ø
per fili morbidi sino a mm. 2,0 di Ø

für harte Drähte bis 1,6 mm Ø
for hard wires up to 1,6 mm Ø
para hilos duros hasta 1,6 mm de Ø
pour fils durs jusqu'à 1,6 mm de Ø
per fili duri sino a mm. 1,6 di Ø



KA 273/22
22 cm/8³/₄"

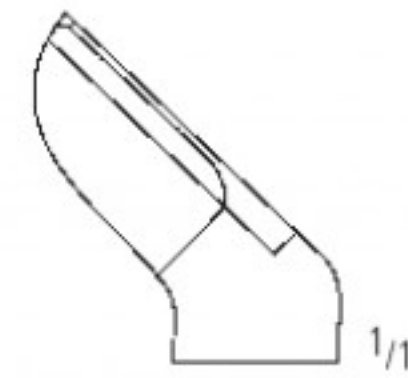

für Drähte bis 2,5 mm Ø
for wires up to 2,5 mm Ø
para hilos hasta 2,5 mm de Ø
pour fils jusqu'à 2,5 mm de Ø
per fili sino a mm. 2,5 di Ø

AA
AB
AC
AD
AE
AF
AK
AL
AM
AO
AP
AR
KA
KB
KC
KD
KU
KY

Drahtzangen
Wire Forceps
Pinzas para hilos
Pinces à fil
Tenaglie fili



KA 275/47
47,0 cm/18¹/₂"

ORTHOPÄDIE ORTHOPAEDIC ORTOPEDIA ORTHOPEDIE ORTOPEDIA

Drahtspanninstrumente
Wire Twisting Instruments
Tensores cierra-hilos
Tendeurs serre-fils
Strumenti tendifili



LOUTE
KA 280/21
21,0 cm/8¹/₄"



DEMEL

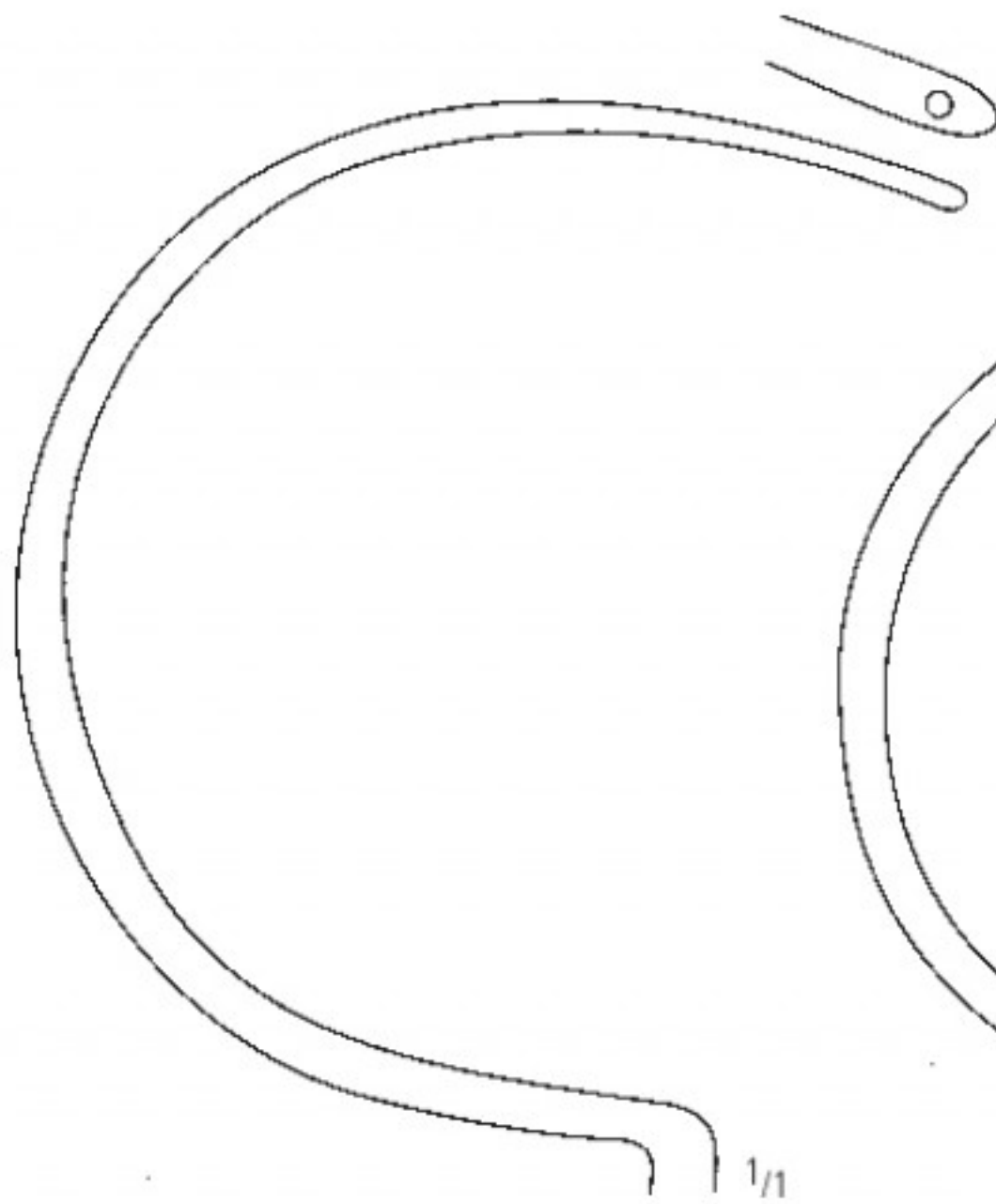

KA 281/01
30,5 cm/12"

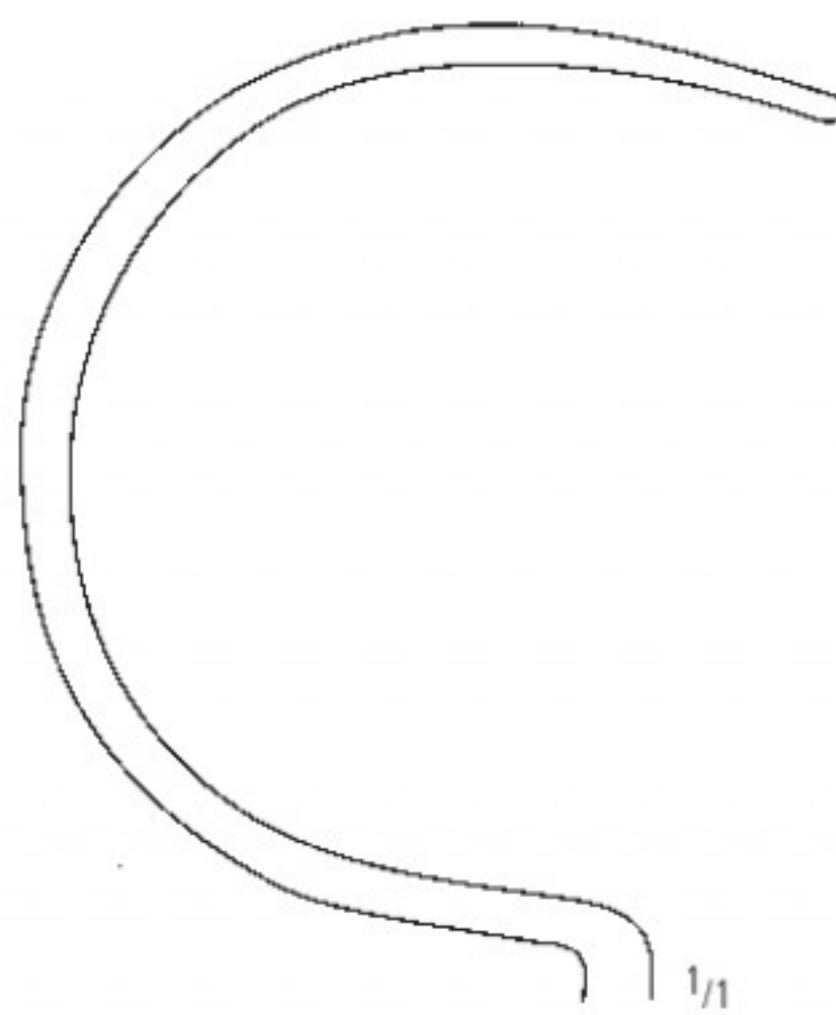

KA 281/02
28,5 cm/11¹/₄"

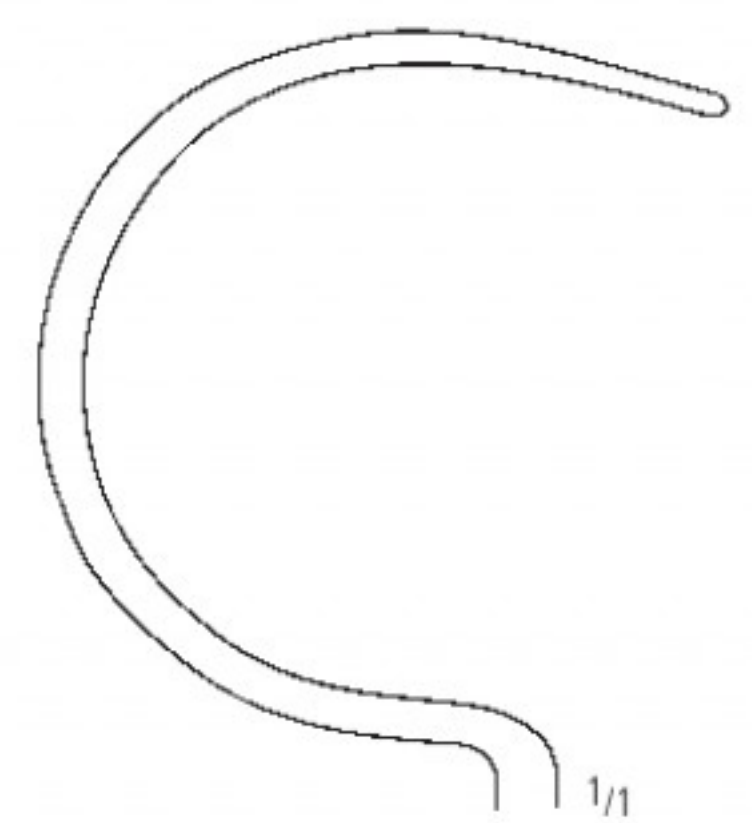

KA 281/03
27,5 cm/10³/₄"

AA
AB
AC
AD
AE
AF
AK
AL
AM
AO
AP
AR
KA
KB
KC
KD
KU
KY

Arthroskopie
Arthroscopy
Artroscopio
Arthroscopie
Artroscopia



Ø 4 mm
KA 300/01
22,5 cm/9"

5 mm



KA 300/02



KA 300/03



KA 300/04



KA 300/05

4 mm



KA 300/06

3 mm



KA 300/07



KA 300/08



KA 300/09

Ø 3 mm



KA 300/10

Ø 3 mm



KA 300/11

1/1

1/1

ORTHOPÄDIE ORTHOPAEDIC ORTOPEDIA ORTHOPEDIE ORTOPEDIA

Arthroskopie
Arthroscopy
Artroscopio
Arthroscopie
Artroscopia

Griff allein
Handle only
Mango solo
Manche seul
Solo impugnatura



KA 302/00
12,5 cm/5"



KA 302/01

KA 302/02

KA 302/03

KA 302/04

KA 302/05

KA 302/06

KA 302/07

KA 302/08

KA 302/09

KA 302/10

KA 302/11

KA 302/12

Ø 3 mm

Ø 7 mm

3 mm

5 mm

7 mm

2,5 mm

3,5 mm

KA 302/13

KA 302/14

KA 302/15

KA 302/16

KA 302/17

KA 302/18

KA 302/19

AA
AB
AC
AD
AE
AF
AK
AL
AM
AO
AP
AR
KA
KB
KC
KD
KU
KY

KA ORTHOPÄDIE ORTHOPAEDIC ORTOPEDIA ORTHOPEDIE ORTOPEDIA

Arthroskopie
Arthroscopy
Artroscopio
Arthroscopie
Artroscopia



Griff allein
Handle only
Mango solo
Manche seul
Solo impugnatura

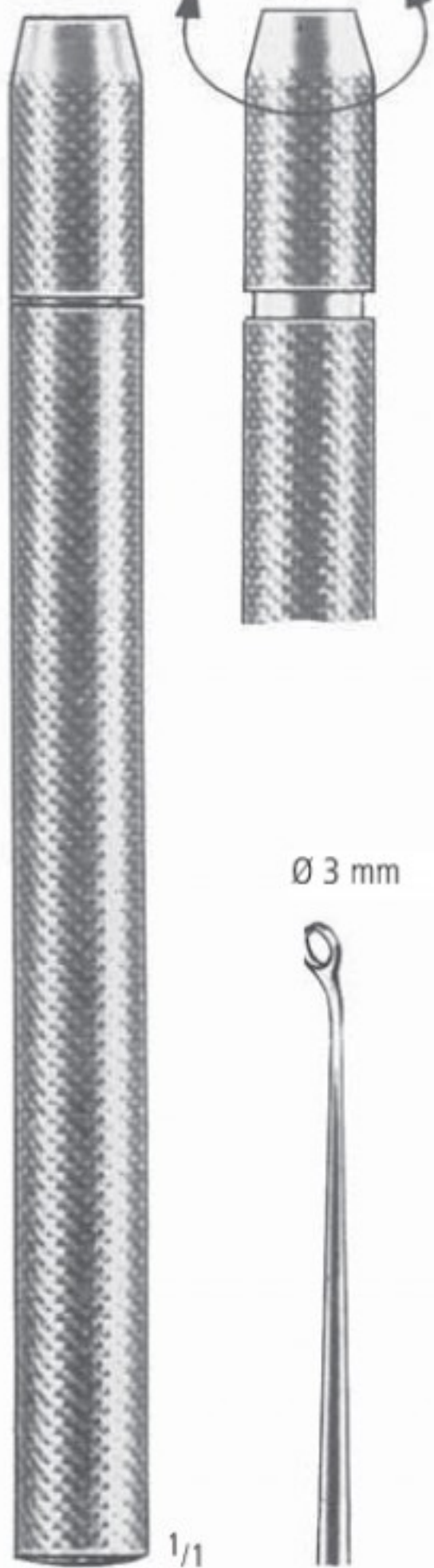

KA 304/01 KA 304/02 KA 304/03 KA 304/04 KA 304/05 KA 304/06



KA 304/07 KA 304/08 KA 304/09 KA 304/10 KA 304/11 KA 304/12

Ø 3 mm

Ø 7 mm

3 mm

5 mm

7 mm

2,5 mm

3,5 mm



KA 304/00
12,5 cm/5"

KA 304/13

KA 304/14

KA 304/15

KA 304/16

KA 304/17

KA 304/18

KA 304/19

Arthroskopie
Arthroscopy
Artroscopio
Arthroscopie
Artroscopia

- >> Bitte beachten Sie folgende Symbole für Arthroskopiezangen.
- >> Kindly note the following symbols for Arthroscopy Forceps.
- >> Tengan en cuenta los siguientes simbolos para pinzas de artroscopio.
- >> Veuillez noter les différentes spécifications pour les pinces arthroscopie.
- >> Notate le seguenti indicazioni per le pinze per artroscopia.



gerade
straight
rectas
droit
rette

7° aufgebogen
7° curved up
7° angulada
7° courbes en montant
7° curva in alto

15° aufgebogen
15° curved up
15° angulada
15° courbes en montant
15° curva in alto



30° rechts gebogen
30° curved right
30° curva a la derecha
30° courbes à droite
30° curva a destra

30° links gebogen
30° curved left
30° curva a la izquierda
30° courbes à gauche
30° curva a sinistra

45° rechts gebogen
45° curved right
45° curva a la derecha
45° courbes à droite
45° curva a destra

45° links gebogen
45° curved left
45° curva a la izquierda
45° courbes à gauche
45° curva a sinistra

- * >> Standardbiegung beträgt 30°. Auf Anfrage sind auch andere Biegungen lieferbar.
- >> Standard angle is 30°. Other angles are available on request.
- >> Angulo standard del extremo 30°. Otros angulos se pueden fabricar sobre pedido.
- >> L'angle standard est de 30°. D'autres angles sont disponibles sur demande.
- >> L'angolo standard è di 30°. Altre angolazioni sono disponibili su richiesta.

AA
AB
AC
AD
AE
AF
AK
AL
AM
AO
AP
AR
KA
KB
KC
KD
KU
KY

KA ORTHOPÄDIE ORTHOPAEDIC ORTOPEDIA ORTHOPEDIE ORTOPEDIA

Arthroskopie
Arthroscopy
Artroscopio
Arthroscopie
Artroscopia

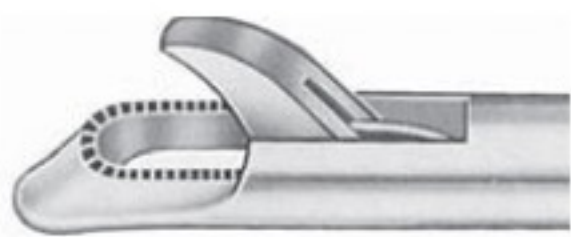
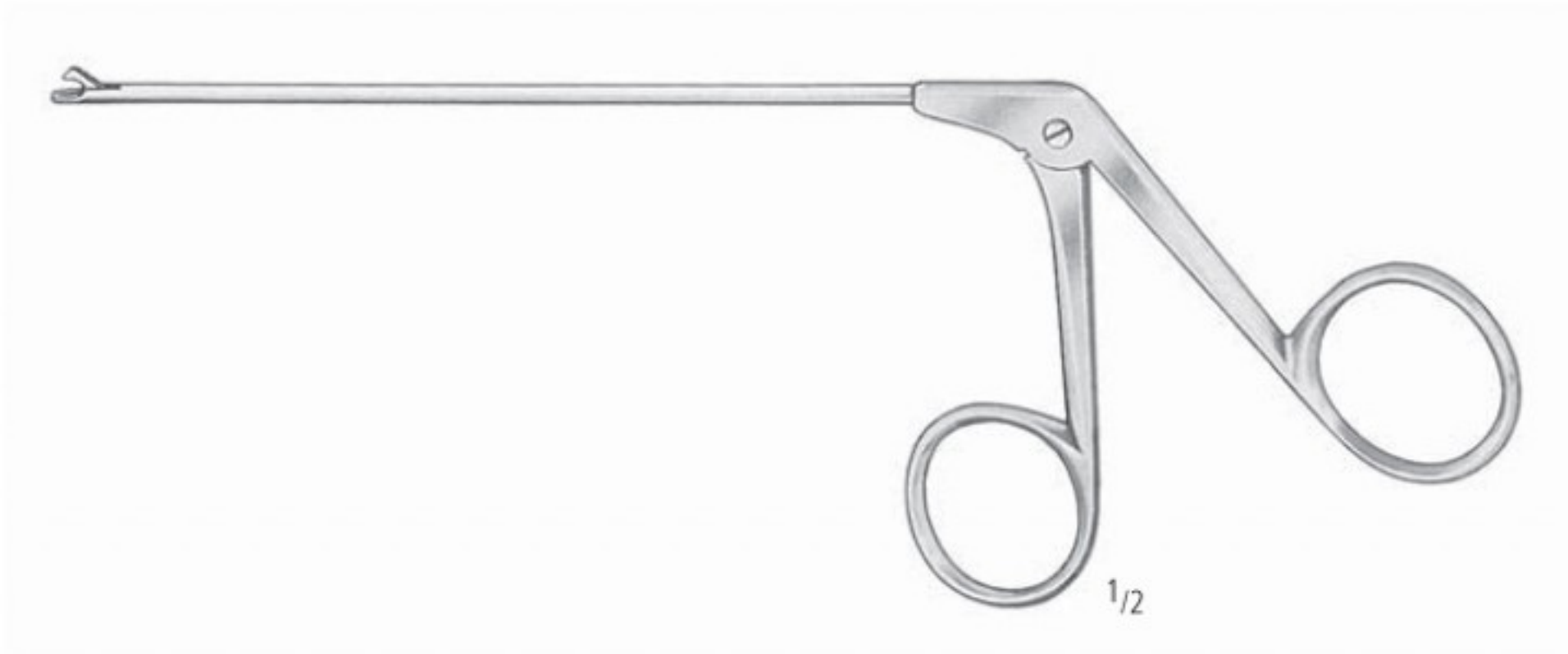

2/1

Ø 2,7 mm
Ø 3,4 mm
Ø 4,5 mm



KA 320/10
KA 321/10
KA 322/10



KA 320/11
KA 321/11
KA 322/11



KA 320/13
KA 321/13
KA 322/13



KA 320/15
KA 321/15
KA 322/15



KA 320/17
KA 321/17
KA 322/17



KA 320/19
KA 321/19
KA 322/19



KA 320/21
KA 321/21
KA 322/21



2/1

Ø 2,7 mm
Ø 3,4 mm
Ø 4,5 mm



KA 323/10
KA 324/10
KA 325/10



KA 323/11
KA 324/11
KA 325/11



KA 323/13
KA 324/13
KA 325/13



KA 323/15
KA 324/15
KA 325/15



KA 323/17
KA 324/17
KA 325/17

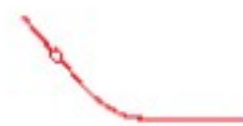

KA 323/19
KA 324/19
KA 325/19



KA 323/21
KA 324/21
KA 325/21

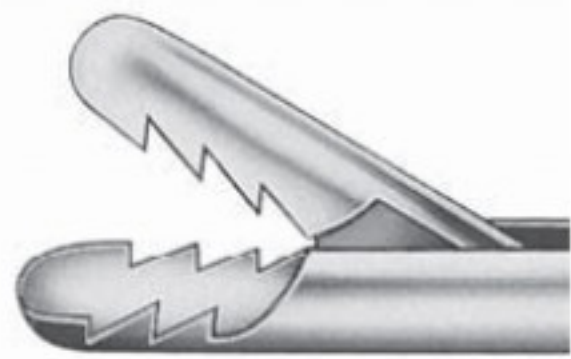

2/1

Ø 3,4 mm



KA 326/10



KA 326/11



KA 326/13



KA 326/15



KA 326/17



KA 326/19



KA 326/21

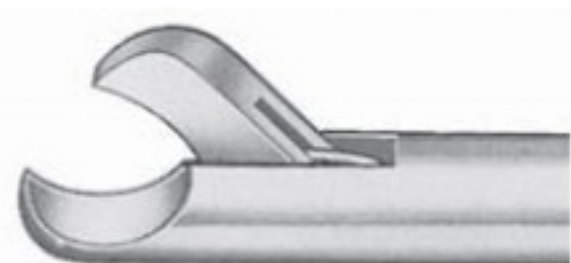

2/1

Ø 3,4 mm



KA 327/10



KA 327/11



KA 327/13



KA 327/15



KA 327/17



KA 327/19



KA 327/21

ORTHOPÄDIE ORTHOPAEDIC ORTOPEDIA ORTHOPEDIE ORTOPEDIA

Arthroskopie
Arthroscopy
Artroscopio
Arthroscopie
Artroscopia

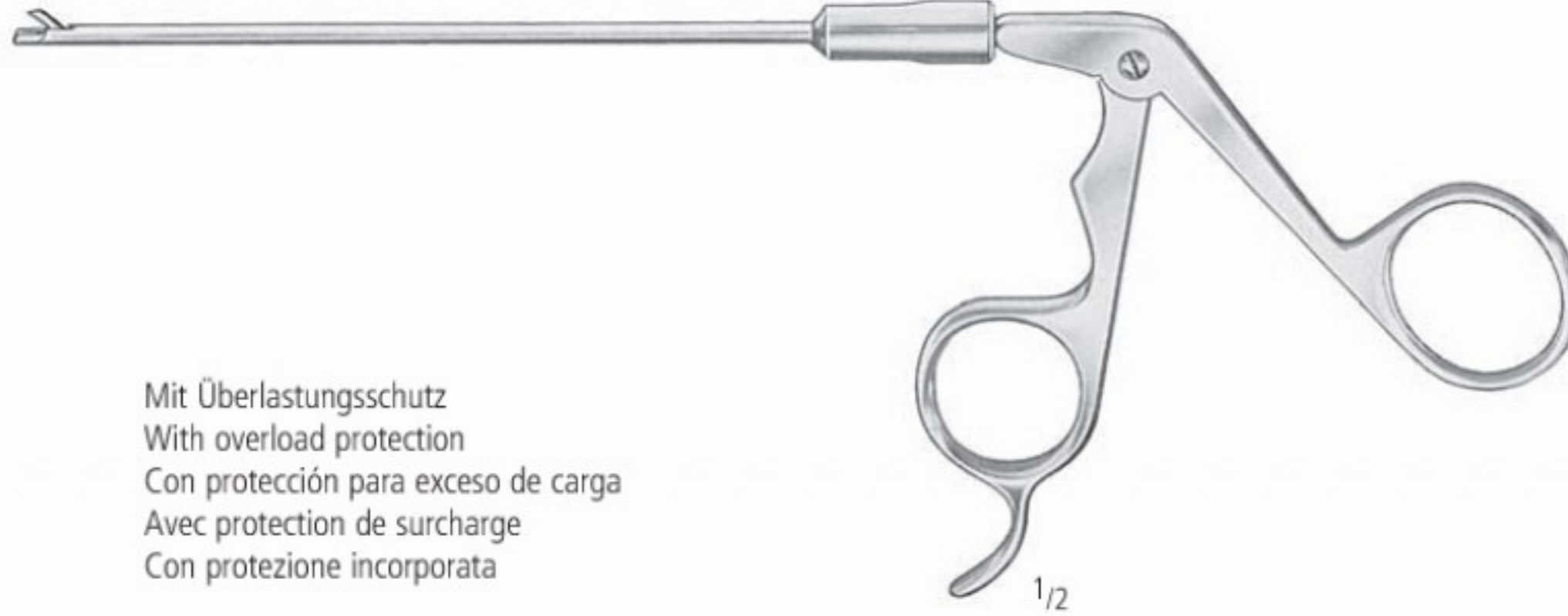

Mit Überlastungsschutz
With overload protection
Con protección para exceso de carga
Avec protection de surcharge
Con protezione incorporata

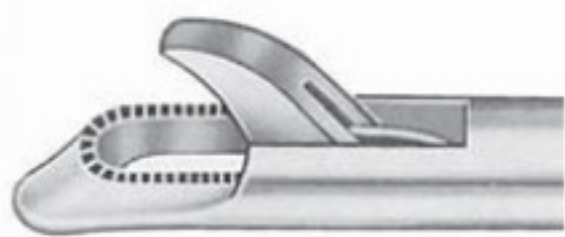

2/1

Ø 2,7 mm
Ø 3,4 mm
Ø 4,5 mm

KA 328/10
KA 329/10
KA 330/10

KA 328/11
KA 329/11
KA 330/11

KA 328/13
KA 329/13
KA 330/13

KA 328/15
KA 329/15
KA 330/15

KA 328/17
KA 329/17
KA 330/17

KA 328/19
KA 329/19
KA 330/19

KA 328/21
KA 329/21
KA 330/21



2/1

Ø 2,7 mm
Ø 3,4 mm
Ø 4,5 mm

KA 331/10
KA 332/10
KA 333/10

KA 331/11
KA 332/11
KA 333/11

KA 331/13
KA 332/13
KA 333/13

KA 331/15
KA 332/15
KA 333/15

KA 331/17
KA 332/17
KA 333/17

KA 331/19
KA 332/19
KA 333/19

KA 331/21
KA 332/21
KA 333/21

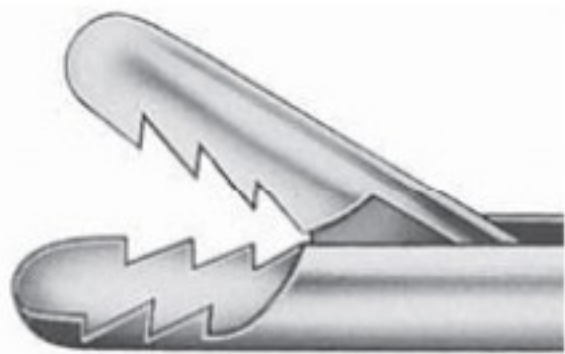

2/1

Ø 3,4 mm

KA 334/10

KA 334/11

KA 334/13

KA 334/15

KA 334/17

KA 334/19

KA 334/21

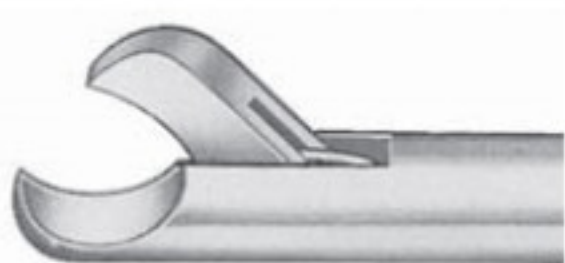

2/1

Ø 3,4 mm

KA 335/10

KA 335/11

KA 335/13

KA 335/15

KA 335/17

KA 335/19

KA 335/21

AA
AB
AC
AD
AE
AF
AK
AL
AM
AO
AP
AR
KA
KB
KC
KD
KU
KY

KA ORTHOPÄDIE ORTHOPAEDIC ORTOPEDIA ORTHOPEDIE ORTOPEDIA

Arthroskopie
Arthroscopy
Artroscopio
Arthroscopie
Artroscopia

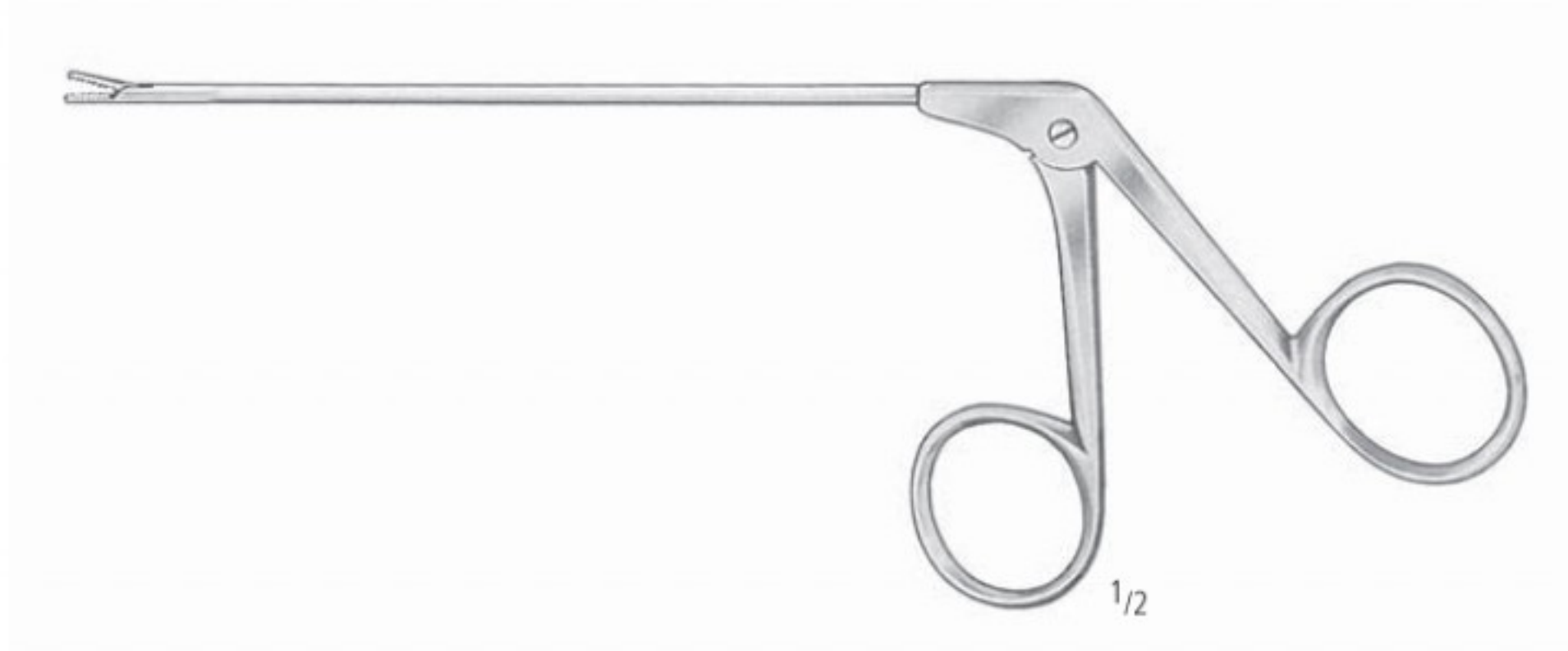

2/1

Ø 3,4 mm

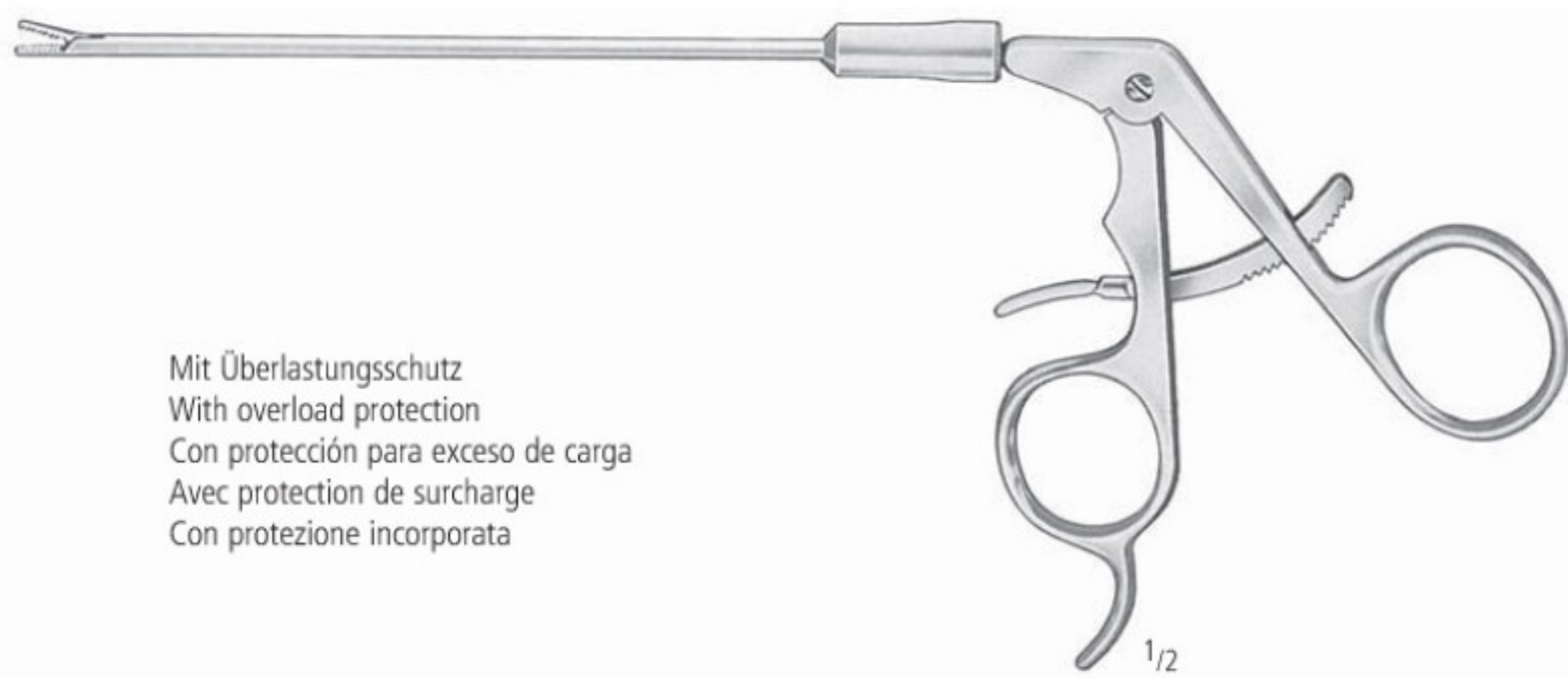

Mit Überlastungsschutz
With overload protection
Con protección para exceso de carga
Avec protection de surcharge
Con protezione incorporata



2/1

Ø 3,4 mm



Arthroscopie
Arthroscopy
Artroscopio
Arthroscopie
Artroscopia

AA
AB
AC
AD
AE
AF
AK
AL
AM
AO
AP
AR
KA
KB
KC
KD
KU
KY



2/1

Ø 2,0 mm



KA 345/10



2/1

Ø 2,0 mm



KA 345/20



2/1

Ø 2,0 mm



KA 345/30



2/1

Ø 2,0 mm



KA 345/40

Maßtabelle
 Scale
 Tabla de medida
 Tableau de la mesure
 Scala



2,0 mm



3,0 mm



4,0 mm



5,0 mm



6,0 mm



8,0 mm



10,0 mm



12,0 mm



14,0 mm



16,0 mm



18,0 mm

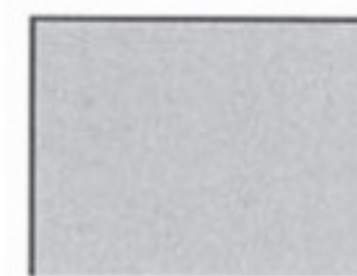

20,0 mm

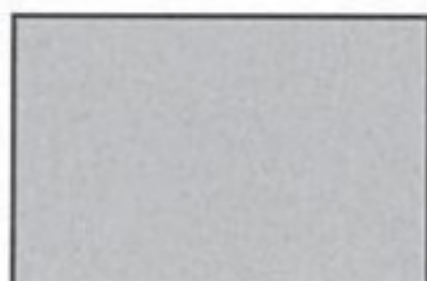

25,0 mm



30,0 mm

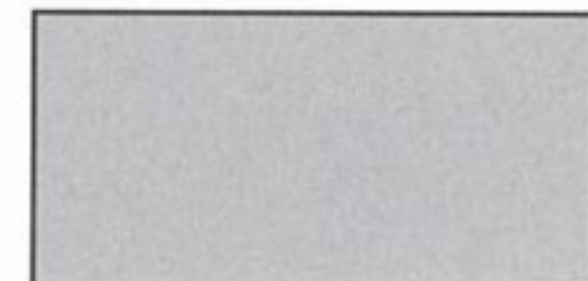

35,0 mm

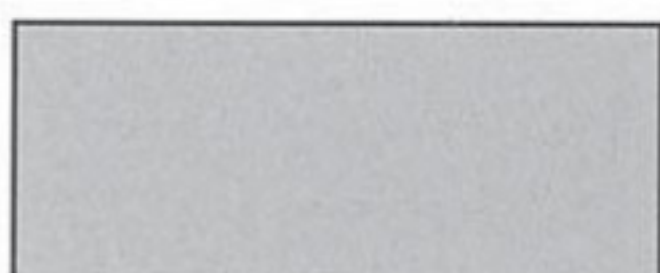

40,0 mm

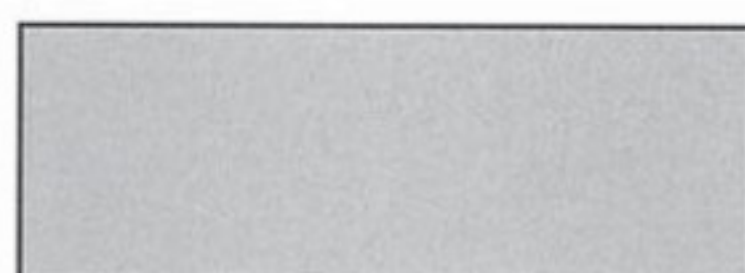

45,0 mm

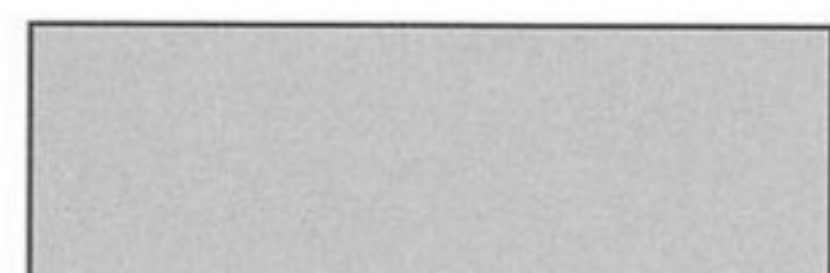

50,0 mm

ORTHOPÄDIE ORTHOPAEDIC ORTOPEDIA ORTHOPEDIE ORTOPEDIA

Meißel und Osteotome
 Chisels, Gouges and Osteotomes
 Cinceles y Gubias
 Ciseaux-Burins et Ostéotomes
 Scalpelli, Osteotomi, Sgorbie



mm 13,5 cm/5¹/₄"

8	KA 400/08
10	KA 400/10
12	KA 400/12
14	KA 400/14
16	KA 400/16



mm 13,5 cm/5¹/₄"

8	KA 401/08
10	KA 401/10
12	KA 401/12
14	KA 401/14
16	KA 401/16



mm 13,5 cm/5¹/₄"

8	KA 402/08
10	KA 402/10
12	KA 402/12
14	KA 402/14
16	KA 402/16



mm **HOKE** 14,0 cm/5¹/₂"

3	KA 404/03
5	KA 404/05
6	KA 404/06
8	KA 404/08
9	KA 404/09



mm **LUCAS** 16,0 cm/6¹/₄"

4	KA 406/04
6	KA 406/06



mm **LUCAS** 16,0 cm/6¹/₄"

3	KA 407/03
5	KA 407/05

AA
AB
AC
AD
AE
AF
AK
AL
AM
AO
AP
AR
KA
KB
KC
KD
KU
KY

KA ORTHOPÄDIE ORTHOPAEDIC ORTOPEDIA ORTHOPEDIE ORTOPEDIA

Meißel und Osteotome
 Chisels, Gouges and Osteotomes
 Cinceles y Gubias
 Ciseaux-Burins et Ostéotomes
 Scalpelli, Osteotomi, Sgorbie



	ALEXANDER
	18,0 cm/7"
mm	
4	KA 418/04
6	KA 418/06
8	KA 418/08
10	KA 418/10
12	KA 418/12
14	KA 418/14



	ALEXANDER
	18,0 cm/7"
mm	
4	KA 419/04
6	KA 419/06
8	KA 419/08
10	KA 419/10
12	KA 419/12
14	KA 419/14



13,5 cm/5 ¹ / ₄ "	17,0 cm/6 ³ / ₄ "
KA 433/02	KA 437/02
KA 433/03	KA 437/03
KA 433/04	KA 437/04
KA 433/05	KA 437/05
KA 433/06	KA 437/06
KA 433/07	KA 437/07
KA 433/08	KA 437/08



PARTSCH

mm	13,5 cm/5 ¹ / ₄ "	17,0 cm/6 ³ / ₄ "
2	KA 443/02	KA 447/02
3	KA 443/03	KA 447/03
4	KA 443/04	KA 447/04
5	KA 443/05	KA 447/05
6	KA 443/06	KA 447/06
7	KA 443/07	KA 447/07
8	KA 443/08	KA 447/08

Meißel und Osteotome
 Chisels, Gouges and Osteotomes
 Cinceles y Gubias
 Ciseaux-Burins et Ostéotomes
 Scalpelli, Osteotomi, Sgorbie



SMITH-PETERSEN
 20,0 cm/8"

mm	KA 450/06	KA 451/06	KA 452/09	KA 453/09
6	KA 450/06	KA 451/06		KA 453/09
9	KA 450/09	KA 451/09	KA 452/09	
13	KA 450/13	KA 451/13		KA 453/14
14			KA 452/14	
16	KA 450/16	KA 451/16		KA 453/19
19	KA 450/19	KA 451/19	KA 452/19	KA 453/25
25	KA 450/25	KA 451/25	KA 452/25	
32	KA 450/32	KA 451/32		

AA
AB
AC
AD
AE
AF
AK
AL
AM
AO
AP
AR
KA
KB
KC
KD
KU
KY

Meißel und Osteotome
 Chisels, Gouges and Osteotomes
 Cinceles y Gubias
 Ciseaux-Burins et Ostéotomes
 Scalpelli, Osteotomi, Sgorbie

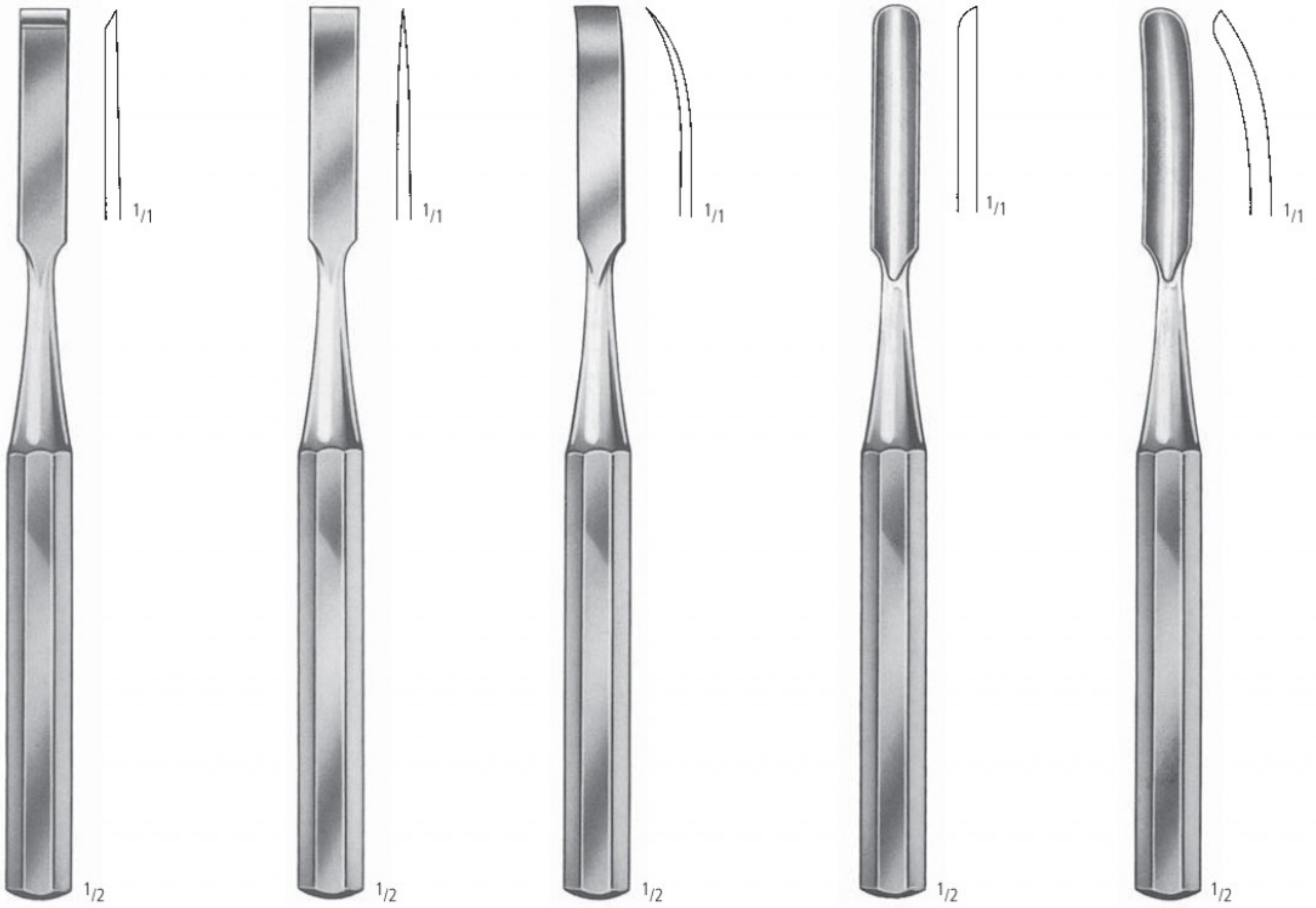

HIBBS
 24,0 cm/9 1/2"

mm	KA 455/06	KA 456/06	KA 457/06	KA 458/06	KA 459/06
6	KA 455/13	KA 456/13	KA 457/13	KA 458/13	KA 459/13
13	KA 455/19	KA 456/19	KA 457/19	KA 458/19	KA 459/19
19	KA 455/25	KA 456/25	KA 457/25	KA 458/25	KA 459/25
25	KA 455/32	KA 456/32	KA 457/32	KA 458/32	KA 459/32
32					

Meißel und Osteotome
 Chisels, Gouges and Osteotomes
 Cinceles y Gubias
 Ciseaux-Burins et Ostéotomes
 Scalpelli, Osteotomi, Sgorbie



STILLE
 20,0 cm/8"

mm
 8
 10
 15
 20
 25

KA 460/08
 KA 460/10
 KA 460/15
 KA 460/20
 KA 460/25

KA 461/08
 KA 461/10
 KA 461/15
 KA 461/20
 KA 461/25

KA 462/08
 KA 462/10
 KA 462/15
 KA 462/20
 KA 462/25

KA 463/08
 KA 463/10
 KA 463/15
 KA 463/20
 KA 463/25

AA
 AB
 AC
 AD
 AE
 AF
 AG
 AH
 AI
 AJ
 AK
 AL
 AM
 AN
 AO
 AP
 AQ
 AR
 AS
 AT
 AU
 AV
 AW
 AX
 AY
 AZ

KA

KB
 KC
 KD
 KE
 KF
 KG
 KH
 KI
 KJ
 KK
 KL
 KM
 KN
 KO
 KP
 KQ
 KR
 KS
 KT
 KU
 KV
 KW
 KY

Meißel und Osteotome
 Chisels, Gouges and Osteotomes
 Cinceles y Gubias
 Ciseaux-Burins et Ostéotomes
 Scalpelli, Osteotomi, Sgorbie



MINI-LEXER
 18,0 cm/7"



MINI-LEXER
 18,0 cm/7"



LEXER
 22,0 cm/8³/₄"



LEXER
 22,0 cm/8³/₄"

mm
 4
 6
 7
 8
 10
 12
 15
 20
 25
 30

KA 470/04
 KA 470/06
 KA 470/08
 KA 470/10
 KA 470/12
 KA 470/15
 KA 470/20

KA 471/04
 KA 471/06
 KA 471/08
 KA 471/10
 KA 471/12
 KA 471/15
 KA 471/20

KA 472/07
 KA 472/10
 KA 472/15
 KA 472/20
 KA 472/25
 KA 472/30

KA 473/07
 KA 473/10
 KA 473/15
 KA 473/20
 KA 473/25
 KA 473/30

Ferrozellgriff
 Hartpress-Handle
 Mango en "Ferrozell"
 Manche en "Ferrozell"
 Manico in "Ferrozell"

ORTHOPÄDIE ORTHOPAEDIC ORTOPEDIA ORTHOPEDIE ORTOPEDIA

Meißel und Osteotome
 Chisels, Gouges and Osteotomes
 Cinceles y Gubias
 Ciseaux-Burins et Ostéotomes
 Scalpelli, Osteotomi, Sgorbie



LEXER
 27,5 cm/10³/₄"

- mm
- 5
- 10 KA 474/10
- 15 KA 474/15



LEXER
 27,5 cm/10³/₄"

- KA 475/10
- KA 475/15



LEXER
 25,0 cm/10"

- KA 476/05
- KA 476/10
- KA 476/15



LEXER
 25,0 cm/10"

- KA 477/05
- KA 477/10
- KA 477/15

Ferrozellgriff
 Hartpress-Handle
 Mango en "Ferrozell"
 Manche en "Ferrozell"
 Manico in "Ferrozell"

AA
 AB
 AC
 AD
 AE
 AF
 AK
 AL
 AM
 AO
 AP
 AR
 KA
 KB
 KC
 KD
 KU
 KY

Meißel und Osteotome
 Chisels, Gouges and Osteotomes
 Cinceles y Gubias
 Ciseaux-Burins et Ostéotomes
 Scalpelli, Osteotomi, Sgorbie



COBB
 28,0 cm/11"

KA 478/01



COBB
 28,0 cm/11"

KA 478/02



COBB
 28,0 cm/11"

KA 478/03



COBB
 28,0 cm/11"

KA 478/04

ORTHOPÄDIE ORTHOPAEDIC ORTOPEDIA ORTHOPEDIE ORTOPEDIA

Meißel und Osteotome
 Chisels, Gouges and Osteotomes
 Cinceles y Gubias
 Ciseaux-Burins et Ostéotomes
 Scalpelli, Osteotomi, Sgorbie

AA
AB
AC
AD
AE
AF
AK
AL
AM
AO
AP
AR
KA
KB
KC
KD
KU
KY

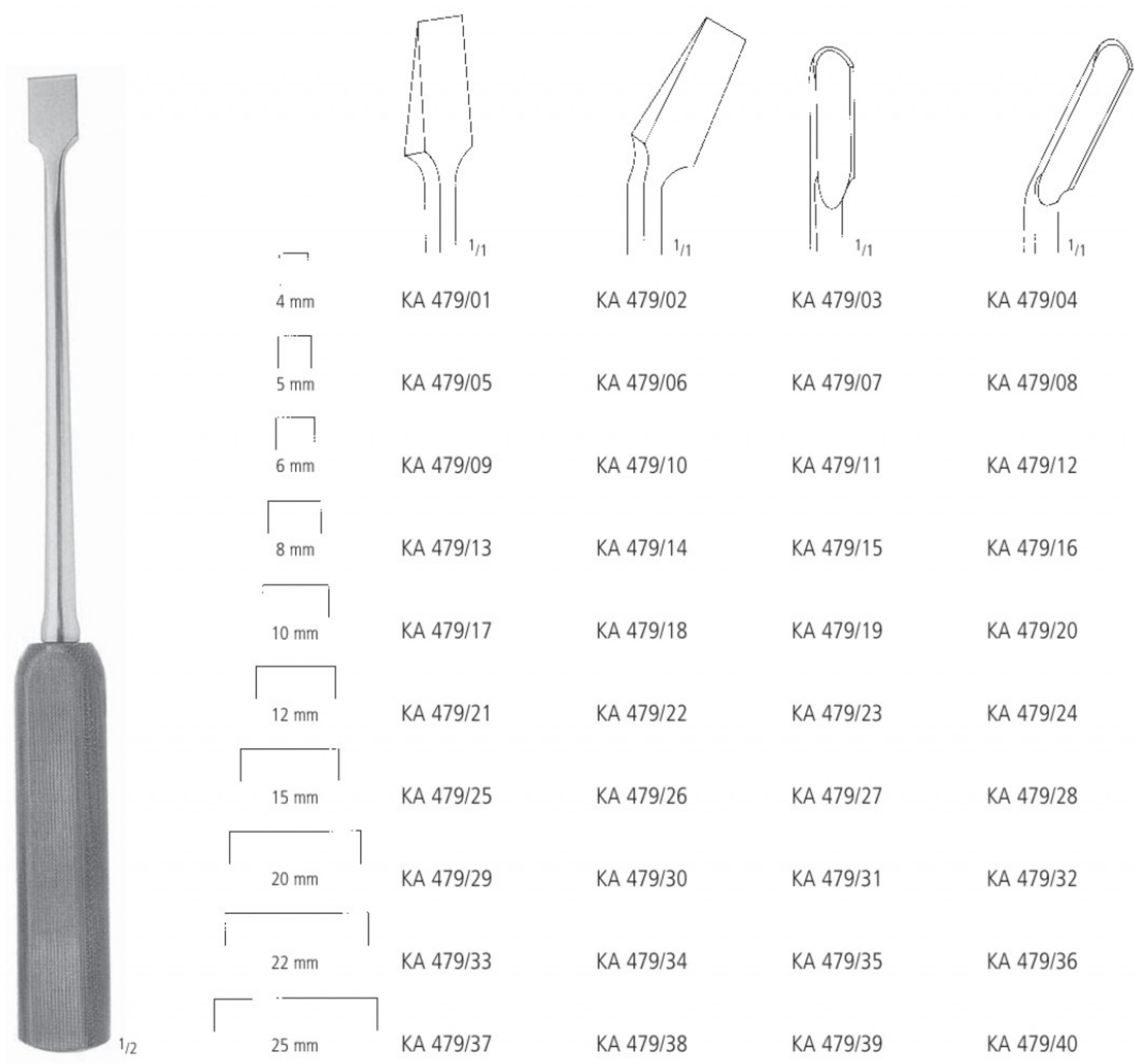

DAHMEN
 30,0 cm/12"

Ferrozellgriff
 Hartpress-Handle
 Mango en "Ferrozell"
 Manche en "Ferrozell"
 Manico in "Ferrozell"

Meißel und Osteotome
 Chisels, Gouges and Osteotomes
 Cinceles y Gubias
 Ciseaux-Burins et Ostéotomes
 Scalpelli, Osteotomi, Sgorbie



MINI-LAMBOTTE
 12,5 cm/5"

MINI-LAMBOTTE
 17,0 cm/6³/₄"

LAMBOTTE
 24,0 cm/9¹/₂"

LAMBOTTE
 23,0 cm/9"

mm	
3	KA 480/03
4	KA 480/04
6	KA 480/06
8	KA 480/08
10	KA 480/10
12	KA 480/12
15	KA 480/15

KA 481/03
KA 481/04
KA 481/06
KA 481/08
KA 481/10
KA 481/12
KA 481/15

mm	
15	KA 482/15
20	KA 482/20
25	KA 482/25
30	KA 482/30
38	KA 482/38
44	KA 482/44
50	KA 482/50

KA 483/15
KA 483/20
KA 483/25
KA 483/30
KA 483/38
KA 483/44
KA 483/50

Hämmer
Mallets
Martillos
Marteaux
Martelli



300 g
(10³/₄ oz.)

BERGMANN
KA 517/30
24,0 cm/9¹/₂"



300 g
(10³/₄ oz.)

BERGMANN
KA 518/30
23,0 cm/9"



550 g
(19¹/₂ oz.)

OMBREDANNE
KA 519/55
24,0 cm/9¹/₂"

AA
AB
AC
AD
AE
AF
AK
AL
AM
AO
AP
AR
KA
KB
KC
KD
KU
KY

Hämmer
Mallets
Martillos
Marteaux
Martelli

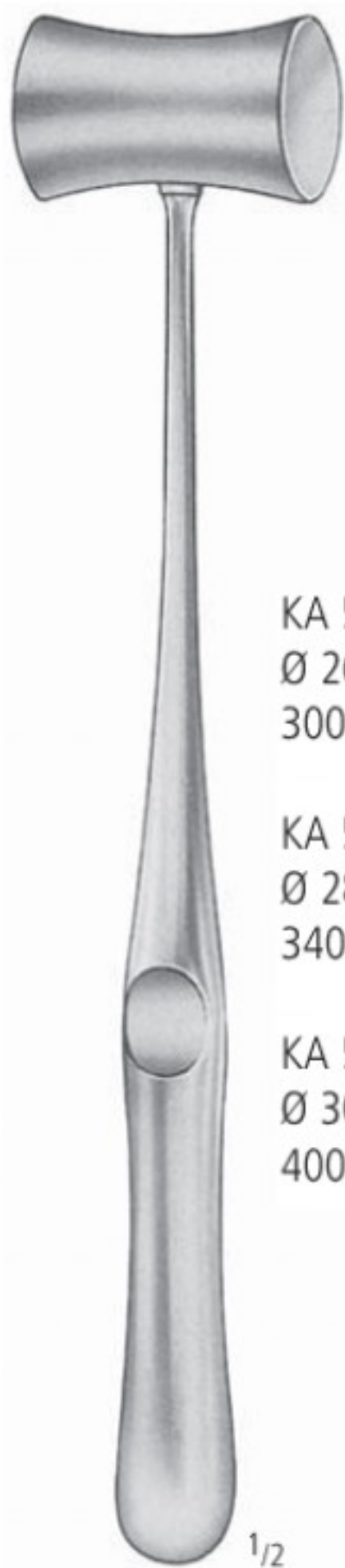

KA 520/30
Ø 26 mm
300 g (10³/₄ oz.)

KA 520/34
Ø 28 mm
340 g (12 oz.)

KA 520/40
Ø 30 mm
400 g (14¹/₄ oz.)

WILLIGER
24,0 cm/9¹/₂"



KA 530/12
Ø 25 mm
120 g (4¹/₄ oz.)

KA 530/18
Ø 30 mm
180 g (6¹/₂ oz.)

KA 530/26
Ø 35 mm
260 g (9¹/₄ oz.)

DOYEN
20,0 cm/8¹/₄"



COTTLE
KA 531/24
19,0 cm/7¹/₂"
240 g (8¹/₂ oz.)

Hämmer
Mallets
Martillos
Marteaux
Martelli



Ø 30 mm
220 g
(7³/₄ oz.)

1/2

COLLIN
KA 532/22
20,0 cm/8"



Ø 27 mm
140 g
(5 oz.)

1/2

HAJEK
KA 533/14
22,0 cm/8³/₄"

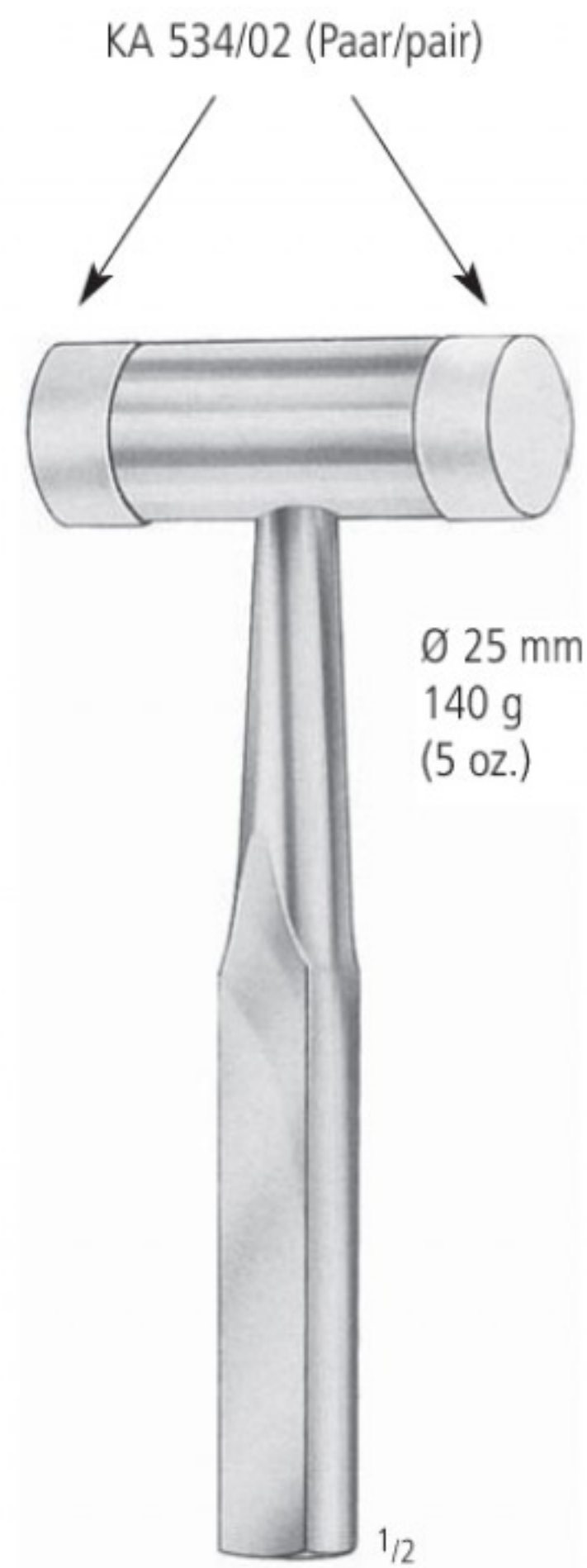

Ø 25 mm
140 g
(5 oz.)

1/2

KA 534/14
18,0 cm/7"

AA

AB

AC

AD

AE

AF

AK

AL

AM

AO

AP

AR

KA

KB

KC

KD

KU

KY

Hämmer
Mallets
Martillos
Marteaux
Martelli

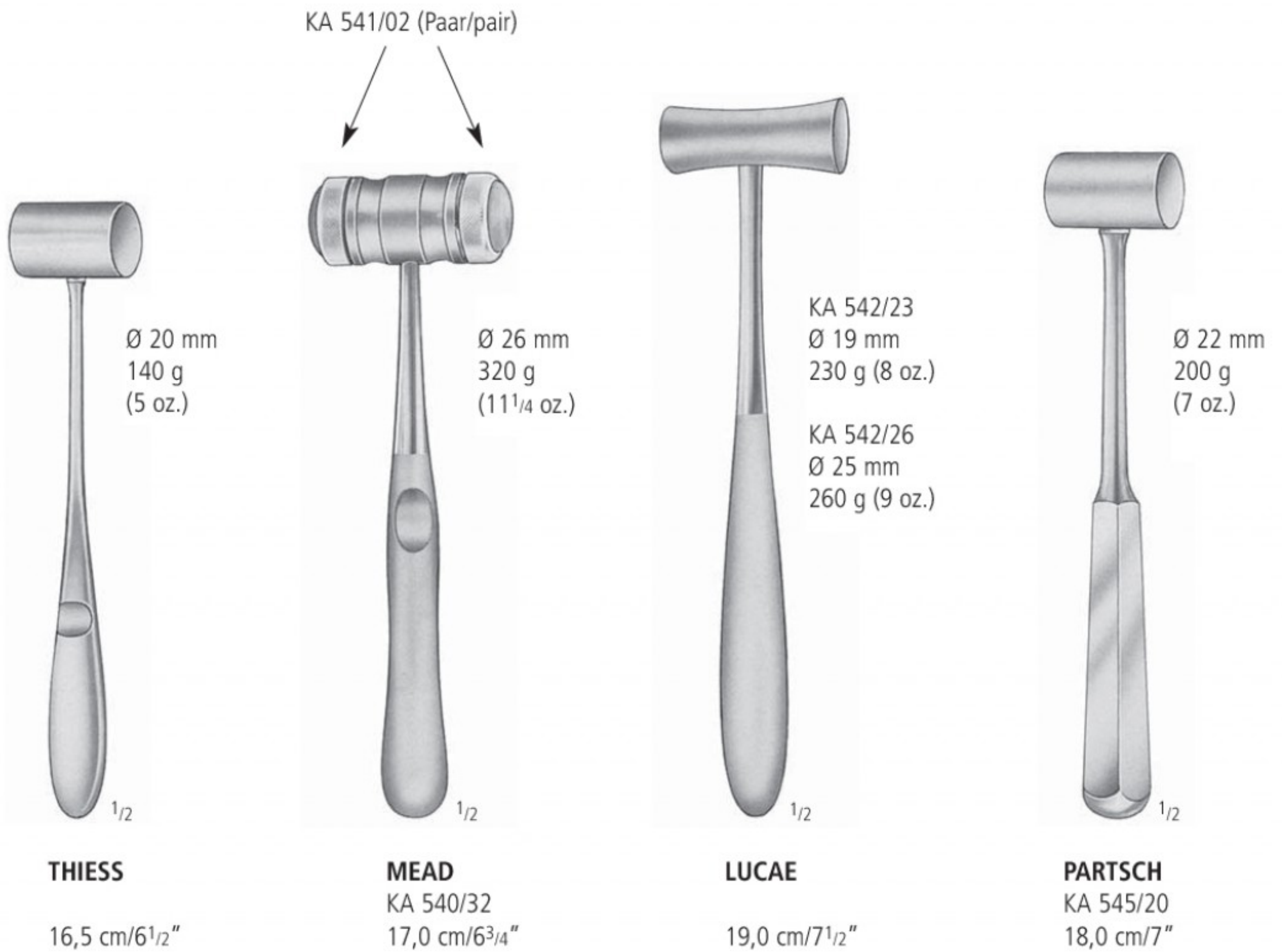

KA 535/16

KA 536/16

bleigefüllt
lead filled
relleno de plomo
garni de plomb
guarnito di piombo

Messing, massiv
brass, solid
latón, macizo
laiton, solide
ottone, solido

Hämmer
Mallets
Martillos
Marteaux
Martelli



450 g
(16 oz.)

1/2

KA 546/45
26,5 cm/10 1/2"



900 g
(32 oz.)

1/2

KA 546/90
26,5 cm/10 1/2"



Ø 42 mm

Ø 30 mm
530 g
(19 oz.)

1/2

KA 550/53
24,0 cm/9 1/2"

AA

AB

AC

AD

AE

AF

AK

AL

AM

AO

AP

AR

KA

KB

KC

KD

KU

KY

Hämmer
Mallets
Martillos
Marteaux
Martelli



Ø 80 x 60 mm
400 g
(14¹/₄ oz.)

STEINBACH
KA 551/40
24,0 cm/9¹/₂"

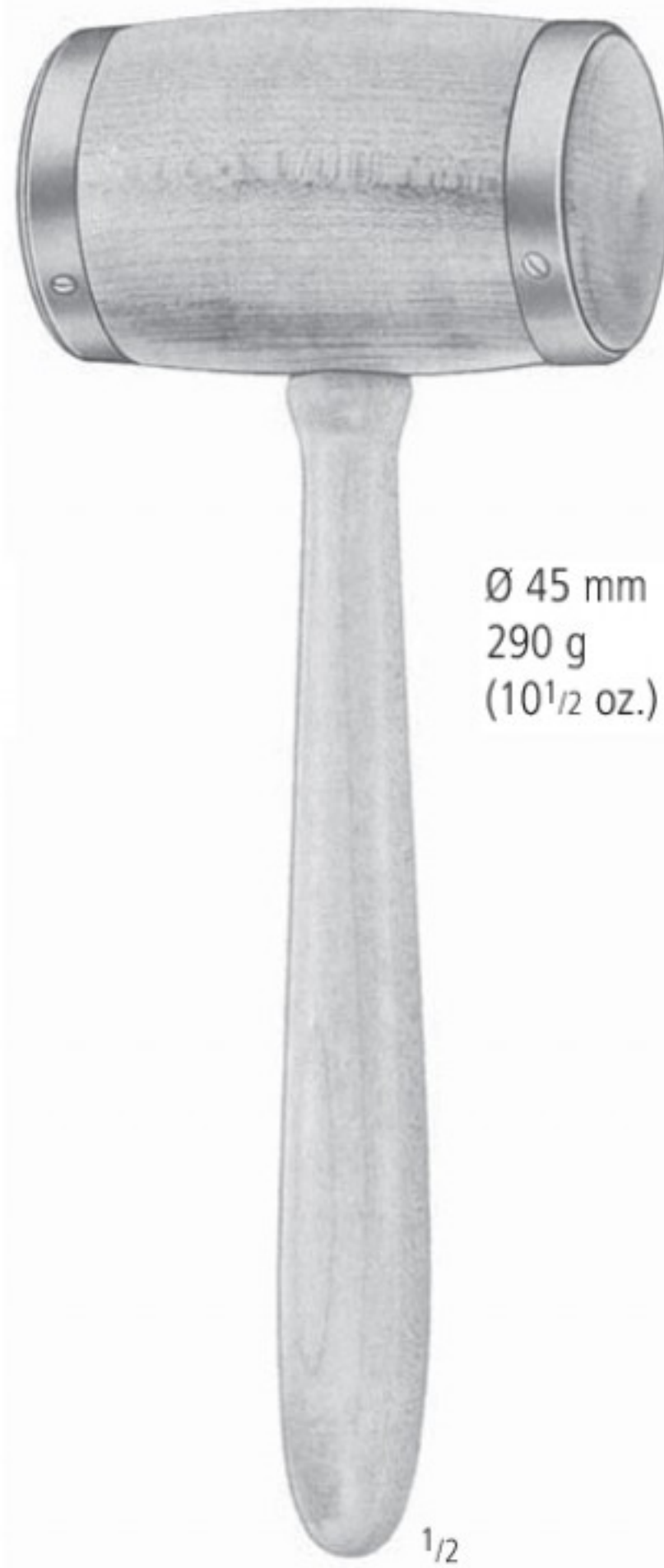

Ø 45 mm
290 g
(10¹/₂ oz.)

KA 552/29
23,0 cm/9"

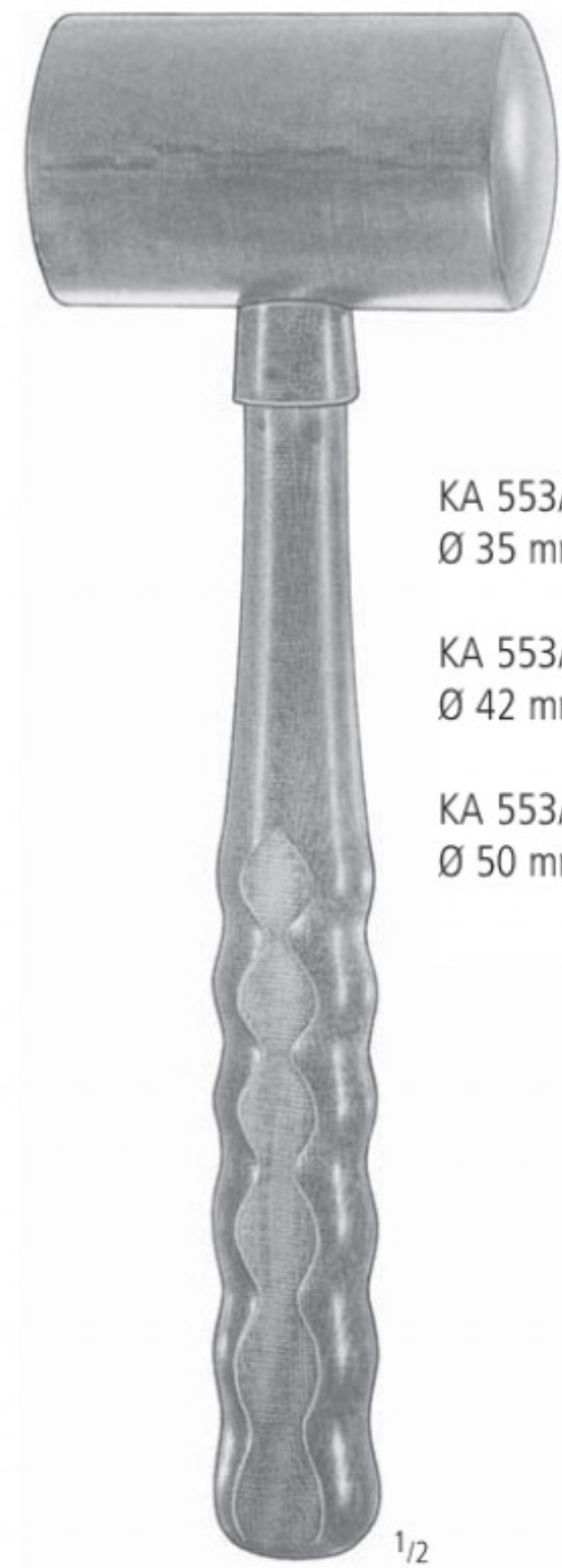

KA 553/35
Ø 35 mm

KA 553/42
Ø 42 mm

KA 553/50
Ø 50 mm

25,0 cm/10"

Hämmer
Mallets
Martillos
Marteaux
Martelli

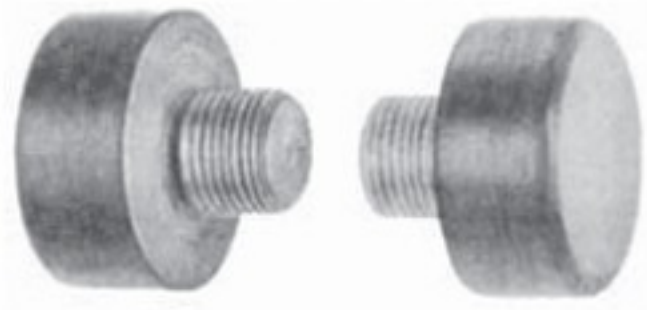

KA 554/90



KA 554/37
370 g (12³/₄ oz.)
Ferozell



KA 555/13
125 g (4¹/₄ oz.)
Ferozell

AA
AB
AC
AD
AE
AF
AK
AL
AM
AO
AP
AR
KA
KB
KC
KD
KU
KY

Scharfe Löffel
 Bone Currettes
 Cucharillas cortantes
 Curettes tranchantes
 Curette taglienti



VOLKMANN
 17,0 cm/6³/₄"



Fig. 0000
 KA 600/00



Fig. 000
 KA 601/00



Fig. 00
 KA 602/00



Fig. 0
 KA 603/00



Fig. 1
 KA 603/01



Fig. 2
 KA 603/02



Fig. 3
 KA 603/03



Fig. 4
 KA 603/04



Fig. 5
 KA 603/05



Fig. 6
 KA 603/06

¹/₁



BRUNS
 17,0 cm/6³/₄"



Fig. 000
 KA 610/00



Fig. 00
 KA 611/00



Fig. 0
 KA 612/00



Fig. 1
 KA 612/01



Fig. 2
 KA 612/02



Fig. 3
 KA 612/03



Fig. 4
 KA 612/04



Fig. 5
 KA 612/05



Fig. 6
 KA 612/06

¹/₁

Scharfe Löffel
 Bone Currettes
 Cucharillas cortantes
 Curettes tranchantes
 Curette taglienti

AA
 AB
 AC
 AD
 AE
 AF
 AK
 AL
 AM
 AO
 AP
 AR
KA
 KB
 KC
 KD
 KU
 KY



SPRATT
 17,0 cm/6³/₄"

Fig. 000
 KA 615/00

Fig. 00
 KA 616/00

Fig. 0
 KA 617/00

Fig. 1
 KA 617/01

Fig. 2
 KA 617/02

Fig. 3
 KA 617/03

Fig. 4
 KA 617/04

Fig. 5
 KA 617/05



SCHUDE
 17,0 cm/6³/₄"

Fig. 000
 KA 620/00

Fig. 00
 KA 621/00

Fig. 0
 KA 622/00

Fig. 1
 KA 622/01

Fig. 2
 KA 622/02

Fig. 3
 KA 622/03

Fig. 4
 KA 622/04

Scharfe Löffel
 Bone Currettes
 Cucharillas cortantes
 Curettes tranchantes
 Curette taglienti



2 mm
 KA 623/02



3 mm
 KA 623/03



4 mm
 KA 623/04



5 mm
 KA 623/05



6 mm
 KA 623/06



3 mm
 KA 623/13



4 mm
 KA 623/14



5 mm
 KA 623/15



6 mm
 KA 623/16



FOX



PIFFARD



4 mm
 KA 624/01



5 mm
 KA 624/02



6 mm
 KA 624/03

Scharfe Löffel
 Bone Currettes
 Cucharillas cortantes
 Curettes tranchantes
 Curette taglienti

AA
 AB
 AC
 AD
 AE
 AF
 AK
 AL
 AM
 AO
 AP
 AR
 KA
 KB
 KC
 KD
 KU
 KY



BRUNS
 23,0 cm/9"

Fig. 000
 KA 625/00

Fig. 00
 KA 625/01

Fig. 0
 KA 625/02

Fig. 1
 KA 625/03

Fig. 2
 KA 625/04

Fig. 3
 KA 625/05

Fig. 4
 KA 625/06

Fig. 5
 KA 625/07

Fig. 6
 KA 625/08



**CLOWARD
 HIBBS SPRATT
 SPINAL FUSION**
 22,5 cm/9"

Fig. 000
 KA 626/00

Fig. 00
 KA 627/00

Fig. 0
 KA 628/00

Fig. 1
 KA 628/01

Fig. 2
 KA 628/02

Fig. 3
 KA 628/03

Fig. 4
 KA 628/04

Fig. 5
 KA 628/05

Fig. 6
 KA 628/06



**CLOWARD
 HIBBS SPRATT
 SPINAL FUSION**
 22,5 cm/9"

Fig. 000
 KA 629/00

Fig. 00
 KA 630/00

Fig. 0
 KA 631/00

Fig. 1
 KA 631/01

Fig. 2
 KA 631/02

Fig. 3
 KA 631/03

Fig. 4
 KA 631/04

Fig. 5
 KA 631/05

Fig. 6
 KA 631/06



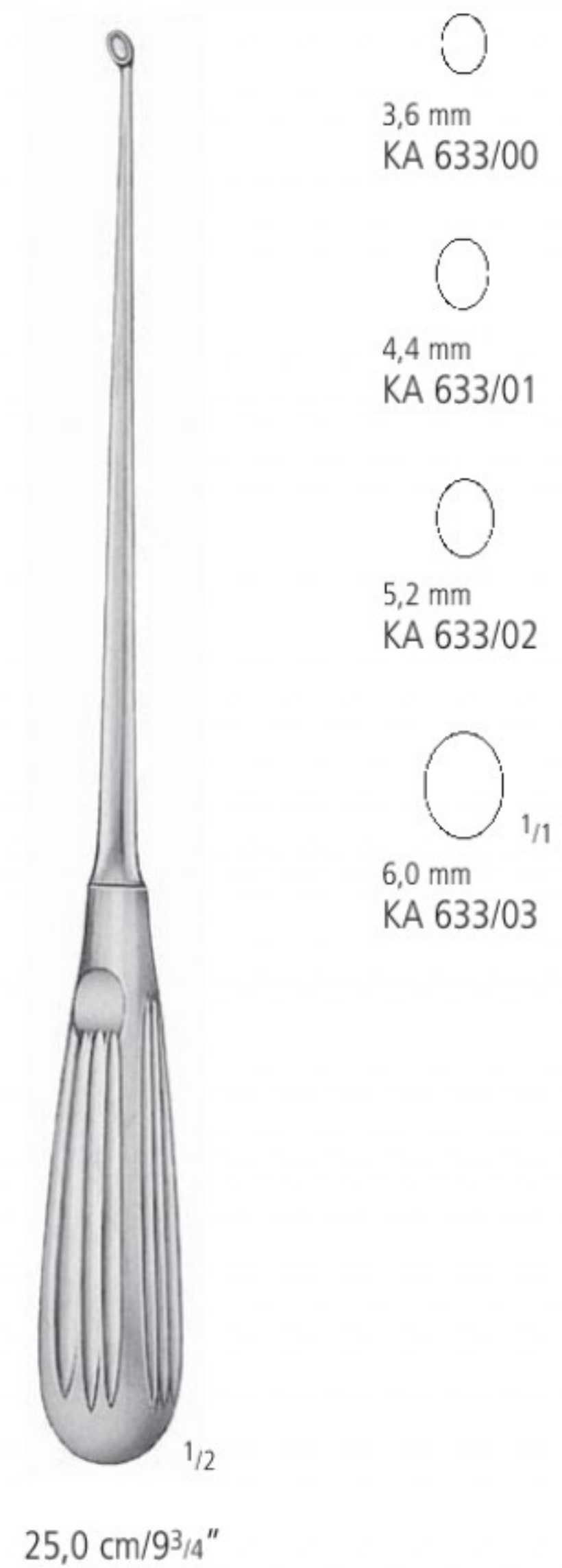
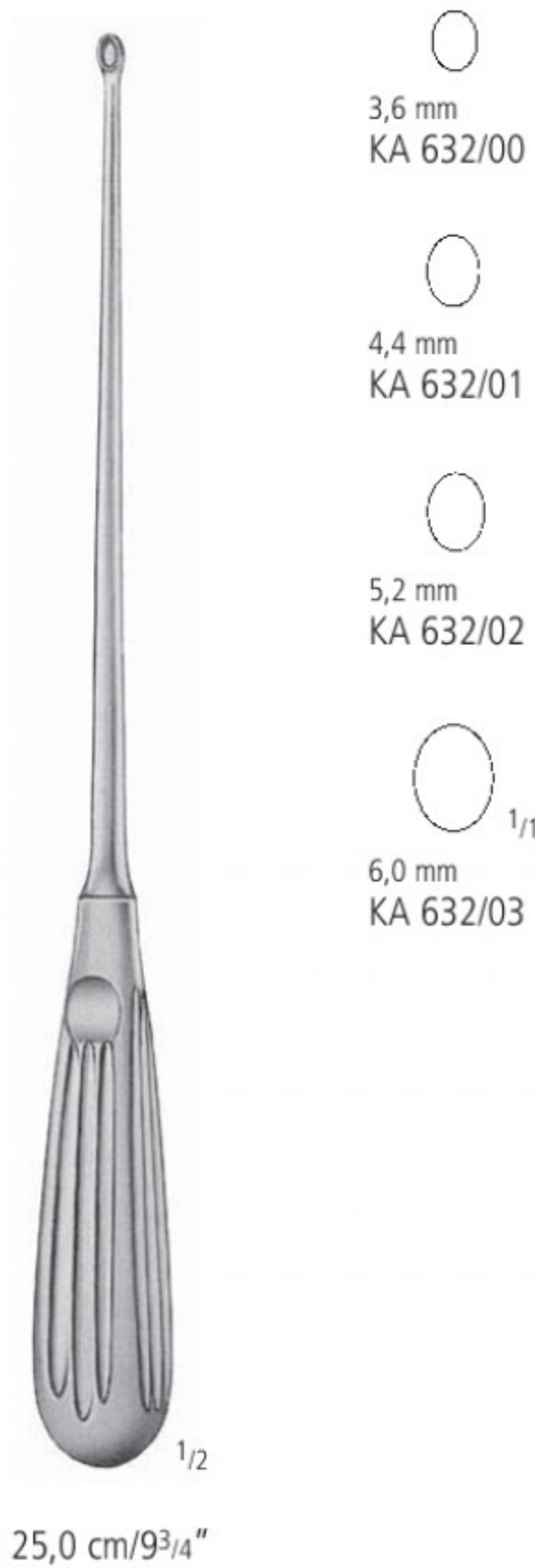



























Scharfe Löffel
 Bone Currettes
 Cucharillas cortantes
 Currettes tranchantes
 Curette taglienti



ORTHOPÄDIE ORTHOPAEDIC ORTOPEDIA ORTHOPEDIE ORTOPEDIA

Scharfe Löffel
 Bone Currettes
 Cucharillas cortantes
 Curettes tranchantes
 Curette taglienti

AA
 AB
 AC
 AD
 AE
 AF
 AK
 AL
 AM
 AO
 AP
 AR
 KA
 KB
 KC
 KD
 KU
 KY

	 3,00 x 5,00 mm KA 634/00		 3,00 x 5,00 mm KA 635/00		 4,06 x 5,08 mm KA 636/00
	 3,50 x 5,50 mm KA 634/01		 3,50 x 5,50 mm KA 635/01		 5,08 x 6,35 mm KA 636/01
	 4,50 x 6,40 mm KA 634/02		 4,50 x 6,40 mm KA 635/02		 6,10 x 7,62 mm KA 636/02
	 5,00 x 8,00 mm KA 634/03		 5,00 x 8,00 mm KA 635/03		 7,11 x 8,89 mm KA 636/03
	 6,00 x 9,00 mm KA 634/04		 6,00 x 9,00 mm KA 635/04		 8,13 x 10,16 mm KA 636/04
	 7,00 x 11,00 mm KA 634/05		 7,00 x 11,00 mm KA 635/05		 9,14 x 11,43 mm KA 636/05
	 8,50 x 12,50 mm KA 634/06		 8,50 x 12,50 mm KA 635/06		 10,16 x 12,70 mm KA 636/06
	 9,50 x 14,50 mm KA 634/07		 9,50 x 14,50 mm KA 635/07		 11,18 x 13,97 mm KA 636/07
HATFIELD 23,0 cm/9"	 10,50 x 16,80 mm KA 634/08	HATFIELD 28,0 cm/11"	 10,50 x 16,80 mm KA 635/08	COBB 28,0 cm/11"	 12,19 x 15,24 mm KA 636/08

Scharfe Löffel
Bone Currettes
Cucharillas cortantes
Currettes tranchantes
Curette taglienti

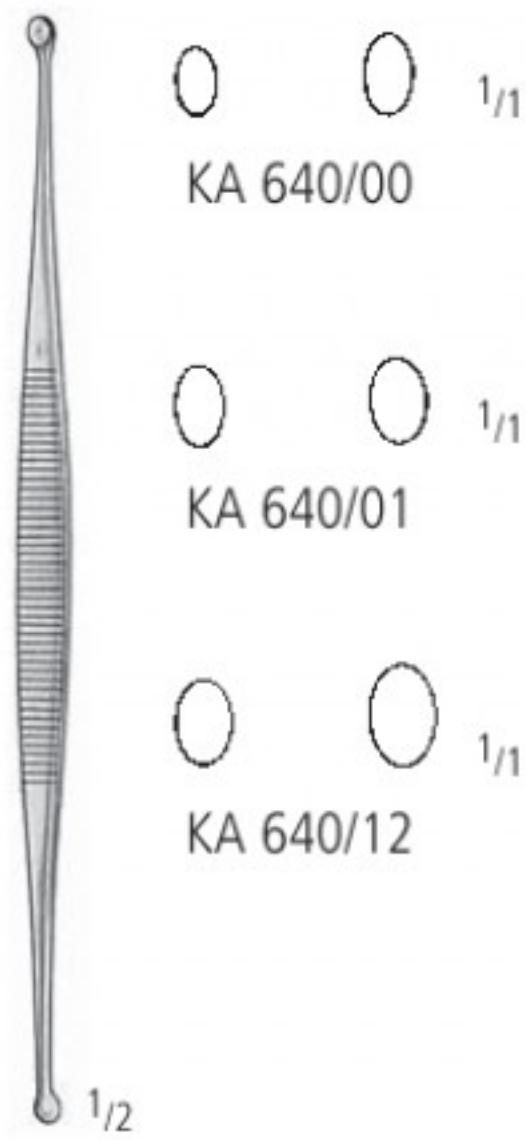

WILLIGER
13,5 cm/5¹/₄"

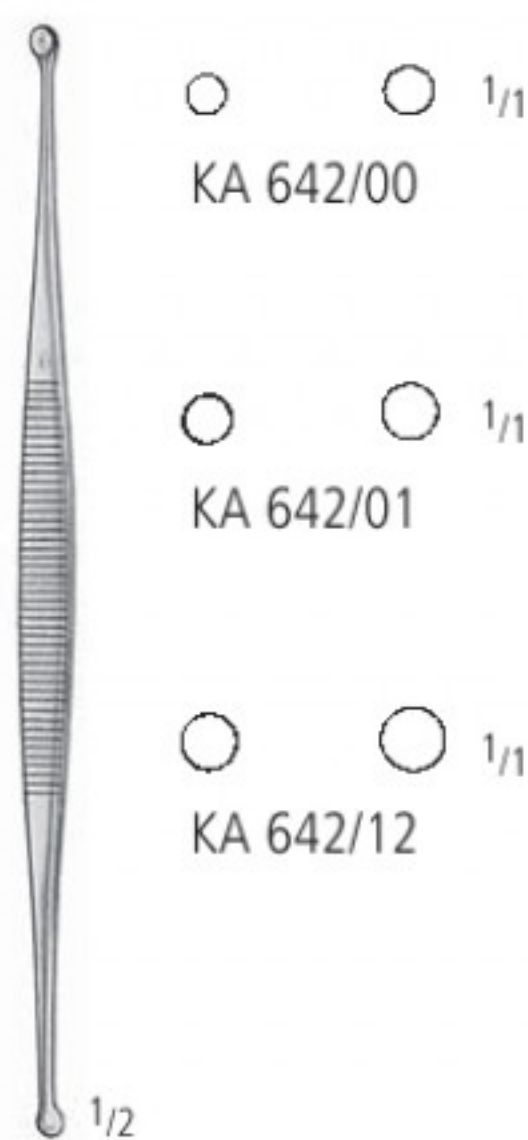

MARTINI
13,5 cm/5¹/₄"



JANSEN
KA 644/16
16,0 cm/6¹/₄"



JANSEN
KA 645/15
15,0 cm/6"



KA 648/21
21,0 cm/8¹/₄"

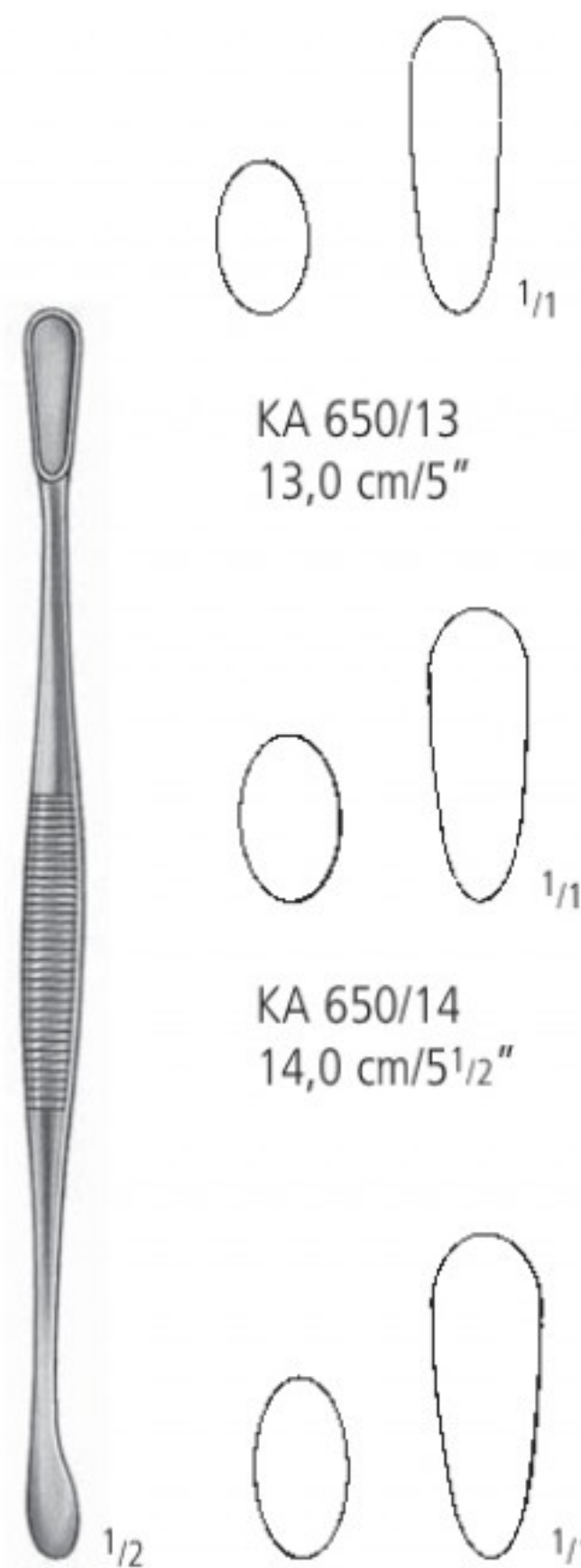

VOLKMANN KA 650/17
17,0 cm/6³/₄"

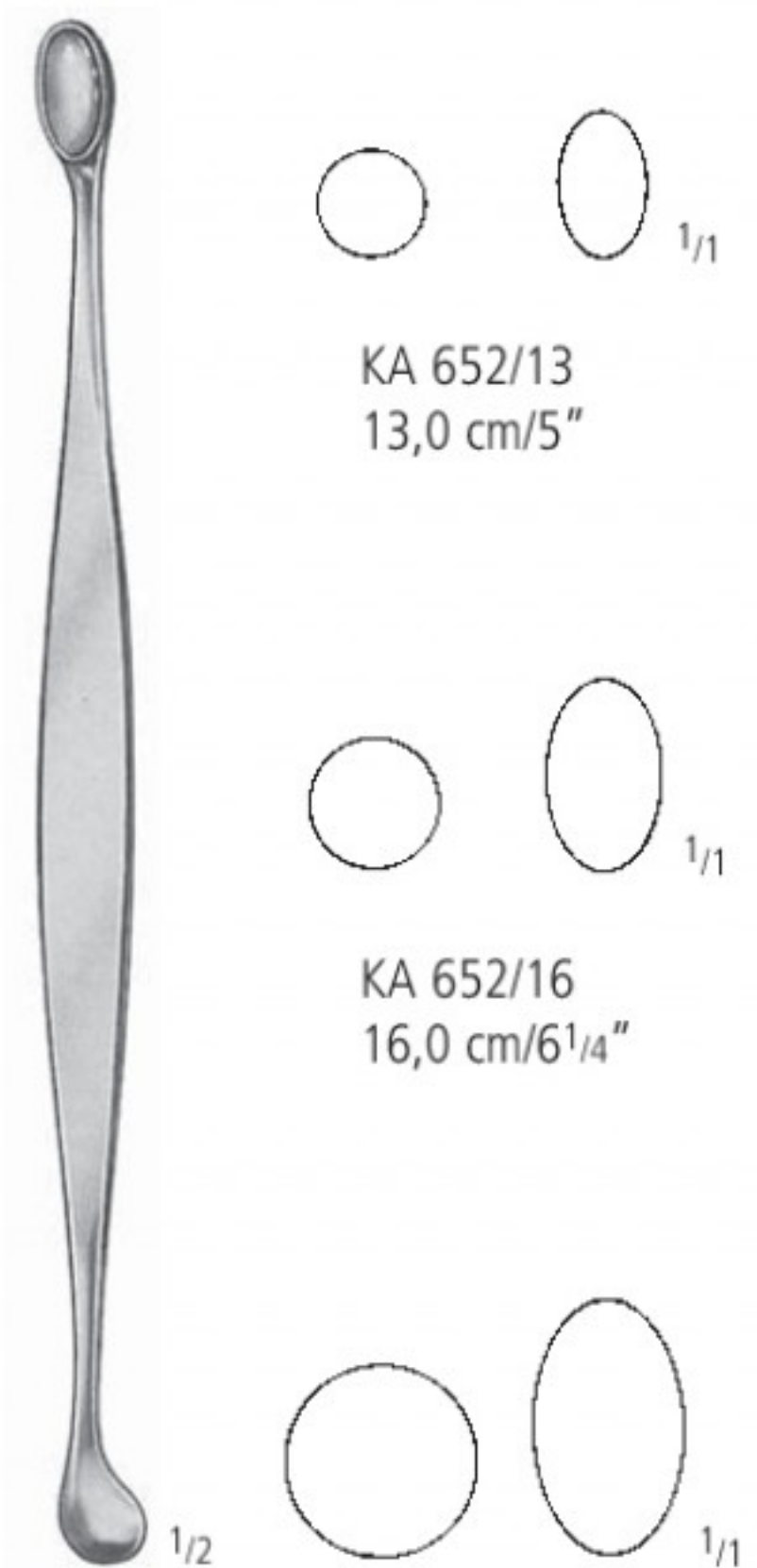

VOLKMANN KA 652/20
20,0 cm/8"

Scharfe Löffel
 Bone Currettes
 Cucharillas cortantes
 Curettes tranchantes
 Curette taglienti



HEMINGWAY
 19,0 cm/7¹/₂"

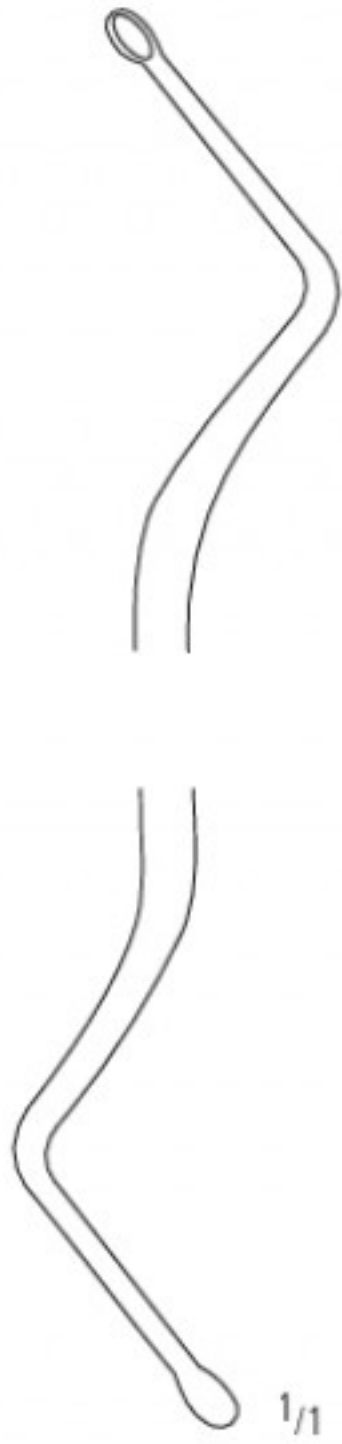

KA 654/11
 19,0 cm/7¹/₂"

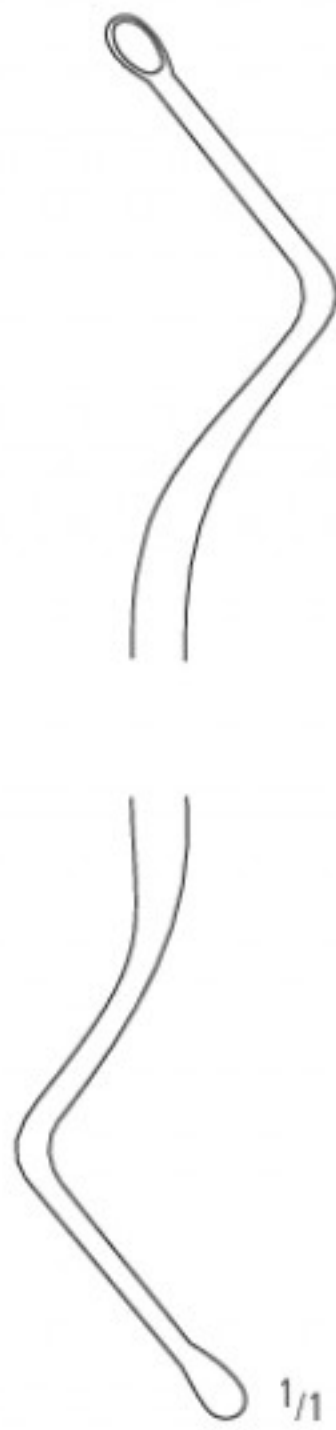

KA 654/22
 19,0 cm/7¹/₂"

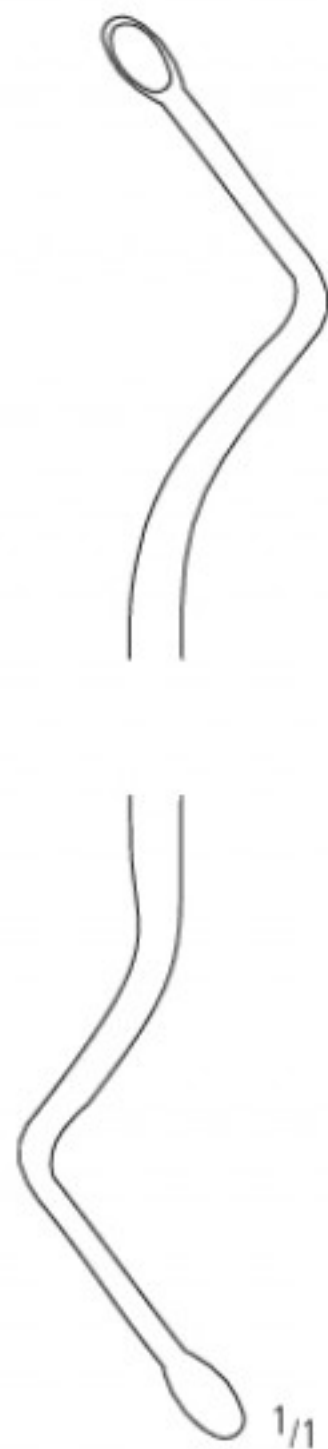

KA 654/33
 19,0 cm/7¹/₂"



LUCAS
 17,0 cm/6³/₄"

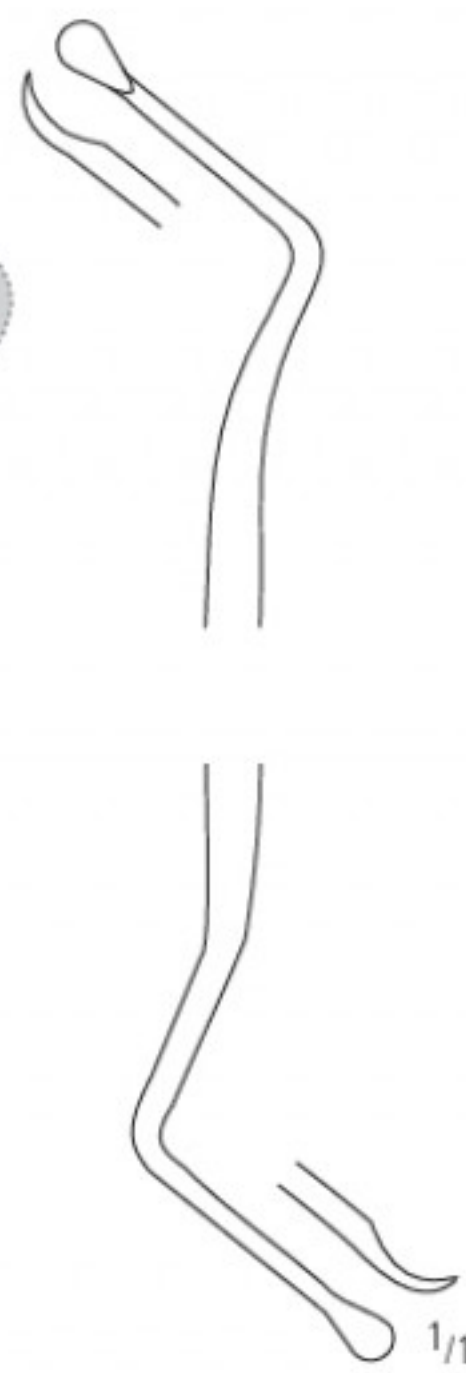

KA 654/85
 17,0 cm/6³/₄"

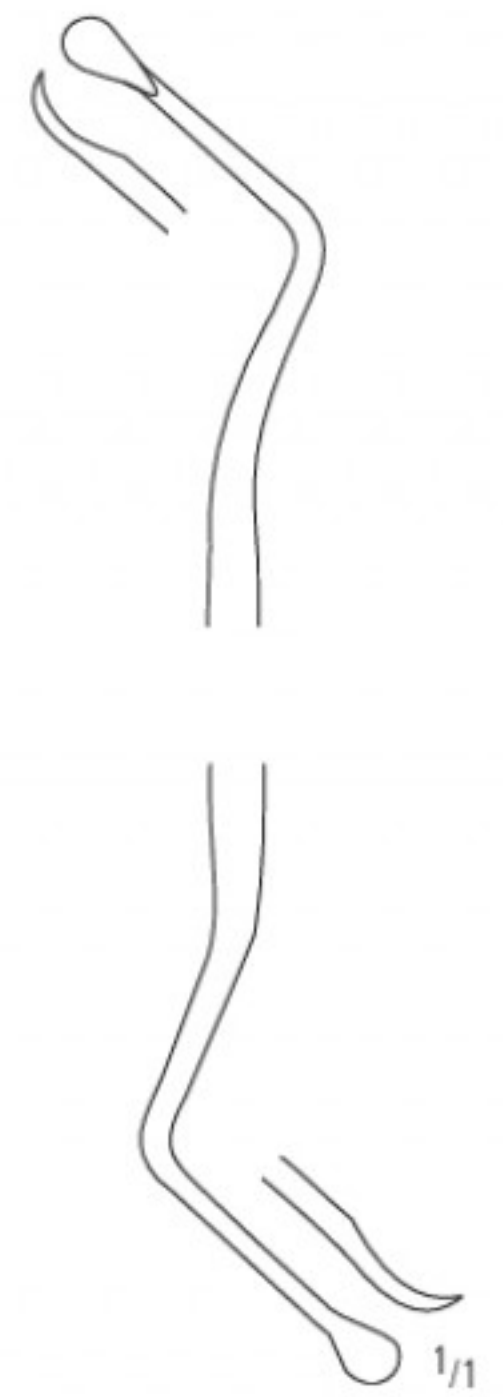

KA 654/86
 17,0 cm/6³/₄"

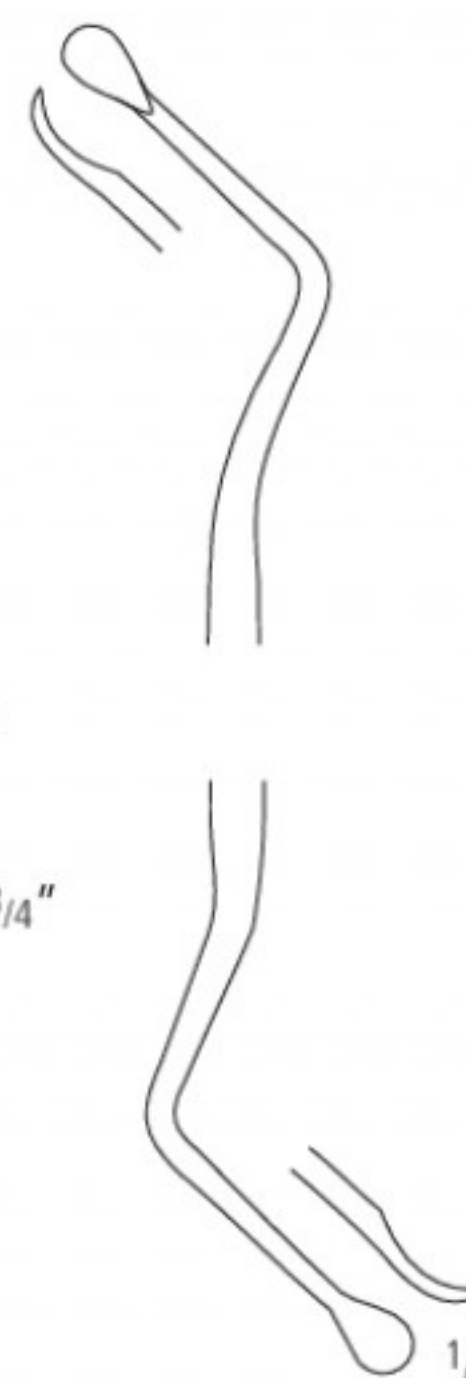

KA 654/87
 17,0 cm/6³/₄"

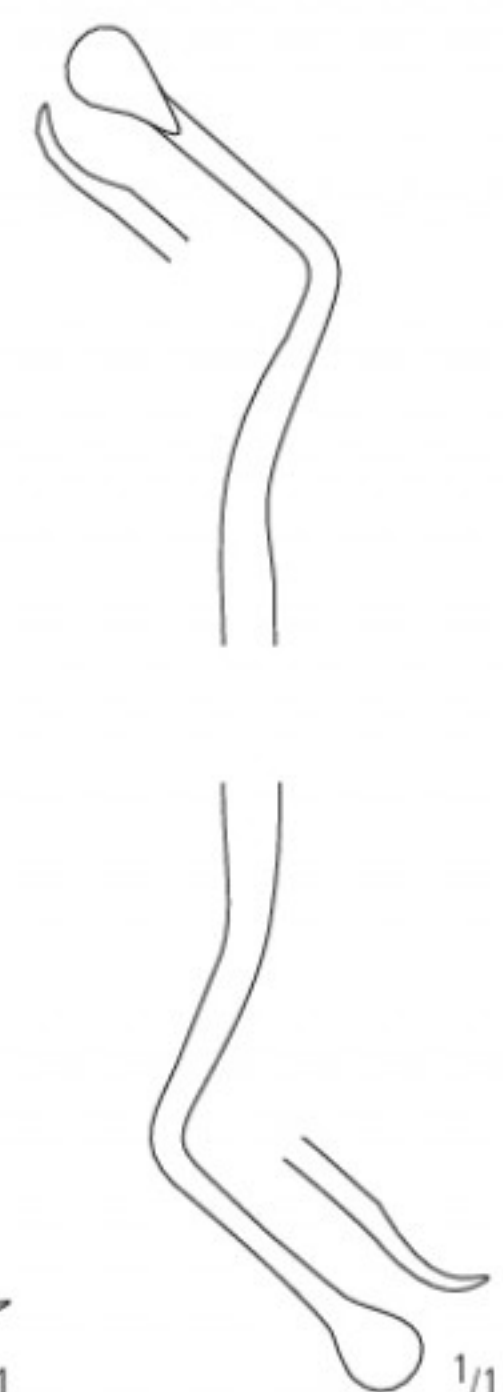

KA 654/88
 17,0 cm/6³/₄"

AA
 AB
 AC
 AD
 AE
 AF
 AG
 AH
 AI
 AJ
 AK
 AL
 AM
 AN
 AO
 AP
 AQ
 AR
 AS
 AT
 AU
 AV
 AW
 AX
 AY
 AZ

KA

Raspatorien
Raspatories
Raspadores
Rugines-Raspatoires
Periostotomi



KA 660/20
20,0 cm/8"



KA 661/20
20,0 cm/8"

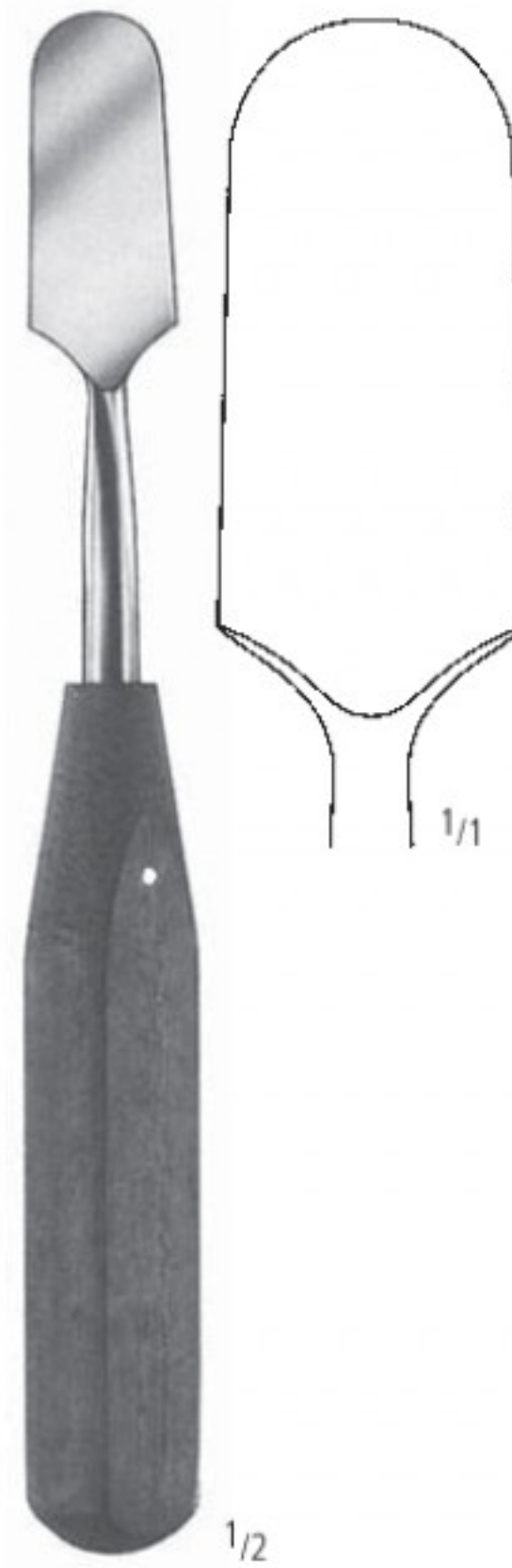

KA 662/20
20,0 cm/8"

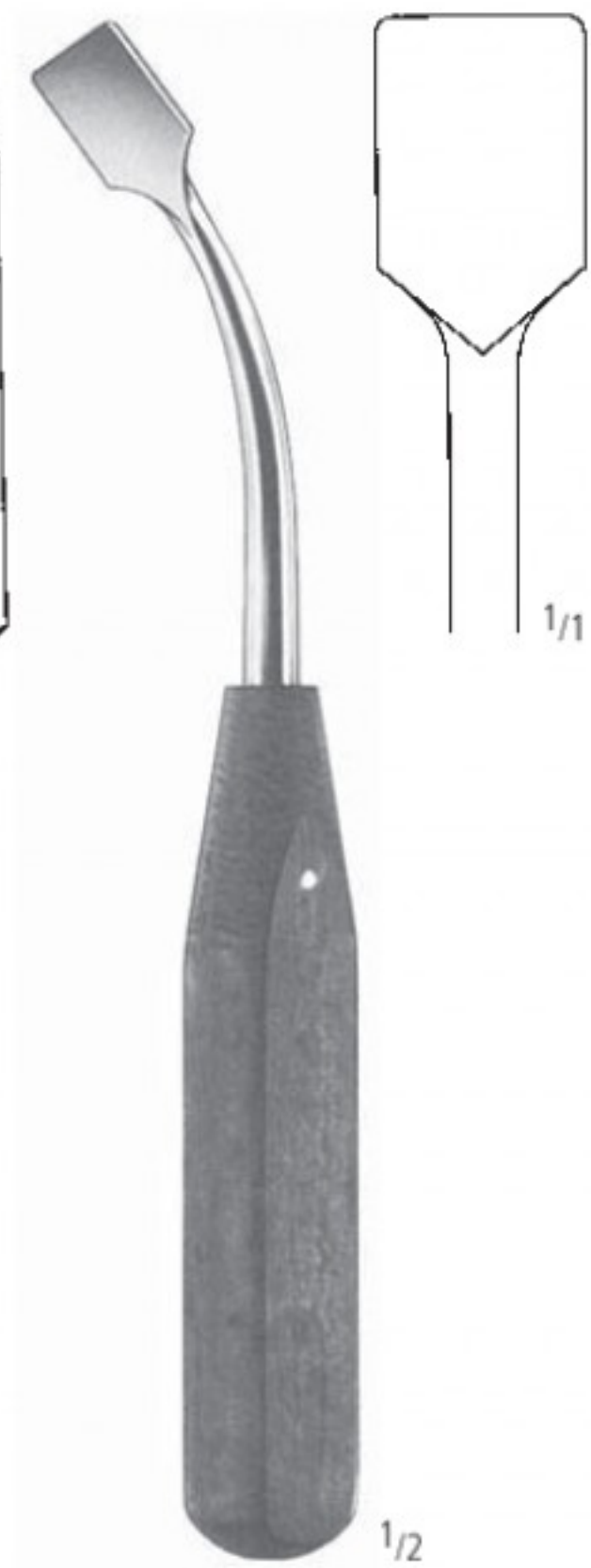

KA 664/19
19,0 cm/7 1/2"



KA 665/18
18,0 cm/7"



KA 666/18
18,0 cm/7"



KA 667/18
18,0 cm/7"



KA 668/18
18,0 cm/7"

Raspatorien
Raspatories
Raspadores
Rugines-Raspatoires
Periostotomi

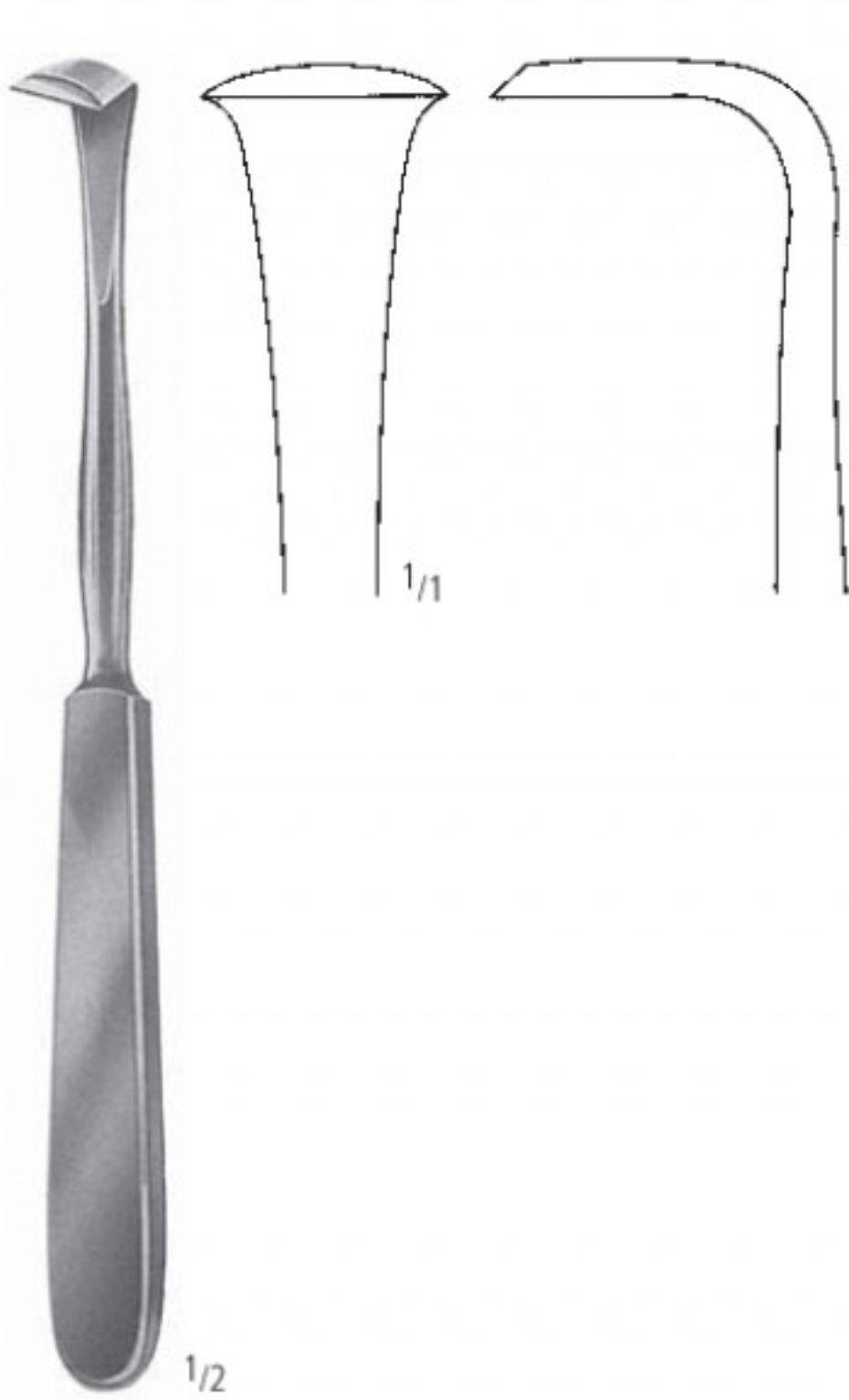

LANGENBECK
KA 671/18
18,0 cm/7"

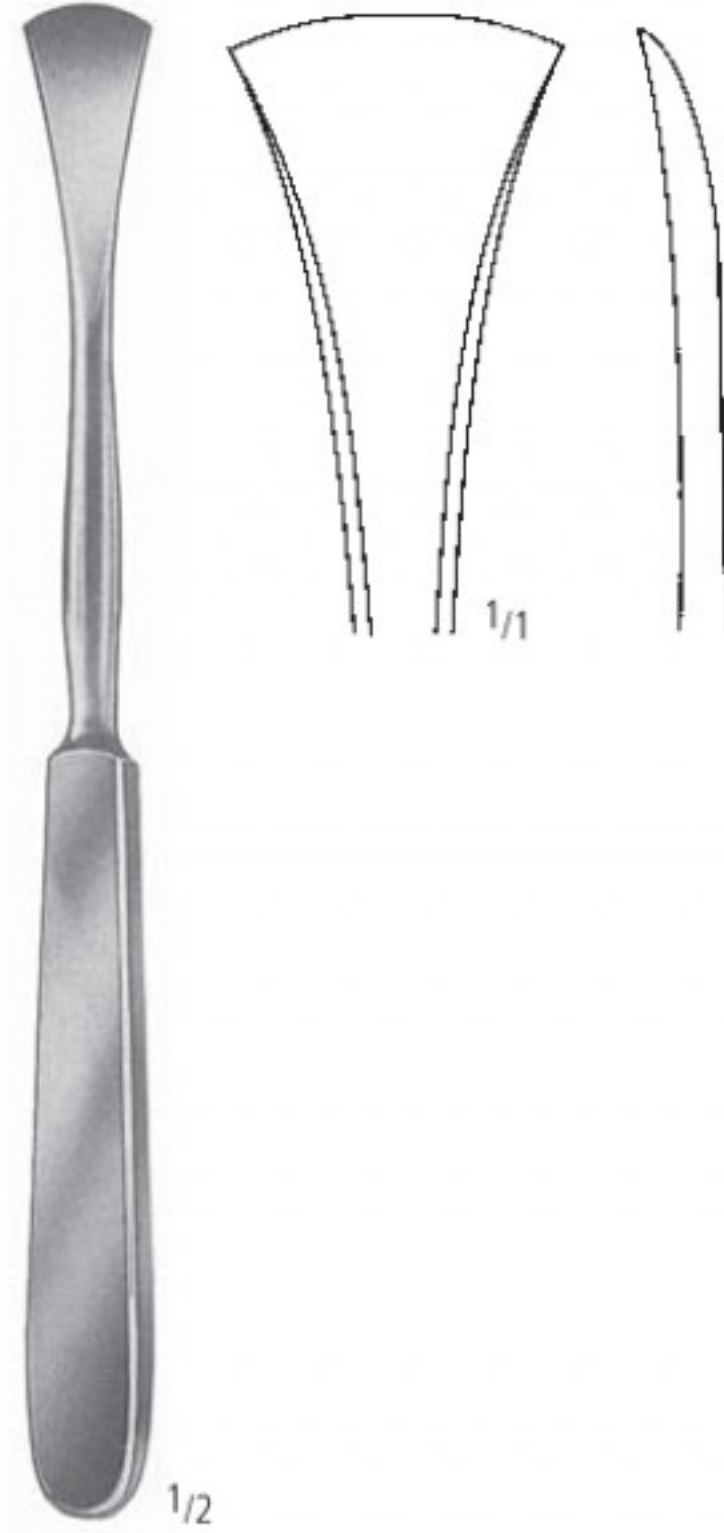

LANGENBECK
KA 672/19
19,0 cm/7 1/2"

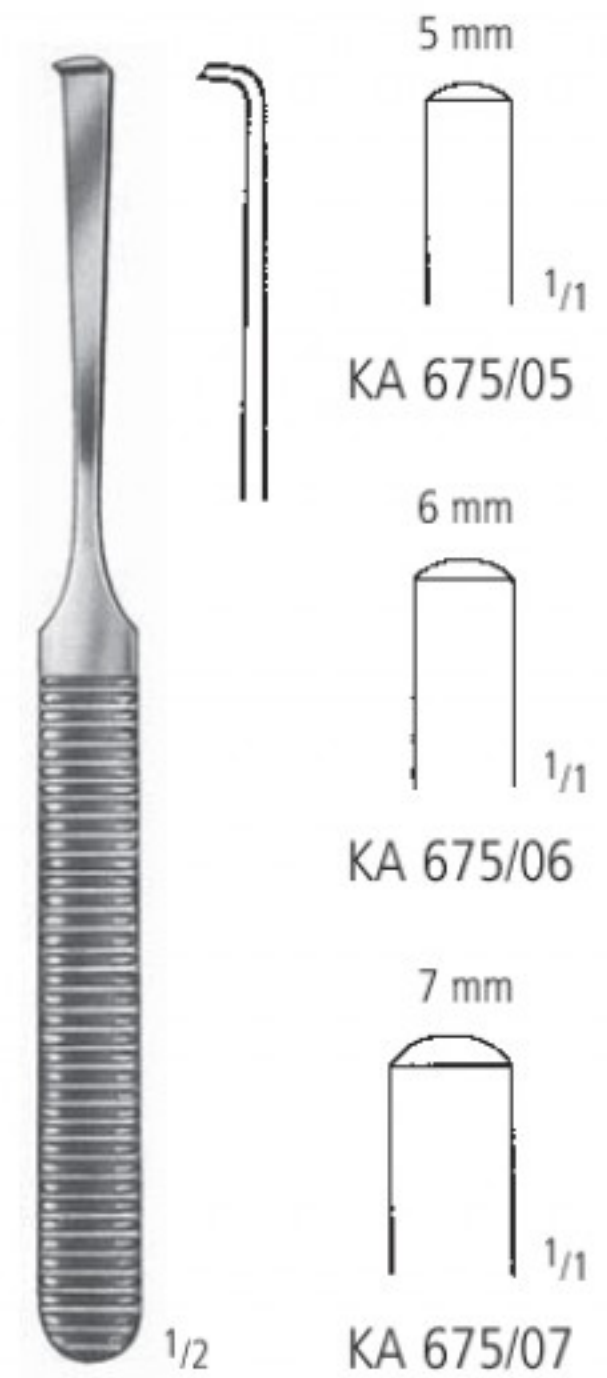

16,0 cm/6 1/4"



LAMBOTTE
21,0 cm/8 1/4"

- 5 mm
KA 677/05
- 10 mm
KA 677/10
- 15 mm
KA 677/15
- 20 mm
KA 677/20
- 25 mm
KA 677/25

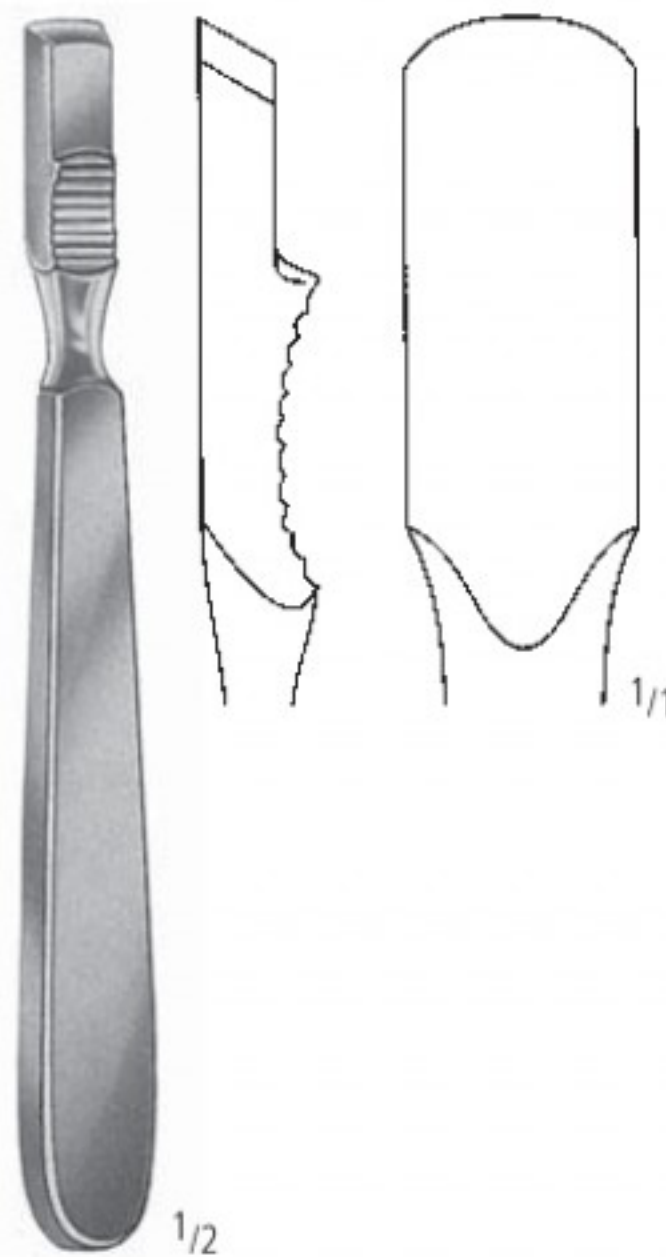

FARABEUF
KA 678/15
15,0 cm/6"

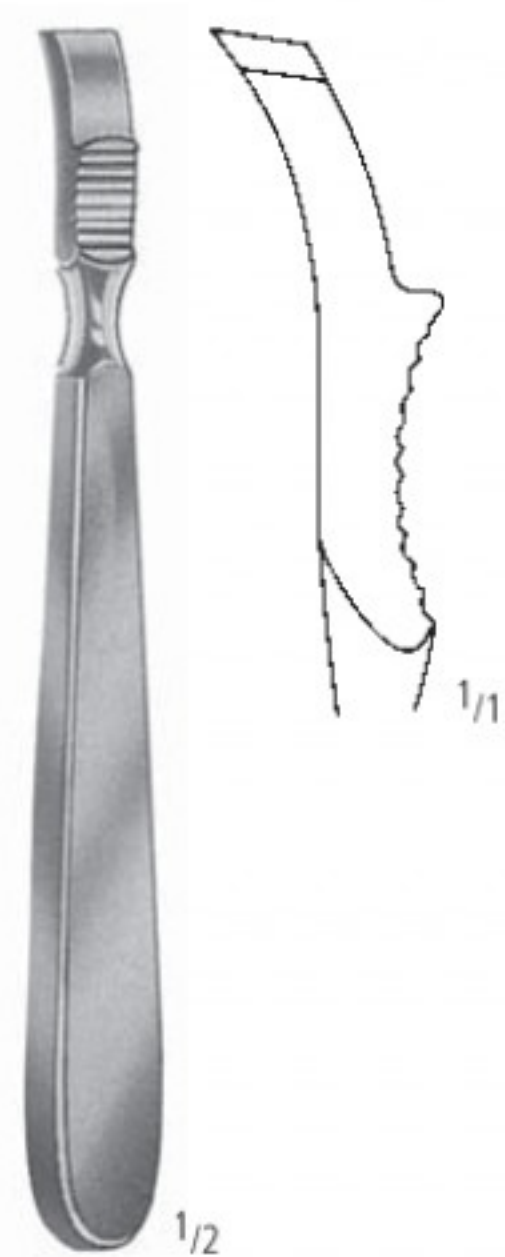

FARABEUF
KA 679/15
15,0 cm/6"

AA
AB
AC
AD
AE
AF
AK
AL
AM
AO
AP
AR
KA
KB
KC
KD
KU
KY

Raspatorien
 Raspatories
 Raspadores
 Rugines-Raspatoires
 Periostotomi

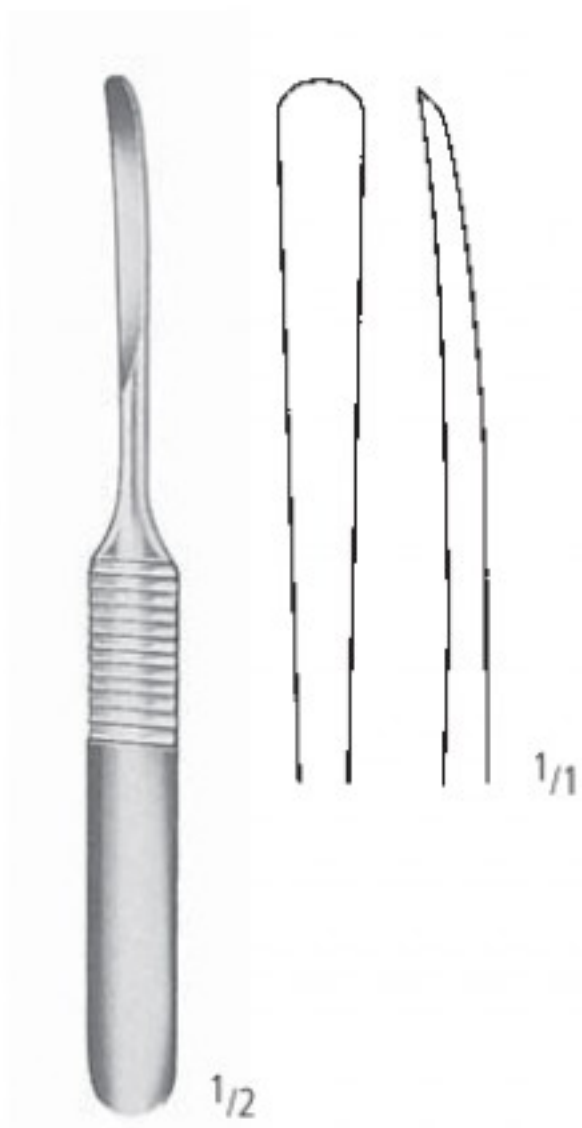

WILLIGER
 KA 680/13
 13,0 cm/5"

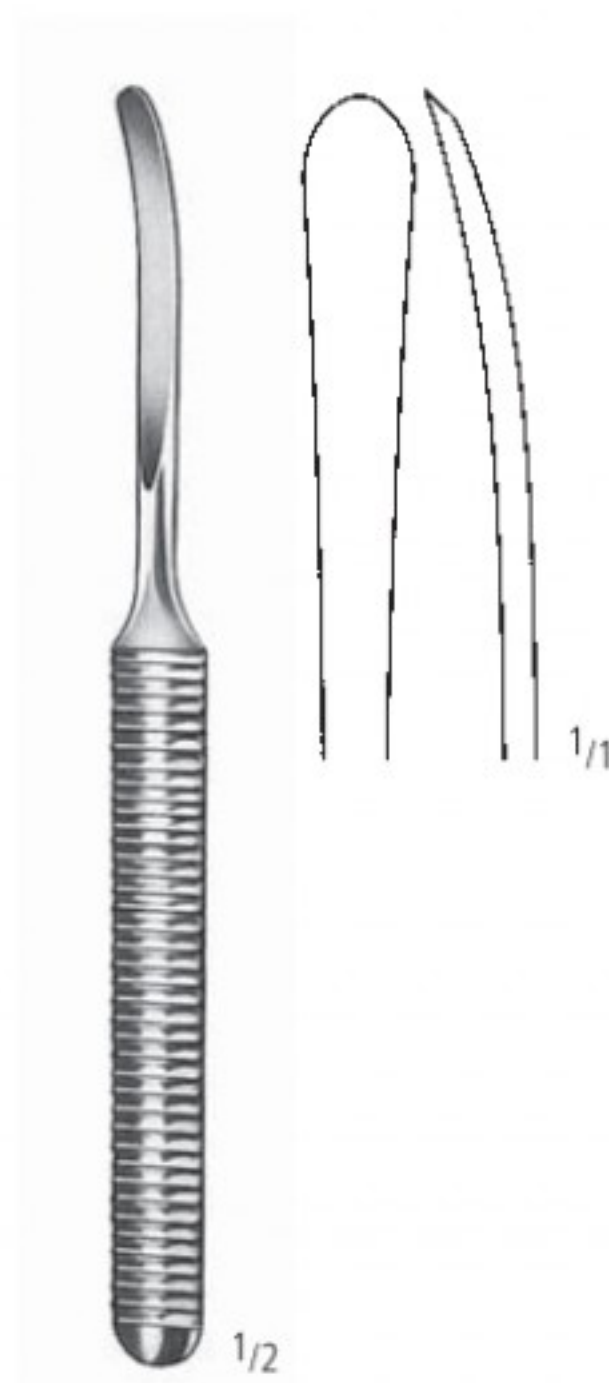

WILLIGER
 KA 680/16
 16,0 cm/6 1/4"

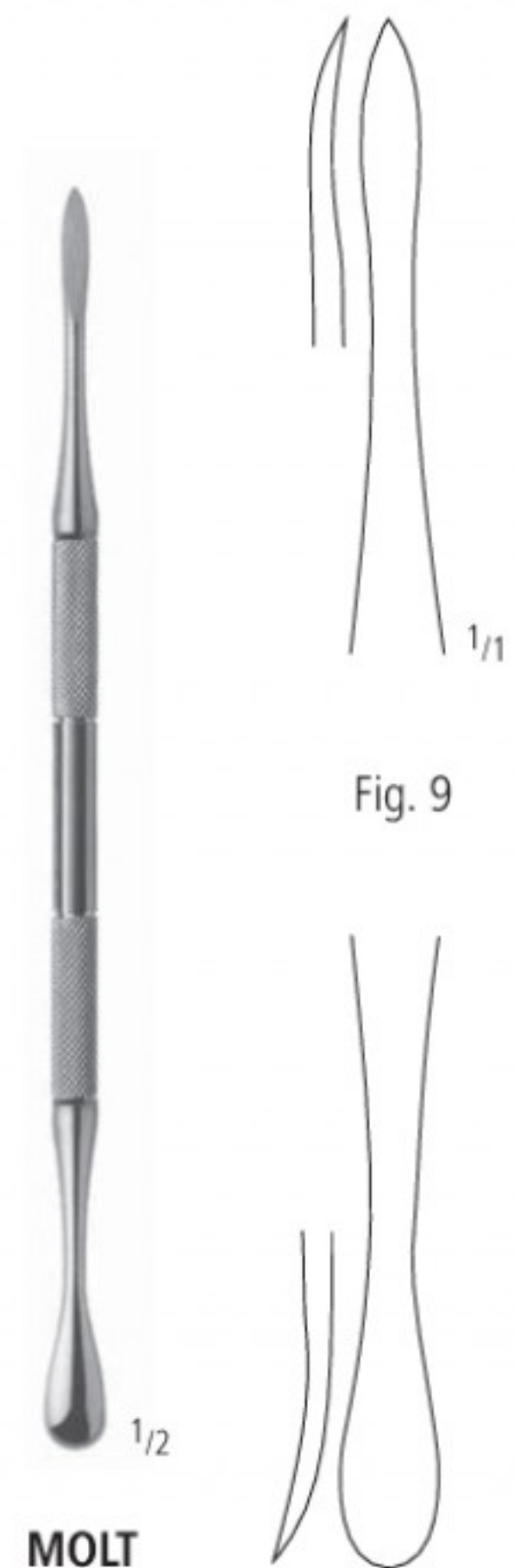

MOLT
 KA 682/09
 18,0 cm/7"

Fig. 9

Raspatorien
 Raspatories
 Raspadores
 Rugines-Raspatoires
 Periostotomi



DOYEN
 17,0 cm/6³/₄"

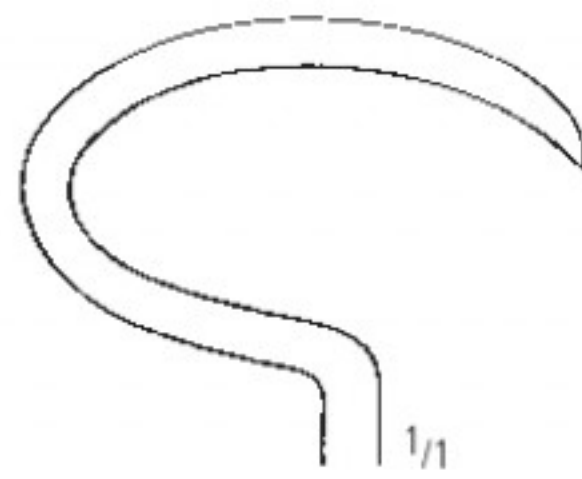

KA 681/17

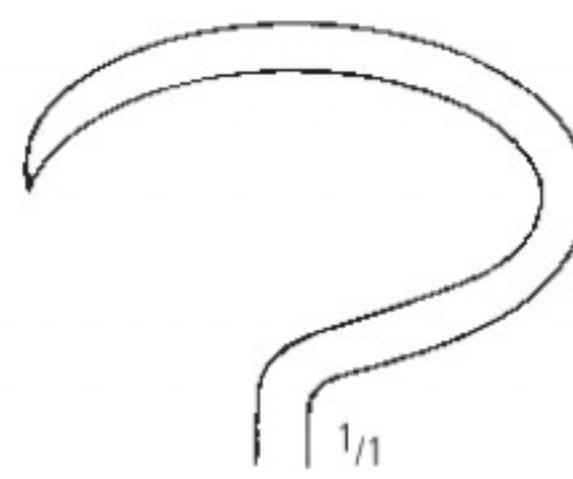

KA 683/17

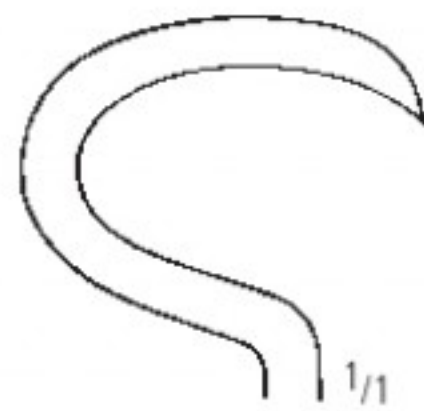

KA 685/17

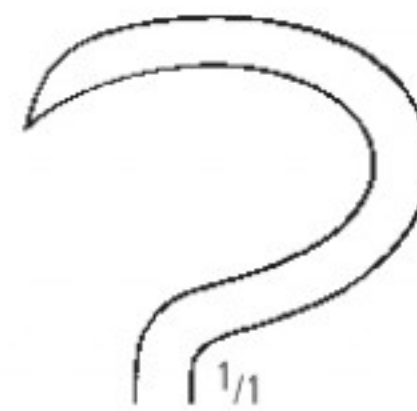

KA 687/17



SEDILLOT
 KA 688/21
 21,0 cm/8¹/₄"

AA
 AB
 AC
 AD
 AE
 AF
 AG
 AH
 AI
 AJ
 AK
 AL
 AM
 AN
 AO
 AP
 AQ
 AR
 AS
 AT
 AU
 AV
 AW
 AX
 AY
 AZ

KA

Raspatorien
Raspatories
Raspadores
Rugines-Raspatoires
Periostotomi



SEMB



KA 689/01
17,5 cm/7"



KA 689/02
21,0 cm/8¹/₄"



KA 689/03
17,5 cm/7"



KA 689/04
21,0 cm/8¹/₄"



KA 689/05
20,5 cm/8"



ALEXANDER
KA 689/20
20,0 cm/8"



MATSON
KA 689/22
22,0 cm/8³/₄"

Elevatori
Elevators
Elevadores
Elévateurs
Elevatori



KA 690/08

LANGENBECK
19,5 cm/7³/₄"

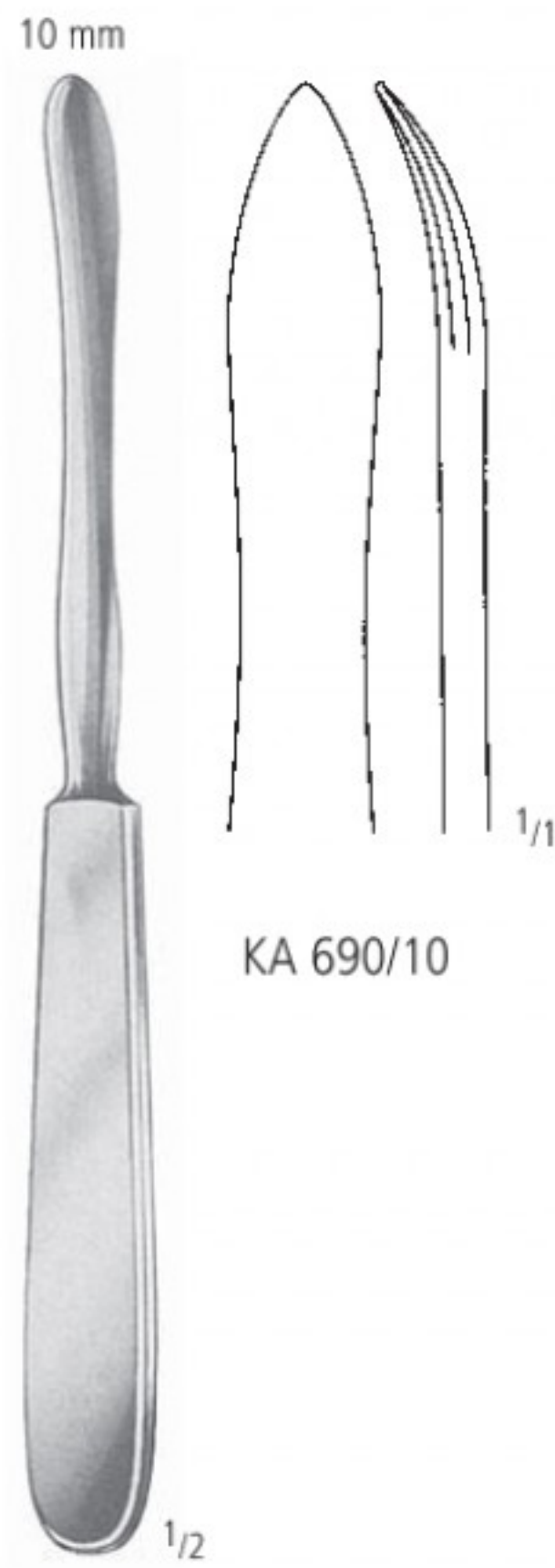

KA 690/10

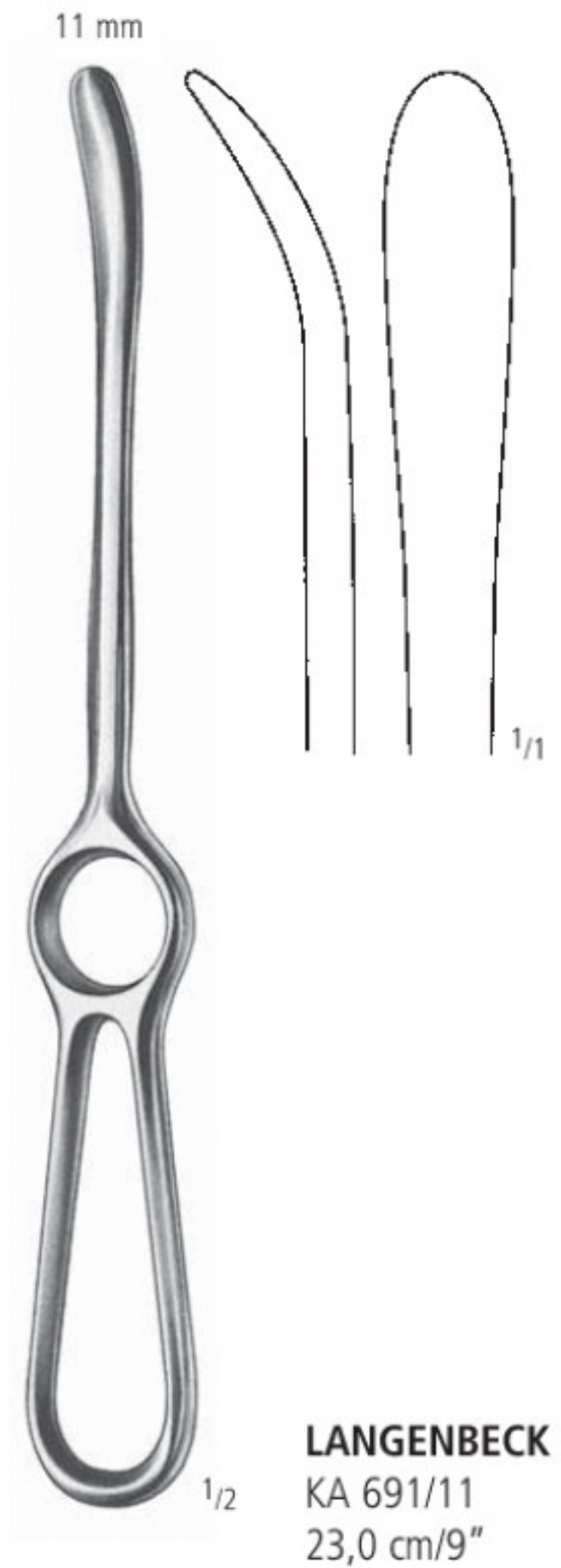

LANGENBECK
KA 691/11
23,0 cm/9"

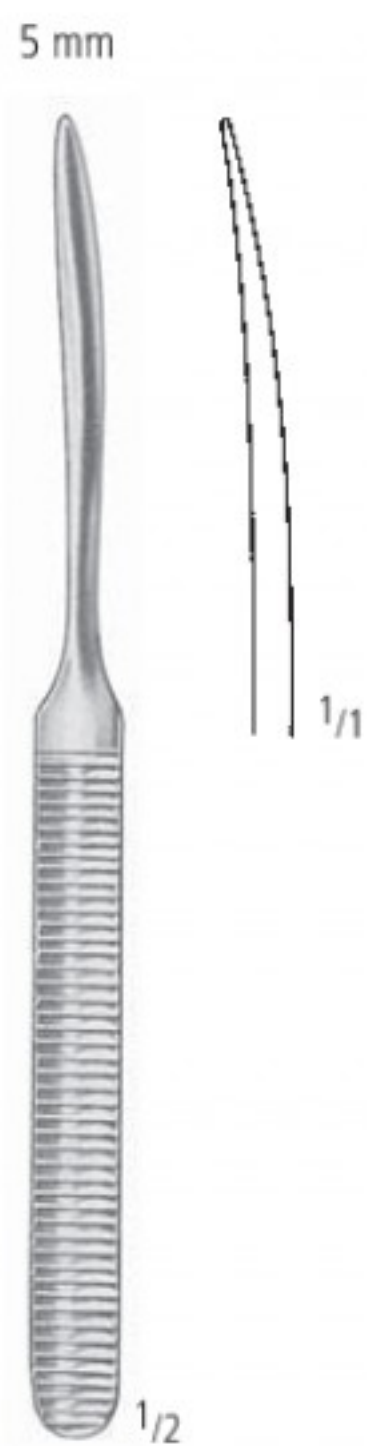

WILLIGER
KA 692/16
16,0 cm/6¹/₄"

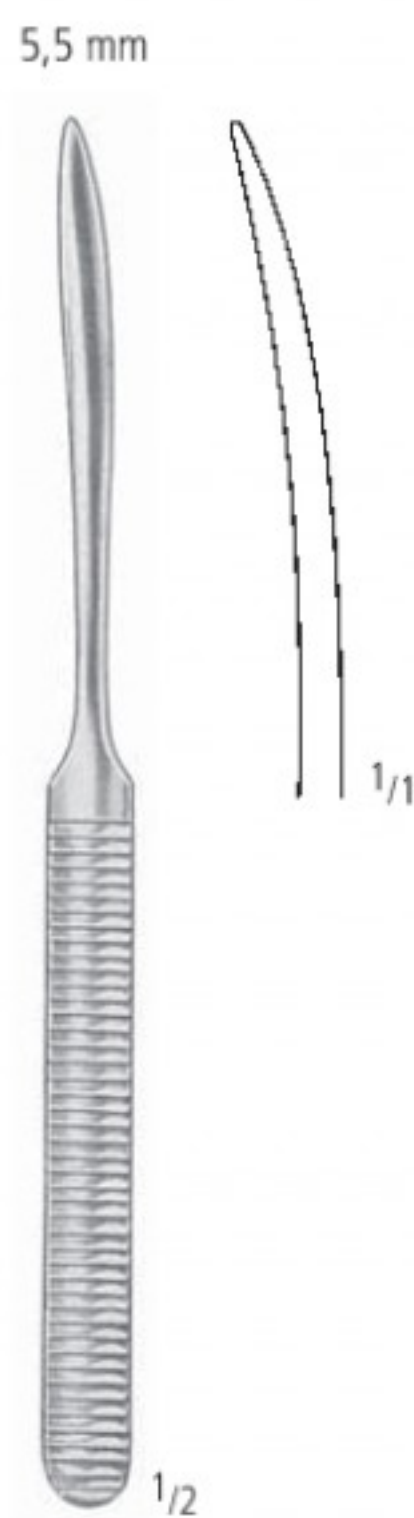

WILLIGER
KA 694/17
17,0 cm/6³/₄"

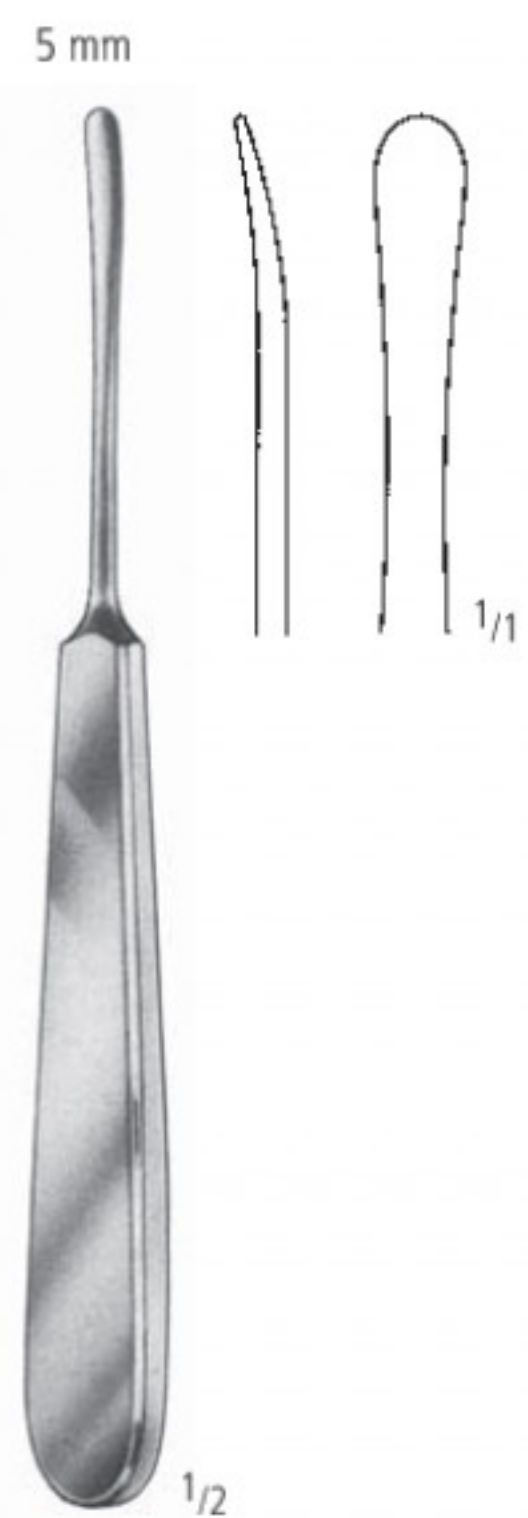

SEBILEAU
KA 695/05
17,5 cm/7"

AA
AB
AC
AD
AE
AF
AK
AL
AM
AO
AP
AR
KA
KB
KC
KD
KU
KY

Elevatoren
Elevators
Elevadores
Elévateurs
Elevatori



KA 696/17
17,5 cm/6³/₄"



KA 698/16
16,0 cm/6¹/₄"



ALDERDYCE
KA 699/21
21,0 cm/8¹/₄"



McDONALD
KA 700/19
19,0 cm/7¹/₂"



KA 701/19
scharf
sharp
cortante
tranchant
tagliante

KA 702/19
stumpf
blunt
romo
mousse
smusso

FREER
19,0 cm/7¹/₂"



FREER
KA 703/18
18,0 cm/7"

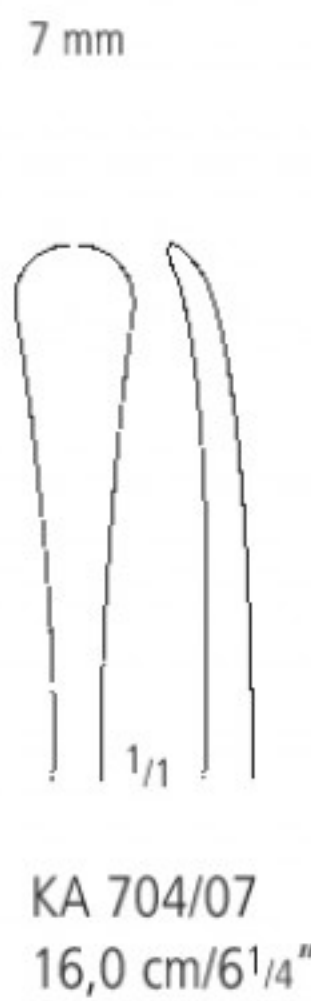

7 mm
KA 704/07
16,0 cm/6¹/₄"

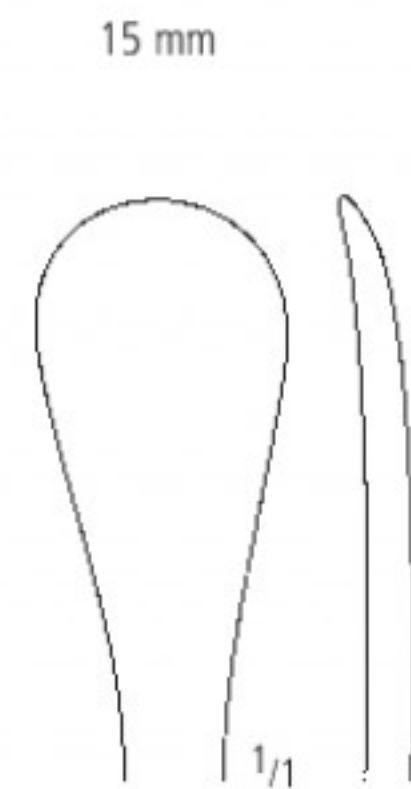

15 mm
KA 704/15
19,0 cm/7¹/₂"

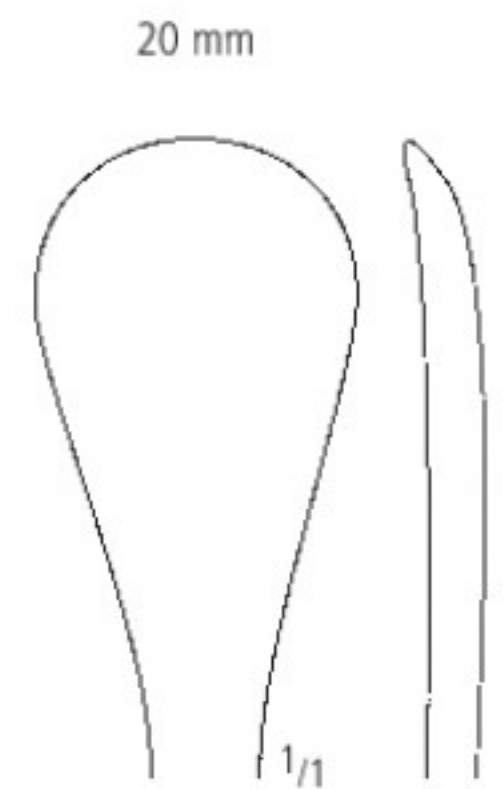

20 mm
KA 704/20
19,0 cm/7¹/₂"

HOEN

Elevatori
Elevators
Elevadores
Elévateurs
Elevatori

AA
AB
AC
AD
AE
AF
AK
AL
AM
AO
AP
AR
KA
KB
KC
KD
KU
KY



ADSON
17,0 cm/6³/₄"



KA 705/01



KA 705/02



KA 705/03



KA 705/04



COBB
28,0 cm/11"



KA 708/01



KA 708/02



KA 708/03

Knochenfeilen
 Bone Files
 Limas para huesos
 Limes à os
 Lime per ossa

20,0 mm



KA 710/22
 22,0 cm/8³/₄"

13,0 mm



KA 711/24
 24,5 cm/9³/₄"

20,0 mm



KA 712/28
 28,0 cm/11"

Raspeln, Stössel
 Rasps, Tampers
 Escofinas, Punzón
 Râpes, Pîlons
 Raspe, Pestoni



PUTTI
 KA 715/27
 27,0 cm/10¹/₂"



PUTTI
 KA 715/30
 30 cm/12"



15,5 cm/6"

 1/1
 Ø 2 mm
 KA 720/02

 1/1
 Ø 3 mm
 KA 720/03

 1/1
 Ø 4 mm
 KA 720/04

 1/1
 Ø 5 mm
 KA 720/05

 1/1
 Ø 6 mm
 KA 720/06

 1/1
 Ø 8 mm
 KA 720/08

 1/1
 Ø 10 mm
 KA 720/10

AA
 AB
 AC
 AD
 AE
 AF
 AG
 AH
 AI
 AJ
 AK
 AL
 AM
 AN
 AO
 AP
 AQ
 AR
 AS
 AT
 AU
 AV
 AW
 AX
 AY
 AZ
 BA
 BB
 BC
 BD
 BE
 BF
 BG
 BH
 BI
 BJ
 BK
 BL
 BM
 BN
 BO
 BP
 BQ
 BR
 BS
 BT
 BU
 BV
 BW
 BX
 BY
 BZ
 CA
 CB
 CC
 CD
 CE
 CF
 CG
 CH
 CI
 CJ
 CK
 CL
 CM
 CN
 CO
 CP
 CQ
 CR
 CS
 CT
 CU
 CV
 CW
 CX
 CY
 CZ
 DA
 DB
 DC
 DD
 DE
 DF
 DG
 DH
 DI
 DJ
 DK
 DL
 DM
 DN
 DO
 DP
 DQ
 DR
 DS
 DT
 DU
 DV
 DW
 DX
 DY
 DZ
 EA
 EB
 EC
 ED
 EE
 EF
 EG
 EH
 EI
 EJ
 EK
 EL
 EM
 EN
 EO
 EP
 EQ
 ER
 ES
 ET
 EU
 EV
 EW
 EX
 EY
 EZ
 FA
 FB
 FC
 FD
 FE
 FF
 FG
 FH
 FI
 FJ
 FK
 FL
 FM
 FN
 FO
 FP
 FQ
 FR
 FS
 FT
 FU
 FV
 FW
 FX
 FY
 FZ
 GA
 GB
 GC
 GD
 GE
 GF
 GG
 GH
 GI
 GJ
 GK
 GL
 GM
 GN
 GO
 GP
 GQ
 GR
 GS
 GT
 GU
 GV
 GW
 GX
 GY
 GZ
 HA
 HB
 HC
 HD
 HE
 HF
 HG
 HH
 HI
 HJ
 HK
 HL
 HM
 HN
 HO
 HP
 HQ
 HR
 HS
 HT
 HU
 HV
 HW
 HX
 HY
 HZ
 IA
 IB
 IC
 ID
 IE
 IF
 IG
 IH
 II
 IJ
 IK
 IL
 IM
 IN
 IO
 IP
 IQ
 IR
 IS
 IT
 IU
 IV
 IW
 IX
 IY
 IZ
 JA
 JB
 JC
 JD
 JE
 JF
 JG
 JH
 JI
 JJ
 JK
 JL
 JM
 JN
 JO
 JP
 JQ
 JR
 JS
 JT
 JU
 JV
 JW
 JX
 JY
 JZ
 KA
 KB
 KC
 KD
 KE
 KF
 KG
 KH
 KI
 KJ
 KK
 KL
 KM
 KN
 KO
 KP
 KQ
 KR
 KS
 KT
 KU
 KV
 KW
 KX
 KY
 KZ
 LA
 LB
 LC
 LD
 LE
 LF
 LG
 LH
 LI
 LJ
 LK
 LL
 LM
 LN
 LO
 LP
 LQ
 LR
 LS
 LT
 LU
 LV
 LW
 LX
 LY
 LZ
 MA
 MB
 MC
 MD
 ME
 MF
 MG
 MH
 MI
 MJ
 MK
 ML
 MM
 MN
 MO
 MP
 MQ
 MR
 MS
 MT
 MU
 MV
 MW
 MX
 MY
 MZ
 NA
 NB
 NC
 ND
 NE
 NF
 NG
 NH
 NI
 NJ
 NK
 NL
 NM
 NN
 NO
 NP
 NQ
 NR
 NS
 NT
 NU
 NV
 NW
 NX
 NY
 NZ
 OA
 OB
 OC
 OD
 OE
 OF
 OG
 OH
 OI
 OJ
 OK
 OL
 OM
 ON
 OO
 OP
 OQ
 OR
 OS
 OT
 OU
 OV
 OW
 OX
 OY
 OZ
 PA
 PB
 PC
 PD
 PE
 PF
 PG
 PH
 PI
 PJ
 PK
 PL
 PM
 PN
 PO
 PP
 PQ
 PR
 PS
 PT
 PU
 PV
 PW
 PX
 PY
 PZ
 QA
 QB
 QC
 QD
 QE
 QF
 QG
 QH
 QI
 QJ
 QK
 QL
 QM
 QN
 QO
 QP
 QQ
 QR
 QS
 QT
 QU
 QV
 QW
 QX
 QY
 QZ
 RA
 RB
 RC
 RD
 RE
 RF
 RG
 RH
 RI
 RJ
 RK
 RL
 RM
 RN
 RO
 RP
 RQ
 RR
 RS
 RT
 RU
 RV
 RW
 RX
 RY
 RZ
 SA
 SB
 SC
 SD
 SE
 SF
 SG
 SH
 SI
 SJ
 SK
 SL
 SM
 SN
 SO
 SP
 SQ
 SR
 SS
 ST
 SU
 SV
 SW
 SX
 SY
 SZ
 TA
 TB
 TC
 TD
 TE
 TF
 TG
 TH
 TI
 TJ
 TK
 TL
 TM
 TN
 TO
 TP
 TQ
 TR
 TS
 TT
 TU
 TV
 TW
 TX
 TY
 TZ
 UA
 UB
 UC
 UD
 UE
 UF
 UG
 UH
 UI
 UJ
 UK
 UL
 UM
 UN
 UO
 UP
 UQ
 UR
 US
 UT
 UY
 UZ
 VA
 VB
 VC
 VD
 VE
 VF
 VG
 VH
 VI
 VJ
 VK
 VL
 VM
 VN
 VO
 VP
 VQ
 VR
 VS
 VT
 VU
 VV
 VW
 VX
 VY
 VZ
 WA
 WB
 WC
 WD
 WE
 WF
 WG
 WH
 WI
 WJ
 WK
 WL
 WM
 WN
 WO
 WP
 WQ
 WR
 WS
 WT
 WU
 WV
 WW
 WX
 WY
 WZ
 XA
 XB
 XC
 XD
 XE
 XF
 XG
 XH
 XI
 XJ
 XK
 XL
 XM
 XN
 XO
 XP
 XQ
 XR
 XS
 XT
 XU
 XV
 XW
 XX
 XY
 XZ
 YA
 YB
 YC
 YD
 YE
 YF
 YG
 YH
 YI
 YJ
 YK
 YL
 YM
 YN
 YO
 YP
 YQ
 YR
 YS
 YT
 YU
 YV
 YW
 YX
 YZ
 ZA
 ZB
 ZC
 ZD
 ZE
 ZF
 ZG
 ZH
 ZI
 ZJ
 ZK
 ZL
 ZM
 ZN
 ZO
 ZP
 ZQ
 ZR
 ZS
 ZT
 ZU
 ZV
 ZW
 ZX
 ZY
 ZZ

Knochenhaltezangen
 Bone Holding Forceps
 Pinzas para huesos
 Daviers porte-os
 Tenaglie per ossa

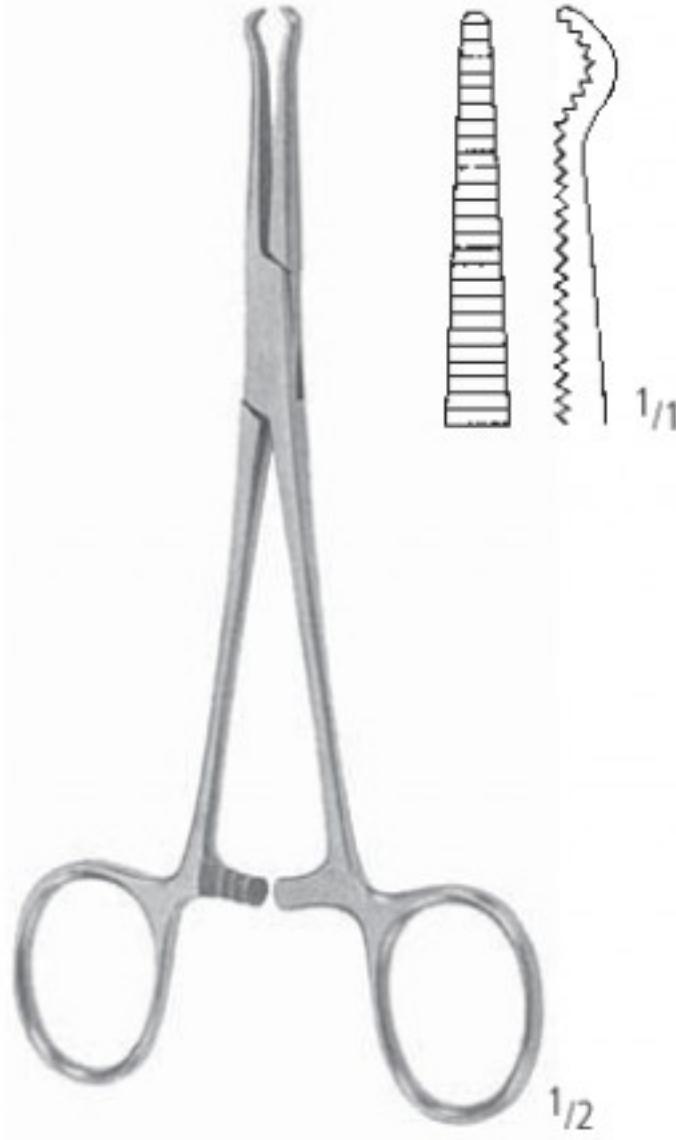

KA 730/00
 14,0 cm/5 1/2"



KA 731/00
 13,5 cm/5 1/4"



KA 732/00
 12,0 cm/4 3/4"



20,0 cm/8"

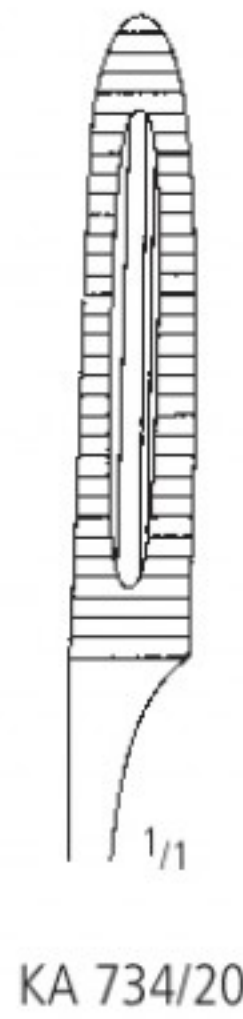

KA 734/20

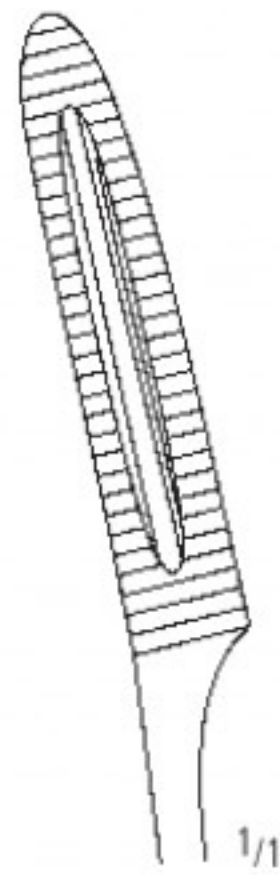

KA 735/20



VAN BUREN
 KA 736/23
 23,0 cm/9"



Meniskus- und Knorpelfasszangen
 Meniscus- and Cartilage Forceps
 Pinzas para cartilago y menisco
 Daviers à ménisques et cartilage
 Pinze per afferrare menisci e cartilagine

AA
AB
AC
AD
AE
AF
AK
AL
AM
AO
AP
AR
KA
KB
KC
KD
KU
KY

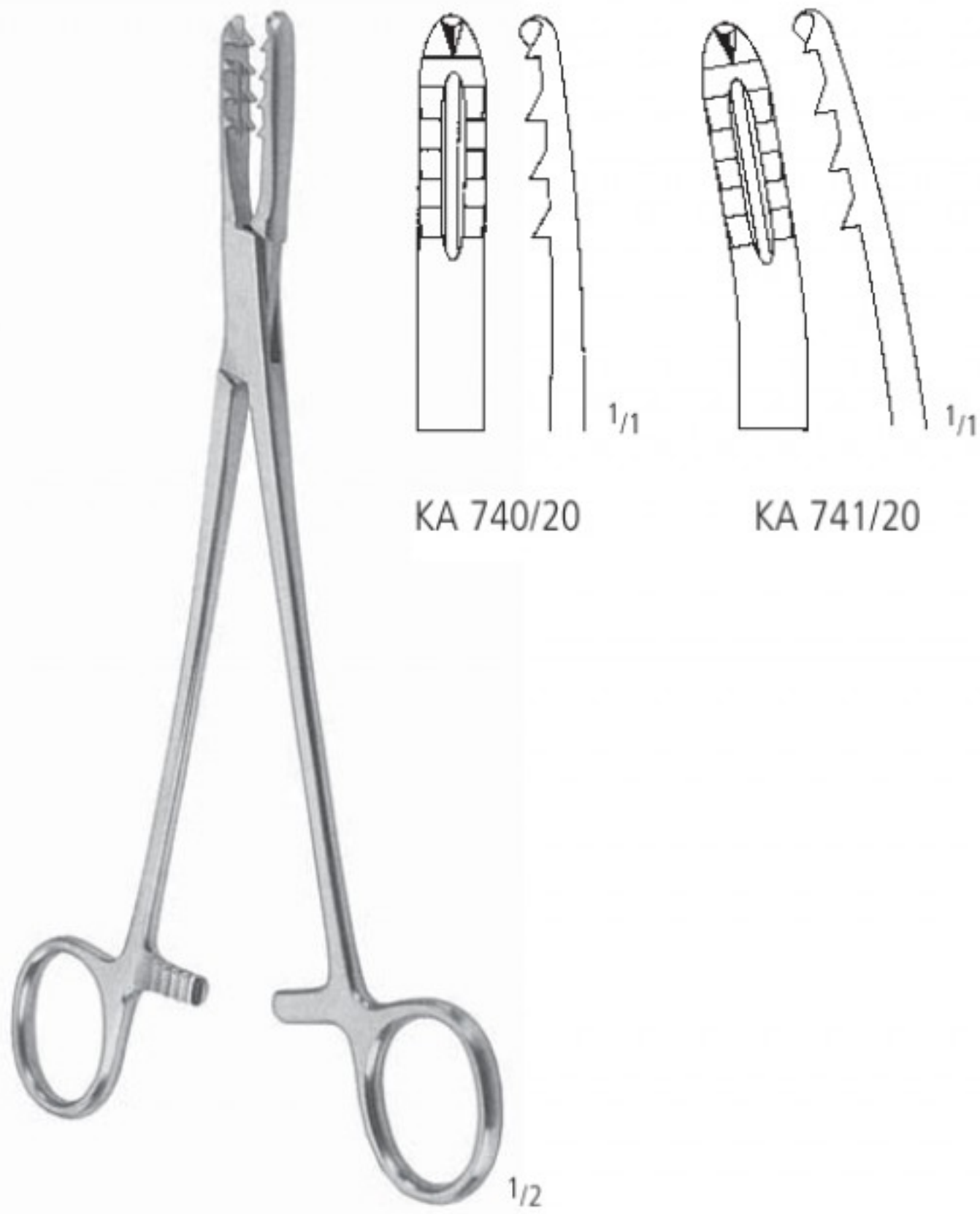

BIRCHER-GANSKE
 20,0 cm/8"

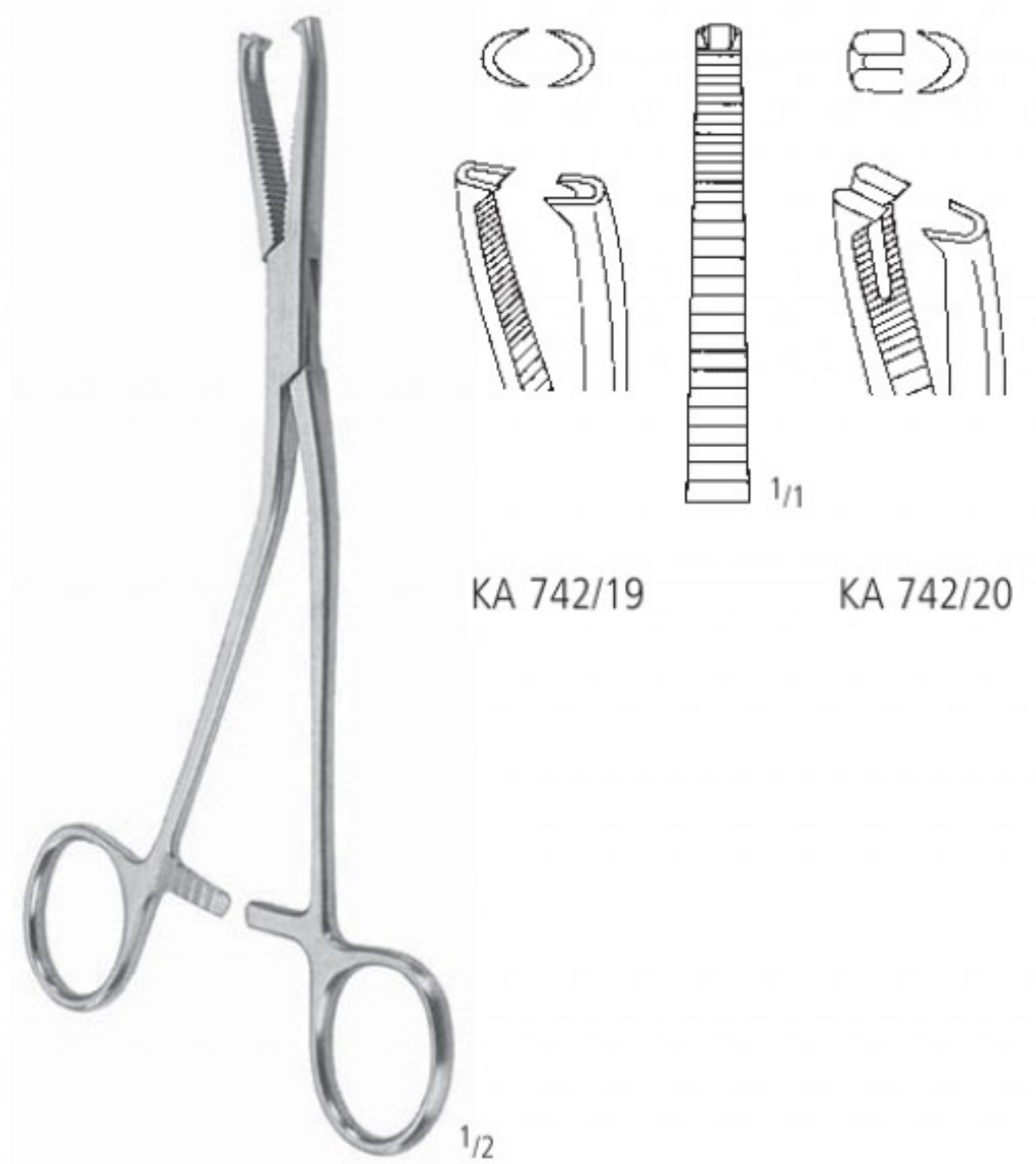

DINGMANN
 19,0 cm/7 1/2"



MARTIN
 KA 744/19
 19,0 cm/7 1/2"

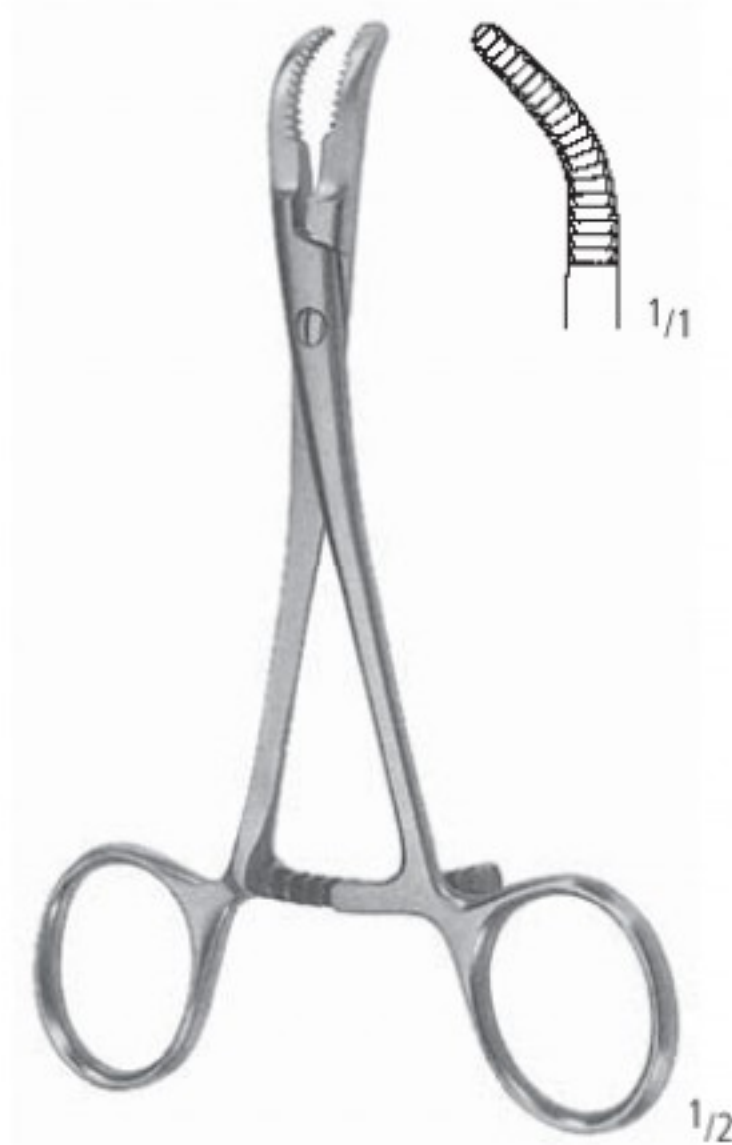

KA 745/13
 13,5 cm/5 1/4"

Knochenhaltezangen
 Bone Holding Forceps
 Pinzas para huesos
 Daviers porte-os
 Tenaglie per ossa



KA 747/21
 21,0 cm/8¹/₄"



LEWIN
 KA 750/17
 17,5 cm/7"

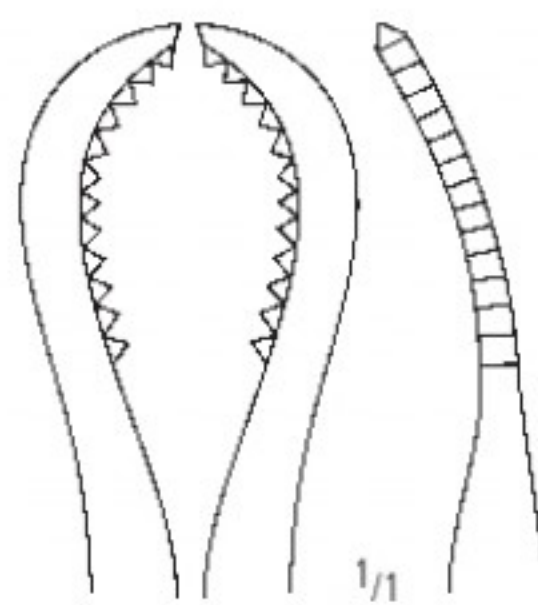

KA 752/16
 16,0 cm/6¹/₄"

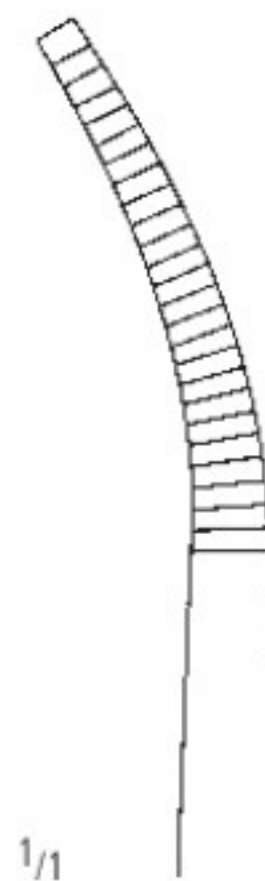
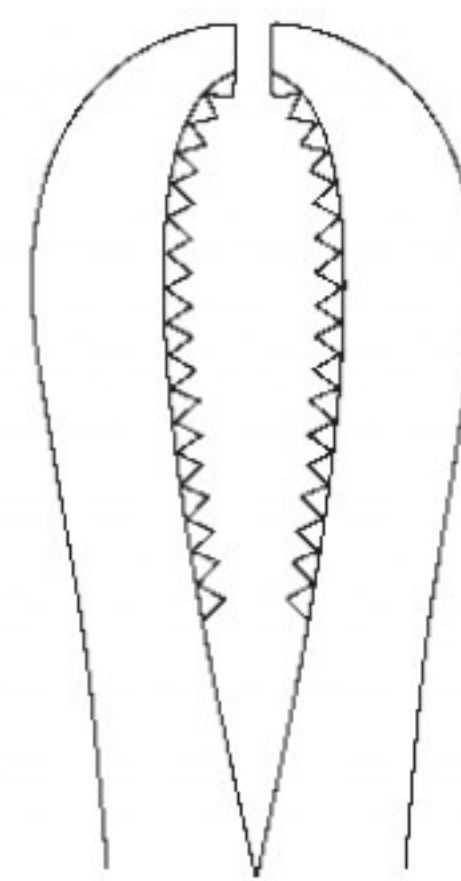

KA 752/24
 24,0 cm/9¹/₂"

Knochenhalte­zangen
 Bone Holding Forceps
 Pinzas para huesos
 Daviers porte-os
 Tenaglie per ossa

AA
 AB
 AC
 AD
 AE
 AF
 AK
 AL
 AM
 AO
 AP
 AR
 KA
 KB
 KC
 KD
 KU
 KY

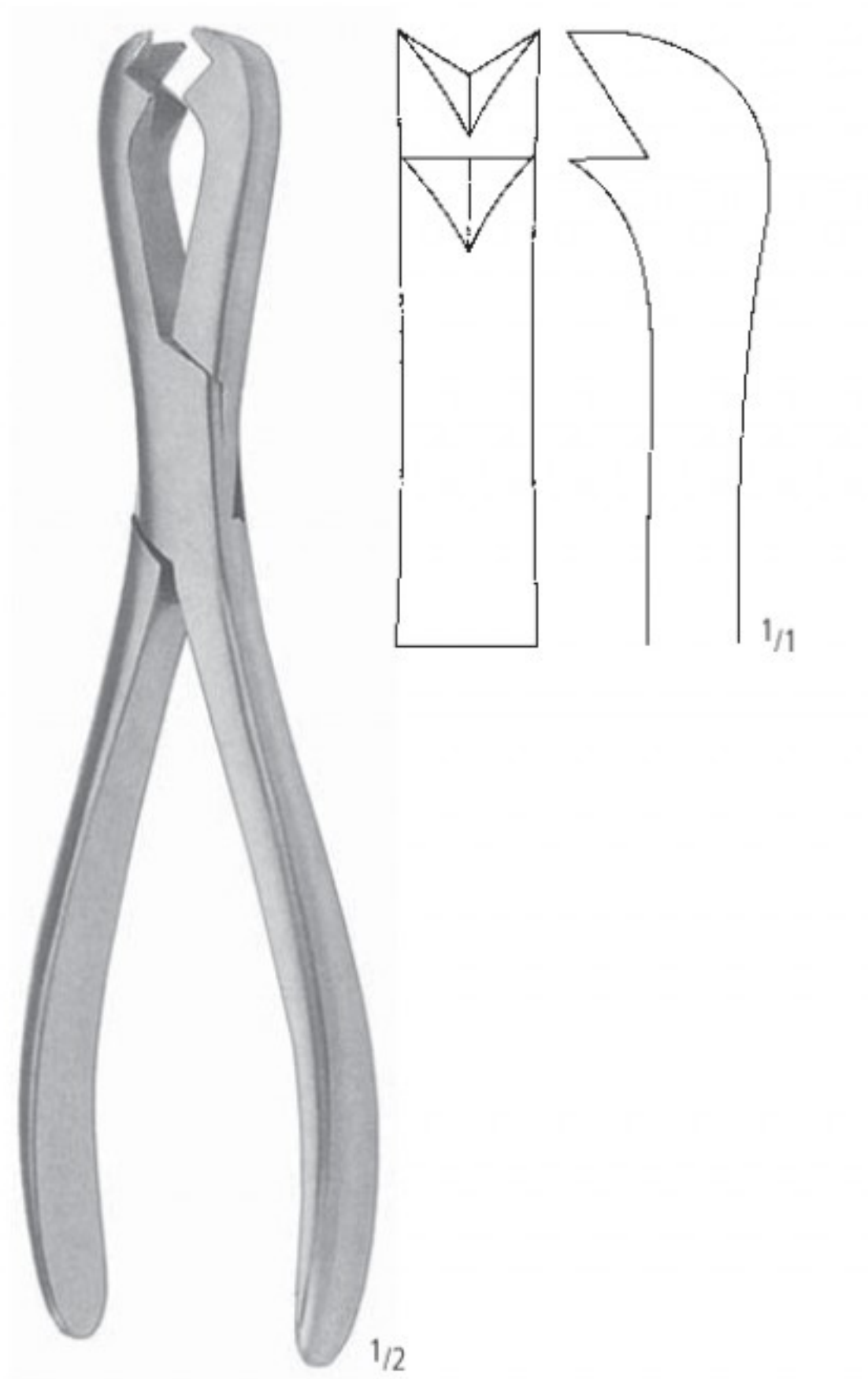

FERGUSSON
 KA 754/21
 21,0 cm/8¹/₄"

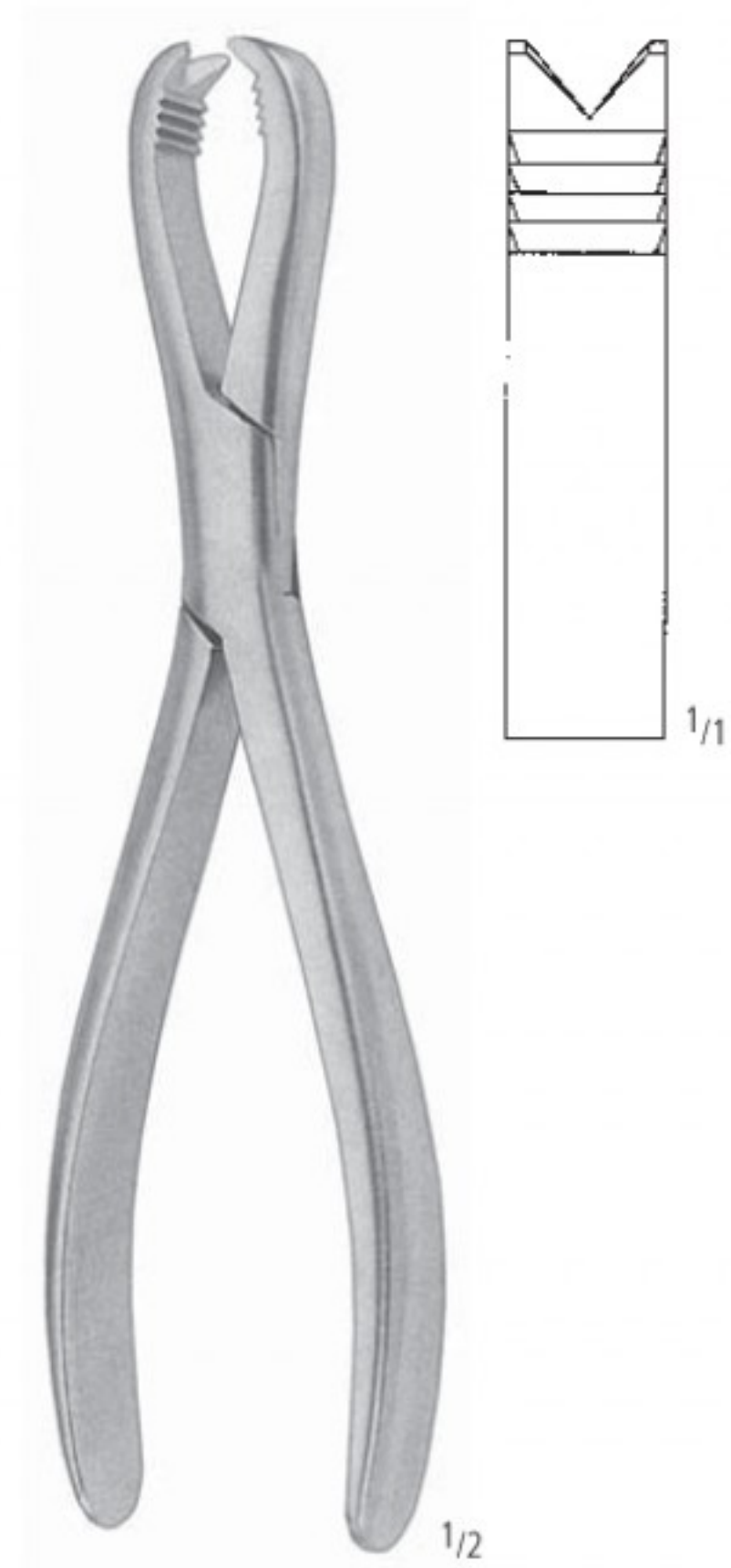

LANGENBECK
 KA 756/21
 21,0 cm/8¹/₄"



KA 757/20
 20,0 cm/8"

Knochenhaltezangen
 Bone Holding Forceps
 Pinzas para huesos
 Daviers porte-os
 Tenaglie per ossa



KA 758/17
 17,0 cm/6³/₄"

KERN

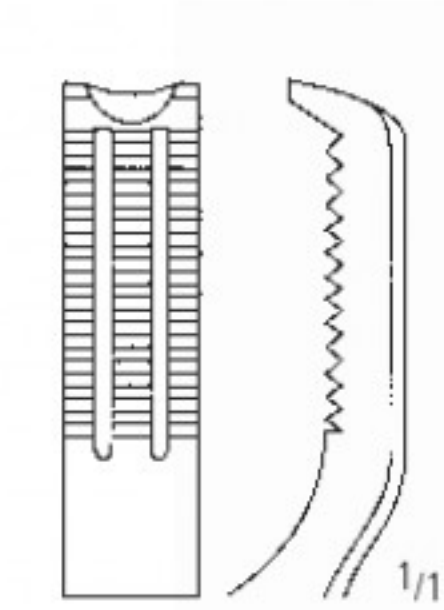

KA 758/21
 21,0 cm/8¹/₂"

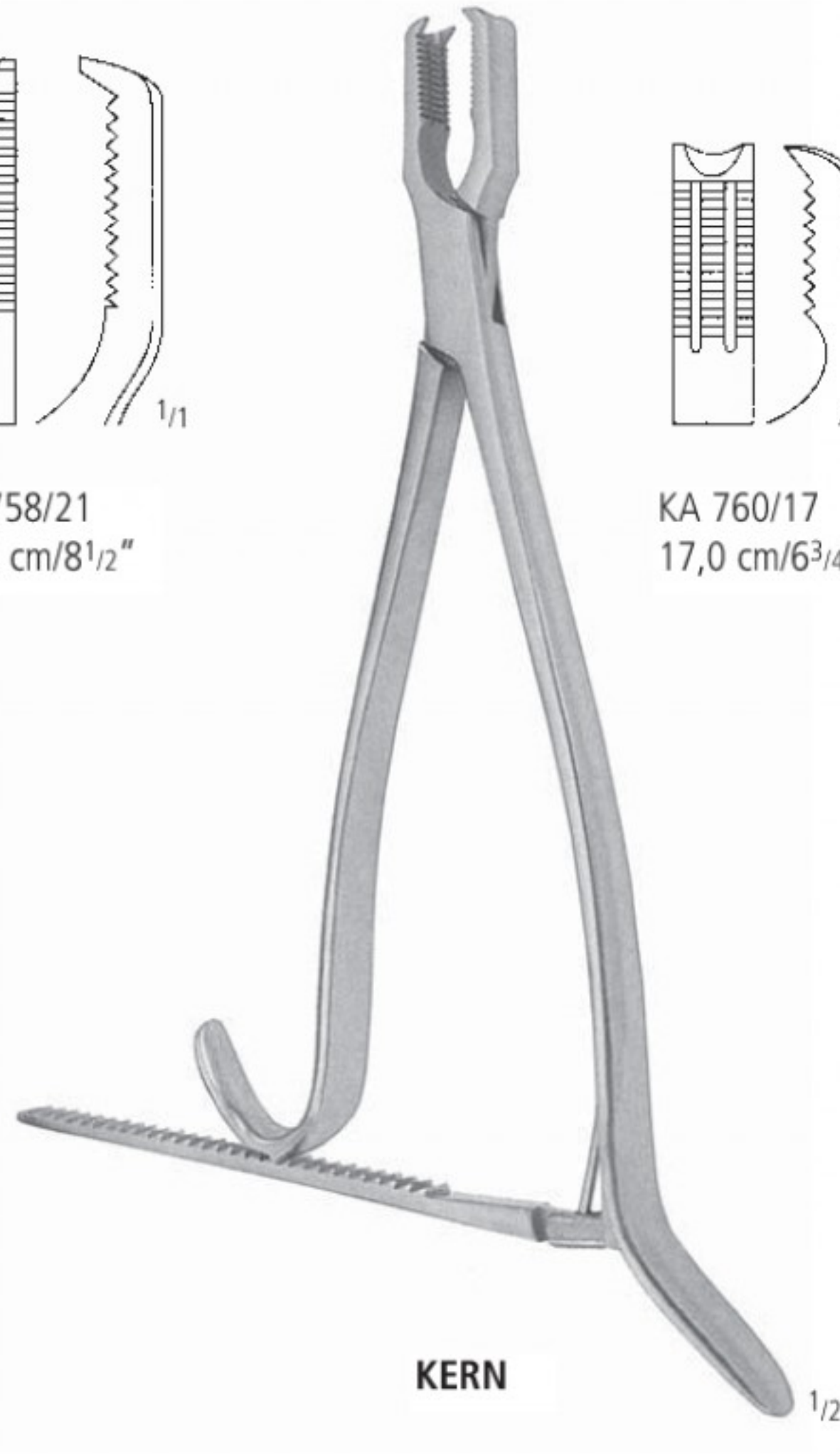

KA 760/17
 17,0 cm/6³/₄"

KERN

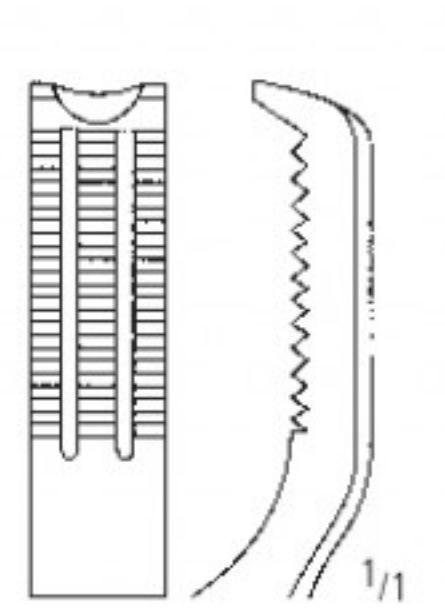

KA 760/21
 21,0 cm/8¹/₂"



SEMB
 KA 762/19
 19,0 cm/7¹/₂"

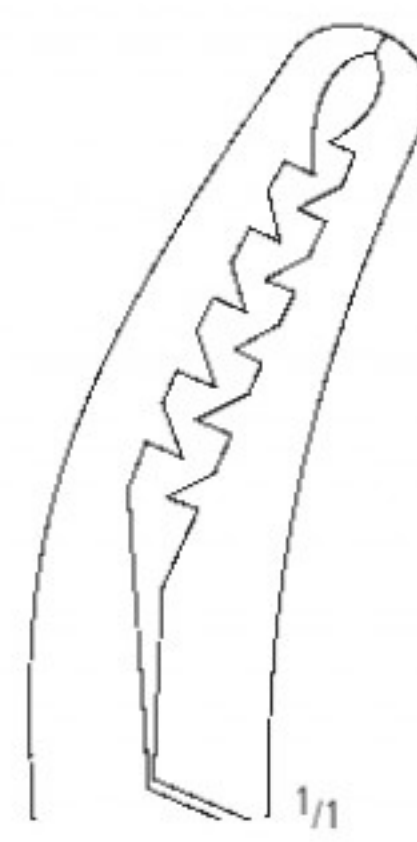
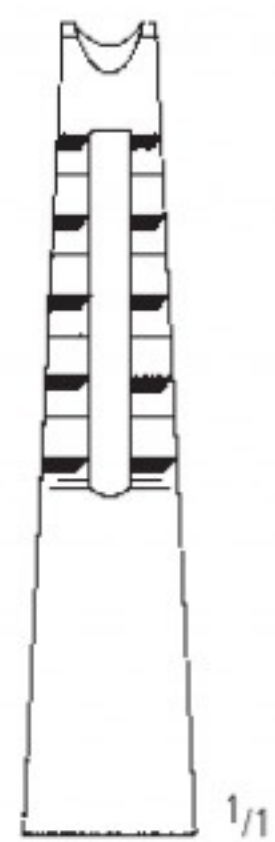

SEMB
 KA 763/19
 19,0 cm/7¹/₂"

Knochenhalte­zangen
Bone Holding Forceps
Pinzas para huesos
Daviers porte-os
Tenaglie per ossa

AA
AB
AC
AD
AE
AF
AK
AL
AM
AO
AP
AR
KA
KB
KC
KD
KU
KY



LANE

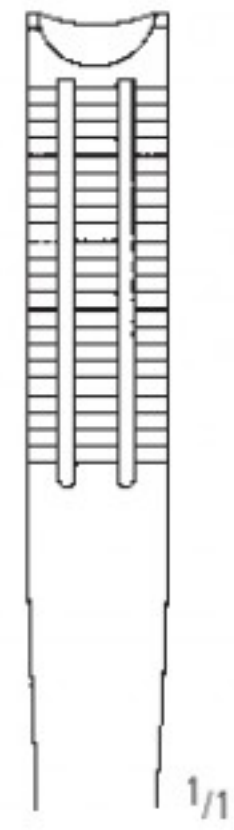

KA 766/33
33,0 cm/13"

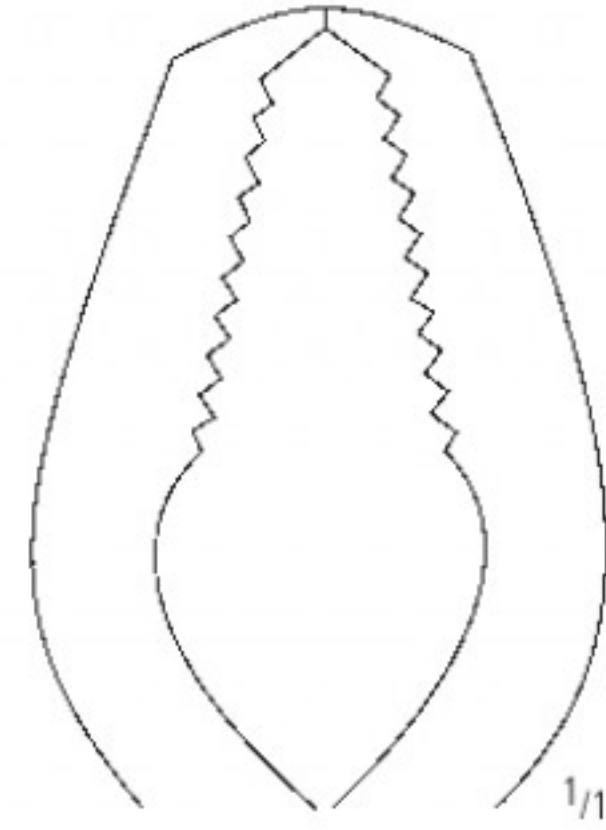

mit Sperre
with ratchet
con cremallera
avec crémaillère
con cremagliera

KA 768/33
33,0 cm/13"

ohne Sperre
without ratchet
sin cremallera
sans crémaillère
senza cremagliera

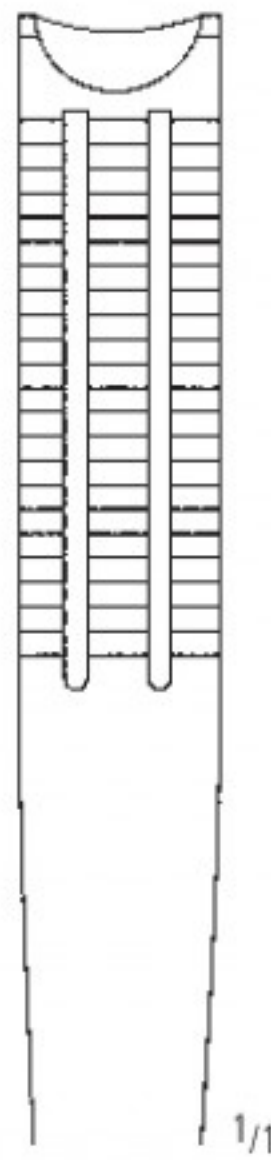

KA 768/45
45,0 cm/17³/₄"

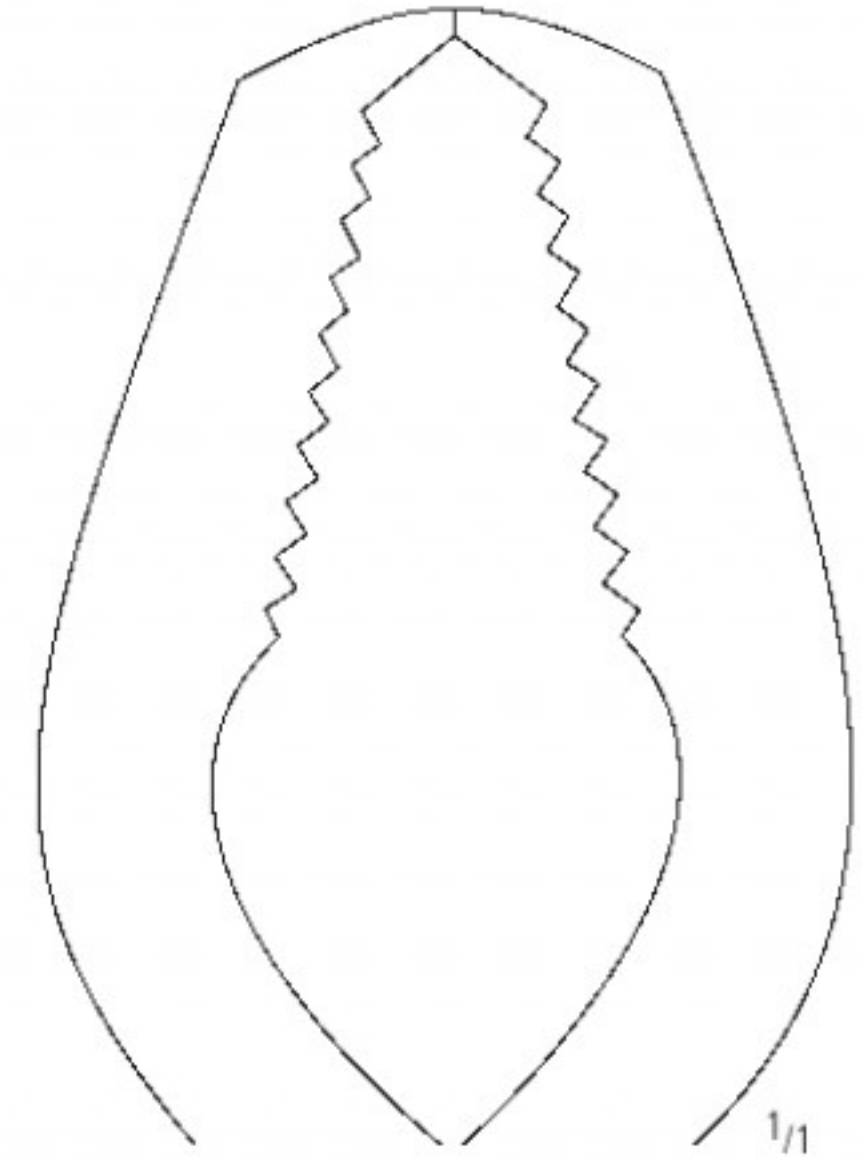

ohne Sperre
without ratchet
sin cremallera
sans crémaillère
senza cremagliera

Knochenhalte­zangen
 Bone Holding Forceps
 Pinzas para huesos
 Daviers porte-os
 Tenaglie per ossa



FARABEU­F-LAMBOTTE
 KA 769/26
 26,0 cm/10¹/₄"

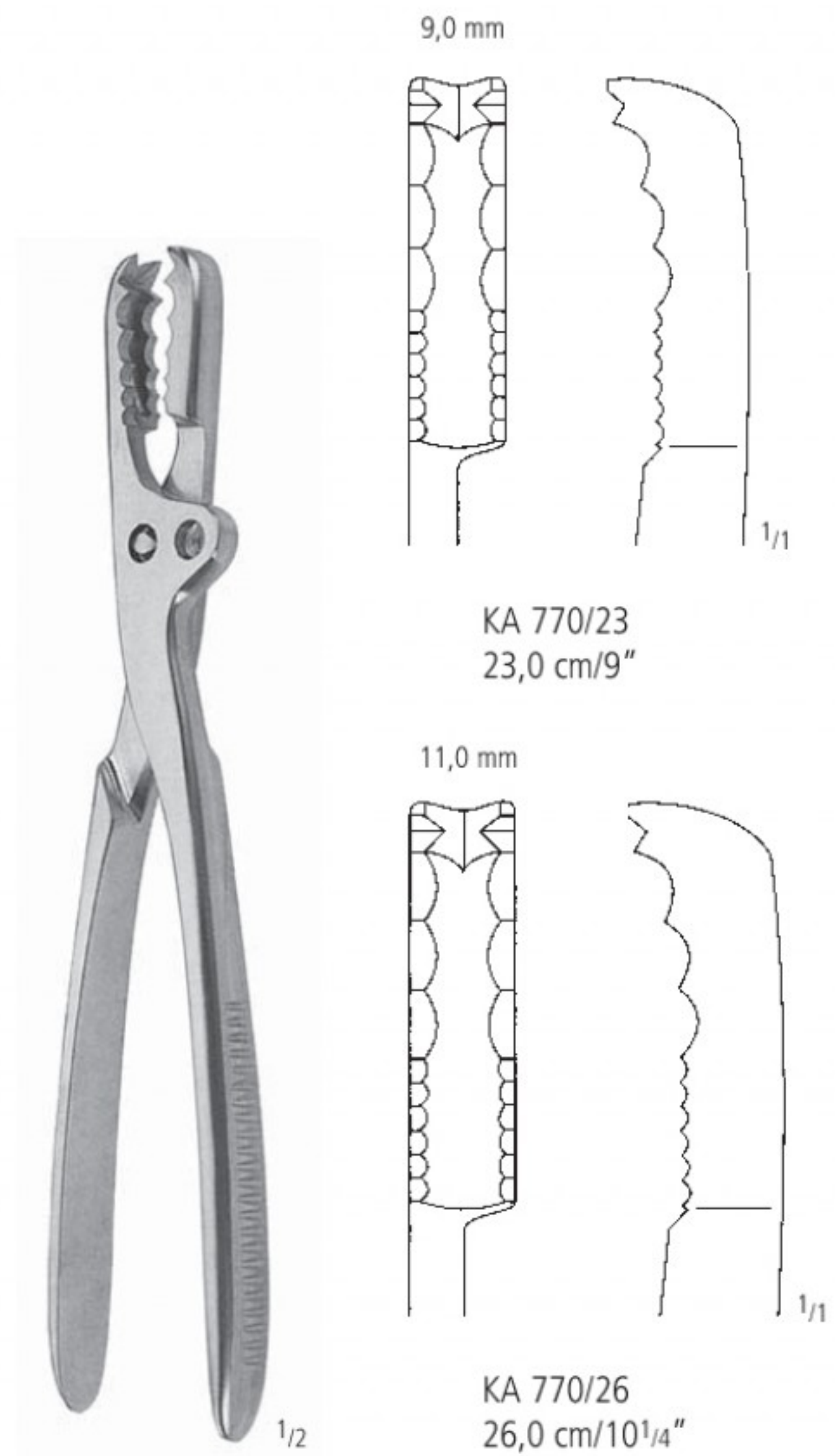

FARABEU­F

KA 770/23
 23,0 cm/9"

KA 770/26
 26,0 cm/10¹/₄"

Knochenhalte­zangen
Bone Holding Forceps
Pinzas para huesos
Daviers porte-os
Tenaglie per ossa

AA
AB
AC
AD
AE
AF
AK
AL
AM
AO
AP
AR
KA
KB
KC
KD
KU
KY



VERBRUGGE

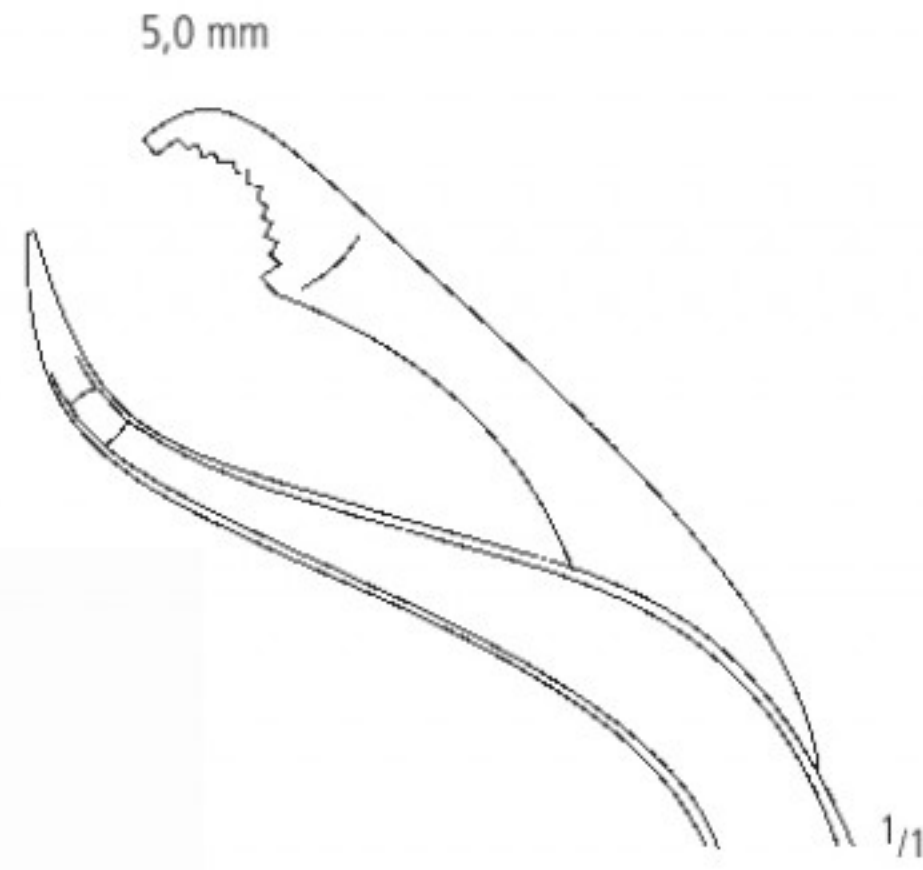

KA 771/05
17,5 cm/6³/₄"

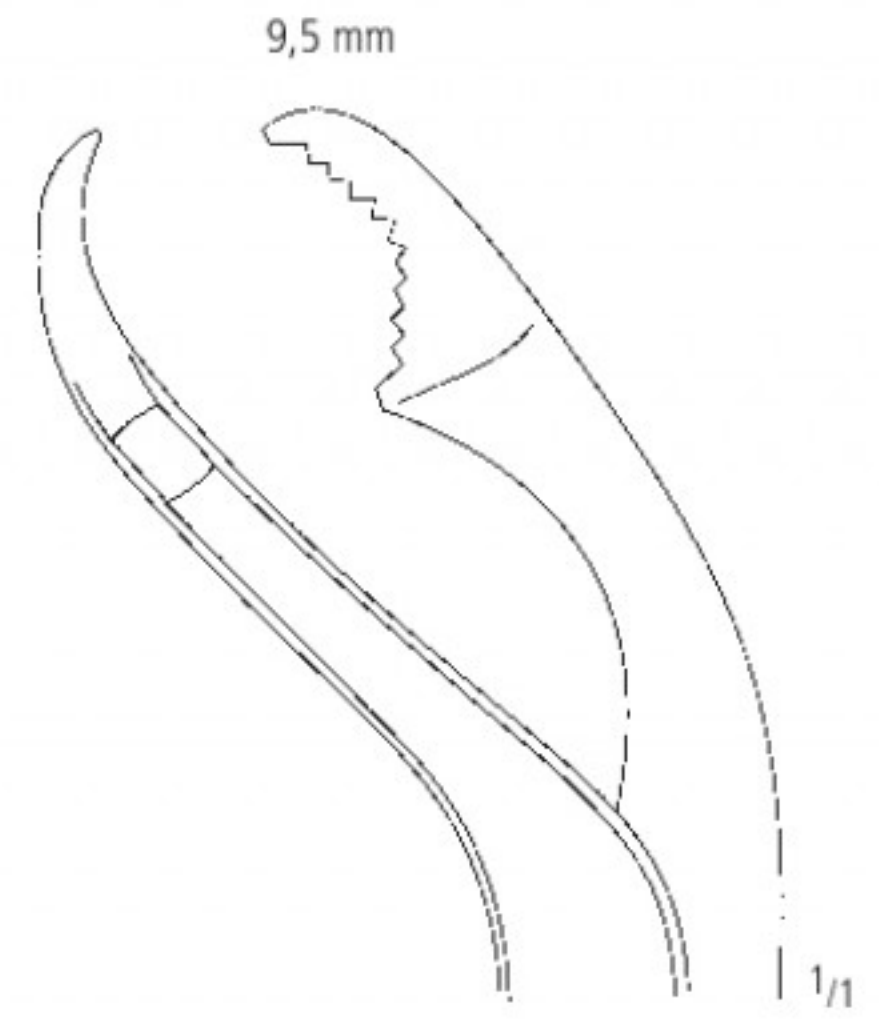

KA 771/10
25,0 cm/10"

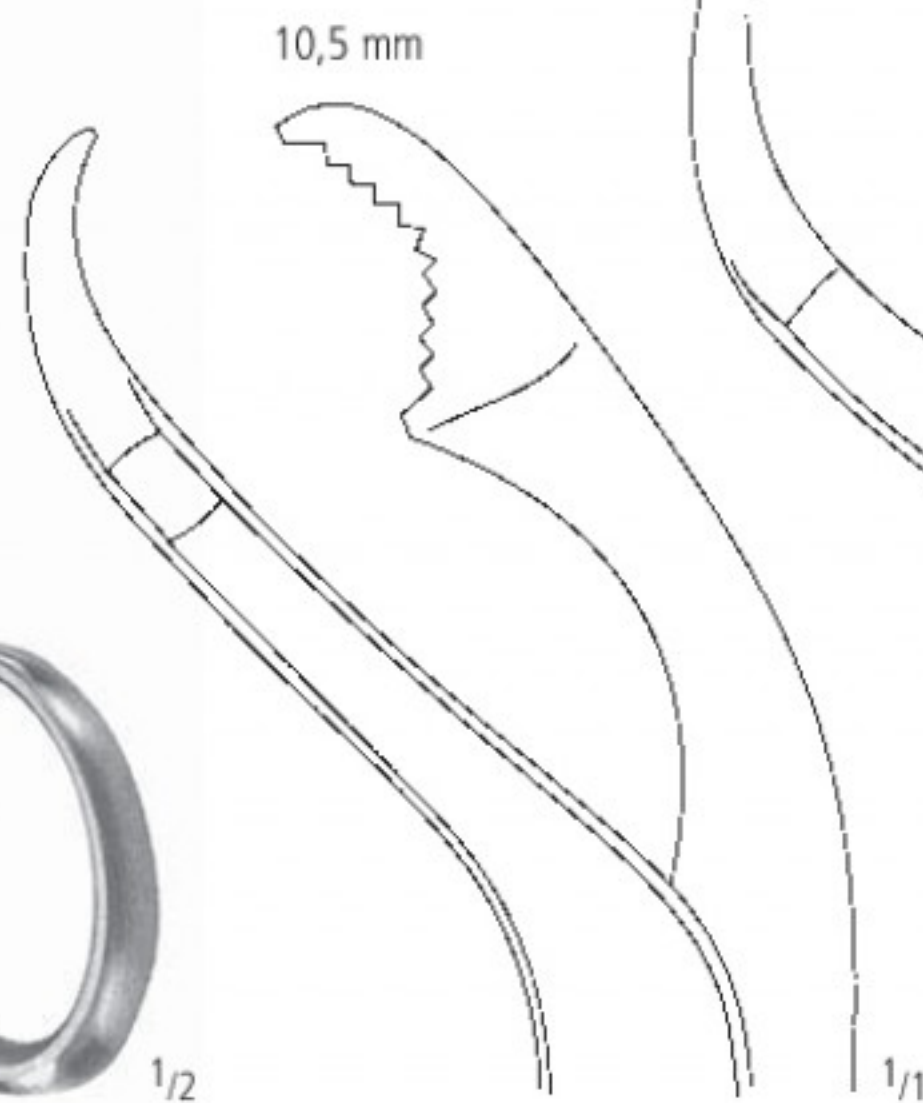

KA 771/11
26,0 cm/10¹/₄"

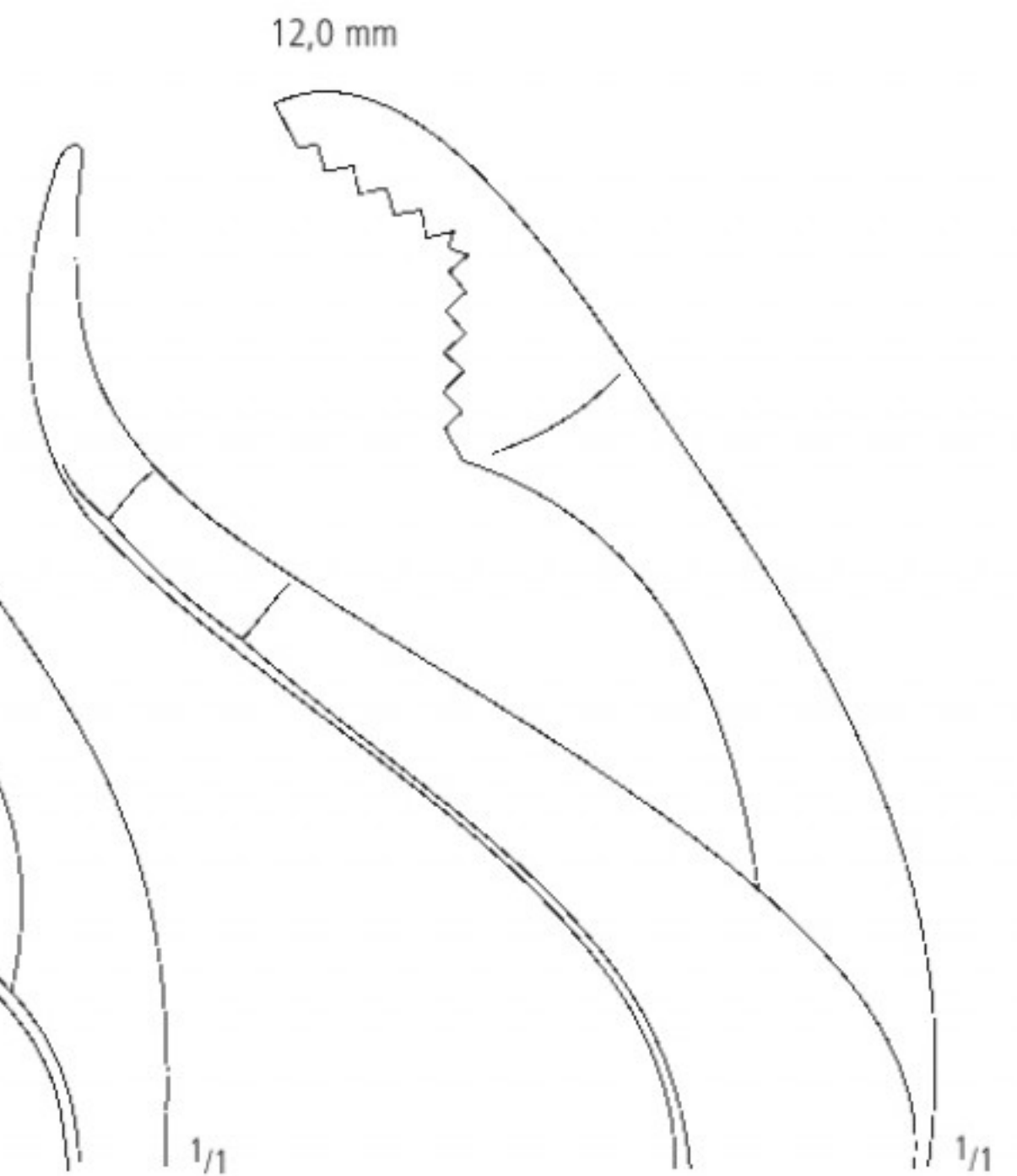

KA 771/12
27,0 cm/11"

Knochenhalte­zangen
 Bone Holding Forceps
 Pinzas para huesos
 Daviers porte-os
 Tenaglie per ossa

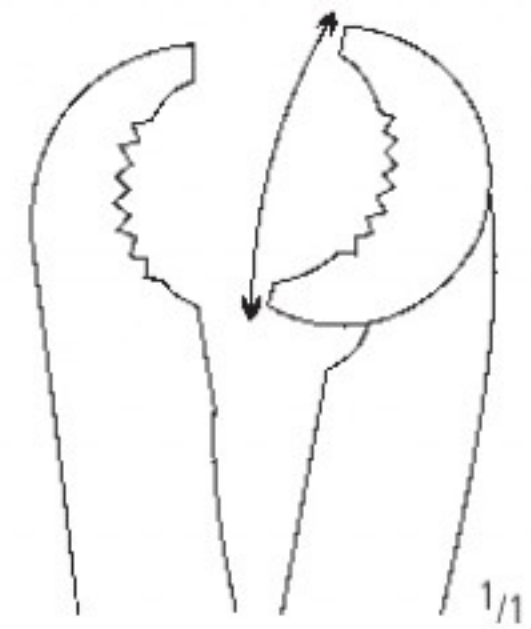
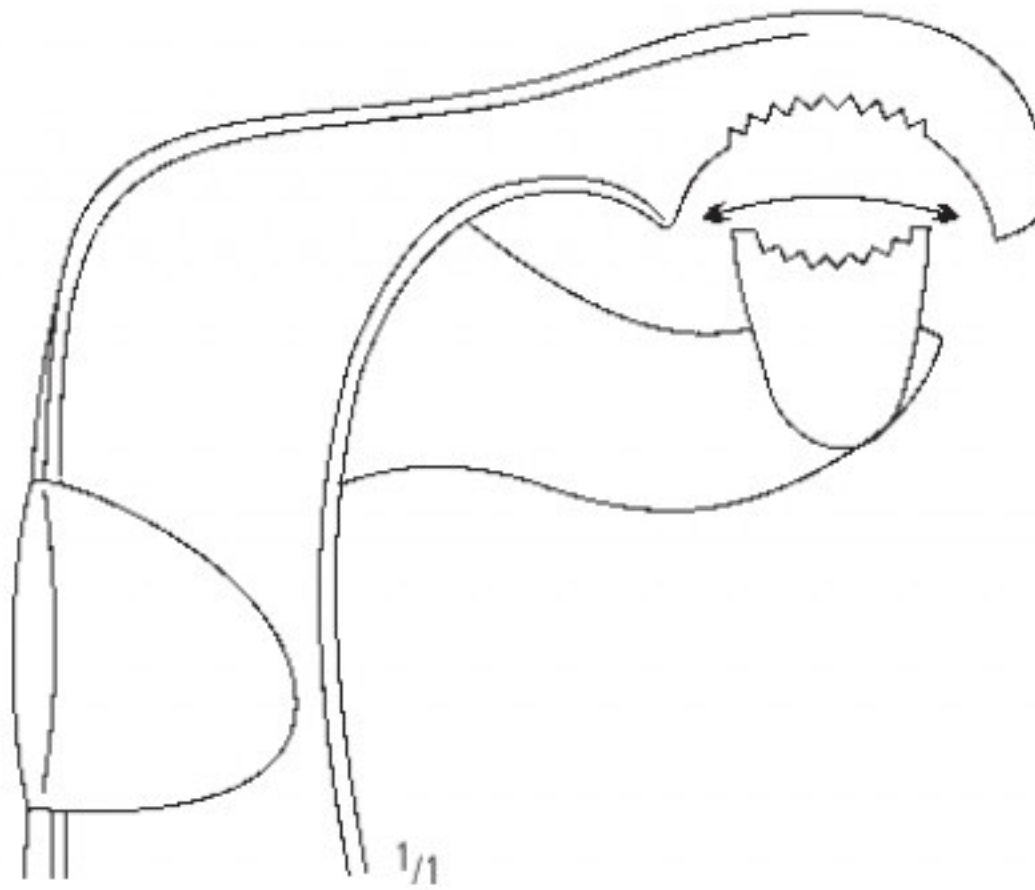
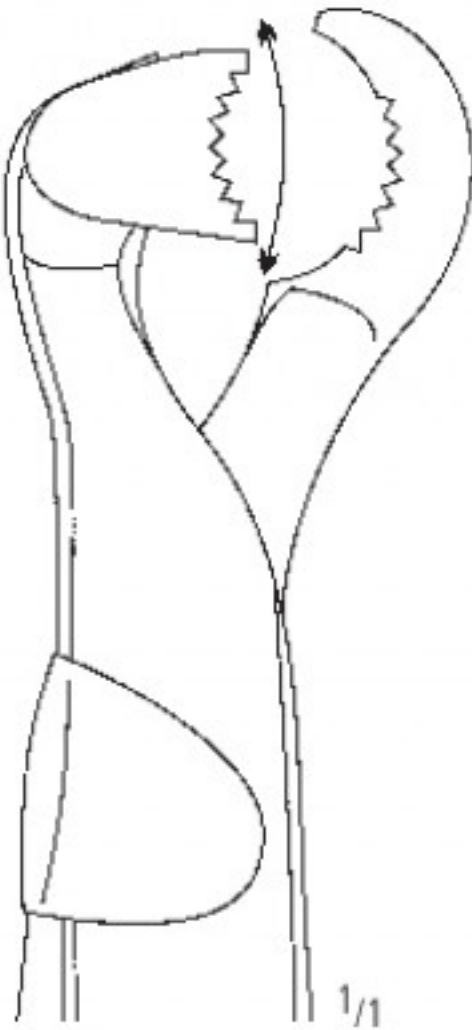

LAMBOTTE
 KA 772/22 - 22,0 cm/8³/₄"
 KA 772/26 - 26,0 cm/10¹/₄"
 KA 772/33 - 33,0 cm/13"

LAMBOTTE
 KA 773/19 - 19,0 cm/7¹/₂"
 KA 773/23 - 23,0 cm/9"
 KA 773/26 - 26,0 cm/10¹/₄"

LAMBOTTE
 KA 774/22 - 22,0 cm/8³/₄"
 KA 774/27 - 27,0 cm/10¹/₂"
 KA 774/30 - 30,0 cm/12"

Knochenhalte­zangen
 Bone Holding Forceps
 Pinzas para huesos
 Daviers porte-os
 Tenaglie per ossa

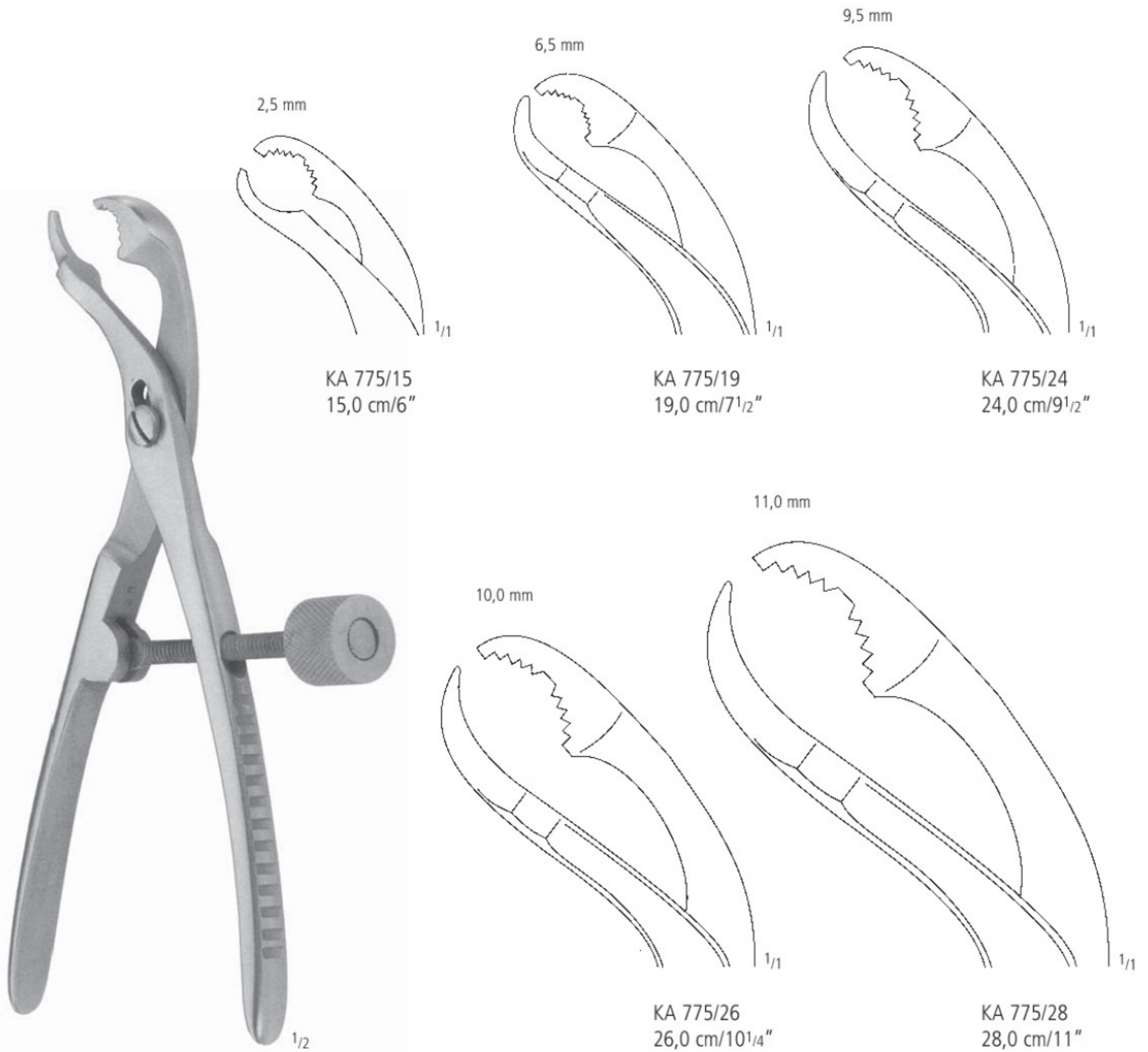

AA
 AB
 AC
 AD
 AE
 AF
 AG
 AH
 AI
 AJ
 AK
 AL
 AM
 AN
 AO
 AP
 AQ
 AR
 AS
 AT
 AU
 AV
 AW
 AX
 AY
 AZ
 BA
 BB
 BC
 BD
 BE
 BF
 BG
 BH
 BI
 BJ
 BK
 BL
 BM
 BN
 BO
 BP
 BQ
 BR
 BS
 BT
 BU
 BV
 BW
 BX
 BY
 BZ
 CA
 CB
 CC
 CD
 CE
 CF
 CG
 CH
 CI
 CJ
 CK
 CL
 CM
 CN
 CO
 CP
 CQ
 CR
 CS
 CT
 CU
 CV
 CW
 CX
 CY
 CZ
 DA
 DB
 DC
 DD
 DE
 DF
 DG
 DH
 DI
 DJ
 DK
 DL
 DM
 DN
 DO
 DP
 DQ
 DR
 DS
 DT
 DU
 DV
 DW
 DX
 DY
 DZ
 EA
 EB
 EC
 ED
 EE
 EF
 EG
 EH
 EI
 EJ
 EK
 EL
 EM
 EN
 EO
 EP
 EQ
 ER
 ES
 ET
 EU
 EV
 EW
 EX
 EY
 EZ
 FA
 FB
 FC
 FD
 FE
 FF
 FG
 FH
 FI
 FJ
 FK
 FL
 FM
 FN
 FO
 FP
 FQ
 FR
 FS
 FT
 FU
 FV
 FW
 FX
 FY
 FZ
 GA
 GB
 GC
 GD
 GE
 GF
 GG
 GH
 GI
 GJ
 GK
 GL
 GM
 GN
 GO
 GP
 GQ
 GR
 GS
 GT
 GU
 GV
 GW
 GX
 GY
 GZ
 HA
 HB
 HC
 HD
 HE
 HF
 HG
 HH
 HI
 HJ
 HK
 HL
 HM
 HN
 HO
 HP
 HQ
 HR
 HS
 HT
 HU
 HV
 HW
 HX
 HY
 HZ
 IA
 IB
 IC
 ID
 IE
 IF
 IG
 IH
 II
 IJ
 IK
 IL
 IM
 IN
 IO
 IP
 IQ
 IR
 IS
 IT
 IU
 IV
 IW
 IX
 IY
 IZ
 JA
 JB
 JC
 JD
 JE
 JF
 JG
 JH
 JI
 JJ
 JK
 JL
 JM
 JN
 JO
 JP
 JQ
 JR
 JS
 JT
 JU
 JV
 JW
 JX
 JY
 JZ
 KA
 KB
 KC
 KD
 KE
 KF
 KG
 KH
 KI
 KJ
 KK
 KL
 KM
 KN
 KO
 KP
 KQ
 KR
 KS
 KT
 KU
 KV
 KW
 KX
 KY
 KZ
 LA
 LB
 LC
 LD
 LE
 LF
 LG
 LH
 LI
 LJ
 LK
 LL
 LM
 LN
 LO
 LP
 LQ
 LR
 LS
 LT
 LU
 LV
 LW
 LX
 LY
 LZ
 MA
 MB
 MC
 MD
 ME
 MF
 MG
 MH
 MI
 MJ
 MK
 ML
 MM
 MN
 MO
 MP
 MQ
 MR
 MS
 MT
 MU
 MV
 MW
 MX
 MY
 MZ
 NA
 NB
 NC
 ND
 NE
 NF
 NG
 NH
 NI
 NJ
 NK
 NL
 NM
 NN
 NO
 NP
 NQ
 NR
 NS
 NT
 NU
 NV
 NW
 NX
 NY
 NZ
 OA
 OB
 OC
 OD
 OE
 OF
 OG
 OH
 OI
 OJ
 OK
 OL
 OM
 ON
 OO
 OP
 OQ
 OR
 OS
 OT
 OU
 OV
 OW
 OX
 OY
 OZ
 PA
 PB
 PC
 PD
 PE
 PF
 PG
 PH
 PI
 PJ
 PK
 PL
 PM
 PN
 PO
 PP
 PQ
 PR
 PS
 PT
 PU
 PV
 PW
 PX
 PY
 PZ
 QA
 QB
 QC
 QD
 QE
 QF
 QG
 QH
 QI
 QJ
 QK
 QL
 QM
 QN
 QO
 QP
 QQ
 QR
 QS
 QT
 QU
 QV
 QW
 QX
 QY
 QZ
 RA
 RB
 RC
 RD
 RE
 RF
 RG
 RH
 RI
 RJ
 RK
 RL
 RM
 RN
 RO
 RP
 RQ
 RR
 RS
 RT
 RU
 RV
 RW
 RX
 RY
 RZ
 SA
 SB
 SC
 SD
 SE
 SF
 SG
 SH
 SI
 SJ
 SK
 SL
 SM
 SN
 SO
 SP
 SQ
 SR
 SS
 ST
 SU
 SV
 SW
 SX
 SY
 SZ
 TA
 TB
 TC
 TD
 TE
 TF
 TG
 TH
 TI
 TJ
 TK
 TL
 TM
 TN
 TO
 TP
 TQ
 TR
 TS
 TT
 TU
 TV
 TW
 TX
 TY
 TZ
 UA
 UB
 UC
 UD
 UE
 UF
 UG
 UH
 UI
 UJ
 UK
 UL
 UM
 UN
 UO
 UP
 UQ
 UR
 US
 UT
 UY
 UZ
 VA
 VB
 VC
 VD
 VE
 VF
 VG
 VH
 VI
 VJ
 VK
 VL
 VM
 VN
 VO
 VP
 VQ
 VR
 VS
 VT
 VU
 VV
 VW
 VX
 VY
 VZ
 WA
 WB
 WC
 WD
 WE
 WF
 WG
 WH
 WI
 WJ
 WK
 WL
 WM
 WN
 WO
 WP
 WQ
 WR
 WS
 WT
 WU
 WV
 WW
 WX
 WY
 WZ
 XA
 XB
 XC
 XD
 XE
 XF
 XG
 XH
 XI
 XJ
 XK
 XL
 XM
 XN
 XO
 XP
 XQ
 XR
 XS
 XT
 XU
 XV
 XW
 XX
 XY
 XZ
 YA
 YB
 YC
 YD
 YE
 YF
 YG
 YH
 YI
 YJ
 YK
 YL
 YM
 YN
 YO
 YP
 YQ
 YR
 YS
 YT
 YU
 YV
 YW
 YX
 YZ
 ZA
 ZB
 ZC
 ZD
 ZE
 ZF
 ZG
 ZH
 ZI
 ZJ
 ZK
 ZL
 ZM
 ZN
 ZO
 ZP
 ZQ
 ZR
 ZS
 ZT
 ZU
 ZV
 ZW
 ZX
 ZY
 ZZ

Knochenhalte­zangen
 Bone Holding Forceps
 Pinzas para huesos
 Daviers porte-os
 Tenaglie per ossa

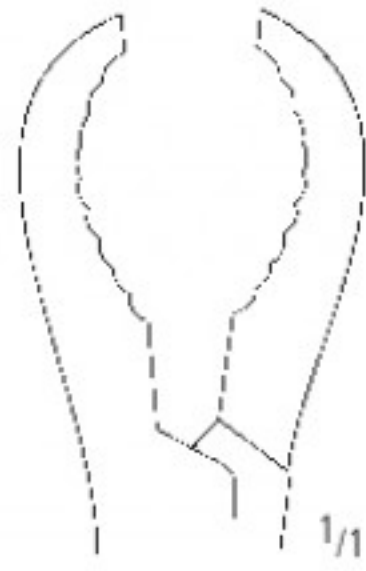

KA 777/23
 23,0 cm/9"

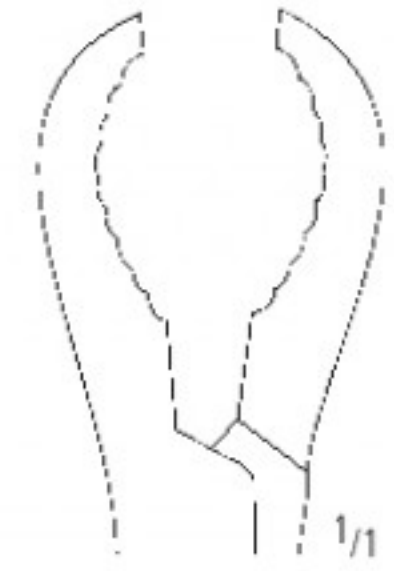

KA 778/23
 23,0 cm/9"

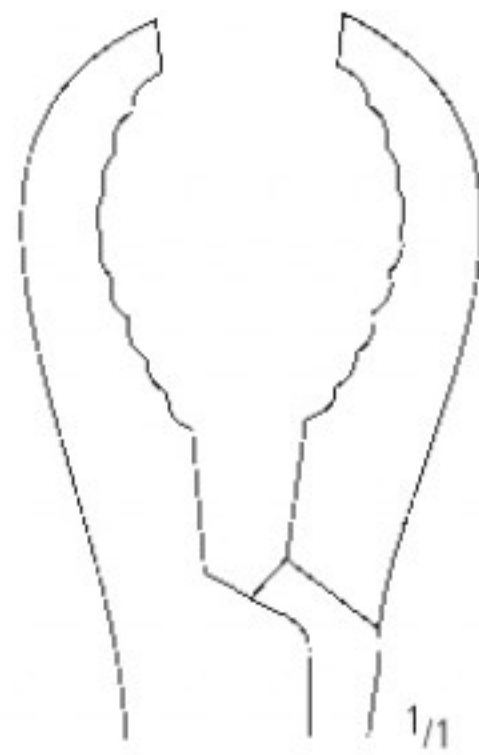

KA 777/25
 25,0 cm/10"

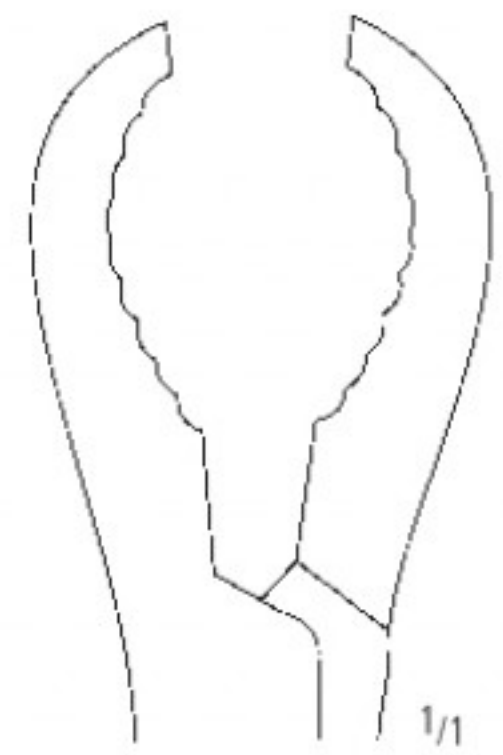

KA 778/25
 25,0 cm/10"

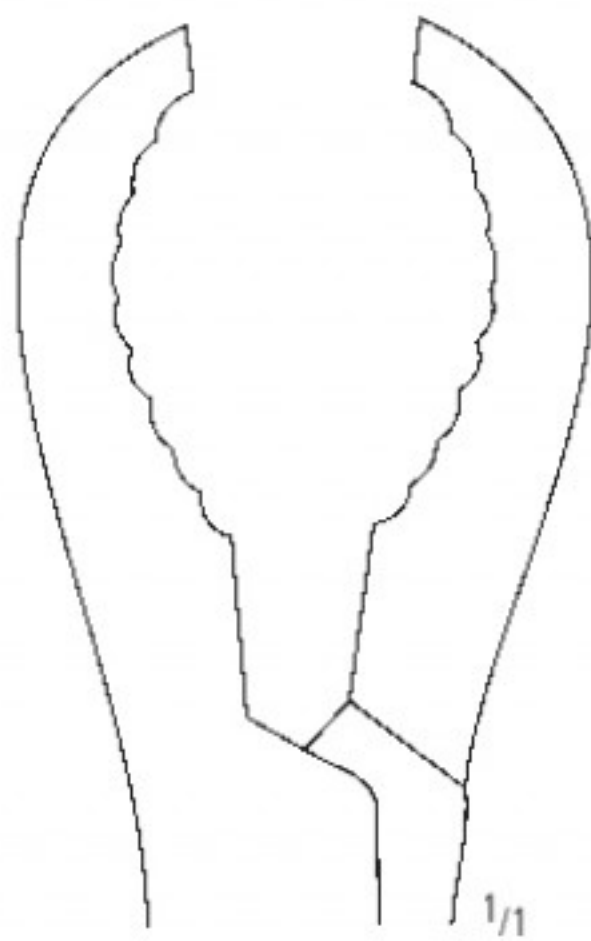

KA 777/28
 28,0 cm/11"

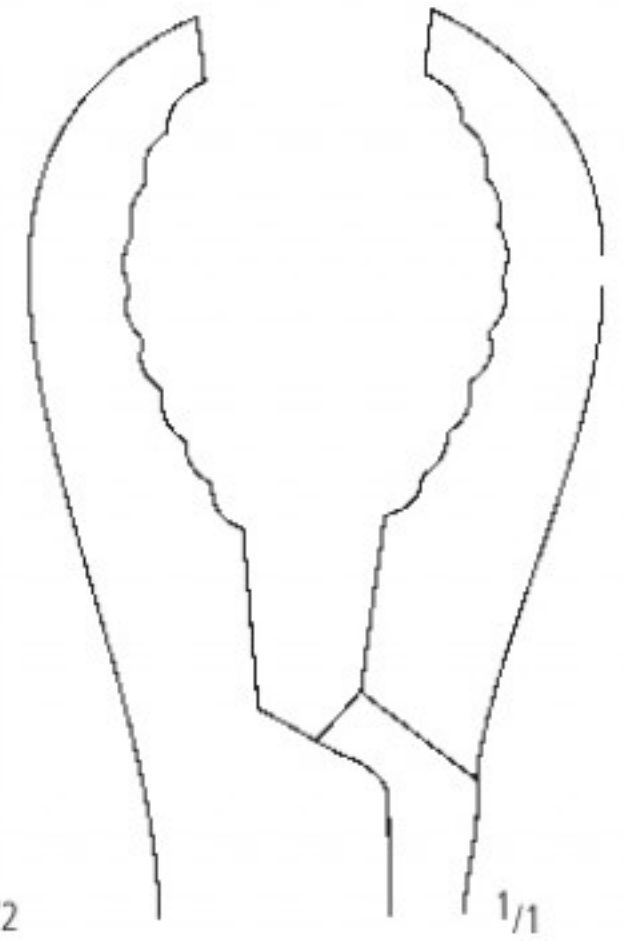

KA 778/28
 28,0 cm/11"



ULRICH



ULRICH

Amputationsschild
 Amputation Shield
 Retractor para amputación
 Retracteur pour amputation
 Retrattore per amputazione



PERCY
 KA 780/00

AA
 AB
 AC
 AD
 AE
 AF
 AK
 AL
 AM
 AO
 AP
 AR
KA
 KB
 KC
 KD
 KU
 KY

Sehnenfassinstrumente
 Tendon Seizing Instruments
 Instrumentos para coger tendones
 Instruments pour saisir les tendons
 Strumenti per afferrare tendini

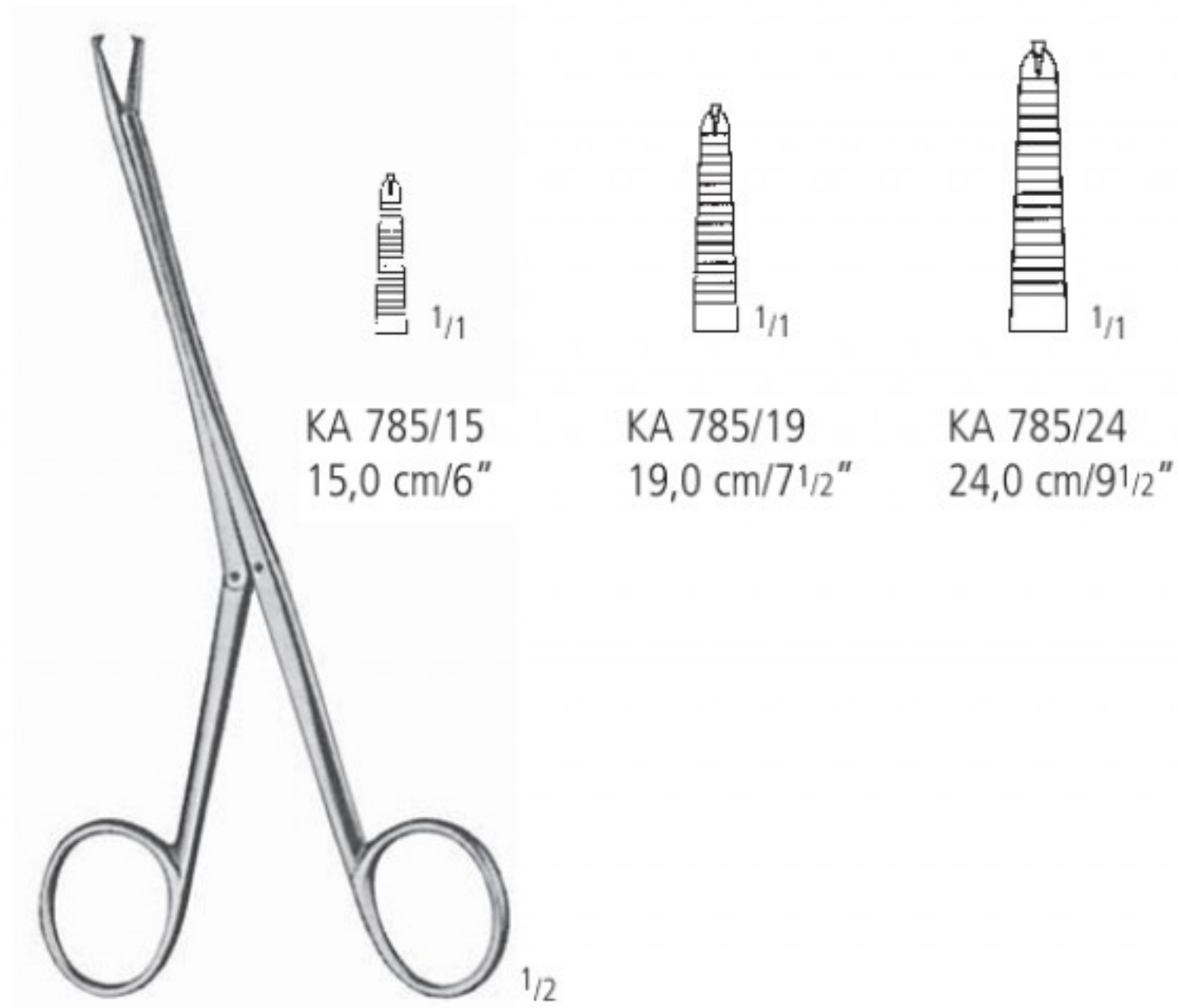

BRAND



CAROLL
 KA 786/11
 11,0 cm/4"

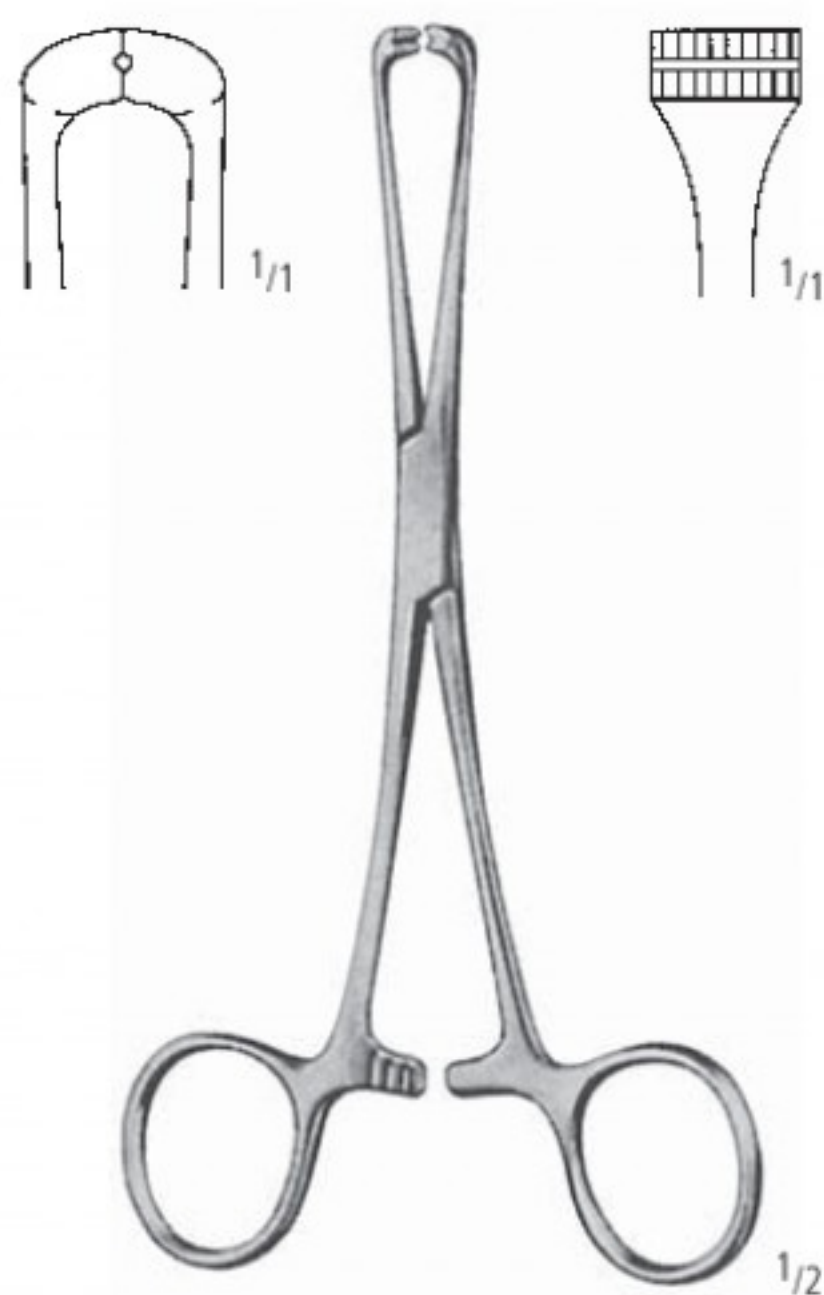

STEINMANN
 KA 787/16
 16,0 cm/6¹/₄"



KLEINERT-KUTZ
 KA 788/20
 20,0 cm/8"

Sehnenstripper
Tendon Stripper
Separadores para tendones
Instruments à écorcher les tendons
Scollatendini



biegsam
malleable
maleable
malléable
malleabile

1/2

BUNNELL
KA 790/23
23,0 cm/9"



4,0 mm
KA 791/40

4,5 mm
KA 791/45

5,5 mm
KA 791/55

1/2

23,0 cm/9"
biegsam
malleable
maleable
malléable
malleabile



KA 792/01

KA 792/02

KA 792/03

KA 792/04

KA 792/05

1/2

BUNNELL
15,0 cm/6"

AA
AB
AC
AD
AE
AF
AK
AL
AM
AO
AP
AR
KA
KB
KC
KD
KU
KY

Wund- und Meniskushaken
 Knee Retractors
 Separadores para rodilla
 Ecarteurs pour le genou
 Divaricatori per il ginocchio

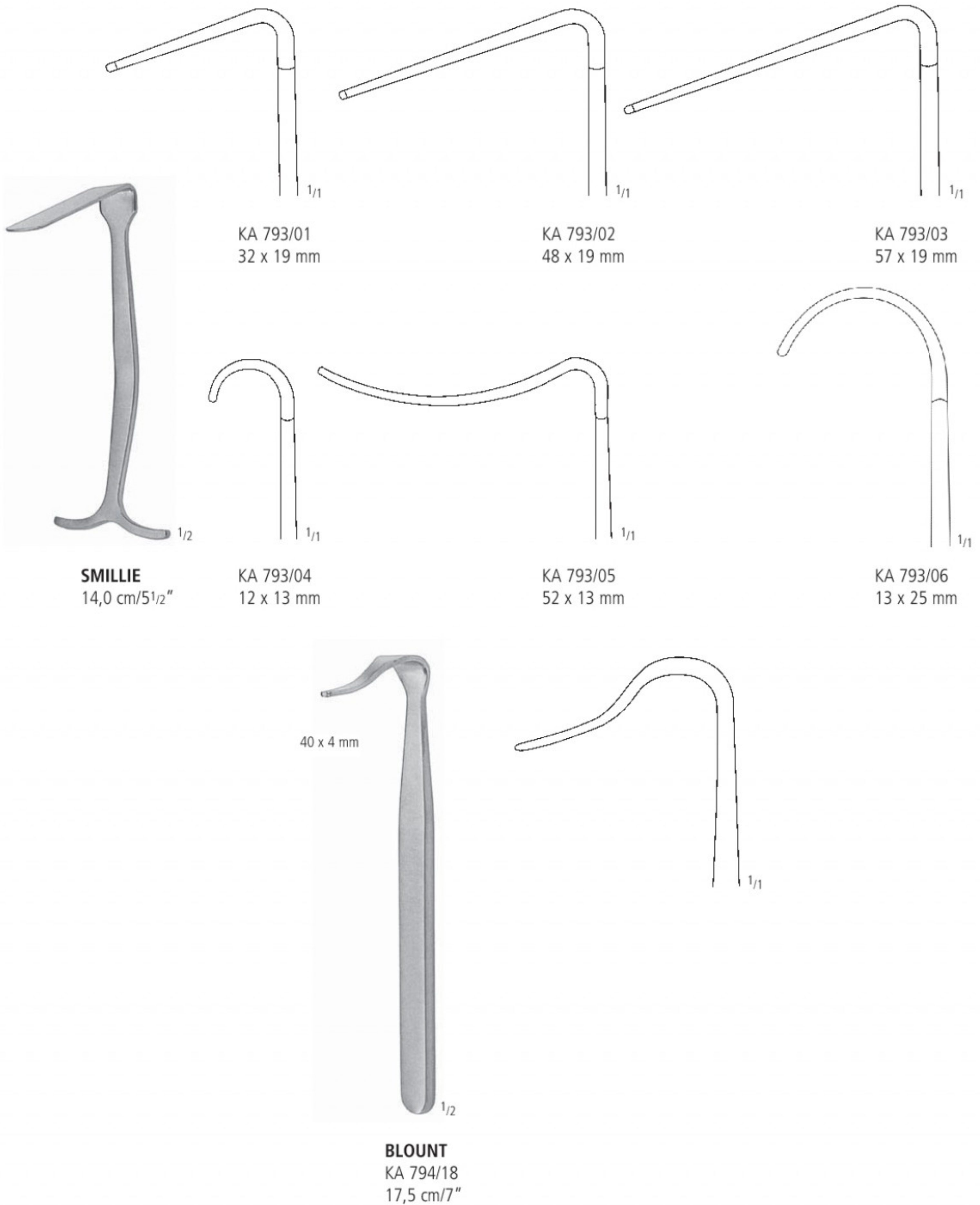

Meniskotome
Meniscotomy Knives
Bisturies para meniscos
Bistouris à ménisques
Meniscotomi

AA
AB
AC
AD
AE
AF
AK
AL
AM
AO
AP
AR
KA
KB
KC
KD
KU
KY

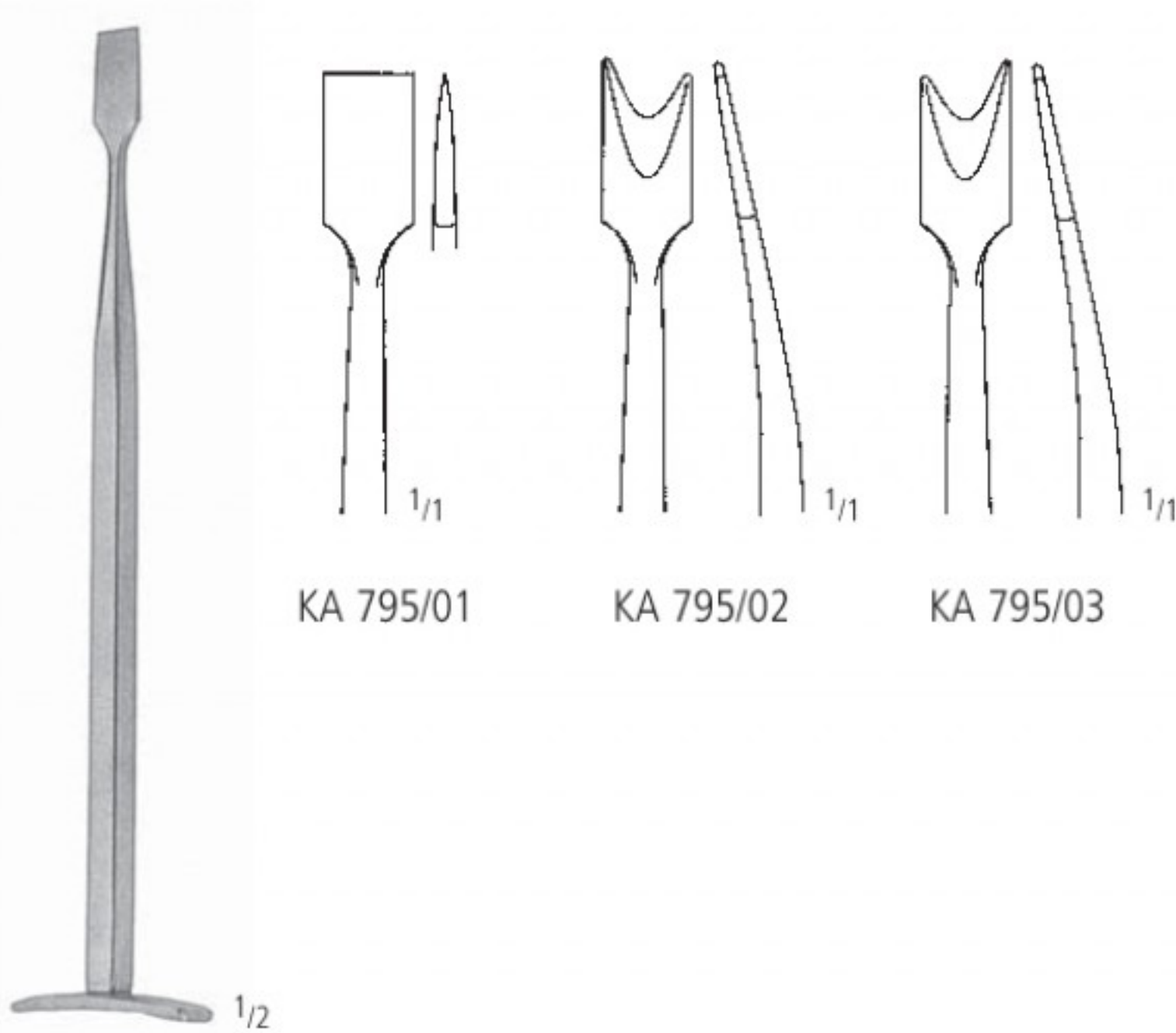

KA 795/01

KA 795/02

KA 795/03

SMILLIE
17,0 cm/6³/₄"

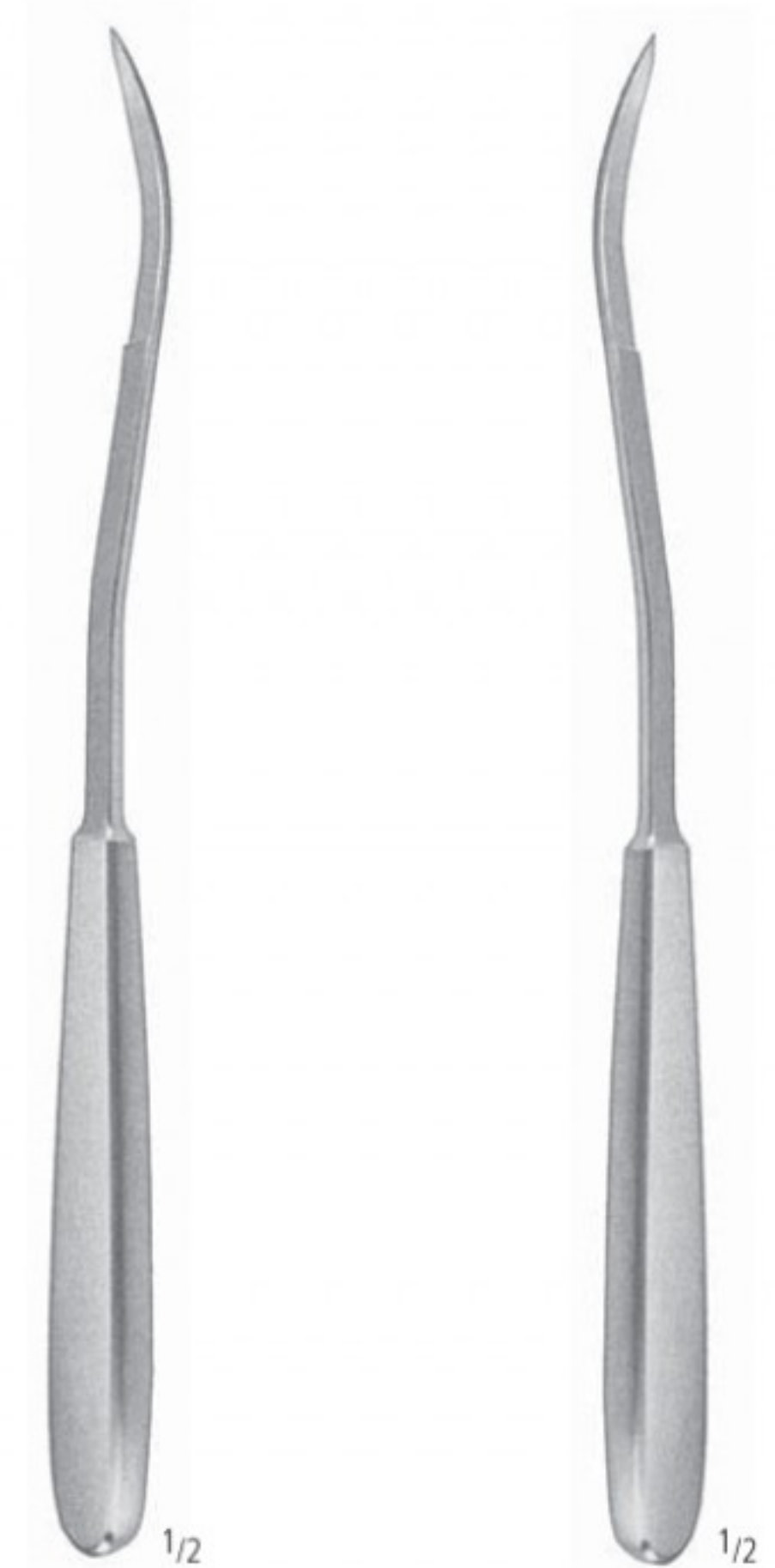

SALENIUS
KA 796/01
22,0 cm/8³/₄"

SALENIUS
KA 796/02
22,0 cm/8³/₄"

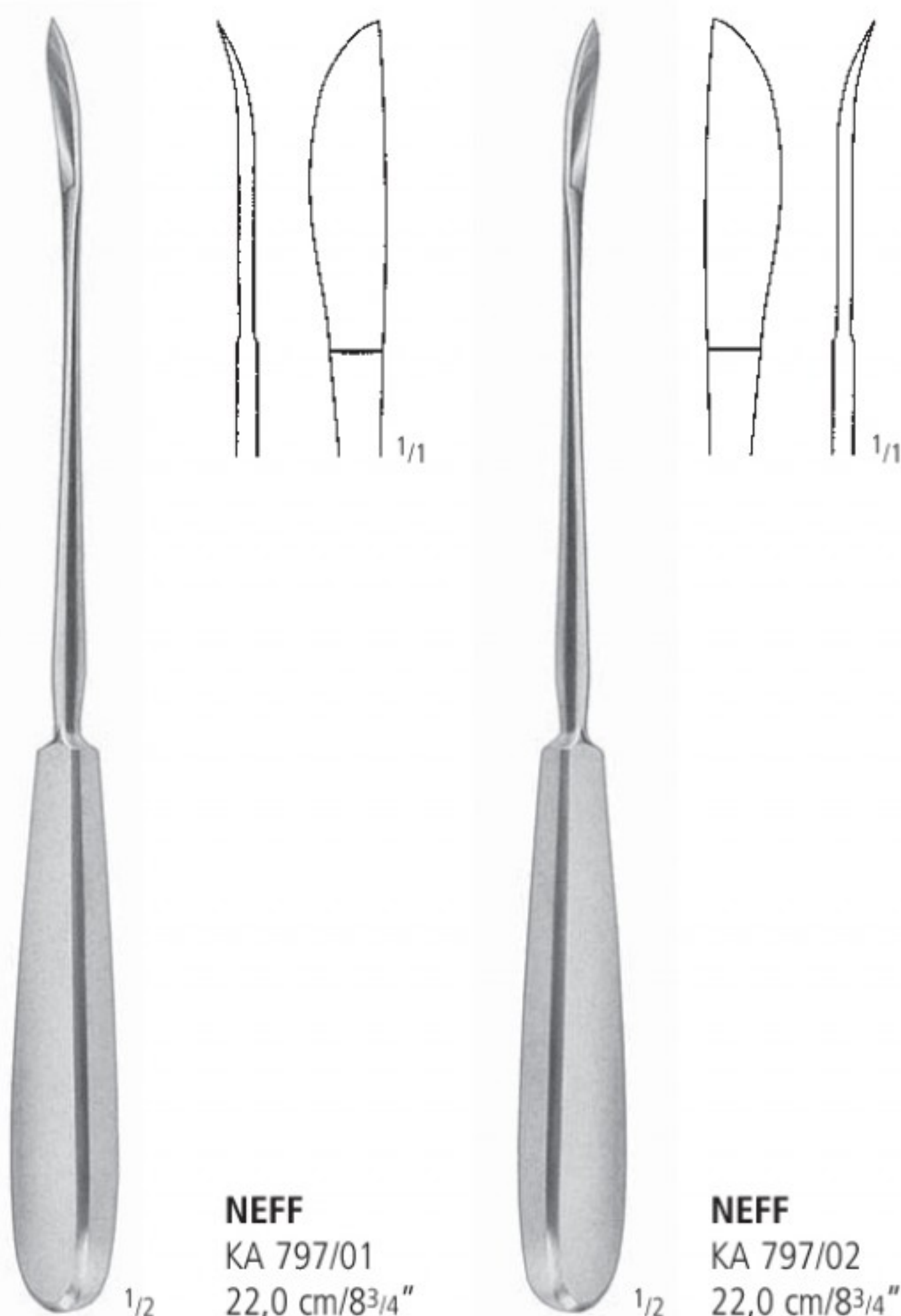

NEFF
KA 797/01
22,0 cm/8³/₄"

NEFF
KA 797/02
22,0 cm/8³/₄"

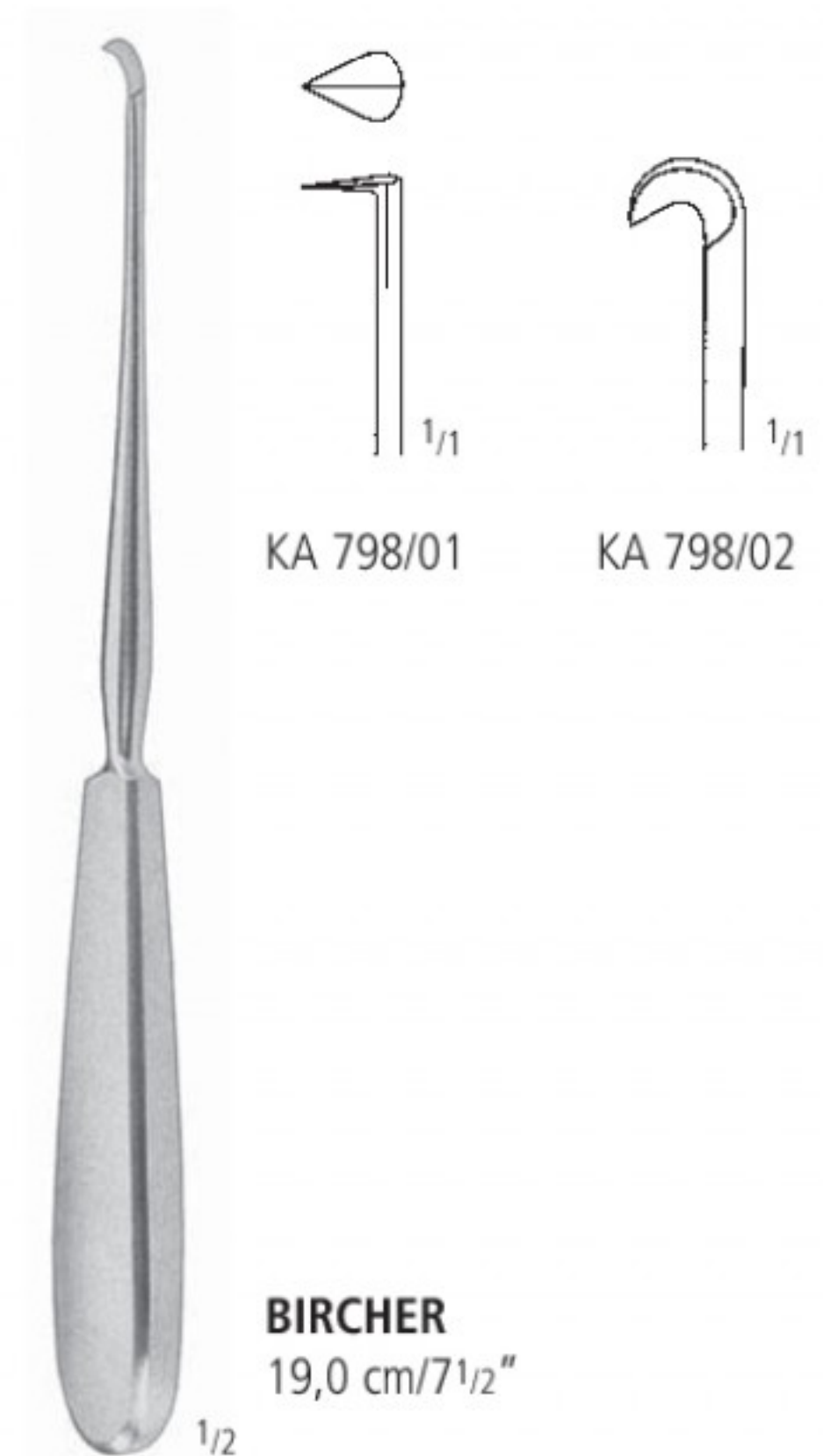

KA 798/01

KA 798/02

BIRCHER
19,0 cm/7¹/₂"

Hohlmeisselzangen
 Bone Rongeurs
 Pinzas-gubias
 Pincers-gouges
 Pinze-sgorbie

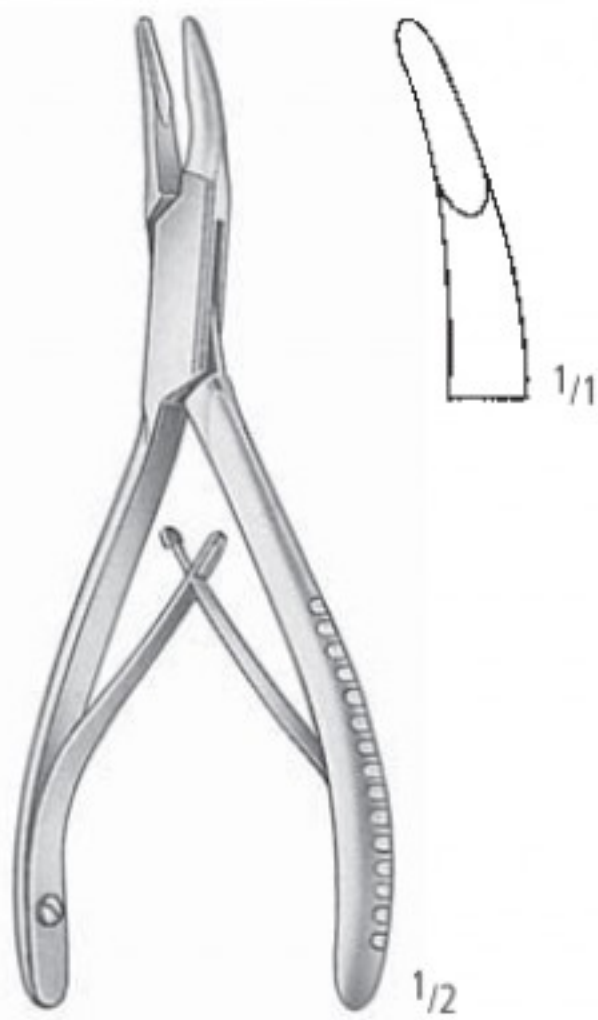

MINI-FRIEDMAN
 KA 800/12
 12,0 cm/5"

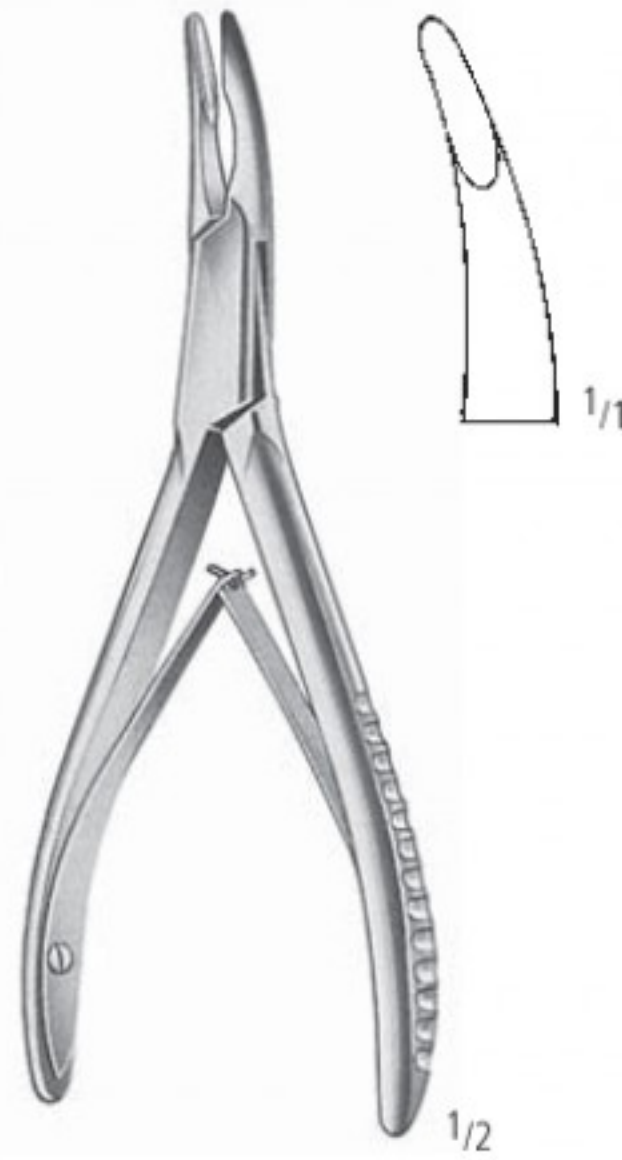

FRIEDMAN
 KA 800/14
 14,0 cm/5 1/2"

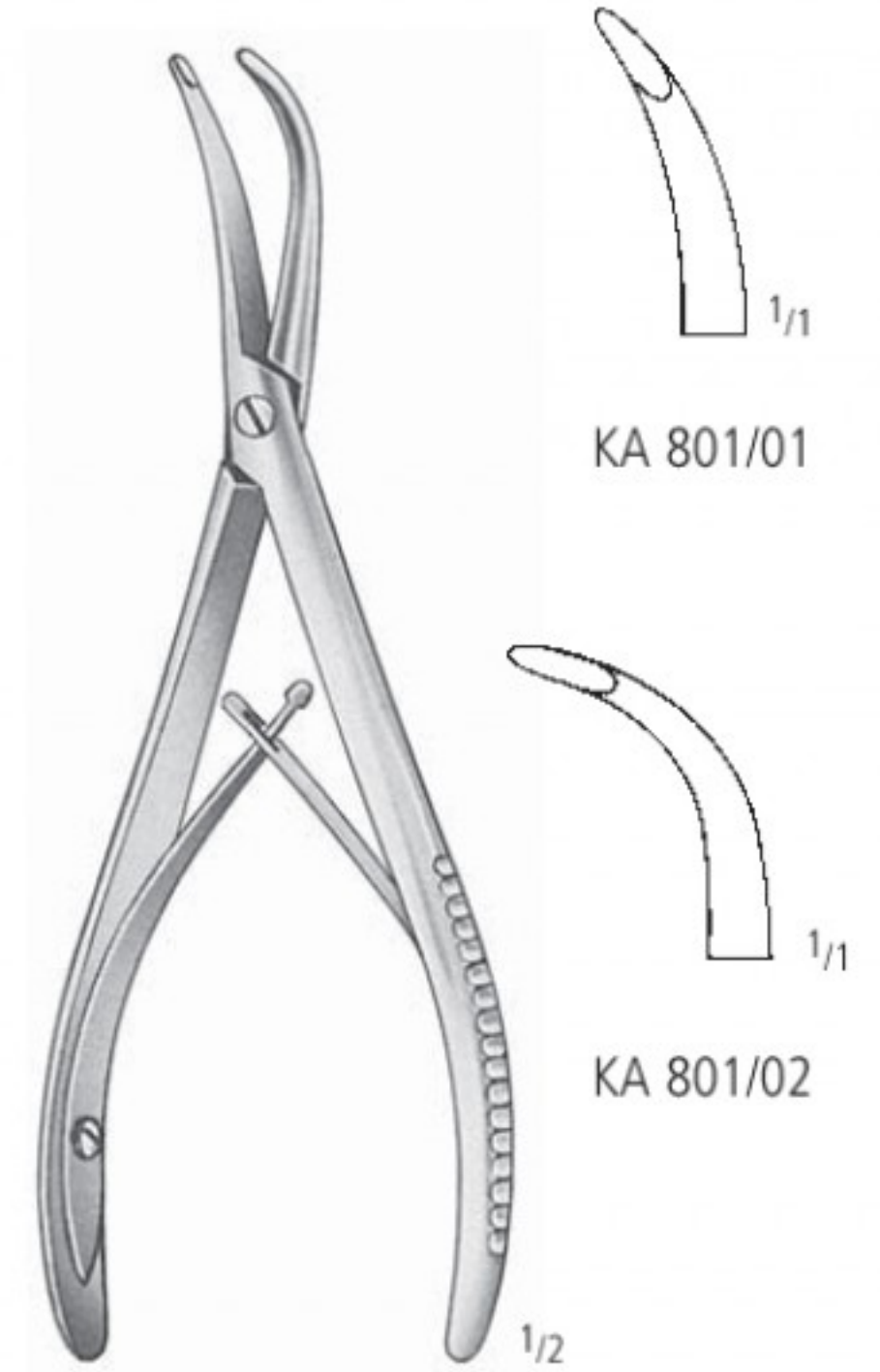

STELLBRINK
 17,0 cm/6 3/4"

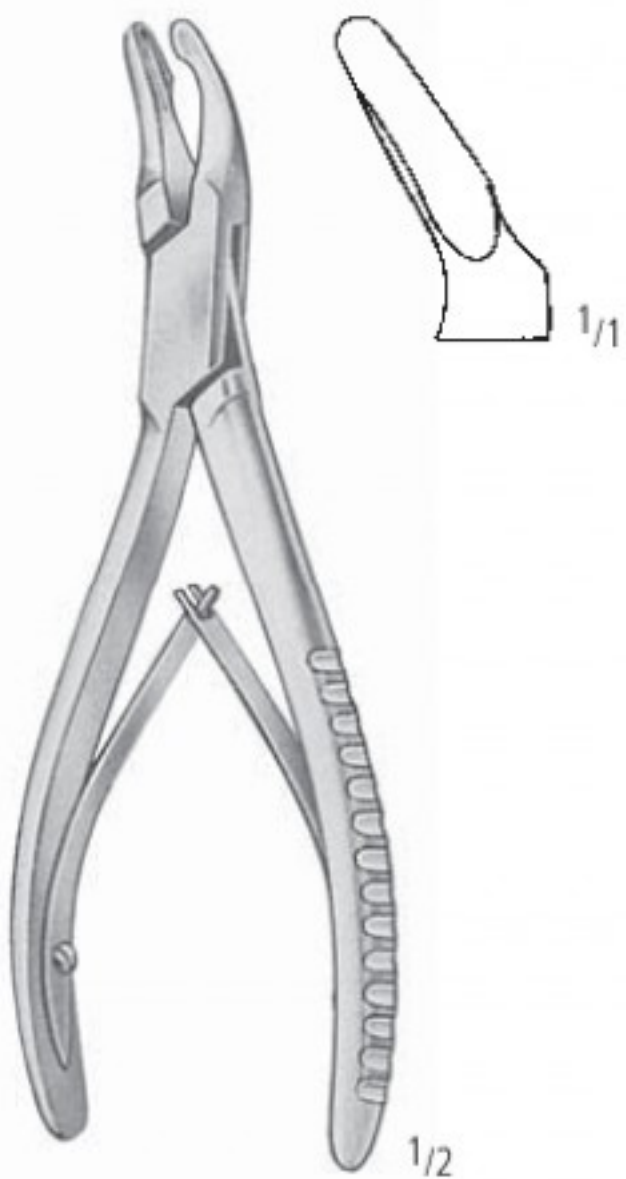

CLEVELAND
 KA 802/14
 14,0 cm/5 1/2"

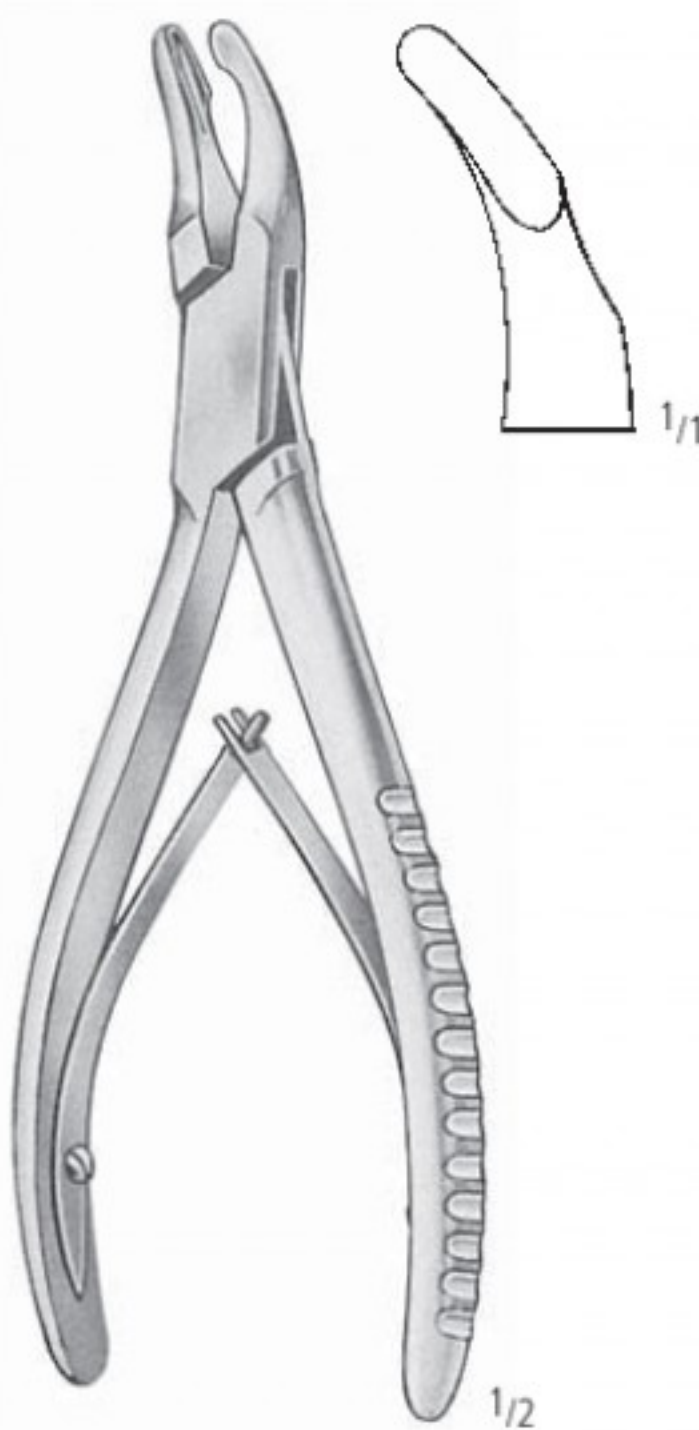

CLEVELAND
 KA 802/17
 17,0 cm/6 3/4"

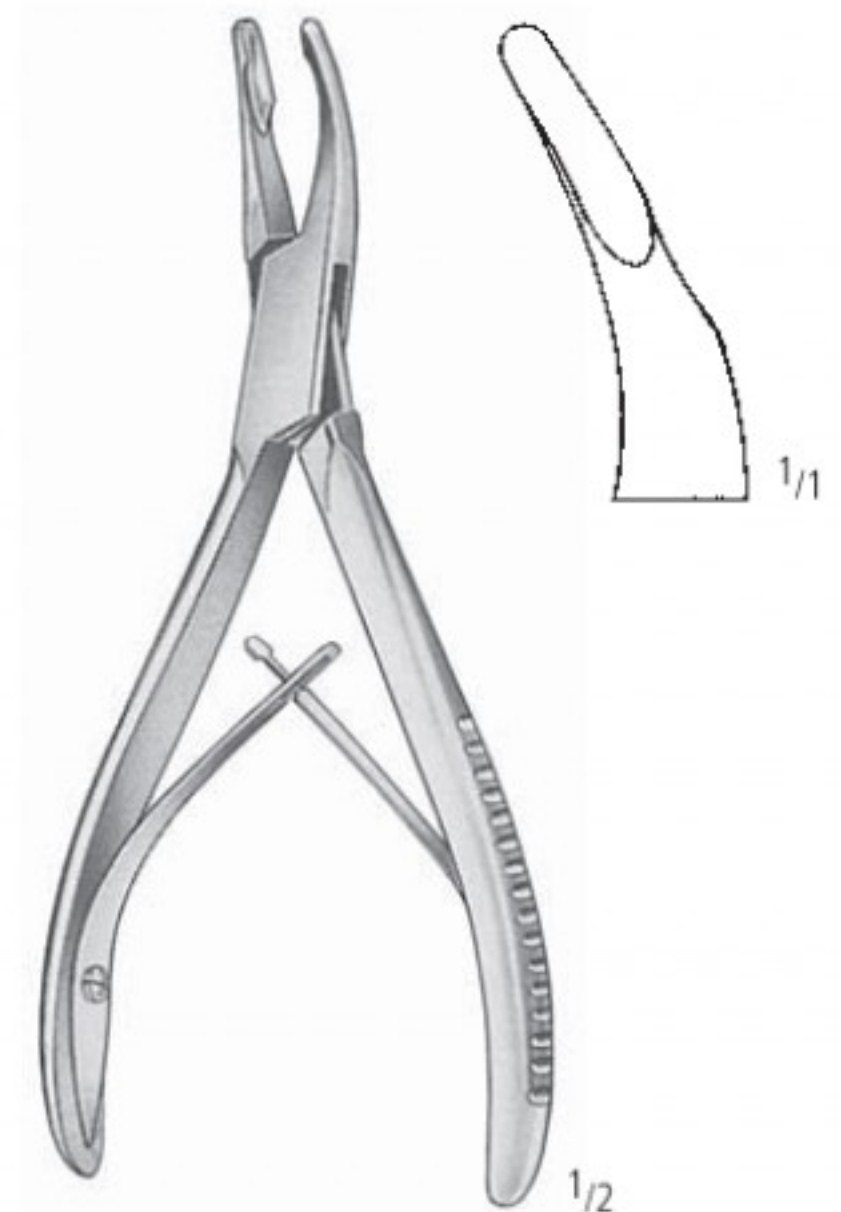

UNIVERSAL
 KA 803/13
 13,5 cm/5 1/4"

ORTHOPÄDIE ORTHOPAEDIC ORTOPEDIA ORTHOPEDIE ORTOPEDIA

Hohlmeisselzangen
 Bone Rongeurs
 Pinzas-gubias
 Pincis-gouges
 Pinze-sgorbie

AA
AB
AC
AD
AE
AF
AK
AL
AM
AO
AP
AR
KA
KB
KC
KD
KU
KY

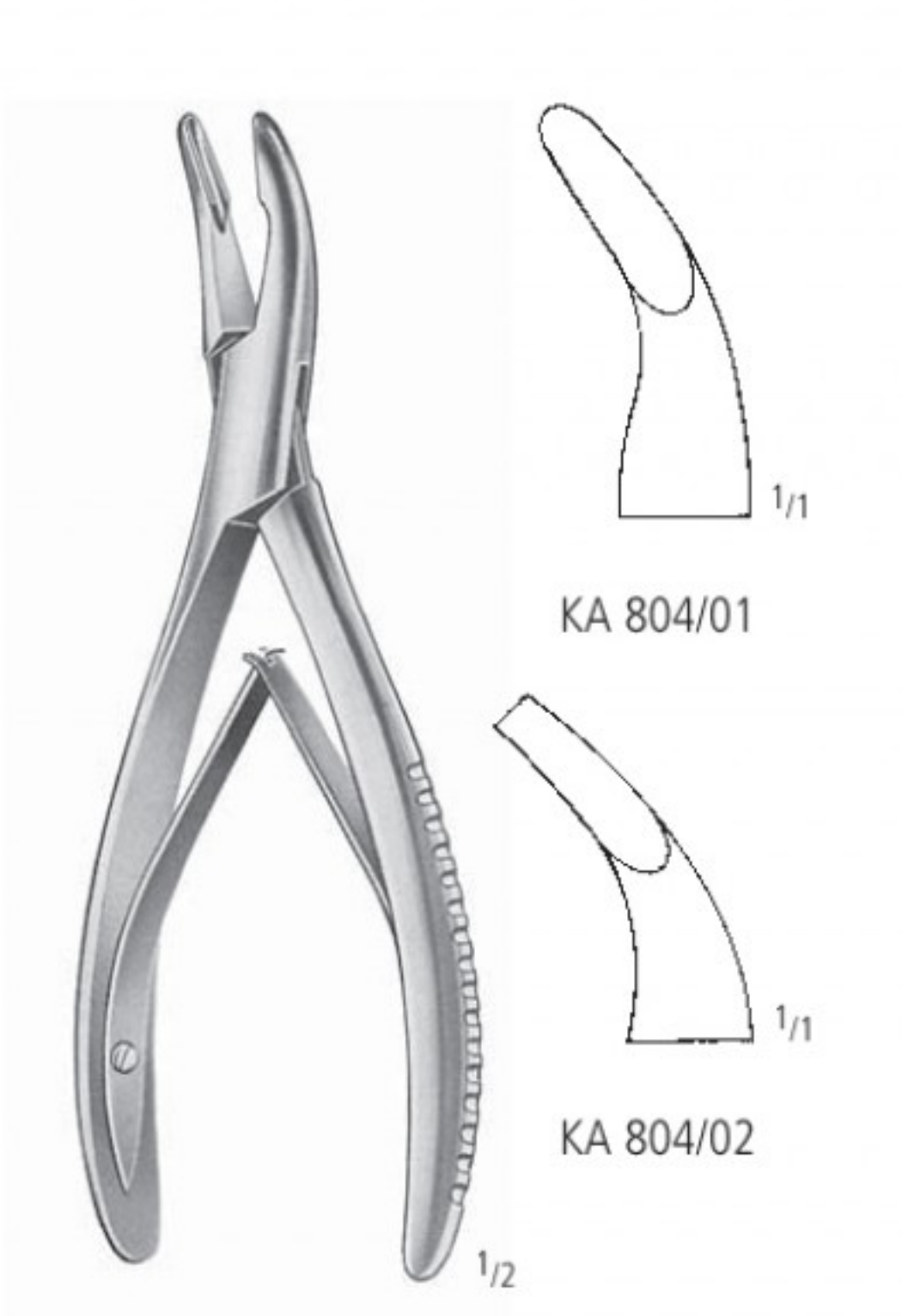

MEAD
 16,5 cm/6 1/2"

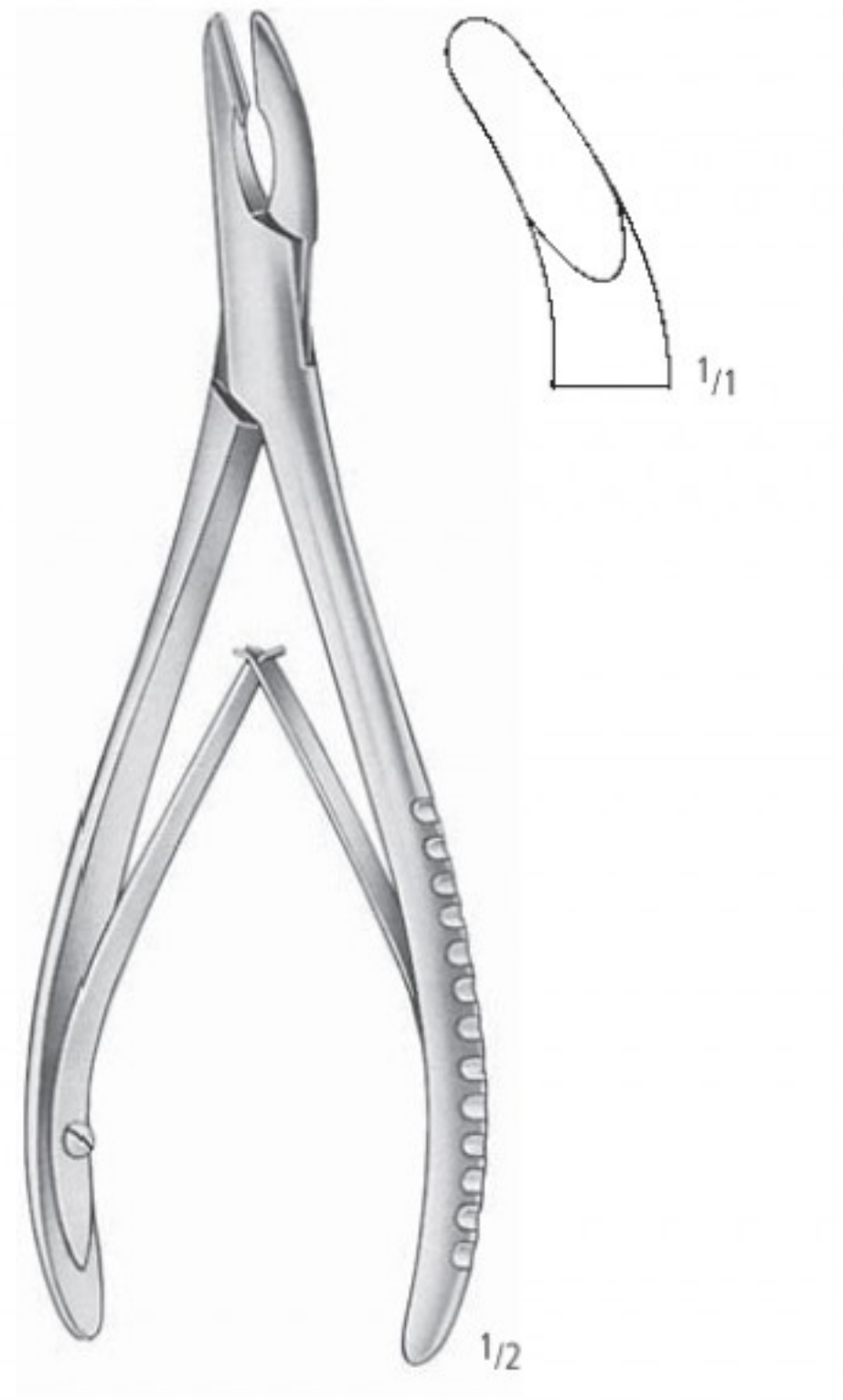

HARTMANN
 KA 807/18
 18,5 cm/7 1/3"

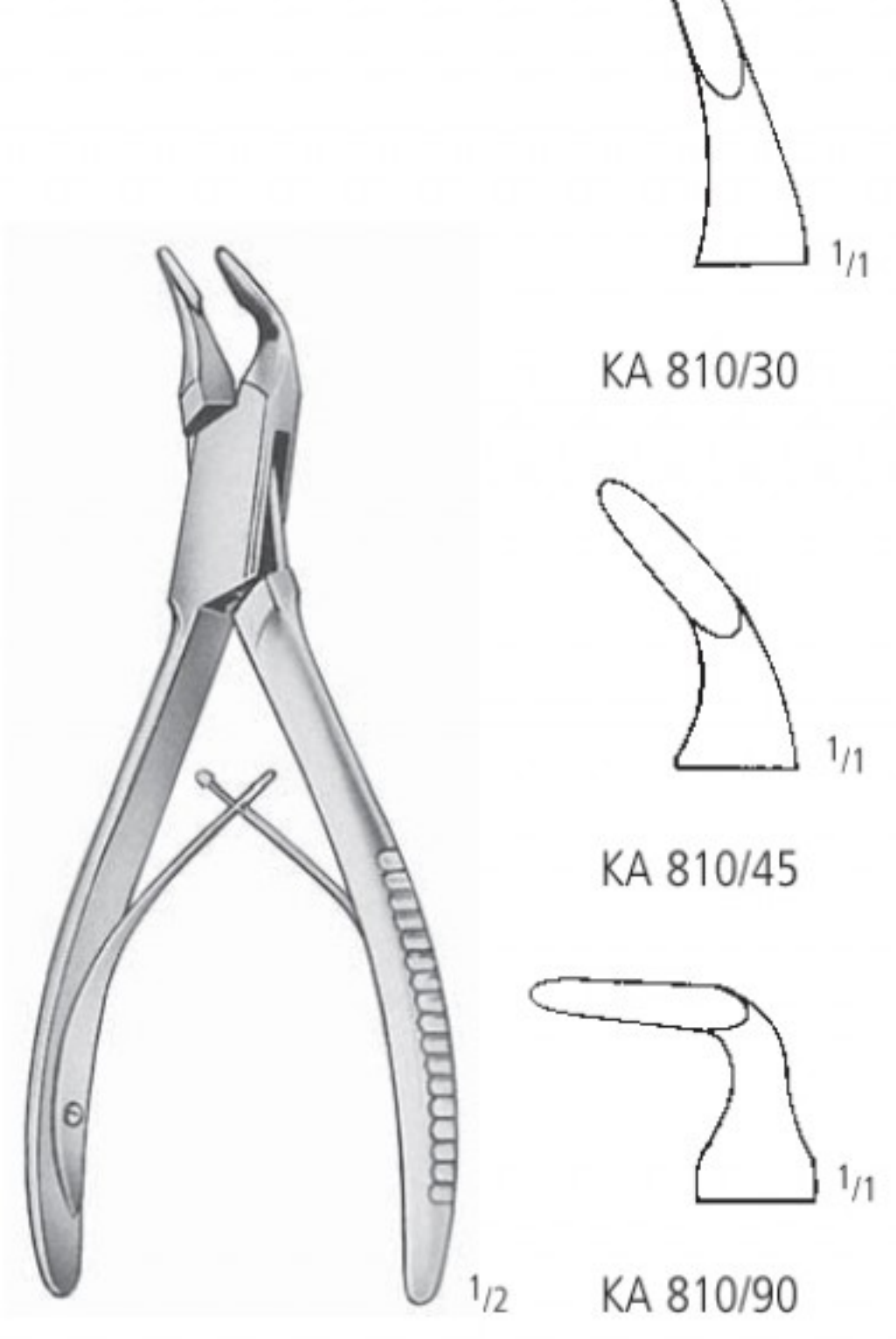

BLUMENTHAL
 15,5 cm/6"



LUER
 17,0 cm/6 3/4"

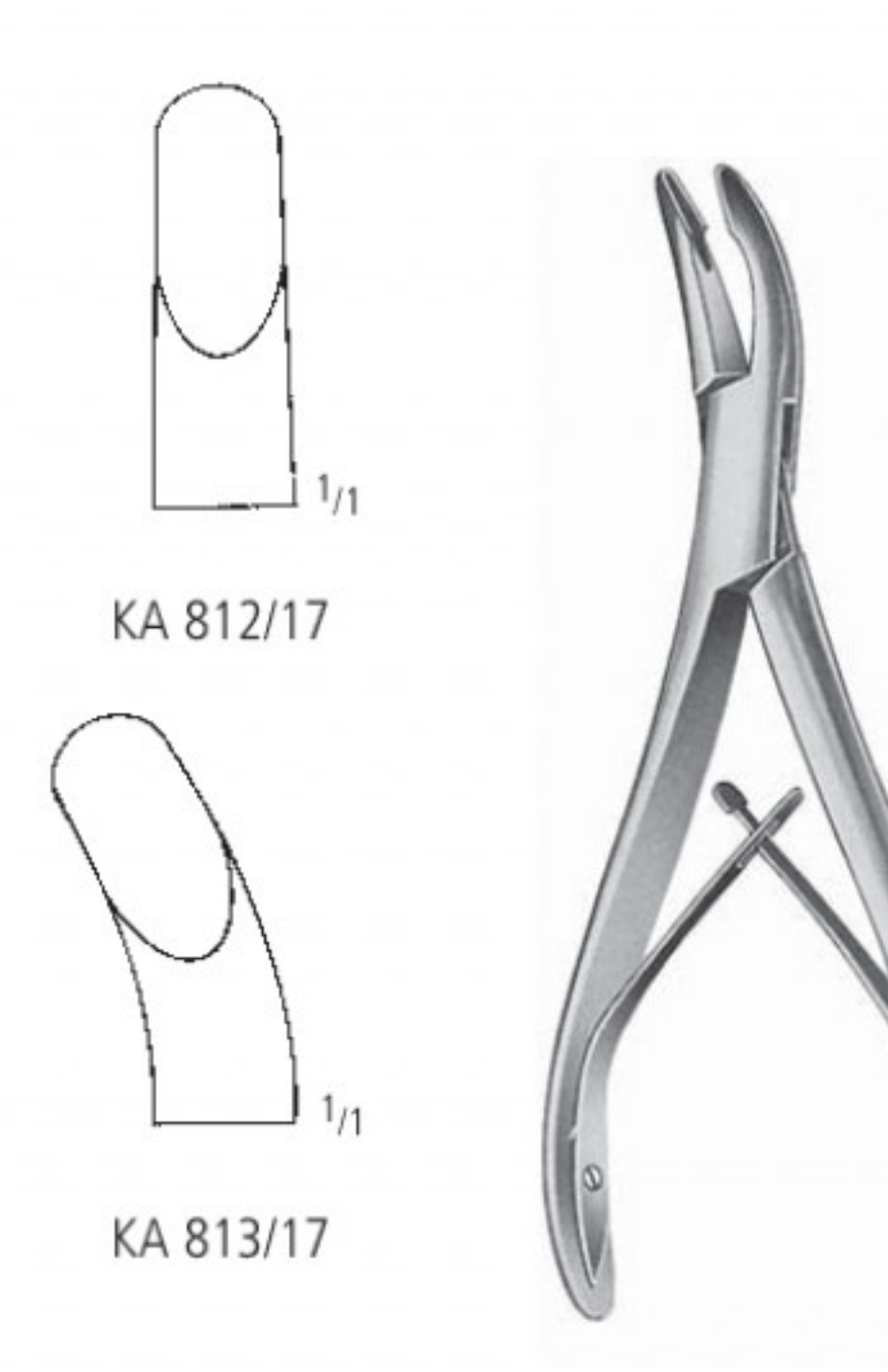

LUER
 15,0 cm/6"

Hohlmeisselzangen
 Bone Rongeurs
 Pinzas-gubias
 Pincas-gouges
 Pinze-sgorbie



LEMPERT
 KA 816/19
 19,0 cm/7¹/₂"



BACON
 KA 819/20
 20,0 cm/8"



MARQUARDT
 KA 821/20
 20,0 cm/8"



MAYFIELD
 KA 823/17
 17,0 cm/6³/₄"

Hohlmeisselzangen
 Bone Rongeurs
 Pinzas-gubias
 Pincis-gouges
 Pinze-sgorbie

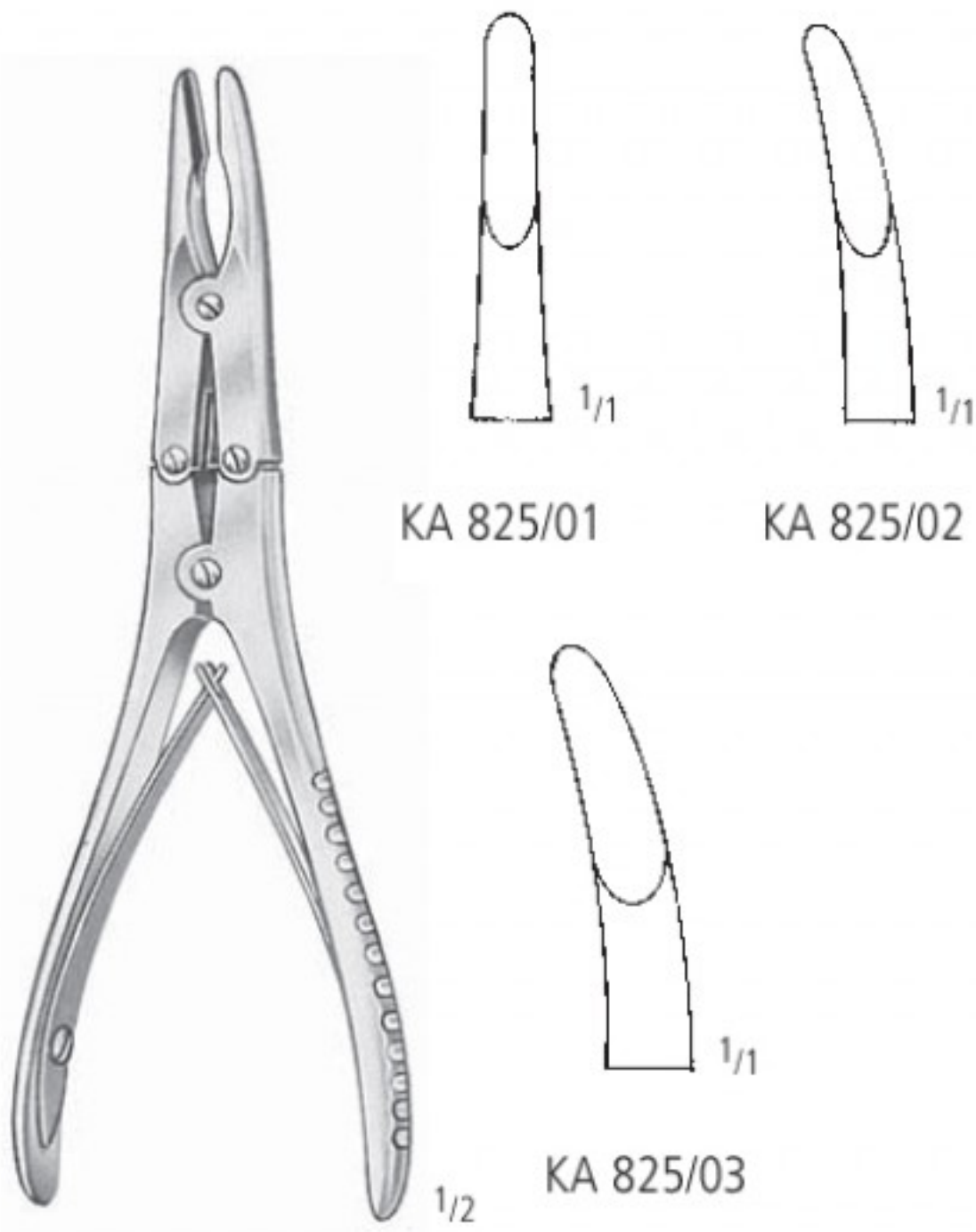

BÖHLER
 15,0 cm/6"

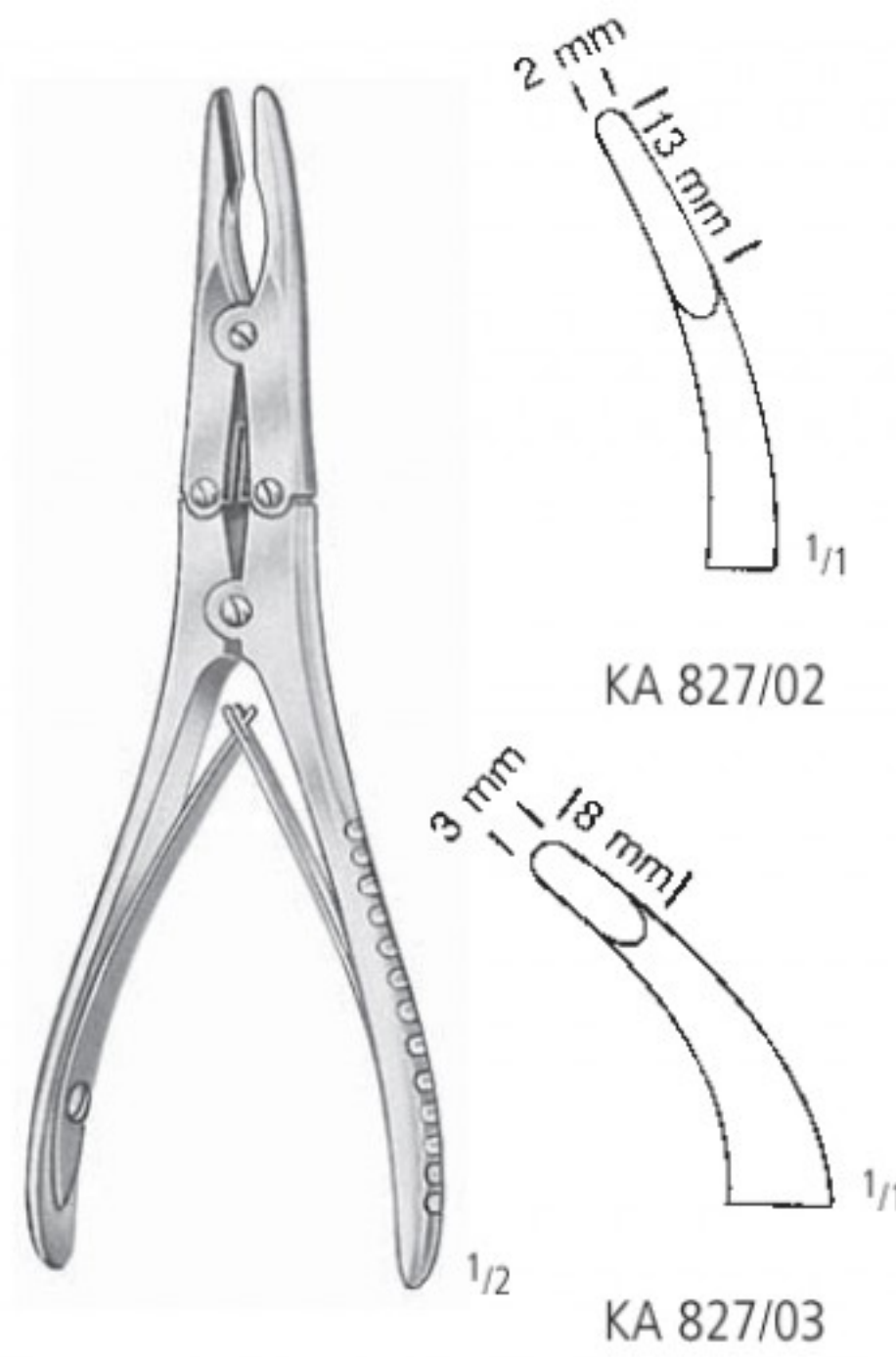

KLEINERT-KUTZ
 15,0 cm/6"

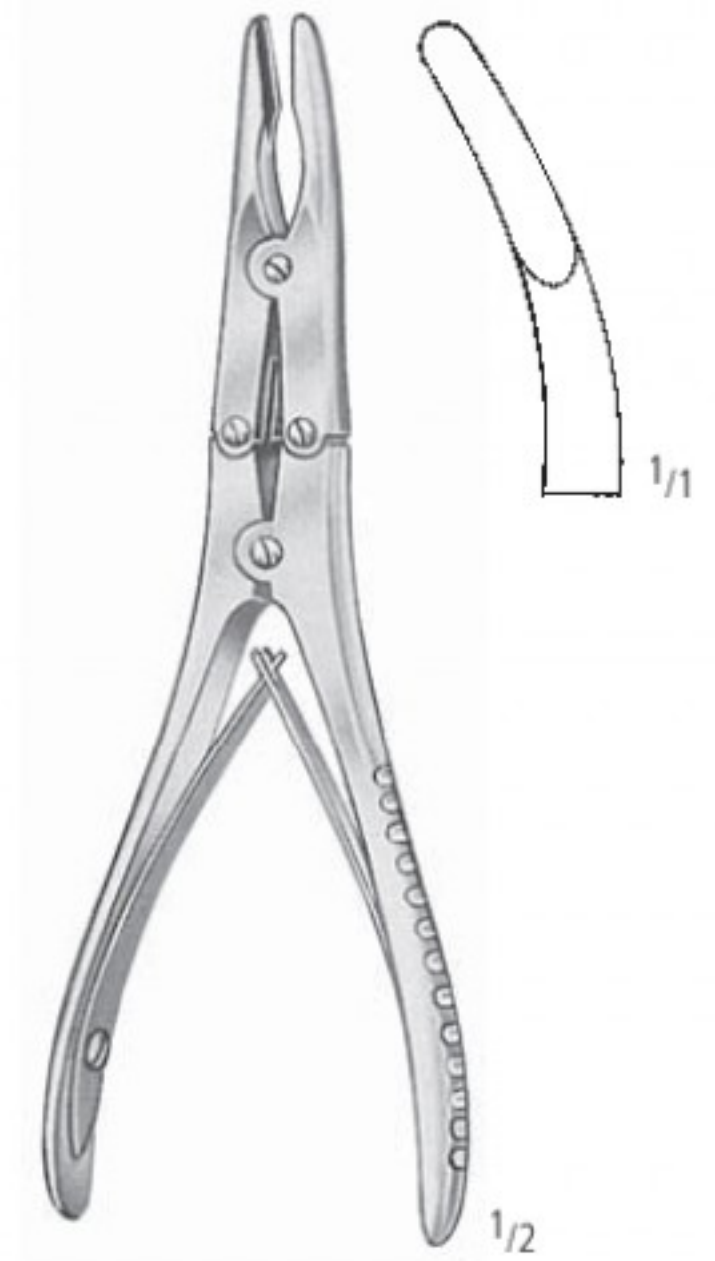

RUSKIN-MINI
 KA 829/15
 15,0 cm/6"



BEYER
 KA 830/18
 18,0 cm/7"



ZAUFAL-JANSEN
 KA 835/18
 18,0 cm/7"

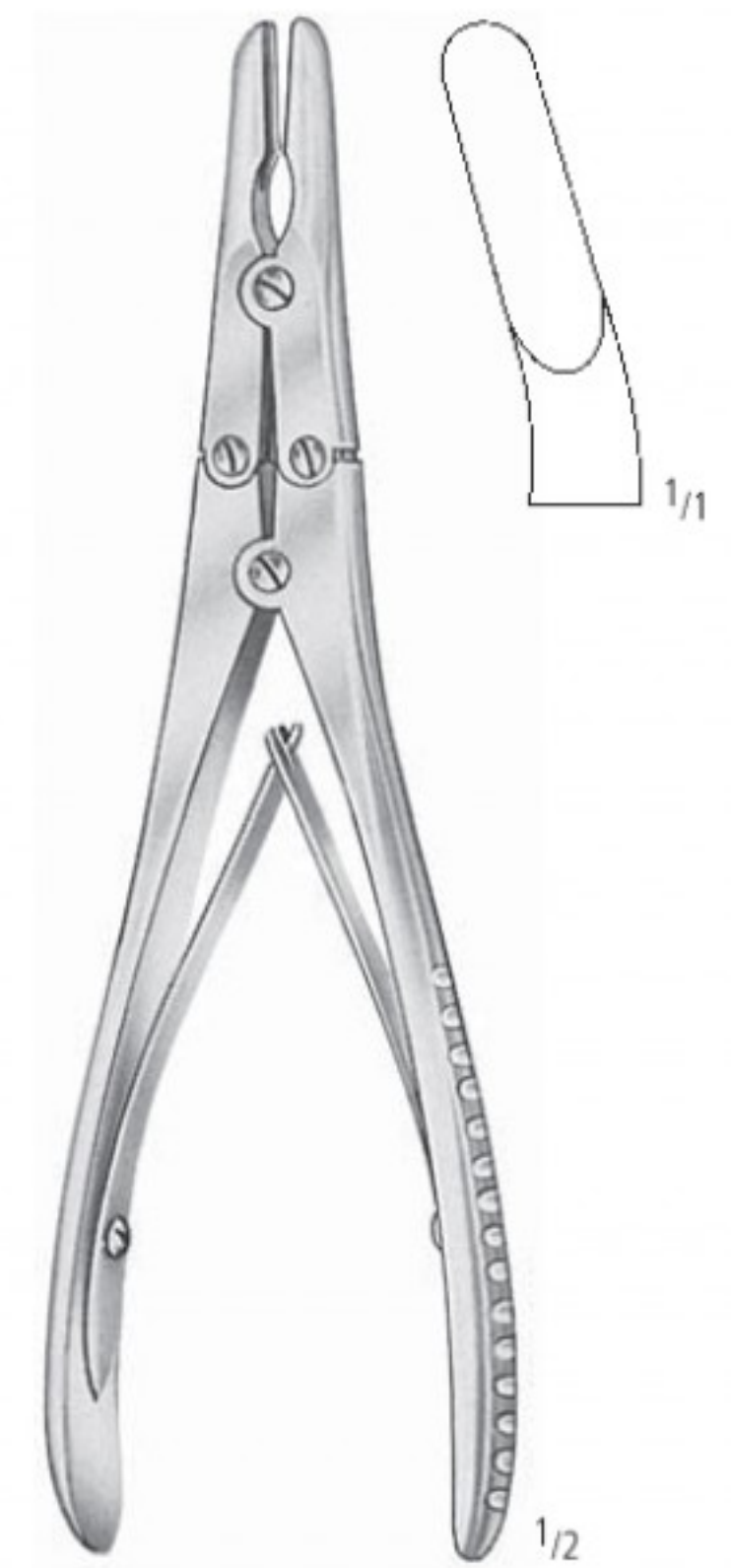

RUSKIN
 KA 836/18
 18,0 cm/7"

AA
 AB
 AC
 AD
 AE
 AF
 AK
 AL
 AM
 AO
 AP
 AR
KA
 KB
 KC
 KD
 KU
 KY

Hohlmeisselzangen
 Bone Rongeurs
 Pinzas-gubias
 Pincés-gouges
 Pinze-sgorbie

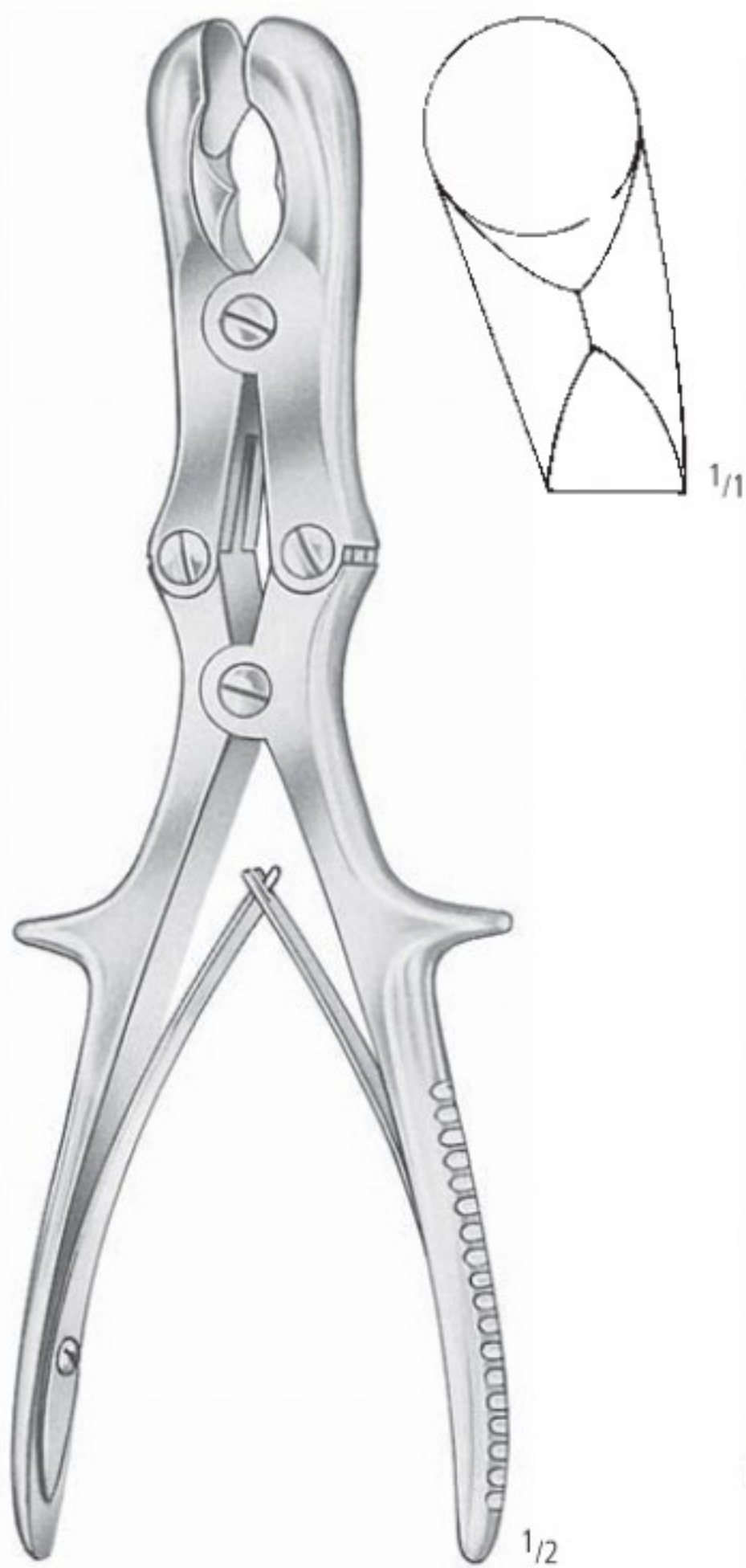

SEMB
 KA 838/22
 22,5 cm/9"



STILLE
 KA 840/23
 23,0 cm/9"



STILLE-RUSKIN
 KA 841/23
 23,0 cm/9"

Hohlmeisselzangen
 Bone Rongeurs
 Pinzas-gubias
 Pincas-gouges
 Pinze-sgorbie

AA
AB
AC
AD
AE
AF
AK
AL
AM
AO
AP
AR
KA
KB
KC
KD
KU
KY



ROETTGEN-RUSKIN
 KA 845/24
 24,0 cm/9¹/₂"



LEKSELL-STILLE
 24,0 cm/9¹/₂"



STILLE-LUER
 22,0 cm/8³/₄"



Hohlmeisselzangen
 Bone Rongeurs
 Pinzas-gubias
 Pincas-gouges
 Pinze-sgorbie

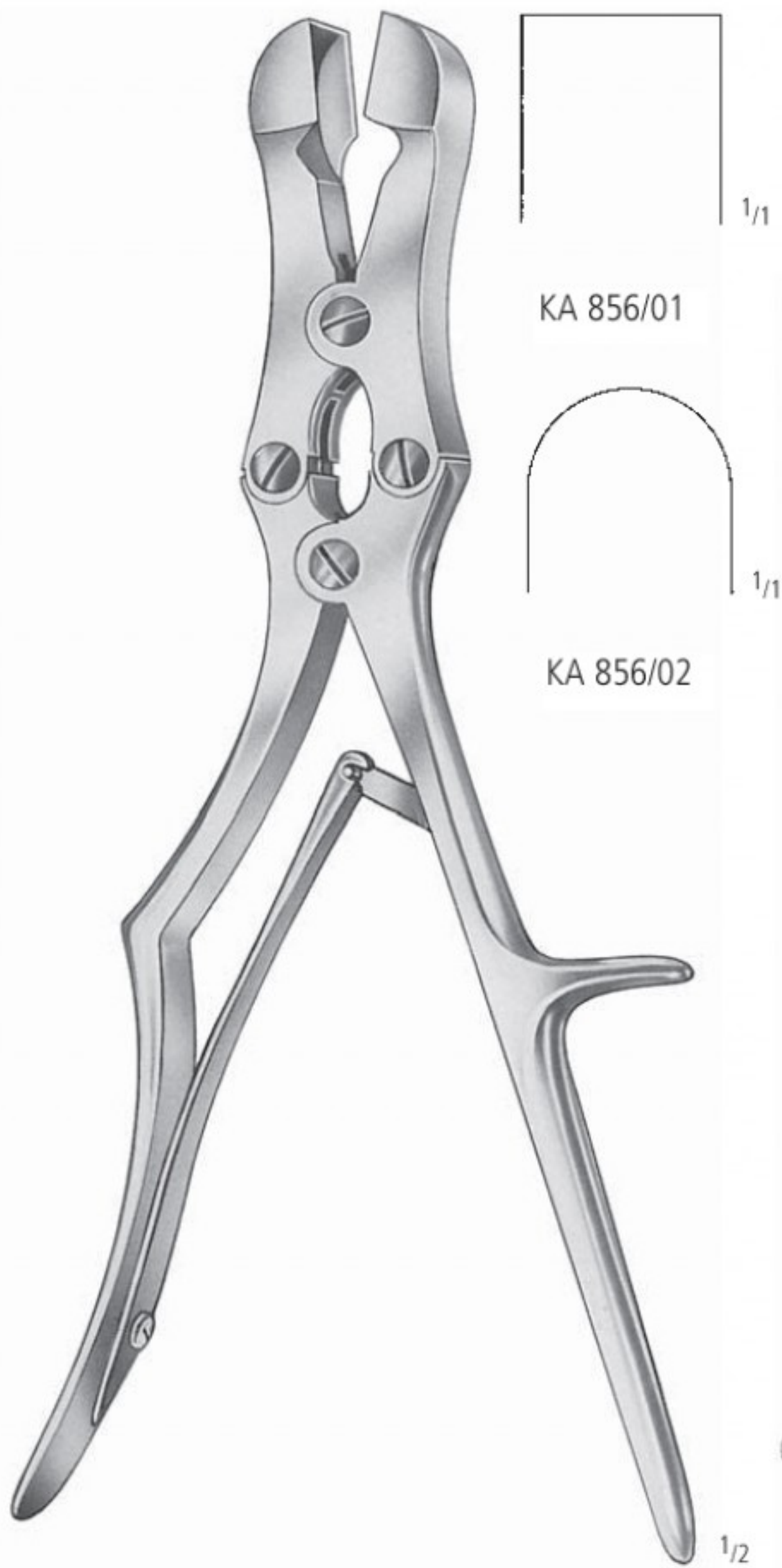

SAUERBRUCH
 30,0 cm/12"



FRYKHOLM
 KA 859/23
 23,0 cm/9"

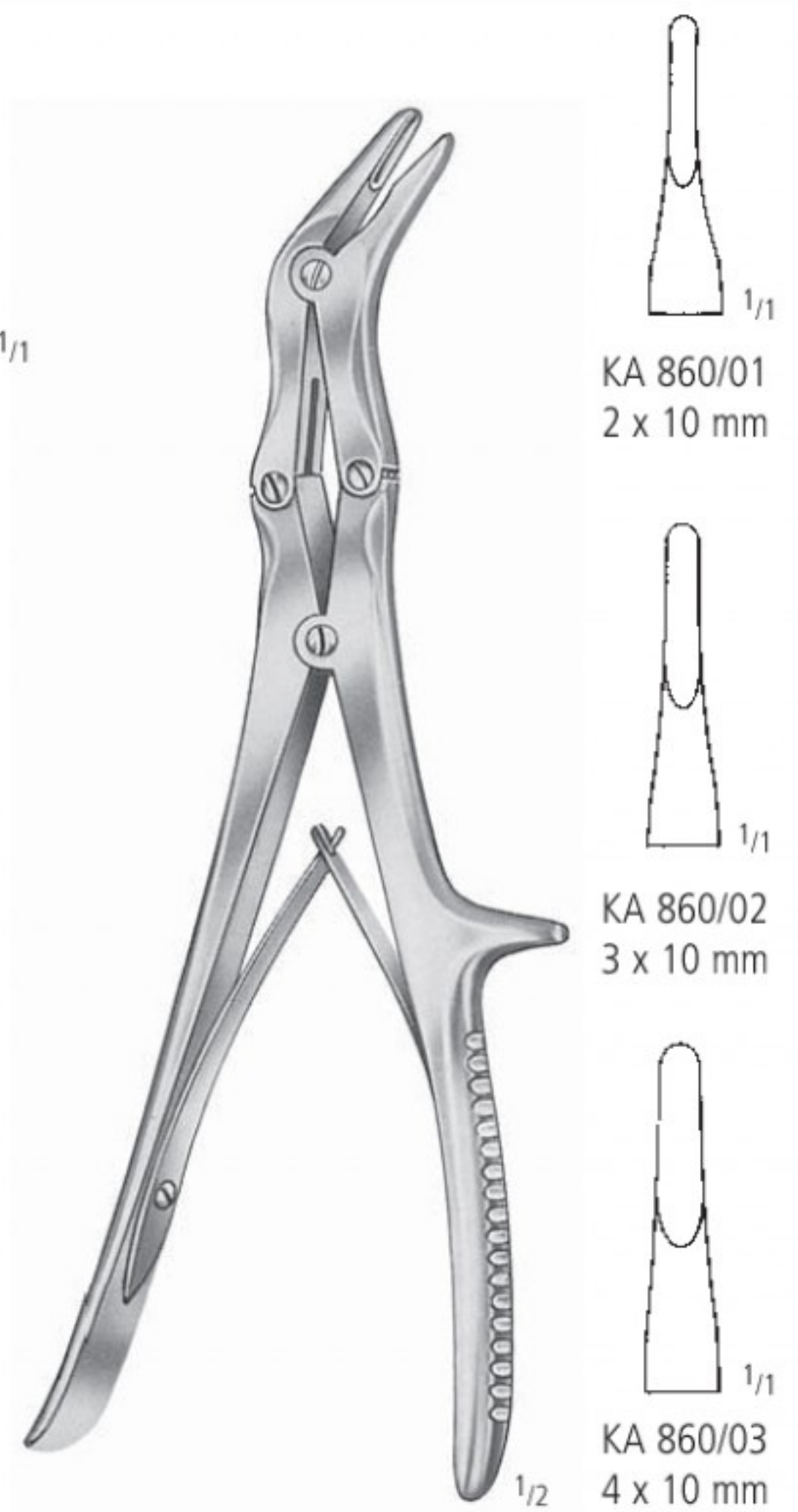

ECHLIN
 23,0 cm/9"

Hohlmeisselzangen
 Bone Rongeurs
 Pinzas-gubias
 Pincas-gouges
 Pinze-sgorbie

AA
AB
AC
AD
AE
AF
AK
AL
AM
AO
AP
AR
KA
KB
KC
KD
KU
KY



RUSKIN
 KA 862/23
 23,0 cm/9"



SMITH-PETERSON
 24,0 cm/9 1/2"



3,0 mm
 KA 863/03



4,0 mm
 KA 863/04

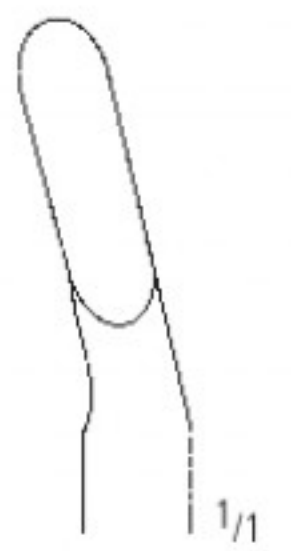

5,0 mm
 KA 863/05

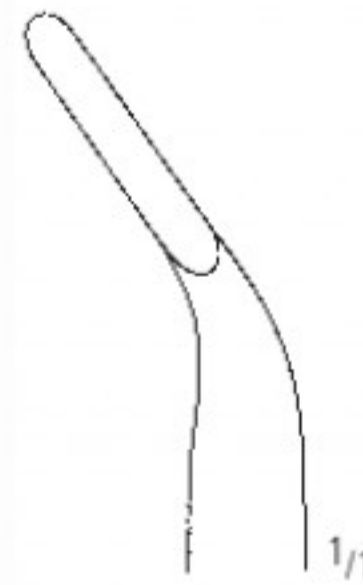

3,0 mm
 KA 863/13

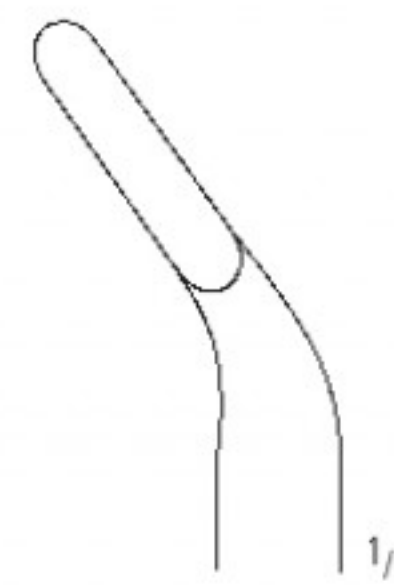

4,0 mm
 KA 863/14

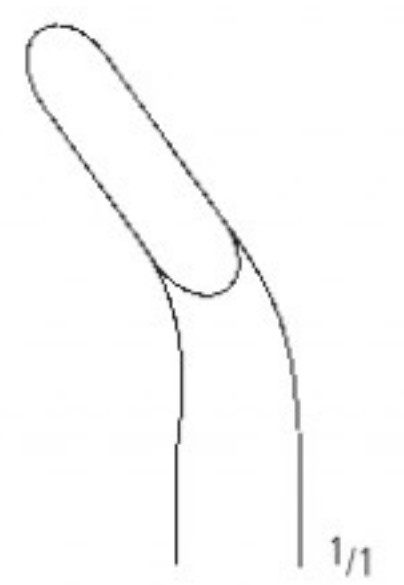

5,0 mm
 KA 863/15

Knochensplitterzangen
 Bone Cutting Forceps
 Pinzas cortantes para huesos
 Pincas coupantes à os
 Cesoie per ossa

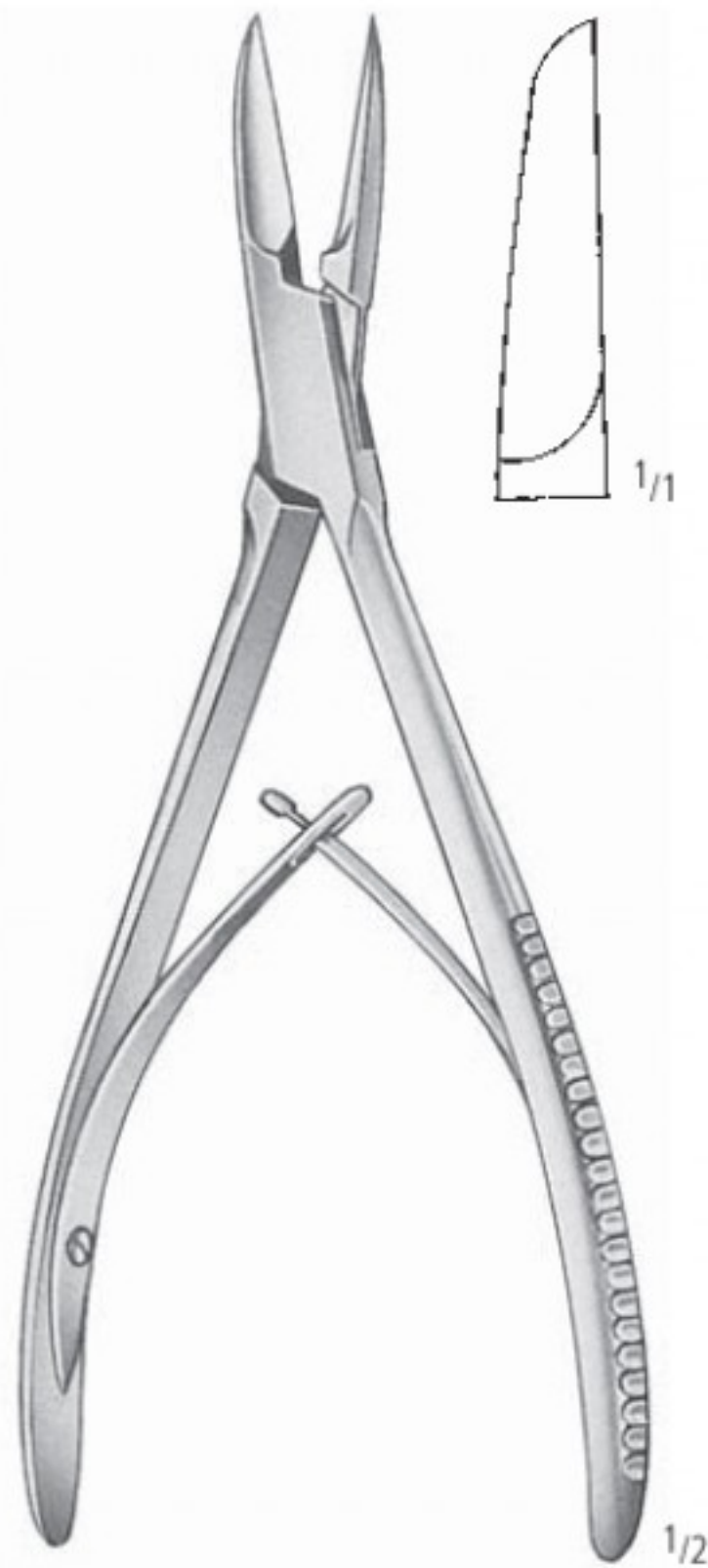

COTTLE KAZANJIAN
 KA 870/19
 19,0 cm/7 1/2"

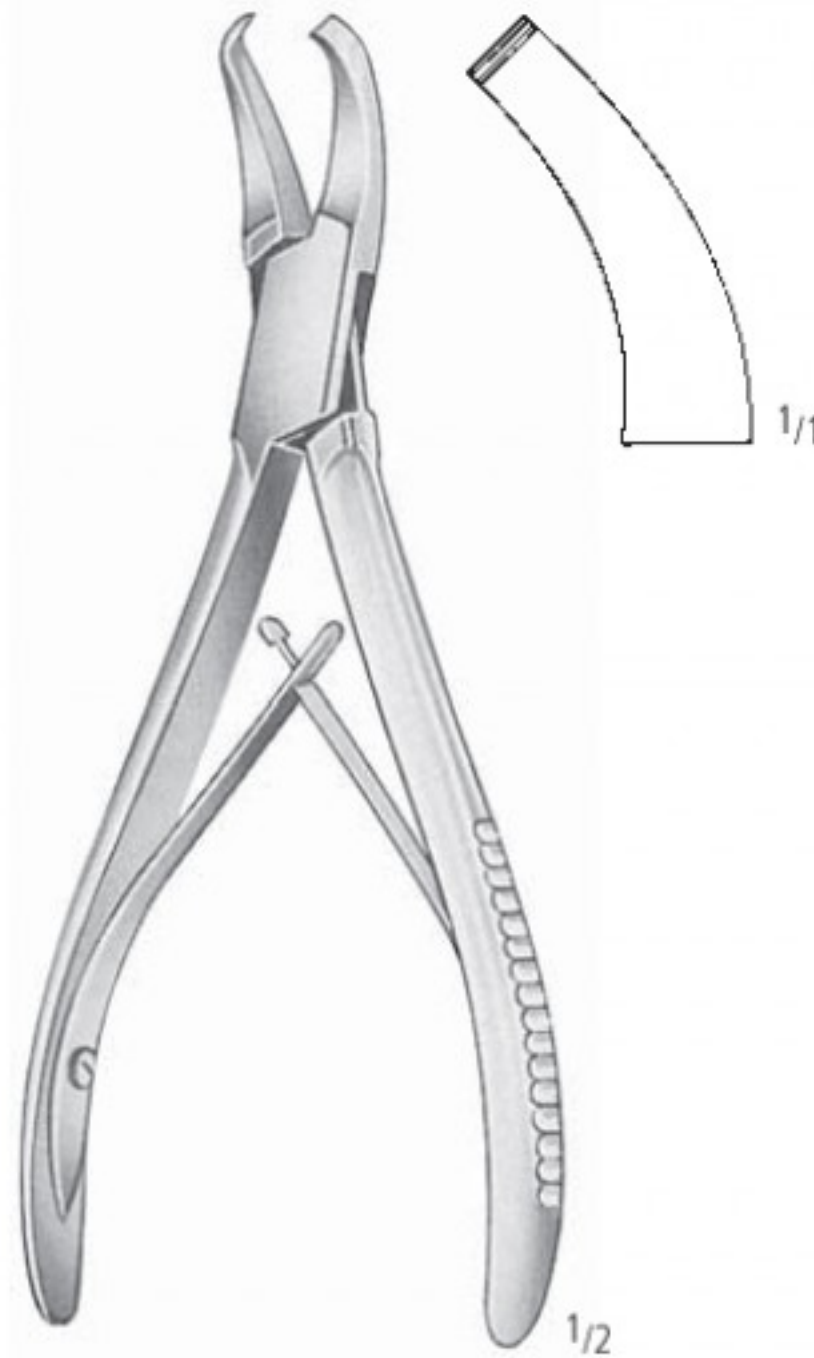

CLEVELAND-GARDNER
 KA 872/16
 18,0 cm/6 1/4"



MARKWALDER
 KA 874/20
 20,0 cm/8"

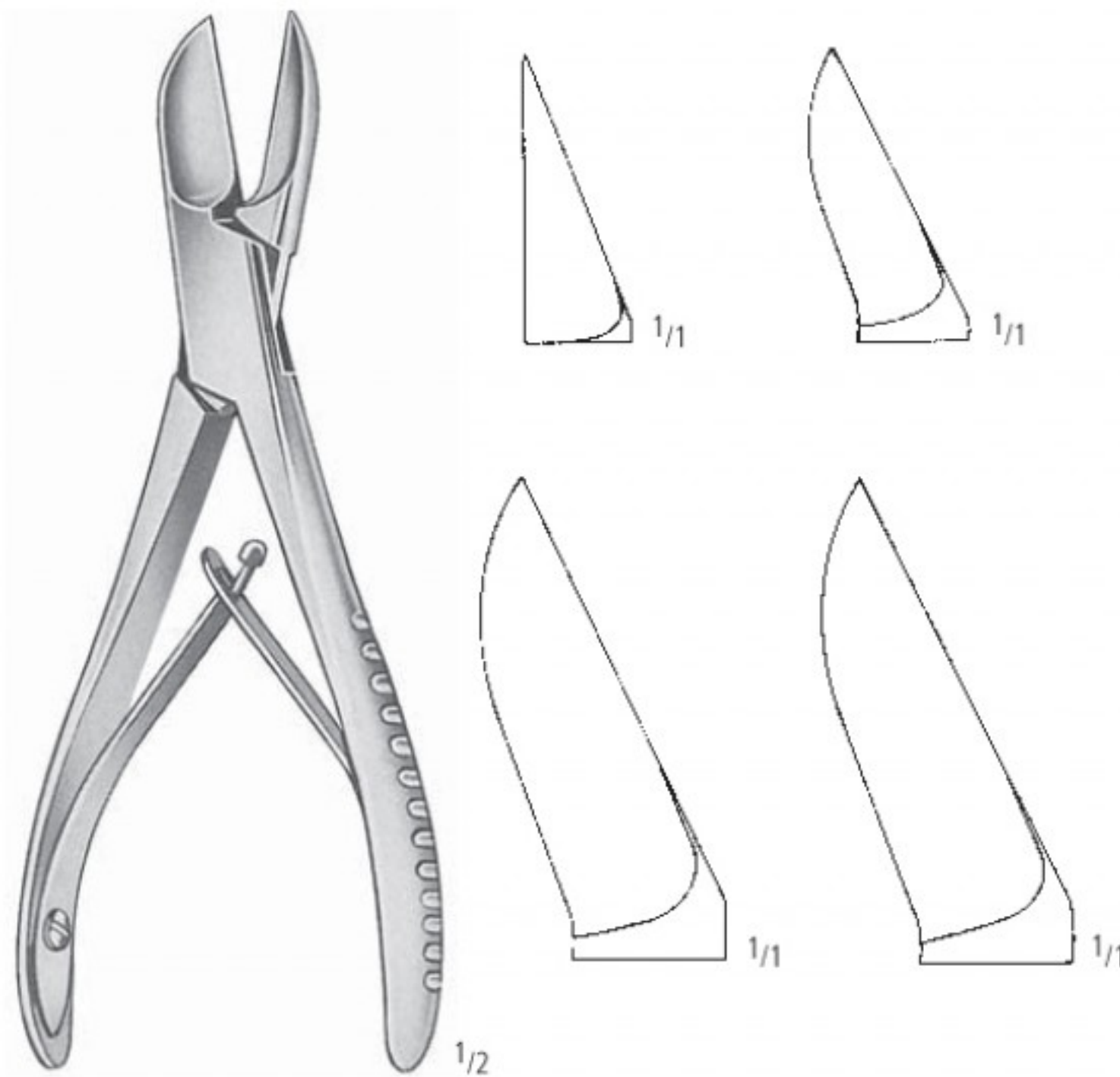
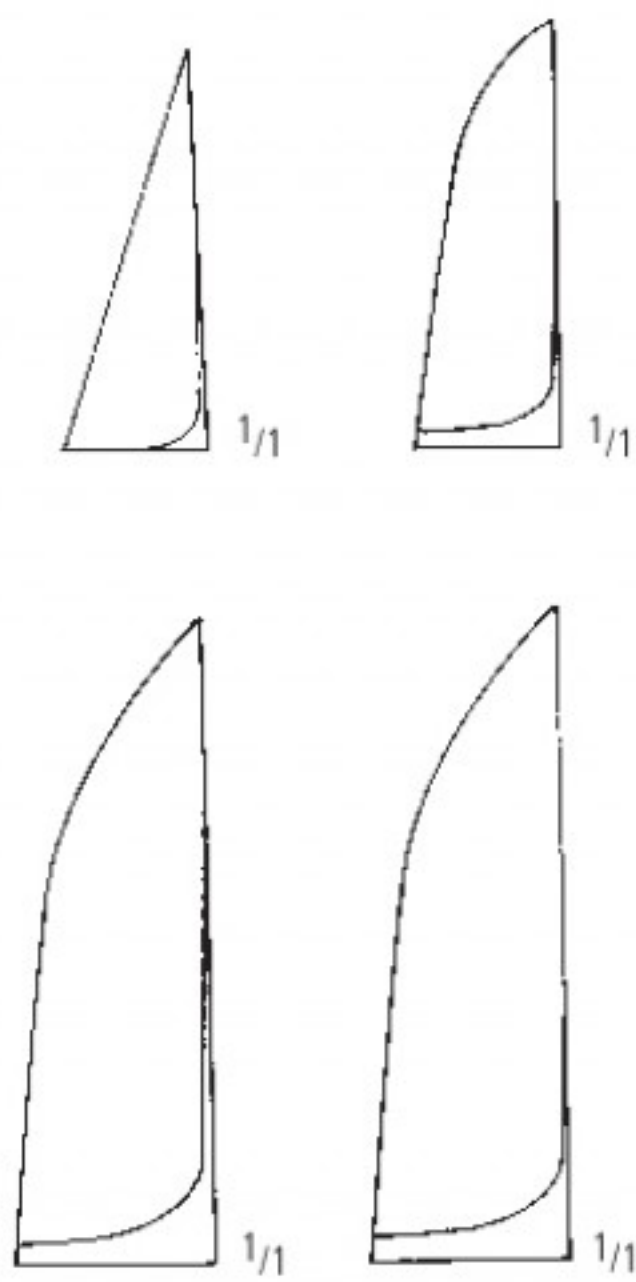

LISTON
 14,0 cm/5 1/2"
 17,0 cm/6 3/4"
 19,0 cm/7 1/2"
 22,0 cm/8 3/4"



LITTAUER-LISTON
 KA 882/15
 15,0 cm/6"

KA 880/14
 KA 880/17
 KA 880/19
 KA 880/22

KA 881/14
 KA 881/17
 KA 881/19
 KA 881/22

ORTHOPÄDIE ORTHOPAEDIC ORTOPEDIA ORTHOPEDIE ORTOPEDIA

Knochensplitterzangen
 Bone Cutting Forceps
 Pinzas cortantes para huesos
 Pincas coupantes à os
 Cesoie per ossa

AA
AB
AC
AD
AE
AF
AK
AL
AM
AO
AP
AR
KA
KB
KC
KD
KU
KY

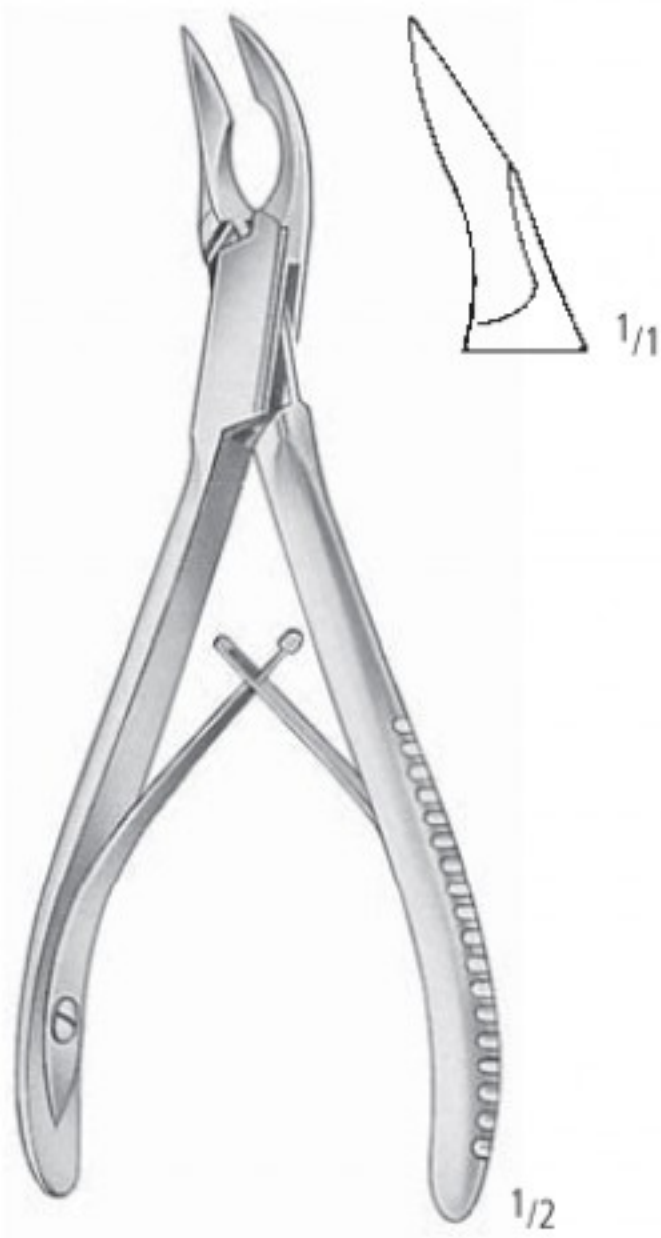

CLEVELAND
 KA 884/15
 15,0 cm/6"



CLEVELAND
 KA 884/17
 17,0 cm/6³/₄"



KA 885/12
 12,0 cm/4³/₄"

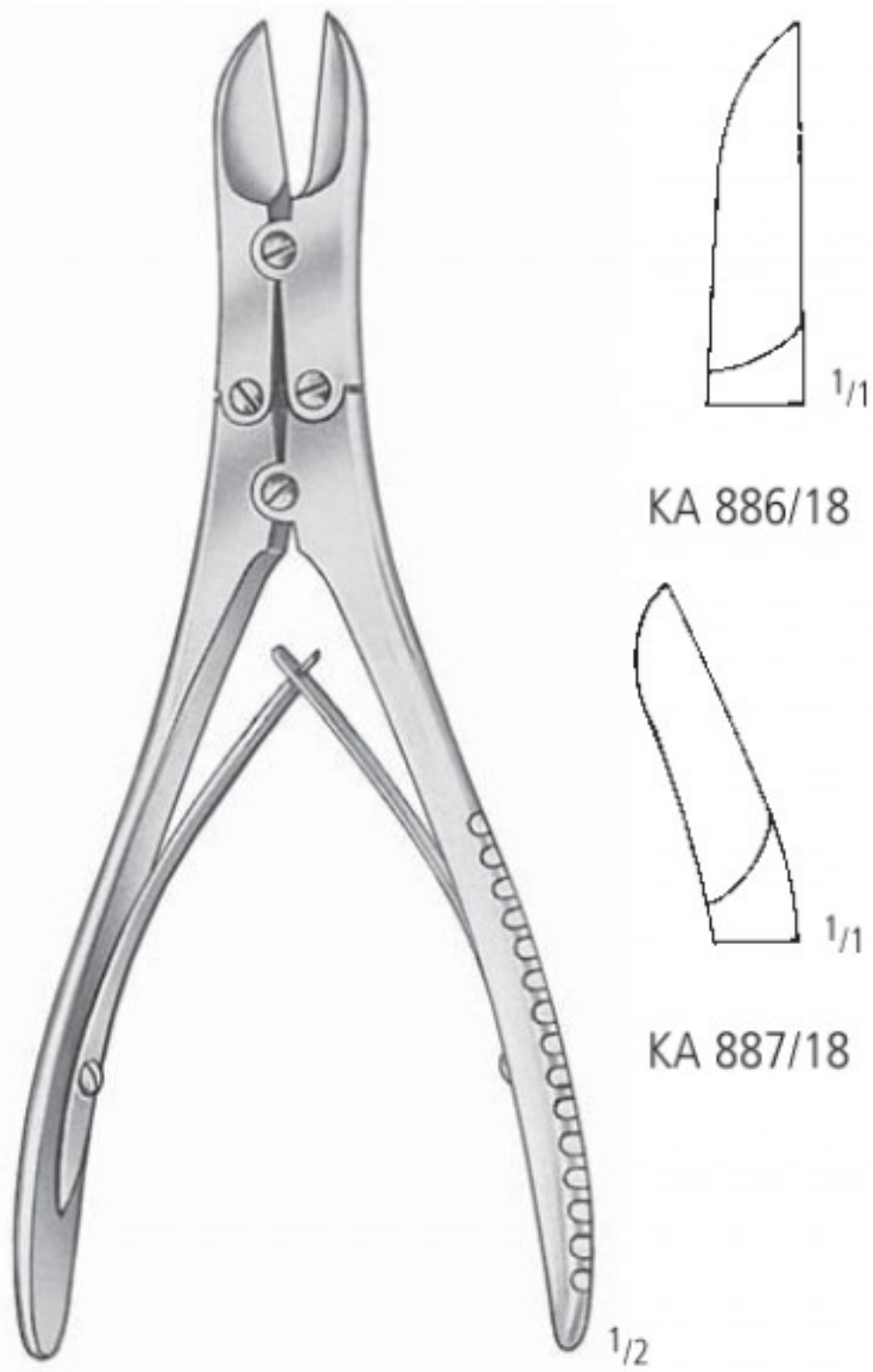

RUSKIN-LISTON
 18,5 cm/7¹/₄"



MC INDOE
 KA 888/17
 17,5 cm/7"

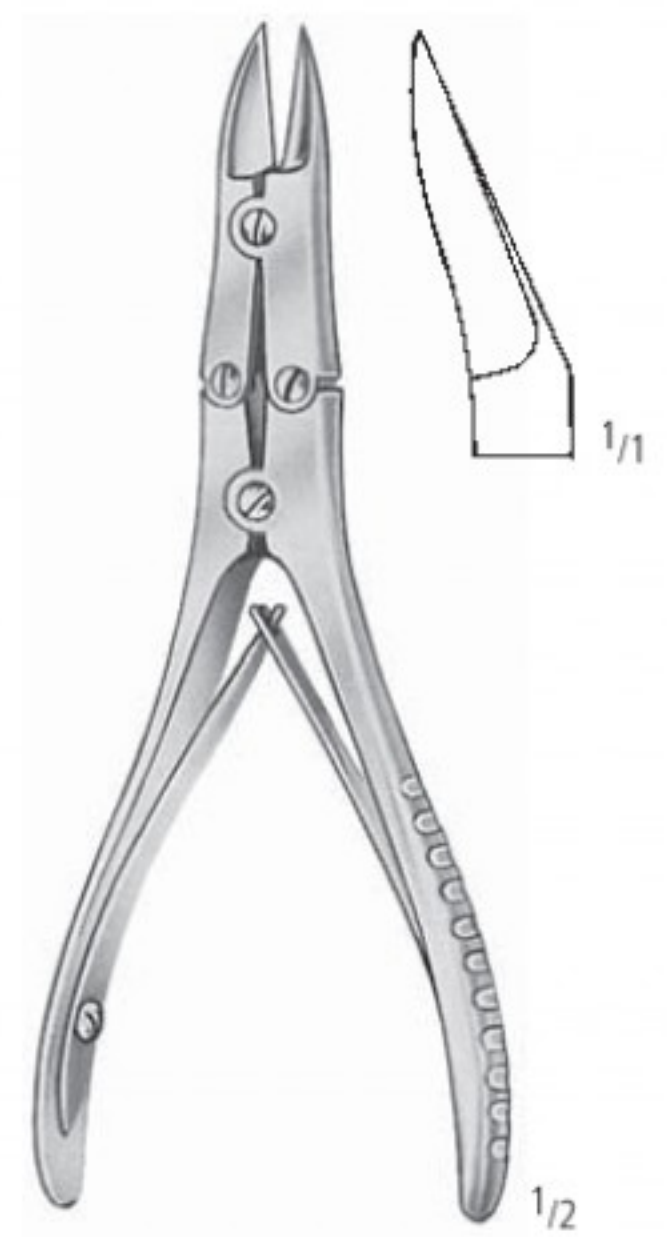

WALTON-LISTON
 KA 889/01
 15,0 cm/6"

Knochensplitterzangen
 Bone Cutting Forceps
 Pinzas cortantes para huesos
 Pincas coupantes à os
 Cesoie per ossa

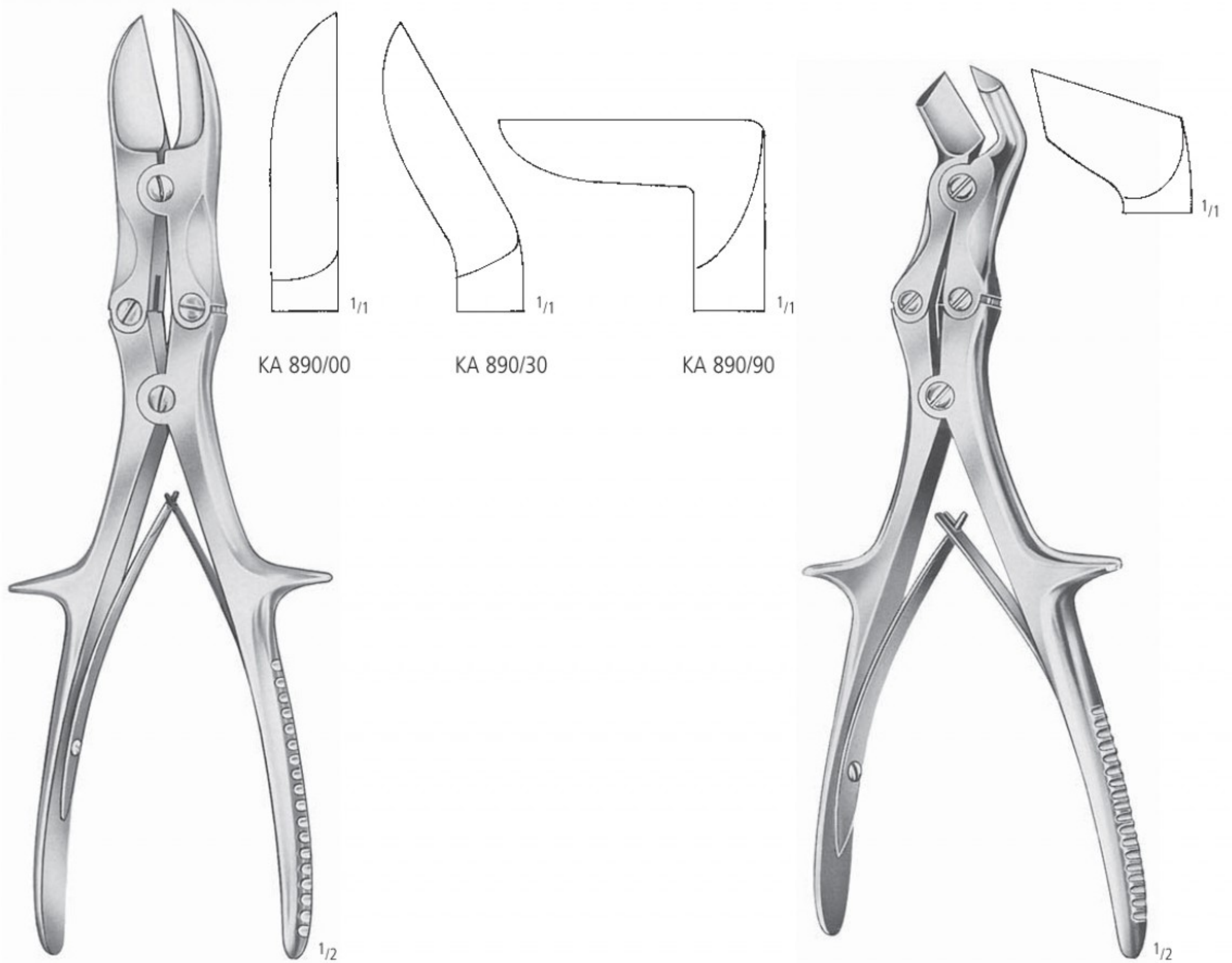

STILLE-LISTON
 27,0 cm/10¹/₂"

LISTON-KEY (TUDOR-EDWARDS)
 KA 892/27
 27,0 cm/10¹/₂"

Knochensplitterzangen
 Bone Cutting Forceps
 Pinzas cortantes para huesos
 Pincas coupantes à os
 Cesioie per ossa



SEMB
 KA 893/24
 24,0 cm/9¹/₂"

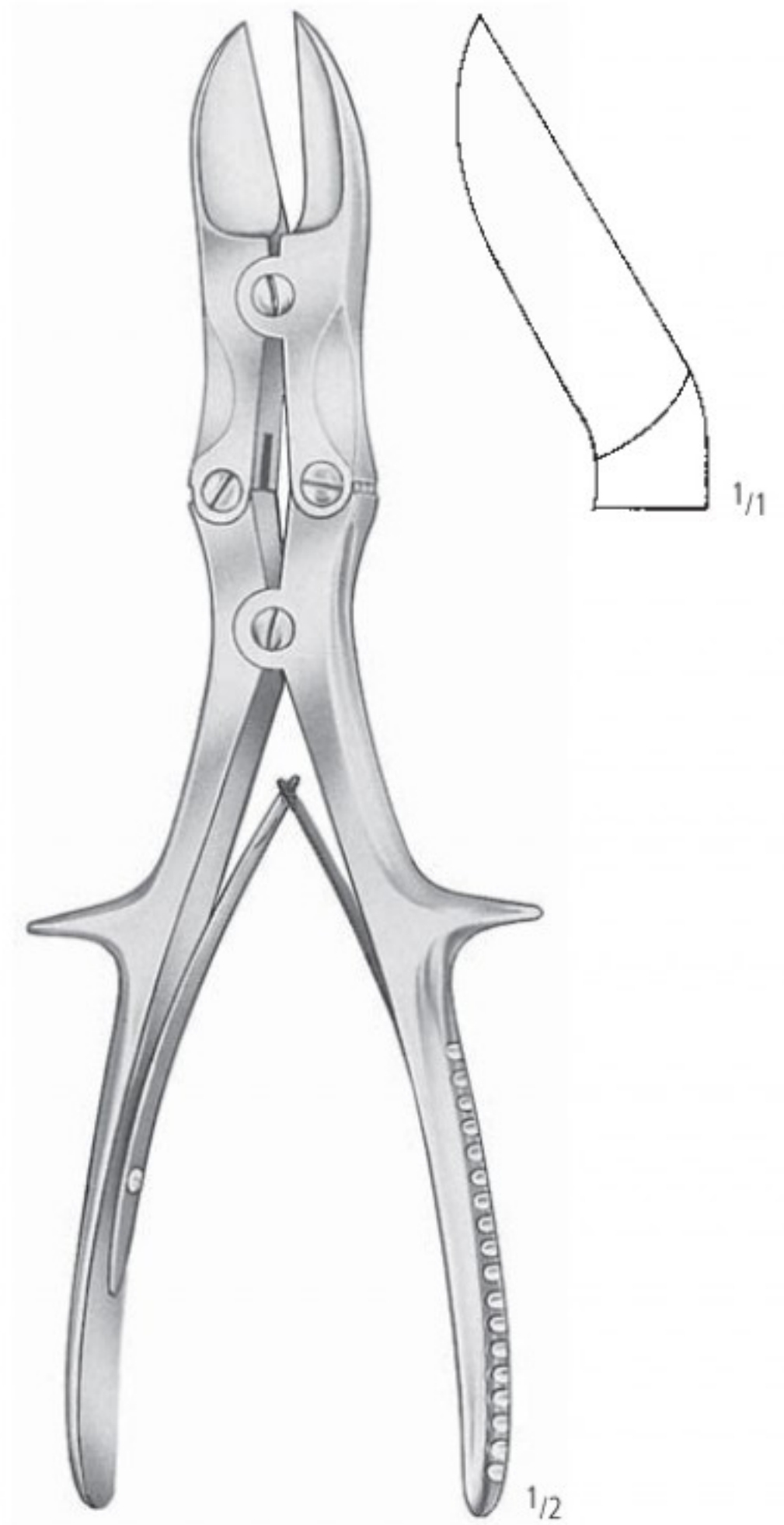

LISTON
 KA 894/23
 23,5 cm/9¹/₄"

AA
 AB
 AC
 AD
 AE
 AF
 AG
 AH
 AI
 AJ
 AK
 AL
 AM
 AN
 AO
 AP
 AQ
 AR
 AS
 AT
 AU
 AV
 AW
 AX
 AY
 AZ
 BA
 BB
 BC
 BD
 BE
 BF
 BG
 BH
 BI
 BJ
 BK
 BL
 BM
 BN
 BO
 BP
 BQ
 BR
 BS
 BT
 BU
 BV
 BW
 BX
 BY
 BZ
 CA
 CB
 CC
 CD
 CE
 CF
 CG
 CH
 CI
 CJ
 CK
 CL
 CM
 CN
 CO
 CP
 CQ
 CR
 CS
 CT
 CU
 CV
 CW
 CX
 CY
 CZ
 DA
 DB
 DC
 DD
 DE
 DF
 DG
 DH
 DI
 DJ
 DK
 DL
 DM
 DN
 DO
 DP
 DQ
 DR
 DS
 DT
 DU
 DV
 DW
 DX
 DY
 DZ
 EA
 EB
 EC
 ED
 EE
 EF
 EG
 EH
 EI
 EJ
 EK
 EL
 EM
 EN
 EO
 EP
 EQ
 ER
 ES
 ET
 EU
 EV
 EW
 EX
 EY
 EZ
 FA
 FB
 FC
 FD
 FE
 FF
 FG
 FH
 FI
 FJ
 FK
 FL
 FM
 FN
 FO
 FP
 FQ
 FR
 FS
 FT
 FU
 FV
 FW
 FX
 FY
 FZ
 GA
 GB
 GC
 GD
 GE
 GF
 GG
 GH
 GI
 GJ
 GK
 GL
 GM
 GN
 GO
 GP
 GQ
 GR
 GS
 GT
 GU
 GV
 GW
 GX
 GY
 GZ
 HA
 HB
 HC
 HD
 HE
 HF
 HG
 HH
 HI
 HJ
 HK
 HL
 HM
 HN
 HO
 HP
 HQ
 HR
 HS
 HT
 HU
 HV
 HW
 HX
 HY
 HZ
 IA
 IB
 IC
 ID
 IE
 IF
 IG
 IH
 II
 IJ
 IK
 IL
 IM
 IN
 IO
 IP
 IQ
 IR
 IS
 IT
 IU
 IV
 IW
 IX
 IY
 IZ
 JA
 JB
 JC
 JD
 JE
 JF
 JG
 JH
 JI
 JJ
 JK
 JL
 JM
 JN
 JO
 JP
 JQ
 JR
 JS
 JT
 JU
 JV
 JW
 JX
 JY
 JZ
 KA
 KB
 KC
 KD
 KE
 KF
 KG
 KH
 KI
 KJ
 KK
 KL
 KM
 KN
 KO
 KP
 KQ
 KR
 KS
 KT
 KU
 KV
 KW
 KX
 KY
 KZ
 LA
 LB
 LC
 LD
 LE
 LF
 LG
 LH
 LI
 LJ
 LK
 LL
 LM
 LN
 LO
 LP
 LQ
 LR
 LS
 LT
 LU
 LV
 LW
 LX
 LY
 LZ
 MA
 MB
 MC
 MD
 ME
 MF
 MG
 MH
 MI
 MJ
 MK
 ML
 MM
 MN
 MO
 MP
 MQ
 MR
 MS
 MT
 MU
 MV
 MW
 MX
 MY
 MZ
 NA
 NB
 NC
 ND
 NE
 NF
 NG
 NH
 NI
 NJ
 NK
 NL
 NM
 NN
 NO
 NP
 NQ
 NR
 NS
 NT
 NU
 NV
 NW
 NX
 NY
 NZ
 OA
 OB
 OC
 OD
 OE
 OF
 OG
 OH
 OI
 OJ
 OK
 OL
 OM
 ON
 OO
 OP
 OQ
 OR
 OS
 OT
 OU
 OV
 OW
 OX
 OY
 OZ
 PA
 PB
 PC
 PD
 PE
 PF
 PG
 PH
 PI
 PJ
 PK
 PL
 PM
 PN
 PO
 PP
 PQ
 PR
 PS
 PT
 PU
 PV
 PW
 PX
 PY
 PZ
 QA
 QB
 QC
 QD
 QE
 QF
 QG
 QH
 QI
 QJ
 QK
 QL
 QM
 QN
 QO
 QP
 QQ
 QR
 QS
 QT
 QU
 QV
 QW
 QX
 QY
 QZ
 RA
 RB
 RC
 RD
 RE
 RF
 RG
 RH
 RI
 RJ
 RK
 RL
 RM
 RN
 RO
 RP
 RQ
 RR
 RS
 RT
 RU
 RV
 RW
 RX
 RY
 RZ
 SA
 SB
 SC
 SD
 SE
 SF
 SG
 SH
 SI
 SJ
 SK
 SL
 SM
 SN
 SO
 SP
 SQ
 SR
 SS
 ST
 SU
 SV
 SW
 SX
 SY
 SZ
 TA
 TB
 TC
 TD
 TE
 TF
 TG
 TH
 TI
 TJ
 TK
 TL
 TM
 TN
 TO
 TP
 TQ
 TR
 TS
 TT
 TU
 TV
 TW
 TX
 TY
 TZ
 UA
 UB
 UC
 UD
 UE
 UF
 UG
 UH
 UI
 UJ
 UK
 UL
 UM
 UN
 UO
 UP
 UQ
 UR
 US
 UT
 UY
 UZ
 VA
 VB
 VC
 VD
 VE
 VF
 VG
 VH
 VI
 VJ
 VK
 VL
 VM
 VN
 VO
 VP
 VQ
 VR
 VS
 VT
 VU
 VV
 VW
 VX
 VY
 VZ
 WA
 WB
 WC
 WD
 WE
 WF
 WG
 WH
 WI
 WJ
 WK
 WL
 WM
 WN
 WO
 WP
 WQ
 WR
 WS
 WT
 WU
 WV
 WW
 WX
 WY
 WZ
 XA
 XB
 XC
 XD
 XE
 XF
 XG
 XH
 XI
 XJ
 XK
 XL
 XM
 XN
 XO
 XP
 XQ
 XR
 XS
 XT
 XU
 XV
 XW
 XX
 XY
 XZ
 YA
 YB
 YC
 YD
 YE
 YF
 YG
 YH
 YI
 YJ
 YK
 YL
 YM
 YN
 YO
 YP
 YQ
 YR
 YS
 YT
 YU
 YV
 YW
 YX
 YZ
 ZA
 ZB
 ZC
 ZD
 ZE
 ZF
 ZG
 ZH
 ZI
 ZJ
 ZK
 ZL
 ZM
 ZN
 ZO
 ZP
 ZQ
 ZR
 ZS
 ZT
 ZU
 ZV
 ZW
 ZX
 ZY
 ZZ

Bleihände, Fingerringsägen und Nagelzange
 Lead Hands, Finger Ring Saws and Nail Instrument
 Manoplas de plomo, sierras para abrir anillos y pinza para uñas
 Manches en plomb, scies pour bagues et pince à ongle
 Mani di piombo, seghe per anelli e pinza per unghie

KA 900/01
 für Kinder
 Child Size
 Para niños
 Pour enfants
 Per bambini

KA 900/02
 für Erwachsene
 Adult Size
 Para adultos
 Pour adultes
 Per adulti



KA 908/17
 17,0 cm/6³/₄"



WALTON
 KA 910/17
 16,0 cm/6¹/₄"

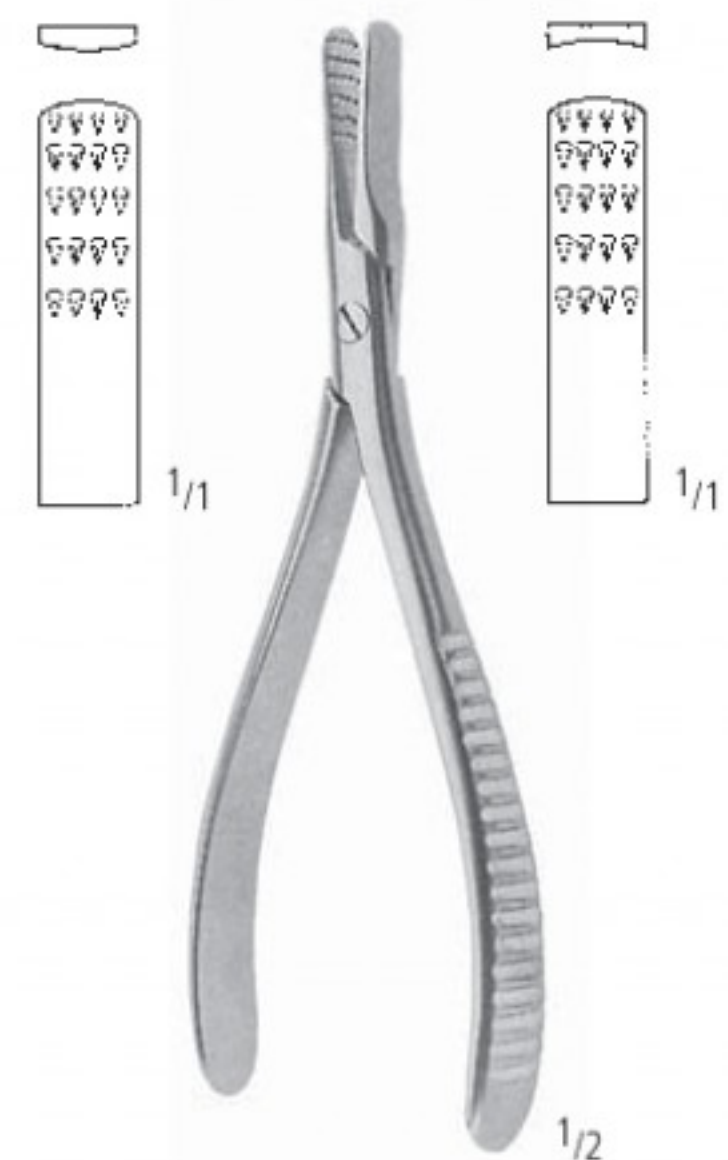

RADOLF
 KA 918/13
 13,5 cm/5¹/₄"

Autopsie-Säge
 Post Mortem Saw
 Sierra para autopsia
 Scie à autopsie
 Sega per autopsia

OSCI nopa®

**Autoklavierbar
 Autoclavable
 Autoclavable
 Autoclavable
 Autoclavabile**



KA 995/00 = 230 V
 (+ KA 996/50 + KA 996/65 + KA 997/01 + KA 998/23 + KA 999/16)
 Euro-Flachstecker / EU-plug
 KA 995/01 = 110 V
 (+ KA 996/50 + KA 996/65 + KA 997/01 + KA 998/23 + KA 999/16)
 USA-Stecker / USA-plug

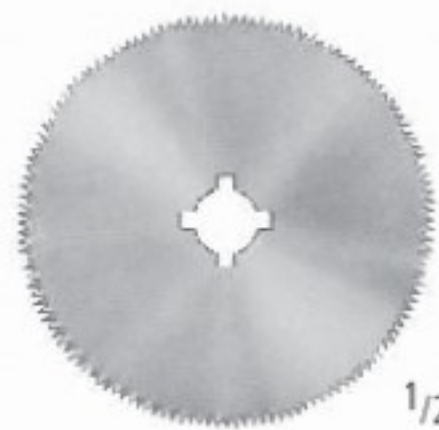

KA 996/50 = Ø 50 mm
 KA 996/65 = Ø 65 mm



KA 997/01



KA 998/23



KA 999/16
 16,0 cm/6 1/4"

AA
 AB
 AC
 AD
 AE
 AF
 AK
 AL
 AM
 AO
 AP
 AR
 KA
 KB
 KC
 KD
 KU
 KY

Autopsie-Säge
 Post Mortem Saw
 Sierra para autopsia
 Scie à autopsie
 Sega per autopsia

nopa[®] P R O F I



KA 995/10 = 230 V
 (+ KA 996/50 + KA 996/65 + KA 997/01 + KA 997/39 + KA 998/24 + KA 999/16)
 Euro-Flachstecker / EU-plug
 KA 995/11 = 110 V
 (+ KA 996/50 + KA 996/65 + KA 997/01 + KA 997/39 + KA 998/24 + KA 999/16)
 USA-Stecker / USA-plug

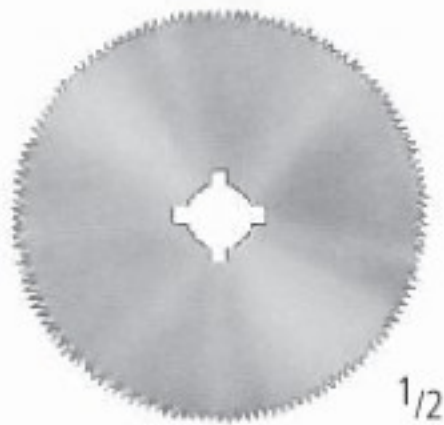

KA 996/50 = Ø 50 mm
 KA 996/65 = Ø 65 mm

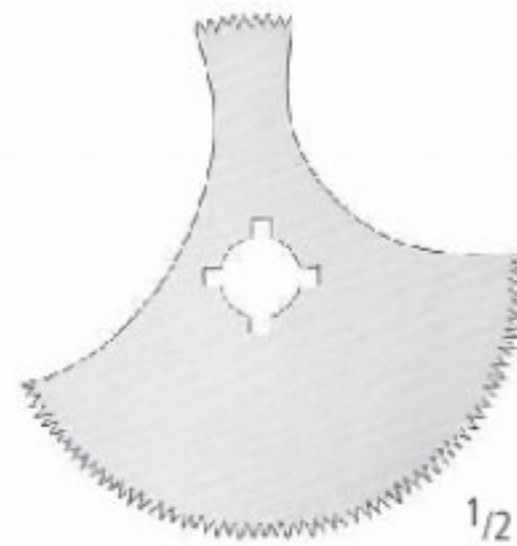

KA 997/01

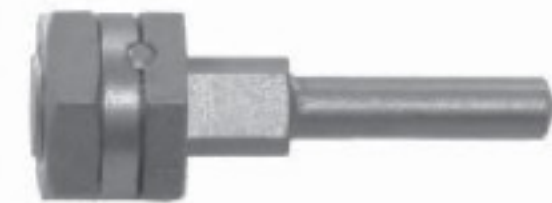

KA 997/39



KA 998/24



KA 999/16
 16,0 cm/6¹/₄"

Autopsie-Säge
 Post Mortem Saw
 Sierra para autopsia
 Scie à autopsie
 Sega per autopsia

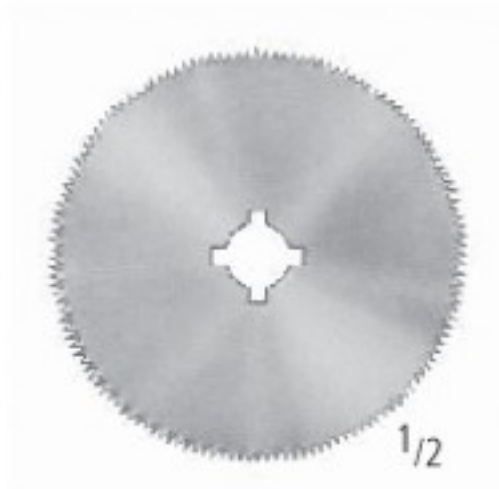

KA 996/50 = Ø 50 mm
 KA 996/65 = Ø 65 mm



KA 997/01



KA 997/02 = 8 mm
 KA 997/03 = 20 mm

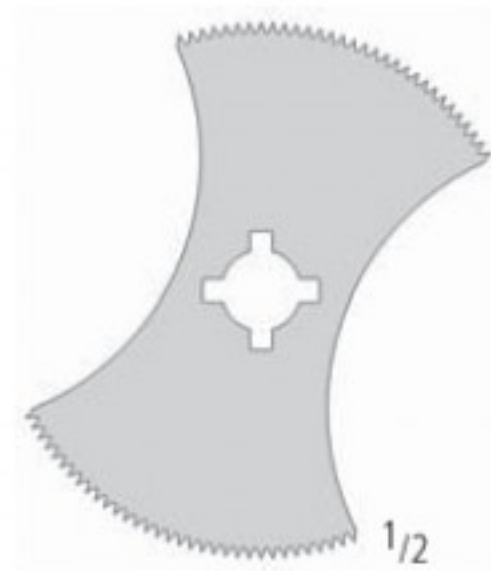

KA 997/04



KA 997/05

nur für **nopa** PROF I
 only for **nopa** PROF I



KA 997/11



KA 997/39



KA 997/58

AA
 AB
 AC
 AD
 AE
 AF
 AK
 AL
 AM
 AO
 AP
 AR
KA
 KB
 KC
 KD
 KU
 KY

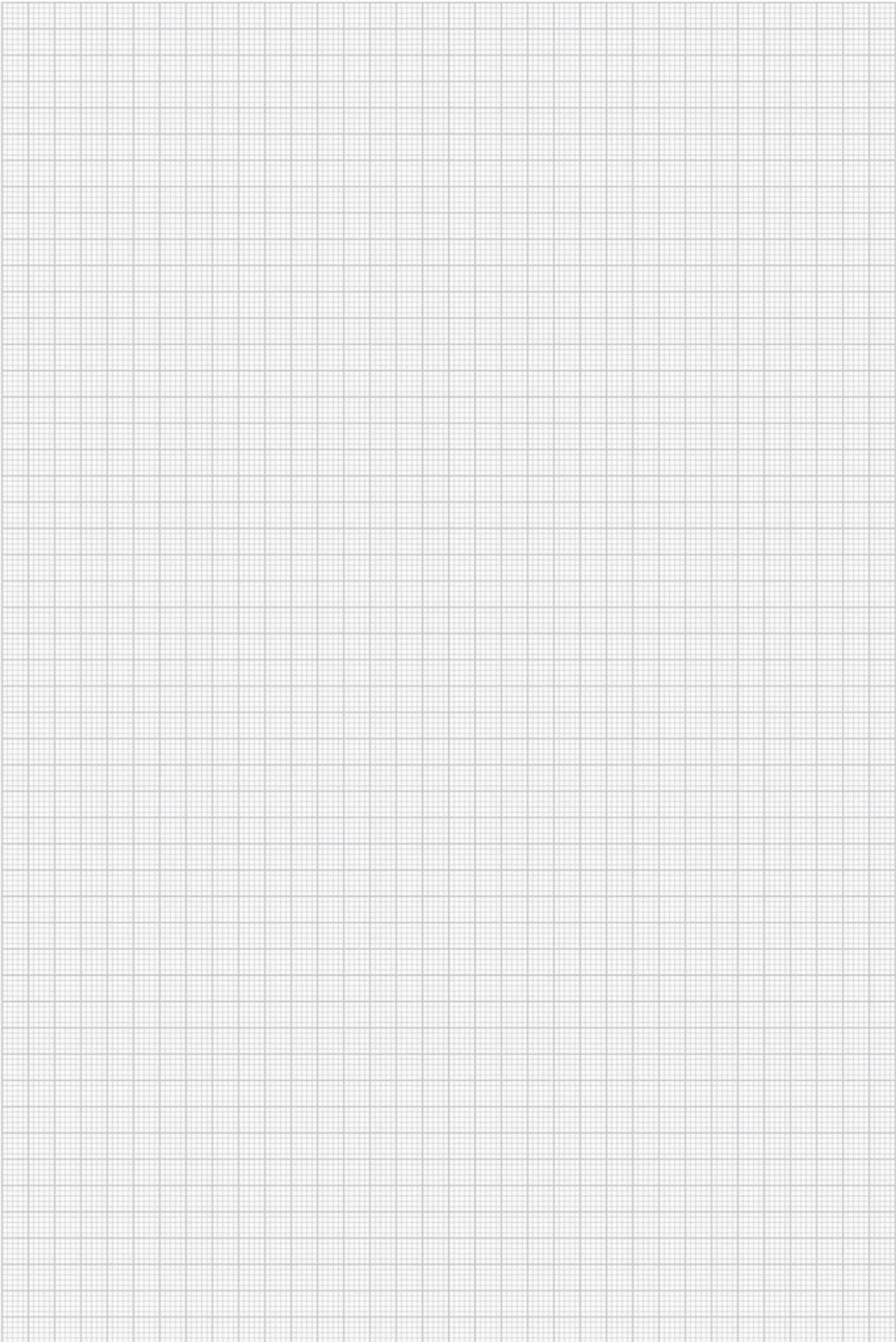

Repositionszangen
 Reposition Forceps
 Pinzas de reposicion
 Pincas de reposition
 Pinze per riposizione



ROWE
 KA 2970/23
 23,0 cm/9"



ROWE
 KA 2971/23
 23,0 cm/9"

AA
 AB
 AC
 AD
 AE
 AF
 AK
 AL
 AM
 AO
 AP
 AR
KA
 KB
 KC
 KD
 KU
 KY

Instrumentarium für Küntscher - Nägel
 Instruments for Küntscher Nails
 Instrumentos para clavos Küntscher
 Instrumentation pour les clous de Küntscher
 Strumenti per chiodi Küntscher



KÜNTSCHER
KA 4900/01



KÜNTSCHER
KA 4900/02



KÜNTSCHER
KA 4900/03



KA 4901/00

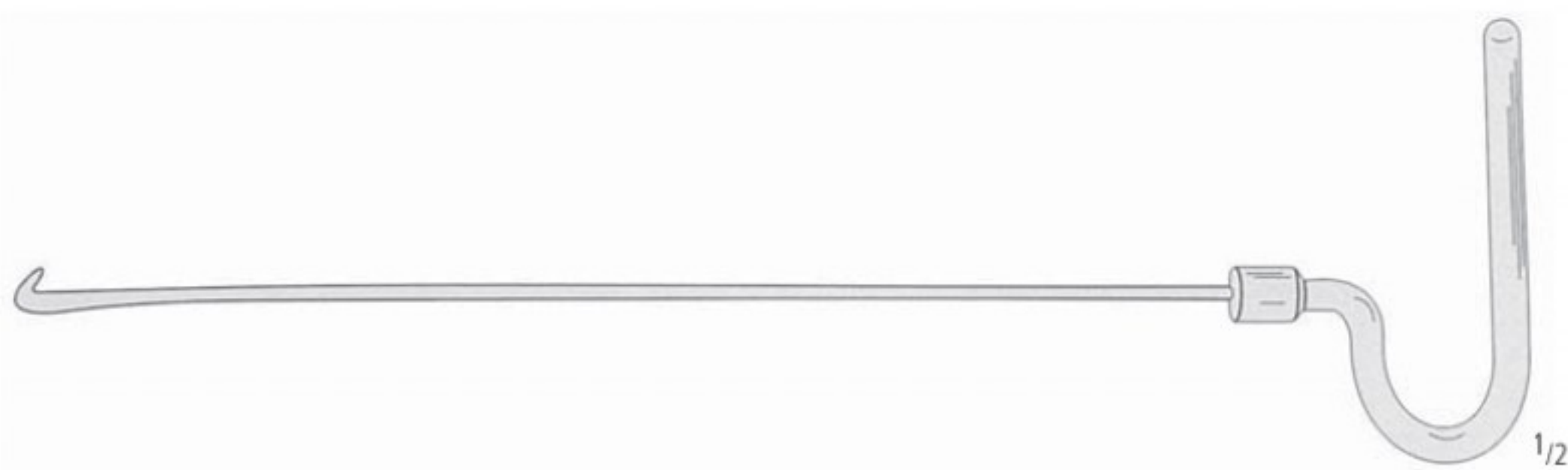

29,0 cm/11 ¹ / ₂ "	KA 4902/29
37,0 cm/14 ¹ / ₂ "	KA 4902/37
42,0 cm/16 ¹ / ₂ "	KA 4902/42
49,0 cm/19 ¹ / ₄ "	KA 4902/49

Instrumentarium für Küntscher - Nägel
 Instruments for Küntscher Nails
 Instrumentos para clavos Küntscher
 Instrumentation pour les clous de Küntscher
 Strumenti per chiodi Küntscher



KA 4913/00



KÜNTSCHER
KA 4913/26



KÜNTSCHER
KA 4913/35



Führungsspieß - Guide Pin - Tallo guía - Guide broche - Spiedo da guida

cm	inch	Ø 3,0 mm	Ø 3,5 mm	Ø 4,0 mm	Ø 5,0 mm
35,0	14	KA 4915/35	KA 4916/35	KA 4917/35	KA 4918/35
46,0	18	KA 4915/46	KA 4916/46	KA 4917/46	KA 4918/46
60,0	23 ¹ / ₂	KA 4915/60	KA 4916/60	KA 4917/60	KA 4918/60
		für Nägel bis for nails up to para clavos hasta pour clous jusqu'à per chiodi fino a Ø 8,0 mm	für Nägel for nails para clavos pour clous per chiodi Ø 9,0 mm Ø 10,0 mm Ø 11,0 mm		für Nägel ab for nails from para clavos desde pour clous à partir de per chiodi a partire da Ø 11,0 mm

AA
AB
AC
AD
AE
AF
AK
AL
AM
AO
AP
AR
KA
KB
KC
KD
KU
KY

Zubehör für Haken-Marknägel
 Accessories for Intramedullary Pins with Hooks
 Accesorios para clavos intramedulares con ganchos
 Accessoires pour broches centro-médullaires
 Accessori per chiodi centromidollari con gancio



KA 4919/20



Ø 2,5 mm KA 4920/02
 Ø 3,0 mm KA 4920/03
 Ø 5,0 mm KA 4920/05
 Ø 6,0 mm KA 4920/06



Ø 2,5 mm
 KA 4922/02



Ø 3,0 mm
 KA 4922/03



Ø 5,0 mm
 KA 4922/05



Ø 6,0 mm
 KA 4922/06

ORTHOPÄDIE ORTHOPAEDIC ORTOPEDIA ORTHOPEDIE ORTOPEDIA

Schraubenzieher
Screw Drivers
Destornilladores
Tournevis
Giravite

1,5 mm



2,5 mm



3,5 mm

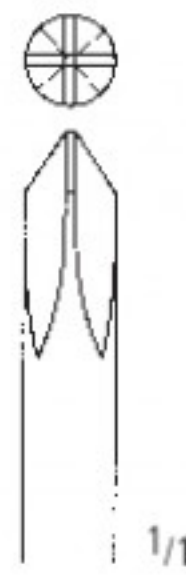
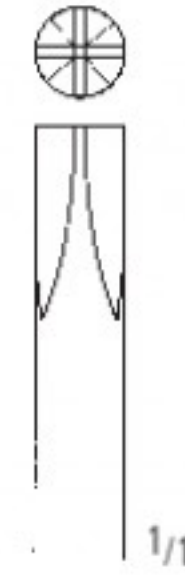
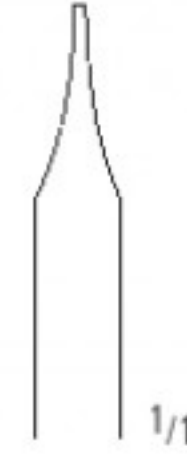
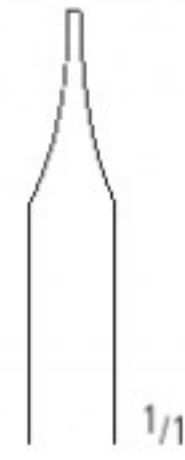
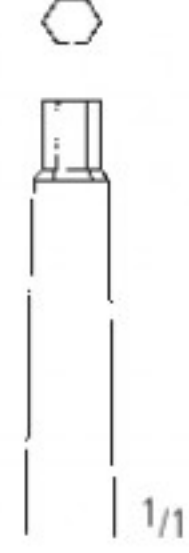

1/2



1/2



1/2



1/2



1/2



1/2



1/2

KA 4930/00
25,0 cm/10"

KA 4930/01
25,0 cm/10"

KA 4930/02
25,0 cm/10"

KA 4930/03
17,0 cm/6³/₄"

LANE
KA 4930/04
25,0 cm/10"

KA 4930/05
25,0 cm/10"

PHILIPS
KA 4930/06
25,0 cm/10"

AA
AB
AC
AD
AE
AF
AK
AL
AM
AO
AP
AR
KA
KB
KC
KD
KU
KY

KA ORTHOPÄDIE ORTHOPAEDIC ORTOPEDIA ORTHOPEDIE ORTOPEDIA

Küntscher Nägel, Oberschenkel
 Küntscher Intramedullary Nails, Femur
 Küntscher clavos intramedulares, fémur
 Clous centromédullaires selon Küntscher pour le fémur
 Chiodi centromidollari secondo Küntscher per femore



KÜNTSCHER

Single Slot

cm	"	6 mm	7 mm	8 mm	9 mm	10 mm	11 mm	12 mm
14,0	5 ^{1/2}	KA 5006/14	KA 5007/14					
16,0	6 ^{1/4}	KA 5006/16	KA 5007/16					
18,0	7	KA 5006/18	KA 5007/18					
20,0	8	KA 5006/20	KA 5007/20					
22,0	8 ^{3/4}	KA 5006/22	KA 5007/22					
24,0	9 ^{1/2}	KA 5006/24	KA 5007/24	KA 5008/24				
26,0	10 ^{1/2}	KA 5006/26	KA 5007/26	KA 5008/26				
28,0	11	KA 5006/28	KA 5007/28	KA 5008/28				
30,0	12	KA 5006/30	KA 5007/30	KA 5008/30	KA 5009/30			
32,0	12 ^{3/4}	KA 5006/32	KA 5007/32	KA 5008/32	KA 5009/32	KA 5010/32	KA 5011/32	
34,0	13 ^{1/3}	KA 5006/34	KA 5007/34	KA 5008/34	KA 5009/34	KA 5010/34	KA 5011/34	KA 5012/34
36,0	14	KA 5006/36	KA 5007/36	KA 5008/36	KA 5009/36	KA 5010/36	KA 5011/36	KA 5012/36
38,0	15 ^{1/4}		KA 5007/38	KA 5008/38	KA 5009/38	KA 5010/38	KA 5011/38	KA 5012/38
40,0	15 ^{3/4}		KA 5007/40	KA 5008/40	KA 5009/40	KA 5010/40	KA 5011/40	KA 5012/40
42,0	16 ^{1/2}			KA 5008/42	KA 5009/42	KA 5010/42	KA 5011/42	KA 5012/42
44,0	17 ^{1/3}			KA 5008/44	KA 5009/44	KA 5010/44	KA 5011/44	KA 5012/44
46,0	18			KA 5008/46	KA 5009/46	KA 5010/46	KA 5011/46	KA 5012/46
48,0	19			KA 5008/48	KA 5009/48	KA 5010/48	KA 5011/48	KA 5012/48
50,0	19 ^{3/4}			KA 5008/50	KA 5009/50	KA 5010/50	KA 5011/50	KA 5012/50
52,0	20 ^{1/2}				KA 5009/52	KA 5010/52	KA 5011/52	KA 5012/52

cm	"	13 mm	14 mm	15 mm	16 mm	17 mm	18 mm
14,0	5 ^{1/2}						
16,0	6 ^{1/4}						
18,0	7						
20,0	8						
22,0	8 ^{3/4}						
24,0	9 ^{1/2}						
26,0	10 ^{1/2}						
28,0	11						
30,0	12						
32,0	12 ^{3/4}						
34,0	13 ^{1/3}	KA 5013/34	KA 5014/34				
36,0	14	KA 5013/36	KA 5014/36	KA 5015/36	KA 5016/36	KA 5017/36	KA 5018/36
38,0	15 ^{1/4}	KA 5013/38	KA 5014/38	KA 5015/38	KA 5016/38	KA 5017/38	KA 5018/38
40,0	15 ^{3/4}	KA 5013/40	KA 5014/40	KA 5015/40	KA 5016/40	KA 5017/40	KA 5018/40
42,0	16 ^{1/2}	KA 5013/42	KA 5014/42	KA 5015/42	KA 5016/42	KA 5017/42	KA 5018/42
44,0	17 ^{1/3}	KA 5013/44	KA 5014/44	KA 5015/44	KA 5016/44	KA 5017/44	KA 5018/44
46,0	18	KA 5013/46	KA 5014/46	KA 5015/46	KA 5016/46	KA 5017/46	KA 5018/46
48,0	19	KA 5013/48	KA 5014/48	KA 5015/48	KA 5016/48	KA 5017/48	KA 5018/48
50,0	19 ^{3/4}	KA 5013/50	KA 5014/50	KA 5015/50	KA 5016/50	KA 5017/50	KA 5018/50
52,0	20 ^{1/2}	KA 5013/52	KA 5014/52	KA 5015/52	KA 5016/52	KA 5017/52	KA 5018/52

ORTHOPÄDIE ORTHOPAEDIC ORTOPEDIA ORTHOPEDIE ORTOPEDIA

Küntscher Nägel, Oberschenkel
 Küntscher Intramedullary Nails, Femur
 Küntscher clavos intramedulares, fémur
 Clous centromédullaires selon Küntscher pour le fémur
 Chiodi centromidollari secondo Küntscher per femore



KÜNTSCHER

Double Slot

cm	"	6 mm	7 mm	8 mm	9 mm	10 mm	11 mm	12 mm
14,0	5 ^{1/2}	KA 5026/14	KA 5027/14					
16,0	6 ^{1/4}	KA 5026/16	KA 5027/16					
18,0	7	KA 5026/18	KA 5027/18					
20,0	8	KA 5026/20	KA 5027/20					
22,0	8 ^{3/4}	KA 5026/22	KA 5027/22					
24,0	9 ^{1/2}	KA 5026/24	KA 5027/24	KA 5028/24				
26,0	10 ^{1/2}	KA 5026/26	KA 5027/26	KA 5028/26				
28,0	11	KA 5026/28	KA 5027/28	KA 5028/28				
30,0	12	KA 5026/30	KA 5027/30	KA 5028/30	KA 5029/30			
32,0	12 ^{3/4}	KA 5026/32	KA 5027/32	KA 5028/32	KA 5029/32	KA 5030/32	KA 5031/32	
34,0	13 ^{1/3}	KA 5026/34	KA 5027/34	KA 5028/34	KA 5029/34	KA 5030/34	KA 5031/34	KA 5032/34
36,0	14	KA 5026/36	KA 5027/36	KA 5028/36	KA 5029/36	KA 5030/36	KA 5031/36	KA 5032/36
38,0	15 ^{1/4}		KA 5027/38	KA 5028/38	KA 5029/38	KA 5030/38	KA 5031/38	KA 5032/38
40,0	15 ^{3/4}		KA 5027/40	KA 5028/40	KA 5029/40	KA 5030/40	KA 5031/40	KA 5032/40
42,0	16 ^{1/2}			KA 5028/42	KA 5029/42	KA 5030/42	KA 5031/42	KA 5032/42
44,0	17 ^{1/3}			KA 5028/44	KA 5029/44	KA 5030/44	KA 5031/44	KA 5032/44
46,0	18			KA 5028/46	KA 5029/46	KA 5030/46	KA 5031/46	KA 5032/46
48,0	19			KA 5028/48	KA 5029/48	KA 5030/48	KA 5031/48	KA 5032/48
50,0	19 ^{3/4}			KA 5028/50	KA 5029/50	KA 5030/50	KA 5031/50	KA 5032/50
52,0	20 ^{1/2}				KA 5029/52	KA 5030/52	KA 5031/52	KA 5032/52

cm	"	13 mm	14 mm	15 mm	16 mm	17 mm	18 mm
14,0	5 ^{1/2}						
16,0	6 ^{1/4}						
18,0	7						
20,0	8						
22,0	8 ^{3/4}						
24,0	9 ^{1/2}						
26,0	10 ^{1/2}						
28,0	11						
30,0	12						
32,0	12 ^{3/4}						
34,0	13 ^{1/3}	KA 5033/34	KA 5034/34				
36,0	14	KA 5033/36	KA 5034/36	KA 5035/36	KA 5036/36	KA 5037/36	KA 5038/36
38,0	15 ^{1/4}	KA 5033/38	KA 5034/38	KA 5035/38	KA 5036/38	KA 5037/38	KA 5038/38
40,0	15 ^{3/4}	KA 5033/40	KA 5034/40	KA 5035/40	KA 5036/40	KA 5037/40	KA 5038/40
42,0	16 ^{1/2}	KA 5033/42	KA 5034/42	KA 5035/42	KA 5036/42	KA 5037/42	KA 5038/42
44,0	17 ^{1/3}	KA 5033/44	KA 5034/44	KA 5035/44	KA 5036/44	KA 5037/44	KA 5038/44
46,0	18	KA 5033/46	KA 5034/46	KA 5035/46	KA 5036/46	KA 5037/46	KA 5038/46
48,0	19	KA 5033/48	KA 5034/48	KA 5035/48	KA 5036/48	KA 5037/48	KA 5038/48
50,0	19 ^{3/4}	KA 5033/50	KA 5034/50	KA 5035/50	KA 5036/50	KA 5037/50	KA 5038/50
52,0	20 ^{1/2}	KA 5033/52	KA 5034/52	KA 5035/52	KA 5036/52	KA 5037/52	KA 5038/52

AA
AB
AC
AD
AE
AF
AK
AL
AM
AO
AP
AR
KA
KB
KC
KD
KU
KY

KA ORTHOPÄDIE ORTHOPAEDIC ORTOPEDIA ORTHOPEDIE ORTOPEDIA

Küntscher Nägel für Unterschenkel und Oberarm
 Küntscher Intramedullary Nails, tibia and humerus
 Küntscher clavos intramedulares, tibia y húmero
 Clous centromédullaires selon Küntscher pour le tibia et l'humérus
 Chiodi centromidollari secondo Küntscher per tibia e omero



KÜNTSCHER

cm	"	6 mm	7 mm	8 mm	9 mm	10 mm	11 mm	12 mm	13 mm	14 mm
18,0	7	KA 5046/18	KA 5047/18	KA 5048/18	KA 5049/18	KA 5050/18	KA 5051/18	KA 5052/18	KA 5053/18	
19,0	7 ^{1/2}	KA 5046/19	KA 5047/19	KA 5048/19	KA 5049/19	KA 5050/19	KA 5051/19	KA 5052/19	KA 5053/19	
20,0	8	KA 5046/20	KA 5047/20	KA 5048/20	KA 5049/20	KA 5050/20	KA 5051/20	KA 5052/20	KA 5053/20	
21,0	8 ^{1/4}	KA 5046/21	KA 5047/21	KA 5048/21	KA 5049/21	KA 5050/21	KA 5051/21	KA 5052/21	KA 5053/21	
22,0	8 ^{3/4}	KA 5046/22	KA 5047/22	KA 5048/22	KA 5049/22	KA 5050/22	KA 5051/22	KA 5052/22	KA 5053/22	
23,0	9	KA 5046/23	KA 5047/23	KA 5048/23	KA 5049/23	KA 5050/23	KA 5051/23	KA 5052/23	KA 5053/23	
24,0	9 ^{1/2}	KA 5046/24	KA 5047/24	KA 5048/24	KA 5049/24	KA 5050/24	KA 5051/24	KA 5052/24	KA 5053/24	
25,0	10	KA 5046/25	KA 5047/25	KA 5048/25	KA 5049/25	KA 5050/25	KA 5051/25	KA 5052/25	KA 5053/25	
26,0	10 ^{1/2}	KA 5046/26	KA 5047/26	KA 5048/26	KA 5049/26	KA 5050/26	KA 5051/26	KA 5052/26	KA 5053/26	
27,0	10 ^{3/4}	KA 5046/27	KA 5047/27	KA 5048/27	KA 5049/27	KA 5050/27	KA 5051/27	KA 5052/27	KA 5053/27	
28,0	11	KA 5046/28	KA 5047/28	KA 5048/28	KA 5049/28	KA 5050/28	KA 5051/28	KA 5052/28	KA 5053/28	
29,0	11 ^{1/2}	KA 5046/29	KA 5047/29	KA 5048/29	KA 5049/29	KA 5050/29	KA 5051/29	KA 5052/29	KA 5053/29	
30,0	12	KA 5046/30	KA 5047/30	KA 5048/30	KA 5049/30	KA 5050/30	KA 5051/30	KA 5052/30	KA 5053/30	KA 5054/30
31,0	12 ^{1/4}		KA 5047/31	KA 5048/31	KA 5049/31	KA 5050/31	KA 5051/31	KA 5052/31	KA 5053/31	KA 5054/31
32,0	12 ^{3/4}		KA 5047/32	KA 5048/32	KA 5049/32	KA 5050/32	KA 5051/32	KA 5052/32	KA 5053/32	KA 5054/32
33,0	13		KA 5047/33	KA 5048/33	KA 5049/33	KA 5050/33	KA 5051/33	KA 5052/33	KA 5053/33	KA 5054/33
34,0	13 ^{1/3}		KA 5047/34	KA 5048/34	KA 5049/34	KA 5050/34	KA 5051/34	KA 5052/34	KA 5053/34	KA 5054/34
35,0	13 ^{1/4}		KA 5047/35	KA 5048/35	KA 5049/35	KA 5050/35	KA 5051/35	KA 5052/35	KA 5053/35	KA 5054/35
36,0	14		KA 5047/36	KA 5048/36	KA 5049/36	KA 5050/36	KA 5051/36	KA 5052/36	KA 5053/36	KA 5054/36
37,0	14 ^{1/2}		KA 5047/37	KA 5048/37	KA 5049/37	KA 5050/37	KA 5051/37	KA 5052/37	KA 5053/37	KA 5054/37
38,0	15 ^{1/4}		KA 5047/38	KA 5048/38	KA 5049/38	KA 5050/38	KA 5051/38	KA 5052/38	KA 5053/38	KA 5054/38
39,0	15 ^{1/3}		KA 5047/39	KA 5048/39	KA 5049/39	KA 5050/39	KA 5051/39	KA 5052/39	KA 5053/39	KA 5054/39
40,0	15 ^{3/4}		KA 5047/40	KA 5048/40	KA 5049/40	KA 5050/40	KA 5051/40	KA 5052/40	KA 5053/40	KA 5054/40

ORTHOPÄDIE ORTHOPAEDIC ORTOPEDIA ORTHOPEDIE ORTOPEDIA

Marknägel, rund, mit Haken
 Intramedullary Pins, round, with hook
 Clavos intramedulares, redondos, con gancho
 Broches à crochet pour enclouage centro-médullaire, rondes
 Chiodi a gancio per inchiodamento centromidollare, rotondi

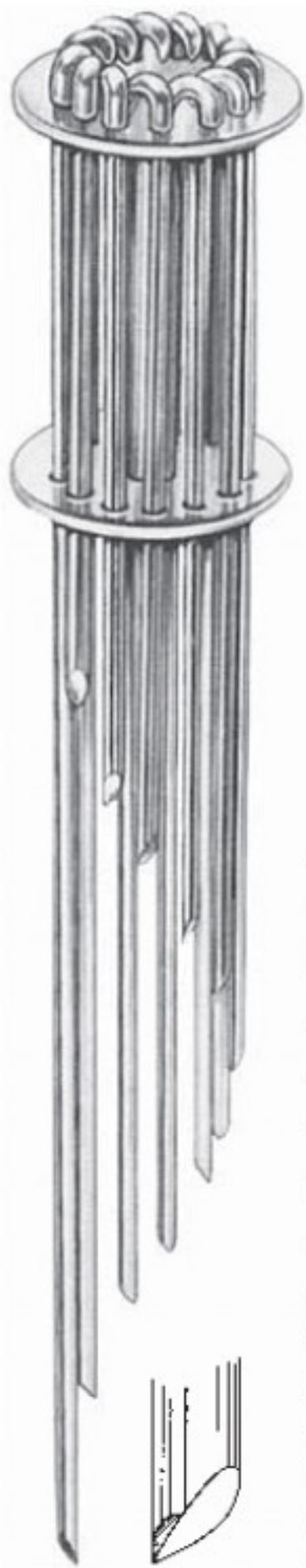

Länge
 length
 largo
 longueur
 lunghezza
 mm
 25
 30
 40
 45
 50
 60
 65
 70
 75
 85
 90
 95
 100
 120
 130
 140
 150
 160
 180
 190
 200
 210
 220
 230
 240
 250
 260
 280
 290
 300
 320
 340
 360
 370
 390
 410
 430

Satz - set - juego - jeu - serie

KA 5080/00 Ø 2,5 mm	KA 5081/00 Ø 3,0 mm	KA 5082/00 Ø 5,0 mm	KA 5083/00 Ø 5,0 mm
KA 5080/25			
KA 5080/30			
KA 5080/40			
KA 5080/45			
KA 5080/50			
KA 5080/60			
KA 5080/65			
KA 5080/70			
KA 5080/75			
KA 5080/85			
KA 5080/90			
KA 5080/95			
KA 5080/99			
	KA 5081/10		
	KA 5081/12		
	KA 5081/13		
	KA 5081/14		
	KA 5081/15		
	KA 5081/16		
	KA 5081/18		
	KA 5081/19		
	KA 5081/20	KA 5082/20	
	KA 5081/21		
		KA 5082/22	
	KA 5081/23		
	KA 5081/24	KA 5082/24	
	KA 5081/25		
		KA 5082/26	
		KA 5082/28	KA 5083/28
			KA 5083/29
		KA 5082/30	
		KA 5082/32	KA 5083/32
		KA 5082/34	KA 5083/34
		KA 5082/36	KA 5083/36
			KA 5083/37
			KA 5083/39
			KA 5083/41
			KA 5083/43

KA 5080/00
KA 5080/25 - KA 5080/99
 für Finger und Fuß
 for small bones
 para huesos pequeños
 pour les petits os
 per le ossa piccole

KA 5081/00
KA 5081/10 - KA 5081/25
 für Unterarm und Clavicula
 for radius, ulna and clavica
 para radio, ulna y clavícula
 pour radius, cubitus et clavicule
 per radio, ulna e clavicola

KA 5082/00
KA 5082/20 - KA 5082/36
 für Unterschenkel und Oberarm
 for tibia and humeros
 para tibia y humero
 pour tibia et humérus
 per tibia e omero

KA 5083/00
KA 5083/28 - KA 5083/43
 für Ober- und Unterschenkel
 for femur and tibia
 para fémur y tibia
 pour fémur et tibia
 per femore e tibia

AA
 AB
 AC
 AD
 AE
 AF
 AK
 AL
 AM
 AO
 AP
 AR
 KA
 KB
 KC
 KD
 KU
 KY

Nägel, Klammern
 Fracture Pins, Clips
 Clavos para huesos, Grapas
 Clous à os, agrafes
 Chiodi per ossa, grappas

WILDBERG

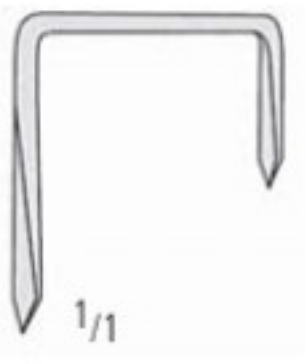

KA 5087/16

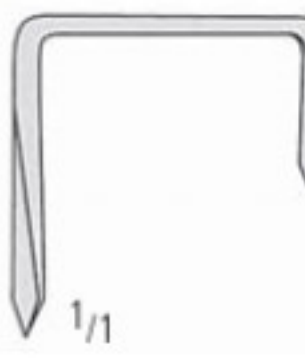

KA 5087/19



KA 5087/22



PALMER
 Ø 1,5 mm

KA 5090/15	15 mm
KA 5090/20	20 mm
KA 5090/25	25 mm
KA 5090/35	35 mm
KA 5090/40	40 mm
KA 5090/45	45 mm
KA 5090/50	50 mm
KA 5090/55	55 mm
KA 5090/60	60 mm
KA 5090/65	65 mm
KA 5090/70	70 mm

Steinmann Nägel
 Steinmann Pins
 Clavos Steinmann
 Clous Steinmann
 Aghi Steinmann



	3,2 mm	3,5 mm	4,0 mm	4,2 mm	4,5 mm	4,8 mm	5,0 mm	5,5 mm	6,0 mm
10,0 cm	KA 5301/10	KA 5302/10	KA 5303/10	KA 5304/10	KA 5305/10	KA 5306/10	KA 5307/10	KA 5308/10	KA 5309/10
15,0 cm	KA 5301/15	KA 5302/15	KA 5303/15	KA 5304/15	KA 5305/15	KA 5306/15	KA 5307/15	KA 5308/15	KA 5309/15
18,0 cm	KA 5301/18	KA 5302/18	KA 5303/18	KA 5304/18	KA 5305/18	KA 5306/18	KA 5307/18	KA 5308/18	KA 5309/18
20,0 cm	KA 5301/20	KA 5302/20	KA 5303/20	KA 5304/20	KA 5305/20	KA 5306/20	KA 5307/20	KA 5308/20	KA 5309/20
22,0 cm	KA 5301/22	KA 5302/22	KA 5303/22	KA 5304/22	KA 5305/22	KA 5306/22	KA 5307/22	KA 5308/22	KA 5309/22
23,5 cm	KA 5301/23	KA 5302/23	KA 5303/23	KA 5304/23	KA 5305/23	KA 5306/23	KA 5307/23	KA 5308/23	KA 5309/23
25,0 cm	KA 5301/25	KA 5302/25	KA 5303/25	KA 5304/25	KA 5305/25	KA 5306/25	KA 5307/25	KA 5308/25	KA 5309/25
28,0 cm	KA 5301/28	KA 5302/28	KA 5303/28	KA 5304/28	KA 5305/28	KA 5306/28	KA 5307/28	KA 5308/28	KA 5309/28
30,0 cm	KA 5301/30	KA 5302/30	KA 5303/30	KA 5304/30	KA 5305/30	KA 5306/30	KA 5307/30	KA 5308/30	KA 5309/30



	3,2 mm	3,5 mm	4,0 mm	4,2 mm	4,5 mm	4,8 mm	5,0 mm	5,5 mm	6,0 mm
10,0 cm	KA 5311/10	KA 5312/10	KA 5313/10	KA 5314/10	KA 5315/10	KA 5316/10	KA 5317/10	KA 5318/10	KA 5319/10
15,0 cm	KA 5311/15	KA 5312/15	KA 5313/15	KA 5314/15	KA 5315/15	KA 5316/15	KA 5317/15	KA 5318/15	KA 5319/15
18,0 cm	KA 5311/18	KA 5312/18	KA 5313/18	KA 5314/18	KA 5315/18	KA 5316/18	KA 5317/18	KA 5318/18	KA 5319/18
20,0 cm	KA 5311/20	KA 5312/20	KA 5313/20	KA 5314/20	KA 5315/20	KA 5316/20	KA 5317/20	KA 5318/20	KA 5319/20
22,0 cm	KA 5311/22	KA 5312/22	KA 5313/22	KA 5314/22	KA 5315/22	KA 5316/22	KA 5317/22	KA 5318/22	KA 5319/22
23,5 cm	KA 5311/23	KA 5312/23	KA 5313/23	KA 5314/23	KA 5315/23	KA 5316/23	KA 5317/23	KA 5318/23	KA 5319/23
25,0 cm	KA 5311/25	KA 5312/25	KA 5313/25	KA 5314/25	KA 5315/25	KA 5316/25	KA 5317/25	KA 5318/25	KA 5319/25
28,0 cm	KA 5311/28	KA 5312/28	KA 5313/28	KA 5314/28	KA 5315/28	KA 5316/28	KA 5317/28	KA 5318/28	KA 5319/28
30,0 cm	KA 5311/30	KA 5312/30	KA 5313/30	KA 5314/30	KA 5315/30	KA 5316/30	KA 5317/30	KA 5318/30	KA 5319/30

AA
AB
AC
AD
AE
AF
AK
AL
AM
AO
AP
AR
KA
KB
KC
KD
KU
KY

Steinmann Nägel
 Steinmann Pins
 Clavos Steinmann
 Clous Steinmann
 Aghi Steinmann



STEINMANN

	3,2 mm	3,5 mm	4,0 mm	4,2 mm	4,5 mm	4,8 mm	5,0 mm	5,5 mm	6,0 mm
10,0 cm	KA 5321/10	KA 5322/10	KA 5323/10	KA 5324/10	KA 5325/10	KA 5326/10	KA 5327/10	KA 5328/10	KA 5329/10
15,0 cm	KA 5321/15	KA 5322/15	KA 5323/15	KA 5324/15	KA 5325/15	KA 5326/15	KA 5327/15	KA 5328/15	KA 5329/15
18,0 cm	KA 5321/18	KA 5322/18	KA 5323/18	KA 5324/18	KA 5325/18	KA 5326/18	KA 5327/18	KA 5328/18	KA 5329/18
20,0 cm	KA 5321/20	KA 5322/20	KA 5323/20	KA 5324/20	KA 5325/20	KA 5326/20	KA 5327/20	KA 5328/20	KA 5329/20
22,0 cm	KA 5321/22	KA 5322/22	KA 5323/22	KA 5324/22	KA 5325/22	KA 5326/22	KA 5327/22	KA 5328/22	KA 5329/22
23,5 cm	KA 5321/23	KA 5322/23	KA 5323/23	KA 5324/23	KA 5325/23	KA 5326/23	KA 5327/23	KA 5328/23	KA 5329/23
25,0 cm	KA 5321/25	KA 5322/25	KA 5323/25	KA 5324/25	KA 5325/25	KA 5326/25	KA 5327/25	KA 5328/25	KA 5329/25
28,0 cm	KA 5321/28	KA 5322/28	KA 5323/28	KA 5324/28	KA 5325/28	KA 5326/28	KA 5327/28	KA 5328/28	KA 5329/28
30,0 cm	KA 5321/30	KA 5322/30	KA 5323/30	KA 5324/30	KA 5325/30	KA 5326/30	KA 5327/30	KA 5328/30	KA 5329/30

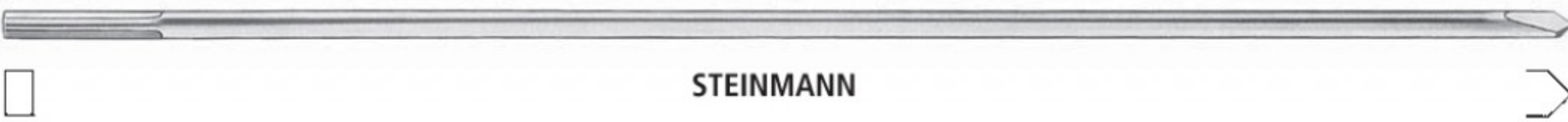

STEINMANN

	3,2 mm	3,5 mm	4,0 mm	4,2 mm	4,5 mm	4,8 mm	5,0 mm	5,5 mm	6,0 mm
10,0 cm	KA 5331/10	KA 5332/10	KA 5333/10	KA 5334/10	KA 5335/10	KA 5336/10	KA 5337/10	KA 5338/10	KA 5339/10
15,0 cm	KA 5331/15	KA 5332/15	KA 5333/15	KA 5334/15	KA 5335/15	KA 5336/15	KA 5337/15	KA 5338/15	KA 5339/15
18,0 cm	KA 5331/18	KA 5332/18	KA 5333/18	KA 5334/18	KA 5335/18	KA 5336/18	KA 5337/18	KA 5338/18	KA 5339/18
20,0 cm	KA 5331/20	KA 5332/20	KA 5333/20	KA 5334/20	KA 5335/20	KA 5336/20	KA 5337/20	KA 5338/20	KA 5339/20
22,0 cm	KA 5331/22	KA 5332/22	KA 5333/22	KA 5334/22	KA 5335/22	KA 5336/22	KA 5337/22	KA 5338/22	KA 5339/22
23,5 cm	KA 5331/23	KA 5332/23	KA 5333/23	KA 5334/23	KA 5335/23	KA 5336/23	KA 5337/23	KA 5338/23	KA 5339/23
25,0 cm	KA 5331/25	KA 5332/25	KA 5333/25	KA 5334/25	KA 5335/25	KA 5336/25	KA 5337/25	KA 5338/25	KA 5339/25
28,0 cm	KA 5331/28	KA 5332/28	KA 5333/28	KA 5334/28	KA 5335/28	KA 5336/28	KA 5337/28	KA 5338/28	KA 5339/28
30,0 cm	KA 5331/30	KA 5332/30	KA 5333/30	KA 5334/30	KA 5335/30	KA 5336/30	KA 5337/30	KA 5338/30	KA 5339/30

ORTHOPÄDIE ORTHOPAEDIC ORTOPEDIA ORTHOPEDIE ORTOPEDIA

Kirschner Bohrdrähte
Kirschner Wires
Agujas Kirschner
Broches de Kirschner
Fili Kirschner

AA
AB
AC
AD
AE
AF
AK
AL
AM
AO
AP
AR
KA
KB
KC
KD
KU
KY



KIRSCHNER

	60 mm	70 mm	80 mm	120 mm	140 mm	160 mm	230 mm	310 mm
0,6 mm	KA 5401/06	KA 5402/06	KA 5403/06	KA 5404/06	KA 5405/06	KA 5406/06	KA 5407/06	KA 5408/06
0,8 mm	KA 5401/08	KA 5402/08	KA 5403/08	KA 5404/08	KA 5405/08	KA 5406/08	KA 5407/08	KA 5408/08
0,9 mm	KA 5401/09	KA 5402/09	KA 5403/09	KA 5404/09	KA 5405/09	KA 5406/09	KA 5407/09	KA 5408/09
1,0 mm	KA 5401/10	KA 5402/10	KA 5403/10	KA 5404/10	KA 5405/10	KA 5406/10	KA 5407/10	KA 5408/10
1,2 mm	KA 5401/12	KA 5402/12	KA 5403/12	KA 5404/12	KA 5405/12	KA 5406/12	KA 5407/12	KA 5408/12
1,4 mm	KA 5401/14	KA 5402/14	KA 5403/14	KA 5404/14	KA 5405/14	KA 5406/14	KA 5407/14	KA 5408/14
1,5 mm	KA 5401/15	KA 5402/15	KA 5403/15	KA 5404/15	KA 5405/15	KA 5406/15	KA 5407/15	KA 5408/15
1,6 mm	KA 5401/16	KA 5402/16	KA 5403/16	KA 5404/16	KA 5405/16	KA 5406/16	KA 5407/16	KA 5408/16
1,7 mm	KA 5401/17	KA 5402/17	KA 5403/17	KA 5404/17	KA 5405/17	KA 5406/17	KA 5407/17	KA 5408/17
1,8 mm	KA 5401/18	KA 5402/18	KA 5403/18	KA 5404/18	KA 5405/18	KA 5406/18	KA 5407/18	KA 5408/18
2,0 mm	KA 5401/20	KA 5402/20	KA 5403/20	KA 5404/20	KA 5405/20	KA 5406/20	KA 5407/20	KA 5408/20
2,2 mm	KA 5401/22	KA 5402/22	KA 5403/22	KA 5404/22	KA 5405/22	KA 5406/22	KA 5407/22	KA 5408/22
2,5 mm	KA 5401/25	KA 5402/25	KA 5403/25	KA 5404/25	KA 5405/25	KA 5406/25	KA 5407/25	KA 5408/25
3,0 mm	KA 5401/30	KA 5402/30	KA 5403/30	KA 5404/30	KA 5405/30	KA 5406/30	KA 5407/30	KA 5408/30



KIRSCHNER

	60 mm	70 mm	80 mm	120 mm	140 mm	160 mm	230 mm	310 mm
0,6 mm	KA 5411/06	KA 5412/06	KA 5413/06	KA 5414/06	KA 5415/06	KA 5416/06	KA 5417/06	KA 5418/06
0,8 mm	KA 5411/08	KA 5412/08	KA 5413/08	KA 5414/08	KA 5415/08	KA 5416/08	KA 5417/08	KA 5418/08
0,9 mm	KA 5411/09	KA 5412/09	KA 5413/09	KA 5414/09	KA 5415/09	KA 5416/09	KA 5417/09	KA 5418/09
1,0 mm	KA 5411/10	KA 5412/10	KA 5413/10	KA 5414/10	KA 5415/10	KA 5416/10	KA 5417/10	KA 5418/10
1,2 mm	KA 5411/12	KA 5412/12	KA 5413/12	KA 5414/12	KA 5415/12	KA 5416/12	KA 5417/12	KA 5418/12
1,4 mm	KA 5411/14	KA 5412/14	KA 5413/14	KA 5414/14	KA 5415/14	KA 5416/14	KA 5417/14	KA 5418/14
1,5 mm	KA 5411/15	KA 5412/15	KA 5413/15	KA 5414/15	KA 5415/15	KA 5416/15	KA 5417/15	KA 5418/15
1,6 mm	KA 5411/16	KA 5412/16	KA 5413/16	KA 5414/16	KA 5415/16	KA 5416/16	KA 5417/16	KA 5418/16
1,7 mm	KA 5411/17	KA 5412/17	KA 5413/17	KA 5414/17	KA 5415/17	KA 5416/17	KA 5417/17	KA 5418/17
1,8 mm	KA 5411/18	KA 5412/18	KA 5413/18	KA 5414/18	KA 5415/18	KA 5416/18	KA 5417/18	KA 5418/18
2,0 mm	KA 5411/20	KA 5412/20	KA 5413/20	KA 5414/20	KA 5415/20	KA 5416/20	KA 5417/20	KA 5418/20
2,2 mm	KA 5411/22	KA 5412/22	KA 5413/22	KA 5414/22	KA 5415/22	KA 5416/22	KA 5417/22	KA 5418/22
2,5 mm	KA 5411/25	KA 5412/25	KA 5413/25	KA 5414/25	KA 5415/25	KA 5416/25	KA 5417/25	KA 5418/25
3,0 mm	KA 5411/30	KA 5412/30	KA 5413/30	KA 5414/30	KA 5415/30	KA 5416/30	KA 5417/30	KA 5418/30

Kirschner Bohrdrähte
Kirschner Wires
Agujas Kirschner
Broches de Kirschner
Fili Kirschner



KIRSCHNER

	60 mm	70 mm	80 mm	120 mm	140 mm	160 mm	230 mm	310 mm
0,6 mm	KA 5421/06	KA 5422/06	KA 5423/06	KA 5424/06	KA 5425/06	KA 5426/06	KA 5427/06	KA 5428/06
0,8 mm	KA 5421/08	KA 5422/08	KA 5423/08	KA 5424/08	KA 5425/08	KA 5426/08	KA 5427/08	KA 5428/08
0,9 mm	KA 5421/09	KA 5422/09	KA 5423/09	KA 5424/09	KA 5425/09	KA 5426/09	KA 5427/09	KA 5428/09
1,0 mm	KA 5421/10	KA 5422/10	KA 5423/10	KA 5424/10	KA 5425/10	KA 5426/10	KA 5427/10	KA 5428/10
1,2 mm	KA 5421/12	KA 5422/12	KA 5423/12	KA 5424/12	KA 5425/12	KA 5426/12	KA 5427/12	KA 5428/12
1,4 mm	KA 5421/14	KA 5422/14	KA 5423/14	KA 5424/14	KA 5425/14	KA 5426/14	KA 5427/14	KA 5428/14
1,5 mm	KA 5421/15	KA 5422/15	KA 5423/15	KA 5424/15	KA 5425/15	KA 5426/15	KA 5427/15	KA 5428/15
1,6 mm	KA 5421/16	KA 5422/16	KA 5423/16	KA 5424/16	KA 5425/16	KA 5426/16	KA 5427/16	KA 5428/16
1,7 mm	KA 5421/17	KA 5422/17	KA 5423/17	KA 5424/17	KA 5425/17	KA 5426/17	KA 5427/17	KA 5428/17
1,8 mm	KA 5421/18	KA 5422/18	KA 5423/18	KA 5424/18	KA 5425/18	KA 5426/18	KA 5427/18	KA 5428/18
2,0 mm	KA 5421/20	KA 5422/20	KA 5423/20	KA 5424/20	KA 5425/20	KA 5426/20	KA 5427/20	KA 5428/20
2,2 mm	KA 5421/22	KA 5422/22	KA 5423/22	KA 5424/22	KA 5425/22	KA 5426/22	KA 5427/22	KA 5428/22
2,5 mm	KA 5421/25	KA 5422/25	KA 5423/25	KA 5424/25	KA 5425/25	KA 5426/25	KA 5427/25	KA 5428/25
3,0 mm	KA 5421/30	KA 5422/30	KA 5423/30	KA 5424/30	KA 5425/30	KA 5426/30	KA 5427/30	KA 5428/30



KIRSCHNER

	60 mm	70 mm	80 mm	120 mm	140 mm	160 mm	230 mm	310 mm
0,6 mm	KA 5431/06	KA 5432/06	KA 5433/06	KA 5434/06	KA 5435/06	KA 5436/06	KA 5437/06	KA 5438/06
0,8 mm	KA 5431/08	KA 5432/08	KA 5433/08	KA 5434/08	KA 5435/08	KA 5436/08	KA 5437/08	KA 5438/08
0,9 mm	KA 5431/09	KA 5432/09	KA 5433/09	KA 5434/09	KA 5435/09	KA 5436/09	KA 5437/09	KA 5438/09
1,0 mm	KA 5431/10	KA 5432/10	KA 5433/10	KA 5434/10	KA 5435/10	KA 5436/10	KA 5437/10	KA 5438/10
1,2 mm	KA 5431/12	KA 5432/12	KA 5433/12	KA 5434/12	KA 5435/12	KA 5436/12	KA 5437/12	KA 5438/12
1,4 mm	KA 5431/14	KA 5432/14	KA 5433/14	KA 5434/14	KA 5435/14	KA 5436/14	KA 5437/14	KA 5438/14
1,5 mm	KA 5431/15	KA 5432/15	KA 5433/15	KA 5434/15	KA 5435/15	KA 5436/15	KA 5437/15	KA 5438/15
1,6 mm	KA 5431/16	KA 5432/16	KA 5433/16	KA 5434/16	KA 5435/16	KA 5436/16	KA 5437/16	KA 5438/16
1,7 mm	KA 5431/17	KA 5432/17	KA 5433/17	KA 5434/17	KA 5435/17	KA 5436/17	KA 5437/17	KA 5438/17
1,8 mm	KA 5431/18	KA 5432/18	KA 5433/18	KA 5434/18	KA 5435/18	KA 5436/18	KA 5437/18	KA 5438/18
2,0 mm	KA 5431/20	KA 5432/20	KA 5433/20	KA 5434/20	KA 5435/20	KA 5436/20	KA 5437/20	KA 5438/20
2,2 mm	KA 5431/22	KA 5432/22	KA 5433/22	KA 5434/22	KA 5435/22	KA 5436/22	KA 5437/22	KA 5438/22
2,5 mm	KA 5431/25	KA 5432/25	KA 5433/25	KA 5434/25	KA 5435/25	KA 5436/25	KA 5437/25	KA 5438/25
3,0 mm	KA 5431/30	KA 5432/30	KA 5433/30	KA 5434/30	KA 5435/30	KA 5436/30	KA 5437/30	KA 5438/30

ORTHOPÄDIE ORTHOPAEDIC ORTOPEDIA ORTHOPEDIE ORTOPEDIA

Kirschner Bohrdrähte
Kirschner Wires
Agujas Kirschner
Broches de Kirschner
Fili Kirschner

AA
AB
AC
AD
AE
AF
AK
AL
AM
AO
AP
AR
KA
KB
KC
KD
KU
KY



KIRSCHNER

	60 mm	70 mm	80 mm	120 mm	140 mm	160 mm	230 mm	310 mm
0,6 mm	KA 5451/06	KA 5452/06	KA 5453/06	KA 5454/06	KA 5455/06	KA 5456/06	KA 5457/06	KA 5458/06
0,8 mm	KA 5451/08	KA 5452/08	KA 5453/08	KA 5454/08	KA 5455/08	KA 5456/08	KA 5457/08	KA 5458/08
0,9 mm	KA 5451/09	KA 5452/09	KA 5453/09	KA 5454/09	KA 5455/09	KA 5456/09	KA 5457/09	KA 5458/09
1,0 mm	KA 5451/10	KA 5452/10	KA 5453/10	KA 5454/10	KA 5455/10	KA 5456/10	KA 5457/10	KA 5458/10
1,2 mm	KA 5451/12	KA 5452/12	KA 5453/12	KA 5454/12	KA 5455/12	KA 5456/12	KA 5457/12	KA 5458/12
1,4 mm	KA 5451/14	KA 5452/14	KA 5453/14	KA 5454/14	KA 5455/14	KA 5456/14	KA 5457/14	KA 5458/14
1,5 mm	KA 5451/15	KA 5452/15	KA 5453/15	KA 5454/15	KA 5455/15	KA 5456/15	KA 5457/15	KA 5458/15
1,6 mm	KA 5451/16	KA 5452/16	KA 5453/16	KA 5454/16	KA 5455/16	KA 5456/16	KA 5457/16	KA 5458/16
1,7 mm	KA 5451/17	KA 5452/17	KA 5453/17	KA 5454/17	KA 5455/17	KA 5456/17	KA 5457/17	KA 5458/17
1,8 mm	KA 5451/18	KA 5452/18	KA 5453/18	KA 5454/18	KA 5455/18	KA 5456/18	KA 5457/18	KA 5458/18
2,0 mm	KA 5451/20	KA 5452/20	KA 5453/20	KA 5454/20	KA 5455/20	KA 5456/20	KA 5457/20	KA 5458/20
2,2 mm	KA 5451/22	KA 5452/22	KA 5453/22	KA 5454/22	KA 5455/22	KA 5456/22	KA 5457/22	KA 5458/22
2,5 mm	KA 5451/25	KA 5452/25	KA 5453/25	KA 5454/25	KA 5455/25	KA 5456/25	KA 5457/25	KA 5458/25
3,0 mm	KA 5451/30	KA 5452/30	KA 5453/30	KA 5454/30	KA 5455/30	KA 5456/30	KA 5457/30	KA 5458/30



KIRSCHNER

	60 mm	70 mm	80 mm	120 mm	140 mm	160 mm	230 mm	310 mm
0,6 mm	KA 5461/06	KA 5462/06	KA 5463/06	KA 5464/06	KA 5465/06	KA 5466/06	KA 5467/06	KA 5468/06
0,8 mm	KA 5461/08	KA 5462/08	KA 5463/08	KA 5464/08	KA 5465/08	KA 5466/08	KA 5467/08	KA 5468/08
0,9 mm	KA 5461/09	KA 5462/09	KA 5463/09	KA 5464/09	KA 5465/09	KA 5466/09	KA 5467/09	KA 5468/09
1,0 mm	KA 5461/10	KA 5462/10	KA 5463/10	KA 5464/10	KA 5465/10	KA 5466/10	KA 5467/10	KA 5468/10
1,2 mm	KA 5461/12	KA 5462/12	KA 5463/12	KA 5464/12	KA 5465/12	KA 5466/12	KA 5467/12	KA 5468/12
1,4 mm	KA 5461/14	KA 5462/14	KA 5463/14	KA 5464/14	KA 5465/14	KA 5466/14	KA 5467/14	KA 5468/14
1,5 mm	KA 5461/15	KA 5462/15	KA 5463/15	KA 5464/15	KA 5465/15	KA 5466/15	KA 5467/15	KA 5468/15
1,6 mm	KA 5461/16	KA 5462/16	KA 5463/16	KA 5464/16	KA 5465/16	KA 5466/16	KA 5467/16	KA 5468/16
1,7 mm	KA 5461/17	KA 5462/17	KA 5463/17	KA 5464/17	KA 5465/17	KA 5466/17	KA 5467/17	KA 5468/17
1,8 mm	KA 5461/18	KA 5462/18	KA 5463/18	KA 5464/18	KA 5465/18	KA 5466/18	KA 5467/18	KA 5468/18
2,0 mm	KA 5461/20	KA 5462/20	KA 5463/20	KA 5464/20	KA 5465/20	KA 5466/20	KA 5467/20	KA 5468/20
2,2 mm	KA 5461/22	KA 5462/22	KA 5463/22	KA 5464/22	KA 5465/22	KA 5466/22	KA 5467/22	KA 5468/22
2,5 mm	KA 5461/25	KA 5462/25	KA 5463/25	KA 5464/25	KA 5465/25	KA 5466/25	KA 5467/25	KA 5468/25
3,0 mm	KA 5461/30	KA 5462/30	KA 5463/30	KA 5464/30	KA 5465/30	KA 5466/30	KA 5467/30	KA 5468/30

Kirschner Bohrdrähte
 Kirschner Wires
 Agujas Kirschner
 Broches de Kirschner
 Fili Kirschner



	60 mm	70 mm	80 mm	120 mm	140 mm	160 mm	230 mm	310 mm
0,6 mm	KA 5471/06	KA 5472/06	KA 5473/06	KA 5474/06	KA 5475/06	KA 5476/06	KA 5477/06	KA 5478/06
0,8 mm	KA 5471/08	KA 5472/08	KA 5473/08	KA 5474/08	KA 5475/08	KA 5476/08	KA 5477/08	KA 5478/08
0,9 mm	KA 5471/09	KA 5472/09	KA 5473/09	KA 5474/09	KA 5475/09	KA 5476/09	KA 5477/09	KA 5478/09
1,0 mm	KA 5471/10	KA 5472/10	KA 5473/10	KA 5474/10	KA 5475/10	KA 5476/10	KA 5477/10	KA 5478/10
1,2 mm	KA 5471/12	KA 5472/12	KA 5473/12	KA 5474/12	KA 5475/12	KA 5476/12	KA 5477/12	KA 5478/12
1,4 mm	KA 5471/14	KA 5472/14	KA 5473/14	KA 5474/14	KA 5475/14	KA 5476/14	KA 5477/14	KA 5478/14
1,5 mm	KA 5471/15	KA 5472/15	KA 5473/15	KA 5474/15	KA 5475/15	KA 5476/15	KA 5477/15	KA 5478/15
1,6 mm	KA 5471/16	KA 5472/16	KA 5473/16	KA 5474/16	KA 5475/16	KA 5476/16	KA 5477/16	KA 5478/16
1,7 mm	KA 5471/17	KA 5472/17	KA 5473/17	KA 5474/17	KA 5475/17	KA 5476/17	KA 5477/17	KA 5478/17
1,8 mm	KA 5471/18	KA 5472/18	KA 5473/18	KA 5474/18	KA 5475/18	KA 5476/18	KA 5477/18	KA 5478/18
2,0 mm	KA 5471/20	KA 5472/20	KA 5473/20	KA 5474/20	KA 5475/20	KA 5476/20	KA 5477/20	KA 5478/20
2,2 mm	KA 5471/22	KA 5472/22	KA 5473/22	KA 5474/22	KA 5475/22	KA 5476/22	KA 5477/22	KA 5478/22
2,5 mm	KA 5471/25	KA 5472/25	KA 5473/25	KA 5474/25	KA 5475/25	KA 5476/25	KA 5477/25	KA 5478/25
3,0 mm	KA 5471/30	KA 5472/30	KA 5473/30	KA 5474/30	KA 5475/30	KA 5476/30	KA 5477/30	KA 5478/30

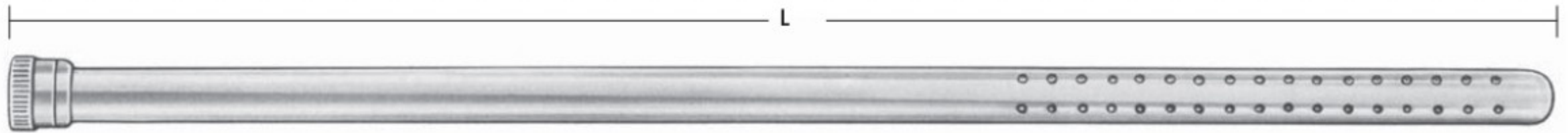

1/1

KIRSCHNER

- 15,5 cm KA 5540/15
- 19,0 cm KA 5540/19
- 32,0 cm KA 5540/32



SCHANZ

	100 mm	120 mm	150 mm	170 mm	200 mm	250 mm
3,0 mm	KA 5560/30	KA 5562/30	KA 5564/30	KA 5566/30	KA 5568/30	KA 5570/30
3,5 mm	KA 5560/35	KA 5562/35	KA 5564/35	KA 5566/35	KA 5568/35	KA 5570/35
4,0 mm	KA 5560/40	KA 5562/40	KA 5564/40	KA 5566/40	KA 5568/40	KA 5570/40
4,5 mm	KA 5560/45	KA 5562/45	KA 5564/45	KA 5566/45	KA 5568/45	KA 5570/45
5,0 mm	KA 5560/50	KA 5562/50	KA 5564/50	KA 5566/50	KA 5568/50	KA 5570/50

AA
AB
AC
AD
AE
AF
AK
AL
AM
AO
AP
AR
KA
KB
KC
KD
KU
KY

Knochen-Schrauben
 Bone Screws
 Tornillos para huesos
 Vis d'ostéo-synthèse
 Viti per ossa

CORTICALIS

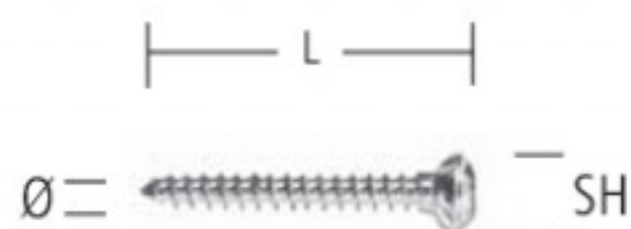

	SH 3,0 mm	SH 3,0 mm
		TITAN
L	Ø 1,5 mm	Ø 1,5 mm
4 mm	KA 5600/04	KA 5601/04
6 mm	KA 5600/06	KA 5601/06
7 mm	KA 5600/07	KA 5601/07
8 mm	KA 5600/08	KA 5601/08
9 mm	KA 5600/09	KA 5601/09
10 mm	KA 5600/10	KA 5601/10
11 mm	KA 5600/11	KA 5601/11
12 mm	KA 5600/12	KA 5601/12
14 mm	KA 5600/14	KA 5601/14
16 mm	KA 5600/16	KA 5601/16
18 mm	KA 5600/18	KA 5601/18
20 mm	KA 5600/20	KA 5601/20
22 mm		
24 mm		
26 mm		
28 mm		
30 mm		
32 mm		
34 mm		
36 mm		
38 mm		
40 mm		

	SH 4,0 mm	SH 4,0 mm
		TITAN
L	Ø 2,0 mm	Ø 2,0 mm
4 mm	KA 5602/04	KA 5603/04
6 mm	KA 5602/06	KA 5603/06
8 mm	KA 5602/08	KA 5603/08
10 mm	KA 5602/10	KA 5603/10
12 mm	KA 5602/12	KA 5603/12
14 mm	KA 5602/14	KA 5603/14
16 mm	KA 5602/16	KA 5603/16
18 mm	KA 5602/18	KA 5603/18
20 mm	KA 5602/20	KA 5603/20
22 mm	KA 5602/22	KA 5603/22
24 mm	KA 5602/24	KA 5603/24
26 mm	KA 5602/26	KA 5603/26
28 mm	KA 5602/28	KA 5603/28
30 mm	KA 5602/30	KA 5603/30
32 mm	KA 5602/32	KA 5603/32
34 mm	KA 5602/34	KA 5603/34
36 mm	KA 5602/36	KA 5603/36
38 mm	KA 5602/38	KA 5603/38
40 mm		

	SH 5,0 mm	SH 5,0 mm
		TITAN
L	Ø 2,7 mm	Ø 2,7 mm
4 mm	KA 5604/06	KA 5605/06
6 mm	KA 5604/08	KA 5605/08
8 mm	KA 5604/10	KA 5605/10
10 mm	KA 5604/12	KA 5605/12
12 mm	KA 5604/14	KA 5605/14
14 mm	KA 5604/16	KA 5605/16
16 mm	KA 5604/18	KA 5605/18
18 mm	KA 5604/20	KA 5605/20
20 mm	KA 5604/22	KA 5605/22
22 mm	KA 5604/24	KA 5605/24
24 mm	KA 5604/26	KA 5605/26
26 mm	KA 5604/28	KA 5605/28
28 mm	KA 5604/30	KA 5605/30
30 mm	KA 5604/32	KA 5605/32
32 mm	KA 5604/34	KA 5605/34
34 mm	KA 5604/36	KA 5605/36
36 mm	KA 5604/38	KA 5605/38
40 mm	KA 5604/40	KA 5605/40



KA 5690/11

KA 5690/15

KA 5690/20

AA
AB
AC
AD
AE
AF
AK
AL
AM
AO
AP
AR
KA
KB
KC
KD
KU
KY

KA ORTHOPÄDIE ORTHOPAEDIC ORTOPEDIA ORTHOPEDIE ORTOPEDIA

Knochen-Schrauben
Bone Screws
Tornillos para huesos
Vis d'ostéo-synthèse
Viti per ossa

CORTICALIS

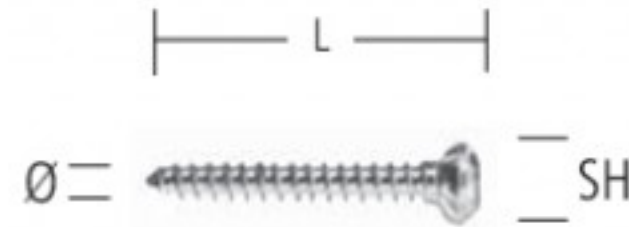

	SH 6,0 mm	SH 6,0 mm	SH 8,0 mm	SH 8,0 mm
		TITAN		TITAN
L	Ø 3,5 mm	Ø 3,5 mm	Ø 4,5 mm	Ø 4,5 mm
10 mm	KA 5606/10	KA 5607/10		
12 mm	KA 5606/12	KA 5607/12		
14 mm	KA 5606/14	KA 5607/14	KA 5608/14	KA 5609/14
16 mm	KA 5606/16	KA 5607/16	KA 5608/16	KA 5609/16
18 mm	KA 5606/18	KA 5607/18	KA 5608/18	KA 5609/18
20 mm	KA 5606/20	KA 5607/20	KA 5608/20	KA 5609/20
22 mm	KA 5606/22	KA 5607/22	KA 5608/22	KA 5609/22
24 mm	KA 5606/24	KA 5607/24	KA 5608/24	KA 5609/24
26 mm	KA 5606/26	KA 5607/26	KA 5608/26	KA 5609/26
28 mm	KA 5606/28	KA 5607/28	KA 5608/28	KA 5609/28
30 mm	KA 5606/30	KA 5607/30	KA 5608/30	KA 5609/30
32 mm	KA 5606/32	KA 5607/32	KA 5608/32	KA 5609/32
34 mm			KA 5608/34	KA 5609/34
36 mm	KA 5606/36	KA 5607/36	KA 5608/36	KA 5609/36
38 mm			KA 5608/38	KA 5609/38
40 mm	KA 5606/40	KA 5607/40	KA 5608/40	KA 5609/40
42 mm			KA 5608/42	KA 5609/42
44 mm			KA 5608/44	KA 5609/44
45 mm	KA 5606/45	KA 5607/45		
46 mm			KA 5608/46	KA 5609/46
48 mm			KA 5608/48	KA 5609/48
50 mm	KA 5606/50	KA 5607/50	KA 5608/50	KA 5609/50
52 mm			KA 5608/52	KA 5609/52
54 mm			KA 5608/54	KA 5609/54
55 mm	KA 5606/55	KA 5607/55		
56 mm			KA 5608/56	KA 5609/56
58 mm			KA 5608/58	KA 5609/58
60 mm	KA 5606/60	KA 5607/60	KA 5608/60	KA 5609/60
62 mm			KA 5608/62	KA 5609/62
64 mm			KA 5608/64	KA 5609/64
65 mm	KA 5606/65	KA 5607/65		
68 mm			KA 5608/68	KA 5609/68
70 mm	KA 5606/70	KA 5607/70	KA 5608/70	KA 5609/70
72 mm			KA 5608/72	KA 5609/72
75 mm	KA 5606/75	KA 5607/75		
76 mm			KA 5608/76	KA 5609/76
80 mm	KA 5606/80	KA 5607/80	KA 5608/80	KA 5609/80
85 mm	KA 5606/85	KA 5607/85	KA 5608/85	KA 5609/85
90 mm	KA 5606/90	KA 5607/90	KA 5608/90	KA 5609/90
95 mm	KA 5606/95	KA 5607/95	KA 5608/95	KA 5609/95
100 mm	KA 5606/96	KA 5607/96	KA 5608/96	KA 5609/96
105 mm	KA 5606/97	KA 5607/97	KA 5608/97	KA 5609/97
110 mm	KA 5606/98	KA 5607/98	KA 5608/98	KA 5609/98



KA 5690/25

KA 5690/32

Knochen-Schrauben
 Bone Screws
 Tornillos para huesos
 Vis d'ostéo-synthèse
 Viti per ossa

SPONGIOSA

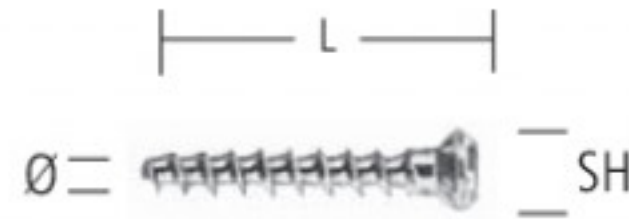

	SH 6,0 mm	SH 6,0 mm
		TITAN
L	Ø 4,0 mm	Ø 4,0 mm
10 mm	KA 5620/10	KA 5621/10
11 mm	KA 5620/11	KA 5621/11
12 mm	KA 5620/12	KA 5621/12
14 mm	KA 5620/14	KA 5621/14
16 mm	KA 5620/16	KA 5621/16
18 mm	KA 5620/18	KA 5621/18
20 mm	KA 5620/20	KA 5621/20
22 mm	KA 5620/22	KA 5621/22
24 mm	KA 5620/24	KA 5621/24
26 mm	KA 5620/26	KA 5621/26
28 mm	KA 5620/28	KA 5621/28
30 mm	KA 5620/30	KA 5621/30
35 mm	KA 5620/35	KA 5621/35
40 mm	KA 5620/40	KA 5621/40
45 mm	KA 5620/45	KA 5621/45
50 mm	KA 5620/50	KA 5621/50
55 mm	KA 5620/55	KA 5621/55
60 mm	KA 5620/60	KA 5621/60

	SH 8,0 mm	SH 8,0 mm
		TITAN
L	Ø 6,5 mm	Ø 6,5 mm
25 mm	KA 5624/25	KA 5625/25
30 mm	KA 5624/30	KA 5625/30
35 mm	KA 5624/35	KA 5625/35
40 mm	KA 5624/40	KA 5625/40
45 mm	KA 5624/45	KA 5625/45
50 mm	KA 5624/50	KA 5625/50
55 mm	KA 5624/55	KA 5625/55
60 mm	KA 5624/60	KA 5625/60
65 mm	KA 5624/65	KA 5625/65
70 mm	KA 5624/70	KA 5625/70
75 mm	KA 5624/75	KA 5625/75
80 mm	KA 5624/80	KA 5625/80
85 mm	KA 5624/85	KA 5625/85
90 mm	KA 5624/90	KA 5625/90
95 mm	KA 5624/95	KA 5625/95
100 mm	KA 5624/96	KA 5625/96
105 mm	KA 5624/97	KA 5625/97
110 mm	KA 5624/98	KA 5625/98



KA 5690/25



KA 5690/32

7 mm



KA 5698/07

13 mm



KA 5698/13

AA
AB
AC
AD
AE
AF
AK
AL
AM
AO
AP
AR
KA
KB
KC
KD
KU
KY

Knochen-Schrauben
 Bone Screws
 Tornillos para huesos
 Vis d'ostéo-synthèse
 Viti per ossa

SPONGIOSA

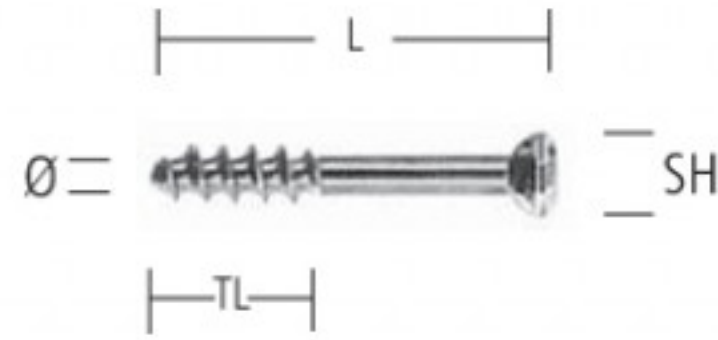

		SH 6,0 mm	SH 6,0 mm
			TITAN
L	TL	Ø 4,0 mm	Ø 4,0 mm
10 mm	5 mm	KA 5630/10	KA 5631/10
12 mm	5 mm	KA 5630/12	KA 5631/12
14 mm	5 mm	KA 5630/14	KA 5631/14
16 mm	6 mm	KA 5630/16	KA 5631/16
18 mm	7 mm	KA 5630/18	KA 5631/18
20 mm	8 mm	KA 5630/20	KA 5631/20
22 mm	9 mm	KA 5630/22	KA 5631/22
24 mm	10 mm	KA 5630/24	KA 5631/24
26 mm	12 mm	KA 5630/26	KA 5631/26
28 mm	14 mm	KA 5630/28	KA 5631/28
30 mm	14 mm	KA 5630/30	KA 5631/30
35 mm	14 mm	KA 5630/35	KA 5631/35
40 mm	14 mm	KA 5630/40	KA 5631/40
45 mm	15 mm	KA 5630/45	KA 5631/45
50 mm	15 mm	KA 5630/50	KA 5631/50



KA 5690/25

7 mm



KA 5698/07

Knochen-Schrauben
 Bone Screws
 Tornillos para huesos
 Vis d'ostéo-synthèse
 Viti per ossa

SPONGIOSA

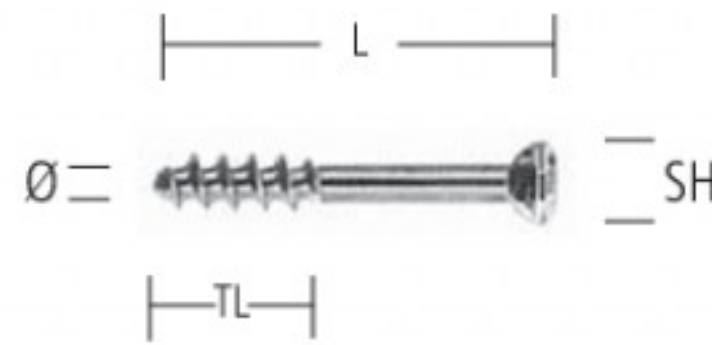

		SH 8,0 mm	SH 8,0 mm			SH 8,0 mm	SH 8,0 mm
			TITAN				TITAN
L	TL	Ø 6,5 mm	Ø 6,5 mm	TL	Ø 6,5 mm	Ø 6,5 mm	
30 mm	16 mm	KA 5632/30	KA 5633/30				
35 mm	16 mm	KA 5632/35	KA 5633/35				
40 mm	16 mm	KA 5632/40	KA 5633/40				
45 mm	16 mm	KA 5632/45	KA 5633/45	32 mm	KA 5634/45	KA 5635/45	
50 mm	16 mm	KA 5632/50	KA 5633/50	32 mm	KA 5634/50	KA 5635/50	
55 mm	16 mm	KA 5632/55	KA 5633/55	32 mm	KA 5634/55	KA 5635/55	
60 mm	16 mm	KA 5632/60	KA 5633/60	32 mm	KA 5634/60	KA 5635/60	
65 mm	16 mm	KA 5632/65	KA 5633/65	32 mm	KA 5634/65	KA 5635/65	
70 mm	16 mm	KA 5632/70	KA 5633/70	32 mm	KA 5634/70	KA 5635/70	
75 mm	16 mm	KA 5632/75	KA 5633/75	32 mm	KA 5634/75	KA 5635/75	
80 mm	16 mm	KA 5632/80	KA 5633/80	32 mm	KA 5634/80	KA 5635/80	
85 mm	16 mm	KA 5632/85	KA 5633/85	32 mm	KA 5634/85	KA 5635/85	
90 mm	16 mm	KA 5632/90	KA 5633/90	32 mm	KA 5634/90	KA 5635/90	
95 mm	16 mm	KA 5632/95	KA 5633/95	32 mm	KA 5634/95	KA 5635/95	
100 mm	16 mm	KA 5632/96	KA 5633/96	32 mm	KA 5634/96	KA 5635/96	
105 mm	16 mm	KA 5632/97	KA 5633/97	32 mm	KA 5634/97	KA 5635/97	
110 mm	16 mm	KA 5632/98	KA 5633/98	32 mm	KA 5634/98	KA 5635/98	



KA 5690/32

KA 5690/32

13 mm



KA 5698/13

KA 5698/13

AA
AB
AC
AD
AE
AF
AK
AL
AM
AO
AP
AR
KA
KB
KC
KD
KU
KY

Knochen-Schrauben
 Bone Screws
 Tornillos para huesos
 Vis d'ostéo-synthèse
 Viti per ossa

selbstschneidend
 self-cutting
 rosca cortante
 auto-taraudeuses
 filetto tagliante

**CORTICALIS
 CANNULATED**

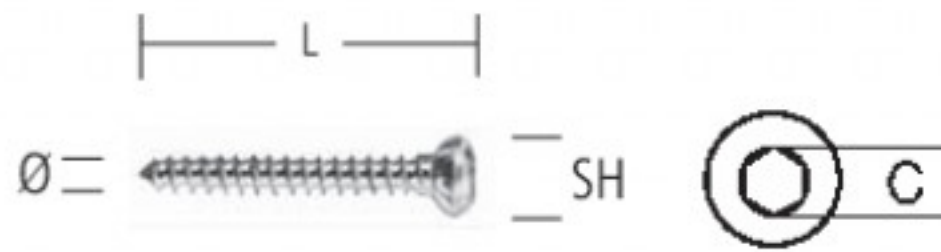

	SH 6,0 mm	SH 8,0 mm
	C 1,6 mm	C 1,8 mm
	TITAN	TITAN
L	Ø 3,5 mm	Ø 4,5 mm
12 mm	KA 5640/12	
14 mm	KA 5640/14	
16 mm	KA 5640/16	
18 mm	KA 5640/18	
20 mm	KA 5640/20	
22 mm	KA 5640/22	
24 mm	KA 5640/24	
26 mm	KA 5640/26	
28 mm	KA 5640/28	
30 mm	KA 5640/30	KA 5642/30
32 mm	KA 5640/32	KA 5642/32
34 mm	KA 5640/34	KA 5642/34
36 mm	KA 5640/36	KA 5642/36
38 mm	KA 5640/38	KA 5642/38
40 mm	KA 5640/40	KA 5642/40
42 mm	KA 5640/42	KA 5642/42
44 mm	KA 5640/44	KA 5642/44
46 mm	KA 5640/46	KA 5642/46
48 mm	KA 5640/48	KA 5642/48
52 mm	KA 5640/52	
57 mm	KA 5640/57	KA 5642/57
62 mm	KA 5640/62	KA 5642/62
67 mm	KA 5640/67	KA 5642/67
72 mm	KA 5640/72	KA 5642/72



KA 5690/25 KA 5690/32

**CORTICALIS
 CANNULATED**



		SH 6,0 mm	SH 8,0 mm
		C 1,6 mm	C 1,8 mm
		TITAN	TITAN
L	TL	Ø 4,0 mm	Ø 4,5 mm
30 mm	20 mm	KA 5644/30	KA 5646/30
32 mm	20 mm	KA 5644/32	KA 5646/32
34 mm	20 mm	KA 5644/34	KA 5646/34
35 mm	20 mm		
40 mm	20 mm	KA 5644/40	KA 5646/40
42 mm	20 mm	KA 5644/42	KA 5646/42
44 mm	20 mm	KA 5644/44	KA 5646/44
45 mm	20 mm		
46 mm	20 mm	KA 5644/46	KA 5646/46
48 mm	20 mm	KA 5644/48	KA 5646/48
50 mm	20 mm	KA 5644/50	KA 5646/50
55 mm	20 mm	KA 5644/55	KA 5646/55
60 mm	20 mm	KA 5644/60	KA 5646/60
65 mm	20 mm	KA 5644/65	KA 5646/65
70 mm	20 mm	KA 5644/70	KA 5646/70



KA 5690/25 KA 5690/32

Knochen-Schrauben
Bone Screws
Tornillos para huesos
Vis d'ostéo-synthèse
Viti per ossa

selbstschneidend
self-cutting
rosca cortante
auto-taraudeuses
filetto tagliante

**SPONGIOSA
CANNULATED**



		SH 8,0 mm
		C 2,0 mm
		TITAN
L	TL	Ø 5,0 mm
30 mm	20 mm	KA 5648/30
32 mm	20 mm	KA 5648/32
34 mm	20 mm	KA 5648/34
40 mm	20 mm	KA 5648/40
42 mm	20 mm	KA 5648/42
44 mm	20 mm	KA 5648/44
46 mm	20 mm	KA 5648/46
48 mm	20 mm	KA 5648/48
50 mm	20 mm	KA 5648/50
55 mm	20 mm	KA 5648/55
60 mm	20 mm	KA 5648/60
65 mm	20 mm	KA 5648/65
70 mm	20 mm	KA 5648/70

		SH 8,0 mm
		C 3,2 mm
		TITAN
L	TL	Ø 6,5 mm
35 mm	25 mm	KA 5649/35
40 mm	25 mm	KA 5649/40
45 mm	25 mm	KA 5649/45
50 mm	25 mm	KA 5649/50
55 mm	25 mm	KA 5649/55
60 mm	25 mm	KA 5649/60
65 mm	25 mm	KA 5649/65
70 mm	25 mm	KA 5649/70
75 mm	25 mm	KA 5649/75
80 mm	25 mm	KA 5649/80
85 mm	25 mm	KA 5649/85
90 mm	25 mm	KA 5649/90
95 mm	25 mm	KA 5649/95
100 mm	25 mm	KA 5650/01
105 mm	25 mm	KA 5650/02
110 mm	25 mm	KA 5650/03
115 mm	25 mm	KA 5650/04
120 mm	25 mm	KA 5650/05
125 mm	25 mm	KA 5650/06
130 mm	25 mm	KA 5650/07



KA 5690/32

13 mm



KA 5698/13



KA 5690/25

13 mm



KA 5698/13

AA
AB
AC
AD
AE
AF
AK
AL
AM
AO
AP
AR
KA
KB
KC
KD
KU
KY

Knochen-Schrauben
 Bone Screws
 Tornillos para huesos
 Vis d'ostéo-synthèse
 Viti per ossa

MALLEOLAR

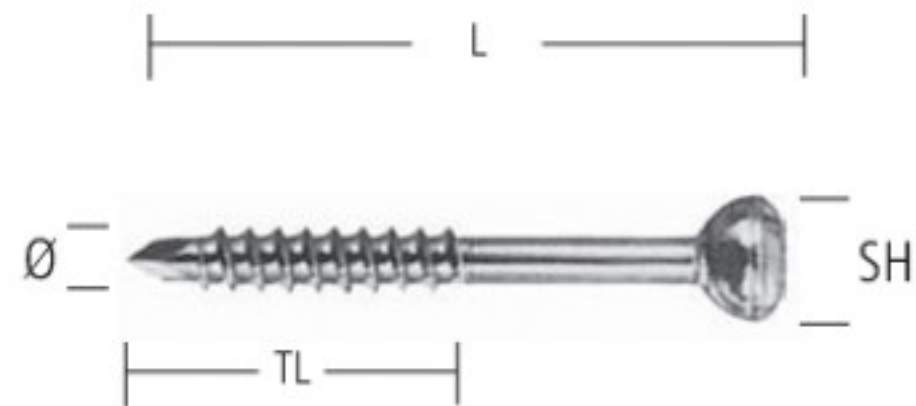

		SH 8,0 mm	SH 8,0 mm
			TITAN
L	TL	Ø 4,5 mm	Ø 4,5 mm
30 mm	15 mm	KA 5655/30	KA 5656/30
35 mm	18 mm	KA 5655/35	KA 5656/35
40 mm	20 mm	KA 5655/40	KA 5656/40
45 mm	22 mm	KA 5655/45	KA 5656/45
50 mm	24 mm	KA 5655/50	KA 5656/50
55 mm	26 mm	KA 5655/55	KA 5656/55
60 mm	28 mm	KA 5655/60	KA 5656/60
65 mm	30 mm	KA 5655/65	KA 5656/65
70 mm	32 mm	KA 5655/70	KA 5656/70



KA 5690/32

Vorbohrer für Knochen-Schrauben
 Drill Bit for Bone Screws
 Broca para tornillos para huesos
 Alésoir pour Vis d'ostéo-synthèse
 Alesatore per Viti per ossa



Ø	L	
1,1 mm	52 mm	KA 5690/11
1,5 mm	100 mm	KA 5690/15
2,0 mm	100 mm	KA 5690/20
2,5 mm	111 mm	KA 5690/25
3,2 mm	130 mm	KA 5690/32

AA

AB

AC

AD

AE

AF

AK

AL

AM

AO

AP

AR

KA

KB

KC

KD

KU

KY

