

DARM, MAGEN
INTESTINES, STOMACH
INTESTINOS, ESTOMAGO
INTESTINS, ESTOMAC
INTESTINI, STOMACO

KD

nopa[®] instruments

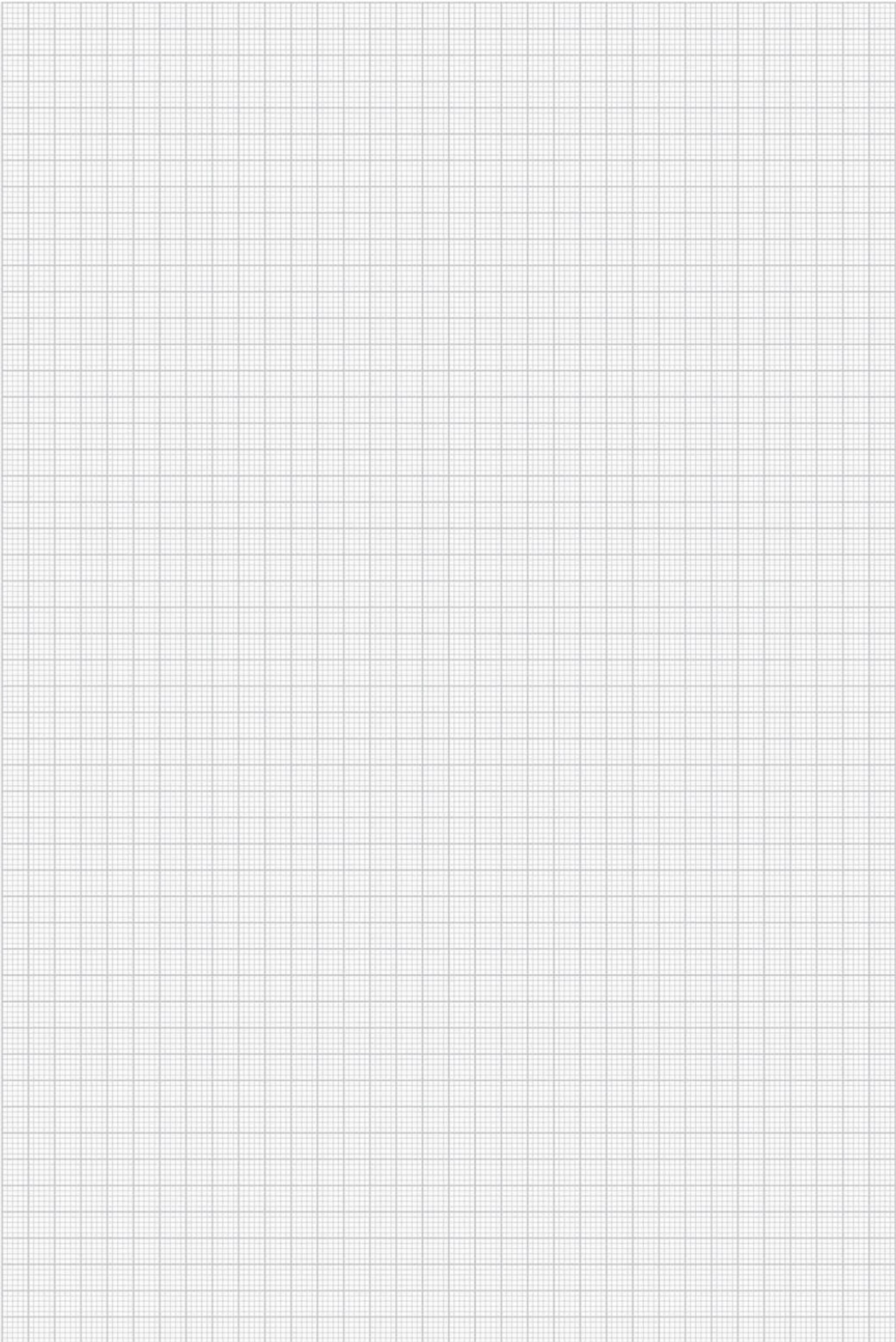



Gewebefasszangchen, Darmfasszangen
 Tissue Seizing Forceps
 Pinzas para coger tejidos e intestinos
 Pincers pour saisir le tissu et l'intestin
 Pinze per afferrare tessuti e l'intestino

AA
AB
AC
AD
AE
AF
AK
AL
AM
AO
AP
AR
KA
KB
KC
KD
KU
KY

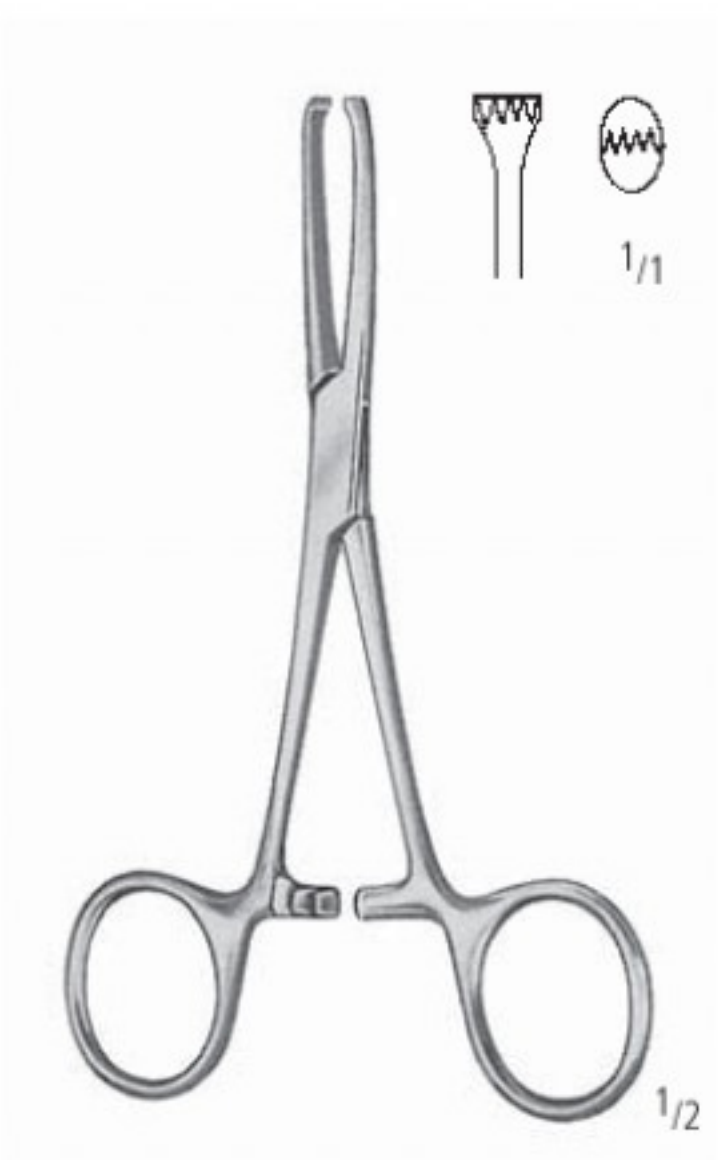

ALLIS-BABY 4:5
 KD 050/12
 12,5 cm/5"



ALLIS 4:5
 KD 054/15
 15,0 cm/6"



ALLIS 5:6
 15,0 cm/6" KD 055/15
 19,0 cm/7 1/2" KD 055/19
 25,0 cm/10" KD 055/25

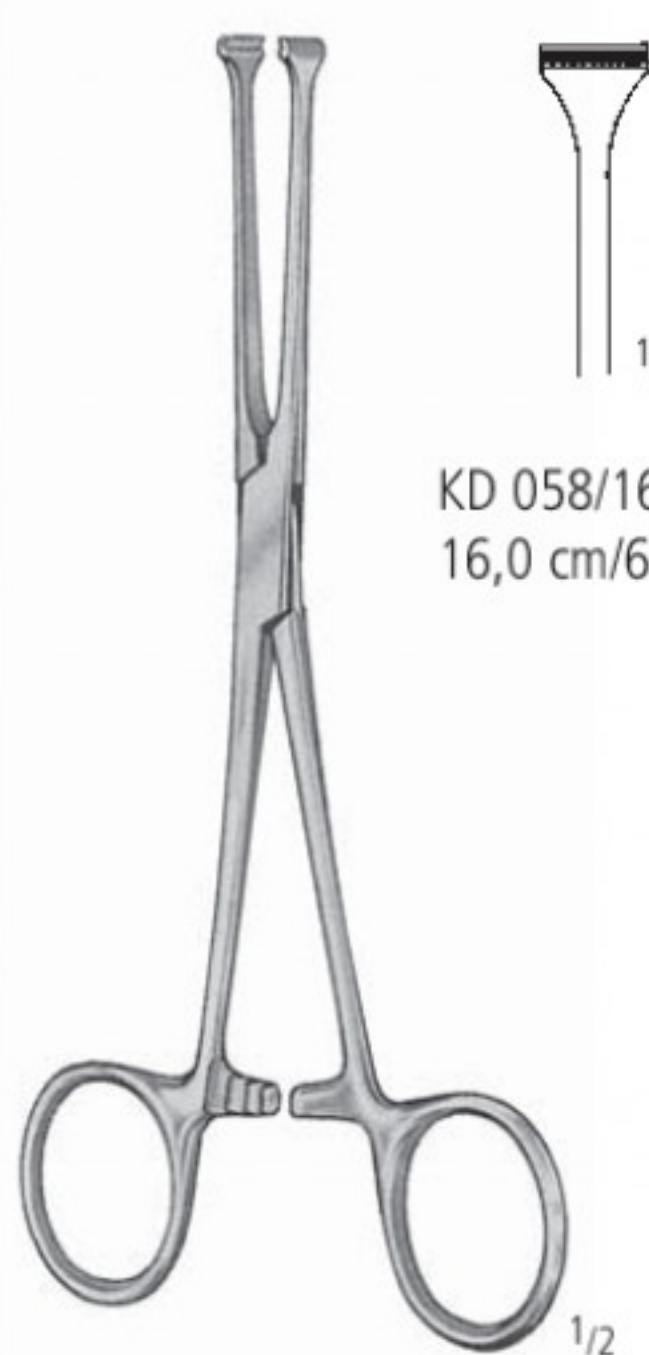

ALLIS

KD 058/16
 16,0 cm/6 1/4"

KD 058/20
 20,0 cm/8"

KD 058/25
 25,0 cm/10"

KD 058/30
 30,0 cm/12"



ALLIS-ADAIR 10:11
 KD 060/15
 15,0 cm/6"

Gewebefasszängchen, Darmfasszangen
 Tissue Seizing Forceps
 Pinzas para coger tejidos e intestinos
 Pincers pour saisir le tissu et l'intestin
 Pinze per afferrare tessuti e l'intestino

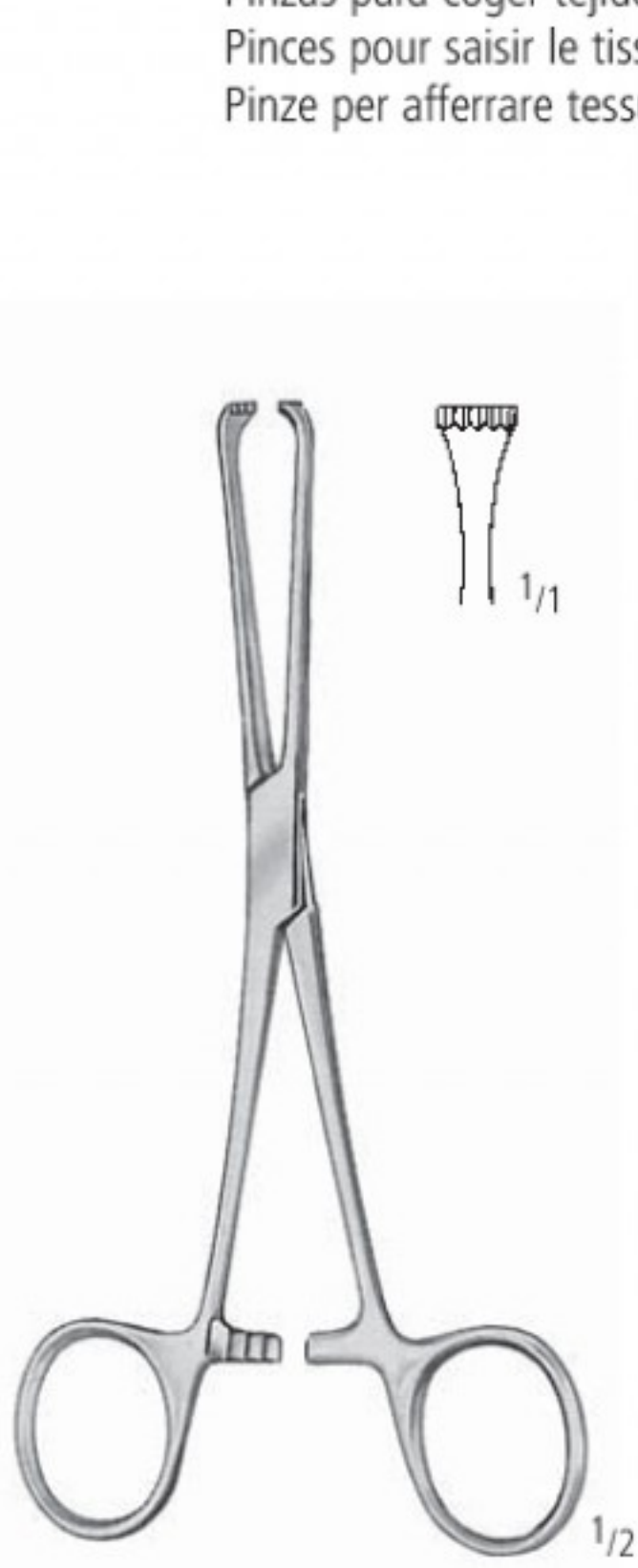

BOYS-ALLIS 5:6
 KD 065/15
 15,0 cm/6"



LOCKWOOD-ALLIS 5:6
 KD 067/20
 20,0 cm/8"



JUDD-ALLIS 3:4
 15,0 cm/6" KD 070/15
 19,0 cm/7 1/2" KD 070/19



LITTLEWOOD
 KD 075/18
 18,0 cm/7"



THOMS-ALLIS 6:7
 KD 080/20
 20,0 cm/8"



LOCKWOOD
 KD 085/20
 20,0 cm/8"

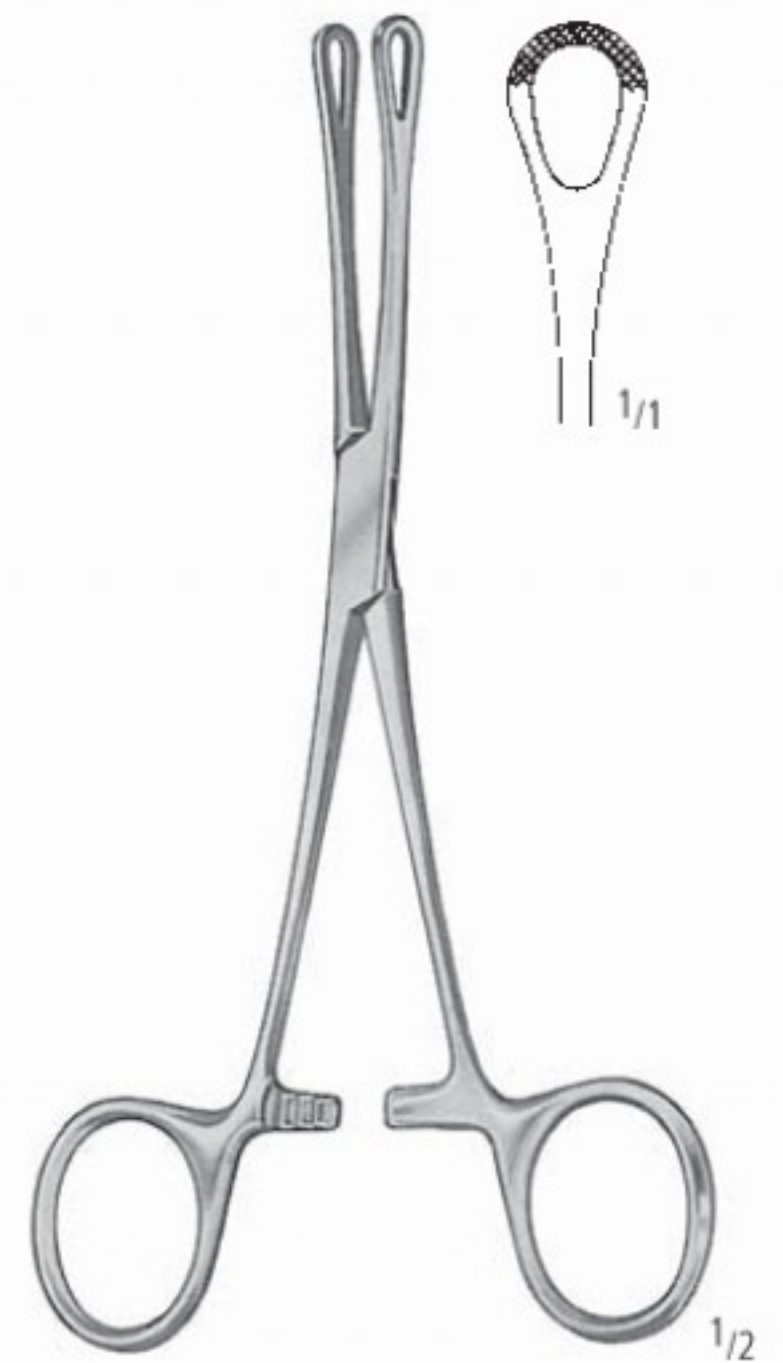

WILLIAMS
 KD 090/16
 16,0 cm/6 1/4"

Darmfazzangen
 Intestinal Tissue Forceps
 Pinzas para coger intestinos
 Pincers pour saisir l'intestin
 Pinze per afferrare l'intestino



BABCOCK

16,0 cm/6¹/₄" KD 100/16
 20,0 cm/8" KD 100/20



BABCOCK

KD 111/16 16,0 cm/6¹/₄"
 KD 111/18 18,0 cm/7"
 KD 111/20 20,0 cm/8"
 KD 111/24 24,0 cm/9¹/₂"

ATRAU[®]
 nopa[®]

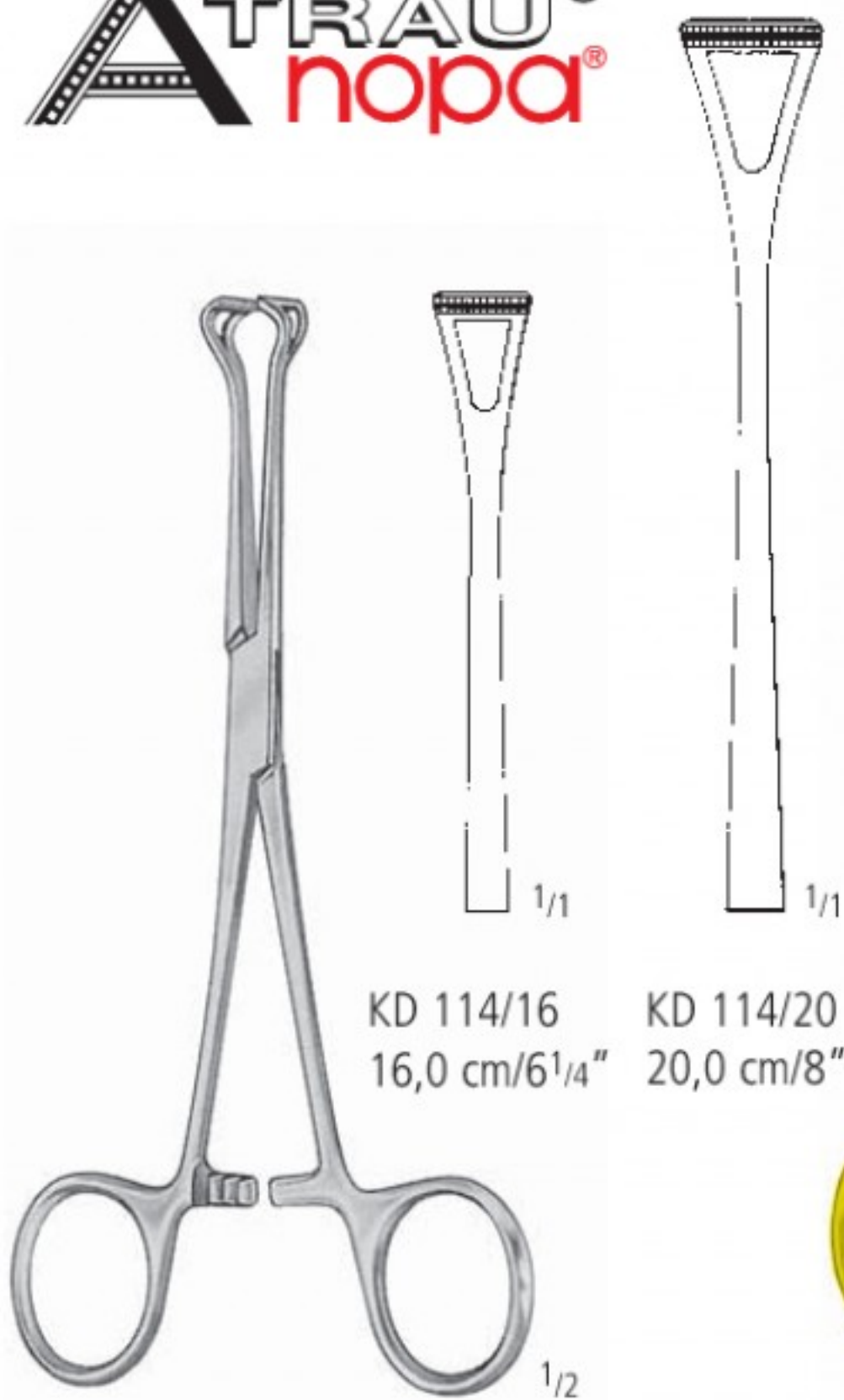

BABCOCK

KD 114/16 16,0 cm/6¹/₄"
 KD 114/20 20,0 cm/8"



DUVAL

KD 120/20
 20,0 cm/8"

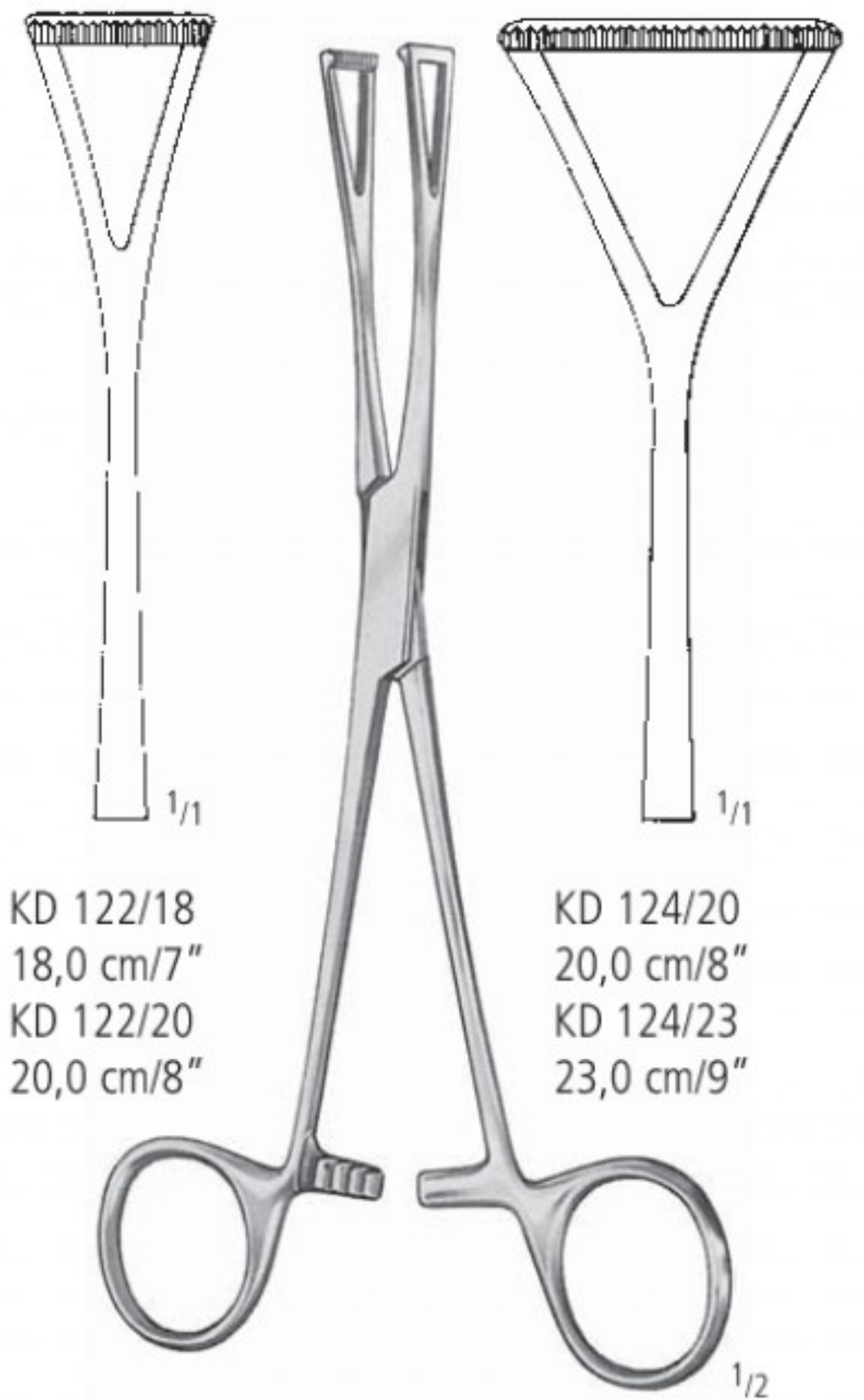

DUVAL

KD 122/18 18,0 cm/7"
 KD 122/20 20,0 cm/8"
 KD 124/20 20,0 cm/8"
 KD 124/23 23,0 cm/9"

AA
AB
AC
AD
AE
AF
AK
AL
AM
AO
AP
AR
KA
KB
KC
KD
KU
KY

Magen- und Darmklemmen
 Stomach and Intestinal Clamp Forceps
 Pinzas-clamps estomacales e intestinales
 Pincas-clamps stomacales et pour l'intestin
 Pinze stomacali e intestinali

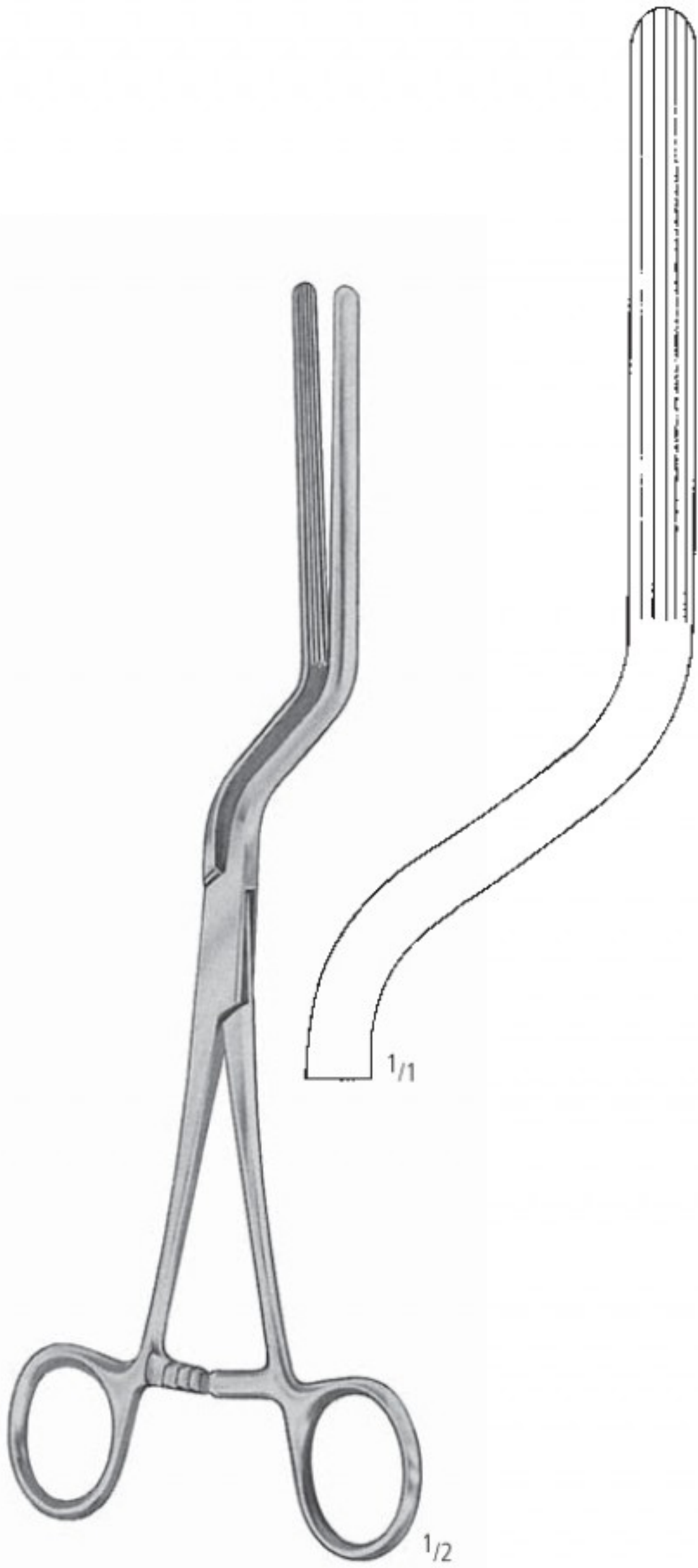

BRUNNER

KD 180/24
 24,0 cm/9 1/2"

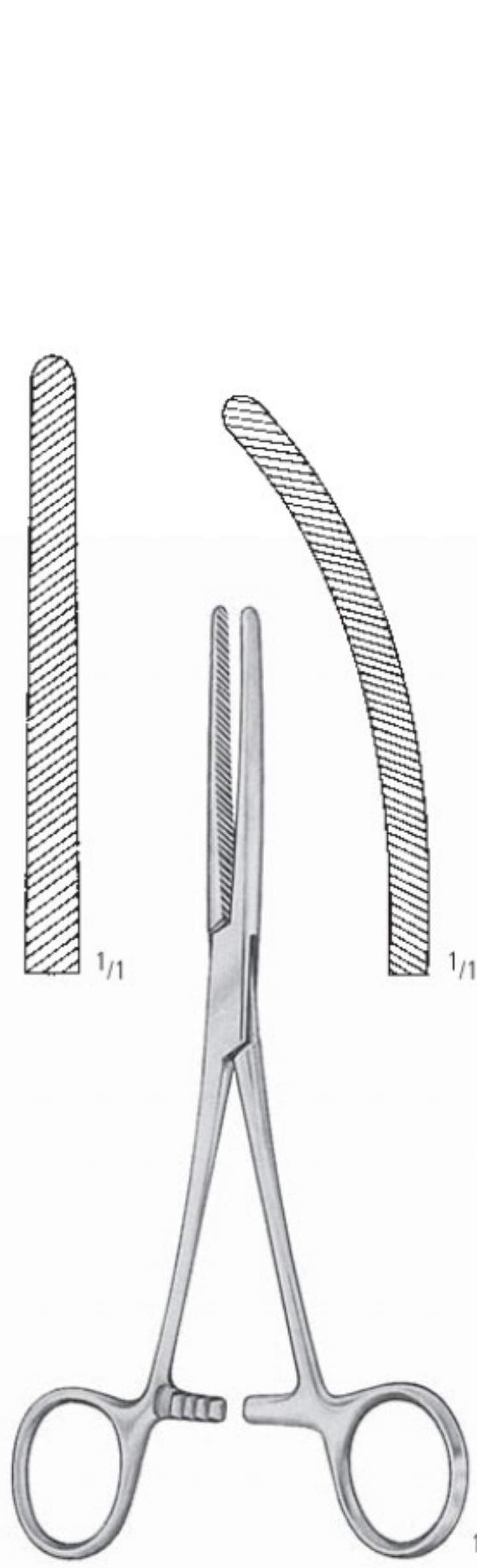

BABY-DOYEN

KD 190/16 16,5 cm/6 1/2" KD 191/16
 KD 190/18 18,0 cm/7" KD 191/18

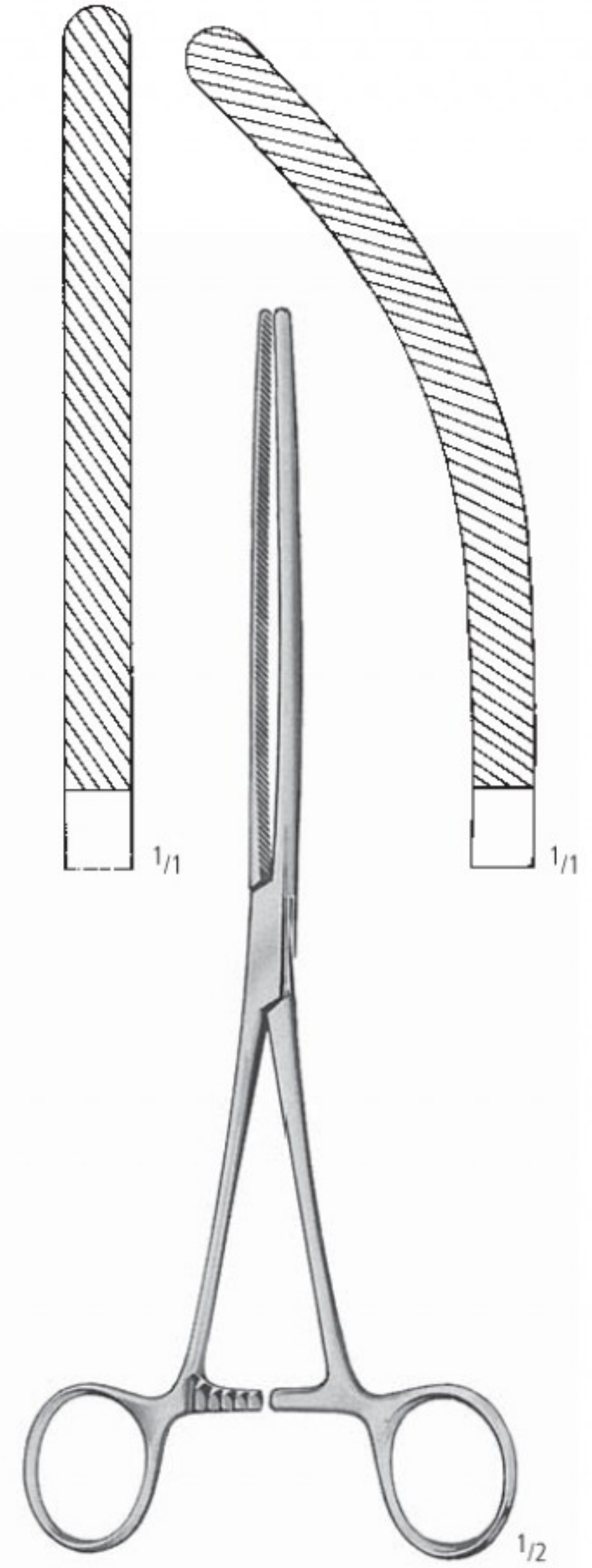

DOYEN

KD 200/21 21,0 cm/8 1/4" KD 201/21
 KD 200/23 23,0 cm/9" KD 201/23

Magen- und Darmklemmen
 Stomach and Intestinal Clamp Forceps
 Pinzas-clamps estomacales e intestinales
 Pinces-clamps stomacales et pour l'intestin
 Pinze stomacali e intestinali

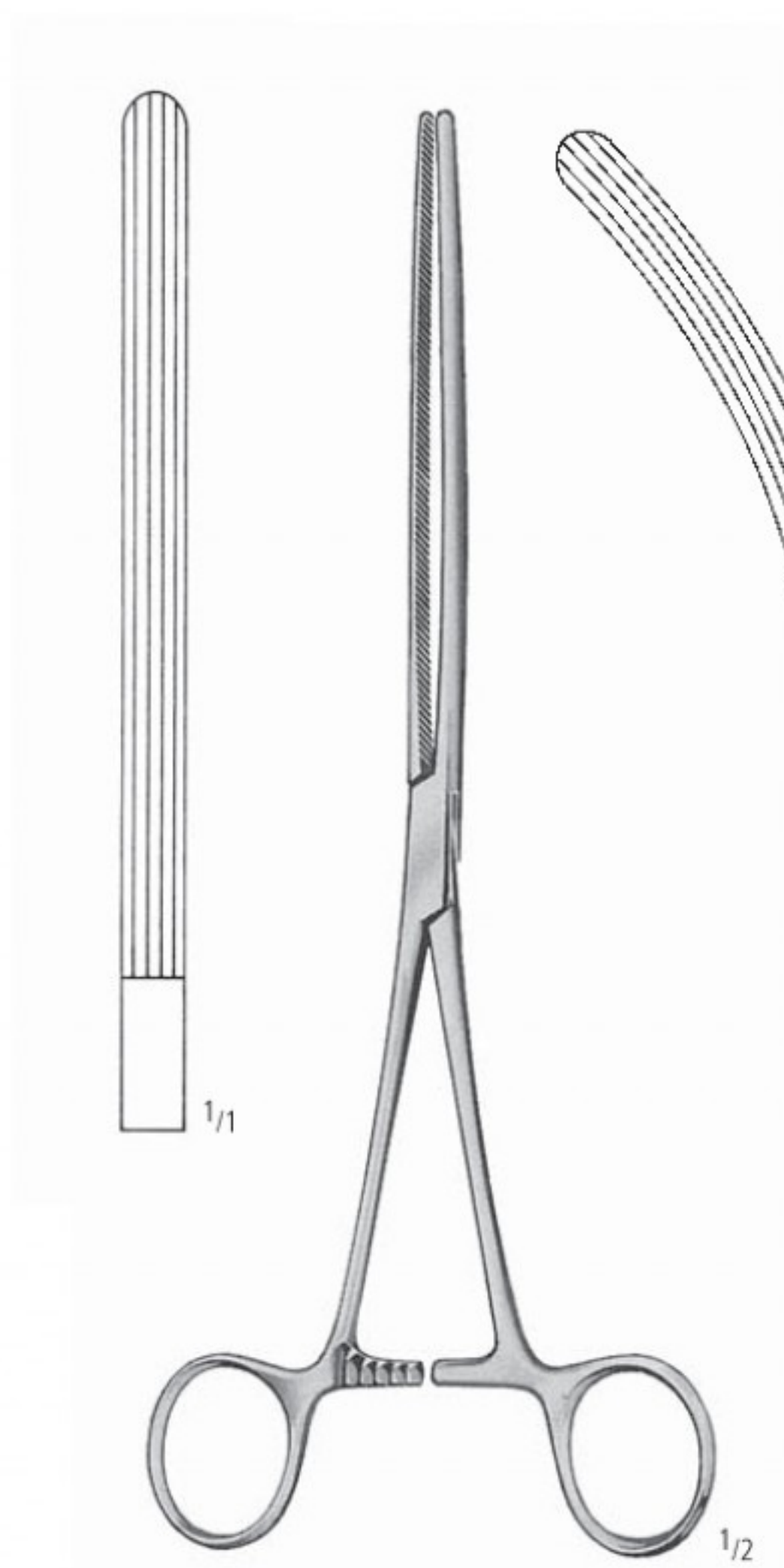

MAYO-ROBSON

KD 210/21	21,0 cm/8 ¹ / ₄ "	KD 211/21
KD 210/23	23,0 cm/9"	KD 211/23
KD 210/25	25,0 cm/10"	KD 211/25

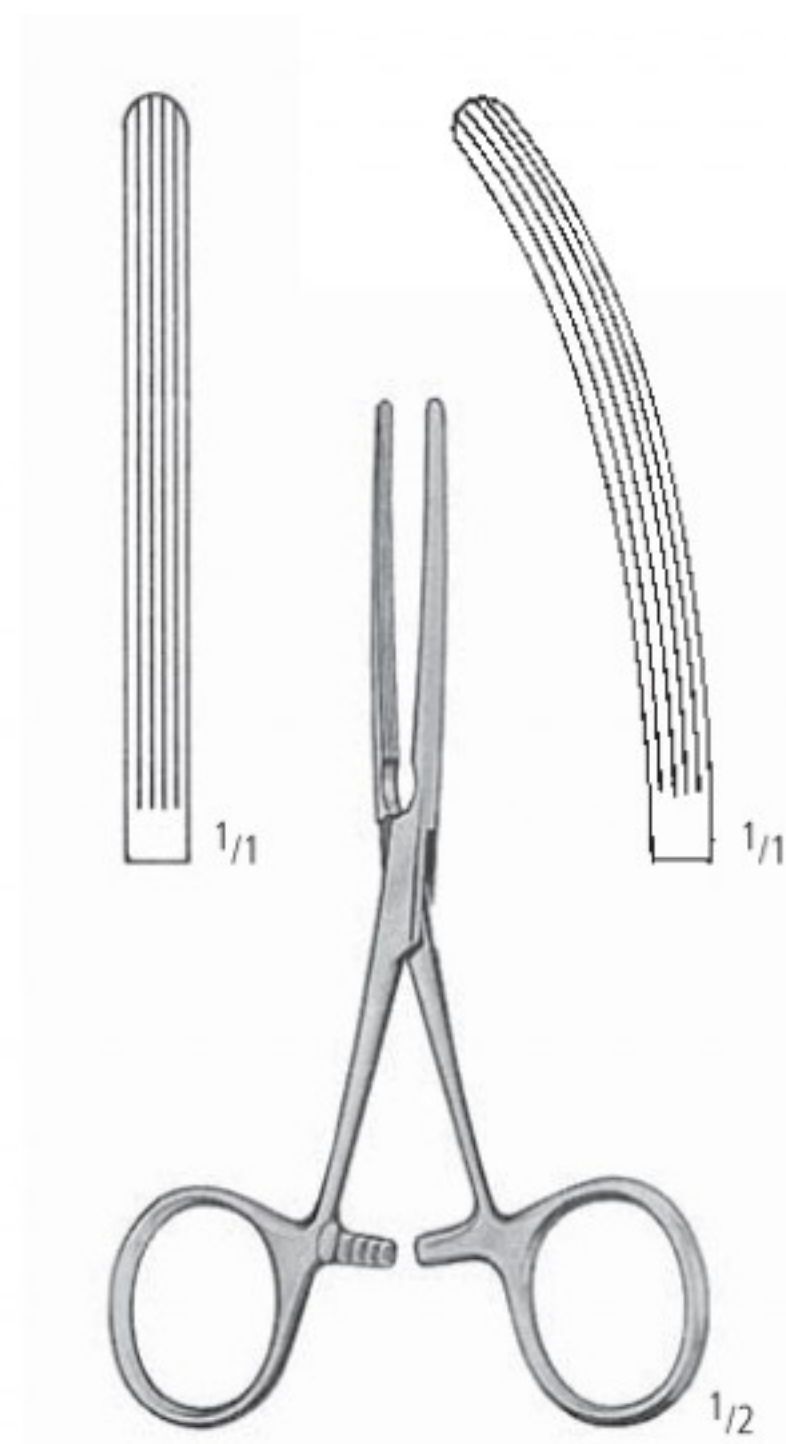

BABY-KOCHER

KD 212/13	13,0 cm/5"	KD 213/13
-----------	------------	-----------

AA

AB

AC

AD

AE

AF

AK

AL

AM

AO

AP

AR

KA

KB

KC

KD

KU

KY

Magen- und Darmklemmen
 Stomach and Intestinal Clamp Forceps
 Pinzas-clamps estomacales e intestinales
 Pincas-clamps stomacales et pour l'intestin
 Pinze stomacali e intestinali



KOCHER

KD 214/22	22,0 cm/8 ³ / ₄ "	KD 215/22
KD 214/25	25,0 cm/10"	KD 215/25
KD 214/28	28,0 cm/11"	KD 215/28

sehr elastisch - very elastic - muy elásticas - très élastiques - molto elastiche

Magen- und Darmklemmen
 Stomach and Intestinal Clamp Forceps
 Pinzas-clamps estomacales e intestinales
 Pincas-clamps stomacales et pour l'intestin
 Pinze stomacali e intestinali

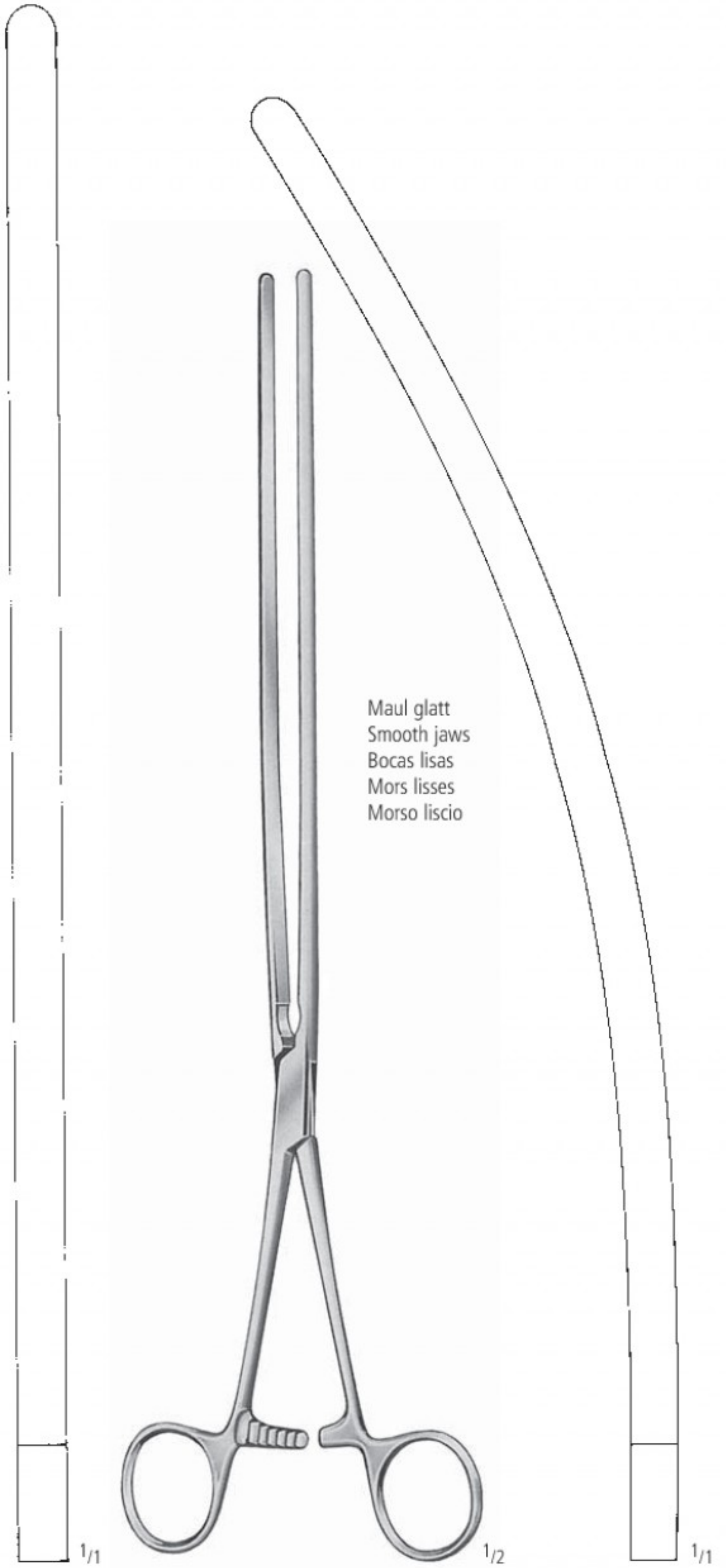
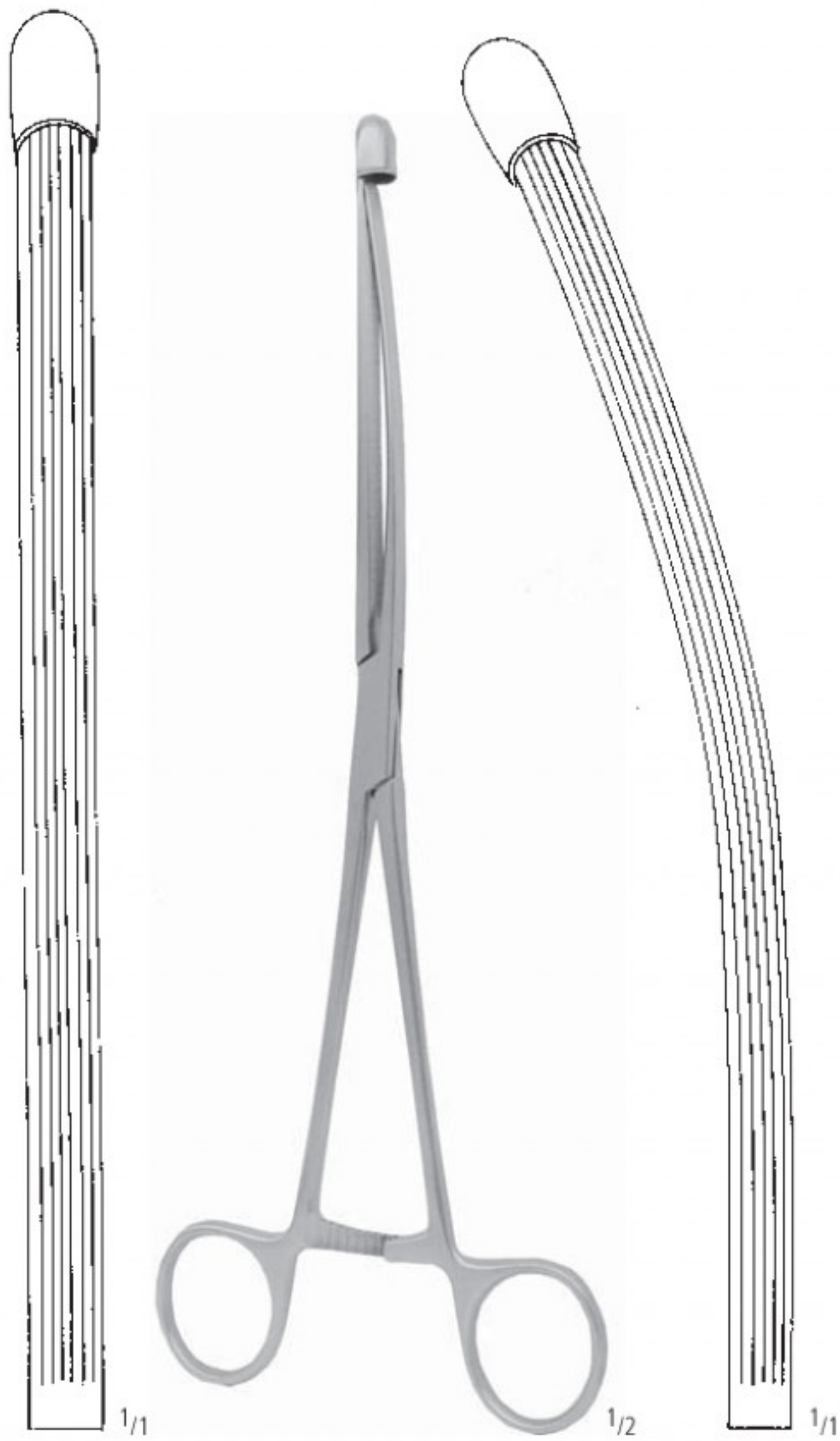

Maul glatt
 Smooth jaws
 Bocas lisas
 Mors lisses
 Morso liscio

KD 224/25

NUSSBAUM
 25,0 cm/10"

KD 225/25

KD 230/25
 KD 230/33

SCUDDER
 25,0 cm/10"
 33,0 cm/13"

KD 231/25
 KD 231/33

AA
 AB
 AC
 AD
 AE
 AF
 AG
 AH
 AI
 AJ
 AK
 AL
 AM
 AN
 AO
 AP
 AQ
 AR
 AS
 AT
 AU
 AV
 AW
 AX
 AY
 AZ
 BA
 BB
 BC
 BD
 BE
 BF
 BG
 BH
 BI
 BJ
 BK
 BL
 BM
 BN
 BO
 BP
 BQ
 BR
 BS
 BT
 BU
 BV
 BW
 BX
 BY
 BZ
 CA
 CB
 CC
 CD
 CE
 CF
 CG
 CH
 CI
 CJ
 CK
 CL
 CM
 CN
 CO
 CP
 CQ
 CR
 CS
 CT
 CU
 CV
 CW
 CX
 CY
 CZ
 DA
 DB
 DC
 DD
 DE
 DF
 DG
 DH
 DI
 DJ
 DK
 DL
 DM
 DN
 DO
 DP
 DQ
 DR
 DS
 DT
 DU
 DV
 DW
 DX
 DY
 DZ
 EA
 EB
 EC
 ED
 EE
 EF
 EG
 EH
 EI
 EJ
 EK
 EL
 EM
 EN
 EO
 EP
 EQ
 ER
 ES
 ET
 EU
 EV
 EW
 EX
 EY
 EZ
 FA
 FB
 FC
 FD
 FE
 FF
 FG
 FH
 FI
 FJ
 FK
 FL
 FM
 FN
 FO
 FP
 FQ
 FR
 FS
 FT
 FU
 FV
 FW
 FX
 FY
 FZ
 GA
 GB
 GC
 GD
 GE
 GF
 GG
 GH
 GI
 GJ
 GK
 GL
 GM
 GN
 GO
 GP
 GQ
 GR
 GS
 GT
 GU
 GV
 GW
 GX
 GY
 GZ
 HA
 HB
 HC
 HD
 HE
 HF
 HG
 HH
 HI
 HJ
 HK
 HL
 HM
 HN
 HO
 HP
 HQ
 HR
 HS
 HT
 HU
 HV
 HW
 HX
 HY
 HZ
 IA
 IB
 IC
 ID
 IE
 IF
 IG
 IH
 II
 IJ
 IK
 IL
 IM
 IN
 IO
 IP
 IQ
 IR
 IS
 IT
 IU
 IV
 IW
 IX
 IY
 IZ
 JA
 JB
 JC
 JD
 JE
 JF
 JG
 JH
 JI
 JJ
 JK
 JL
 JM
 JN
 JO
 JP
 JQ
 JR
 JS
 JT
 JU
 JV
 JW
 JX
 JY
 JZ
 KA
 KB
 KC
 KD
 KE
 KF
 KG
 KH
 KI
 KJ
 KK
 KL
 KM
 KN
 KO
 KP
 KQ
 KR
 KS
 KT
 KU
 KV
 KW
 KX
 KY
 KZ
 LA
 LB
 LC
 LD
 LE
 LF
 LG
 LH
 LI
 LJ
 LK
 LL
 LM
 LN
 LO
 LP
 LQ
 LR
 LS
 LT
 LU
 LV
 LW
 LX
 LY
 LZ
 MA
 MB
 MC
 MD
 ME
 MF
 MG
 MH
 MI
 MJ
 MK
 ML
 MM
 MN
 MO
 MP
 MQ
 MR
 MS
 MT
 MU
 MV
 MW
 MX
 MY
 MZ
 NA
 NB
 NC
 ND
 NE
 NF
 NG
 NH
 NI
 NJ
 NK
 NL
 NM
 NN
 NO
 NP
 NQ
 NR
 NS
 NT
 NU
 NV
 NW
 NX
 NY
 NZ
 OA
 OB
 OC
 OD
 OE
 OF
 OG
 OH
 OI
 OJ
 OK
 OL
 OM
 ON
 OO
 OP
 OQ
 OR
 OS
 OT
 OU
 OV
 OW
 OX
 OY
 OZ
 PA
 PB
 PC
 PD
 PE
 PF
 PG
 PH
 PI
 PJ
 PK
 PL
 PM
 PN
 PO
 PP
 PQ
 PR
 PS
 PT
 PU
 PV
 PW
 PX
 PY
 PZ
 QA
 QB
 QC
 QD
 QE
 QF
 QG
 QH
 QI
 QJ
 QK
 QL
 QM
 QN
 QO
 QP
 QQ
 QR
 QS
 QT
 QU
 QV
 QW
 QX
 QY
 QZ
 RA
 RB
 RC
 RD
 RE
 RF
 RG
 RH
 RI
 RJ
 RK
 RL
 RM
 RN
 RO
 RP
 RQ
 RR
 RS
 RT
 RU
 RV
 RW
 RX
 RY
 RZ
 SA
 SB
 SC
 SD
 SE
 SF
 SG
 SH
 SI
 SJ
 SK
 SL
 SM
 SN
 SO
 SP
 SQ
 SR
 SS
 ST
 SU
 SV
 SW
 SX
 SY
 SZ
 TA
 TB
 TC
 TD
 TE
 TF
 TG
 TH
 TI
 TJ
 TK
 TL
 TM
 TN
 TO
 TP
 TQ
 TR
 TS
 TT
 TU
 TV
 TW
 TX
 TY
 TZ
 UA
 UB
 UC
 UD
 UE
 UF
 UG
 UH
 UI
 UJ
 UK
 UL
 UM
 UN
 UO
 UP
 UQ
 UR
 US
 UT
 UY
 UZ
 VA
 VB
 VC
 VD
 VE
 VF
 VG
 VH
 VI
 VJ
 VK
 VL
 VM
 VN
 VO
 VP
 VQ
 VR
 VS
 VT
 VY
 VZ
 WA
 WB
 WC
 WD
 WE
 WF
 WG
 WH
 WI
 WJ
 WK
 WL
 WM
 WN
 WO
 WP
 WQ
 WR
 WS
 WT
 WY
 WZ
 XA
 XB
 XC
 XD
 XE
 XF
 XG
 XH
 XI
 XJ
 XK
 XL
 XM
 XN
 XO
 XP
 XQ
 XR
 XS
 XT
 XU
 XV
 XW
 XX
 XY
 XZ
 YA
 YB
 YC
 YD
 YE
 YF
 YG
 YH
 YI
 YJ
 YK
 YL
 YM
 YN
 YO
 YP
 YQ
 YR
 YS
 YT
 YZ
 ZA
 ZB
 ZC
 ZD
 ZE
 ZF
 ZG
 ZH
 ZI
 ZJ
 ZK
 ZL
 ZM
 ZN
 ZO
 ZP
 ZQ
 ZR
 ZS
 ZT
 ZY
 ZZ

Atraumatische Magen- und Darmklemmen
 Non-traumatic Stomach and Intestinal Clamp Forceps
 Pinzas-clamps estomacales e intestinales Atrauma
 Pincas-clamps stomacales et pour l'intestin Atrauma
 Pinze stomacali e intestinali Atrauma

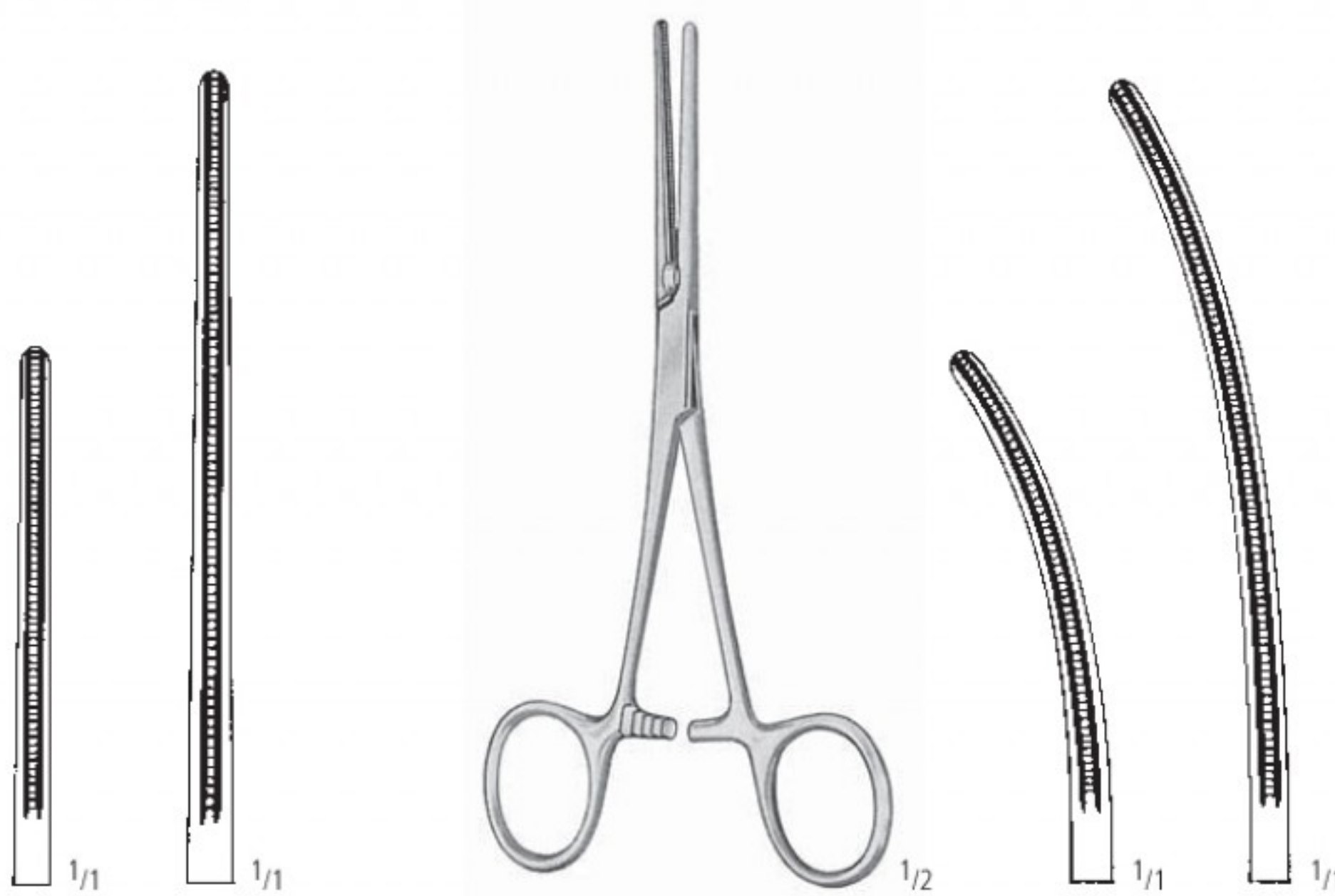

BAINBRIDGE

KD 234/15	15,0 cm/6"	KD 235/15
KD 234/18	18,0 cm/7"	KD 235/18



DOYEN

KD 240/16	16,0 cm/6 1/4"	KD 241/16
KD 240/18	18,0 cm/7"	KD 241/18
KD 240/21	21,0 cm/8 1/4"	KD 241/21
KD 240/23	23,0 cm/9"	KD 241/23

Atraumatische Magen- und Darmklemmen
 Non-traumatic Stomach and Intestinal Clamp Forceps
 Pinzas-clamps estomacales e intestinales Atrauma
 Pincers-clamps stomacales et pour l'intestin Atrauma
 Pinze stomacali e intestinali Atrauma



KOCHER		
KD 250/22	22,0 cm/8 ³ / ₄ "	KD 251/22
KD 250/25	25,0 cm/10"	KD 251/25
KD 250/28	28,0 cm/11"	KD 251/28

AA
AB
AC
AD
AE
AF
AK
AL
AM
AO
AP
AR
KA
KB
KC
KD
KU
KY

Atraumatische Magen- und Darmklemmen
 Non-traumatic Stomach and Intestinal Clamp Forceps
 Pinzas-clamps estomacales e intestinales Atrauma
 Pincas-clamps stomacales et pour l'intestin Atrauma
 Pinze stomacali e intestinali Atrauma

ATRAU[®]
 nopa[®]

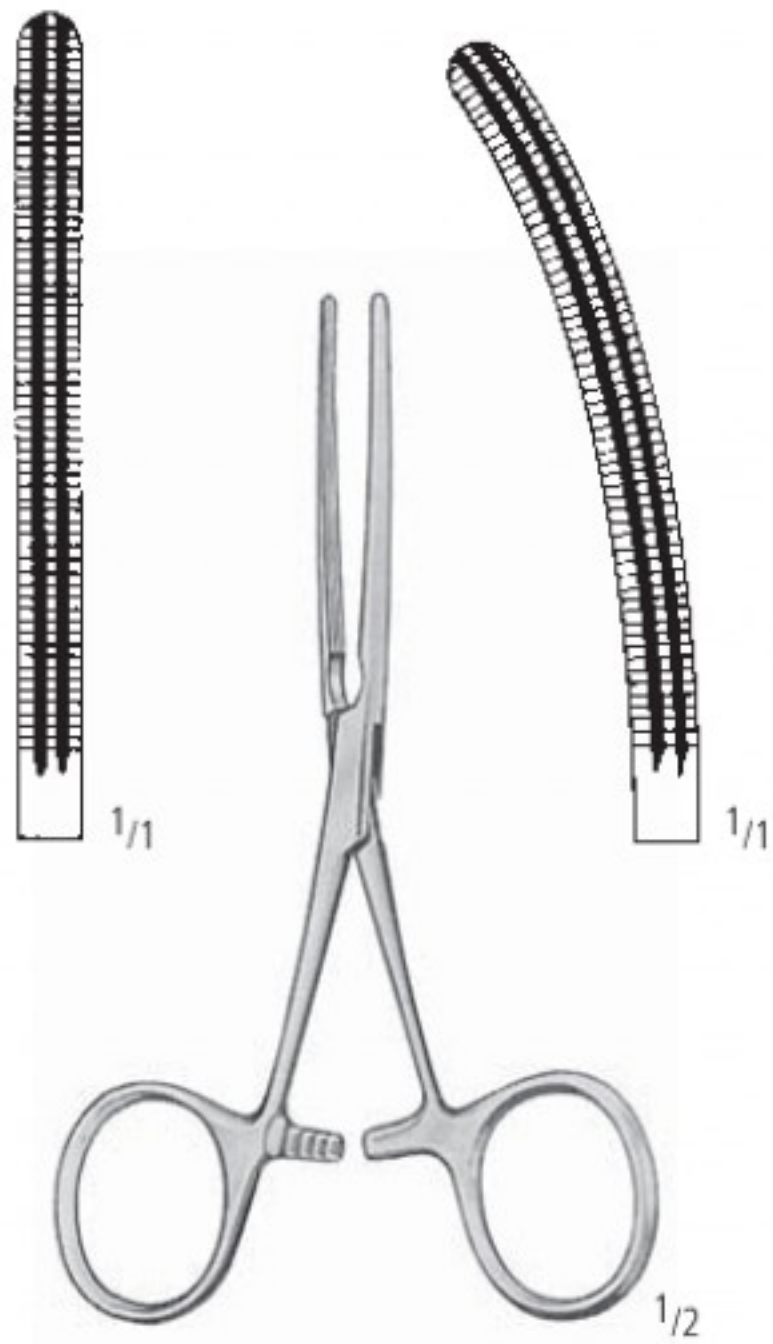

BABY KOCHER
 KD 252/13 13,0 cm/5" KD 253/13

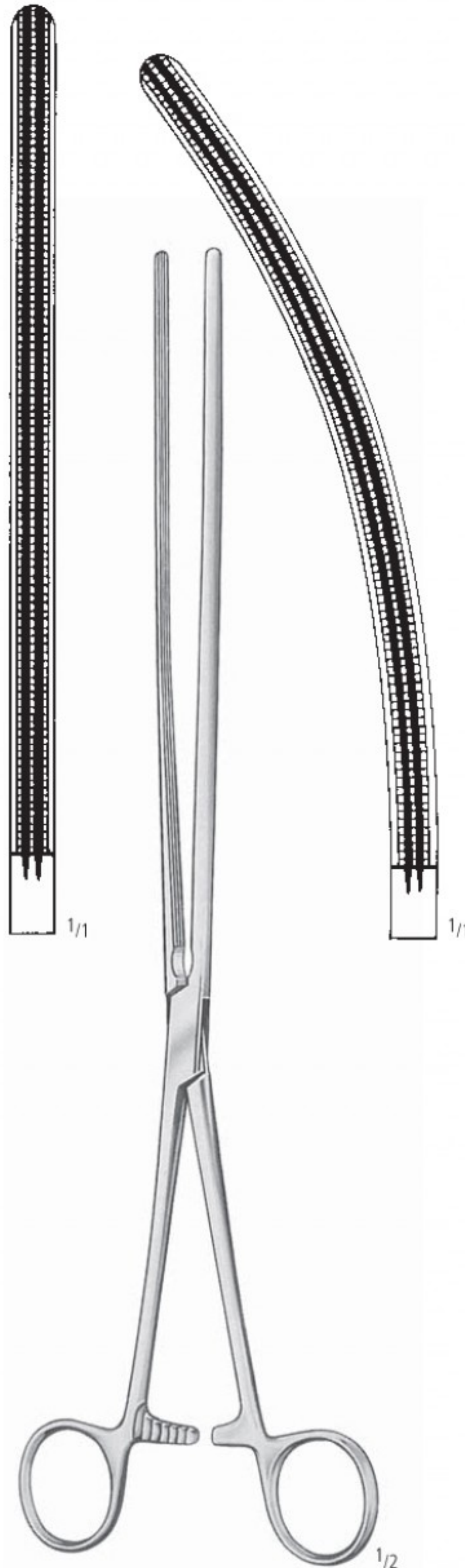

MAYO ROBSON
 KD 256/25 25,0 cm/10" KD 257/25

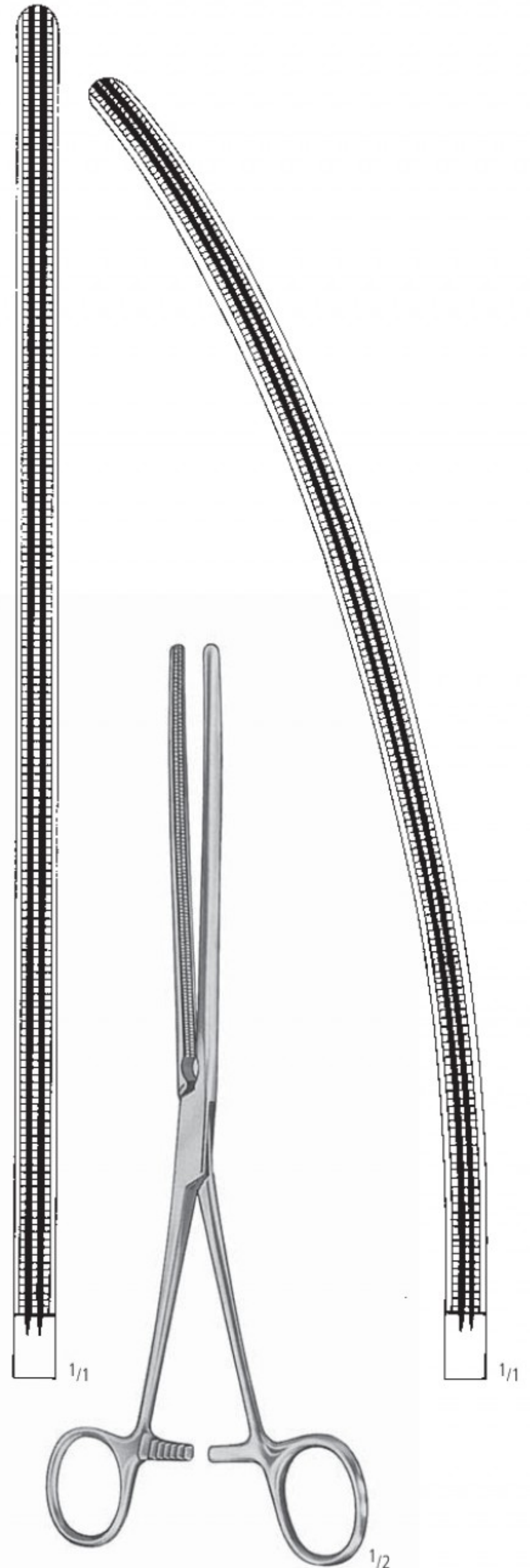

SCUDDER
 KD 258/33 33,0 cm/13" KD 259/33

Atraumatische Magen- und Darmklemmen
 Non-traumatic Stomach and Intestinal Clamp Forceps
 Pinzas-clamps estomacales e intestinales Atrauma
 Pinces-clamps stomacales et pour l'intestin Atrauma
 Pinze stomacali e intestinali Atrauma

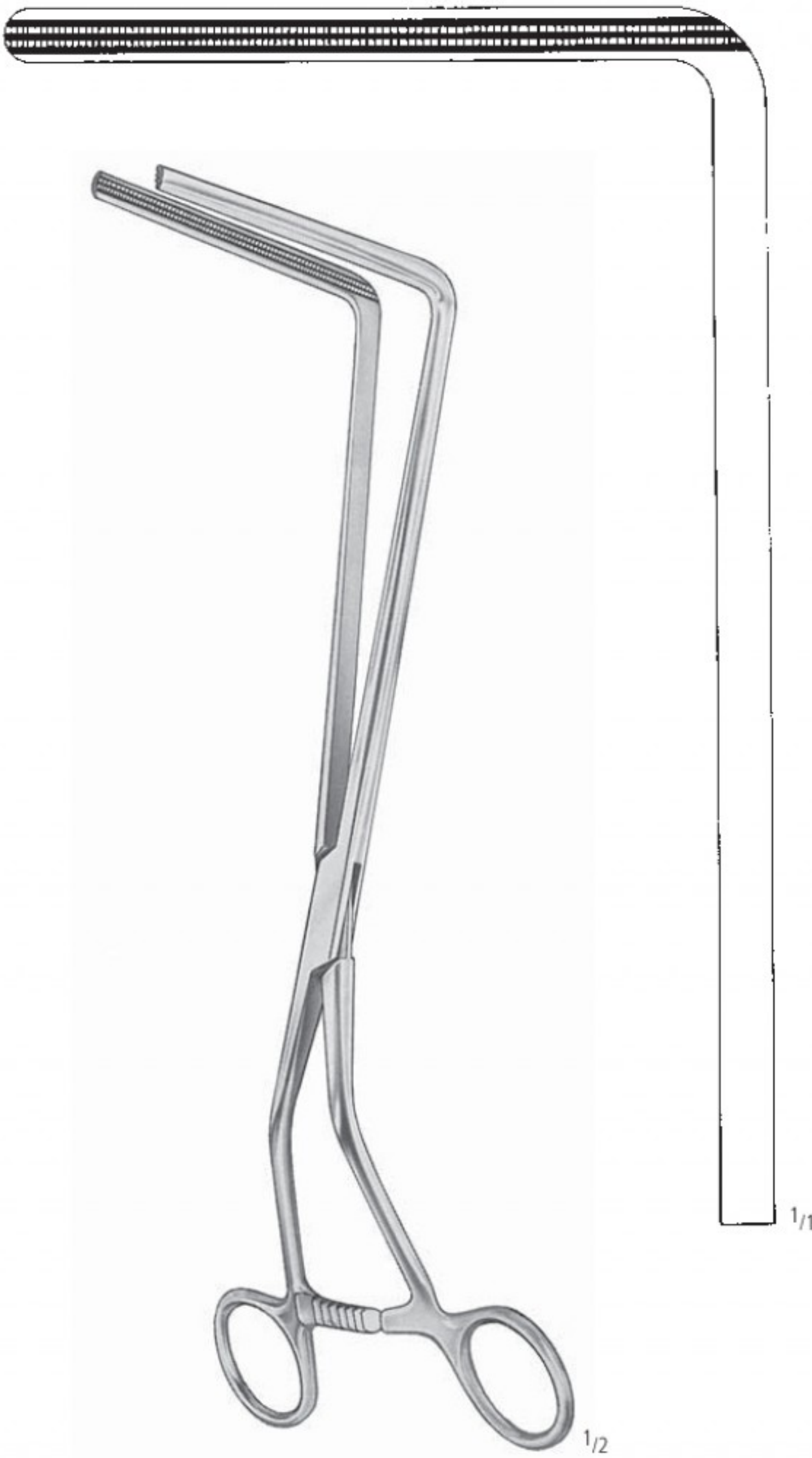

RESANO
 KD 260/30
 30,0 cm/12"



FEHLAND
 KD 270/24
 24,0 cm/9 1/2"

AA
 AB
 AC
 AD
 AE
 AF
 AK
 AL
 AM
 AO
 AP
 AR
 KA
 KB
 KC
 KD
 KU
 KY

Anastomosenklemmen
 Anastomosis Forceps
 Pinzas para anastomosis
 Pincas à anastomose
 Pinze per anastomosi

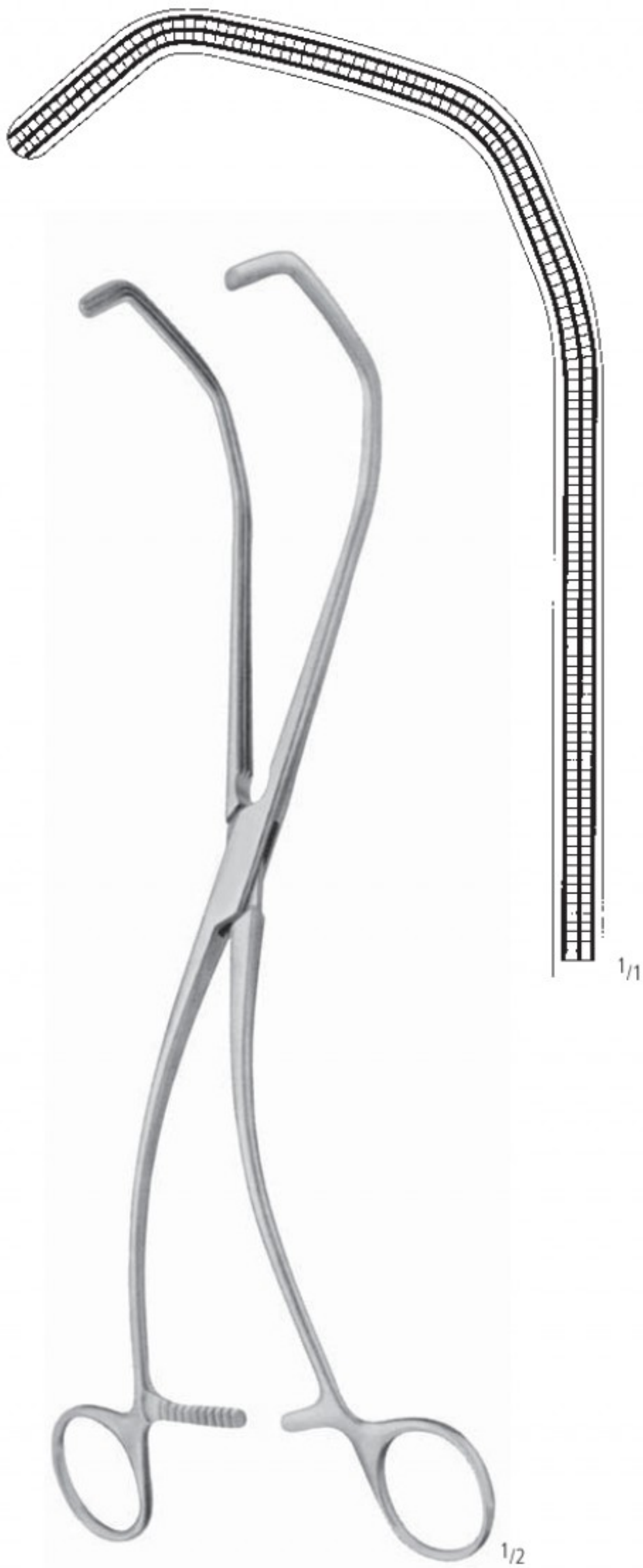

KERSTING
 KD 273/30
 30,0 cm/12"

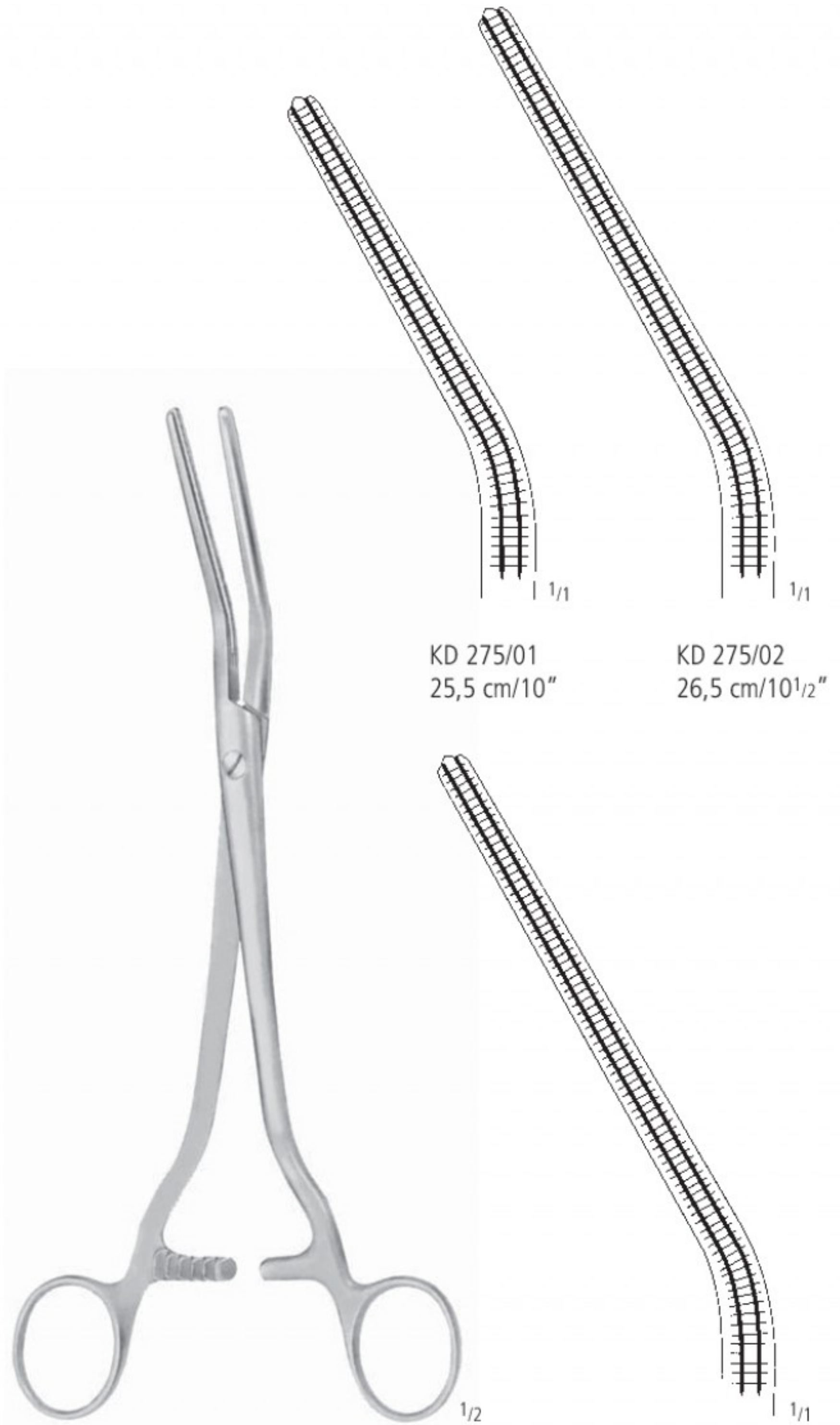

DICK

KD 275/01
 25,5 cm/10"

KD 275/02
 26,5 cm/10¹/₂"

KD 275/03
 27,5 cm/10³/₄"

Anastomosenklemmen
 Anastomosis Forceps
 Pinzas para anastomosis
 Pinces à anastomose
 Pinze per anastomosi



LLOYD-DAVIS
 KD 277/32
 31,5 cm/12¹/₂"



23,0 cm/9"

AA
 AB
 AC
 AD
 AE
 AF
 AK
 AL
 AM
 AO
 AP
 AR
 KA
 KB
 KC
KD
 KU
 KY

Darm- und Magenquetschklemmen
 Intestinal and Stomach Crushing Clamps
 Pinzas-clamps intestinales y estomacales
 Pincas-clamps et Ecraseurs pour l'intestin et l'estomac
 Pinze e Schiacciatori per intestino e stomaco

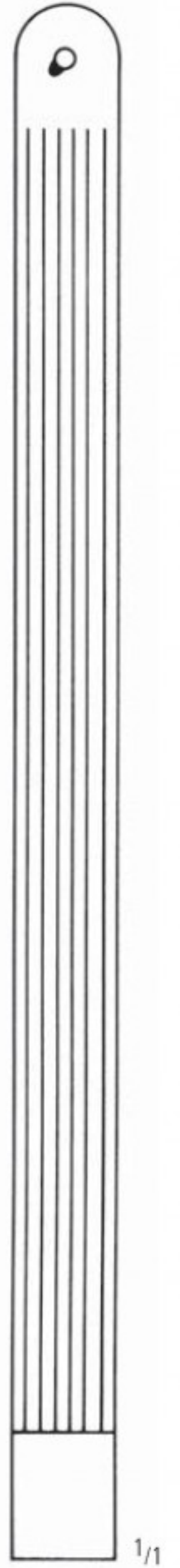
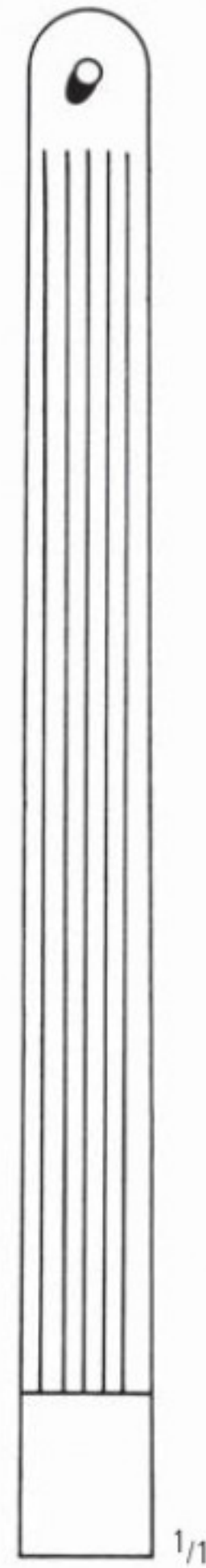
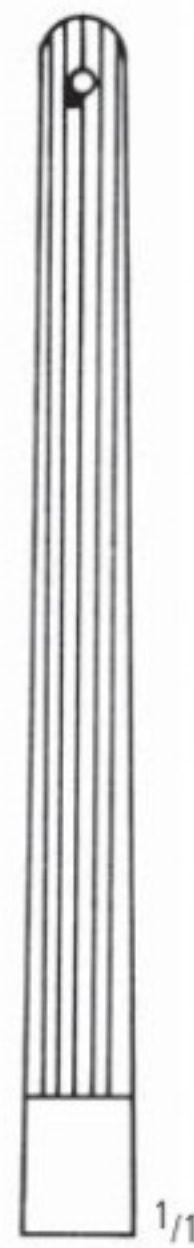
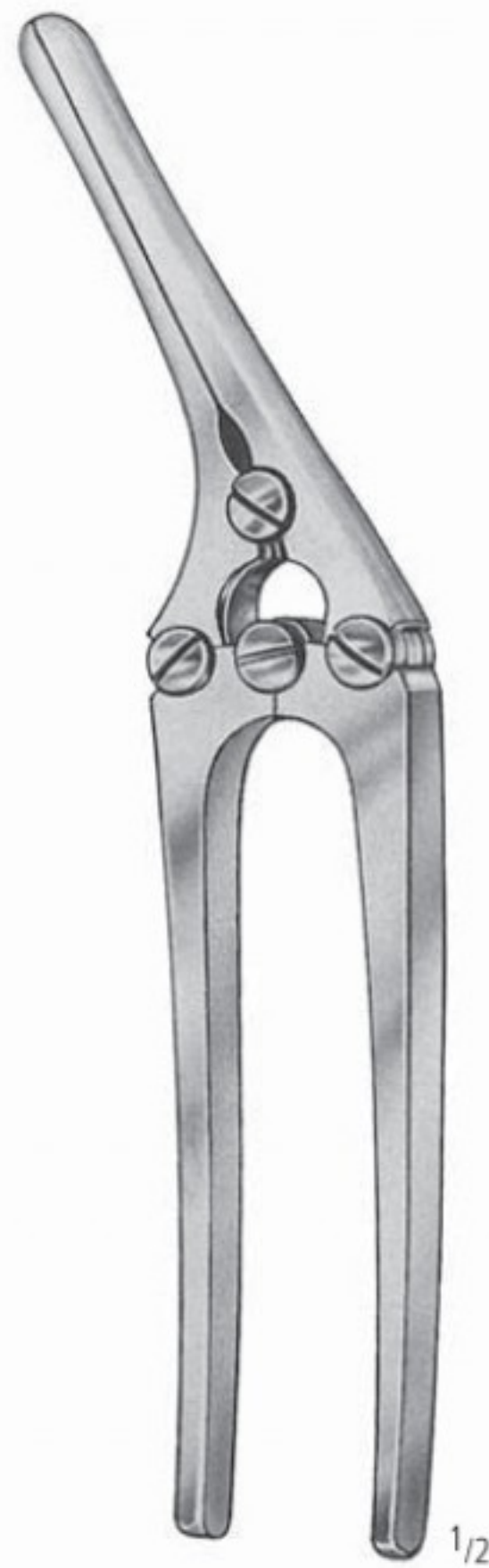

PAYR-BABY
 15,0 cm/6"

ohne Stift
 without pin
 sin espiga
 sans cheville
 senza perno

KD 310/15

mit Stift
 with pin
 con espiga
 avec cheville
 con perno

KD 312/15

PAYR

21,0 cm/8¹/₄"

ohne Stift
 without pin
 sin espiga
 sans cheville
 senza perno

KD 314/21

mit Stift
 with pin
 con espiga
 avec cheville
 con perno

KD 316/21

29,0 cm/11¹/₂"

KD 318/29

KD 320/29

35,0 cm/14"

KD 322/35

KD 324/35

Magenklemmen
 Stomach Clamp Forceps
 Pinzas-clamps estomacales
 Pincas-clamps stomacales
 Pinze stomacali

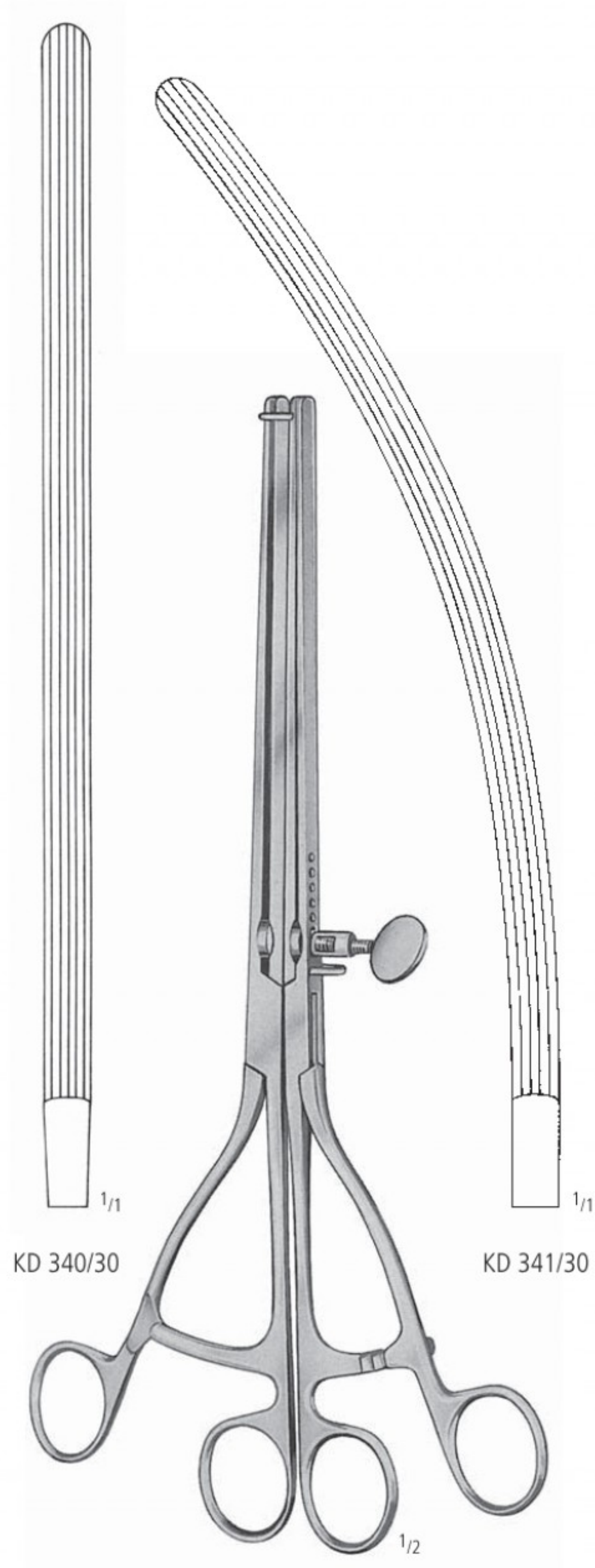

LANE
 30,0 cm/12"

AA
 AB
 AC
 AD
 AE
 AF
 AK
 AL
 AM
 AO
 AP
 AR
 KA
 KB
 KC
 KD
 KU
 KY

Darmklemmen, Anastomosenklemmen
 Intestinal and Anastomosis Clamp Forceps
 Pinzas-clamps intestinales y para anastomosis
 Pincas-clamps intestinales et à anastomose
 Pinze intestinali e per anastomosi



Maullänge
 jaw length
 largo de boca
 longueur des mors
 lunghezza del morso

5,0 cm/2"	KD 350/05
7,0 cm/2 ³ / ₄ "	KD 350/07
10,0 cm/4"	KD 350/10

DE MARTEL-WOLFSON

Satz zu 3 Anastomosenklemmen
 Set of 3 anastomosis clamps
 Juego de 3 clamps para anastomosis
 Jeu de 3 pincas-clamps à anastomose
 Serie di 3 pinze per anastomosi

Darmklemmen, Anastomosenklemmen
 Intestinal and Anastomosis Clamp Forceps
 Pinzas-clamps intestinales y para anastomosis
 Pincas-clamps intestinales et à anastomose
 Pinze intestinali e per anastomosi

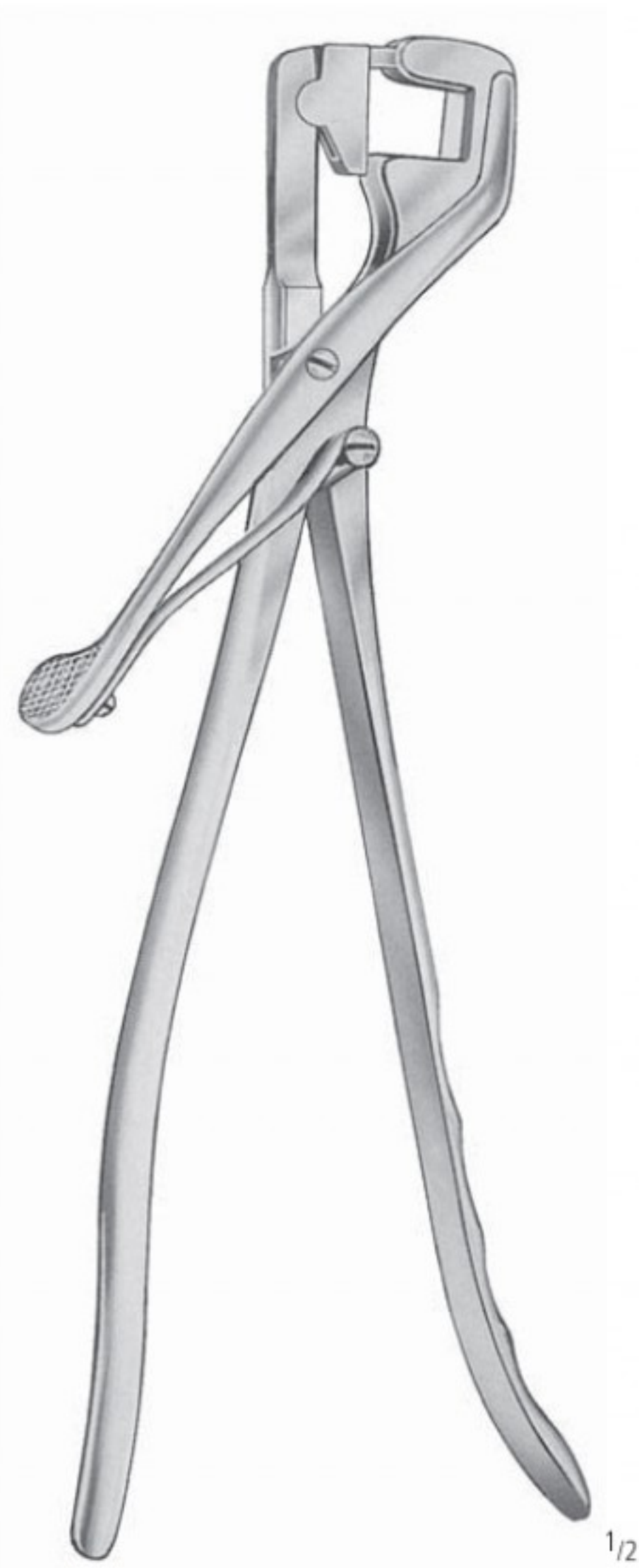

DE MARTEL-WOLFSON
 KD 355/26
 26,0 cm/10¹/₂"



DE MARTEL-WOLFSON
 KD 370/08
 8,5 cm/3¹/₃"



DE MARTEL-WOLFSON
 KD 370/23
 23,0 cm/9"

AA
 AB
 AC
 AD
 AE
 AF
 AK
 AL
 AM
 AO
 AP
 AR
 KA
 KB
 KC
 KD
 KU
 KY

KD MASTDARM RECTUM RECTO RECTUM RETTO

Mastdarm - Spekula
 Rectal Specula
 Espécules rectales
 Spéculums rectaux
 Specoli rettali

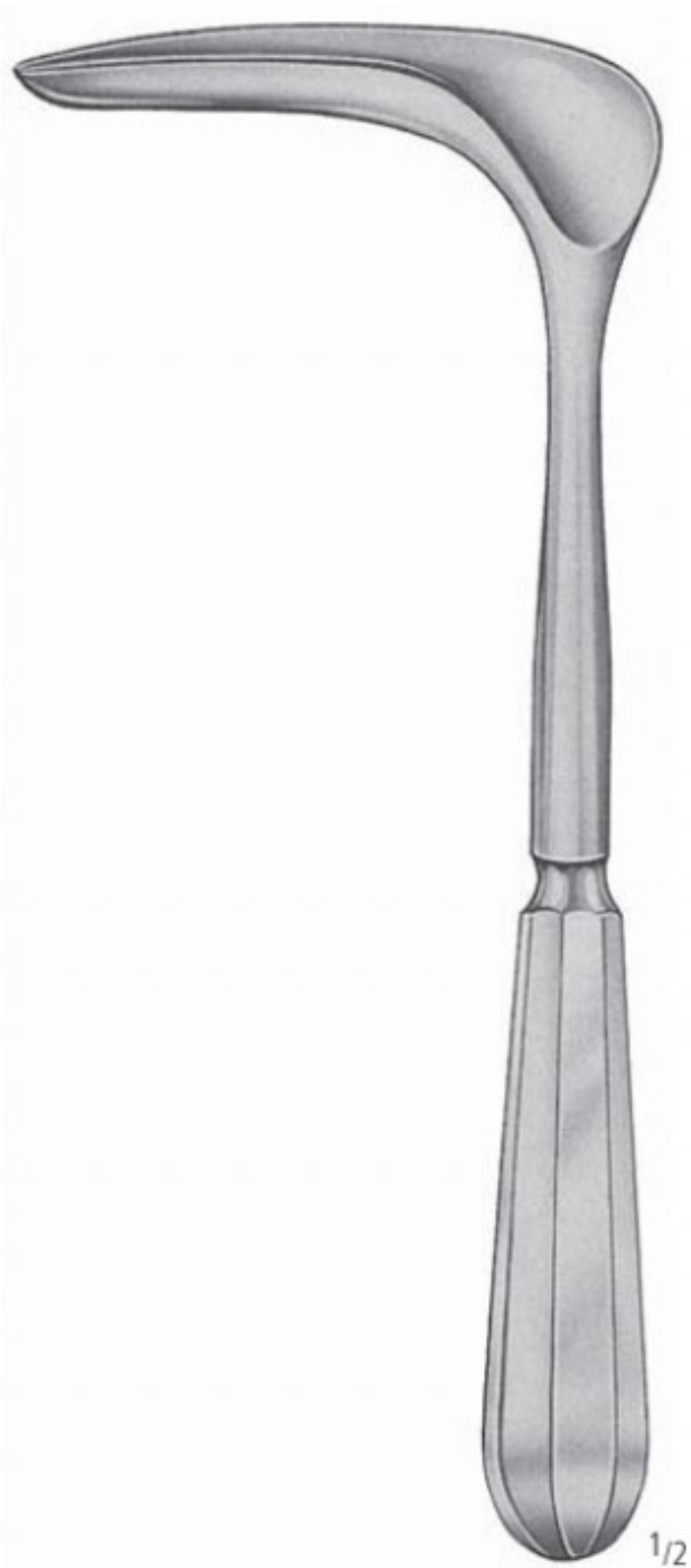

CZERNY
 KD 618/22
 22,0 cm/8³/₄"



SAWYER
 KD 619/01 64 x 22 mm 270 mm
 KD 619/02 75 x 30 mm 280 mm
 KD 619/03 89 x 38 mm 280 mm

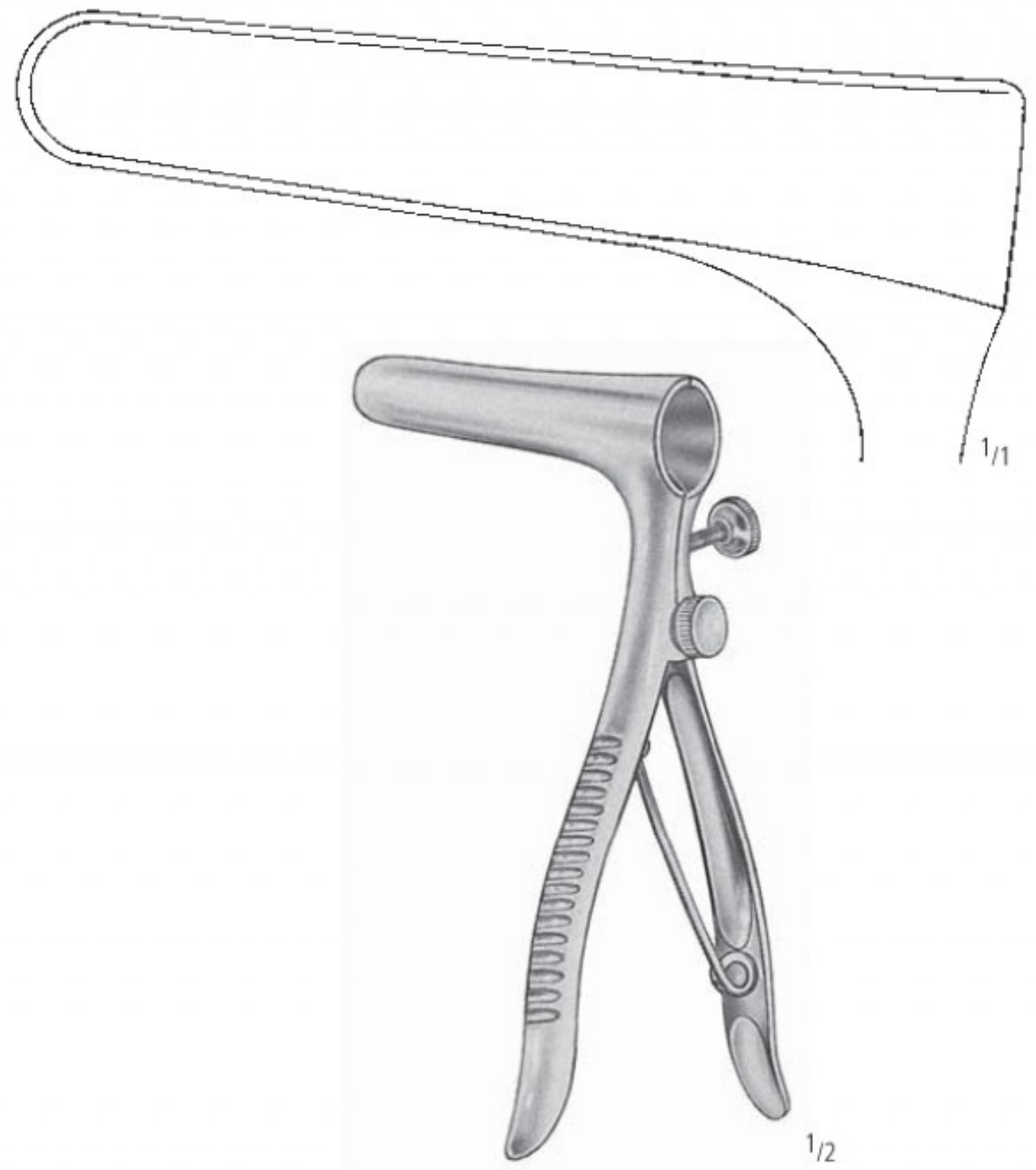

SIMS
 KD 622/15
 15,0 cm/6"

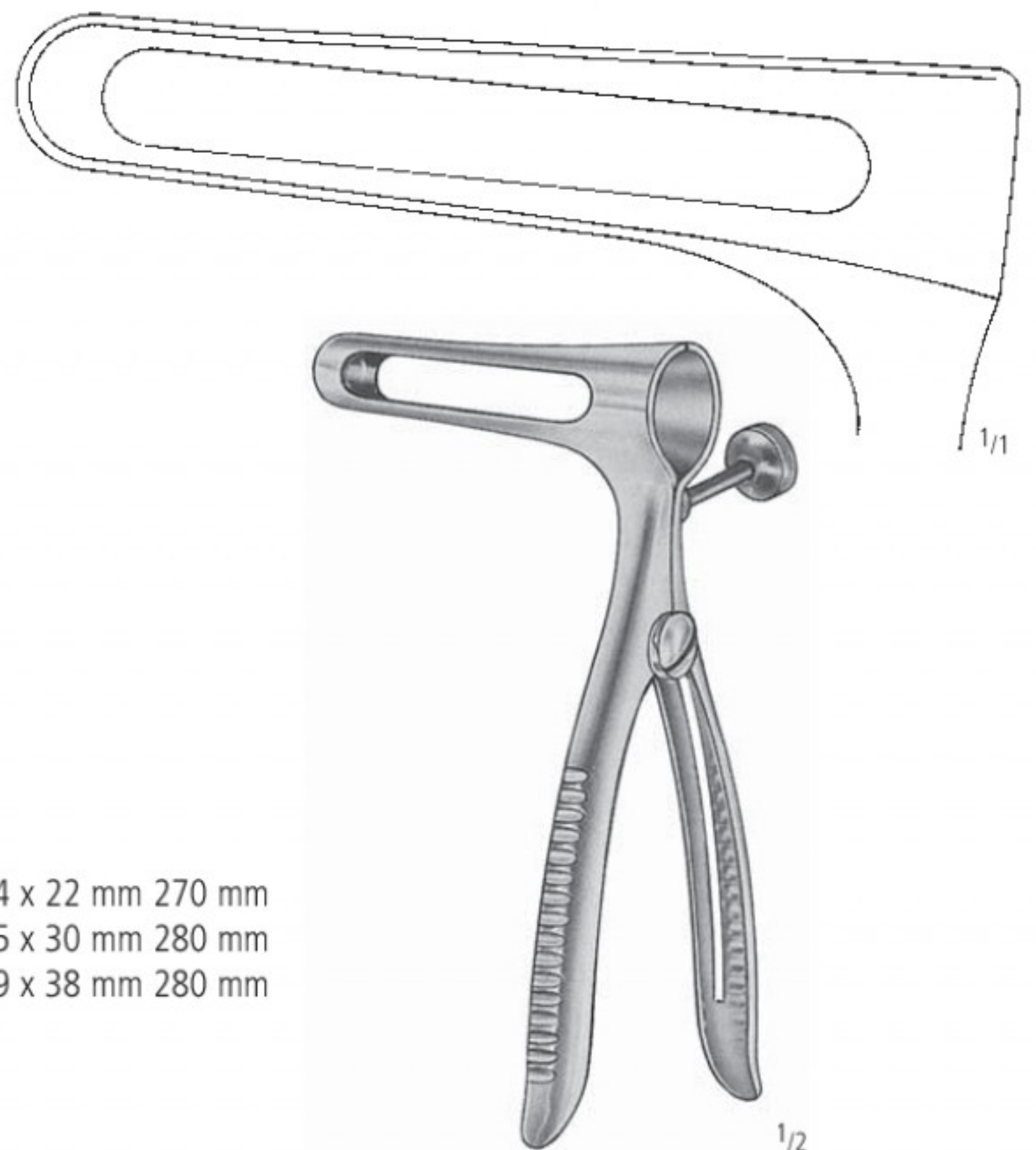

SIMS
 KD 624/15
 15,0 cm/6"

MASTDARM RECTUM RECTO RECTUM RETTO

Mastdarm - Spekula
 Rectal Specula
 Espéculos rectales
 Spéculums rectaux
 Specoli rettali

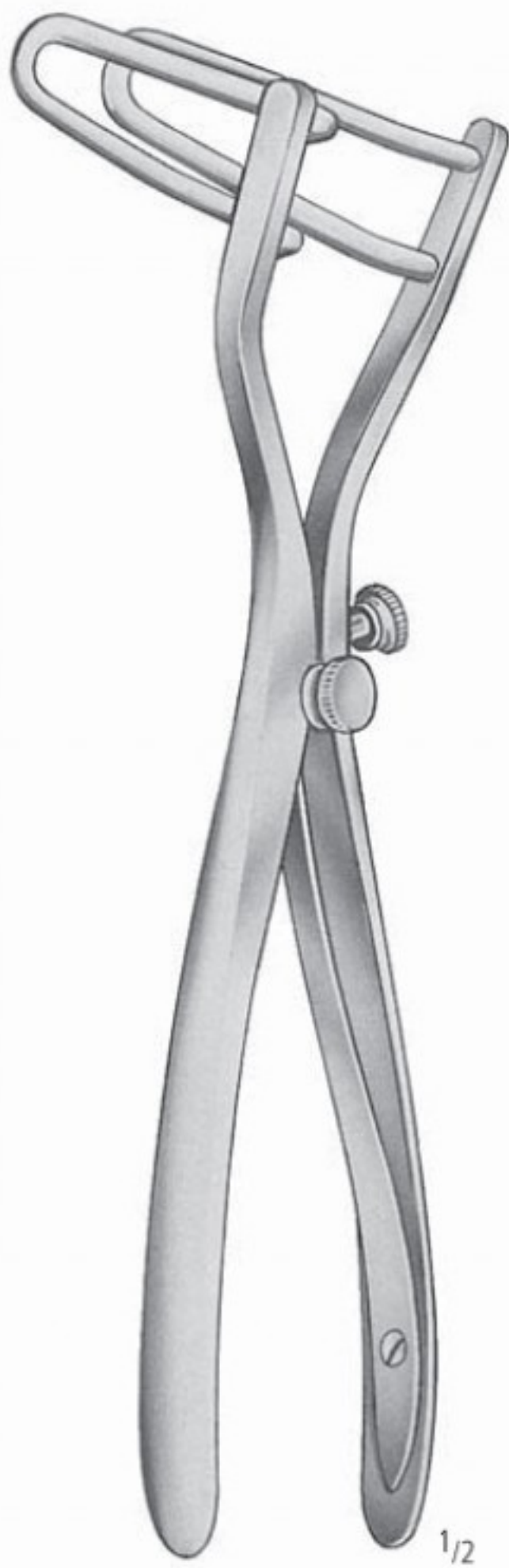

SCHULZE-BERGMANN
 22,0 cm/8³/₄"

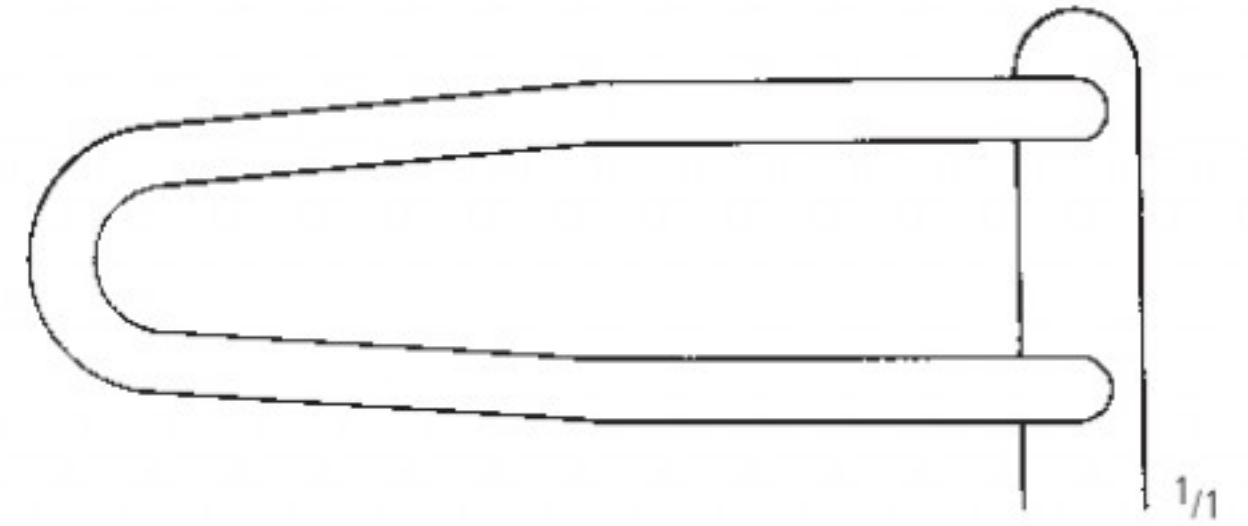

KD 630/06
 60 mm

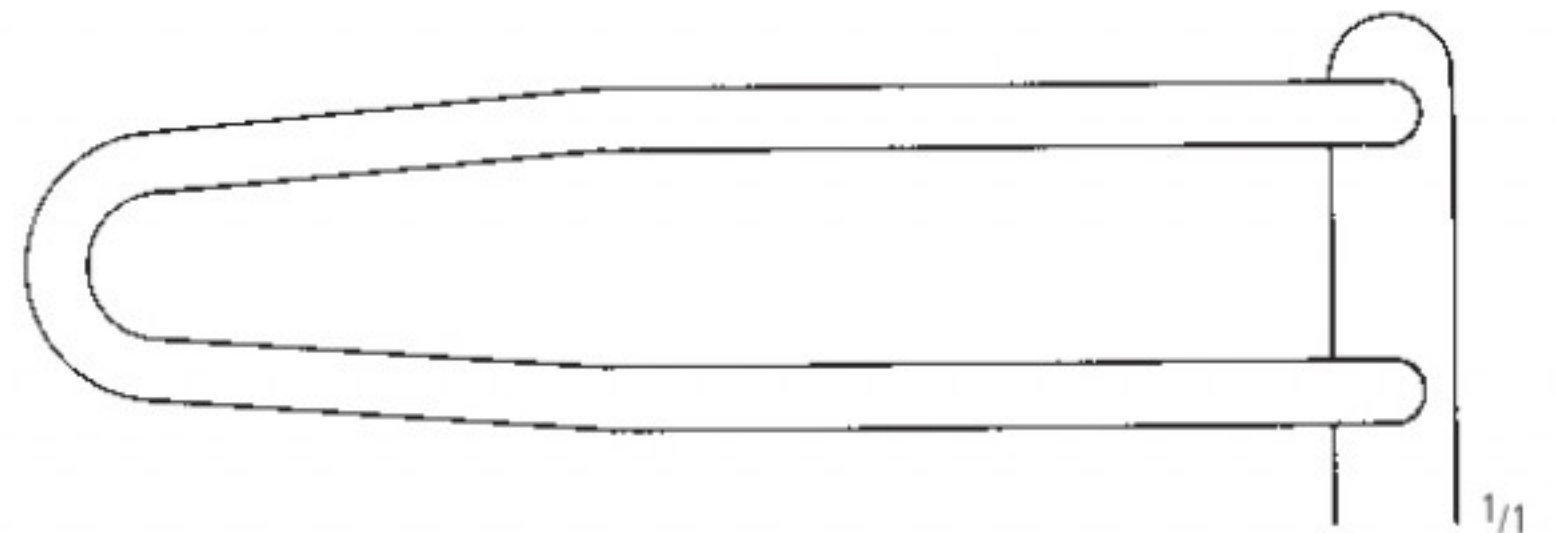

KD 630/08
 80 mm

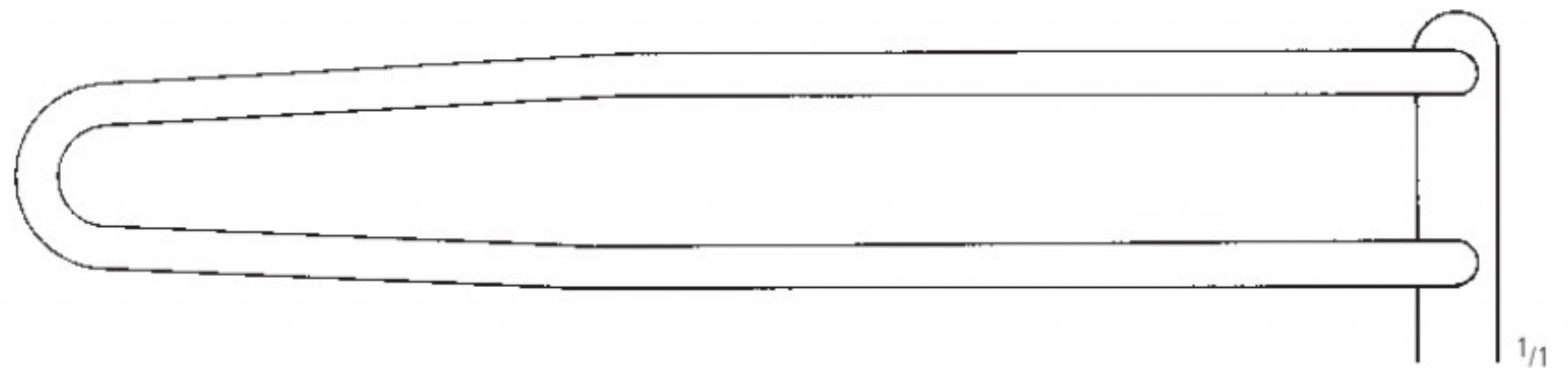

KD 630/12
 125 mm

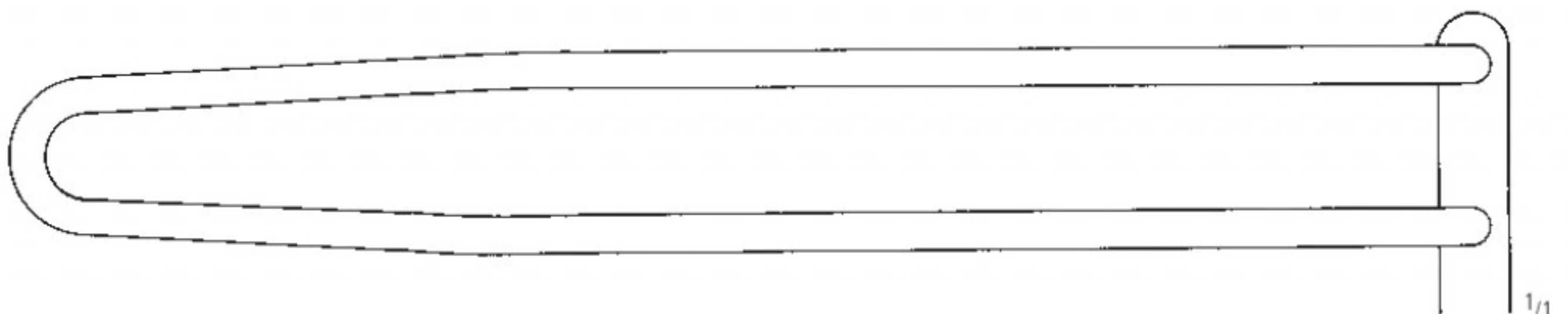

KD 630/15
 150 mm

AA
 AB
 AC
 AD
 AE
 AF
 AK
 AL
 AM
 AO
 AP
 AR
 KA
 KB
 KC
KD
 KU
 KY

KD MASTDARM RECTUM RECTO RECTUM RETTO

Mastdarm - Spekula
 Rectal Specula
 Espécules rectales
 Spéculums rectaux
 Specoli rettali



PRATT
 KD 640/21
 21,5 cm/8½"
 85 x 25 mm

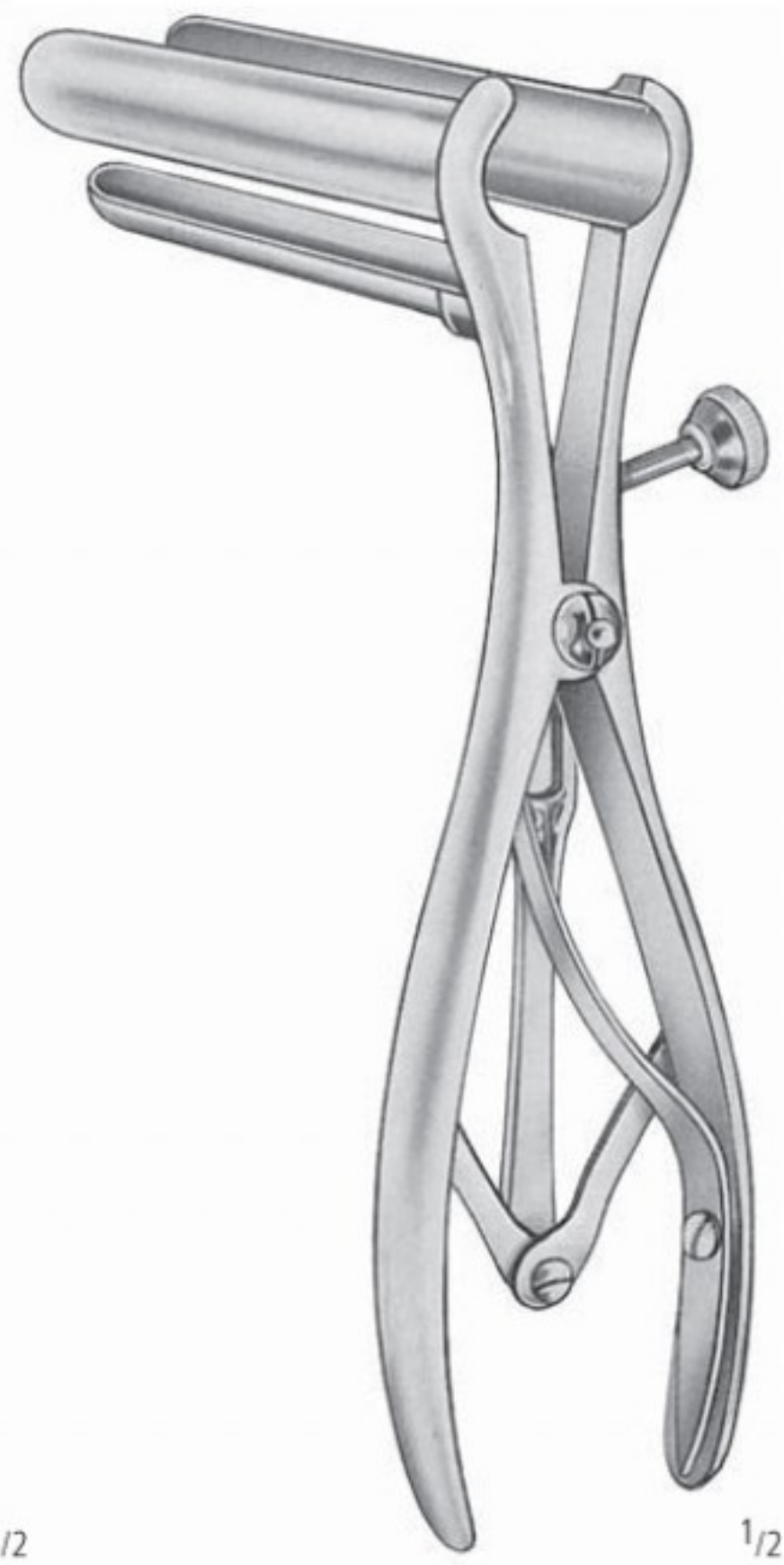

MATHIEU
 KD 650/19
 19,5 cm/7¾"
 90 x 15 mm

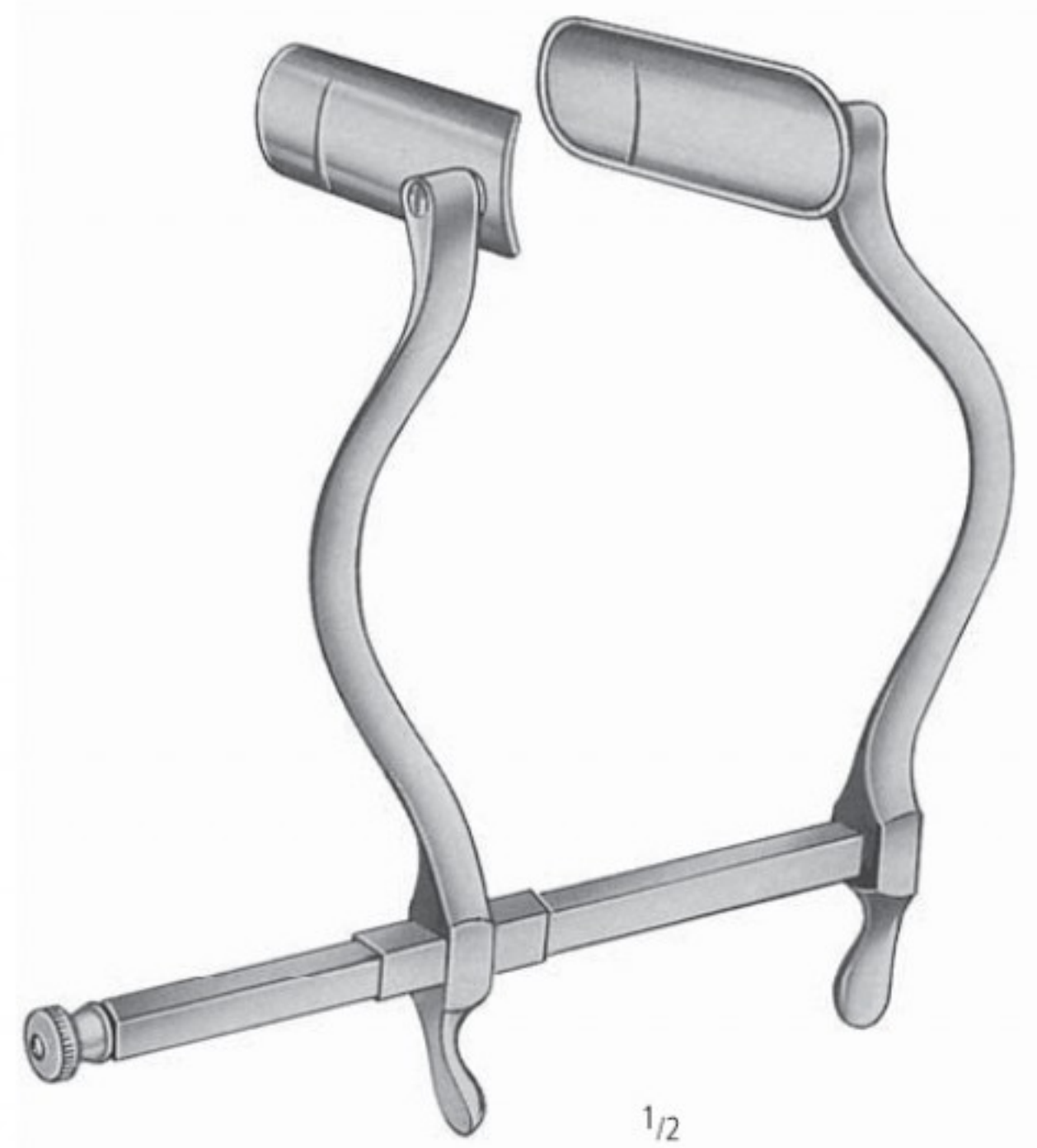

SMITH-BUIE
 KD 660/15
 15,0 cm/6"
 75 x 23 mm

MASTDARM RECTUM RECTO RECTUM RETTO

Sphinkterskope, Anuskope, Proktoskope
 Sphincteroscopes, Anoscopes, Proctoscopes
 Esfinteroscopios, Anoscopios, Proctoscopios
 Sphinctérosopes, Anuscopes, Proctoscopes
 Sfinteroscopi, Anoscopi, Protoscopi



ROSCHKE
 KD 662/01
 Ø 15/30 x 70 mm



ROSCHKE
 KD 662/02
 Ø 15/30 x 70 mm



ALAN PARKS
 KD 665/01

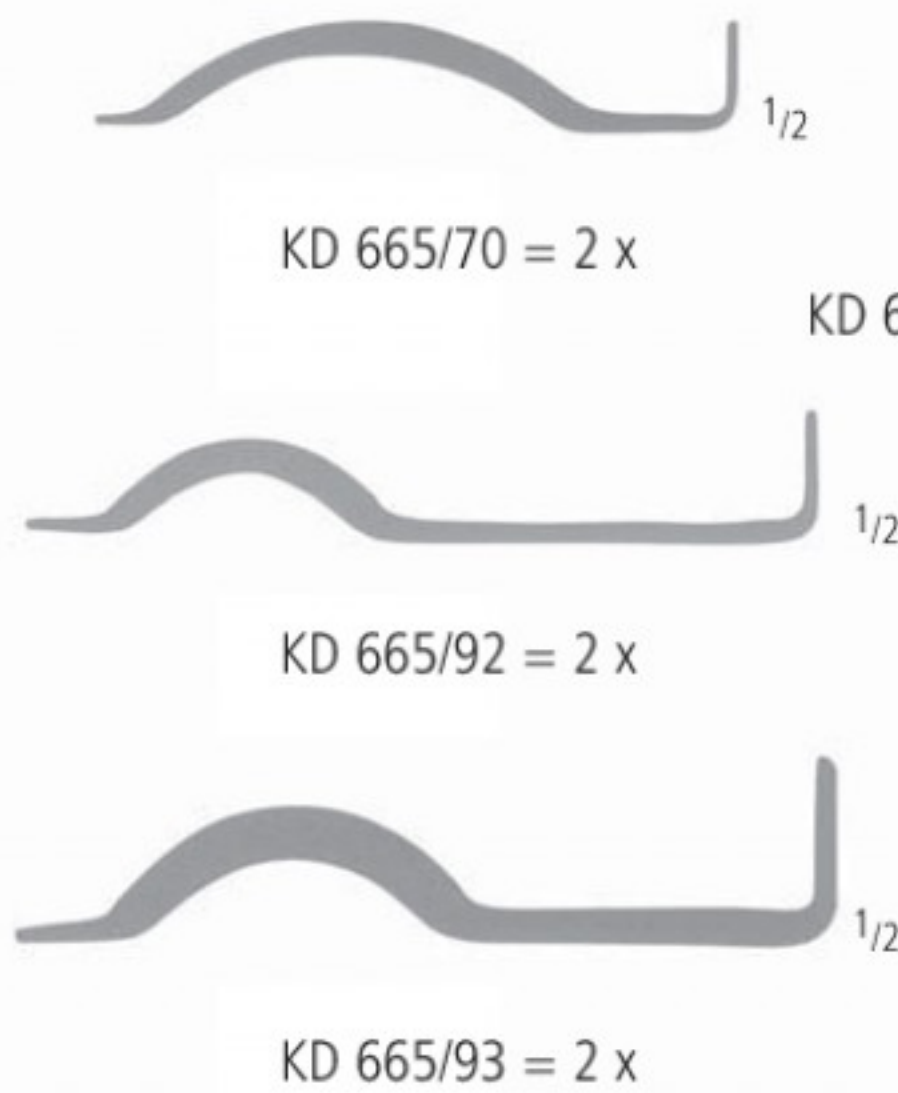

KD 665/70 = 2 x

KD 665/92 = 2 x

KD 665/93 = 2 x

komplett mit 2 Paar Valven
 complete with 2 pair of valves

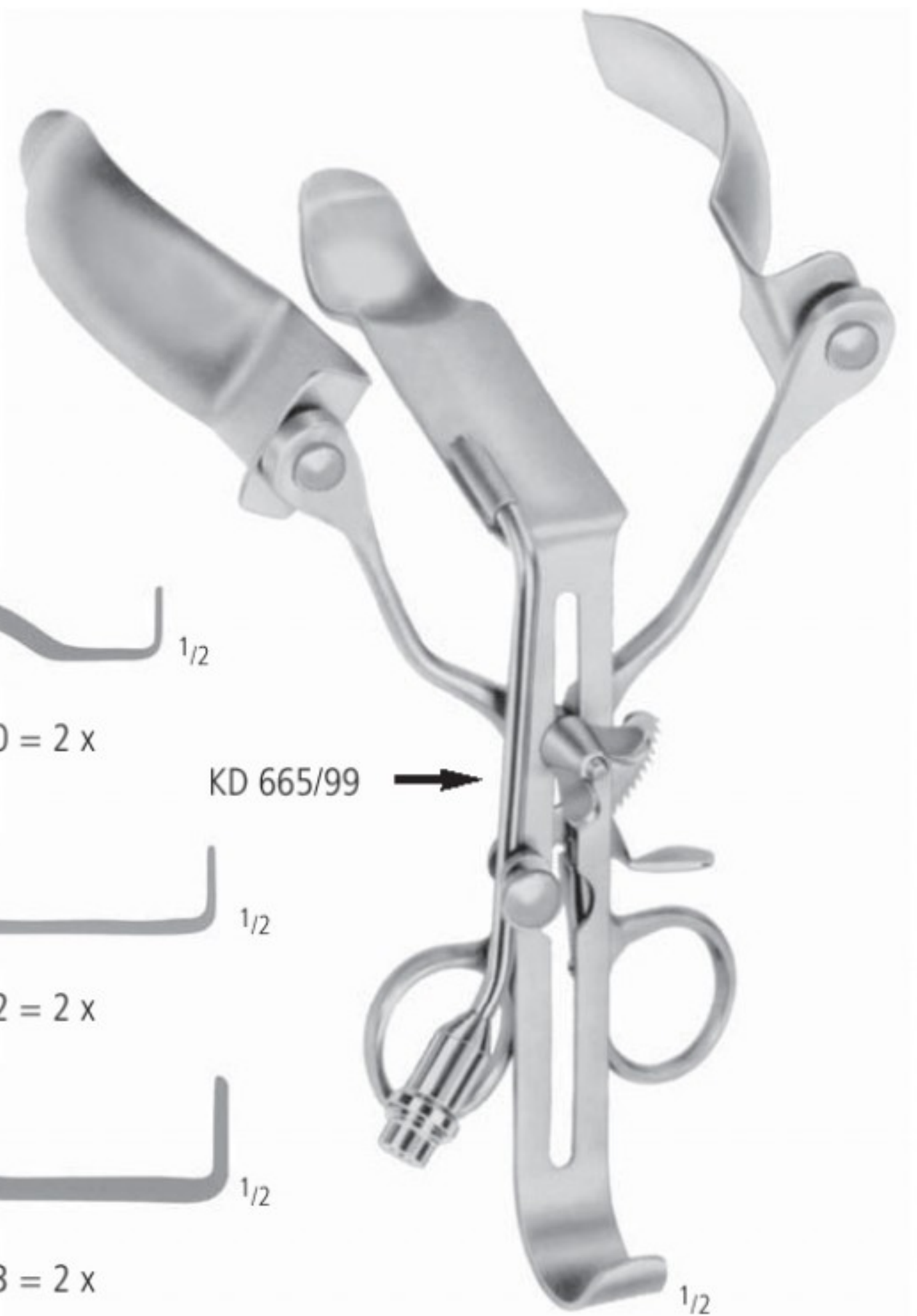

ALAN PARKS
 KD 665/02

AA
 AB
 AC
 AD
 AE
 AF
 AK
 AL
 AM
 AO
 AP
 AR
 KA
 KB
 KC
 KD
 KU
 KY

KD MASTDARM RECTUM RECTO RECTUM RETTO

Sphinkterskope, Anuskope, Proktoskope
 Sphincteroscopes, Anoscopes, Proctoscopes
 Esfinteroscopios, Anoscopios, Proctoscopios
 Sphinctérosopes, Anusopes, Proctosopes
 Sfinteroscopi, Anoscopi, Protoscopi



IVES-FANSLER
 KD 668/22
 Ø 22 mm



IVES-FANSLER
 KD 669/22
 Ø 22 mm

MASTDARM RECTUM RECTO RECTUM RETTO

Sphinkterskope, Anuskope, Proktoskope
 Sphincteroscopes, Anoscopes, Proctoscopes
 Esfinteroscopios, Anoscopios, Proctoscopios
 Sphinctérosopes, Anoscopes, Proctoscopes
 Sfinteroscopi, Anoscopi, Protoscopi



HIRSCHMANN

- KD 670/01 = 16 mm Ø x 65 mm
- KD 670/02 = 19 mm Ø x 65 mm
- KD 670/03 = 22 mm Ø x 65 mm
- KD 670/04 = 22 mm Ø x 125 mm



HIRSCHMANN

- KD 671/01 = 16 mm Ø x 60 mm
- KD 671/02 = 19 mm Ø x 70 mm
- KD 671/03 = 24 mm Ø x 90 mm
- KD 671/04 = 24 mm Ø x 130 mm

AA
AB
AC
AD
AE
AF
AK
AL
AM
AO
AP
AR
KA
KB
KC
KD
KU
KY

KD MASTDARM RECTUM RECTO RECTUM RETTO

Sphinkterskope, Anuskope, Proktoskope
 Sphincteroscopes, Anoscopes, Proctoscopes
 Esfinteroscopios, Anoscopios, Proctoscopios
 Sphinctérosopes, Anusopes, Proctosopes
 Sfinteroscopi, Anoscopi, Protoscopi



BENSAUDE

KD 675/19 = 19 mm Ø x 70 mm

KD 675/22 = 22 mm Ø x 70 mm



KELLY

KD 680/05 = 22 mm Ø x 50 mm

KD 680/10 = 22 mm Ø x 100 mm

KD 680/14 = 22 mm Ø x 140 mm

KD 680/20 = 22 mm Ø x 200 mm

MASTDARM RECTUM RECTO RECTUM RETTO

Sphinkterskope, Anuskope, Proktoskope
 Sphincteroscopes, Anoscopes, Proctoscopes
 Esfinteroscopios, Anoscopios, Proctoscopios
 Sphinctérosopes, Anoscopes, Proctoscopes
 Sfinteroscopi, Anoscopi, Protoscopi



KELLY

KD 685/21 = 21 mm Ø x 50 mm
 KD 685/27 = 27 mm Ø x 50 mm



MORGAN

KD 690/01 = 17 mm Ø x 65 mm
 KD 690/02 = 17 mm Ø x 80 mm
 KD 690/03 = 20 mm Ø x 65 mm
 KD 690/04 = 20 mm Ø x 80 mm
 KD 690/05 = 24 mm Ø x 65 mm
 KD 690/06 = 24 mm Ø x 80 mm



MORGAN

KD 690/99
KALTLICHT / FIBRE OPTIC

AA
 AB
 AC
 AD
 AE
 AF
 AK
 AL
 AM
 AO
 AP
 AR
 KA
 KB
 KC
KD
 KU
 KY

KD MASTDARM RECTUM RECTO RECTUM RETTO

Anuskope, Proktoskope
 Anoscopes, Proctoscopes
 Anoscopios, Proctoscopios
 Anoscopes, Proctoscopes
 Anoscopi, Proctoscopi

BLOND

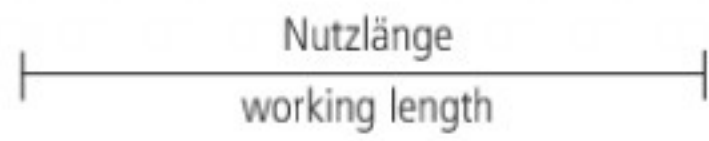

KD 700/01
 18/24 mm Ø x 75 mm



KD 700/02
 18/24 mm Ø x 75 mm



KD 700/03
 15/23 mm Ø x 75 mm



KD 700/04
 18/25 mm Ø x 105 mm



KD 702/01
 26 mm Ø x 60 mm



KD 702/02
 21 mm Ø x 80 mm

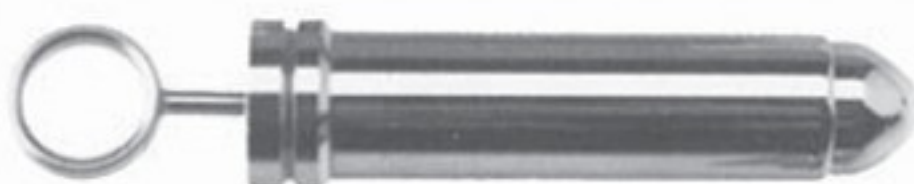

KD 702/03
 24 mm Ø x 80 mm



KD 702/04
 21 mm Ø x 120 mm

MASTDARM RECTUM RECTO RECTUM RETTO

Anuskope, Proktoskope
 Anoscopes, Proctoscopes
 Anoscopios, Proctoscopios
 Anoscopes, Proctoscopes
 Anoscopi, Proctoscopi



KD 705/01

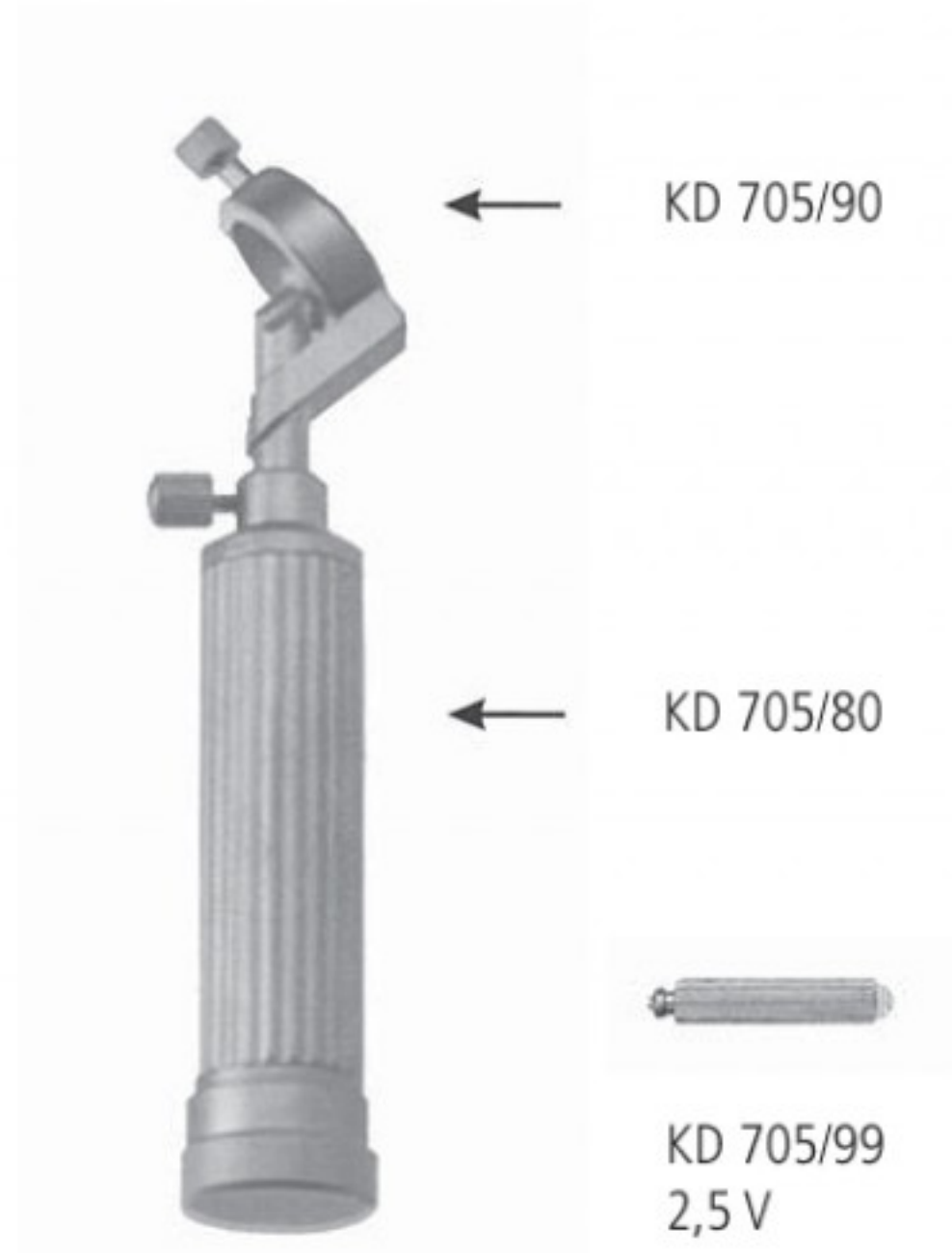

KD 705/02 = KD 705/80
 KD 705/90
 KD 705/99

GRIFFE FÜR KD 700/01 - KD 702/04
 HANDLES FOR KD 700/01 - KD 702/04



BLOND
 KD 707/01 = KD 705/01
 KD 700/01



BLOND
 KD 707/02 = KD 705/02
 KD 700/01

AA
 AB
 AC
 AD
 AE
 AF
 AG
 AH
 AI
 AJ
 AK
 AL
 AM
 AN
 AO
 AP
 AQ
 AR
 AS
 AT
 AU
 AV
 AW
 AX
 AY
 AZ

KD

KU
 KY

Rektoskope
 Rectoscopes
 Rectoscopios
 Rektoskopes
 Rectoscopi



KALTLICHT KOPF
F/O HEAD
 KD 715/01



KALTLICHT
FIBRE OPTIC
 KD 715/02

GRIFFE FÜR NACHFOLGENDE TUBEN
HANDLES FOR TUBES SHOWN NEXT PAGES



KD 717/01
KOPF für KD 717/02
HEAD for KD 717/02



WARMLICHT
BATTERY
 KD 717/02

MASTDARM RECTUM RECTO RECTUM RETTO

Rektoskope
Rectoscopes
Rectoscopios
Rektoskopes
Rectoscopi



DIAGNOSTIC
KD 719/15 = 15 mm Ø x 200 mm



PROKTOSKOP
KD 720/00 = 18/24 mm Ø x 75 mm



ANUSKOP
KD 722/00 = 21 mm Ø x 80 mm



KALTLICHT / FIBRE OPTIC
KD 722/99
75 mm

AA
AB
AC
AD
AE
AF
AK
AL
AM
AO
AP
AR
KA
KB
KC
KD
KU
KY

KD MASTDARM RECTUM RECTO RECTUM RETTO

Rektoskope
Rectoscopes
Rectoscopios
Rektoskopes
Rectoscopi



KD 724/20 = 20 mm Ø x 200 mm
KD 724/25 = 20 mm Ø x 250 mm
KD 724/30 = 20 mm Ø x 300 mm



KD 725/20 = 200 mm
KD 725/25 = 250 mm
KD 725/30 = 300 mm



**KALT LICHT
FIBRE OPTIC**

KD 728/20 = 200 mm
KD 728/25 = 250 mm
KD 728/30 = 300 mm

**WARMLICHT
CONVENTIONAL ILLUMINATION**

KD 729/20 = 200 mm
KD 729/25 = 250 mm
KD 729/30 = 300 mm

KD 729/99



**VERSCHLUSSDECKEL
COVER CAP**
KD 731/00



**SCHWENKLUPPE
SWIVEL LENS**
KD 731/01



**TELESKOPOPTIK
TELESCOPE**
KD 731/02



**DOPPELGEBLÄSE MIT L/L
DOUBLEBLOWER WITH L/L**
KD 731/04

Rektoskope
 Rectoscopes
 Rectoscopios
 Rektoskopes
 Rectoscopi

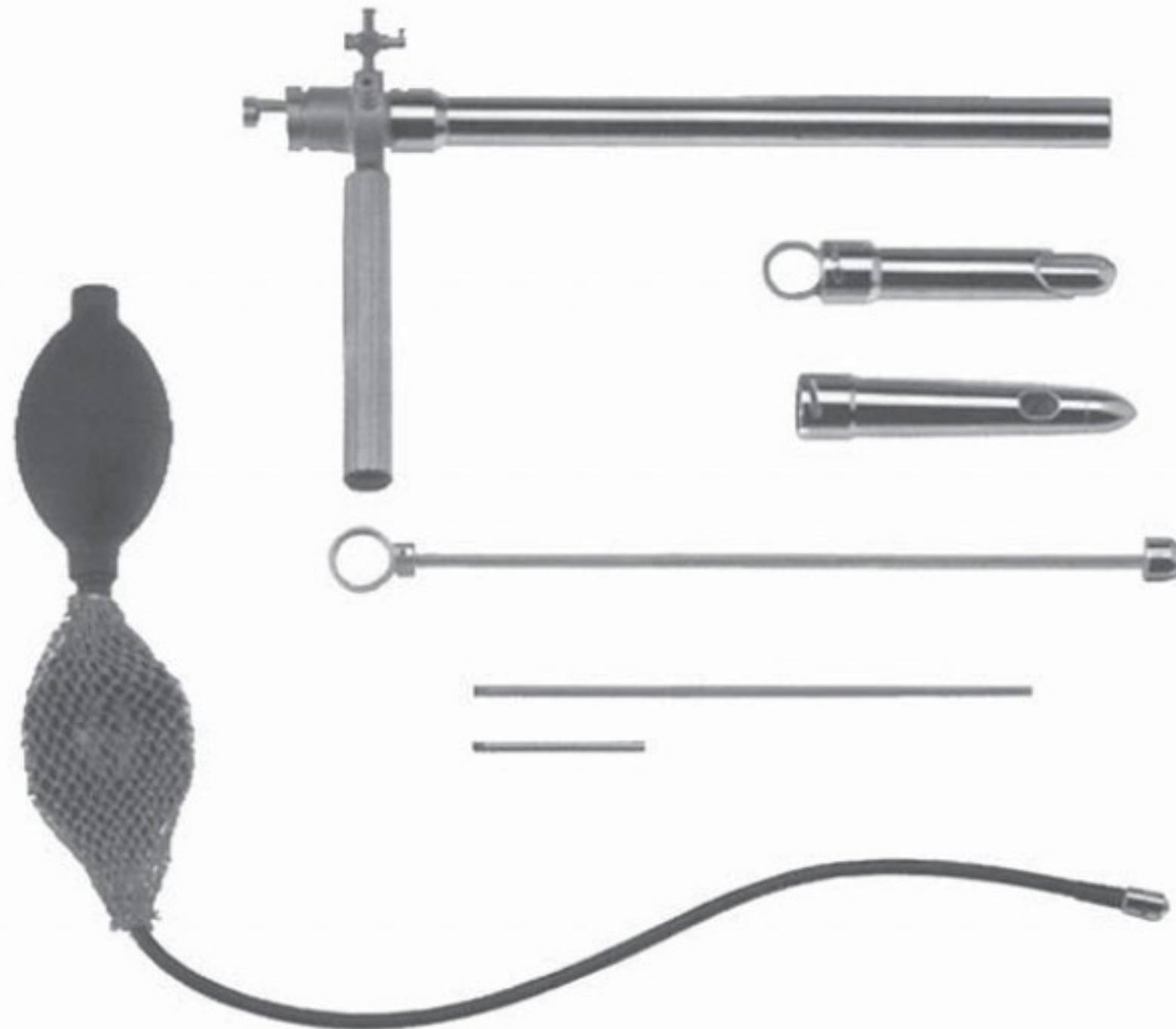

KD 740/00 = KD 715/01
 KD 731/00
 KD 731/01
 KD 715/02
 KD 724/25
 KD 725/25
 KD 728/25
 KD 720/00
 KD 722/00
 KD 722/99
 KD 731/04

REKTO - PROKTOSKOPSET MIT F/O - BELEUCHTUNG

F/O - Rektoskopkopf mit Zweiweghahn, Verschlussdeckel und Schwenklupe, Griff, Rektoskoptubus 250 mm, Ø 20 mm mit Mandrin und F/O Lichtträger, Anuskoptubus 80 mm, mit Mandrin, Proktoskoptubus mit Seitenfenster und kurzem F/O Lichtträger, Doppelgebläse.

RECTO - PROCTOSCOPE WITH F/O - ILLUMINATION

F/O - Rectoscope-head with two-way stop-cock, lens cover and swivel lens, handle, Rectoscope-tube 250 mm, Ø 20 mm, with obturator and F/O light-carrier, Anoscope-tube 80 mm with obturator, Proctoscope-tube with lateral window and short F/O light-carrier, double blower.

AA

AB

AC

AD

AE

AF

AK

AL

AM

AO

AP

AR

KA

KB

KC

KD

KU

KY

Rektoskope
 Rectoscopes
 Rectoscopios
 Rektoskopes
 Rectoscopi

STRAUSS

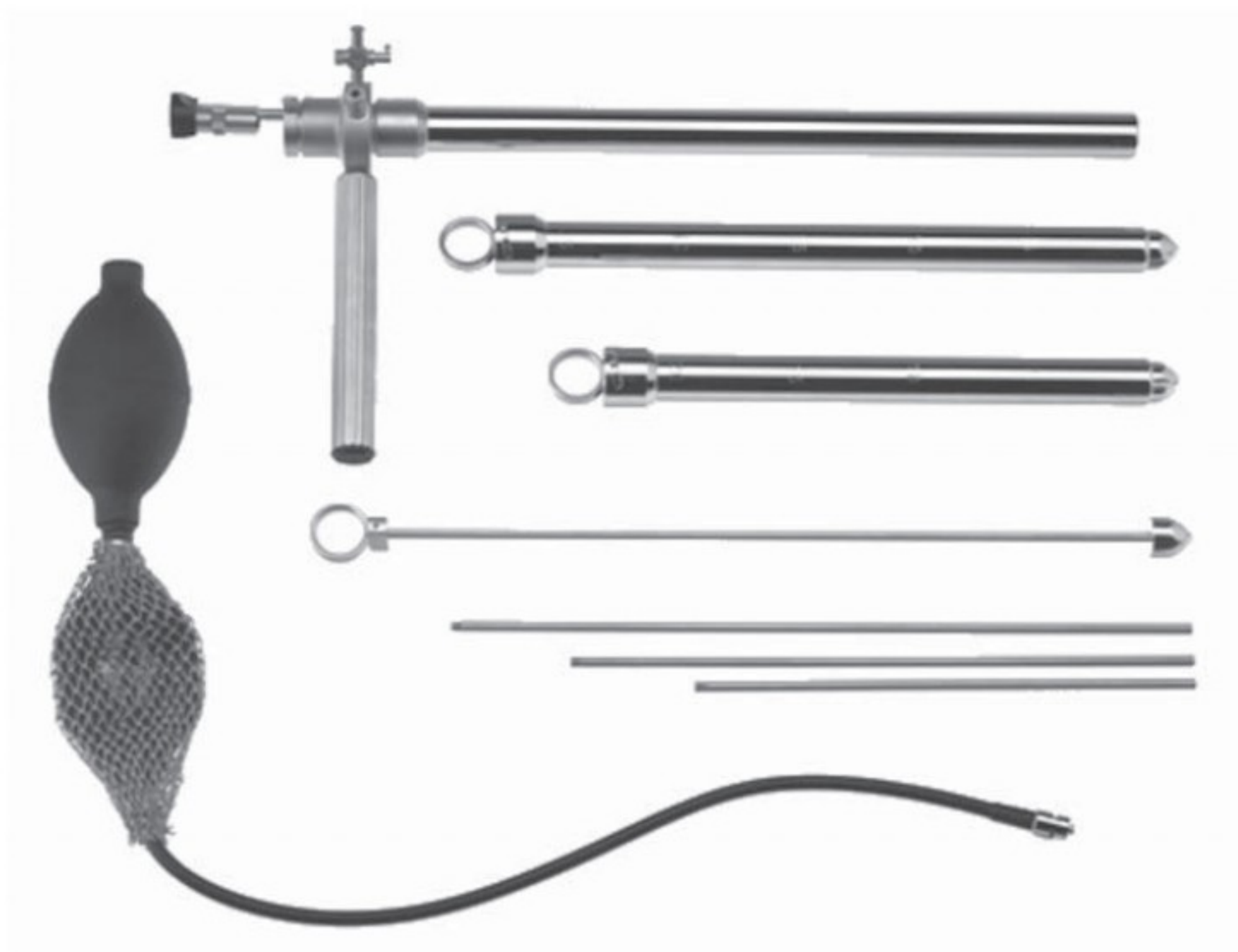

KD 741/00 = KD 715/01
 KD 715/02
 KD 731/00
 KD 731/02
 KD 724/20
 KD 724/25
 KD 724/30
 KD 725/20
 KD 725/25
 KD 725/30
 KD 728/20
 KD 728/25
 KD 728/30
 KD 731/04

F/O - REKTOSKOP NACH STRAUSS

F/O - Rektoskopkopf mit Zweiweghahn, Verschlussdeckel und Teleskop-Optik, Griff, je ein Rektoskoptubus in 200 mm, 250 mm und 300 mm, Ø 20 mm, mit Mandrin und F/O Lichtträger, Doppelgebläse.

F/O - RECTOSCOPE BY STRAUSS

F/O - Rectoscope-head with two-way stop-cock, lens cover and telescope, handle, 3 Rectoscope-tubes Ø 20 mm, with obturator and F/O light-carrier 200 mm, 250 mm and 300 mm, double blower.

Rektoskope
 Rectoscopes
 Rectoscopios
 Rektoskopes
 Rectoscopi

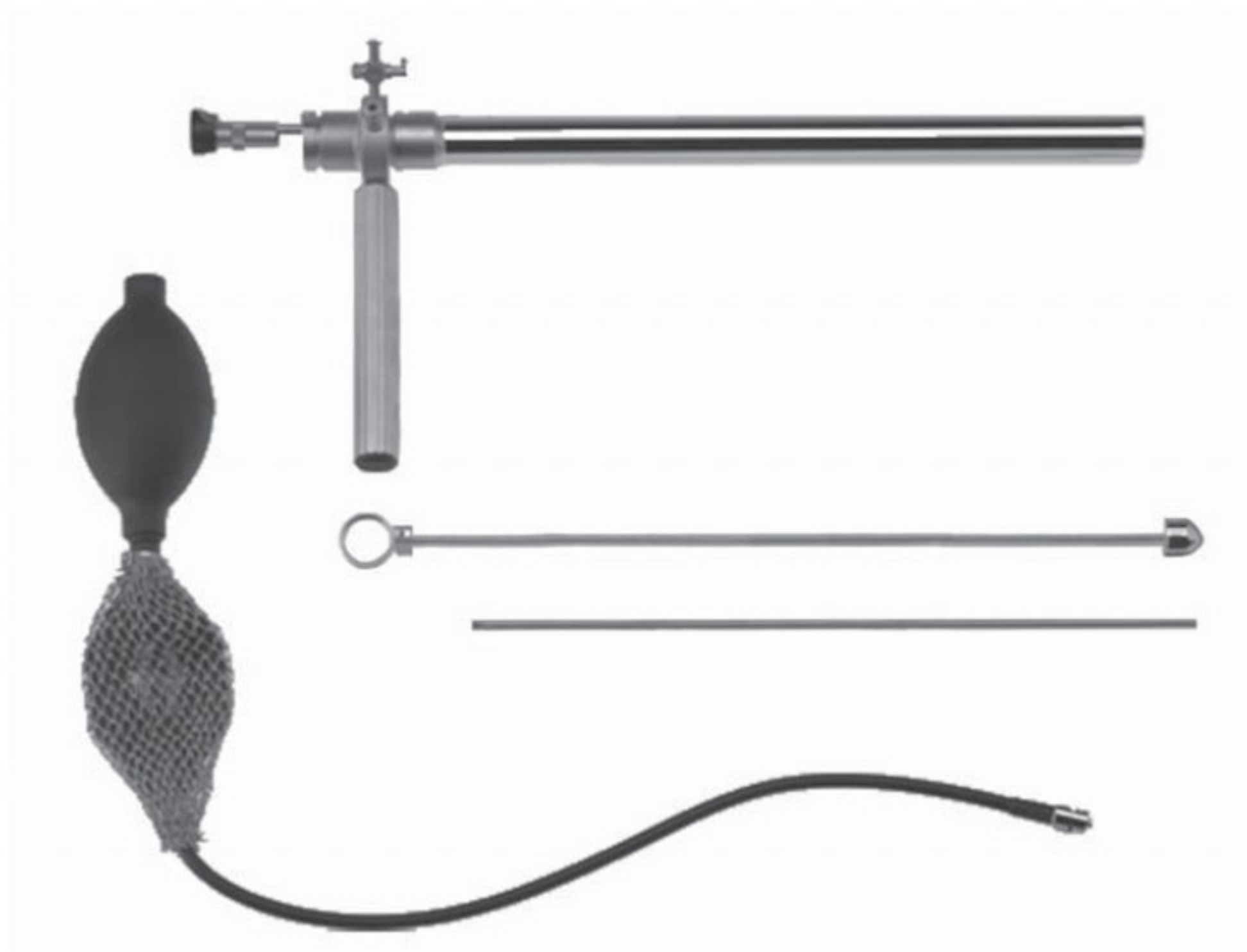

KD 742/00 = KD 715/01
 KD 731/00
 KD 731/02
 KD 715/02
 KD 724/30
 KD 725/30
 KD 728/30
 KD 731/04

KOMPLETTES REKTOSKOPSET MIT F/O - BELEUCHTUNG

F/O - Rektoskopkopf mit Zweiweghahn, Verschlussdeckel und Teleskop-Optik, Griff, Rektoskoptubus in 300 mm Ø 20 mm, mit Mandrin und F/O Lichtträger, Doppelgebläse.

COMPLETE RECTOSCOPE WITH F/O - ILLUMINATION

F/O - Rectoscope-head with two-way stop-cock, lens cover and telescope, handle, Rectoscope-tube 300 mm, Ø 20 mm, with obturator and F/O light-carrier, double blower.

AA
 AB
 AC
 AD
 AE
 AF
 AK
 AL
 AM
 AO
 AP
 AR
 KA
 KB
 KC
 KD
 KU
 KY

Rektoskope
 Rectoscopes
 Rectoscopios
 Rektoskopes
 Rectoscopi

**REKTOSKOP MIT KONVENTIONELLER BELEUCHTUNG
 RECTOSCOPE WITH CONVENTIONAL ILLUMINATION**

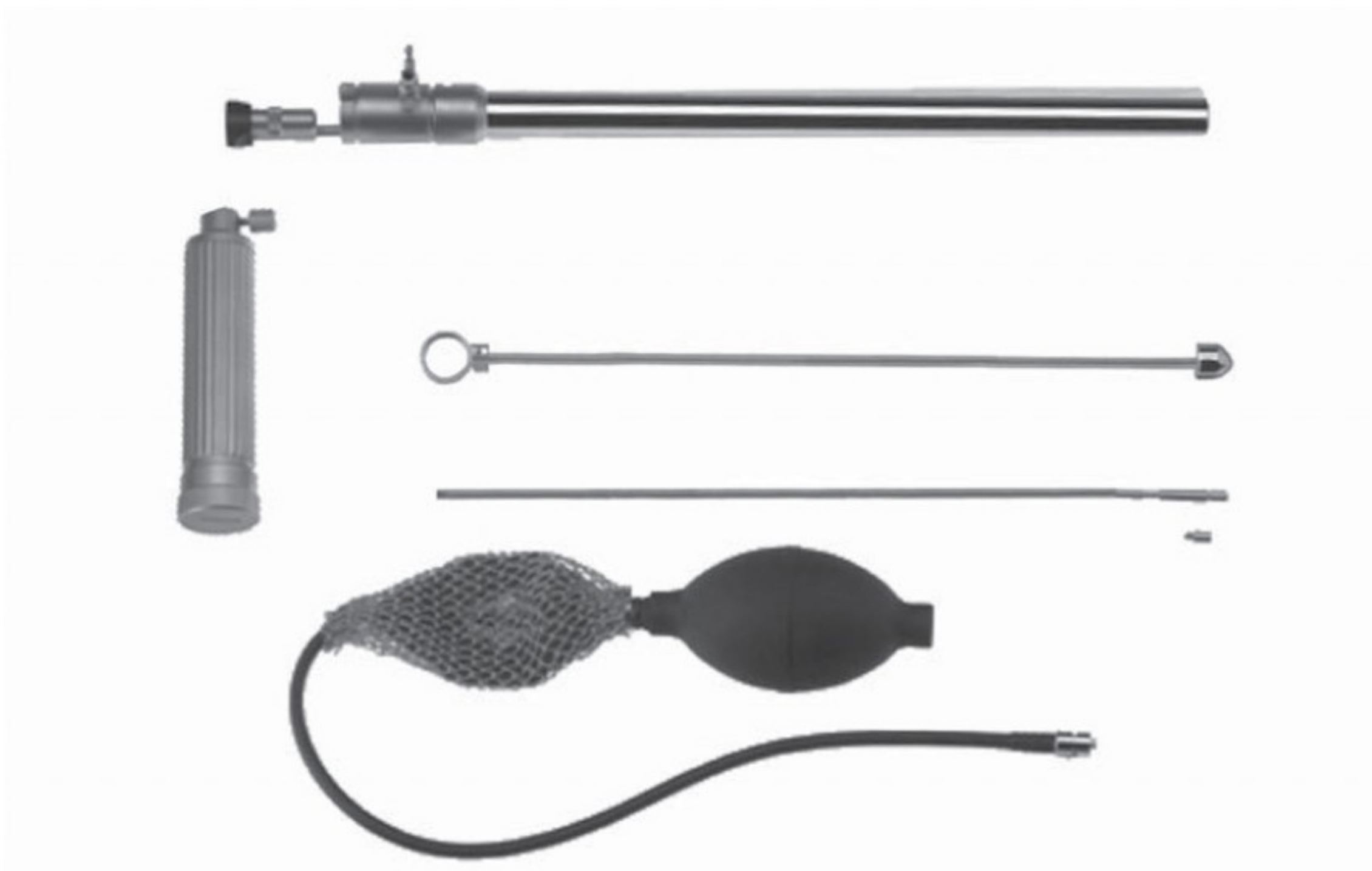

KD 743/00 = KD 717/01
 KD 731/00
 KD 731/02
 KD 724/30
 KD 725/30
 KD 729/30
 KD 731/04
 KD 717/02

KOMPLETTES REKTOSKOP MIT KONVENTIONELLER BELEUCHTUNG

Rektoskopkopf mit Zweiweghahn, Verschlussdeckel und Teleskop-Optik, Rektoskoptubus 300 mm, Ø 20 mm, mit Mandrin und Lampenträger, Doppelgebläse, Batteriegriff.

COMPLETE RECTOSCOPE WITH CONVENTIONAL ILLUMINATION

Rectoscope-head with two-way stop-cock, lens cover and telescope, Rectoscope-tube 300 mm, Ø 20 mm, with obturator and lamp-carrier, double blower, battery handle..

MASTDARM RECTUM RECTO RECTUM RETTO

Mastdarm - Biopsiezangen
 Rectal Biopsy Forceps
 Pinzas saca bocado para biopsia retal
 Pincas emporte-pièces à biopsie rectale
 Pinze tagliente per biopsia rettale

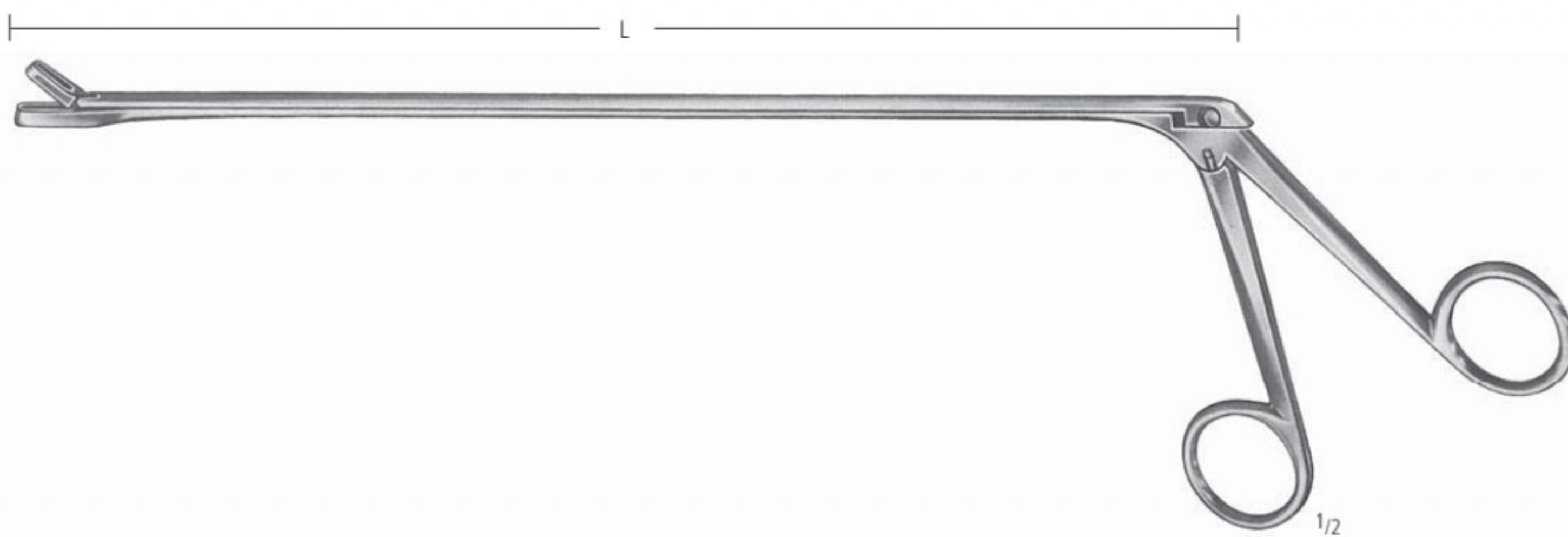

YEOMANN

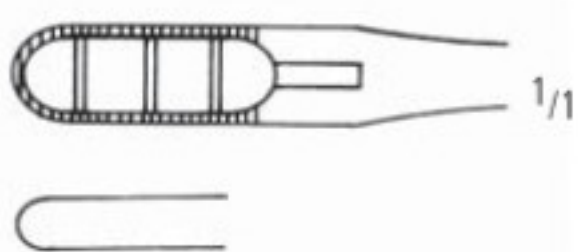

Fig.1
 KD 751/28
 KD 751/35
 KD 751/42

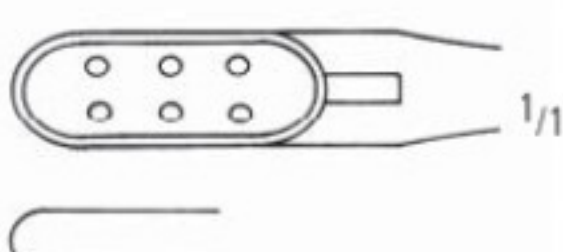

Fig. 2
 KD 752/28
 KD 752/35
 KD 752/42

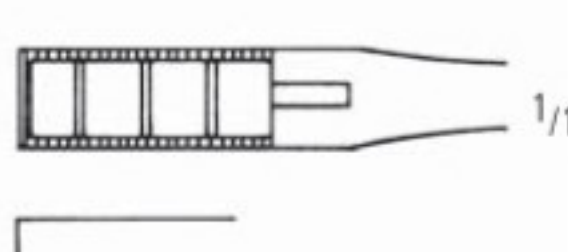
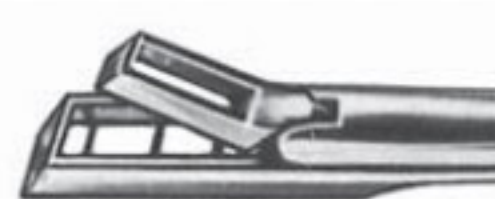

Fig. 3
 KD 753/28
 KD 753/35
 KD 753/42

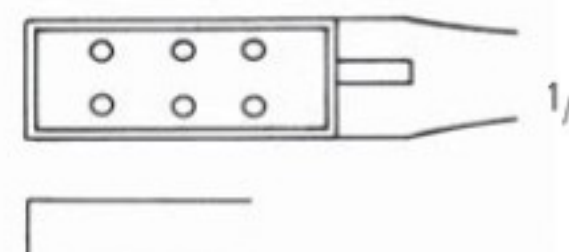

Fig. 4
 KD 754/28
 KD 754/35
 KD 754/42

L = 28,0 cm/11"
 L = 35,0 cm/14"
 L = 42,0 cm/16¹/₂"

AA
 AB
 AC
 AD
 AE
 AF
 AK
 AL
 AM
 AO
 AP
 AR
 KA
 KB
 KC
 KD
 KU
 KY

KD MASTDARM RECTUM RECTO RECTUM RETTO

Hämorrhoidal-Ligatoren
 Haemorrhoidal Ligators
 Ligadores hemorroides
 Ligateurs hémorroïdes
 Legatori emorroidali

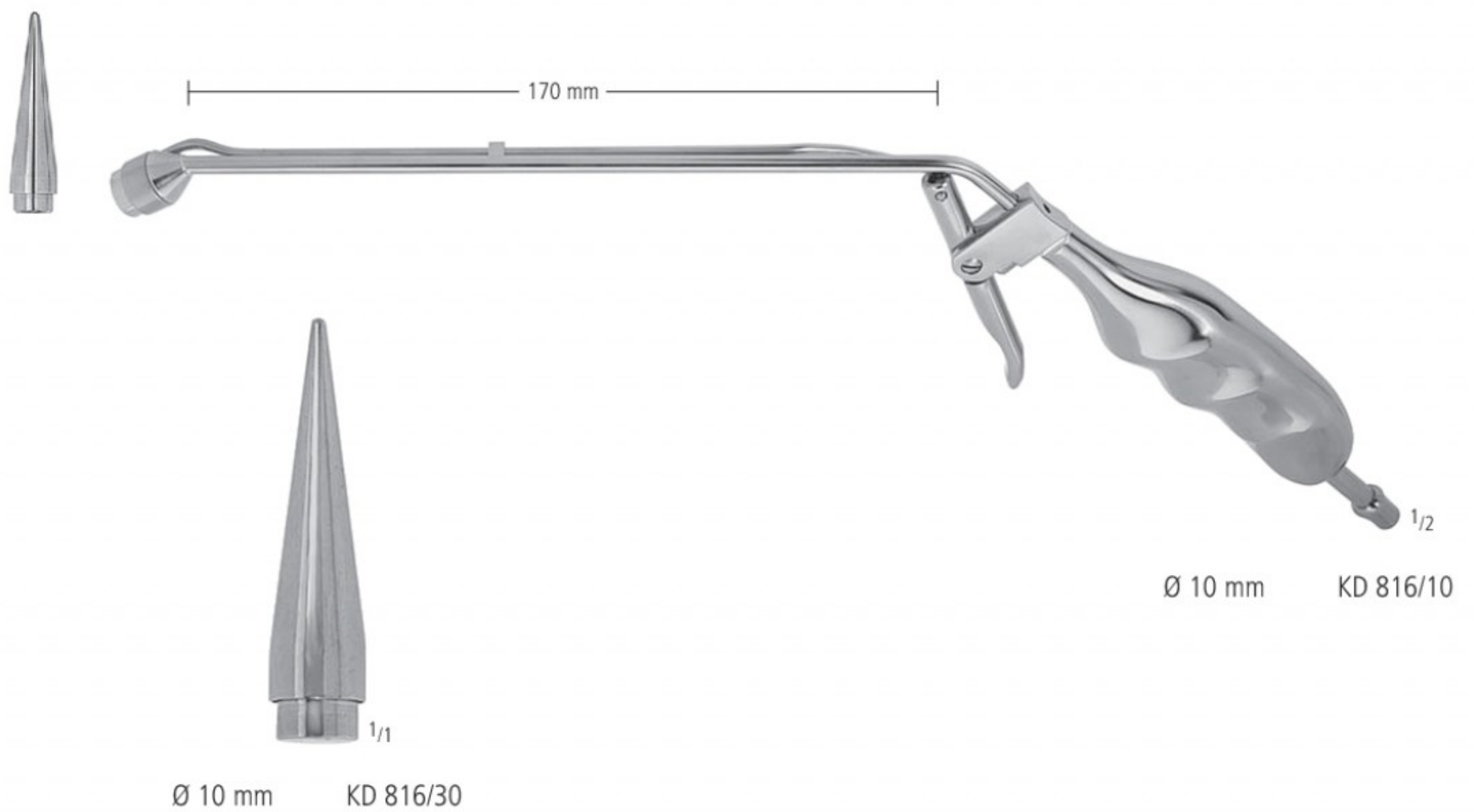
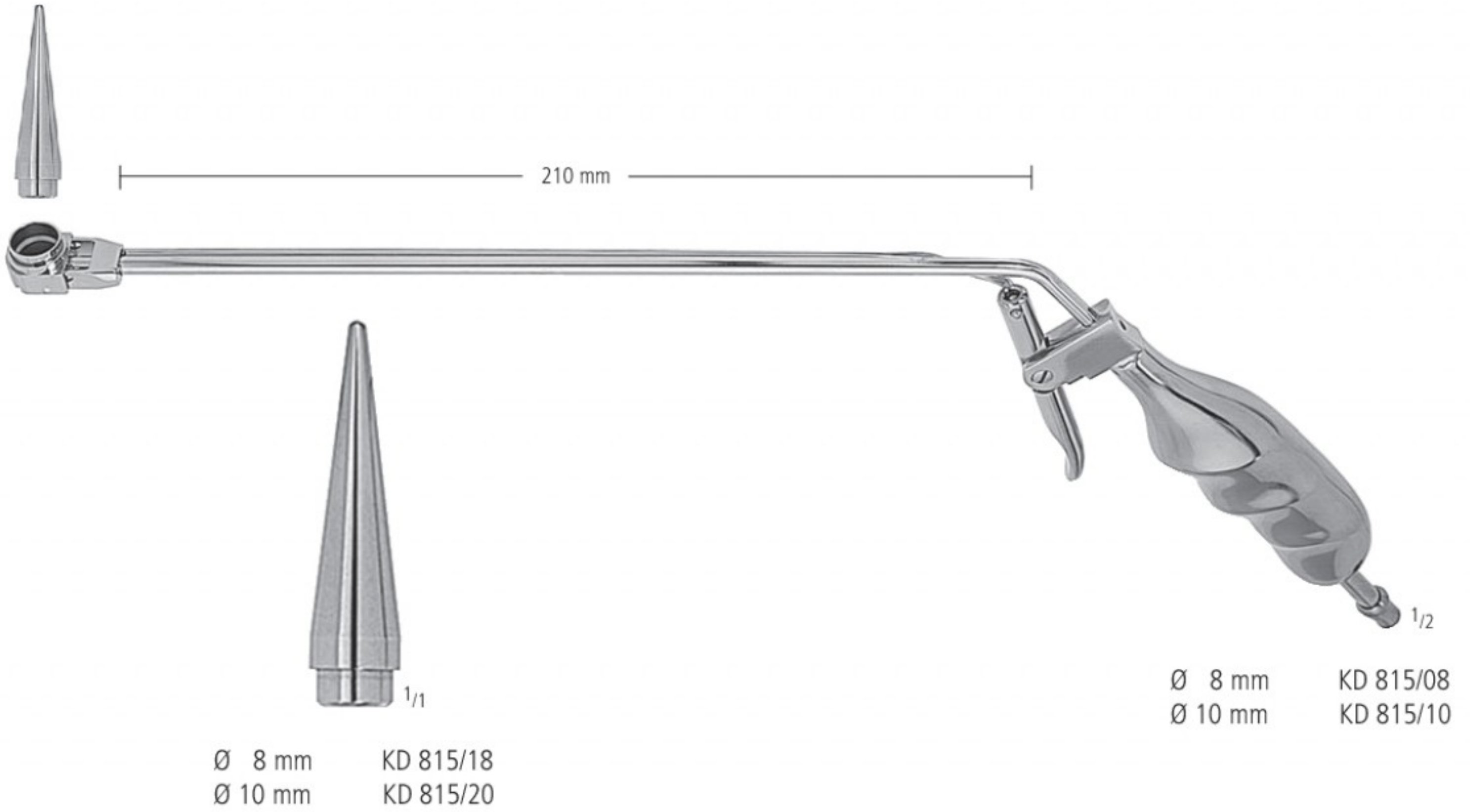

MASTDARM RECTUM RECTO RECTUM RETTO

Hämorrhoidal-Ligatoren
 Haemorrhoidal Ligators
 Ligadores hemorroides
 Ligateurs hémorroïdes
 Legatori emorroidali



1/1

KD 817/00

Ligatur-Gummiringe, 100 Stück
 O-rings, 100 pieces
 Anillos ligadura, 100 piezas
 Anneaux de caoutchouc, 100 pièces
 Anelli per legature, 100 pezzi



1/1

KD 818/01
 Ø 10 mm

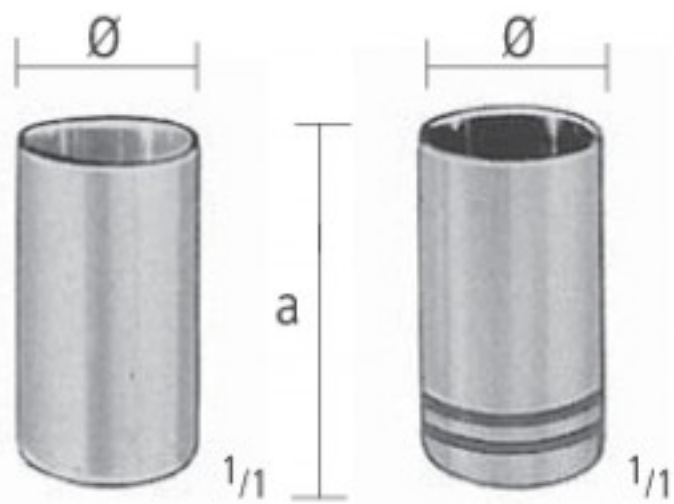

KD 818/11
 Ø 10 mm
 a = 11 mm

KD 818/16
 Ø 10 mm
 a = 16 mm



1/1

KD 820/01
 Ø 12 mm



KD 818/00 =
 mit
 with
 con
 avec
 con
KD 818/01 + KD 818/11

1/2



1/2

MC GIVNEY
KD 820/19
 19,0 cm/7 1/2"

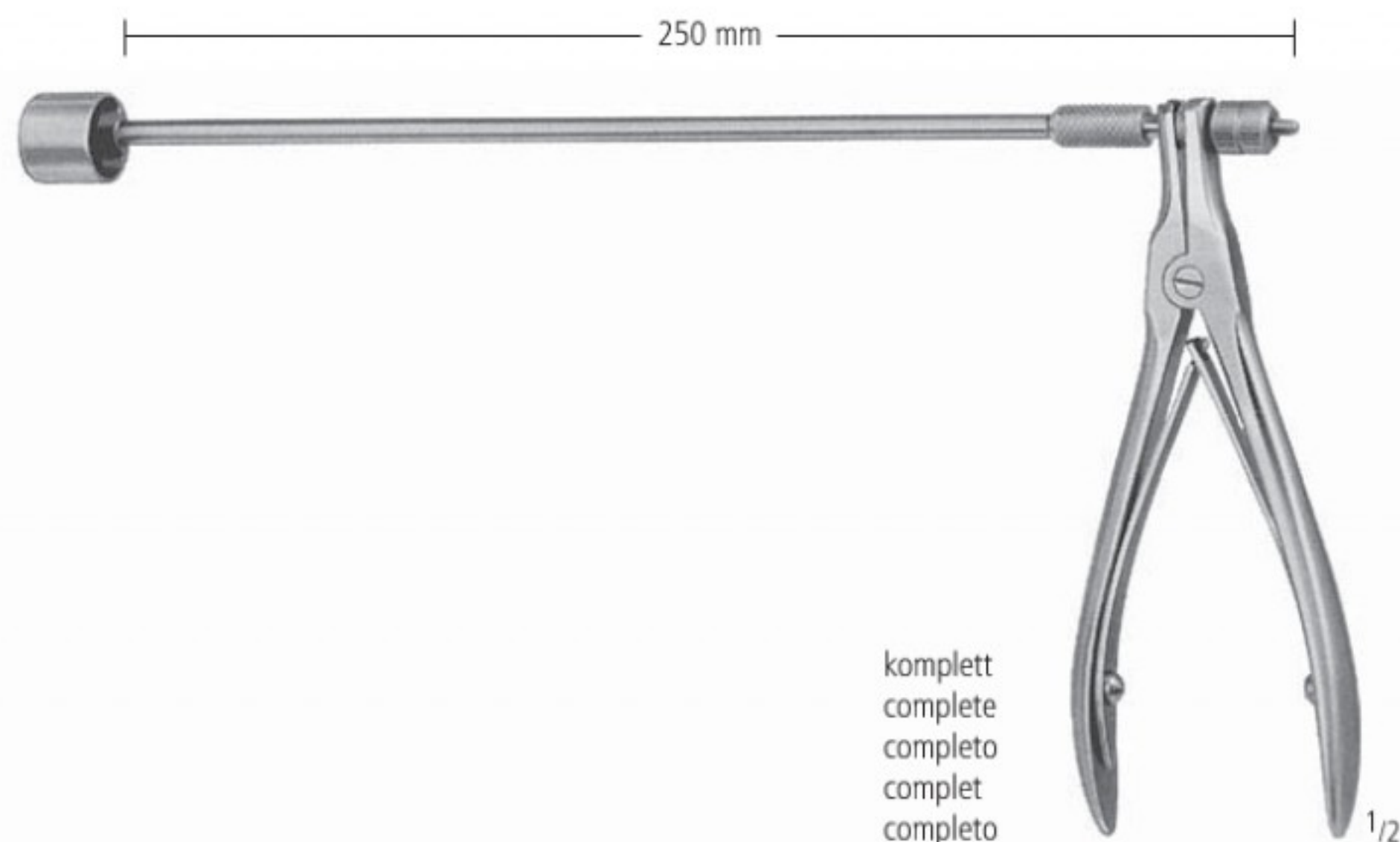

komplett
 complete
 completo
 complet
 completo

1/2

KD 820/00

AA
 AB
 AC
 AD
 AE
 AF
 AK
 AL
 AM
 AO
 AP
 AR
 KA
 KB
 KC
KD
 KU
 KY

KD MASTDARM RECTUM RECTO RECTUM RETTO

Hämorrhoidal-Ligatoren
 Haemorrhoidal Ligators
 Ligadores hemorroides
 Ligateurs hémorroides
 Legatori emorroidali



RUDD
 KD 822/00



KD 822/12