

thorax, herz, gefäße

cardiovascular

cardiovascular
cardiovasculaire
cardiovascolare

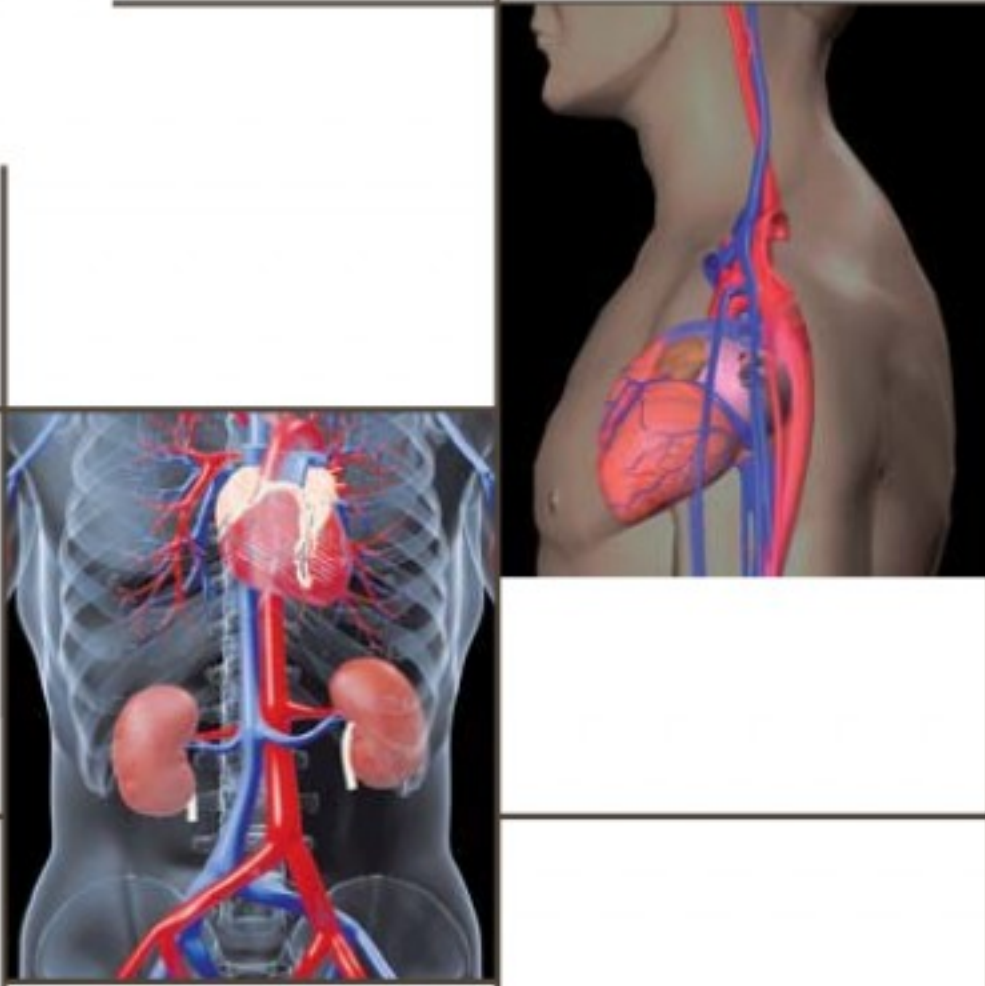

nopa[®] instruments



cardiovascular basic set	>> Cardiovascular • Cardiovascular • Cardiovascular • Cardiovasculaire • Cardiovascolare	9–18
endarterectomy set	>> Endarteriektomie • Endarterectomy • Endarterectomía • Endarterectomie • Endarterectomia	19–24
thoracotomy set	>> Thorakotomie • Thoracotomy • Thoracotomía • Thoracotomie • Thoracotomia	25–30
coronary bypass set	>> Koronar Arterien-Bypass • Coronary Bypass • Bypass coronario Pontage aorto-coronarien • Bypass aorto-coronarico	31–34

INDEX INSTRUMENTE INSTRUMENTS INSTRUMENTOS INSTRUMENTS STRUMENTI

>> Klemmen • Hemostats • Pinzas hemostáticas Pinces hémostatiques • Pinze emostatiche	35-68	AA
>> Pinzetten • Forceps • Pinzas • Pinces • Pinze	69-88	AB
>> Scheren • Scissors • Tijeras • Ciseaux • Forbici	89-128	AC
>> Skalpelle • Scalpels • Bisturíes • Bistouris • Bisturi	129-134	AD
>> Naht • Suture • Sutura • Suture • Sutura	135-162	AE
>> Tupferzangen • Sponges Forceps • Pinzas para pólipos Pinces à pansements • Pinze per polipi	163-170	AF
>> Wundhaken • Retractors • Separadores • Ecarteurs • Divaricatori	171-198	AK
>> Gefäßinstrumente und Sonden • Vessel instruments and probes • Instrumental vascular y sondas Instruments vaisseaux et sondes • Strumenti vascolari e sonde	199-210	AL
>> Saugrohre und Kanülen • Suction tubes and cannulae • Tubos de aspiración y canulas Tubes d'aspiration et canules • Tubi d'aspirazione e cannule	211-216	AO
>> Knocheninstrumente • Bone instruments • Instrumentos para huesos Instruments des os • Strumenti per ossa	217-232	KA
>> Herz/Thorax • Cardiovascular • Cardiovascular • Cardiovasculaire • Cardiovascolare	233-300	KK
>> Endoskopie • Endoscopy • Endoscopia • Endoscopie • Endoscopia	301-344	X



KYE

- >> Bitte fordern Sie unseren Spezialkatalog für Sterilisationscontainer an.
- >> Please request for our special catalogue for Sterilization Containers.
- >> Por favor pida por nuestro catálogo especial de contenedores de esterilización.
- >> Nous vous prions de demander notre catalogue spécial des conteneurs de sterilisation.
- >> Chieda prego il nostro catalogo per contenitori di sterilizzazione.



CARDIOVASCULAR BASIC
CARDIOVASCULAR BASIC
CARDIOVASCULAR BASIC
CARDIOVASCULAIRE BASIC
CARDIOVASCOLARE BASIC

SET

ZS 941/10

Siebvorschlag - Suggested instrument set



ZS 941/10

Contents:

Qty

AA 150/12	HALSTED-MOSQUITO FCPS STR 12,5 CM	1
AA 151/12	HALSTED-MOSQUITO FCPS CVD 12,5 CM	6
AA 180/14	CRILE FORCEPS STR 14,0 CM	2
AA 181/14	CRILE FORCEPS CVD 14,0 CM	12
AA 201/20	ROCHESTER-PEAN FCPS CVD 20,0 CM	1
AA 210/16	OCHSNER-KOCHER ART. FCPS STR 16,0 CM	10
AA 239/18	ADSON FORCEPS CVD 18,5 CM	3
AA 300/16	ROCHESTER-CARMALT FCPS STR 16,0 CM	10
AA 320/02	HEISS FORCEPS SLIGHTLY CVD 20,0 CM	10
AA 330/24	CRAFOORD ARTERY FORCEPS CVD 24,0 CM	3
AA 345/19	MIXTER FORCEPS CVD 19,0 CM	6
AA 751/08	BACKHAUS TOWEL FORCEPS 8,0 CM	6
AA 751/13	BACKHAUS TOWEL FORCEPS 13,0 CM	6
AB 060/14	STANDARD TISSUE FCPS 1X2 T STR 14,5 CM	2
AB 100/12	ADSON DRESSING FORCEPS 12,0 CM	1
AB 117/09	ADSON-BROWN TISS. FCPS CVD 9X9 T 12,0 CM	2
AB 200/18	POTTS-SMITH DRESSING FORCEPS STR 18,0 CM	3
AB 480/15	RUSS.MODEL TISSUE FCPS 15,0 CM	2
AB 480/20	RUSS.MODEL TISSUE FCPS 20,0 CM	2
AB 862/20	DE BAKEY ATRAUMA FCPS STR 2,0 MM 20,0 CM	4
AB 862/24	DE BAKEY FCPS STR 2,0 MM 24,0 CM	2
AC 072/17	MAYO-STILLE OPER. SCS STR BL/BL 17,0 CM	2
AC 073/17	MAYO-STILLE OPER. SCS CVD BL/BL 17,0 CM	2
AC 087/18	KELLY FISTULA SCISSORS CURVED 18,0 CM	1
AC 111/18	METZENBAUM-NELSON SCS CVD BL/BL 18,0 CM	1
AC 111/20	METZENBAUM-NELSON SCS CVD BL/BL 20,0 CM	1
AC 219/25	POTTS-SMITH ART. SCS 25 DEGREE 19,0 CM	1
AC 219/45	POTTS-SMITH ART. SCS 45 DEGREE 19,0 CM	1
AC 941/20	METZENBAUM SCS TUC CVD BL/BL 20,0 CM	1
AC 987/12	UNIVERSAL WIRE SHEARS TUC 12,0 CM	2
AD 010/03	SCALPEL HANDLE NO. 3	6
AD 020/13	SCALPEL HANDLE NO. 3 L	6
AE 100/16	MAYO-HEGAR NEEDLE HOLDER 16,0 CM	3
AE 100/18	MAYO-HEGAR NEEDLE HOLDER 18,0 CM	5
AE 100/20	MAYO-HEGAR NEEDLE HOLDER 20,0 CM	3
AF 200/25	FOERSTER-BALLENGER STR SERRATED 25,0 CM	8
AK 036/01	CUSHING DELICATE HOOK FIG.1 19,0 CM	2
AK 102/10	CUSHING RETRACTOR 10 MM 24,0 CM	2
AK 122/16	SENN-MILLER RETRACTOR SHARP 16,0 CM	4
AK 150/04	VOLKMANN RETR.SHARP 4 PRONGS 21,5 CM	4
AK 245/17	MIDDELDORPF RETRACTOR 14X17 MM 21,5 CM	2
AK 247/01	RICHARDSON RETRACTOR 28X20 MM 24,0 CM	2
AK 247/02	RICHARDSON RETRACTOR 36X28 MM 24,0 CM	2
AK 247/03	RICHARDSON RETRACTOR 44X38 MM 24,0 CM	2
AK 247/04	RICHARDSON RETRACTOR 52X22 MM 24,0 CM	2
AK 300/04	DEAVER RETRACTOR WIDTH 25 MM 30,0 CM	2
AK 300/08	DEAVER RETRACTOR WIDTH 50 MM 30,0 CM	1
AK 300/09	DEAVER RETRACTOR WIDTH 75 MM 30,0 CM	2
AK 374/00	PARKER RETRACTOR SET LARGE FIG.1+2	1
AK 384/00	PARKER-LANGENBECK US-ARMY SET FIG.1+2	1
AK 520/13	WEITLANER RETRACTOR SHARP 13,0 CM	2
AK 580/19	GELPI RETRACTOR 19,0 CM	2
AK 804/30	ABDOMINAL SPATULA 33,0 CM	1
AK 804/40	ABDOMINAL SPATULA 33,0 CM	1
AK 804/50	ABDOMINAL SPATULA 33,0 CM	1

ZS 941/10	Contents:	Qty
AO 400/00	YANKAUER SUCTION TUBE COMPLETE	2
AO 404/00	WALTON-YANKAUER SUCTION TUBE	2
AO 421/22	POOLE SUCTION TUBE CURVED 8 MM 22,0 CM	1
AO 430/10	FRAZIER BRAIN SUCTION TUBE CHARR10/17,00 CM	1
KA 520/40	WILLIGER MALLETS 400G 30 MM DIAM.	1
KD 055/15	ALLIS FCPS 5x6T 15,0 CM	6
KD 055/19	ALLIS TISSUE FCPS 5X6 T 19,0 CM	3
KD 060/15	ALLIS-ADAIR TIS. SEIZ. FCPS 10X11 15,0 CM	4
KD 111/16	BABCOCK INT. TISSUE FCPS 16,0 CM	4
KK 040/25	LEBSCHKE CHISEL 25,0 CM	1
KYE 301/07	WIRE BASKET, 540 X 255 X 70 MM	2

Sterilization Container KYE 200/71, if required.

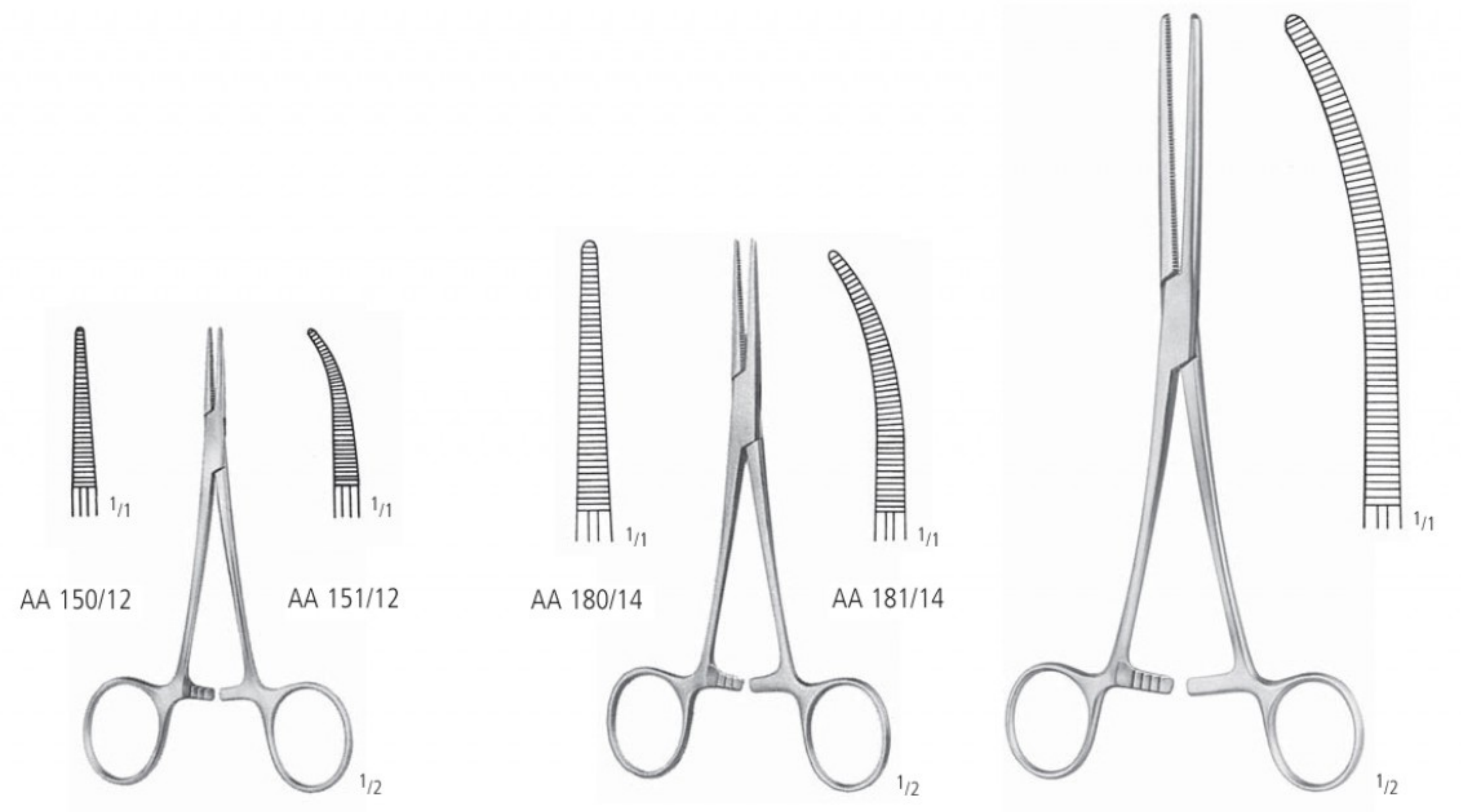

HALSTED-MOSQUITO
12,5 cm/5"

CRILE
14,0 cm/5 1/2"

ROCHESTER-PEAN
AA 201/20
20,0 cm/8"



OCHSNER-KOCHER 1:2
AA 210/16
16,0 cm/6 1/4"

ADSON
AA 239/18
18,5 cm/7 1/3"

ROCHESTER-CARMALT
AA 300/16
16,0 cm/6 1/4"

HEISS
AA 320/02
20,0 cm/8"

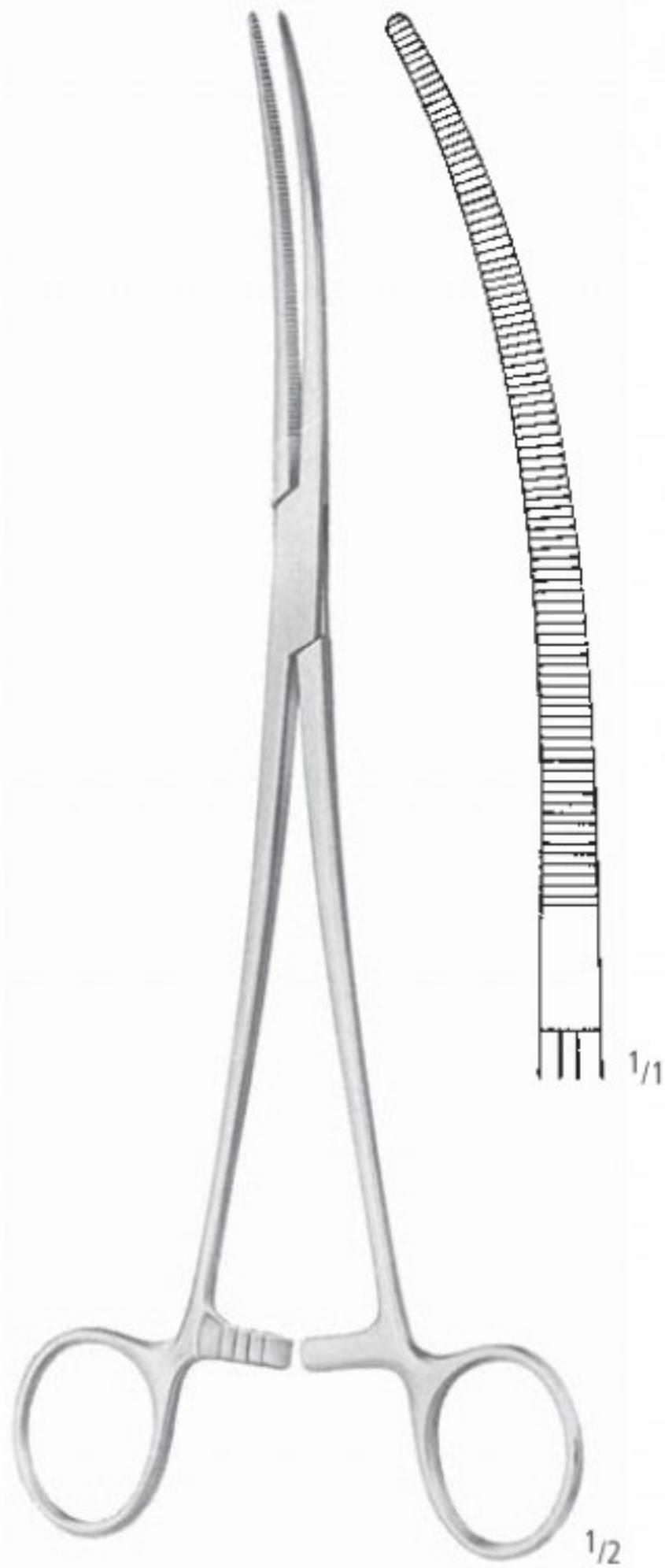

CRAFOORD
AA 330/24
24,0 cm/9¹/₂"



MIXTER
AA 345/19
19,0 cm/7¹/₂"

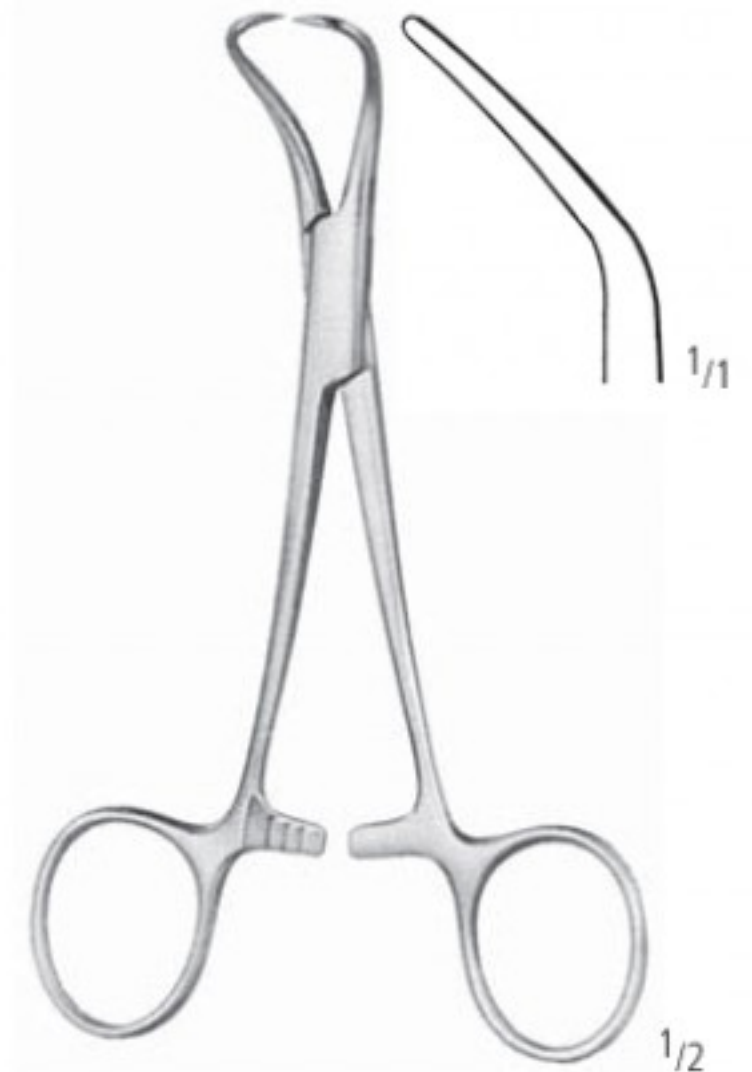

BACKHAUS
8,0 cm/3"
13,0 cm/5"
AA 751/08
AA 751/13



STANDARD 1:2
AB 060/14
14,5 cm/5³/₄"



ADSON
AB 100/12
12,0 cm/4³/₄"



ADSON-BROWN
AB 117/09
12,0 cm/4³/₄"



POTTS-SMITH
AB 200/18
18,0 cm/7"



RUSS. MODELL
15,0 cm/6"
20,0 cm/8"
AB 480/15
AB 480/20



DE BAKAY
20,0 cm/8"
24,0 cm/9¹/₂"
AB 862/20
AB 862/24

Fistelscheren
Fistula Scissors
Tijeras para fistulas
Ciseaux pour fistules
Forbici per fistole

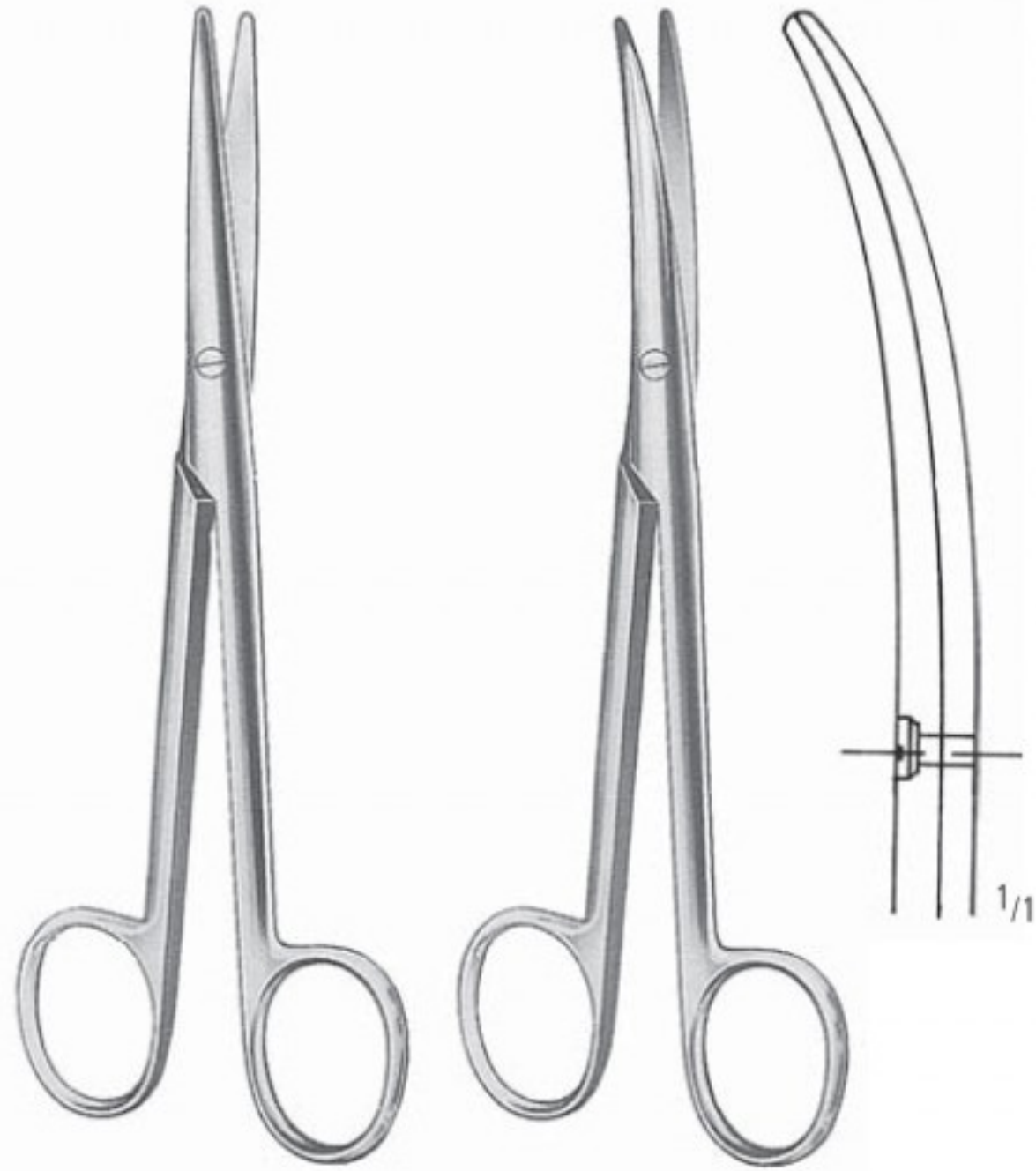

MAYO-STILLE
AC 072/17
17,0 cm/6¹/₄"

MAYO-STILLE
AC 073/17
17,0 cm/6¹/₄"

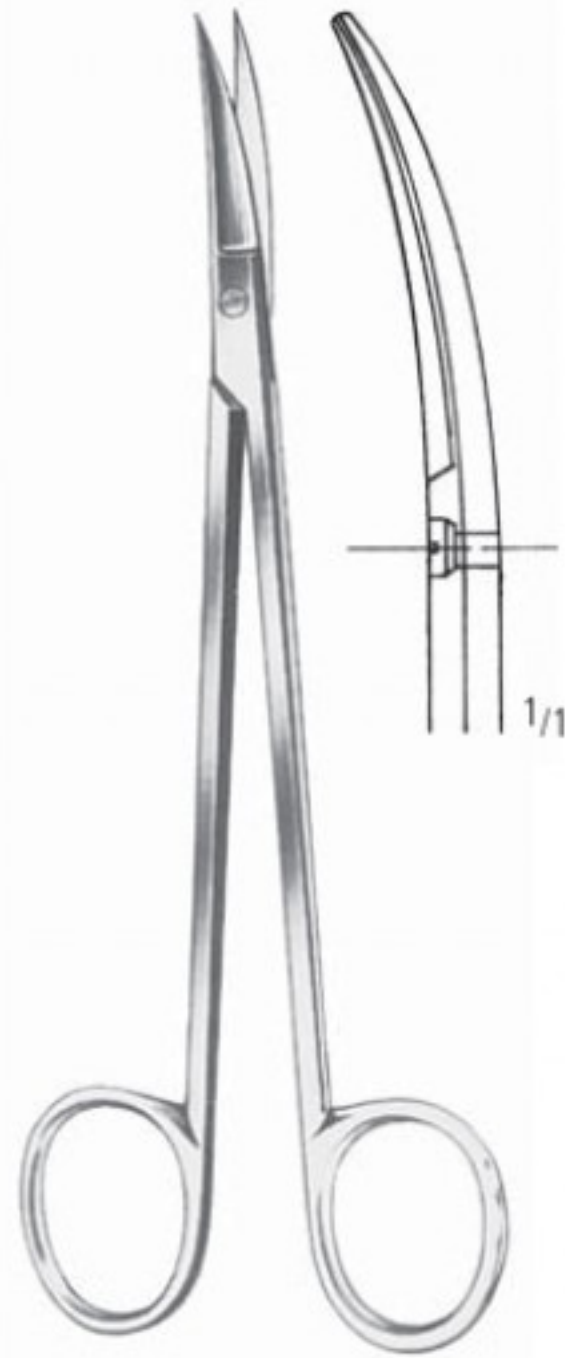

KELLY
AC 087/18
18,0 cm/7"

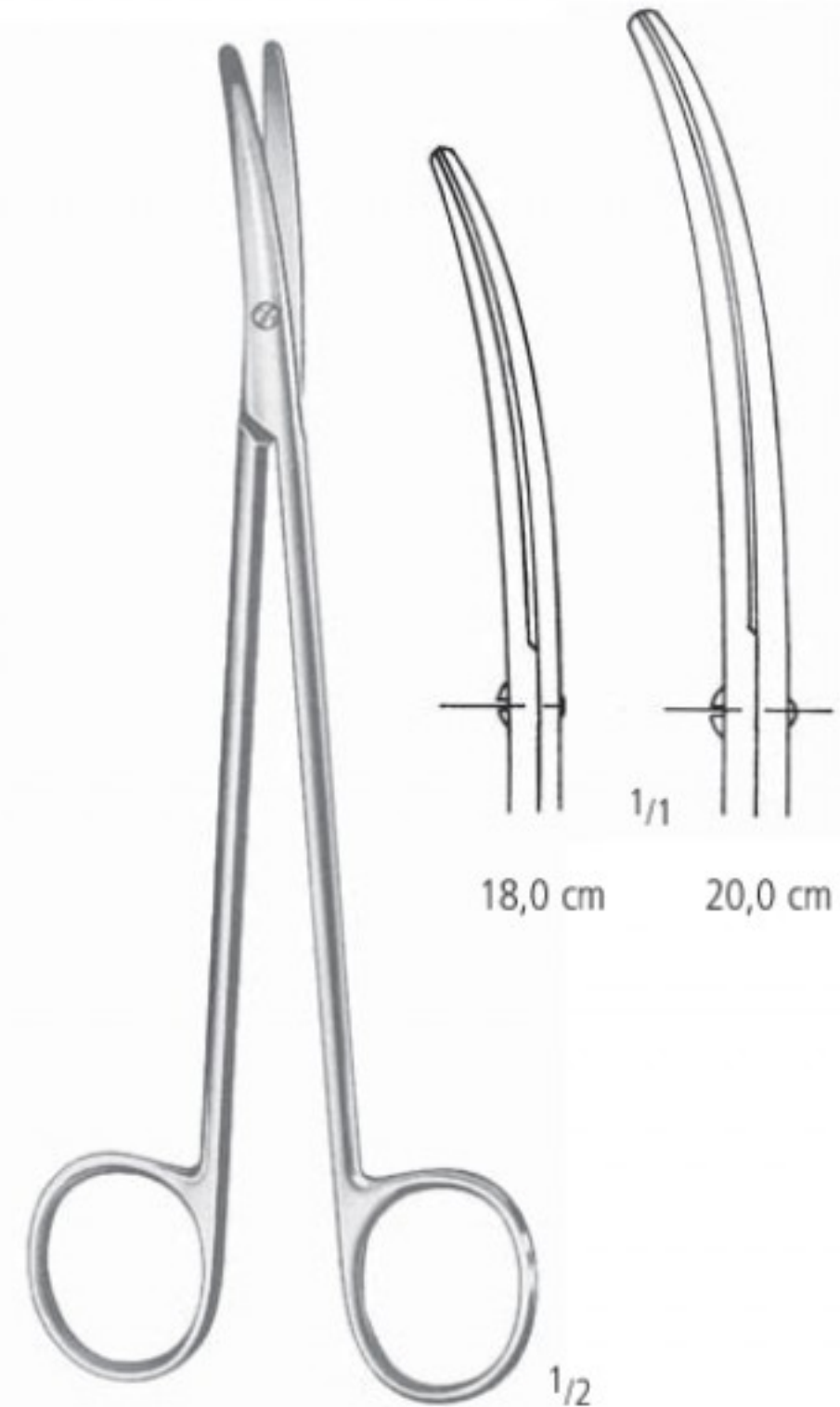

METZENBAUM-NELSON
18,0 cm/7" AC 111/18
20,0 cm/8" AC 111/20

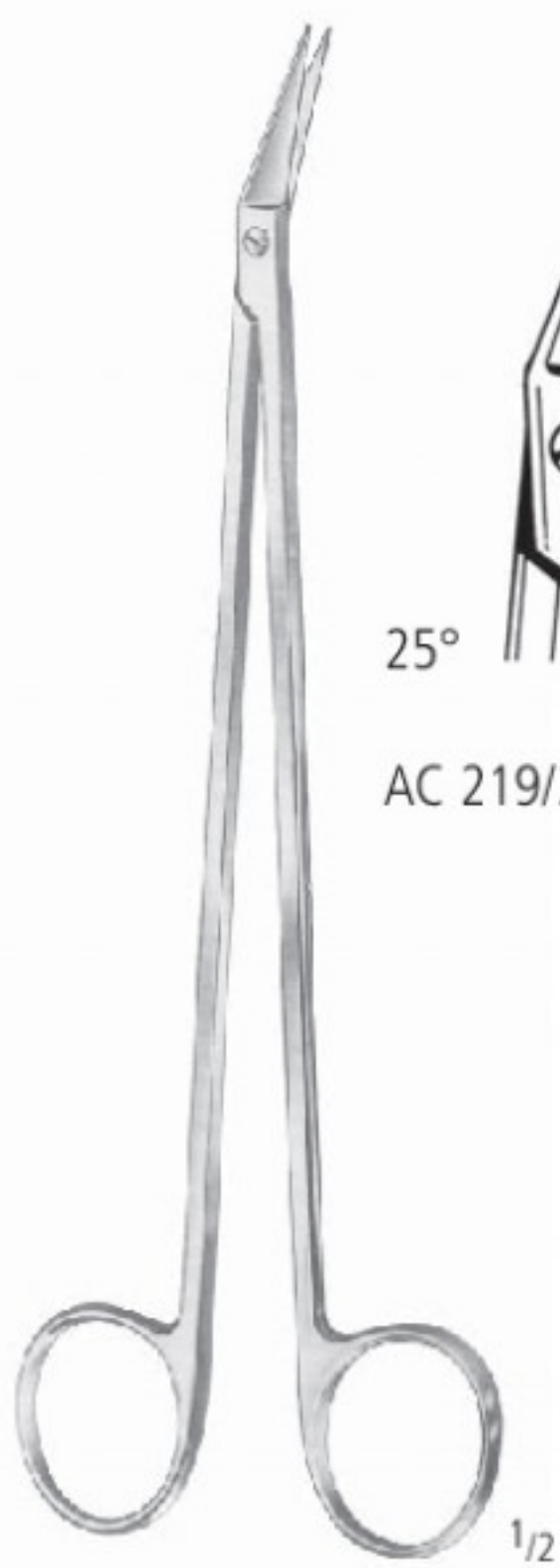

POTTS-SMITH
19,0 cm/7¹/₂"

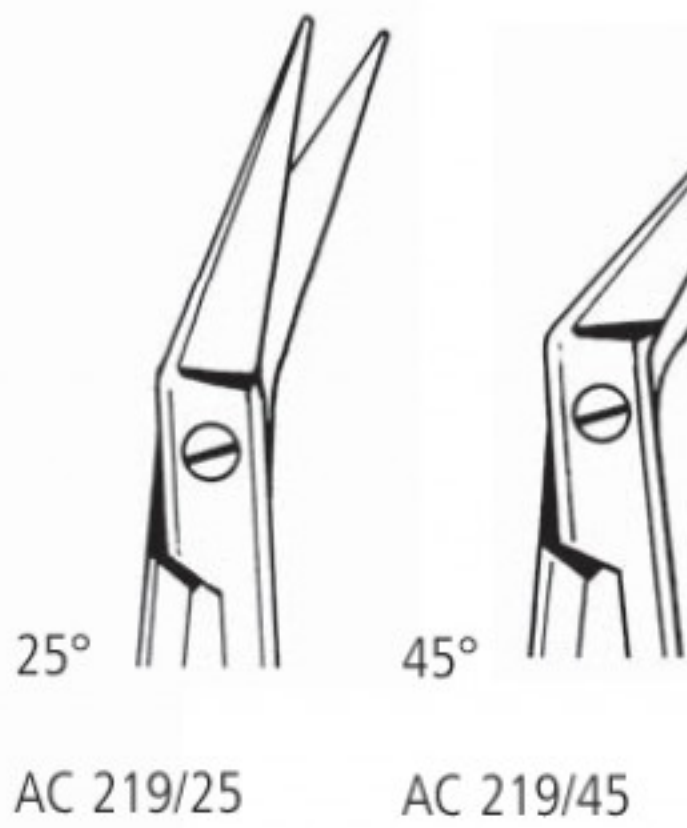

25°
AC 219/25

45°
AC 219/45

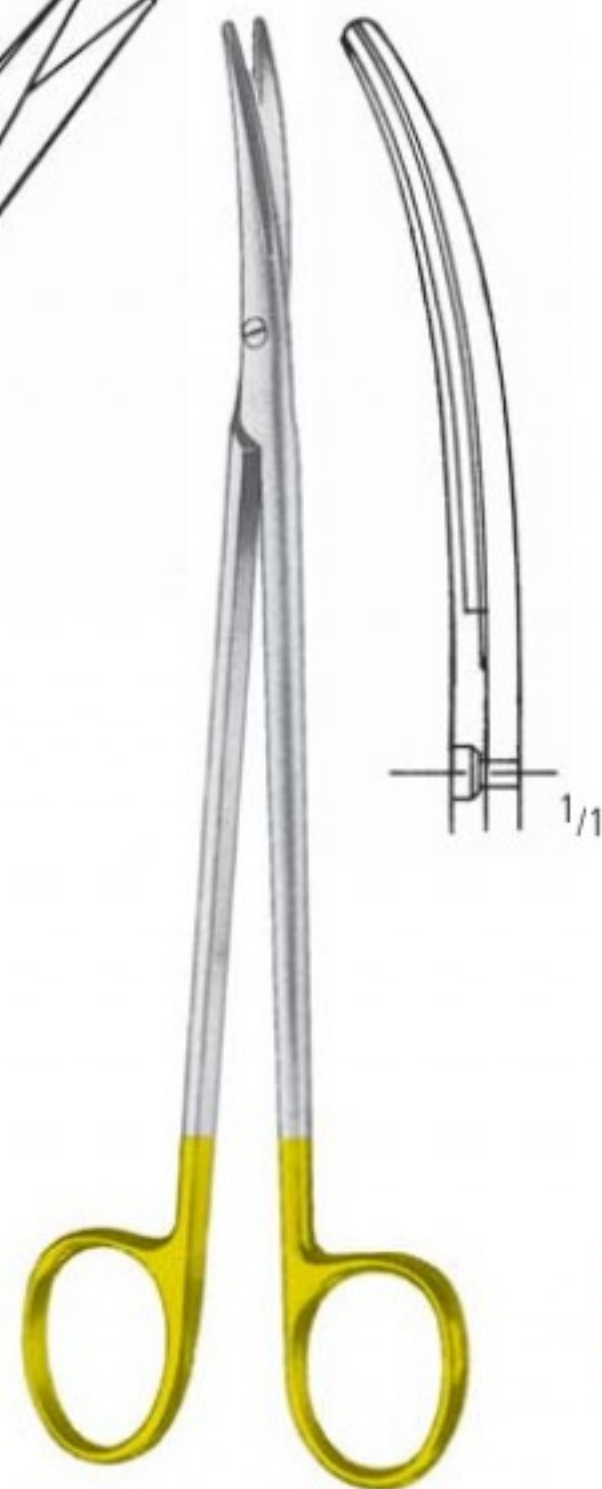

METZENBAUM
AC 941/20 SC
20,0 cm/8"



UNIVERSAL
AC 987/12
12,0 cm/4³/₄"



AD 010/03
No. 3



AD 020/13
No. 3L

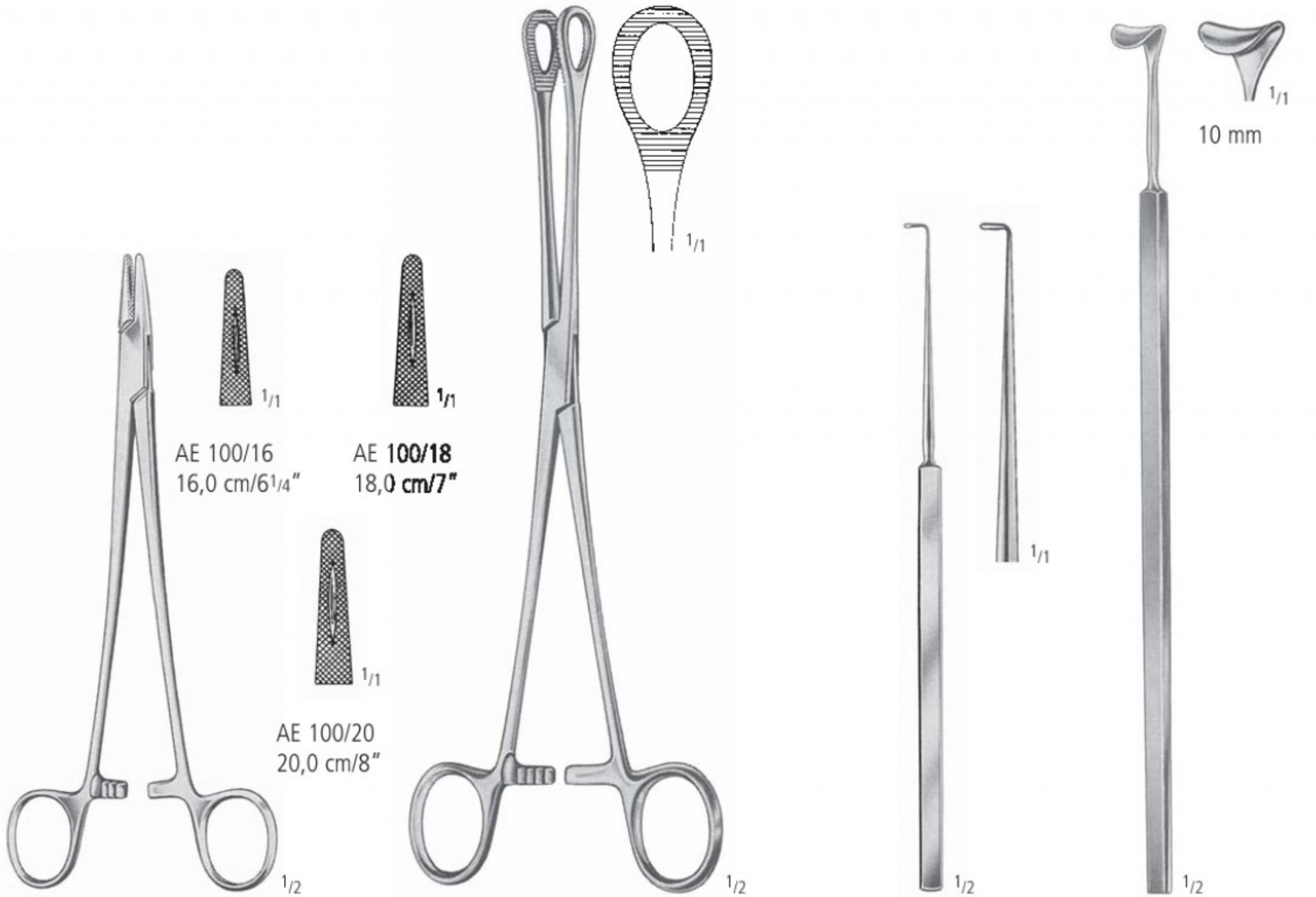

MAYO-HEGAR

FOERSTER-BALLENGER

CUSHING

CUSHING

AF 200/25
25,0 cm/10"

AK 036/01
19,0 cm/7 1/2"

AK 102/10
24,0 cm/9 1/2"

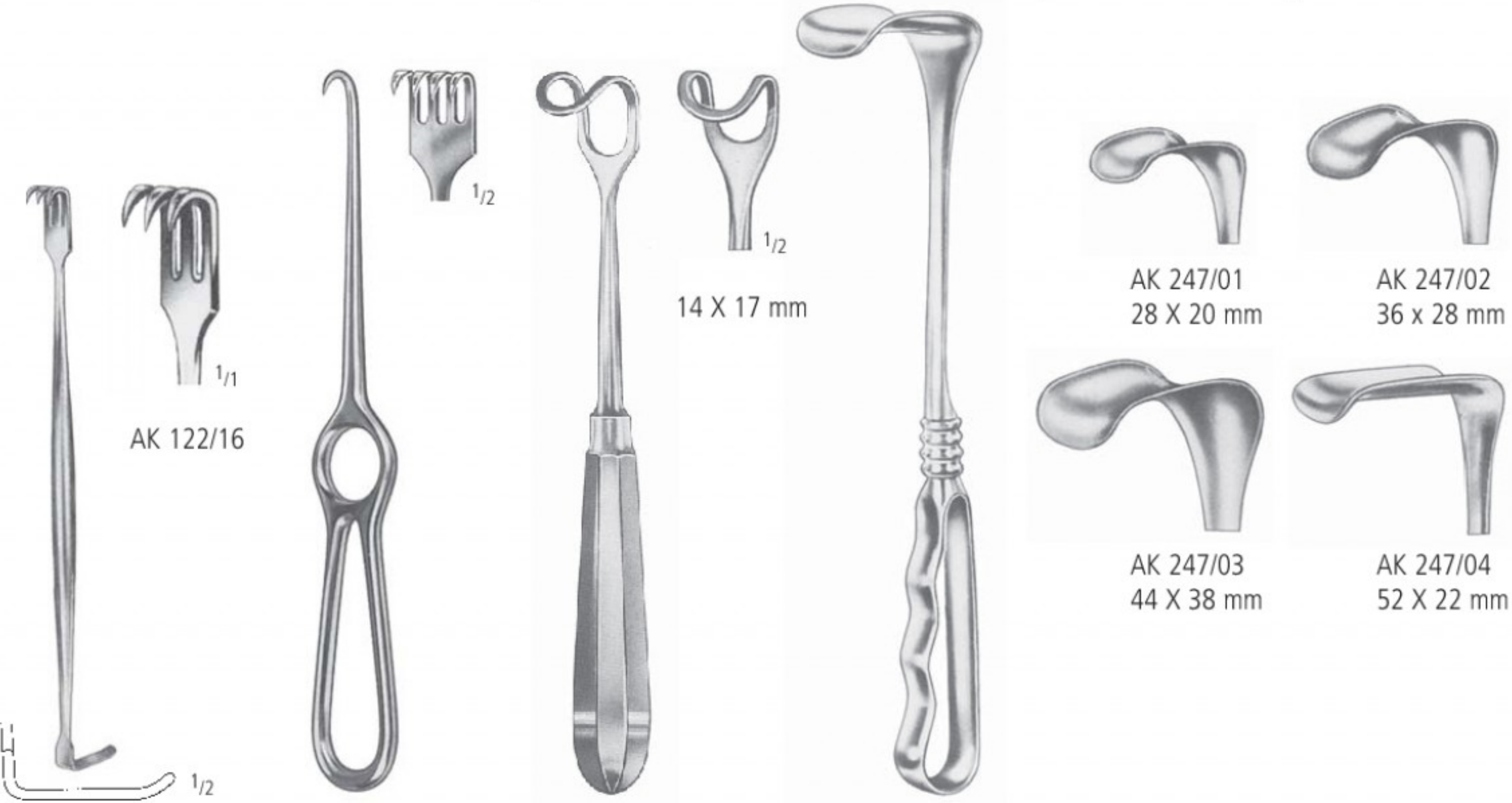

SENN-MILLER

VOLKMANN

MIDDELDORPF

RICHARDSON (KELLY)

AK 122/16
16,0 cm/6 1/4"

AK 150/04
21,5 cm/8 1/2"

AK 245/17
21,5 cm/8 1/2"

24,0 cm/9 1/2"



DEAVER
AK 300/04
30,0 cm/12"



DEAVER
AK 300/08
30,0 cm/12"



DEAVER
AK 300/09
30,0 cm/12"

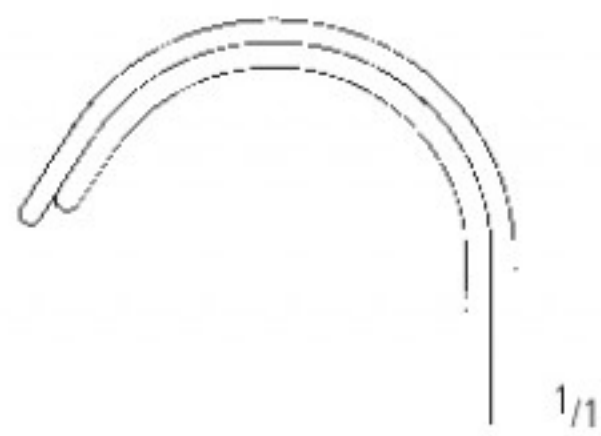

PARKER
AK 374/00 Fig. 1+2
18,0 cm/7"



PARKER-LANGENBECK (U.S. Army)
AK 384/00 Fig. 1+2
21,0 cm/8 1/4"





WEITLANER
13,0 cm/5" AK 520/13



GELPI
AK 580/19
19,0 cm/7 1/2"



biegsam
malleable
maleables
malléables
malleabili

33,0 cm/13"
30 mm AK 804/30
40 mm AK 804/40
50 mm AK 804/50



YANKAUER
AO 400/00
27,0 cm/11"

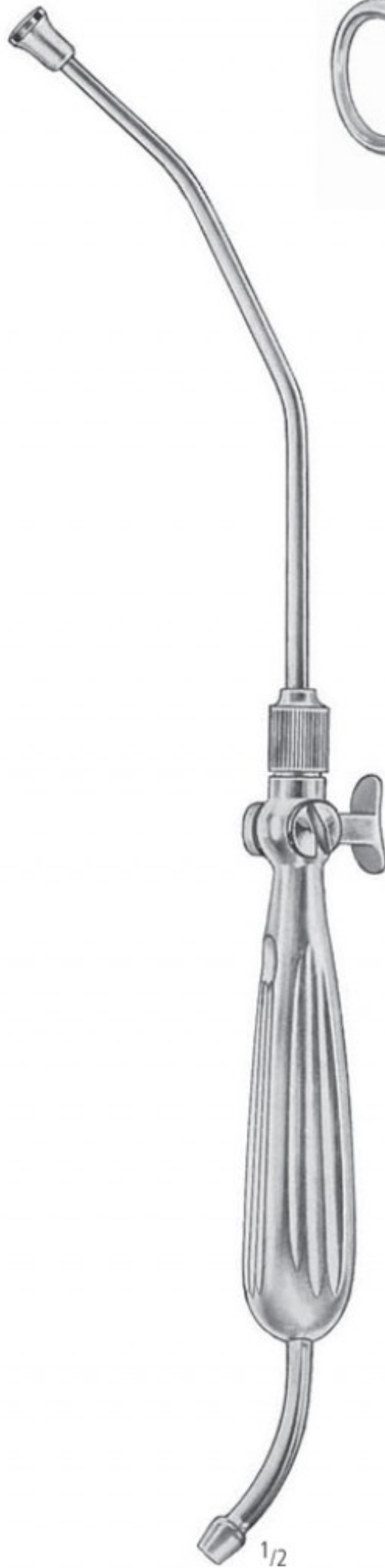

WALTON-YANKAUER
AO 404/00
32,5 cm/13"



POOLE
AO 421/22
8,0 mm



FRAZIER
10 Charr. AO 430/10

cardiovascular basic

endarterectomy

thoracotomy

coronary bypass



KA 520/40
Ø 30 mm
400 g (14¹/₄ oz.)

1/2

WILLIGER
24,0 cm/9¹/₂"



1/2

ALLIS 5:6
15,0 cm/6" KD 055/15
19,0 cm/7¹/₂" KD 055/19



1/2

ALLIS-ADAIR 10:11
KD 060/15
15,0 cm/6"

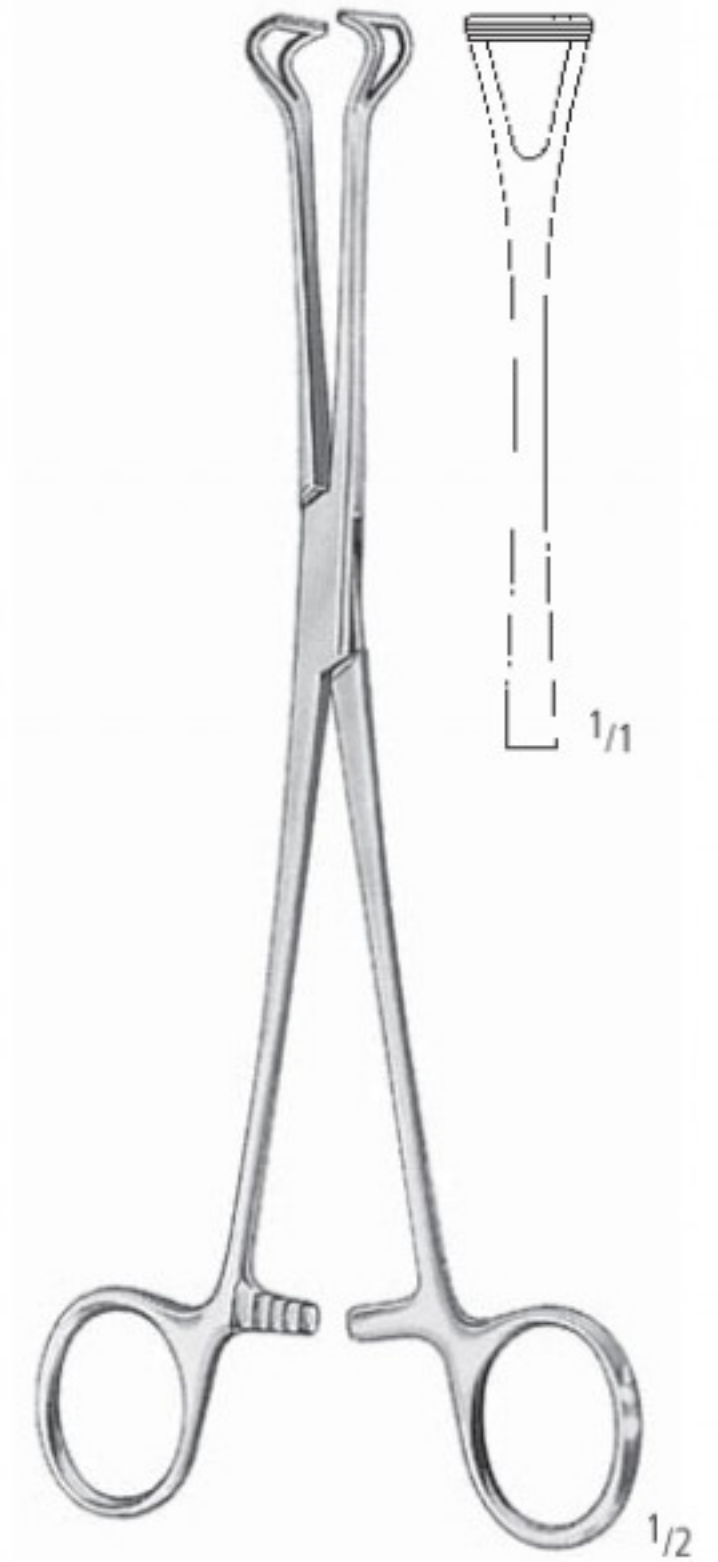

1/2

BABCOCK
KD 111/16
16,0 cm/6¹/₄"



1/3

LEBSCHE
KK 040/25
25,0 cm/10"



L(mm)	B(mm)	H(mm)	
540	255	70	KYE 301/07

ENDARTERIEKTOMIE
ENDARTERECTOMY
ENDARTERECTOMIA
ENDARTERECTOMIE
ENDATERECTOMIA

SET

ZS 941/70

Siebvorschlag - Suggested instrument set



ZS 941/70	Contents:	Qty
AA 151/12	HALSTED-MOSQUITO FCPS CVD 12,5 CM	12
AA 181/14	CRILE FORCEPS CURVED 14,0 CM	12
AA 201/16	ROCHESTER-PEAN FCPS CVD 16,0 CM	6
AA 348/18	BABY-MIXTER ART. FCPS CVD 18,0 CM	2
AA 751/13	BACKHAUS TOWEL FORCEPS 13,0 CM	6
AB 050/14	STANDARD DRESSING FORCEPS STR 14,5 CM	2
AB 060/14	STANDARD TISSUE FCPS. 1X2 TEETH STR 14,5 CM	2
AB 100/12	ADSON DRESSING FORCEPS 12,0 CM	2
AB 110/12	ADSON TISSUE FCPS 1X2 TEETH 12,0 CM	2
AC 072/17	MAYO-STILLE OPER. SCS STR BL/BL 17,0 CM	1
AC 073/17	MAYO-STILLE OPER. SCS CVD BL/BL 17,0 CM	1
AC 111/18	METZENBAUM-NELSON SCS CVD BL/BL 18,0 CM	1
AC 219/45	POTTS-SMITH ART. SCS 45 DEGREE 19,0 CM	1
AC 450/11	IRIS SCISSORS STR SH/SH 11,5 CM	1
AC 451/11	IRIS SCISSORS CVD SH/SH 11,5 CM	1
AD 010/03	SCALPEL HANDLE NO. 3	1
AE 070/15	CRILE-WOOD NEEDLE HOLDER 15,0 CM	2
AF 200/25	FOERSTER-BALLENGER STR SERRATED 25,0 CM	4
AK 036/01	CUSHING DELICATE HOOK FIG.1 19,0 CM	2
AK 245/22	MIDDELDORPF RETRACTOR 20X22 MM 22,0 CM	2
AK 247/01	RICHARDSON RETRACTOR 28X20 MM 24,0 CM	2
AK 384/00	PARKER-LANGENBECK US-ARMY SET FIG.1+2	1
AL 003/13	PROBE W. EYE 13,0 CM 2 MM	2
AO 430/10	FRAZIER BRAIN SUCTION TUBE CHARR10/17,0 CM	2
KD 055/15	ALLIS FCPS 5X6 T 15,0 CM	4
KK 371/06	GLOVER ATRAUMA-BULLDOG CLAMP CVD 5,5 CM	2
KK 371/07	GLOVER ATRAUMA-BULLDOG CLAMP CVD 6,5 CM	2
KK 371/09	GLOVER ATRAUMA-BULLDOG CLAMP CVD 8,5 CM	2
KS 638/01	PENFIELD DURA DISSECTORS FIG.1 17,5 CM	1
KYE 301/07	WIRE BASKET, 540 X 255 X 70 MM	1

Sterilization Container KYE 200/51, if required.



HALSTED-MOSQUITO
AA 151/12
12,5 cm/5"

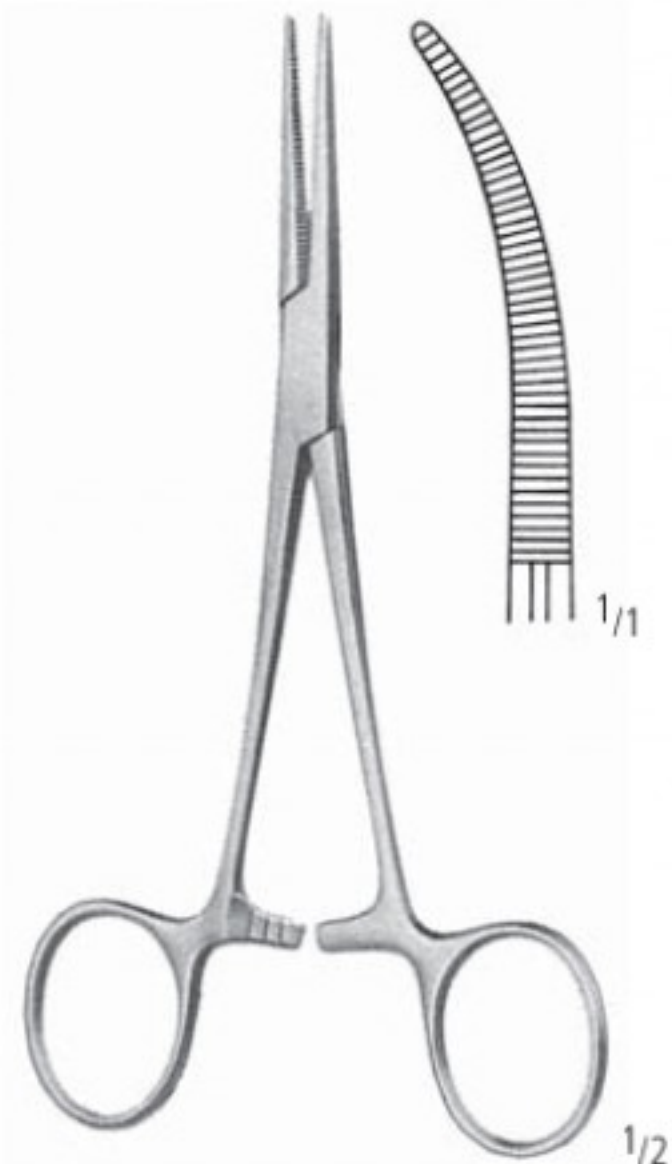

CRILE
AA 181/14
14,0 cm/5 1/2"

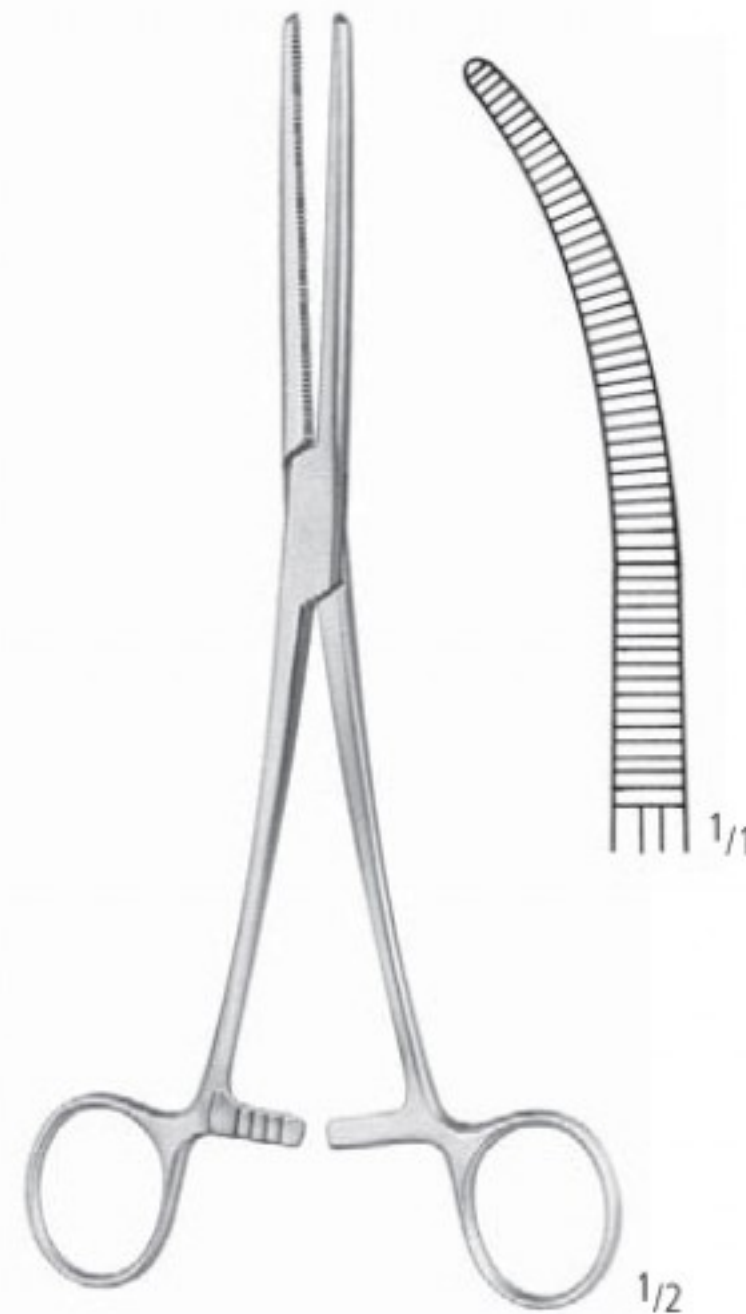

ROCHESTER-PEAN
AA 201/16
16,0 cm/6 1/4"

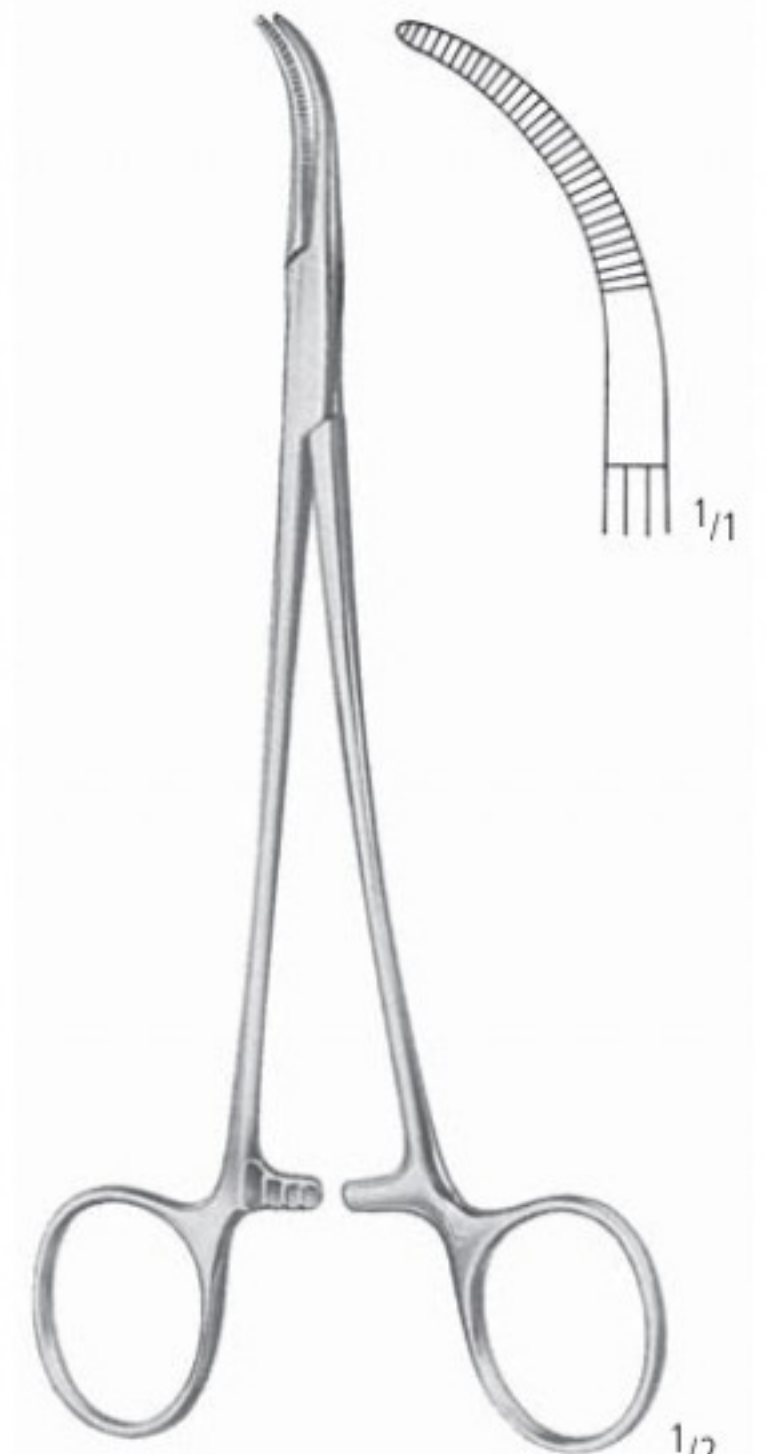

BABY-MIXTER
AA 348/18
18,0 cm/7"

cardiovascular basic

endarterectomy

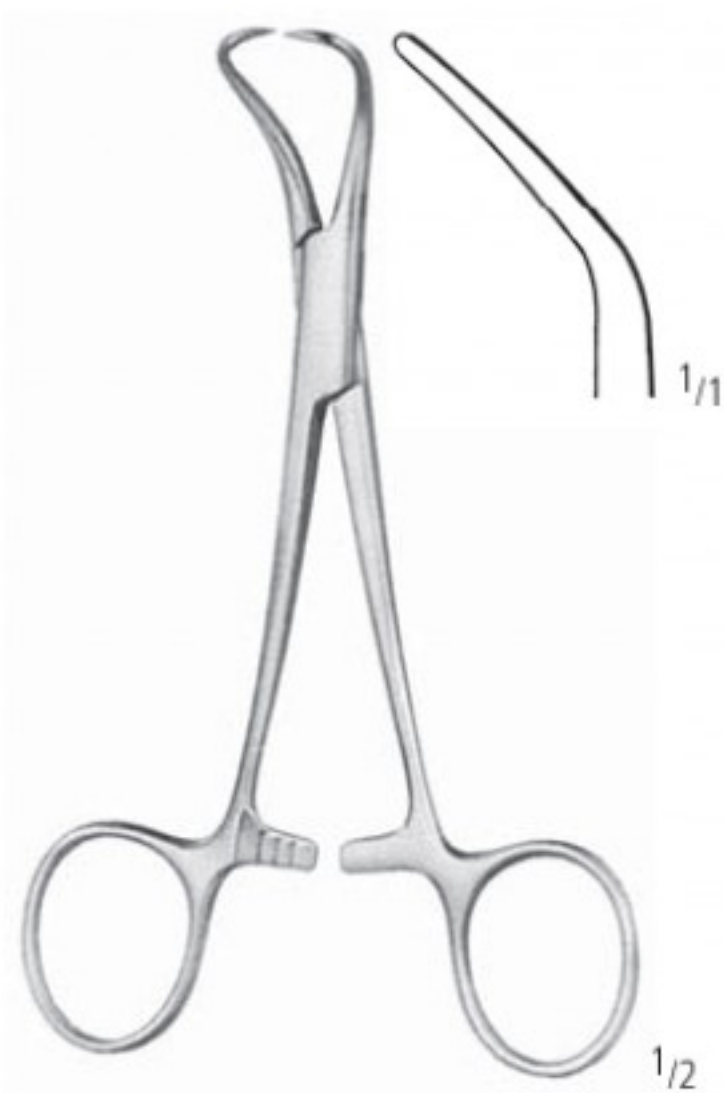

BACKHAUS
AA 751/13
13,0 cm/5"



STANDARD
AB 050/14
14,0 cm/5 1/2"



STANDARD 1:2
AB 060/14
14,5 cm/5 3/4"



ADSON
AB 100/12
12,0 cm/4 3/4"

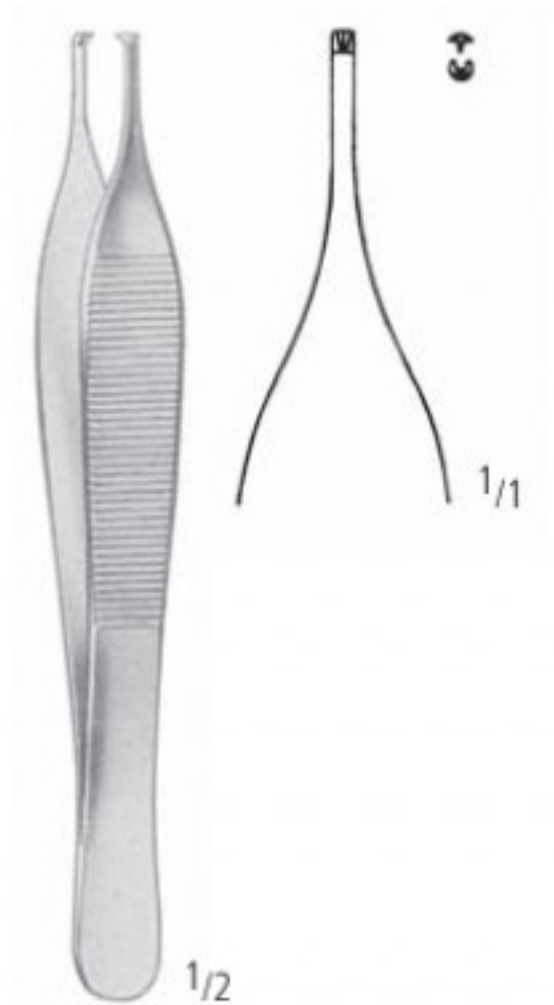

ADSON 1:2
AB 110/12
12,0 cm/4 3/4"

thoracotomy

coronary bypass



MAYO-STILLE
AC 072/17
17,0 cm/6¹/₄"

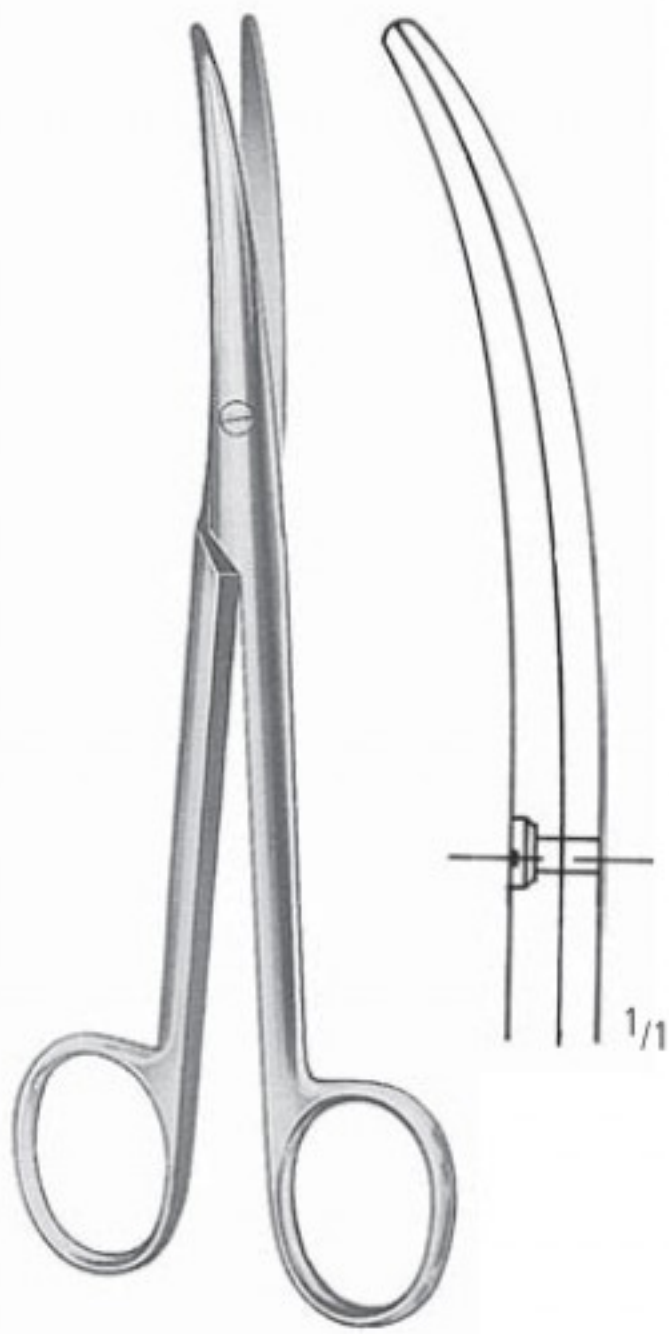

MAYO-STILLE
AC 073/17
17,0 cm/6¹/₄"

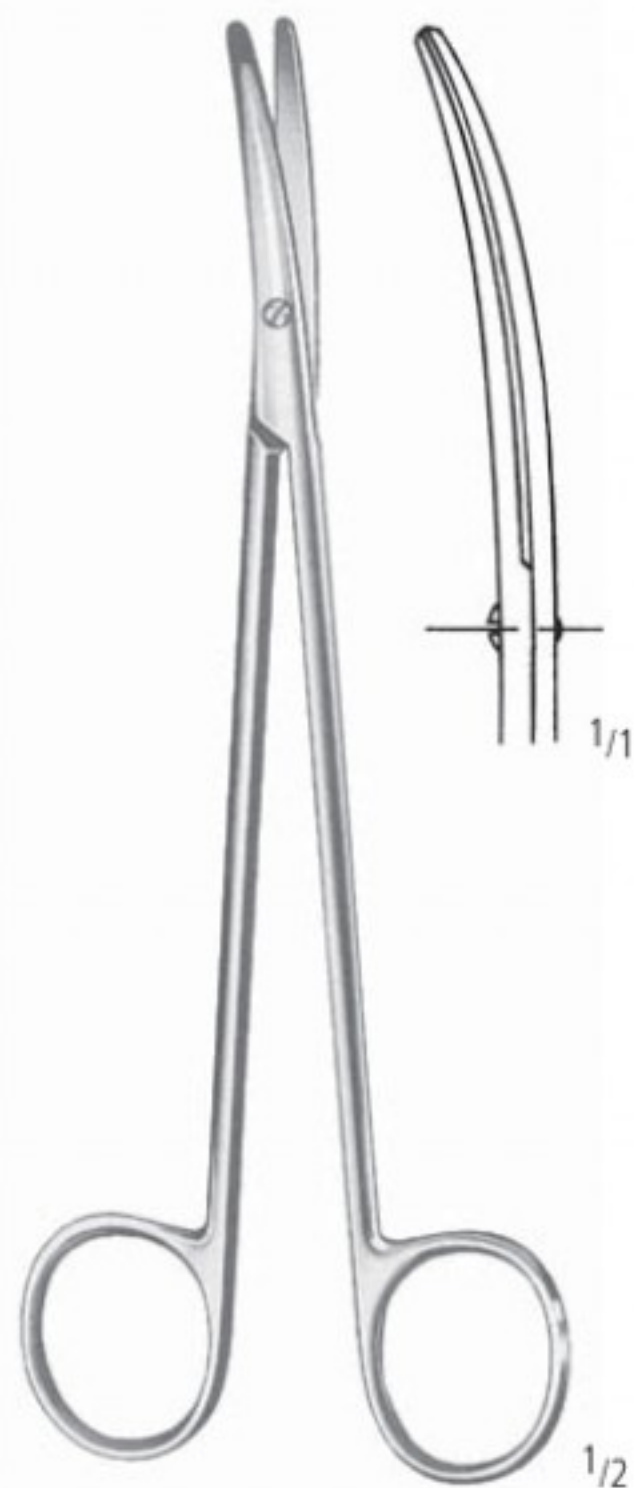

METZENBAUM-NELSON
AC 111/18
18,0 cm/7"

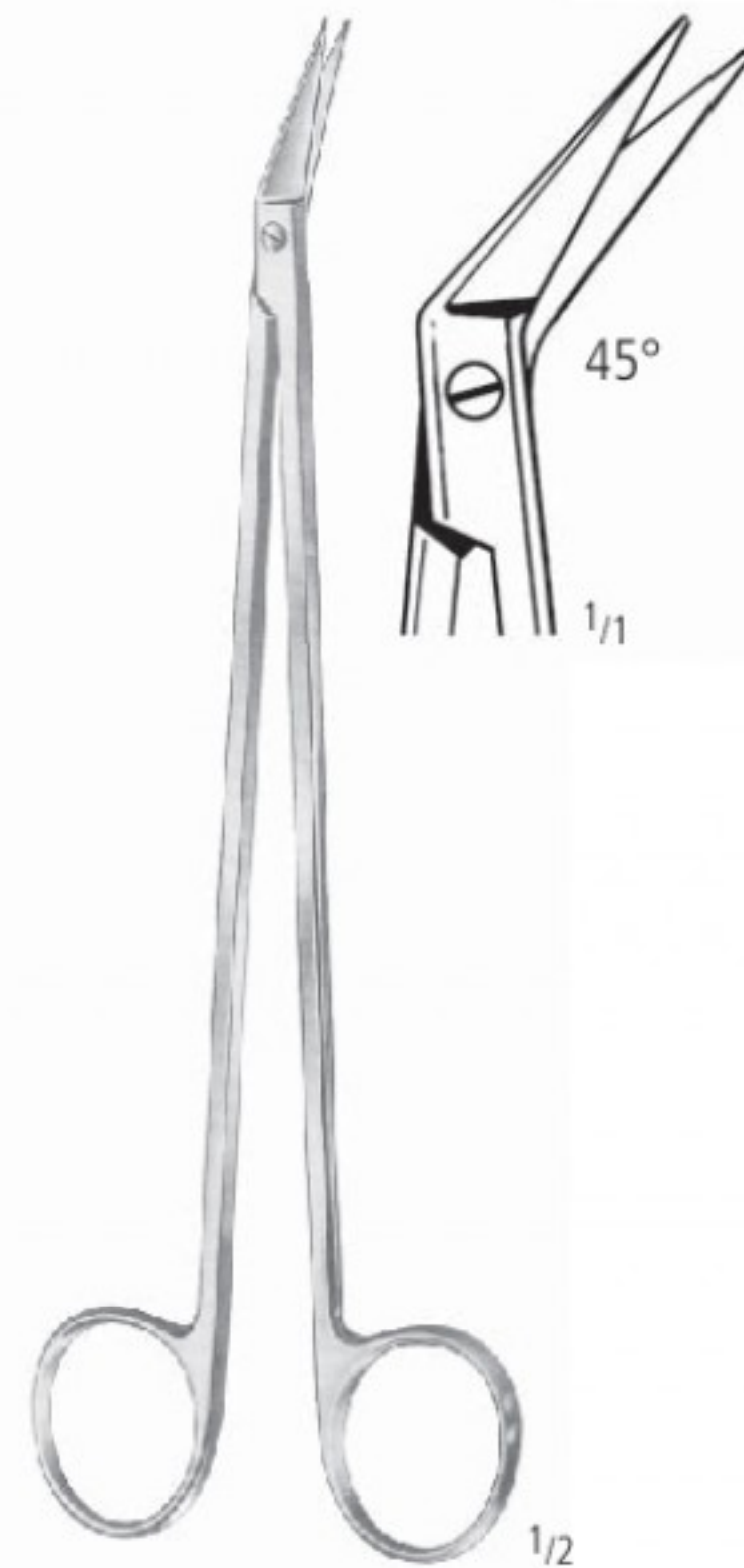

POTTS-SMITH
AC 219/45
19,0 cm/7¹/₂"

Irisscheren
Iris Scissors
Tijeras para iridectomía
Ciseaux à iridectomie
Forbici per iridectomia



AC 450/11
11,5 cm/4¹/₂"

AC 451/11
11,5 cm/4¹/₂"



AD 010/03
No. 3



CRILE-WOOD
AE 070/15
15,0 cm/6"



FOERSTER-BALLENGER
AF 200/25
25,0 cm/10"



CUSHING
AK 036/01
19,0 cm/7 1/2"



MIDDELDORPF
AK 245/22
22,0 cm/8 3/4"



RICHARDSON (KELLY)
AK 247/01
24,0 cm/9 1/2"

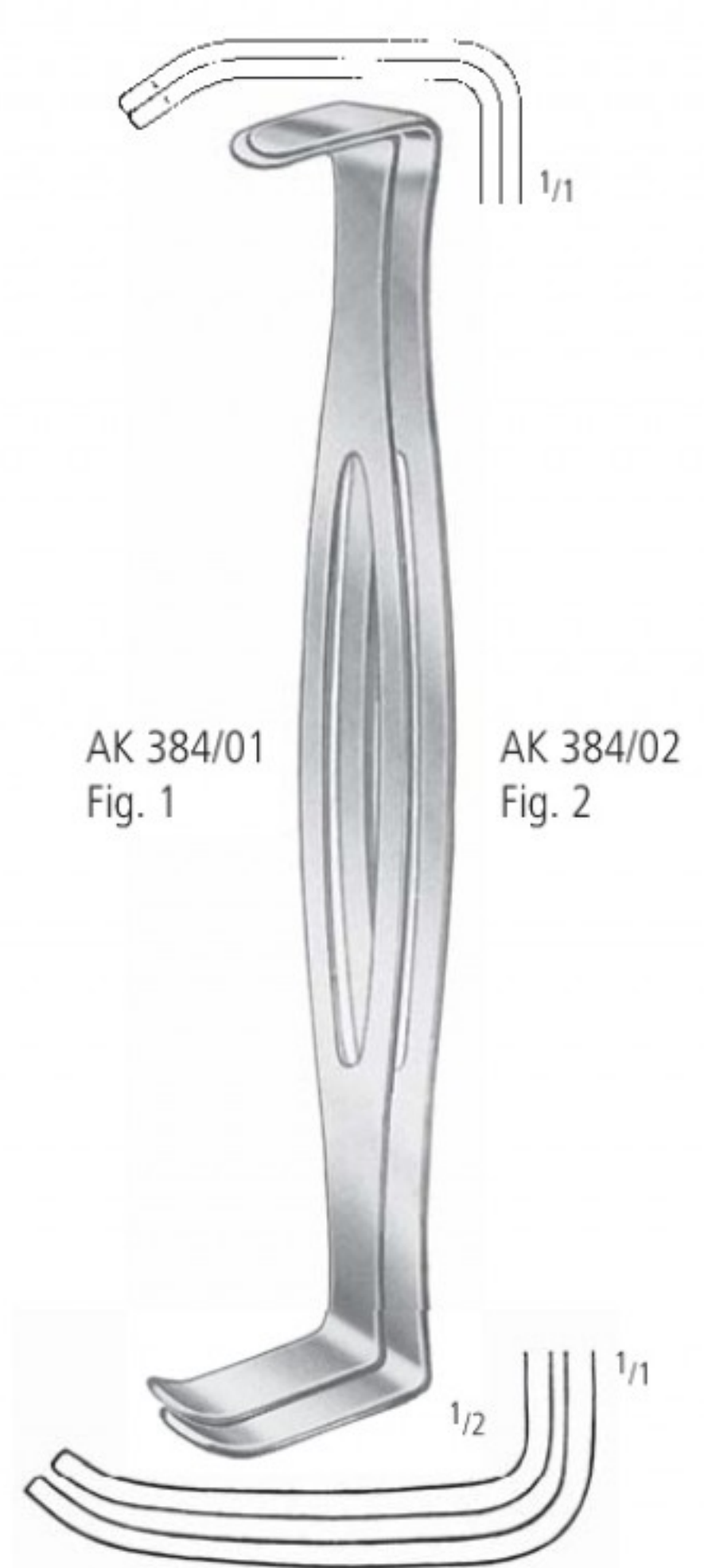

PARKER-LANGENBECK (U.S. Army)
AK 384/00 Fig. 1+2
21,0 cm/8 1/4"



AL 003/13
13,0 cm/5"



ALLIS 5:6
KD 055/15
15,0 cm/6"



GLOVER

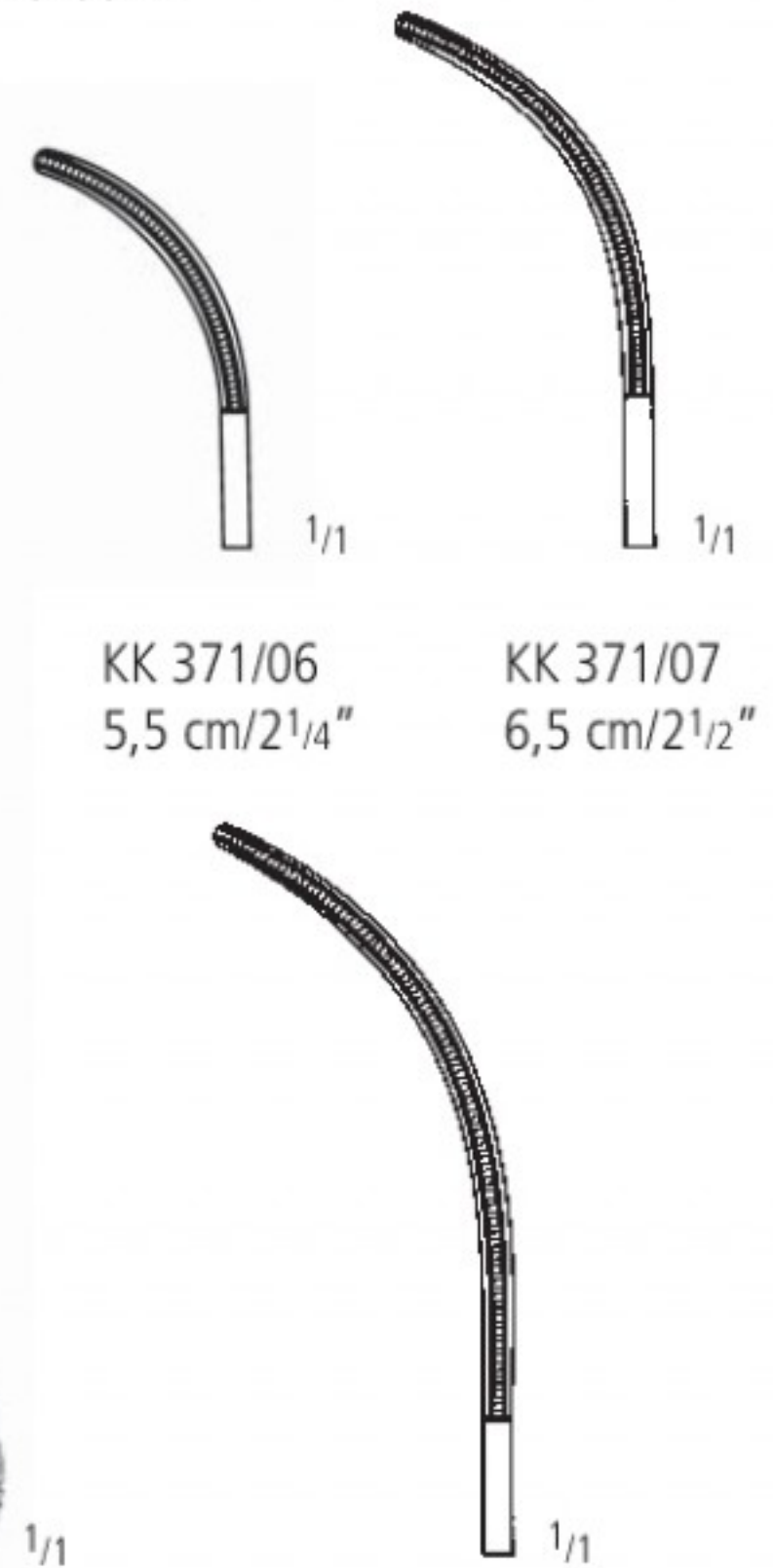

KK 371/06
5,5 cm/2 1/4"

KK 371/07
6,5 cm/2 1/2"

KK 371/09
8,5 cm/3 1/3"

cardiovascular basic

endarterectomy

thoracotomy

coronary bypass



PENFIELD
KS 638/01
17,5 cm/7"



L(mm)	B(mm)	H(mm)	
540	255	70	KYE 301/07

THORAKOTOMIE
THORACOTOMY
THORACOTOMIA
THORACOTOMIE
THORACOTOMIA

SET

ZS 941/01

Siebvorschlag - Suggested instrument set



ZS 941/01	Contents:	Qty
AA 151/12	HALSTED-MOSQUITO FCPS CVD 12,5 CM	12
AA 201/16	ROCHESTER-PEAN FCPS CVD 16,0 CM	12
AA 355/23	MIXTER FORCEPS CVD 23,0 CM	2
AA 751/08	BACKHAUS TOWEL FORCEPS 8,0 CM	12
AB 200/25	POTTS-SMITH DRESSING FORCEPS STR 25,0 CM	2
AB 210/25	POTTS-SMITH TISS. FCPS STR 1X2 TEETH 25,0 CM	1
AB 418/23	NELSON GRASPING FCPS 23,0 CM	1
AC 111/28	METZENBAUM-NELSON SCS CVD BL/BL 28,0 CM	1
AE 130/27	MASSON NEEDLE HOLDER 27,0 CM	1
AK 150/04	VOLKMANN RETR. SHARP 4 PRONGS 21,5 CM	2
AK 230/02	LANGENBECK RETRACTOR 22,0 CM 30X14 MM	2
AK 337/90	DAVIDSON RETRACTOR 75X90 MM 16,0 CM	1
KA 550/53	MALLET 530G STEEL SOLID Ø 42/30 MM 24,0 CM	1
KA 677/15	LAMBOTTE RASPATORIES 15 MM	1
KA 681/17	DOYEN PERIOST. RASPATORY CVD LEFT 17,0 CM	1
KA 683/17	DOYEN PERIOST. RASPATORY CVD RIGHT 17,0 CM	1
KA 763/19	SEMB BONE HOLDING FCPS W/O RATCHET 19,0 CM	1
KA 853/22	STILLE-LUER BONE RONGEURS CVD 22,0 CM	1
KD 124/23	DUVAL INT. TISSUE FCPS LARGE 23,0 CM	2
KK 018/34	BETHUNE RIB SHEARS 34,0 CM	1
KK 040/25	LEBSCHER CHISEL 25,0 CM	1
KK 092/02	FINOCCHIETTO RIB SPREADER 46X62X190 MM	1
KK 170/19	SELLORS RIB CONTRACTOR 19,0 CM	1
KK 180/32	ALLISON LUNG SPATULA 32,0 CM	1
KK 701/22	PRICE-THOMAS FORCEPS 22,0 CM	1
KK 703/02	SEMB BRONCHUS CLAMPS 22,0 CM	1
KYE 301/07	WIRE BASKET, 540 X 255 X 70 MM	1

Sterilization Container KYE 200/51, if required.



HALSTED-MOSQUITO
AA 151/12
12,5 cm/5"

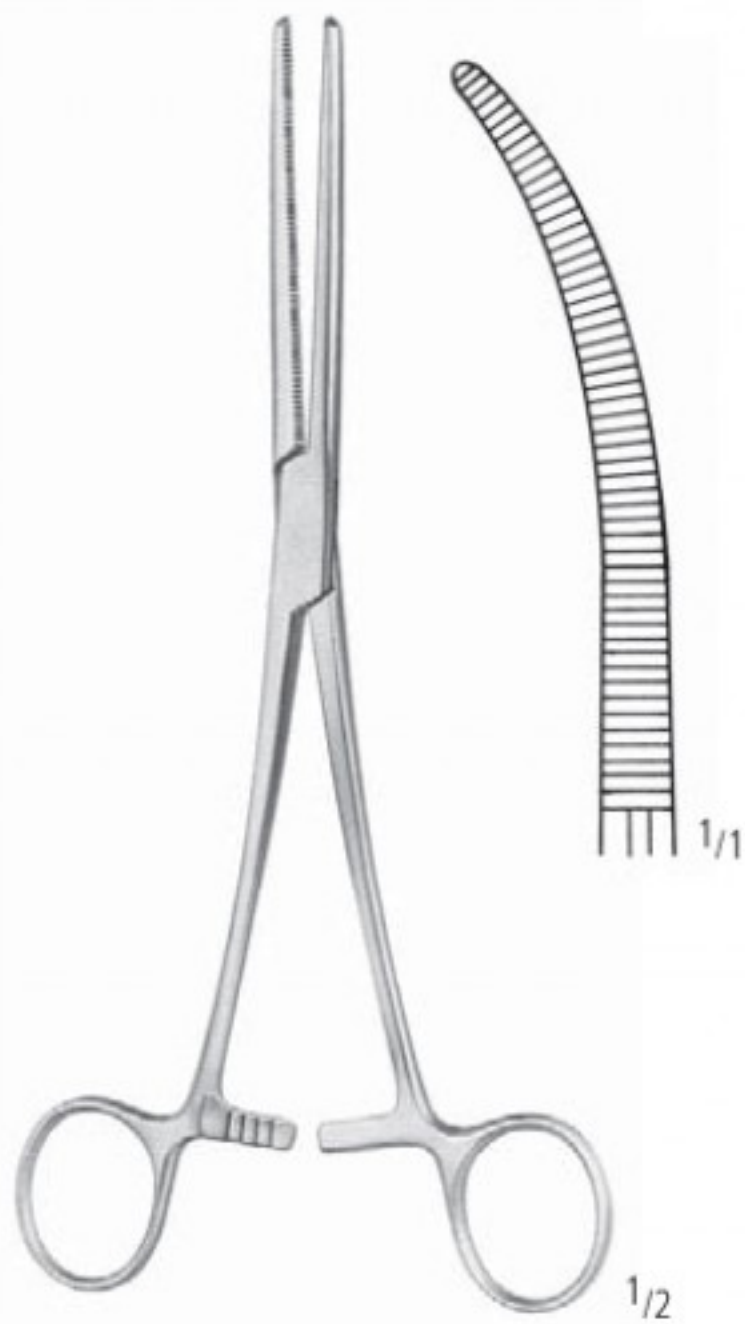

ROCHESTER-PEAN
AA 201/16
16,0 cm/6¹/₄"



MIXTER
AA 355/23
23,0 cm/9"

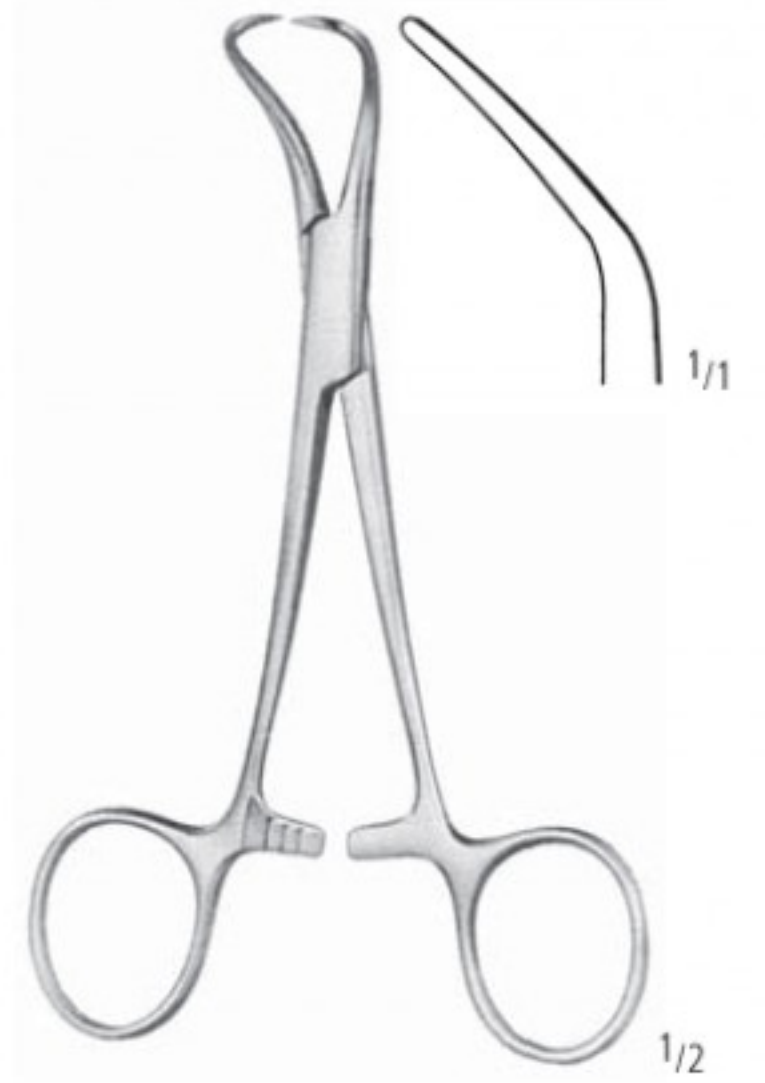

BACKHAUS
AA 751/08
8,0 cm/3"



POTTS-SMITH
AB 200/25
25,0 cm/10"



POTTS-SMITH 1:2
AB 210/25
25,0 cm/10"



NELSON
AB 418/23
23,0 cm/9"



METZENBAUM-NELSON
AC 111/28
28,0 cm/11"



MASSON
AE 130/27
27,0 cm/10³/₄"

cardiovascular basic

endarterectomy

thoracotomy

coronary bypass



VOLKMANN
AK 150/04
21,5 cm/8¹/₂"



LANGENBECK
AK 230/02
22,0 cm/8³/₄"



75 x 90 mm

DAVIDSON
AK 337/90
16,0 cm/6¹/₄"



Ø 42 mm

Ø 30 mm
530 g
(19 oz.)

KA 550/53
24,0 cm/9¹/₂"



15 mm

LAMBOTTE
KA 677/15
21,0 cm/8¹/₄"



DOYEN
17,0 cm/6³/₄"

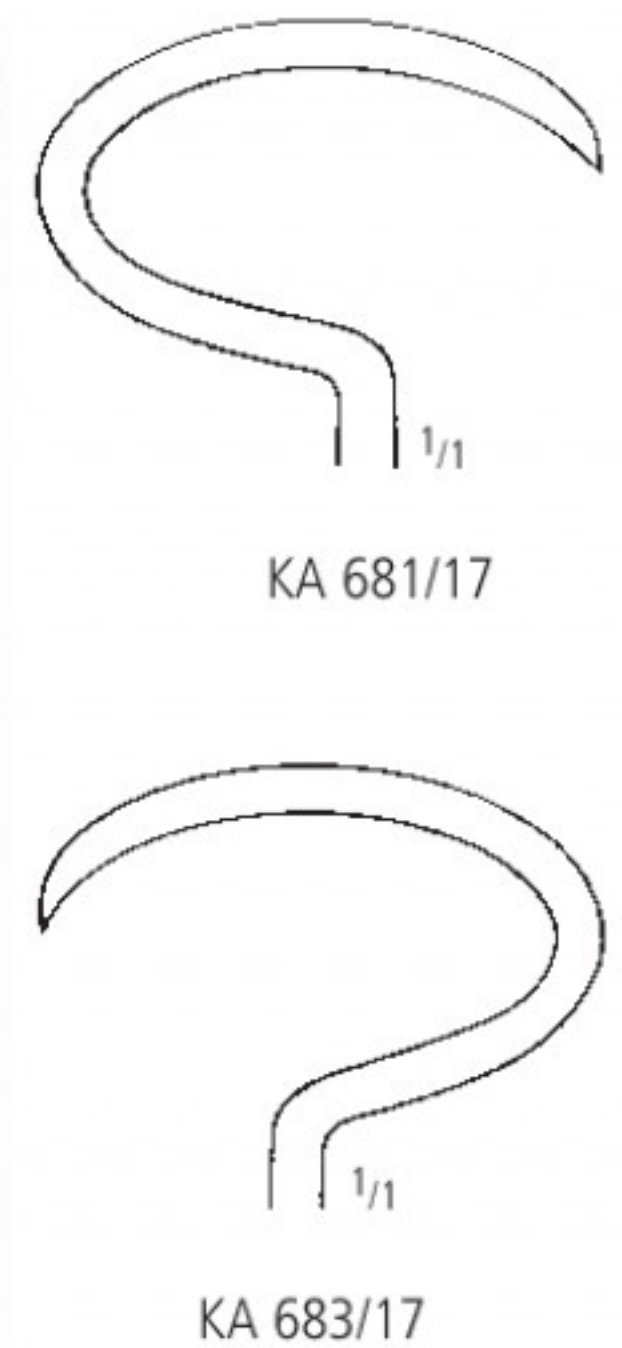

KA 681/17

KA 683/17

THORAKOTOMIE THORACOTOMY THORACOTOMIA THORACOTOMIE THORACOTOMIA



SEMBO
KA 763/19
19,0 cm/7 1/2"



STILLE-LUER
KA 853/22
22,0 cm/8 3/4"

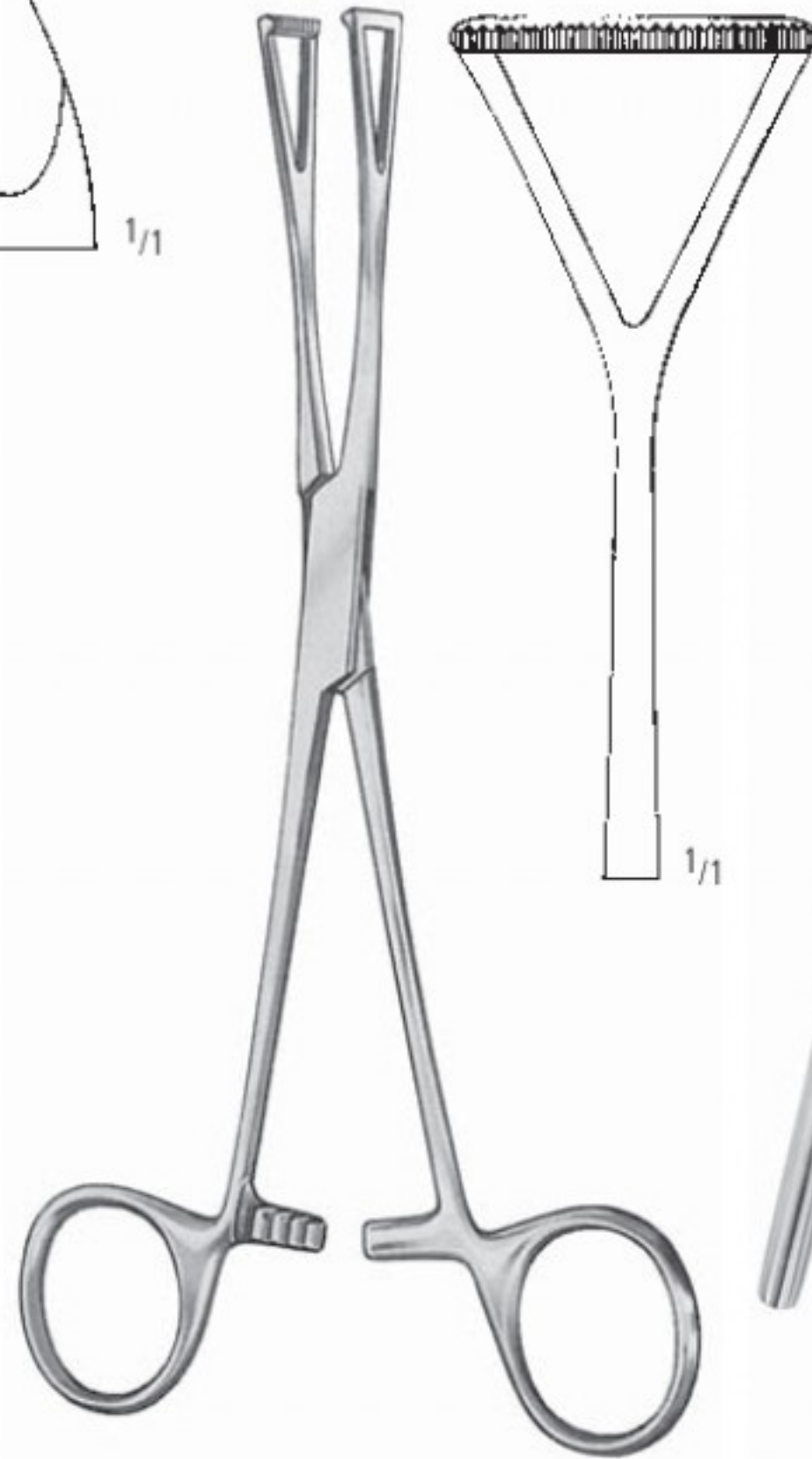

DUVAL
KD 124/23
23,0 cm/9"



BETHUNE
KK 018/34
34,0 cm/13 1/2"



LEBSCHER
KK 040/25
25,0 cm/10"



B 46 mm **H** 62 mm **C** 190 mm

FINOCCHIETTO
KK 092/02



SELLORS
KK 170/19
19,0 cm/7 1/2"

cardiovascular basic

endarterectomy

thoracotomy

coronary bypass



ALLISON
KK 180/32
32,0 cm/12¹/₂"



PRICE-THOMAS
KK 701/22
22,0 cm/8³/₄"

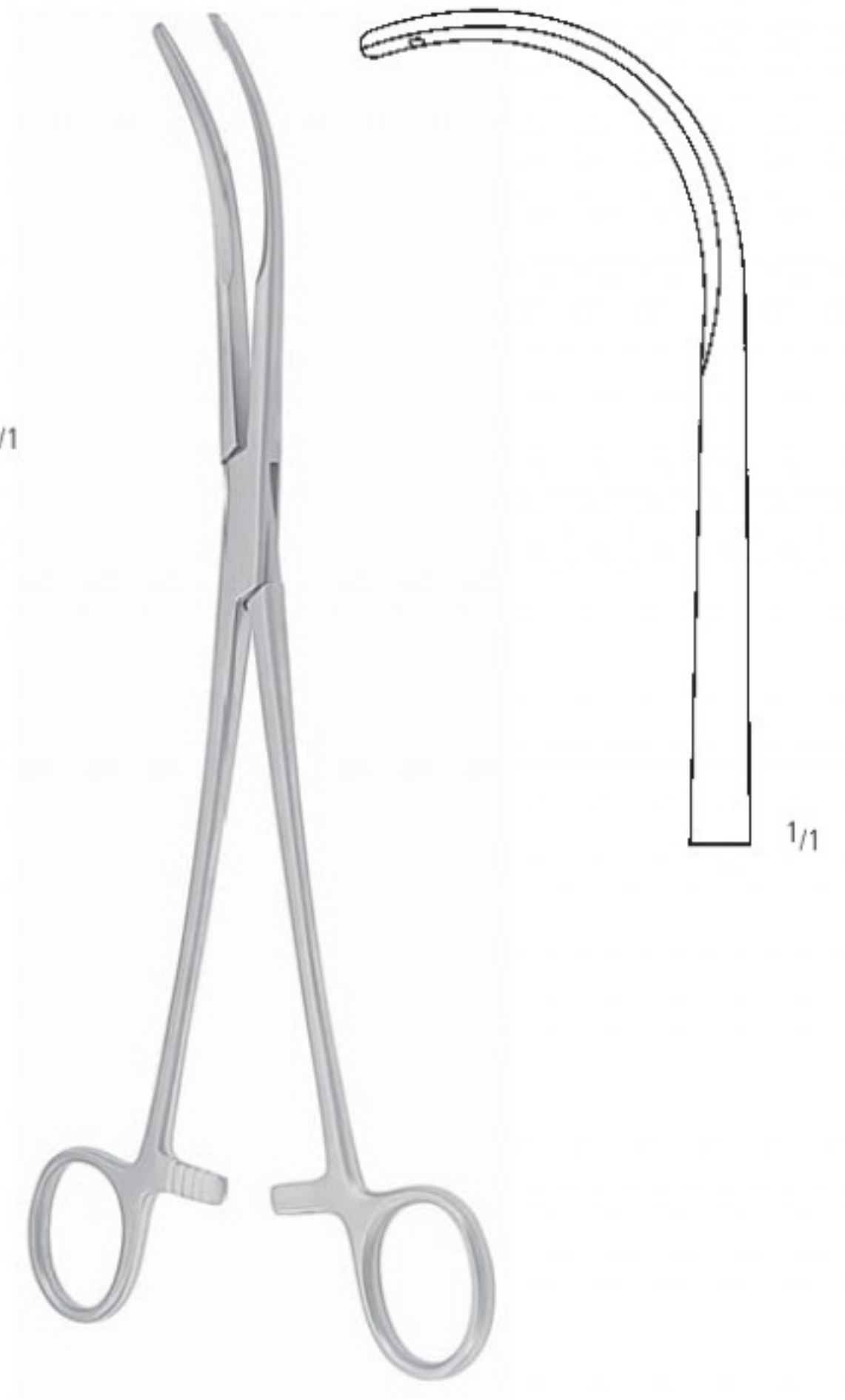

SEMB
KK 703/02
24,0 cm/9¹/₂"



L(mm)	B(mm)	H(mm)	
540	255	70	KYE 301/07

KORONAR ARTERIEN-BYPASS
CORONARY BYPASS
BYPASS CORONARIO
PONTAGE AORTO-CORONARIEN
BYPASS AORTO-CORONARICO

SET

ZS 941/60

Siebvorschlag - Suggested instrument set



ZS 941/60

Contents:

Qty

AA 114/10	HARTMANN FORCEPS STR 10,0 CM	6
AA 115/10	HARTMANN FORCEPS CVD 10,0 CM	6
AA 347/19	MIXTER-O'SHAUGNESSY ART. FCPS CVD 19,0 CM	2
AB 860/16	DE BAKEY ATRAUMA FCPS STR 1,5 MM 16,0 CM	2
AB 860/20	DE BAKEY ATRAUMA FCPS STR 1.5 MM 20,0 CM	2
AB 860/24	DE BAKEY ATRAUMA FCPS STR 1.5 MM 24,0 CM	2
AC 214/15	REYNOLDS DISS. SCISSORS STR SHARP 15,0 CM	1
AC 224/01	HEGEMANN-DIETRICH VASC. SCS 25 DEG 19,0 CM	1
AC 224/02	HEGEMANN-DIETRICH VASC. SCS 45 DEG 19,0 CM	1
AC 224/03	HEGEMANN-DIETRICH VASC. SCS 60 DEG 19,0 CM	1
AC 224/04	HEGEMANN-DIETRICH VASC. SCS 90 DEG 19,0 CM	1
AC 224/05	HEGEMANN-DIETRICH VASC. SCS 125 DEG 19,0 CM	1
AE 430/15	RYDER/FRENCH-EYE NEEDLE HOLDER TUC 15,0 CM	1
AE 430/18	RYDER/FRENCH-EYE NEEDLE HOLDER TUC 18,0 CM	1
AE 434/15	MICRO RYDER NEEDLE HOLDER TUC 15,0 CM	1
KC 130/01	BAKES GALL DUCT DILATOR FIG.1 30,0 CM	1
KC 130/02	BAKES GALL DUCT DILATOR FIG.2 30,0 CM	1
KC 130/03	BAKES GALL DUCT DILATOR FIG.3 30,0 CM	1
KC 130/04	BAKES GALL DUCT DILATOR FIG.4 30,0 CM	1
KC 130/05	BAKES GALL DUCT DILATOR FIG.5 30,0 CM	1
KC 130/06	BAKES GALL DUCT DILATOR FIG.6 30,0 CM	1
KC 130/07	BAKES GALL DUCT DILATOR FIG.7 30,0 CM	1
KC 130/08	BAKES GALL DUCT DILATOR FIG.8 30,0 CM	1
KC 130/09	BAKES GALL DUCT DILATOR FIG.9 30,0 CM	1
KC 130/10	BAKES GALL DUCT DILATOR FIG.10 30,0 CM	1
KC 130/11	BAKES GALL DUCT DILATOR FIG.11 30,0 CM	1
KK 453/20	DE BAKEY FORCEPS 20,0 CM	1
KYE 301/07	WIRE BASKET, 540 x 255 x 70 MM	1

Sterilization Container KYE 200/51, if required.

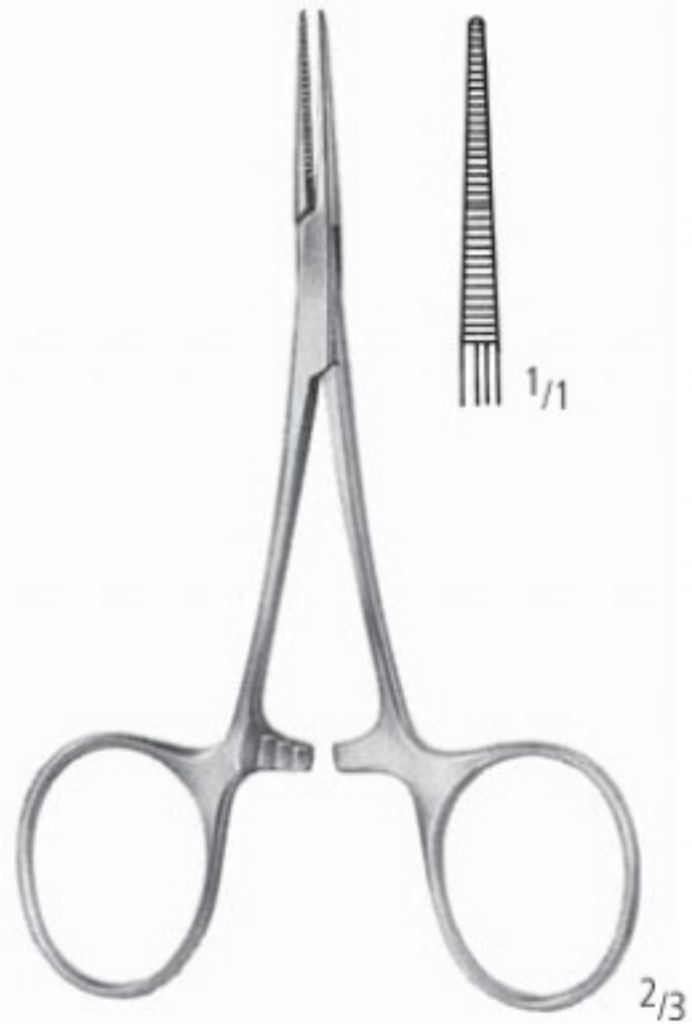

HARTMANN
AA 114/10
10,0 cm/4"

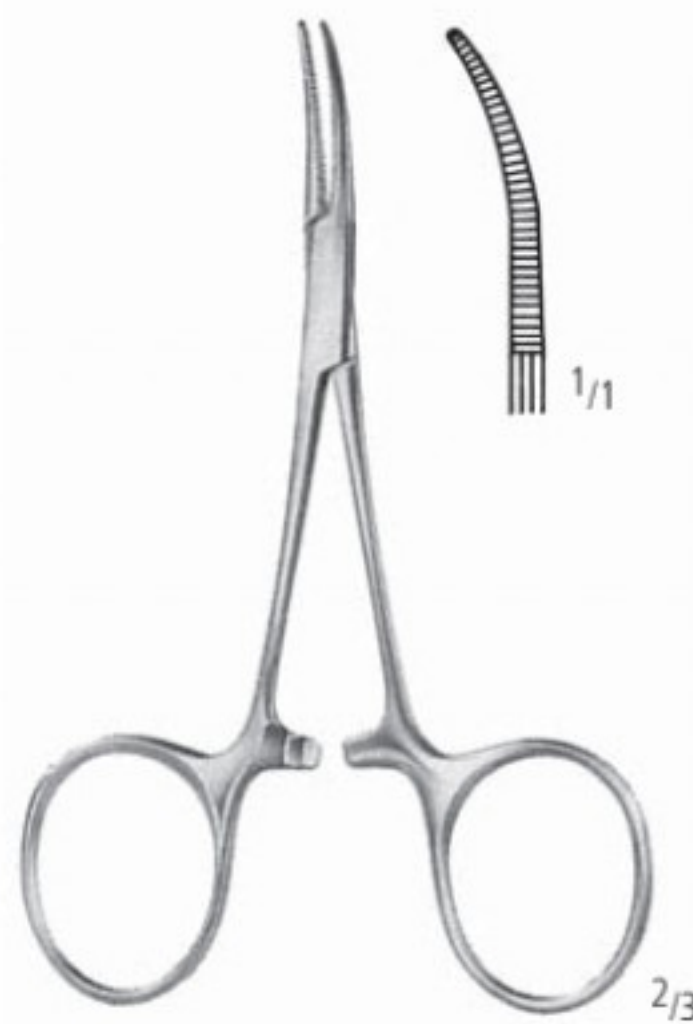

HARTMANN
AA 115/10
10,0 cm/4"

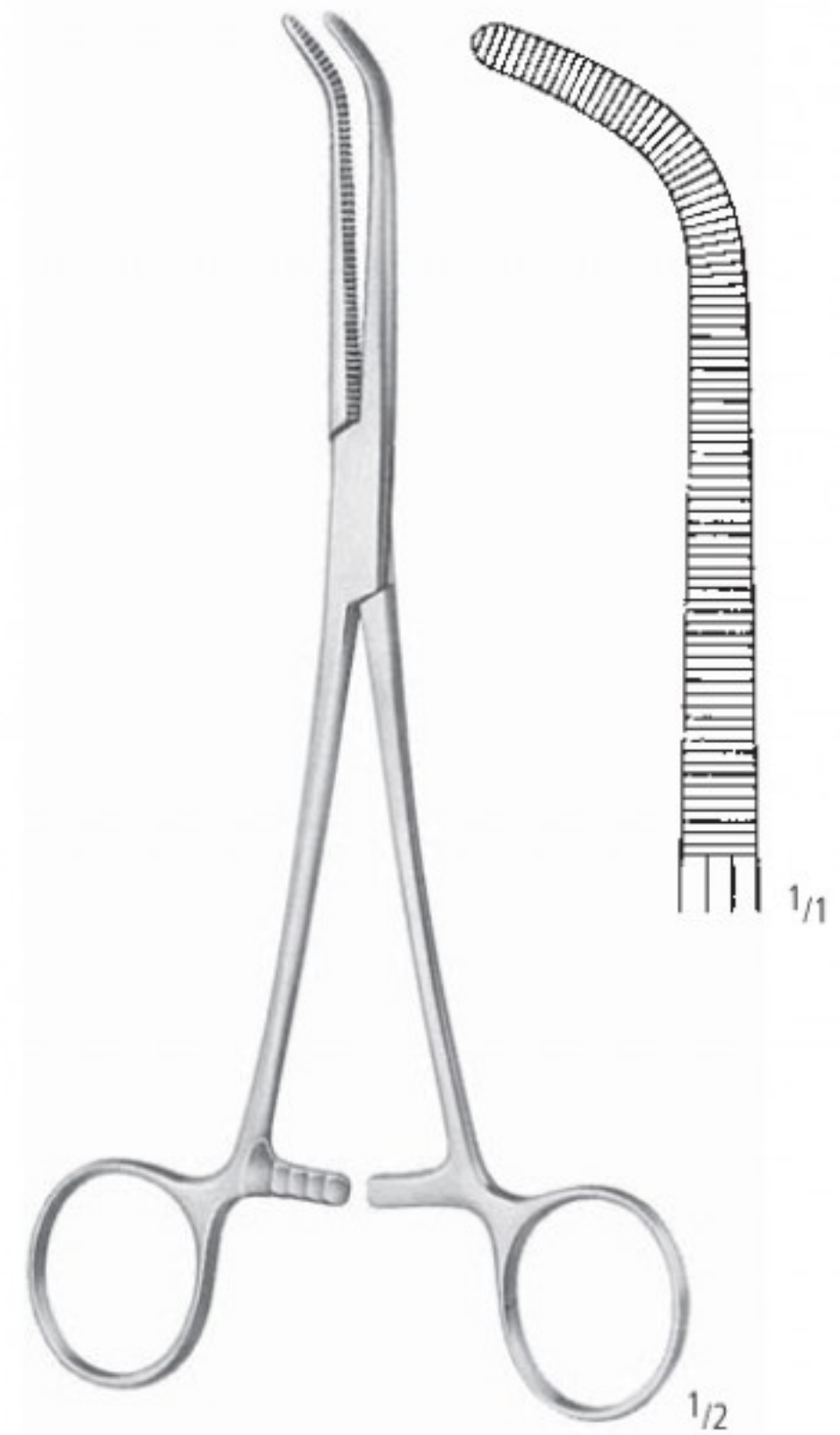

MIXTER-O'SHAUGHNESSY
AA 347/19
19,0 cm/7 1/2"

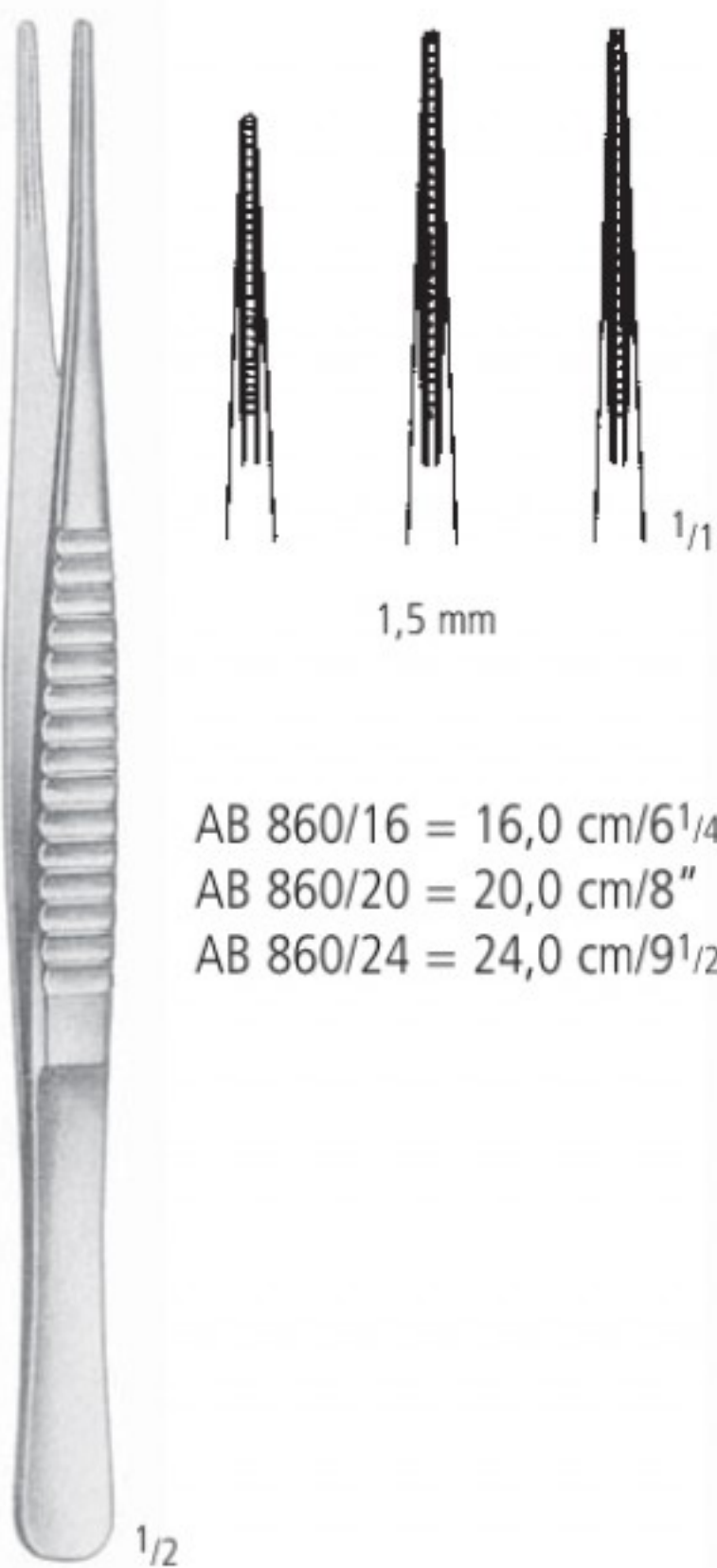

DE BAKEY



REYNOLDS
AC 214/15
15,0 cm/6"

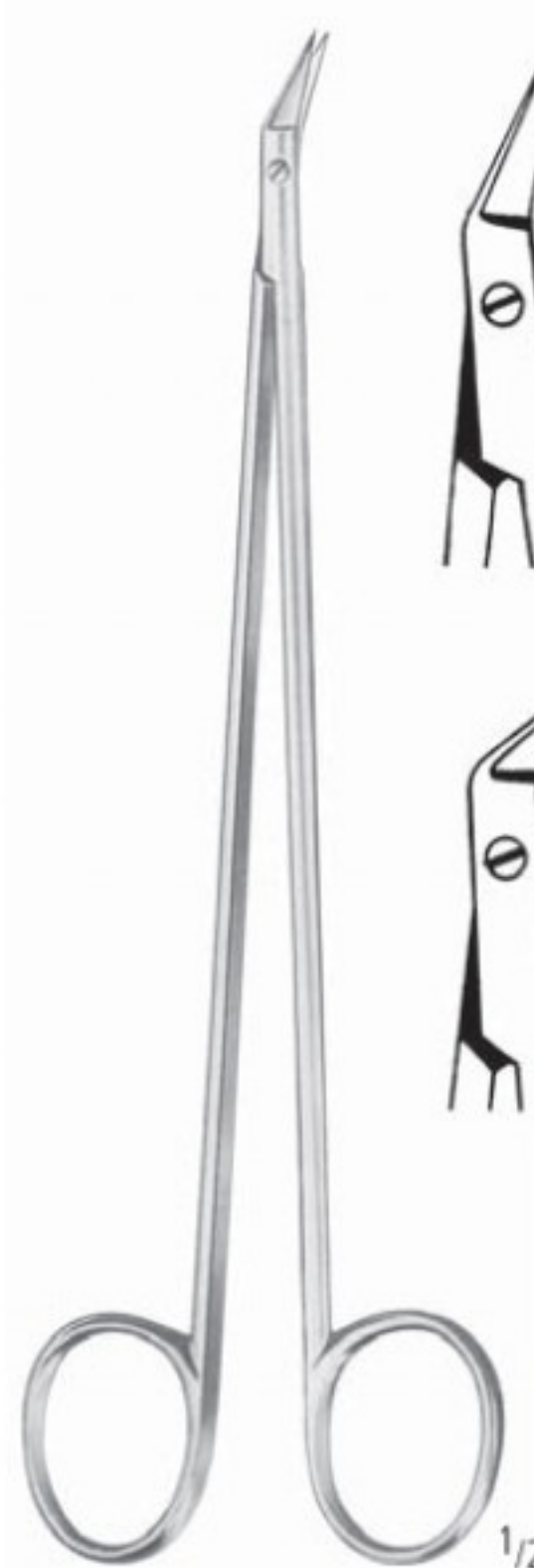

HEGEMANN-DIETRICH
19,0 cm/7 1/2"

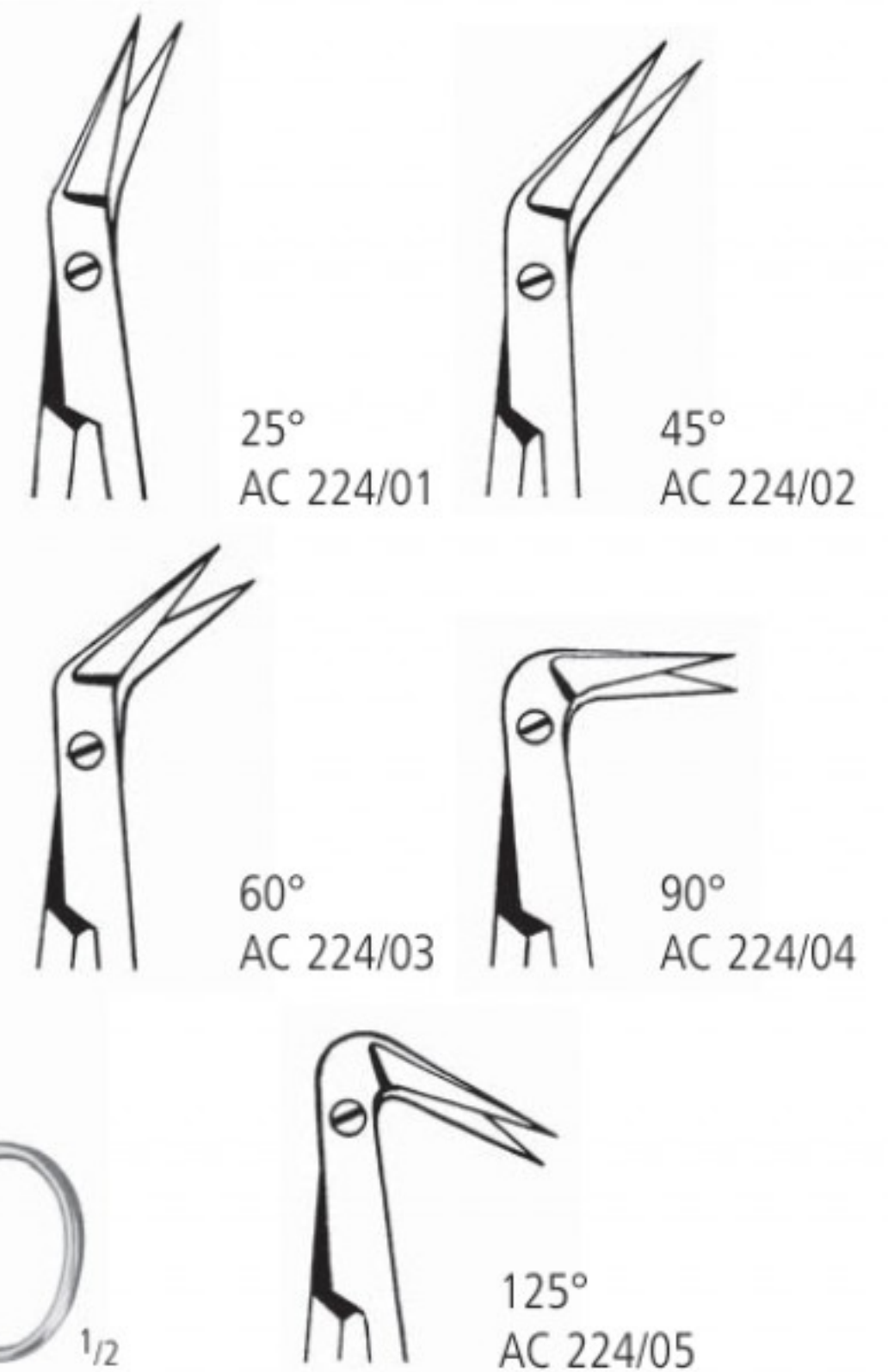

cardiovascular basic

endarterectomy

thoracotomy

coronary bypass

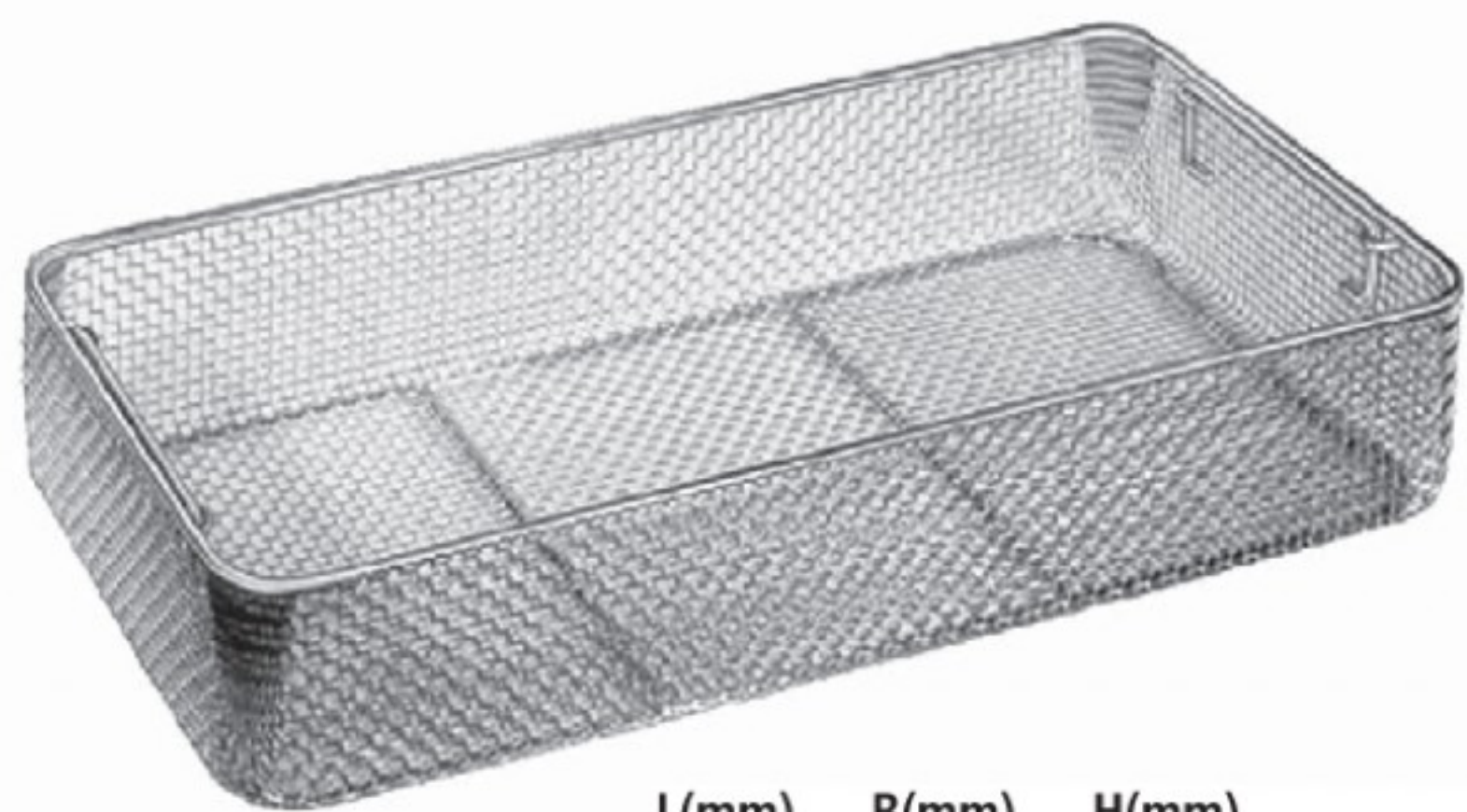
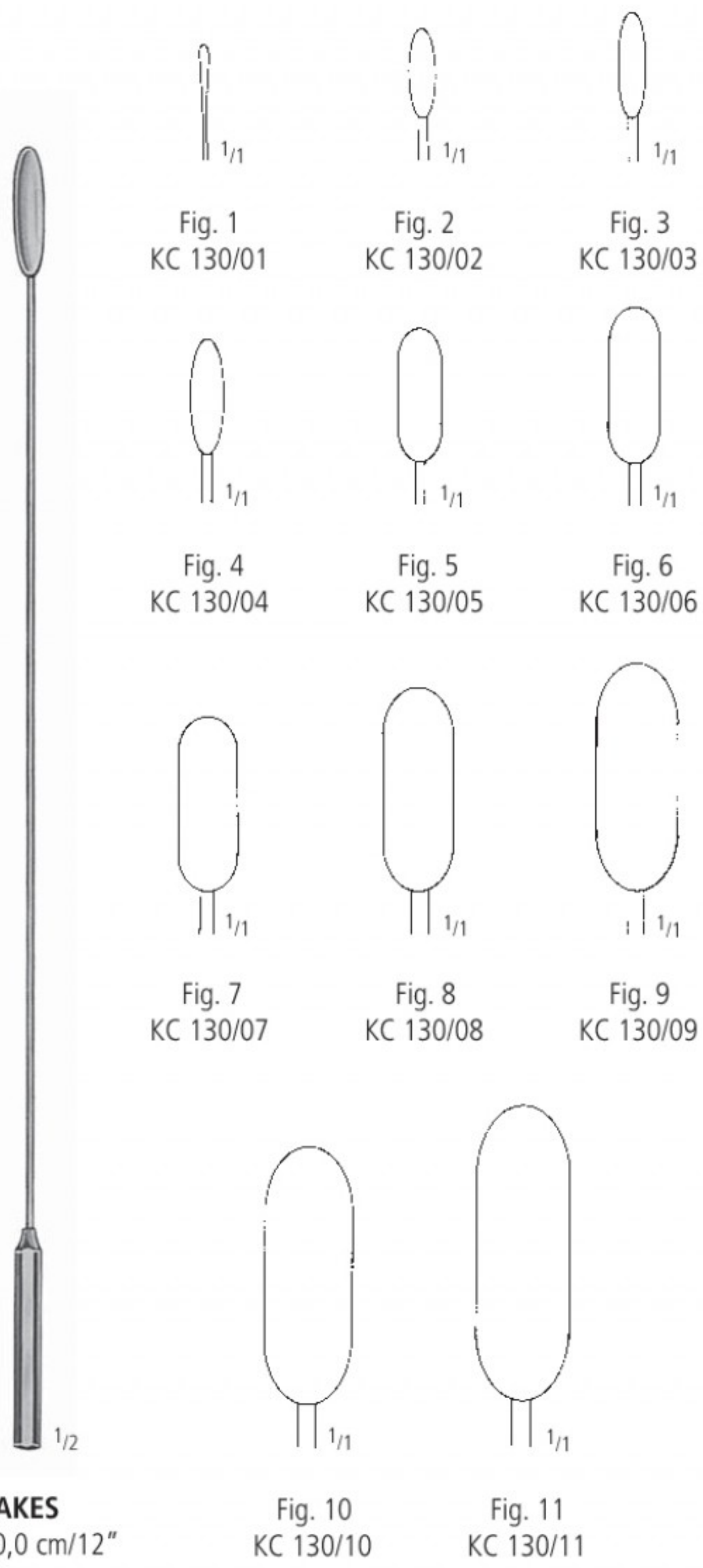
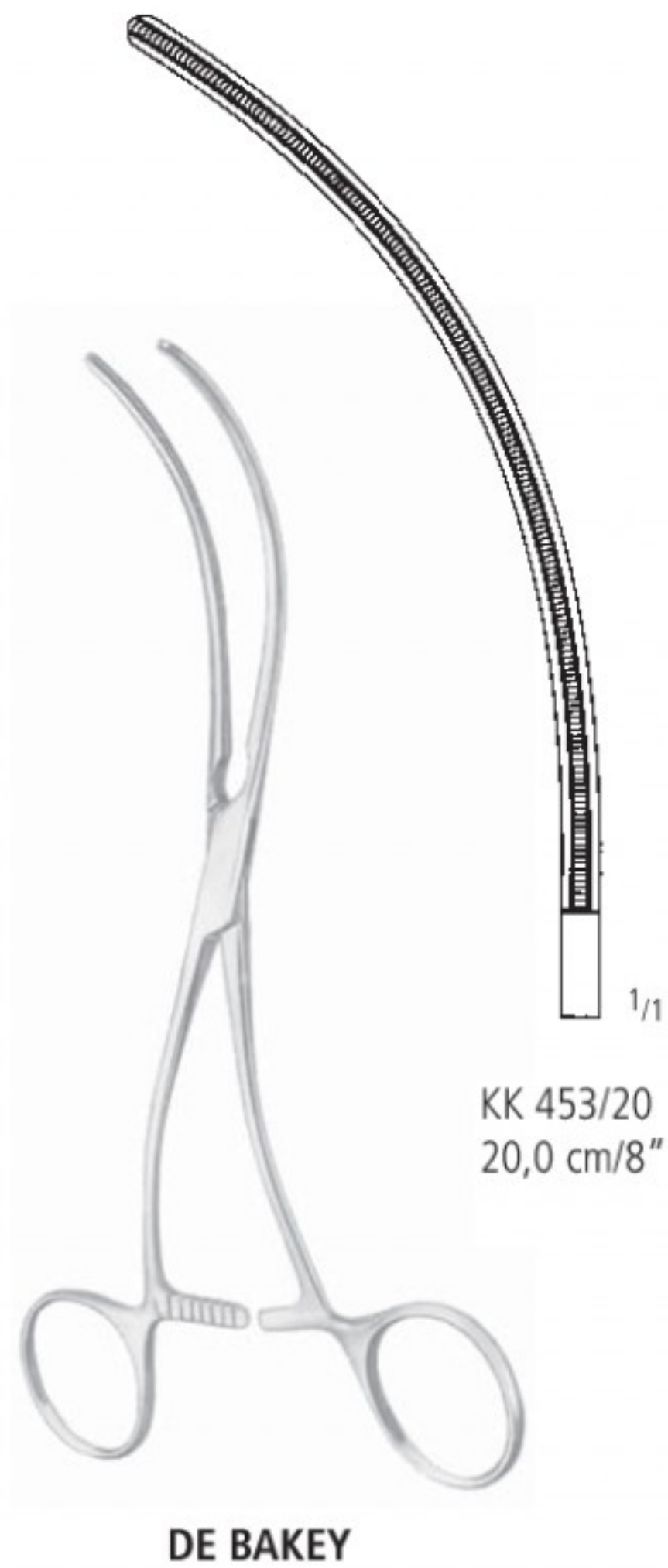
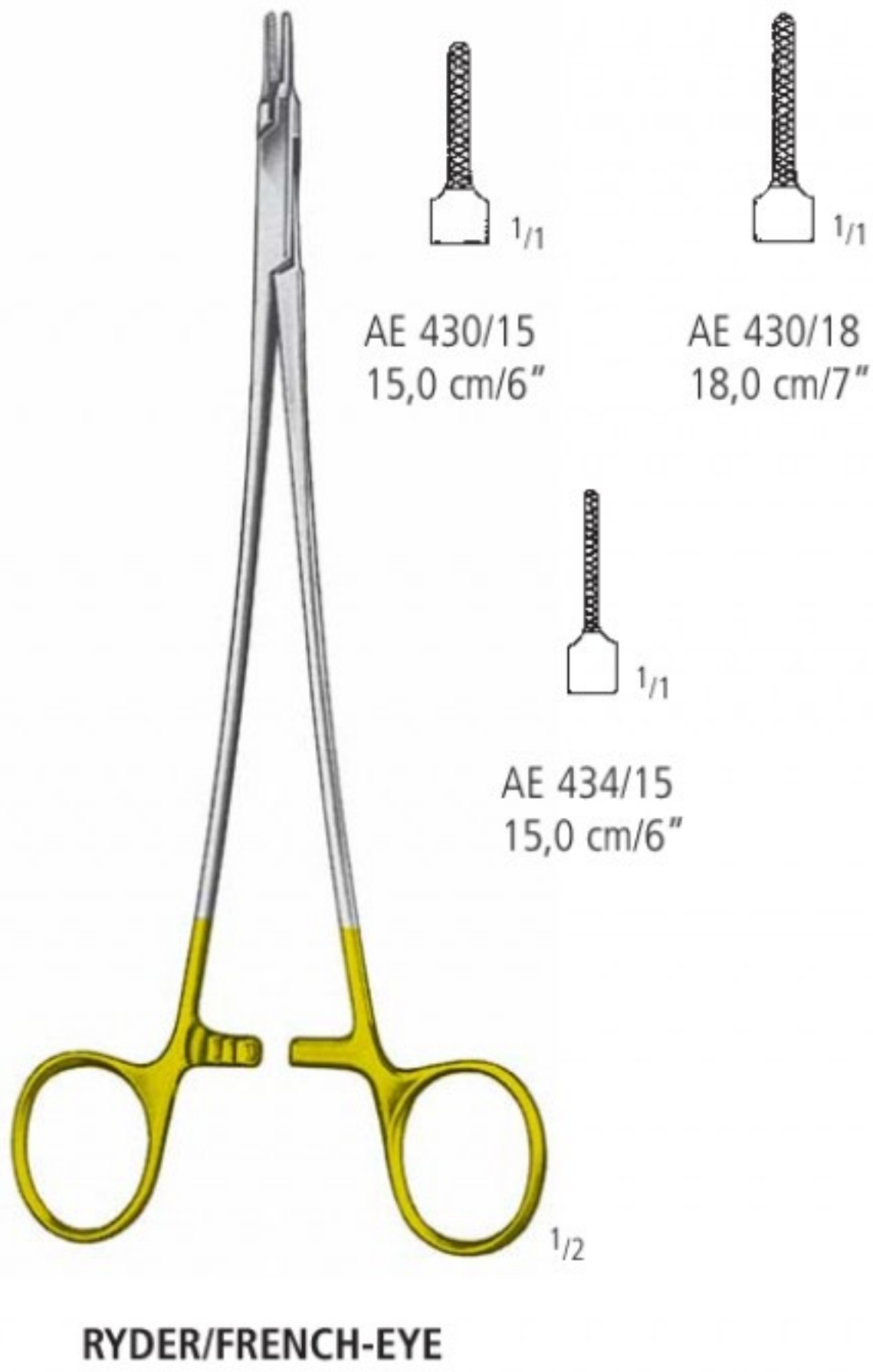

L(mm)	B(mm)	H(mm)	
540	255	70	KYE 301/07

KLEMMEN
HEMOSTATS
PINZAS HEMOSTATICAS
PINCES HEMOSTATIQUES
PINZE EMOSTATICHE

AA

nopa[®] instruments

Weitere Klemmen finden Sie in unserem Katalog „Allgemeine Chirurgie“ in Gruppe AA.

For further hemostats kindly refer to our catalogue "General Surgery", section AA.

Para pinzas hemostaticas adicionales, por favor consulte nuestro catálogo de "Cirugía general", grupo AA.

Pour des pinces hemostatiques supplémentaires, consultez notre catalogue „Chirurgie Generale“, section AA.

Per gli altri pinze emostatiche, consultare il nostro catalogo "Chirurgia Generale", gruppo AA.





titan instruments

nopa[®] instruments

Besonderheit:

nopa Titan Instrumente bieten insbesondere in der Herz-Thorax-Chirurgie Vorteile gegenüber herkömmlichen Instrumenten. Titan ist ca. 45% leichter als rostfreier Edelstahl, weshalb Titan Instrumente weniger traumatisierend sind. Titan ist außerdem ein vollkommen korrosionsbeständiges und antimagnetisches Material. **nopa** Titan Instrumente bedeuten größtmöglichen Komfort für den Chirurgen.

Features:

nopa Titan Instruments provide especially in Cardiovascular surgery a significant advantage compared to other Instruments. Titan is approximately 45% lighter than stainless steel. For that reason, Titan Instruments are less traumatic. Besides that, Titan is a completely stainless and anti-magnetic material. **nopa** Titan Instruments are the most comfortable choice for the Cardiovascular surgeon.

AA 114/10 T	HARTMANN FORCEPS STR 10,0 CM
AA 115/10 T	HARTMANN FORCEPS CVD 10,0 CM
AA 130/12 T	MICRO-MOSQUITO FORCEPS STR 12,0 CM
AA 131/12 T	MICRO-MOSQUITO FORCEPS CVD 12,0 CM
AA 132/12 T	MICRO-MOSQUITO ARTREY FCPS 1X2 STR 12,0 CM
AA 133/12 T	MICRO-MOSQUITO ARTERY FCPS 1X2 CVD 12,0 CM
AA 150/12 T	HALSTED-MOSQUITO FORCEPS STR 12,5 CM
AA 151/12 T	HALSTED-MOSQUITO FORCEPS CVD 12,5 CM
AA 152/12 T	HALSTED-MOSQUITO ARTERY FCPS 1X2 STR 12,5 CM
AA 153/12 T	HALSTED-MOSQUITO FCPS1X2 CVD 12,5 CM
AA 160/15 T	LERICHE ARTERY FCPS STR 15,0 CM
AA 161/15 T	LERICHE ARTERY CVD 15,0 CM
AA 162/15 T	LERICHE ARTERY FCPS STR 1X2 T 15,0 CM
AA 163/15 T	LERICHE ARTERY FCPS CVD 1X2 T 15,0 CM
AA 330/24 T	CRAFOORD ARTERY FORCEPS CVD 24,0 CM



Gewebefasszängchen
Tissue Seizing Forceps
Pinzas para coger tejidos
Pinces pour saisir le tissu
Pinze per afferrare tessuti

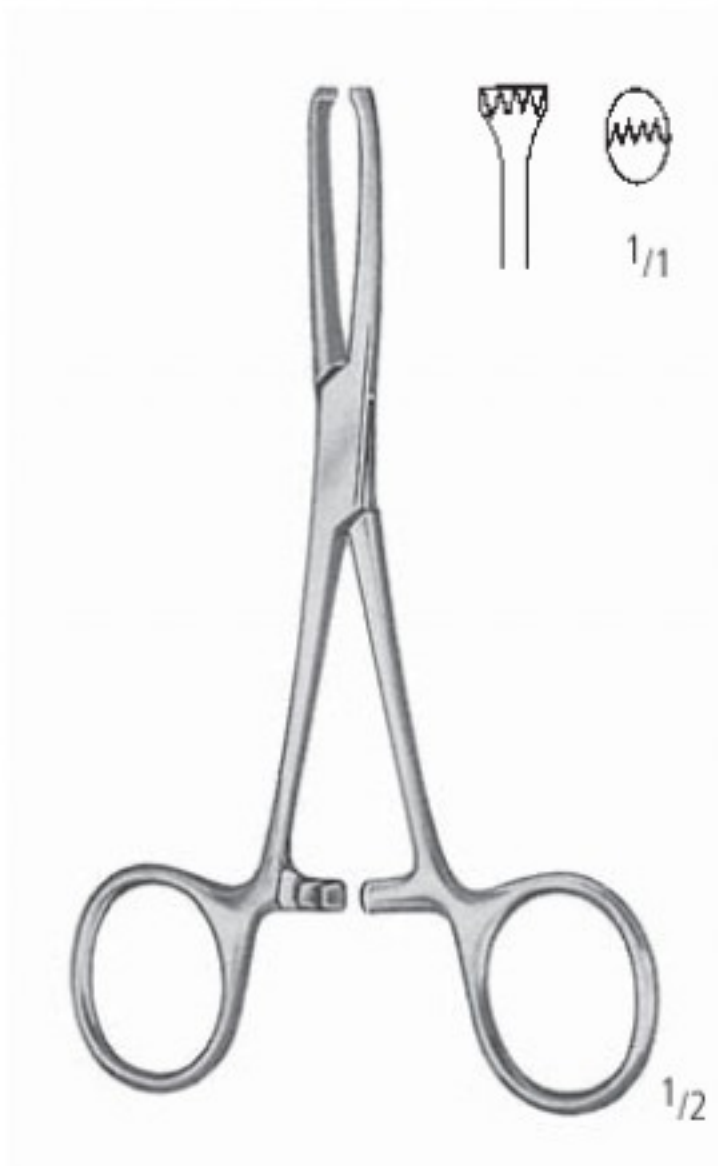

ALLIS-BABY 4:5
KD 050/12
12,5 cm/5"



ALLIS 4:5
KD 054/15
15,0 cm/6"



ALLIS 5:6
15,0 cm/6" KD 055/15
19,0 cm/7 1/2" KD 055/19
25,0 cm/10" KD 055/25

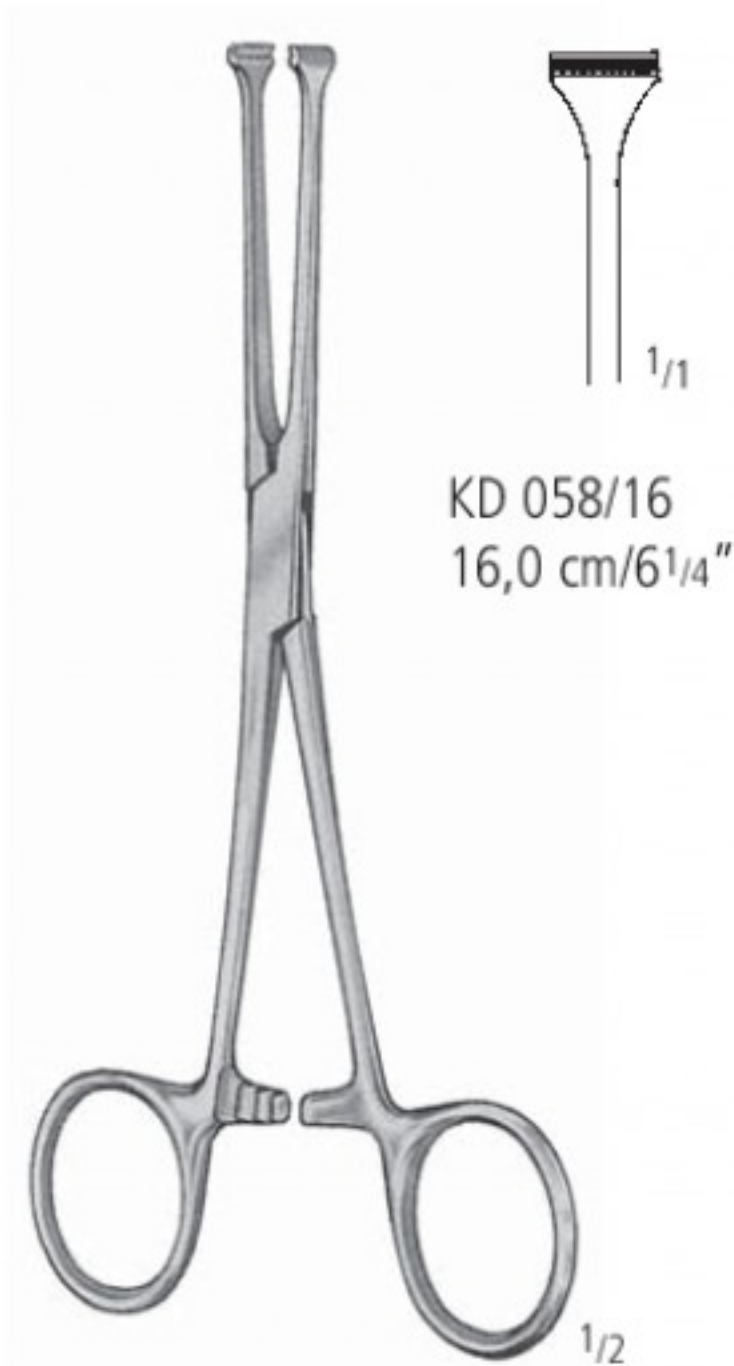

ALLIS

KD 058/16
16,0 cm/6 1/4"

KD 058/20
20,0 cm/8"

KD 058/25
25,0 cm/10"

KD 058/30
30,0 cm/12"



ALLIS-ADAIR 10:11
KD 060/15
15,0 cm/6"

KLEMMEN HEMOSTATS PINZAS HEMOSTATICAS PINCES HEMOSTATIQUES PINZE EMOSTATICHE

Darmfasszangen
Tissue Seizing Forceps
Pinzas para coger intestinos
Pinces pour saisir l'intestin
Pinze per afferrare l'intestino

AA
AB
AC
AD
AE
AF
AK
AL
AO
KA
KK
X



BABCOCK

16,0 cm/6 1/4" KD 100/16
20,0 cm/8" KD 100/20



BABCOCK

KD 111/16
16,0 cm/6 1/4"



KD 111/18
18,0 cm/7"

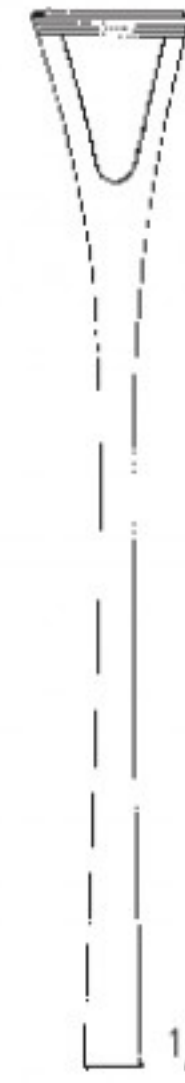

KD 111/20
20,0 cm/8"



KD 111/24
24,0 cm/9 1/2"

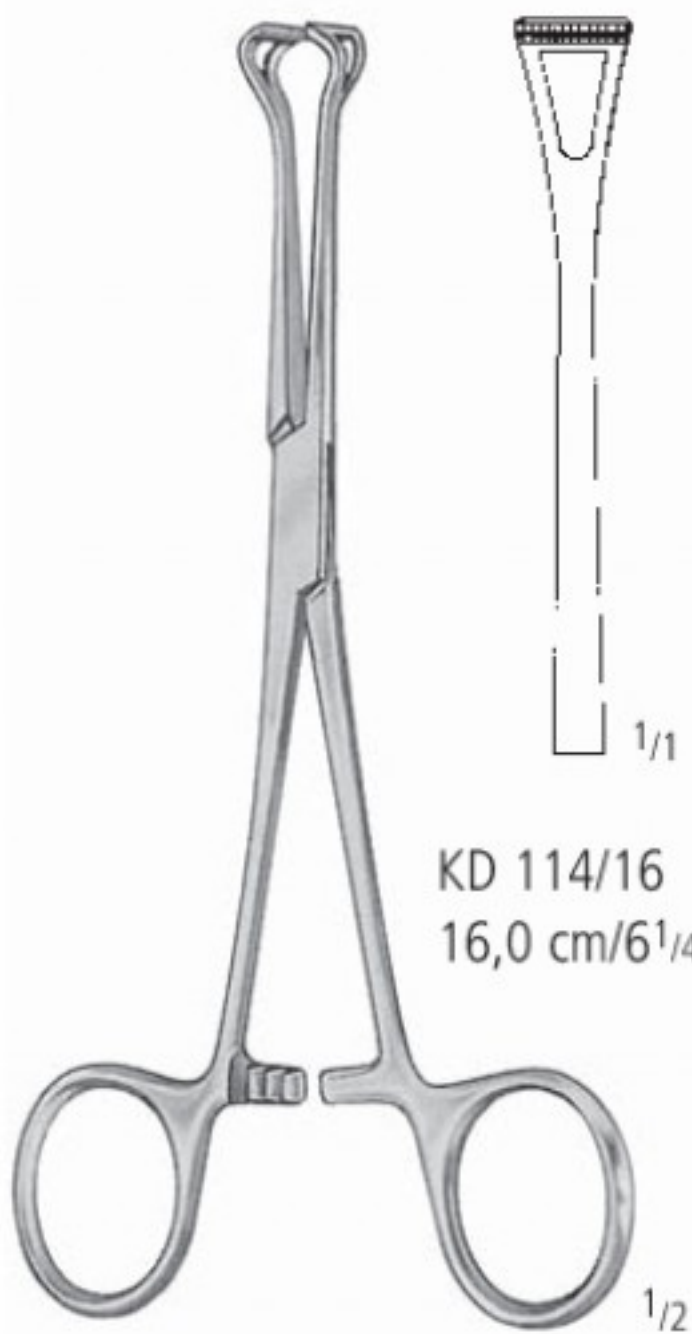

BABCOCK

KD 114/16
16,0 cm/6 1/4"

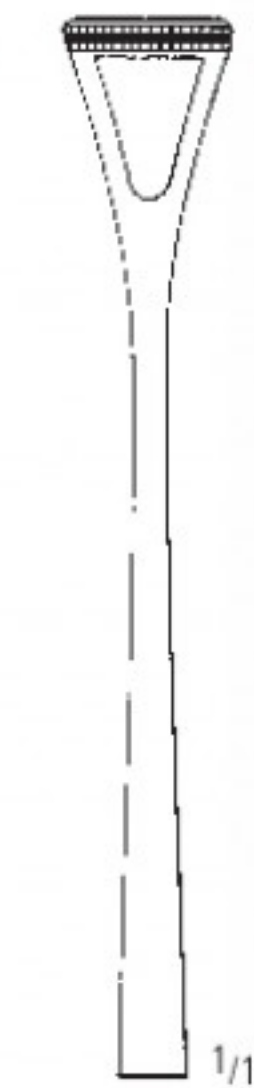

KD 114/20
20,0 cm/8"



DUVAL

KD 120/20
20,0 cm/8"



KD 122/18
18,0 cm/7"
KD 122/20
20,0 cm/8"

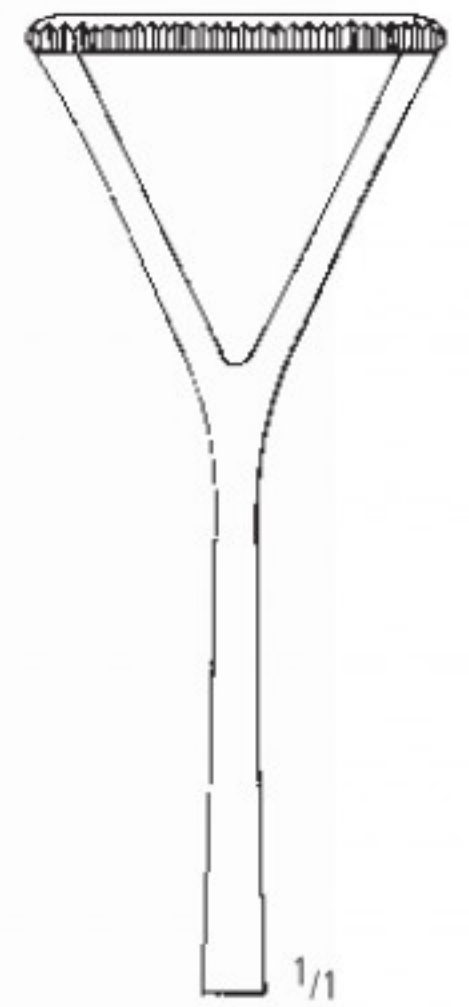

KD 124/20
20,0 cm/8"
KD 124/23
23,0 cm/9"

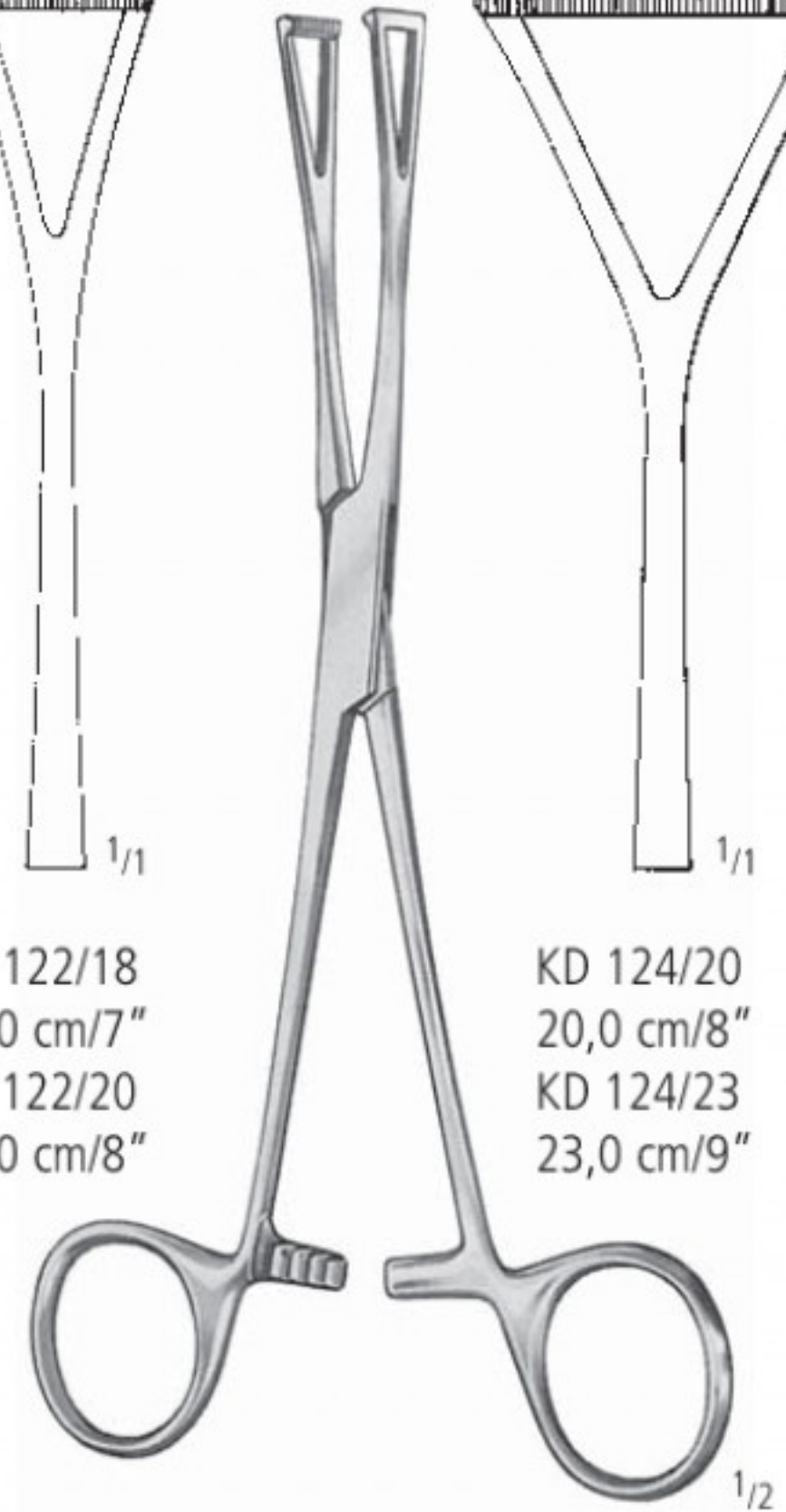

DUVAL

AA

KLEMMEN HEMOSTATS PINZAS HEMOSTATICAS PINCES HEMOSTATIQUES PINZE EMOSTATICHE

Bulldogklemmen
Bulldog Clamps
Clamps Bulldog
Clamps Bulldog
Pinze Bulldog

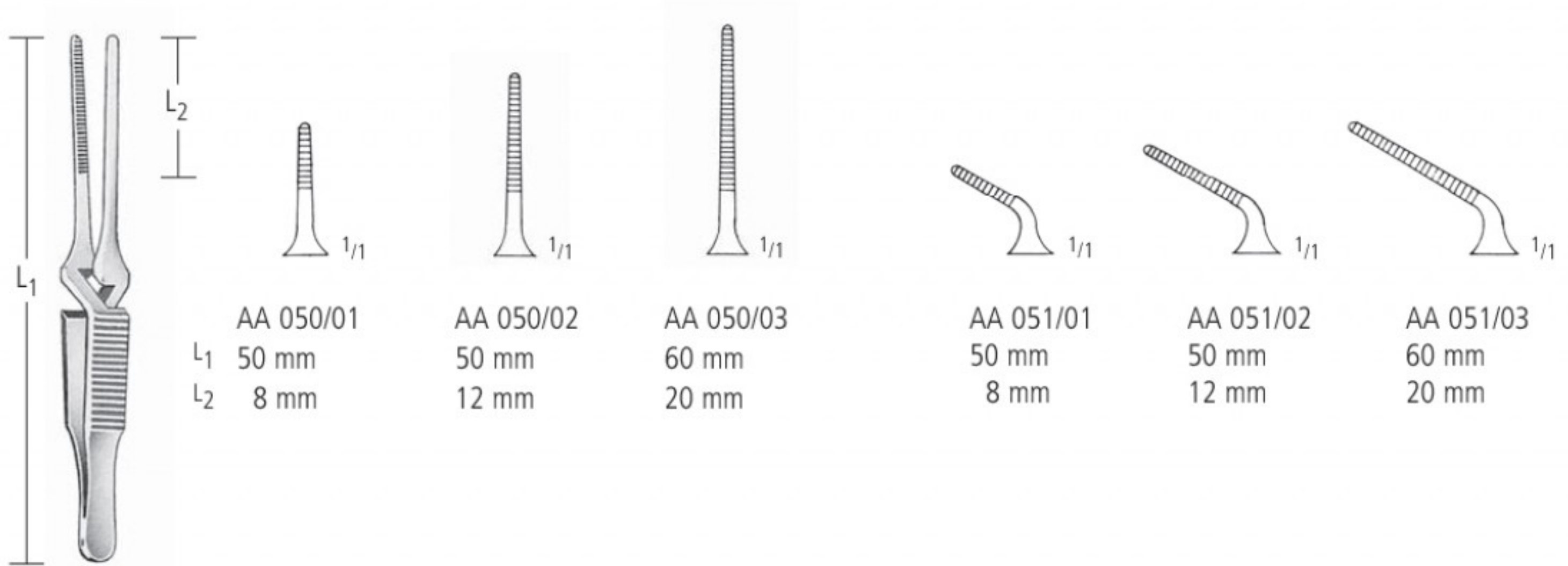

AA 050/01
L₁ 50 mm
L₂ 8 mm

AA 050/02
50 mm
12 mm

AA 050/03
60 mm
20 mm

AA 051/01
50 mm
8 mm

AA 051/02
50 mm
12 mm

AA 051/03
60 mm
20 mm

3 gr.
Gewicht
Weight
Peso
Poids
Peso

50 gr.
Druck
Pressure
Presión
Pression
Pressione

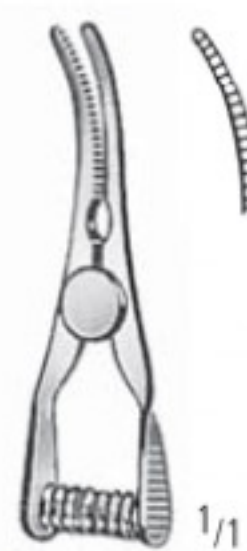

**VENA
ARTERIA**

AA 052/01
AA 053/01

TITAN 30 mm
AA 052/02
AA 053/02

AA 052/03
AA 053/03

AA 054/01
AA 055/01

TITAN 35 mm
AA 054/02
AA 055/02

AA 054/03
AA 055/03



**VENA
ARTERIA**

AA 056/01
AA 057/01

TITAN 40 mm
AA 056/02
AA 057/02

AA 056/03
AA 057/03

AA 058/01
AA 059/01

TITAN 50 mm
AA 058/02
AA 059/02

AA 058/03
AA 059/03

KLEMMEN HEMOSTATS PINZAS HEMOSTATICAS PINCES HEMOSTATIQUES PINZE EMOSTATICHE

Bulldogklemmen, Anlegezange
 Bulldog Clamps, Setting Forceps
 Clamps Bulldog, Pinza para poner
 Clamps Bulldog, Pince à poser
 Pinze Bulldog, Pinza per posizionare

AA
 AB
 AC
 AD
 AE
 AF
 AK
 AL
 AO
 KA
 KK
 X



DIEFFENBACH



AA 060/03
3,5 cm/1 1/2"

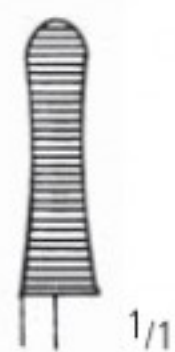

AA 060/05
5,0 cm/2"

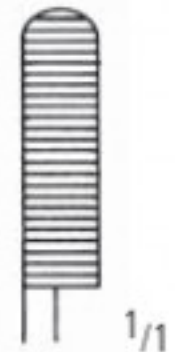

AA 060/06
6,0 cm/2 1/2"



AA 061/03
3,5 cm/1 1/2"

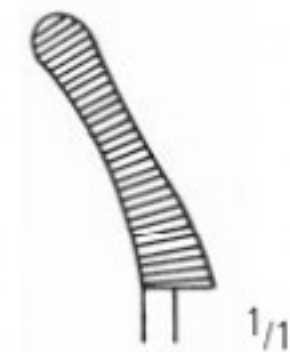

AA 061/05
5,0 cm/2"



AA 061/06
6,0 cm/2 1/2"



JOHNS-HOPKINS

AA 069/24
24,5 cm/9 3/4"



JOHNS-HOPKINS

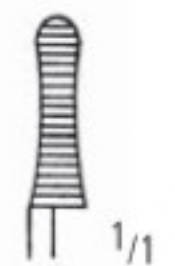

AA 070/04
4,0 cm/1 1/2"

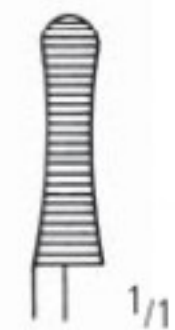

AA 070/05
5,0 cm/2"

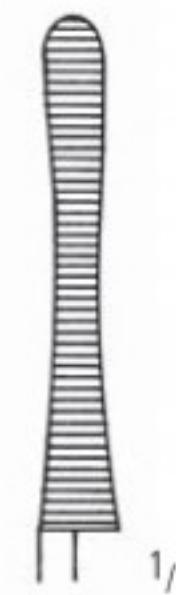

AA 070/06
6,5 cm/2 1/2"

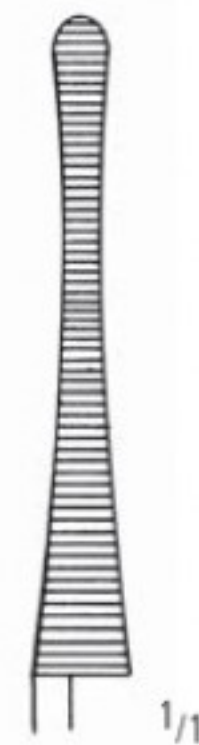

AA 070/07
7,5 cm/3"

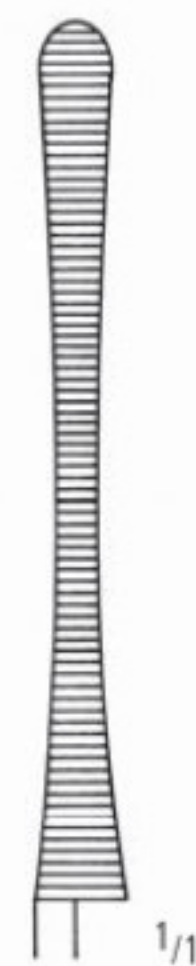

AA 070/09
9,0 cm/3 1/2"



AA 071/04
4,0 cm/1 1/2"



AA 071/05
5,0 cm/2"

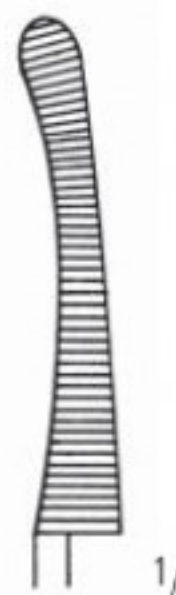

AA 071/06
6,5 cm/2 1/2"

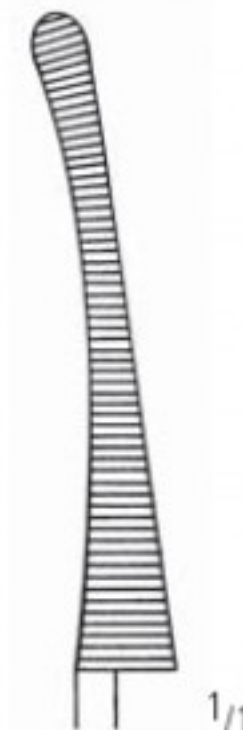

AA 071/07
7,5 cm/3"

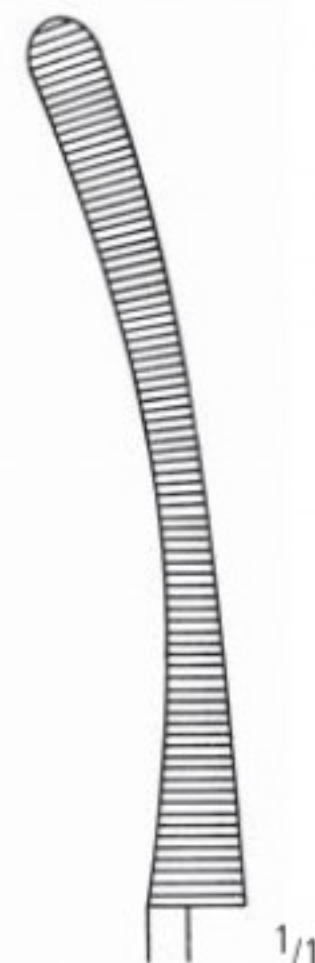

AA 071/09
9,0 cm/3 1/2"

Arterienklemmen
 Artery Forceps
 Pinzas hemostáticas
 Pincas hémostatiques
 Pinze emostatiche

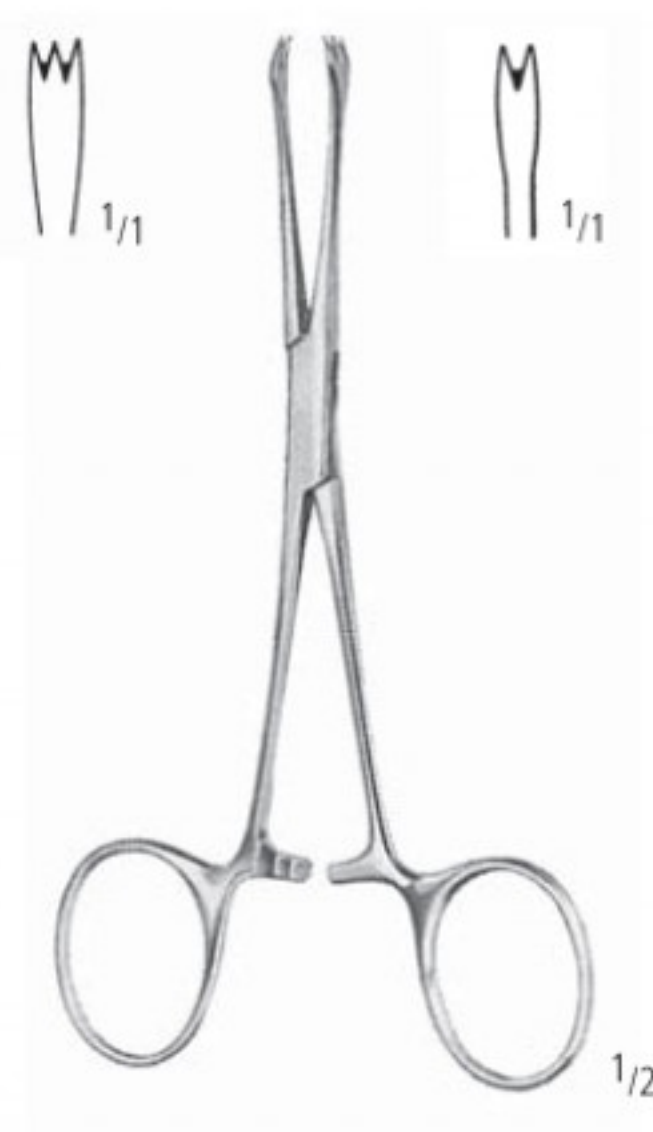

CHAPUT
 AA 072/02
 13,0 cm/5"



TUFFIER
 AA 072/04
 13,0 cm/5"

KLEMMEN HEMOSTATS PINZAS HEMOSTATICAS PINCES HEMOSTATIQUES PINZE EMOSTATICHE

Arterienklemmen
 Artery Forceps
 Pinzas hemostáticas
 Pincés hémostatiques
 Pinze emostatiche

AA
 AB
 AC
 AD
 AE
 AF
 AK
 AL
 AO
 KA
 KK
 X

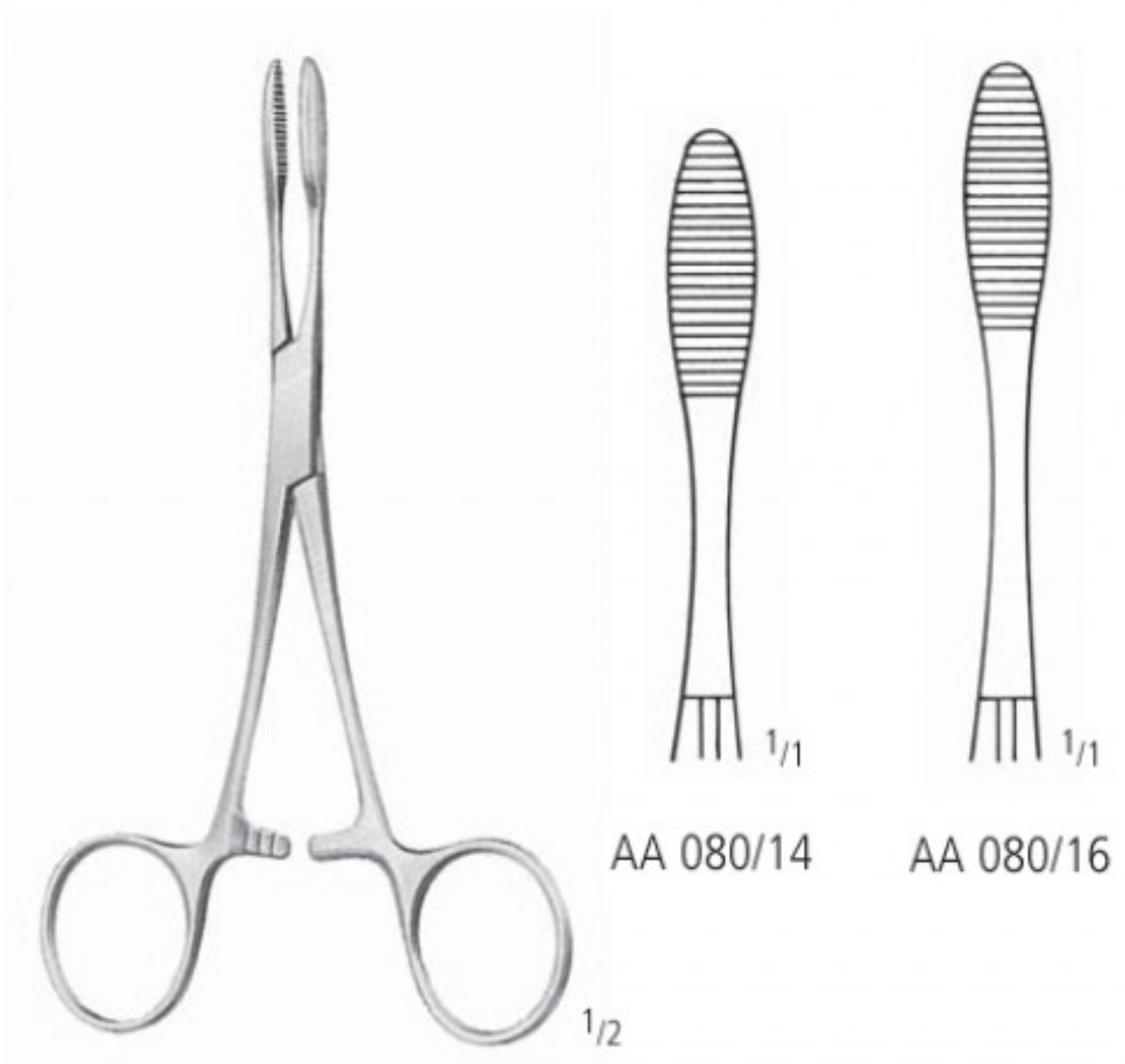

PEAN
 14,0 cm/5½" AA 080/14
 16,0 cm/6¼" AA 080/16

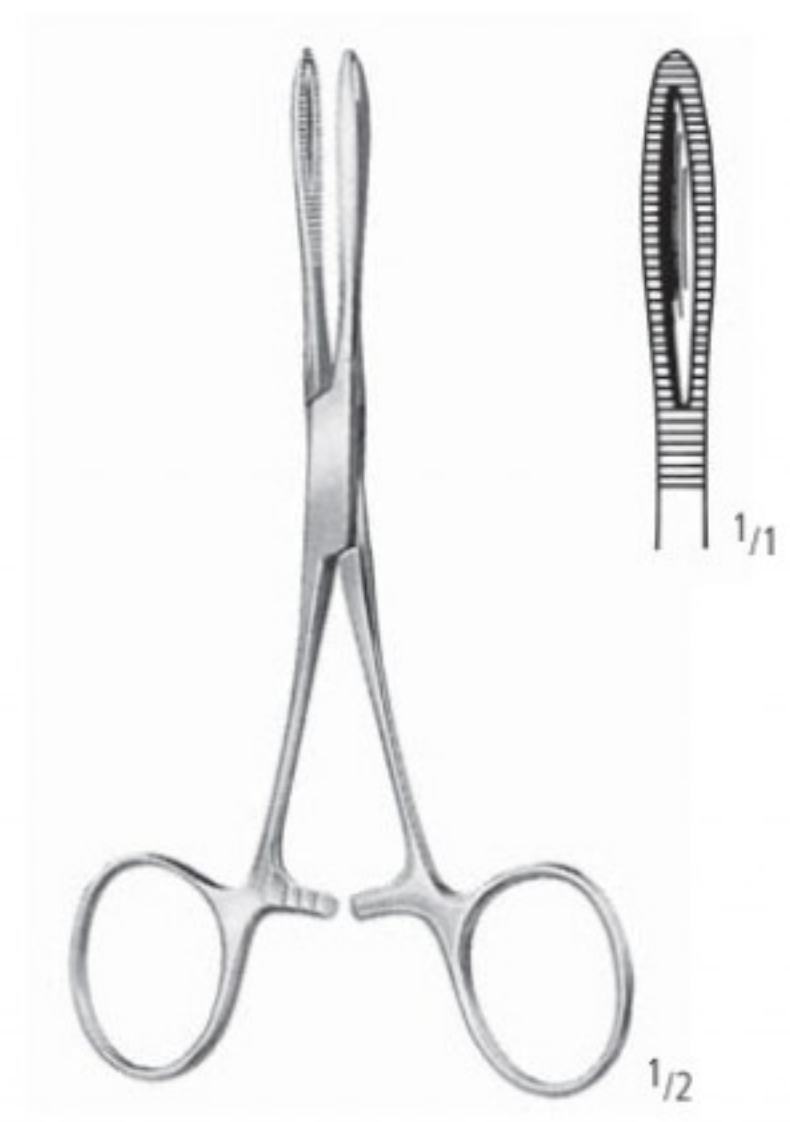

KROENLEIN
 AA 082/13
 13,0 cm/5"

AA

KLEMMEN HEMOSTATS PINZAS HEMOSTATICAS PINCES HEMOSTATIQUES PINZE EMOSTATICHE

Arterienklemmen
 Artery Forceps
 Pinzas hemostáticas
 Pincés hémostatiques
 Pinze emostatiche



SPENCER-WELLS

1/2

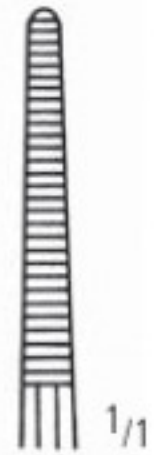

AA 110/13
 13,0 cm/5"

1/1

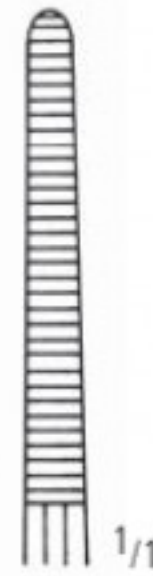

AA 110/14
 14,0 cm/5 1/2"

1/1

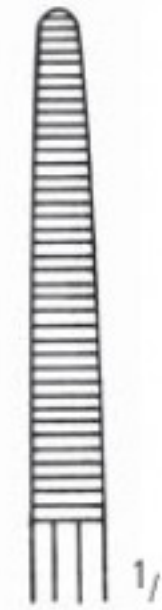

AA 110/15
 15,5 cm/6"

1/1

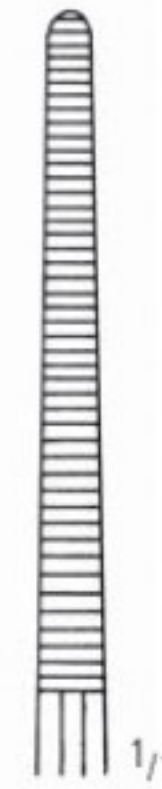

AA 110/18
 18,0 cm/7"

1/1

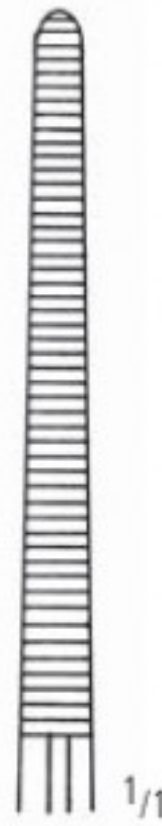

AA 110/20
 20,0 cm/8"

1/1



AA 111/13
 13,0 cm/5"

1/1

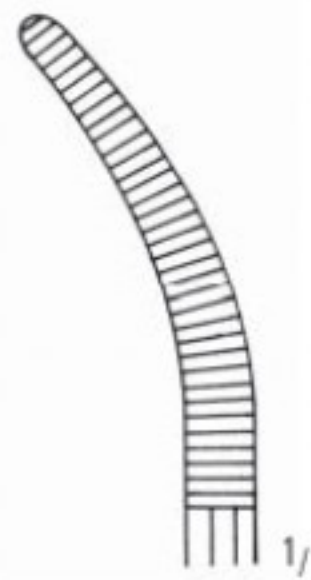

AA 111/14
 14,0 cm/5 1/2"

1/1

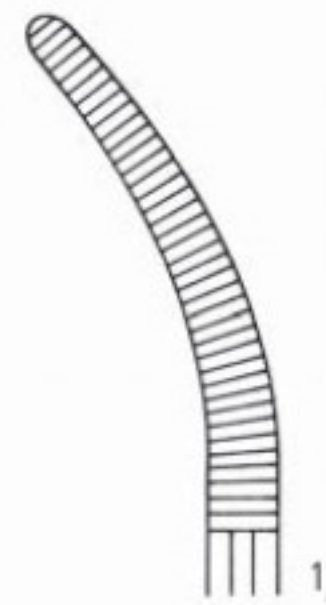

AA 111/15
 15,5 cm/6"

1/1

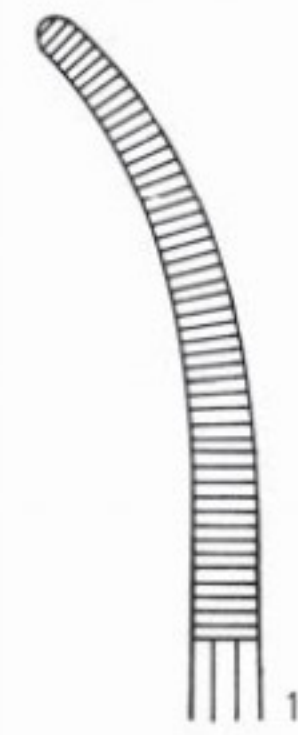

AA 111/18
 18,0 cm/7"

1/1

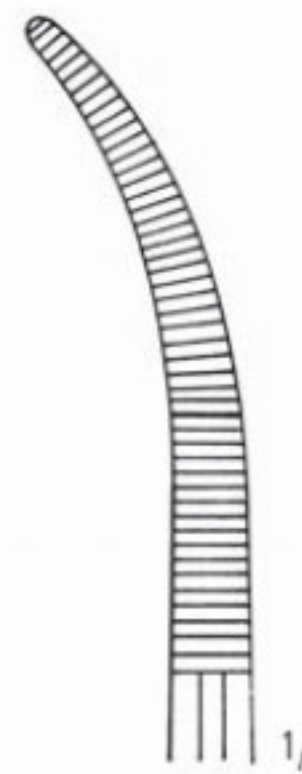

AA 111/20
 20,0 cm/8"

1/1



HARTMANN
 AA 114/10
 10,0 cm/4"

2/3



1/1

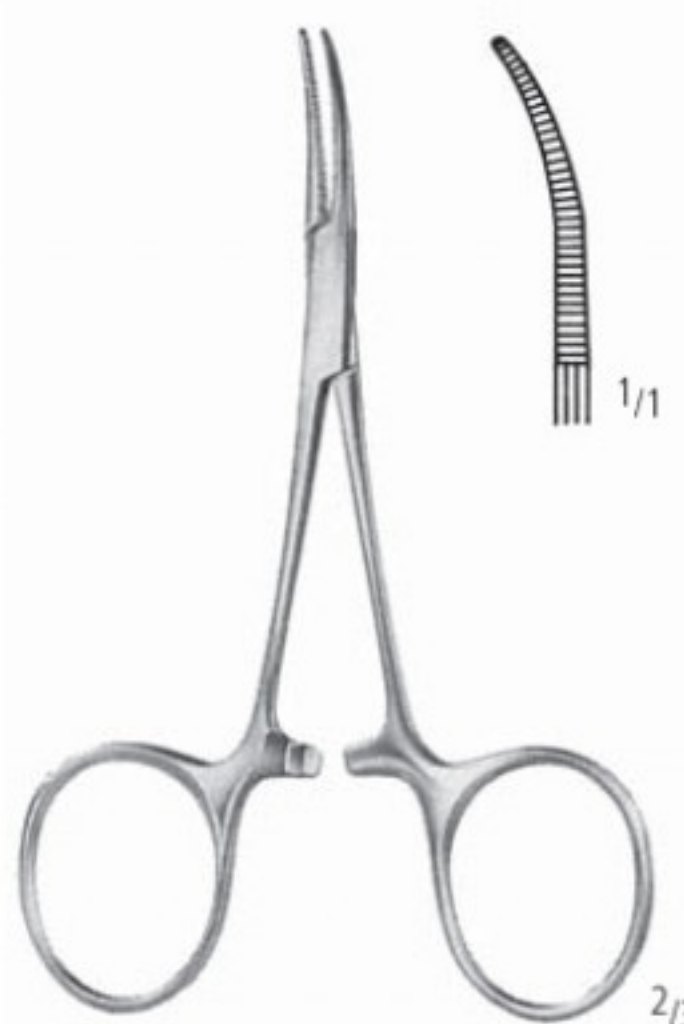

HARTMANN
 AA 115/10
 10,0 cm/4"

2/3



1/1



CARREL
 AA 116/08
 8,5 cm/3 1/2"

2/3



1/1

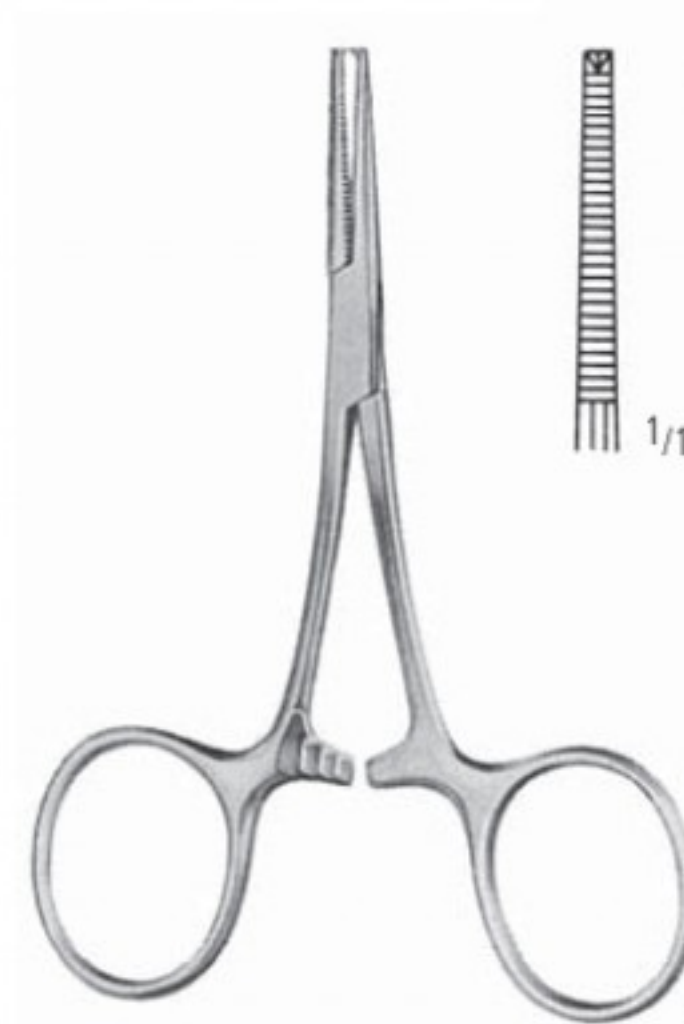

TERRIER 1:2
 AA 118/08
 8,5 cm/3 1/2"

2/3

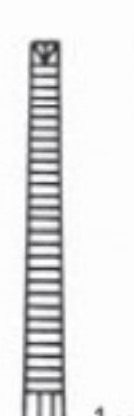

1/1



Feine Arterienklemmen
 Fine Artery Forceps
 Pinzas hemostáticas finas
 Pinces hémostatiques fines
 Pinze emostatiche fine

AA

AB

AC

AD

AE

AF

AK

AL

AO

KA

KK

X

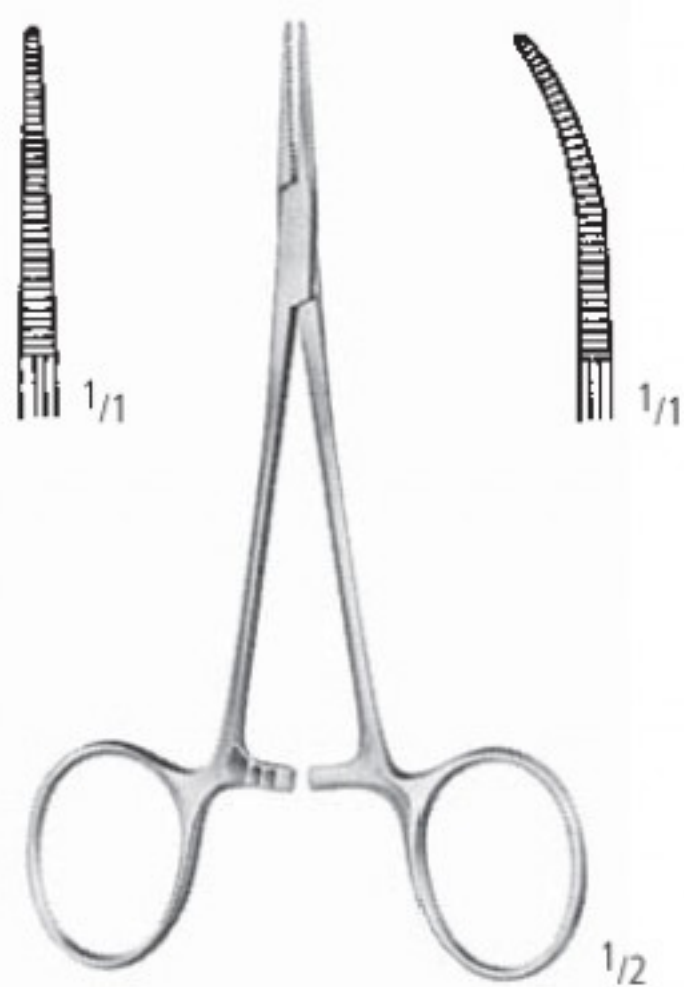

MICRO-MOSQUITO
 AA 130/10 AA 131/10
 AA 130/12 AA 131/12

10,0 cm/4"
 12,0 cm/4³/₄"

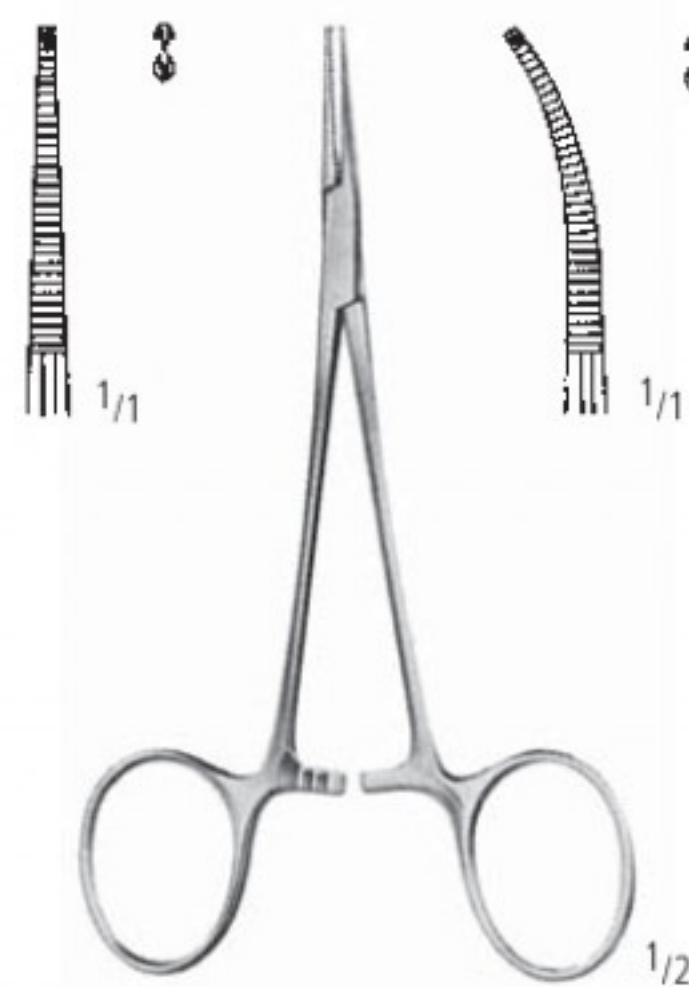

MICRO-MOSQUITO 1:2
 AA 132/10 AA 133/10
 AA 132/12 AA 133/12

WILLIAM STEWART HALSTED

was professor of surgery in the Johns Hopkins University. In 1890 he had bronze casts made of his own hands. On these casts the first surgical rubber gloves were moulded.

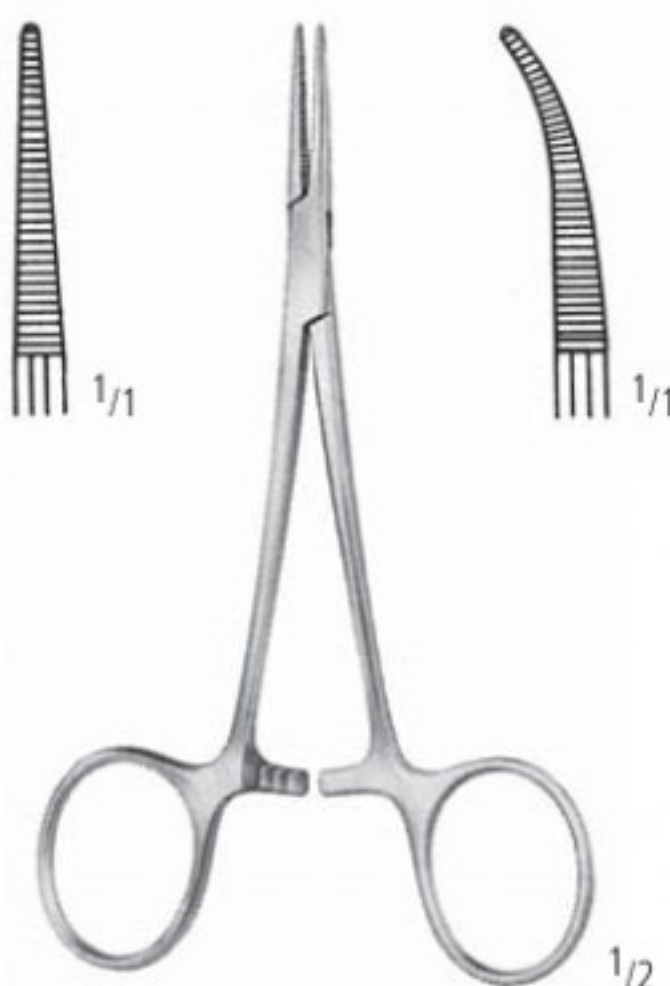

HALSTED-MOSQUITO
 AA 150/12 AA 151/12
 AA 150/14 AA 151/14

12,5 cm/5"
 14,0 cm/5¹/₂"

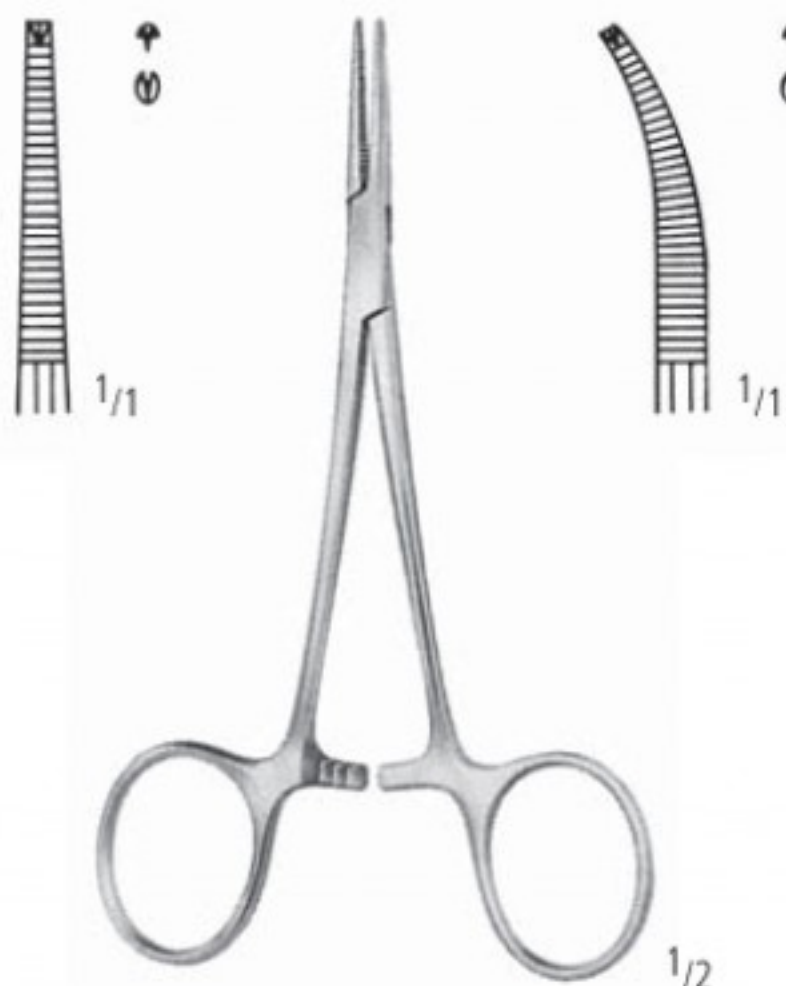

HALSTED-MOSQUITO 1:2
 AA 152/12 AA 153/12
 AA 152/14 AA 153/14

Arterienklemmen
 Artery Forceps
 Pinzas hemostáticas
 Pincas hémostatiques
 Pinze emostatiche

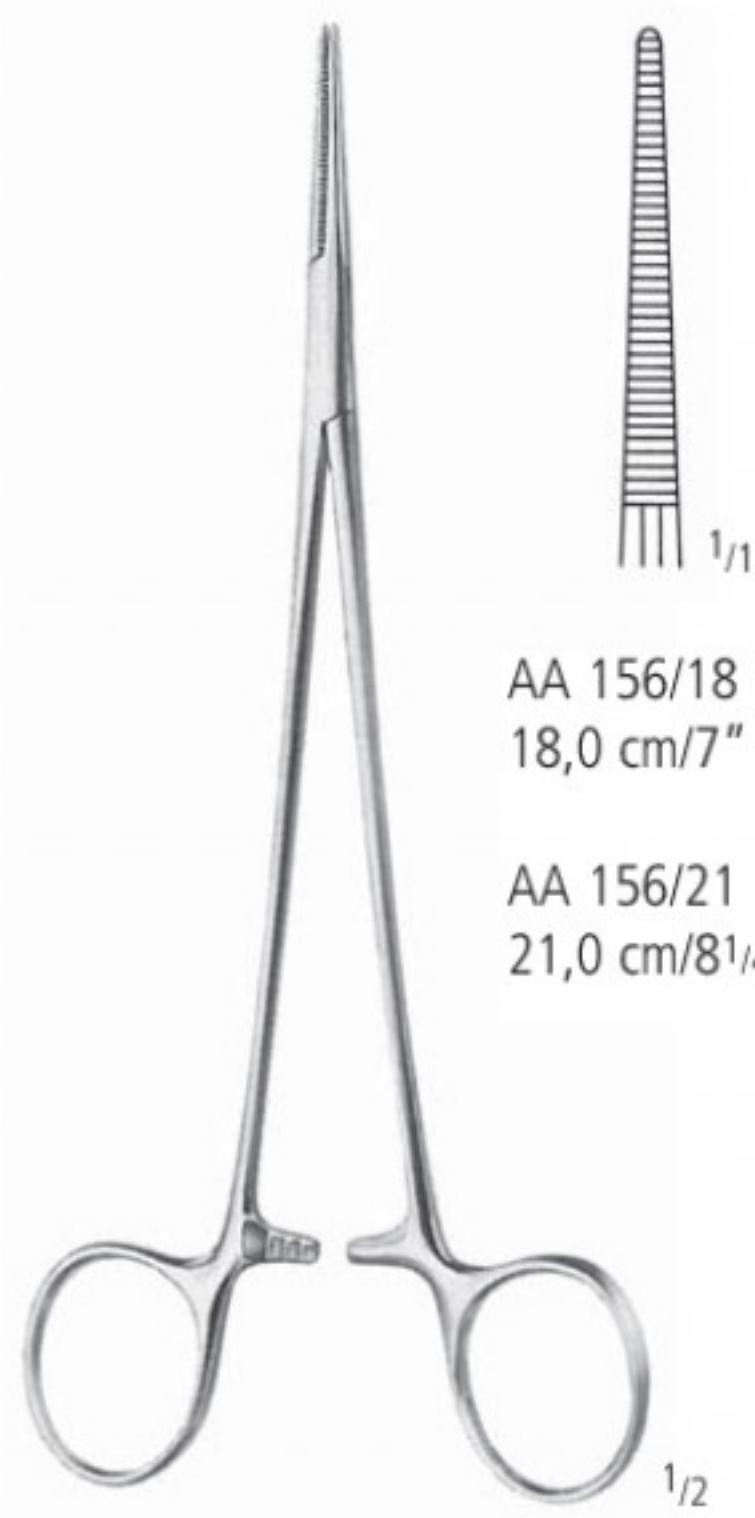

AA 156/18
 18,0 cm/7"

AA 156/21
 21,0 cm/8¹/₄"

HALSTED



AA 157/18
 18,0 cm/7"

AA 157/21
 21,0 cm/8¹/₄"

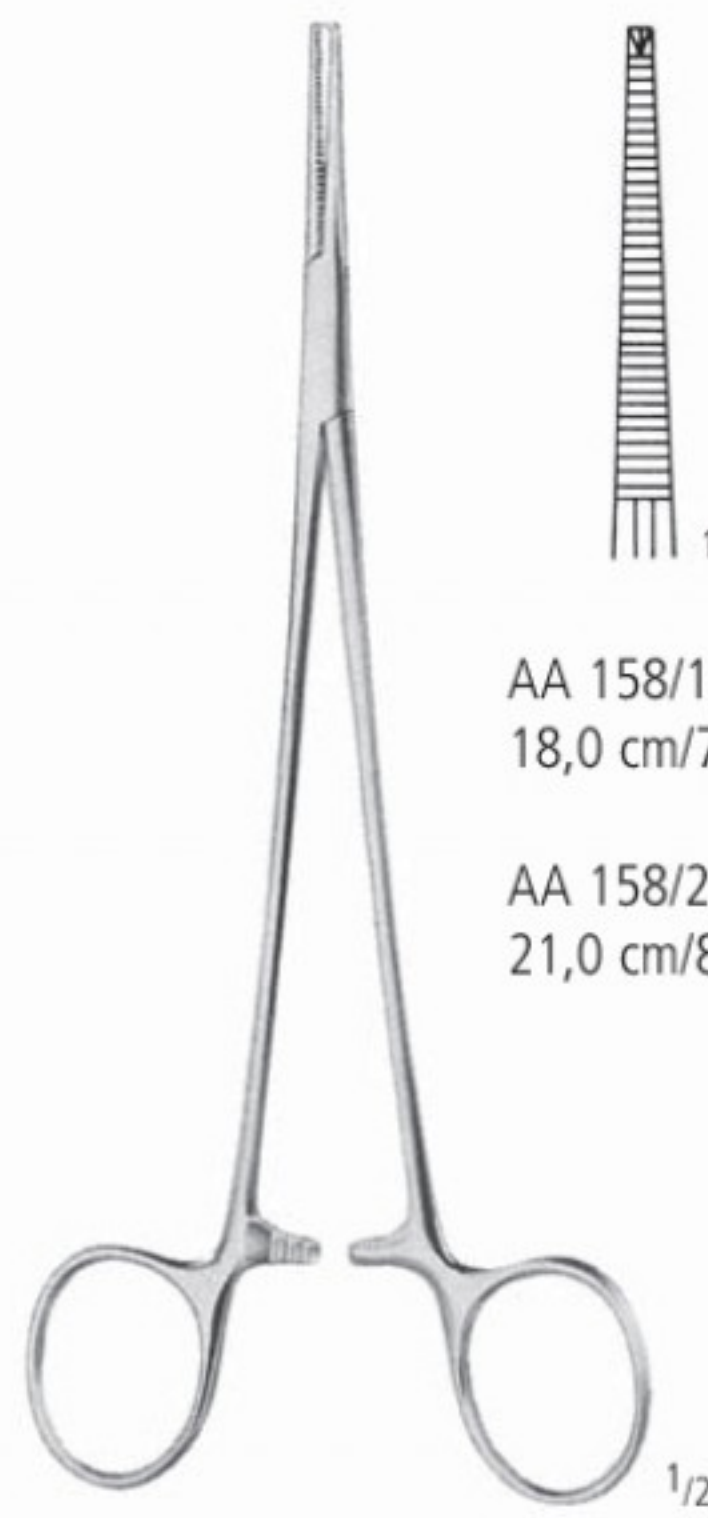

AA 158/18
 18,0 cm/7"

AA 158/21
 21,0 cm/8¹/₄"

HALSTED 1:2

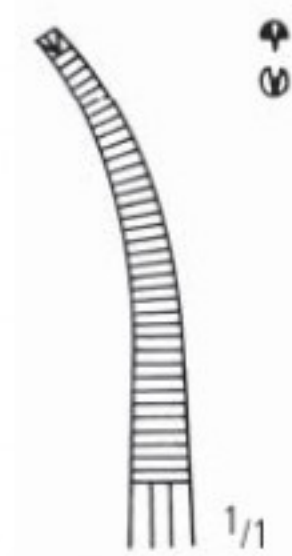

AA 159/18
 18,0 cm/7"

AA 159/21
 21,0 cm/8¹/₄"

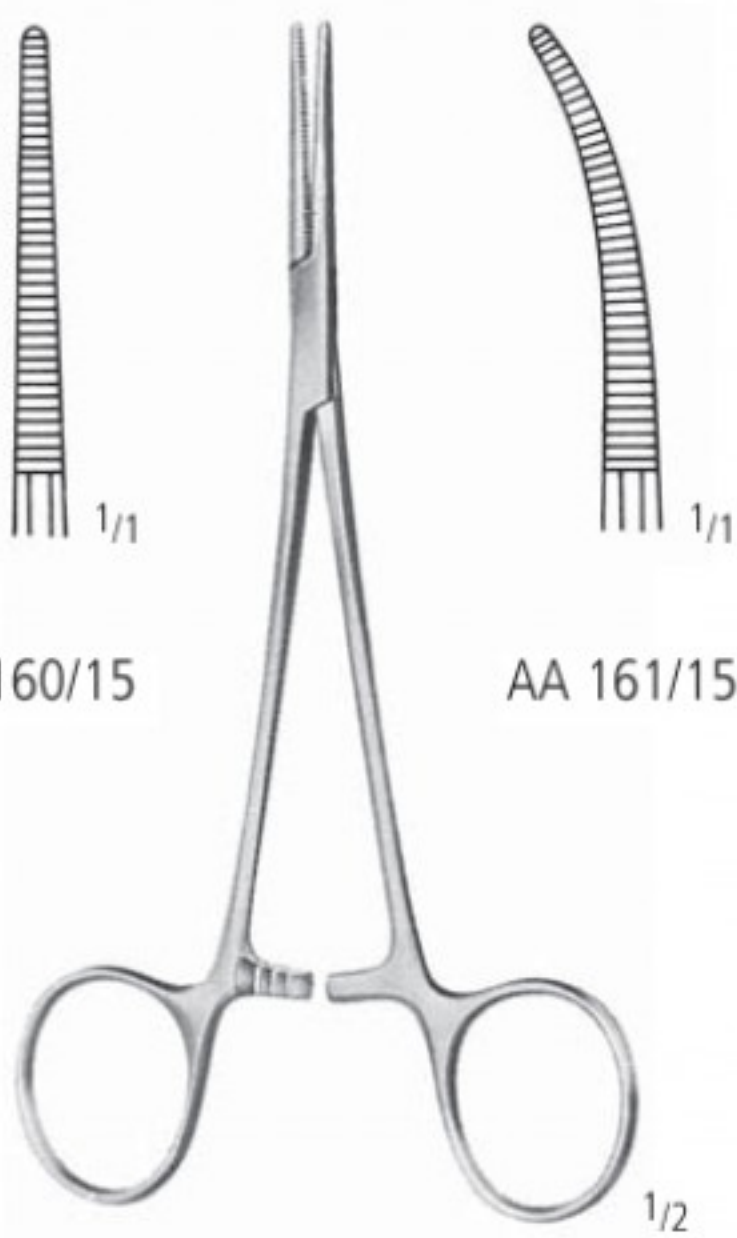

AA 160/15

AA 161/15

LERICHE
 15,0 cm/6"

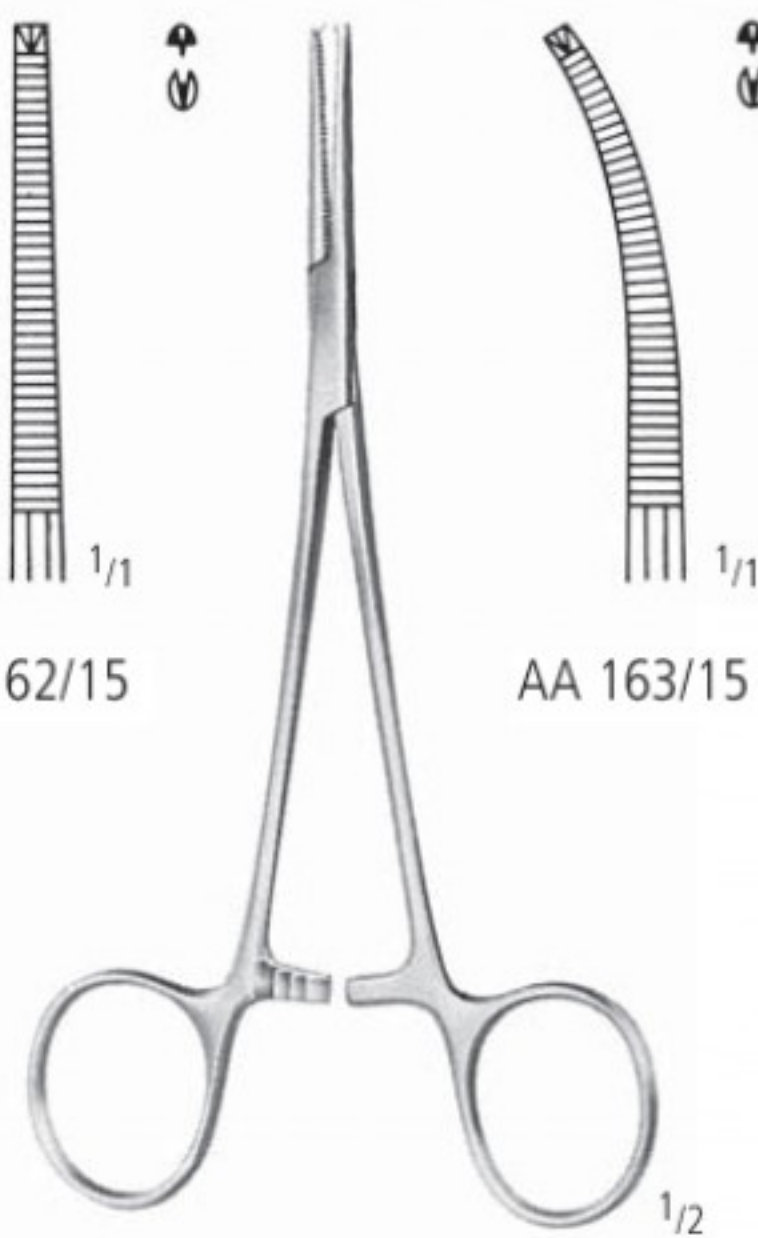

AA 162/15

AA 163/15

LERICHE 1:2
 15,0 cm/6"

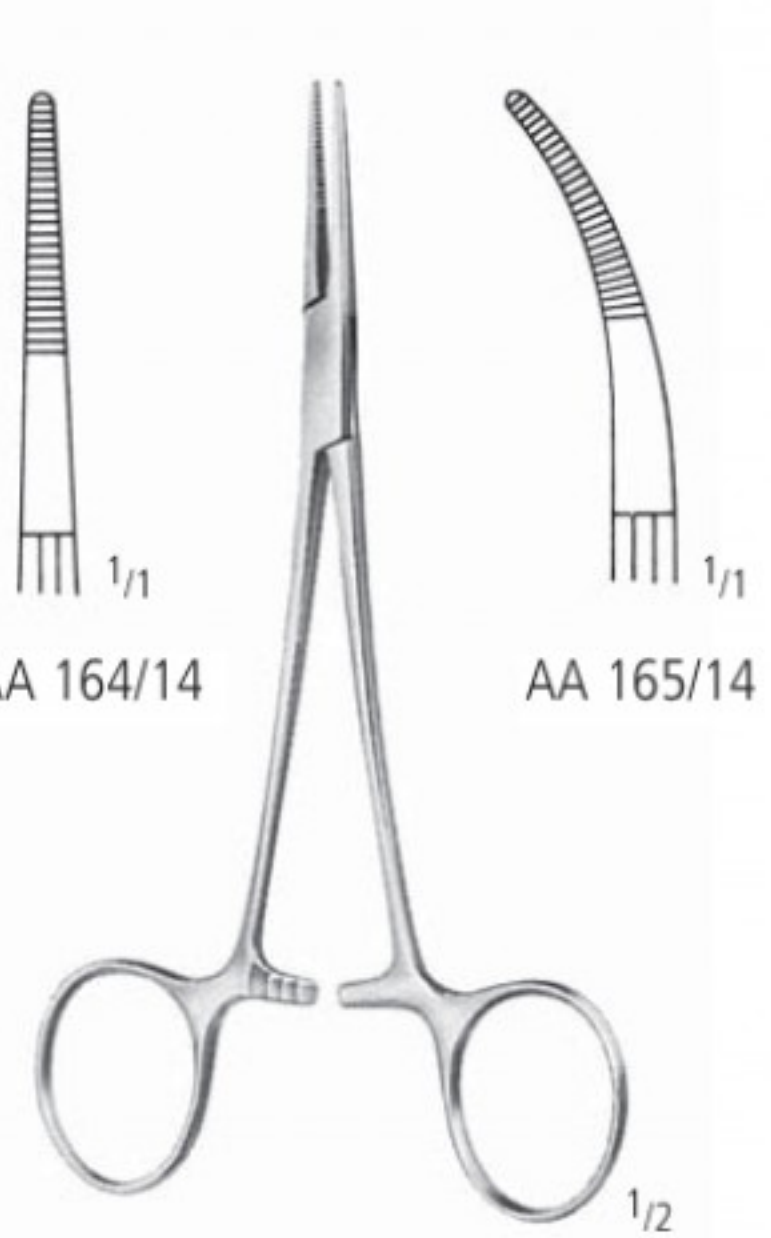

AA 164/14

AA 165/14

PROVIDENCE-HOSPITAL
 14,0 cm/5¹/₂"

KLEMMEN HEMOSTATS PINZAS HEMOSTATICAS PINCES HEMOSTATIQUES PINZE EMOSTATICHE

Arterienklemmen
 Artery Forceps
 Pinzas hemostáticas
 Pincas hémostatiques
 Pinze emostatiche

AA
 AB
 AC
 AD
 AE
 AF
 AK
 AL
 AO
 KA
 KK
 X

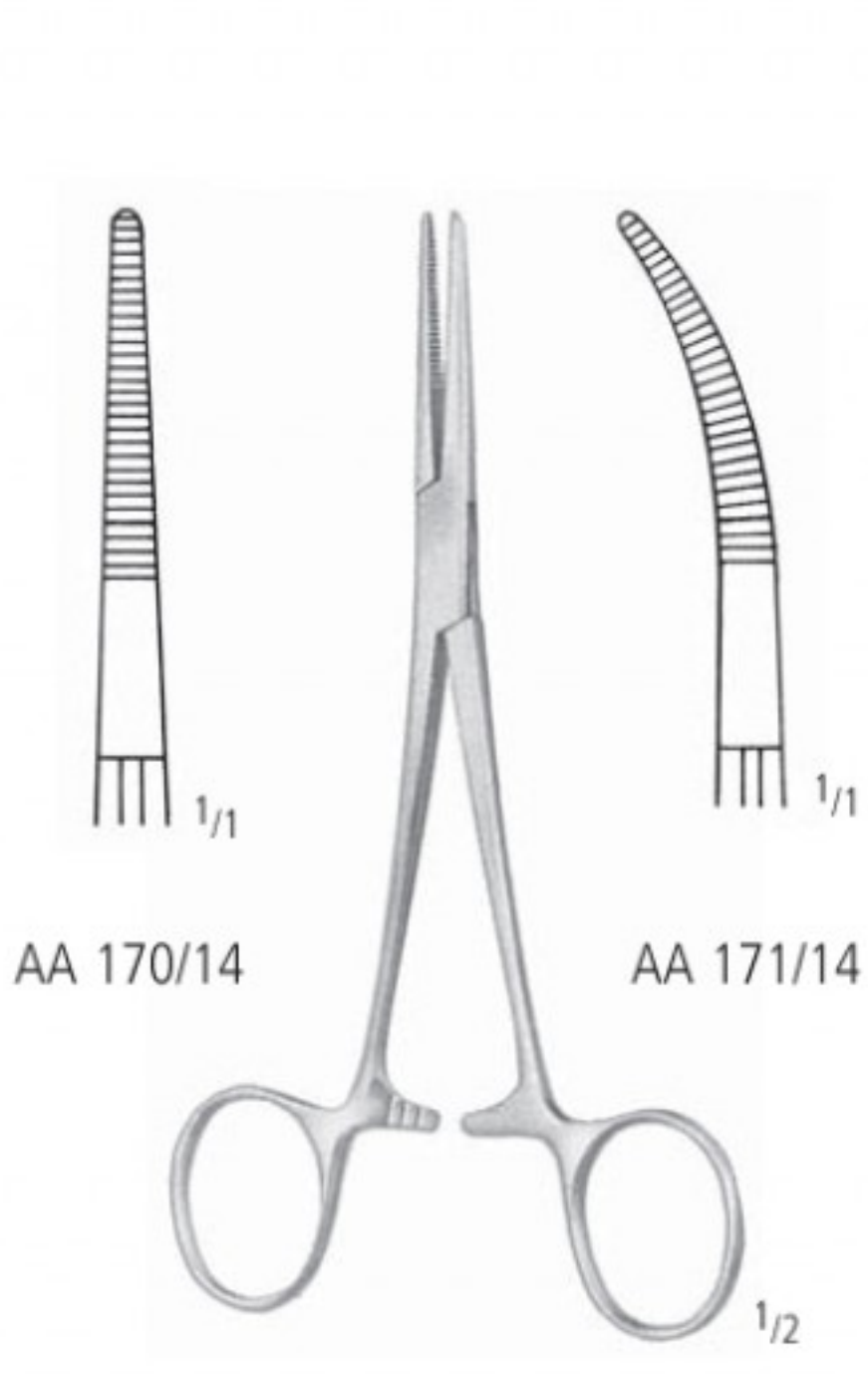

KELLY
 14,0 cm/5 1/2"

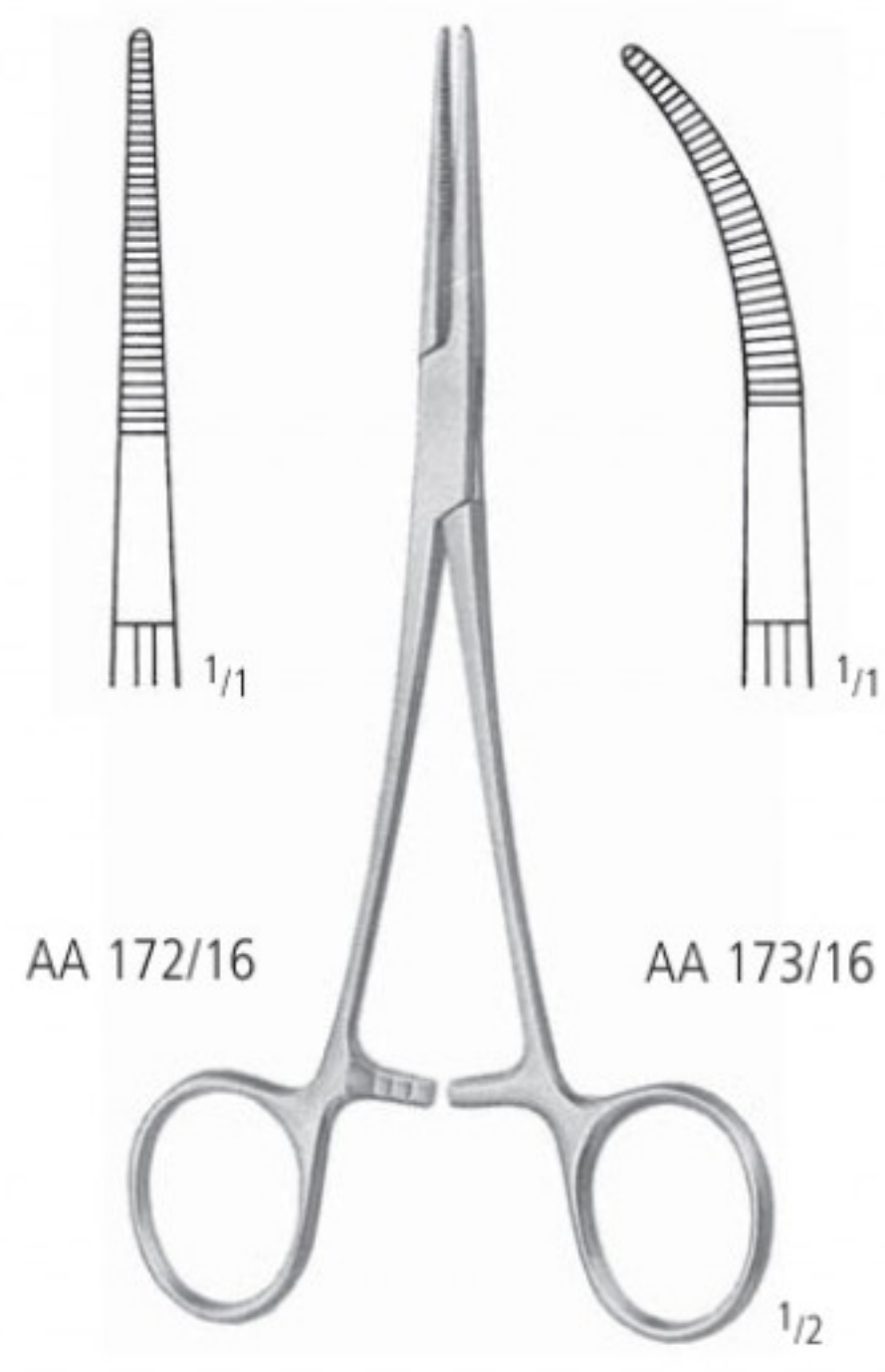

KELLY-RANKIN
 16,0 cm/6 1/4"

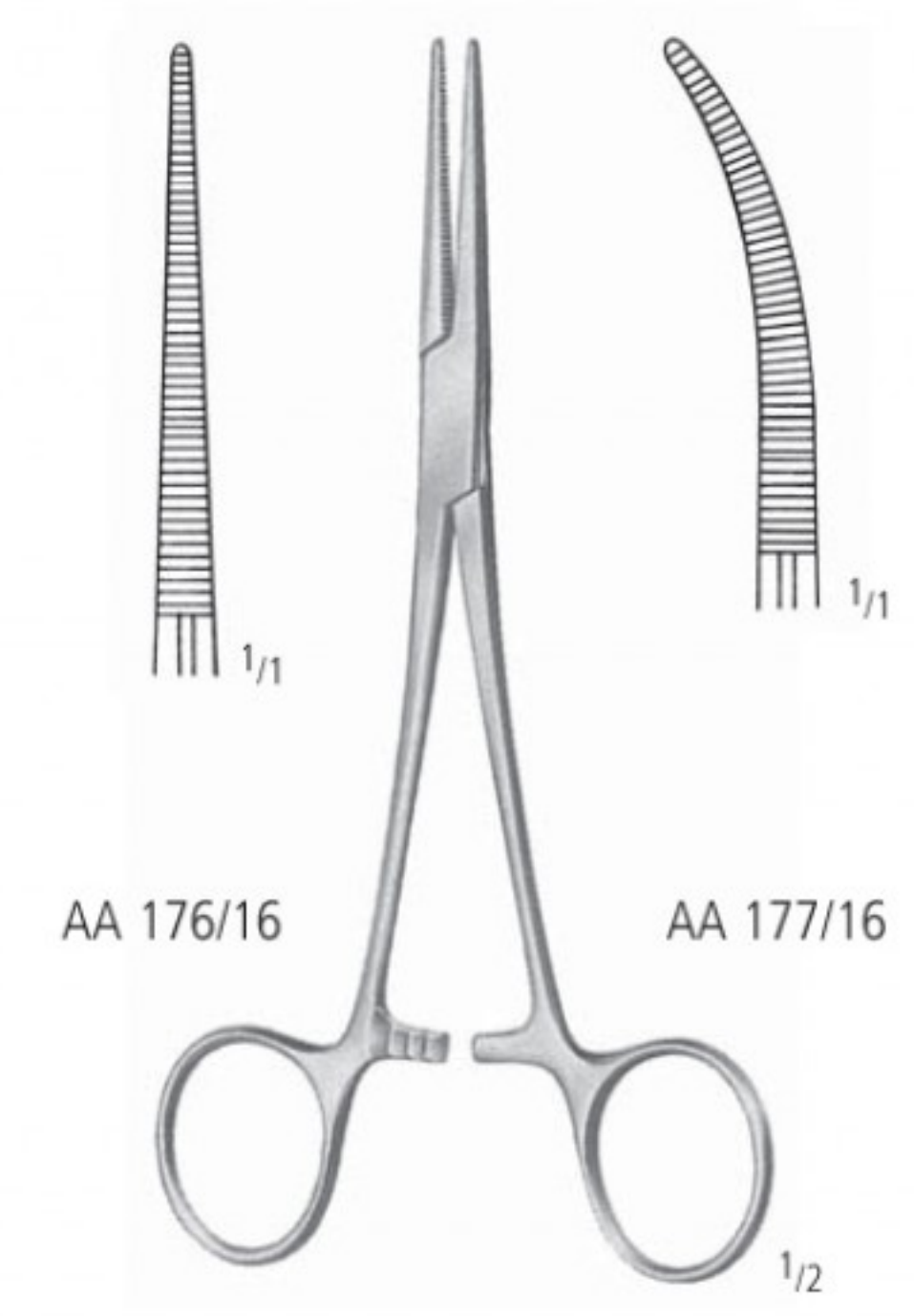

COLLER
 AA 176/14 14,0 cm/5 1/2" AA 177/14
 AA 176/16 16,0 cm/6 1/4" AA 177/16

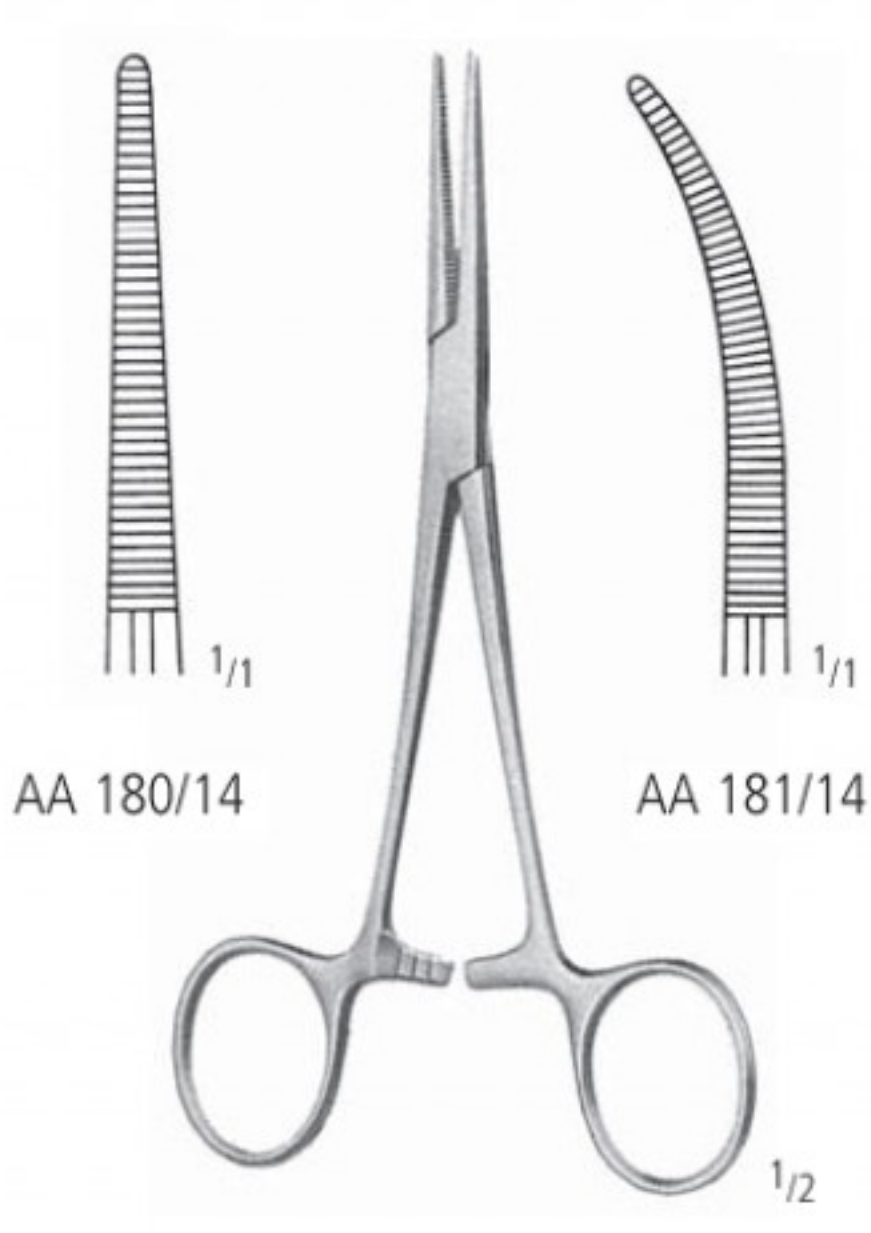

CRILE
 14,0 cm/5 1/2"

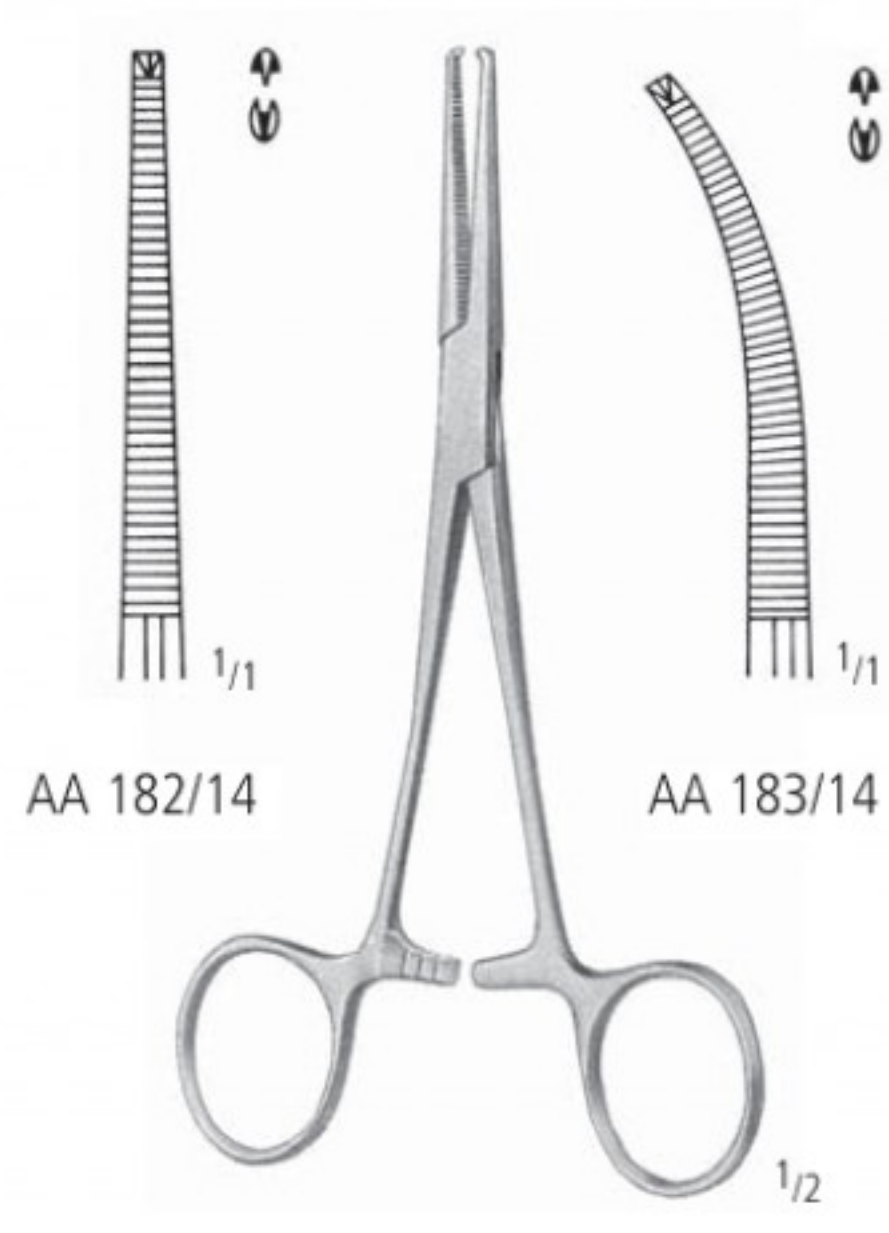

CRILE 1:2
 14,0 cm/5 1/2"

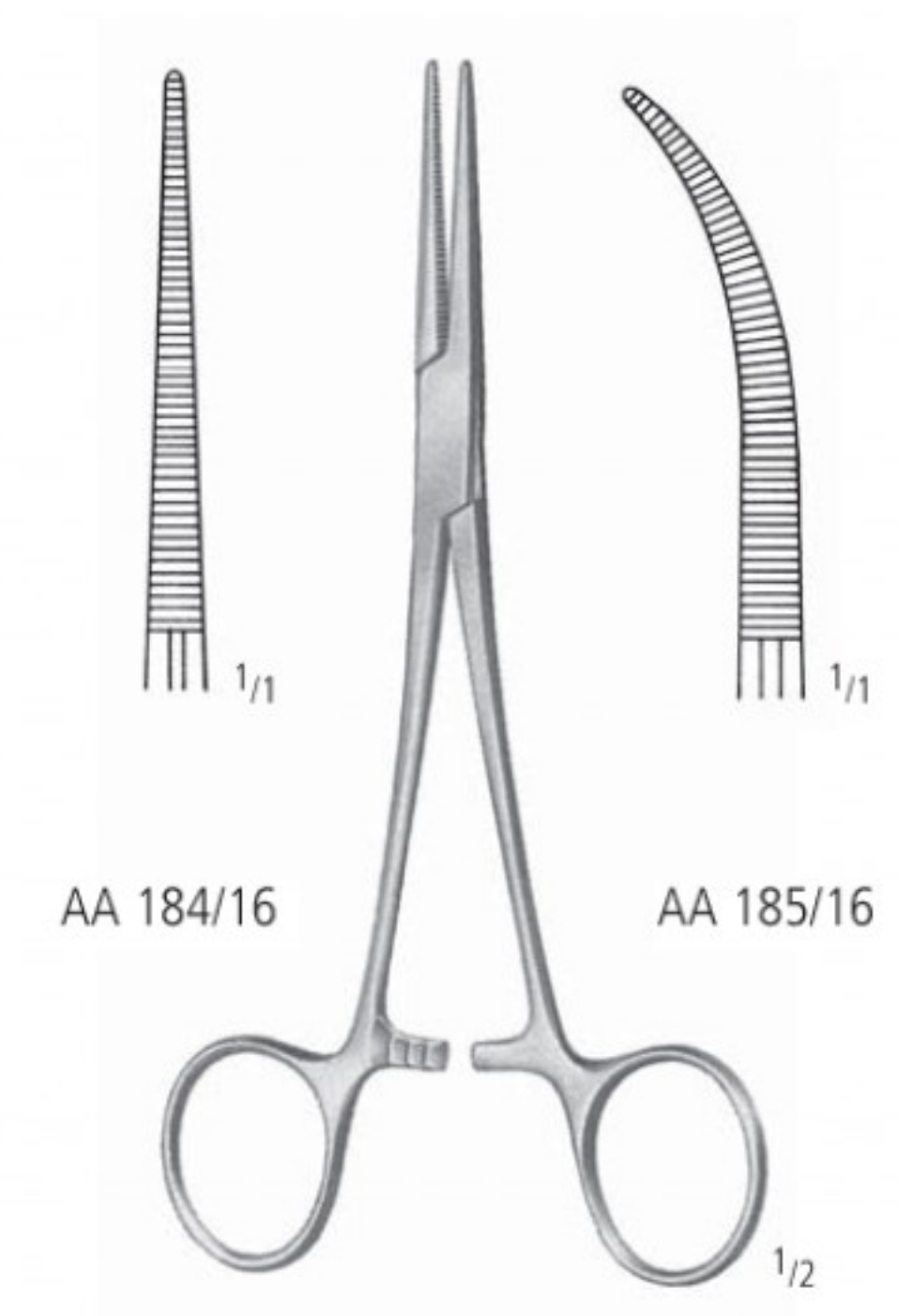

CRILE-RANKIN
 16,0 cm/6 1/4"

Arterienklemmen
 Artery Forceps
 Pinzas hemostáticas
 Pincés hémostatiques
 Pinze emostatiche

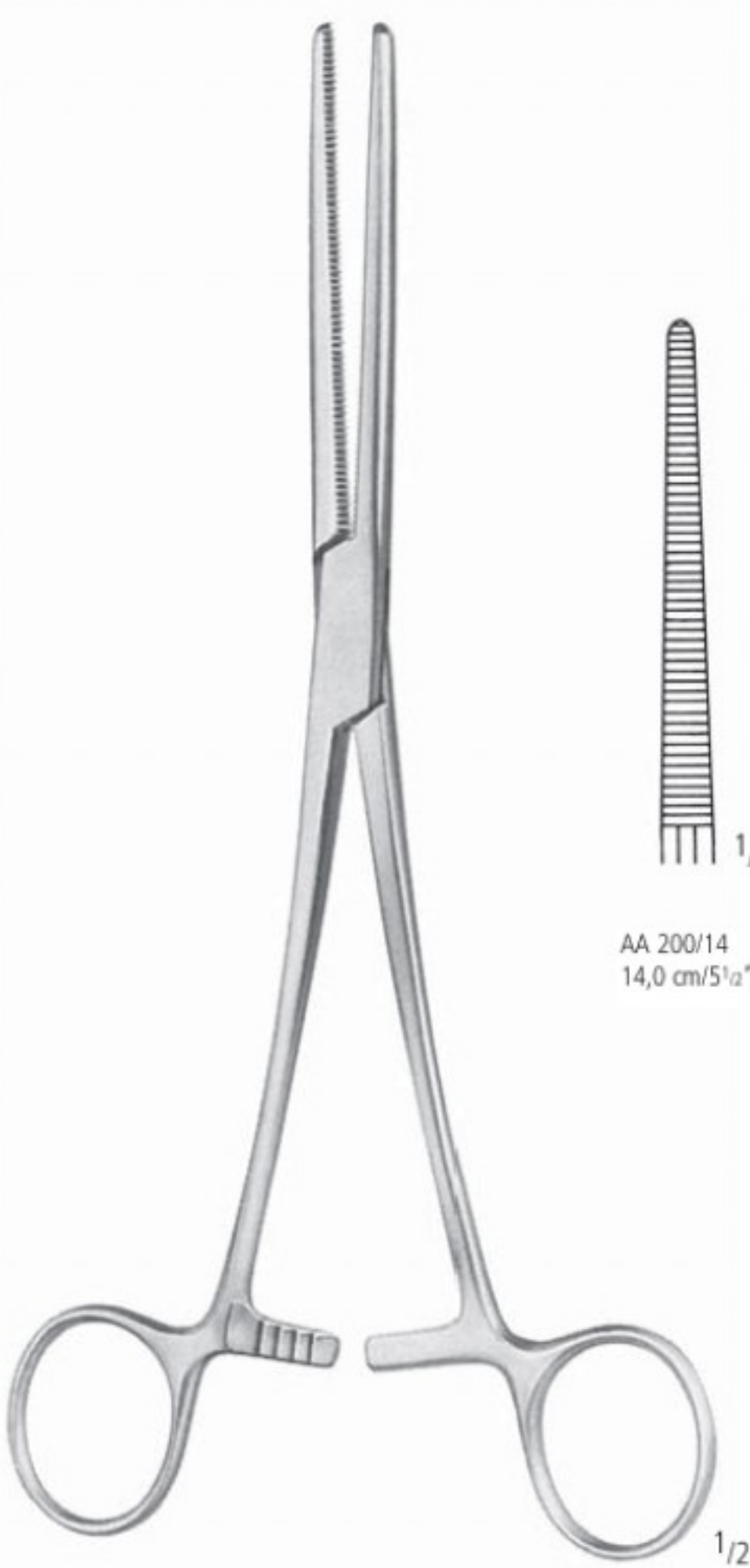

ROCHESTER-PEAN

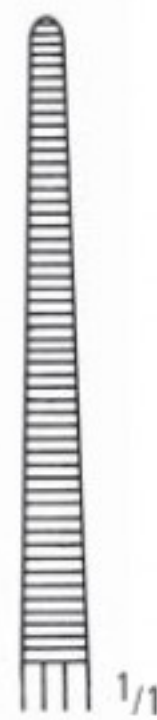

AA 200/14
14,0 cm/5½"

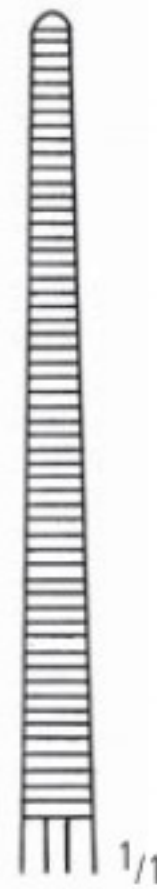

AA 200/16
16,0 cm/6¼"

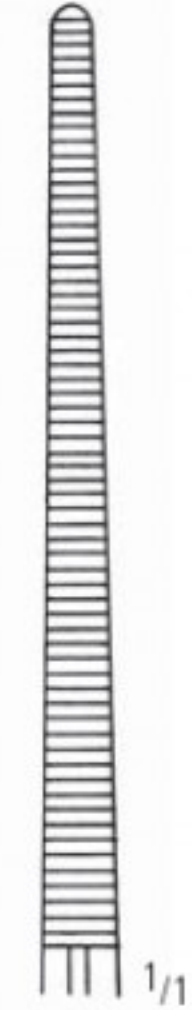

AA 200/18
18,0 cm/7"

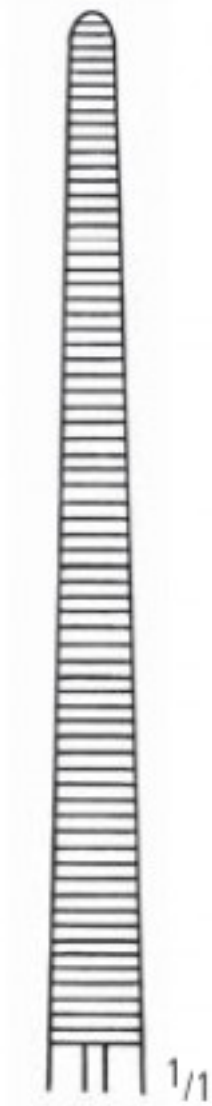

AA 200/20
20,0 cm/8"

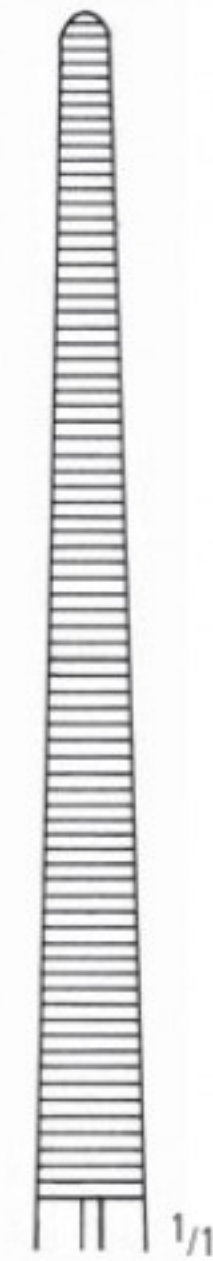

AA 200/22
22,0 cm/8¾"

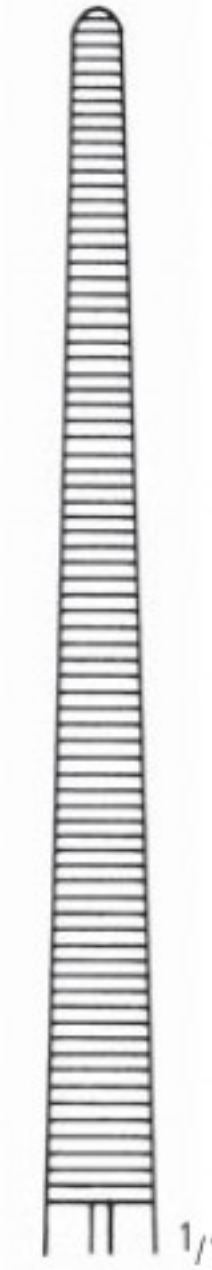

AA 200/24
24,0 cm/9½"

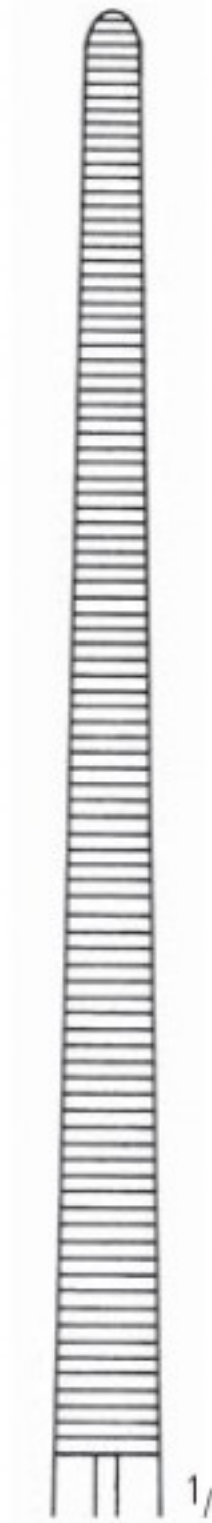

AA 200/26
26,0 cm/10¼"

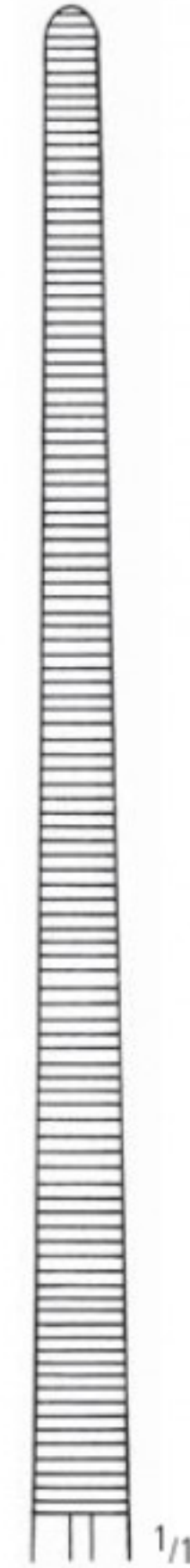

AA 200/30
30,0 cm/12"

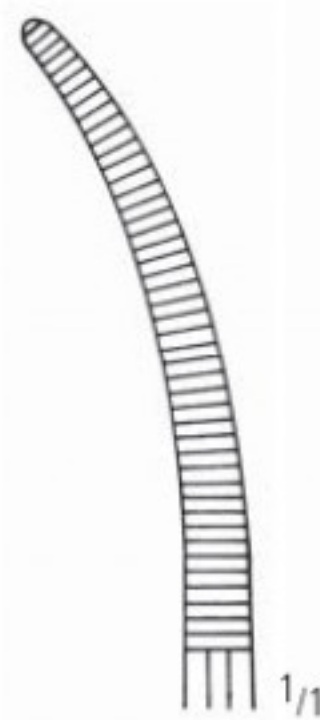

AA 201/14
14,0 cm/5½"

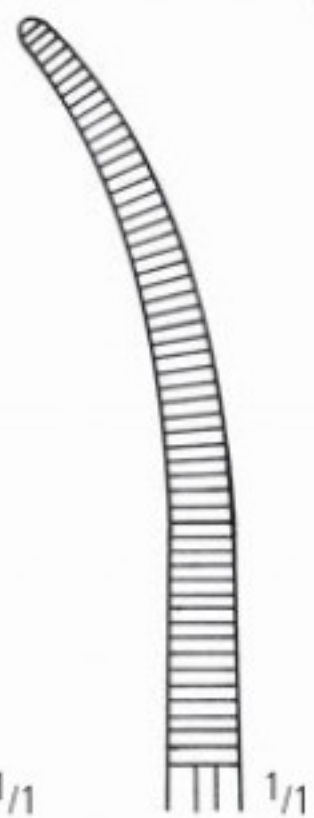

AA 201/16
16,0 cm/6¼"

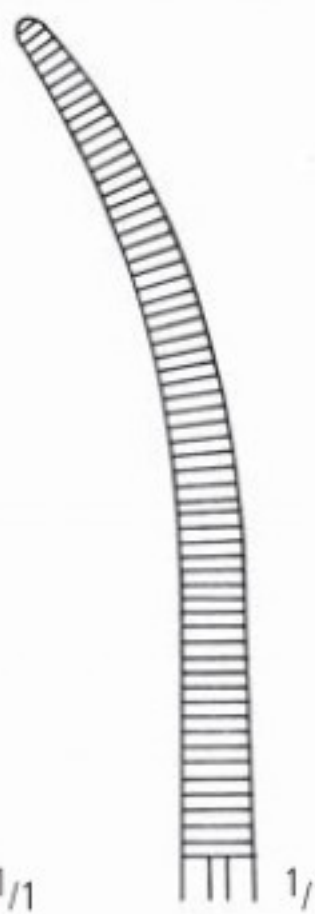

AA 201/18
18,0 cm/7"

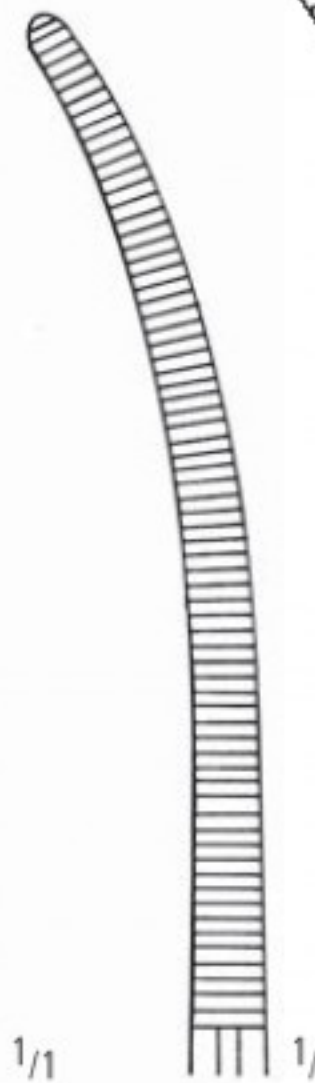

AA 201/20
20,0 cm/8"

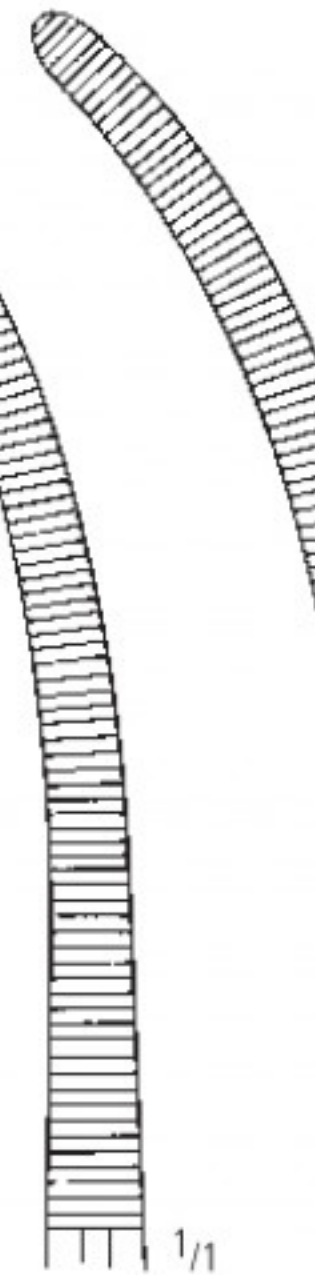

AA 201/22
22,0 cm/8¾"



AA 201/24
24,0 cm/9½"



AA 201/26
26,0 cm/10¼"



AA 201/30
30,0 cm/12"

KLEMMEN HEMOSTATS PINZAS HEMOSTATICAS PINCES HEMOSTATIQUES PINZE EMOSTATICHE

Arterienklemmen
 Artery Forceps
 Pinzas hemostáticas
 Pincas hémostatiques
 Pinze emostatiche

AA
 AB
 AC
 AD
 AE
 AF
 AG
 AH
 AI
 AJ
 AK
 AL
 AM
 AN
 AO
 AP
 AQ
 AR
 AS
 AT
 AU
 AV
 AW
 AX
 AY
 AZ
 BA
 BB
 BC
 BD
 BE
 BF
 BG
 BH
 BI
 BJ
 BK
 BL
 BM
 BN
 BO
 BP
 BQ
 BR
 BS
 BT
 BU
 BV
 BW
 BX
 BY
 BZ
 CA
 CB
 CC
 CD
 CE
 CF
 CG
 CH
 CI
 CJ
 CK
 CL
 CM
 CN
 CO
 CP
 CQ
 CR
 CS
 CT
 CU
 CV
 CW
 CX
 CY
 CZ
 DA
 DB
 DC
 DD
 DE
 DF
 DG
 DH
 DI
 DJ
 DK
 DL
 DM
 DN
 DO
 DP
 DQ
 DR
 DS
 DT
 DU
 DV
 DW
 DX
 DY
 DZ
 EA
 EB
 EC
 ED
 EE
 EF
 EG
 EH
 EI
 EJ
 EK
 EL
 EM
 EN
 EO
 EP
 EQ
 ER
 ES
 ET
 EU
 EV
 EW
 EX
 EY
 EZ
 FA
 FB
 FC
 FD
 FE
 FF
 FG
 FH
 FI
 FJ
 FK
 FL
 FM
 FN
 FO
 FP
 FQ
 FR
 FS
 FT
 FU
 FV
 FW
 FX
 FY
 FZ
 GA
 GB
 GC
 GD
 GE
 GF
 GG
 GH
 GI
 GJ
 GK
 GL
 GM
 GN
 GO
 GP
 GQ
 GR
 GS
 GT
 GU
 GV
 GW
 GX
 GY
 GZ
 HA
 HB
 HC
 HD
 HE
 HF
 HG
 HH
 HI
 HJ
 HK
 HL
 HM
 HN
 HO
 HP
 HQ
 HR
 HS
 HT
 HU
 HV
 HW
 HX
 HY
 HZ
 IA
 IB
 IC
 ID
 IE
 IF
 IG
 IH
 II
 IJ
 IK
 IL
 IM
 IN
 IO
 IP
 IQ
 IR
 IS
 IT
 IU
 IV
 IW
 IX
 IY
 IZ
 JA
 JB
 JC
 JD
 JE
 JF
 JG
 JH
 JI
 JJ
 JK
 JL
 JM
 JN
 JO
 JP
 JQ
 JR
 JS
 JT
 JU
 JV
 JW
 JX
 JY
 JZ
 KA
 KB
 KC
 KD
 KE
 KF
 KG
 KH
 KI
 KJ
 KK
 KL
 KM
 KN
 KO
 KP
 KQ
 KR
 KS
 KT
 KU
 KV
 KW
 KX
 KY
 KZ
 LA
 LB
 LC
 LD
 LE
 LF
 LG
 LH
 LI
 LJ
 LK
 LL
 LM
 LN
 LO
 LP
 LQ
 LR
 LS
 LT
 LU
 LV
 LW
 LX
 LY
 LZ
 MA
 MB
 MC
 MD
 ME
 MF
 MG
 MH
 MI
 MJ
 MK
 ML
 MM
 MN
 MO
 MP
 MQ
 MR
 MS
 MT
 MU
 MV
 MW
 MX
 MY
 MZ
 NA
 NB
 NC
 ND
 NE
 NF
 NG
 NH
 NI
 NJ
 NK
 NL
 NM
 NN
 NO
 NP
 NQ
 NR
 NS
 NT
 NU
 NV
 NW
 NX
 NY
 NZ
 OA
 OB
 OC
 OD
 OE
 OF
 OG
 OH
 OI
 OJ
 OK
 OL
 OM
 ON
 OO
 OP
 OQ
 OR
 OS
 OT
 OU
 OV
 OW
 OX
 OY
 OZ
 PA
 PB
 PC
 PD
 PE
 PF
 PG
 PH
 PI
 PJ
 PK
 PL
 PM
 PN
 PO
 PP
 PQ
 PR
 PS
 PT
 PU
 PV
 PW
 PX
 PY
 PZ
 QA
 QB
 QC
 QD
 QE
 QF
 QG
 QH
 QI
 QJ
 QK
 QL
 QM
 QN
 QO
 QP
 QQ
 QR
 QS
 QT
 QU
 QV
 QW
 QX
 QY
 QZ
 RA
 RB
 RC
 RD
 RE
 RF
 RG
 RH
 RI
 RJ
 RK
 RL
 RM
 RN
 RO
 RP
 RQ
 RR
 RS
 RT
 RU
 RV
 RW
 RX
 RY
 RZ
 SA
 SB
 SC
 SD
 SE
 SF
 SG
 SH
 SI
 SJ
 SK
 SL
 SM
 SN
 SO
 SP
 SQ
 SR
 SS
 ST
 SU
 SV
 SW
 SX
 SY
 SZ
 TA
 TB
 TC
 TD
 TE
 TF
 TG
 TH
 TI
 TJ
 TK
 TL
 TM
 TN
 TO
 TP
 TQ
 TR
 TS
 TT
 TU
 TV
 TW
 TX
 TY
 TZ
 UA
 UB
 UC
 UD
 UE
 UF
 UG
 UH
 UI
 UJ
 UK
 UL
 UM
 UN
 UO
 UP
 UQ
 UR
 US
 UT
 UY
 UZ
 VA
 VB
 VC
 VD
 VE
 VF
 VG
 VH
 VI
 VJ
 VK
 VL
 VM
 VN
 VO
 VP
 VQ
 VR
 VS
 VT
 VU
 VV
 VW
 VX
 VY
 VZ
 WA
 WB
 WC
 WD
 WE
 WF
 WG
 WH
 WI
 WJ
 WK
 WL
 WM
 WN
 WO
 WP
 WQ
 WR
 WS
 WT
 WU
 WV
 WW
 WX
 WY
 WZ
 XA
 XB
 XC
 XD
 XE
 XF
 XG
 XH
 XI
 XJ
 XK
 XL
 XM
 XN
 XO
 XP
 XQ
 XR
 XS
 XT
 XU
 XV
 XW
 XX
 XY
 XZ
 YA
 YB
 YC
 YD
 YE
 YF
 YG
 YH
 YI
 YJ
 YK
 YL
 YM
 YN
 YO
 YP
 YQ
 YR
 YS
 YT
 YU
 YV
 YW
 YX
 YZ
 ZA
 ZB
 ZC
 ZD
 ZE
 ZF
 ZG
 ZH
 ZI
 ZJ
 ZK
 ZL
 ZM
 ZN
 ZO
 ZP
 ZQ
 ZR
 ZS
 ZT
 ZU
 ZV
 ZW
 ZX
 ZY
 ZZ



OCHSNER-KOCHER 1:2

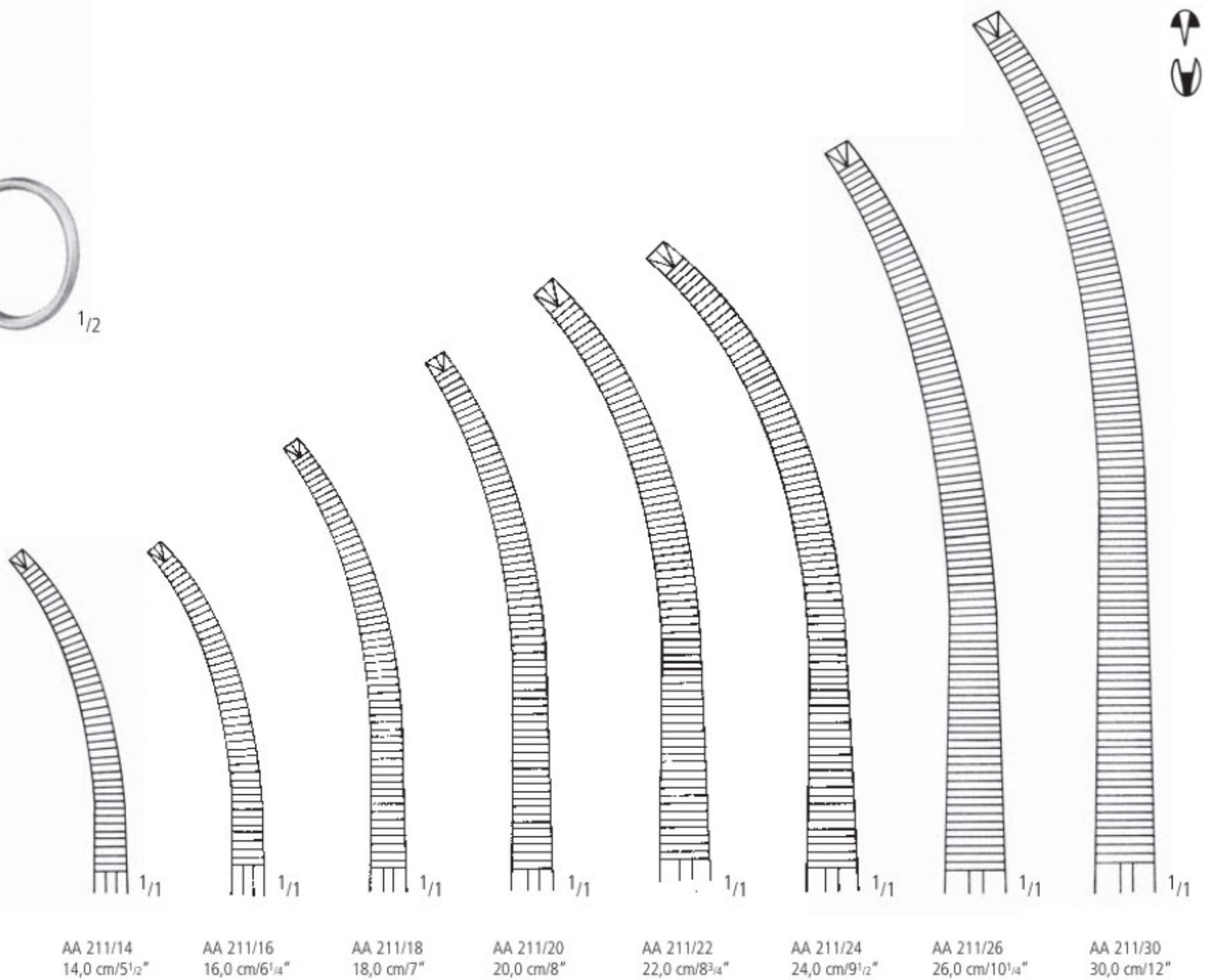
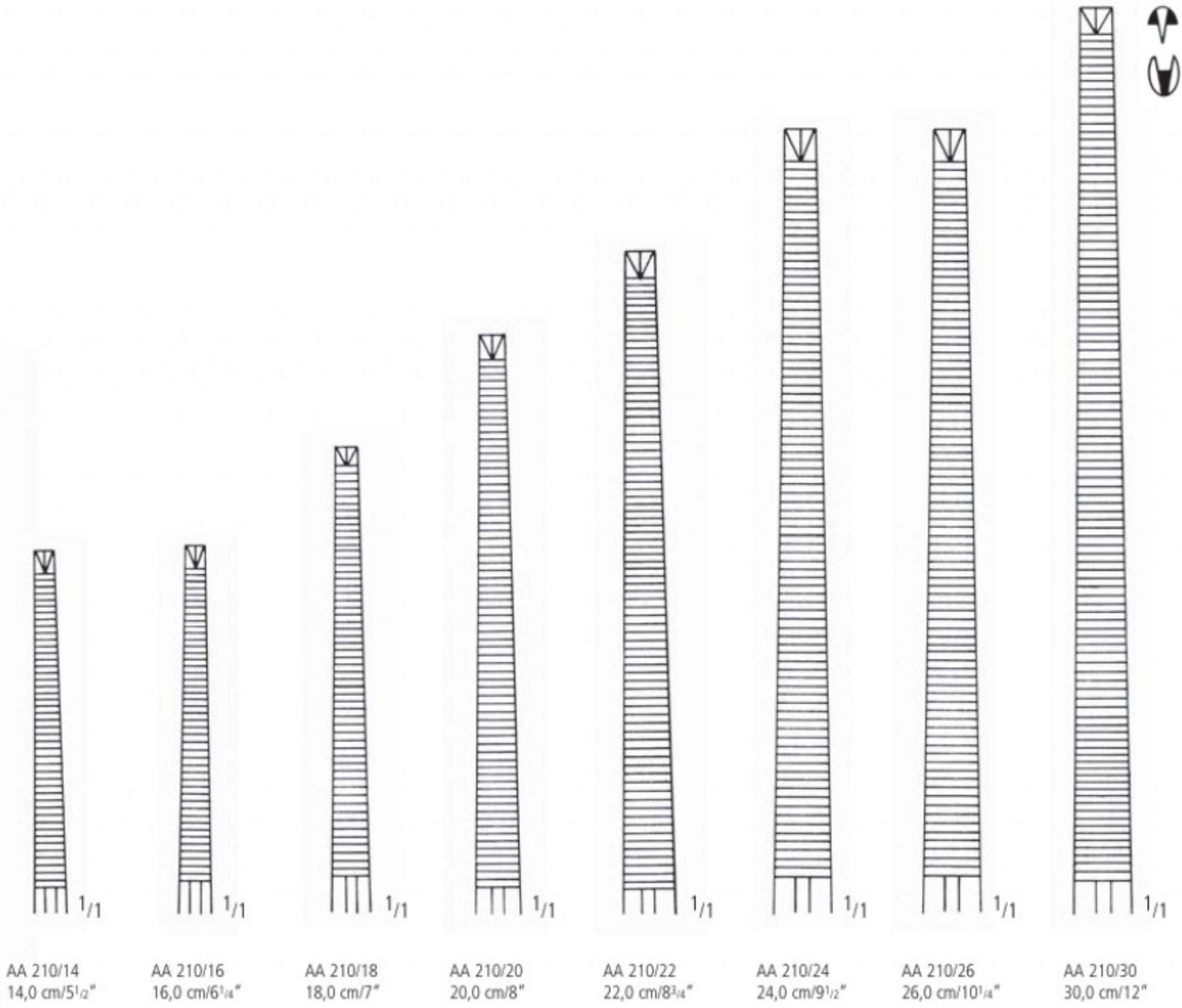

Grazile Arterienklemmen
 Delicate Artery Forceps
 Pinzas hemostáticas delgadas
 Pincas hémostatiques graciles
 Pinze emostatiche delicate

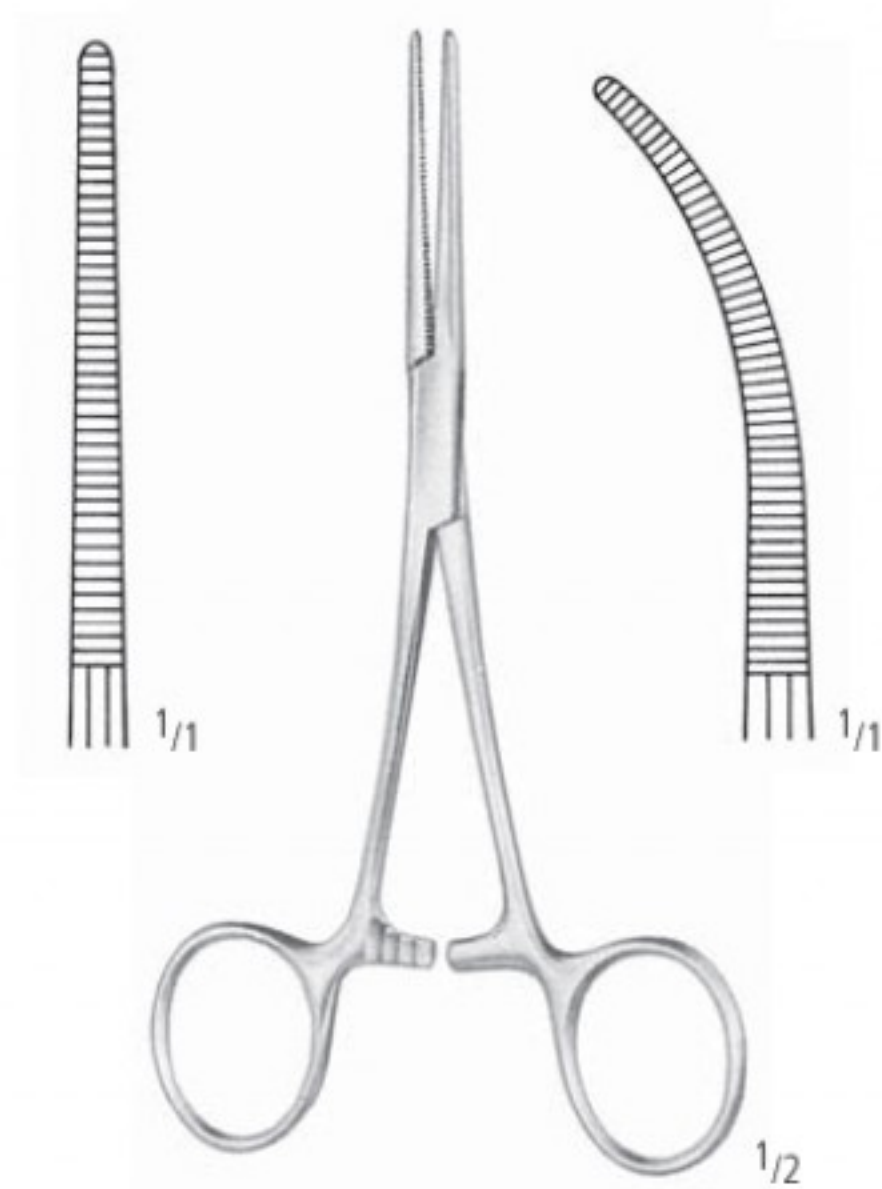

PEAN - DELICATE

AA 214/13	AA 215/13
AA 214/14	AA 215/14
AA 214/16	AA 215/16

13,0 cm/5"
 14,0 cm/5½"
 16,0 cm/6¼"

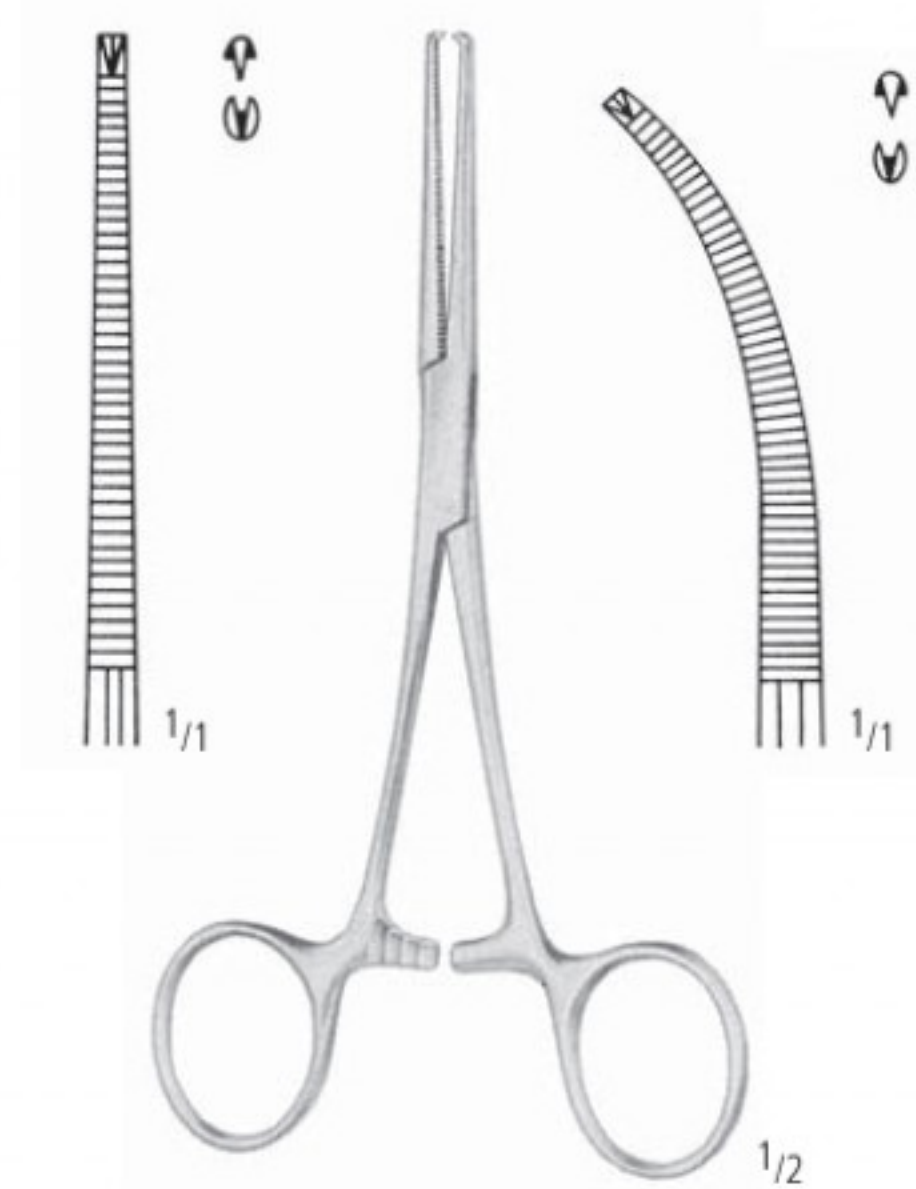

KOCHER 1:2 - DELICATE

AA 216/13	AA 217/13
AA 216/14	AA 217/14
AA 216/16	AA 217/16

JULES PEAN, born 1830, died 1898, was the most important French gynecological surgeon of his time. He studied at Paris 1860. 1864 Pean was the first surgeon in Paris to perform an ovariectomy. By the use of Pean pins he introduced forceps pressure for control of hemorrhage, thus he invented the most used surgical instrument, next to the scalpel.

ALBERT J. OCHSNER, born 1858, died 1925. He devoted much time to attending and participating in medical discussions and was member of all leading societies in his fields.

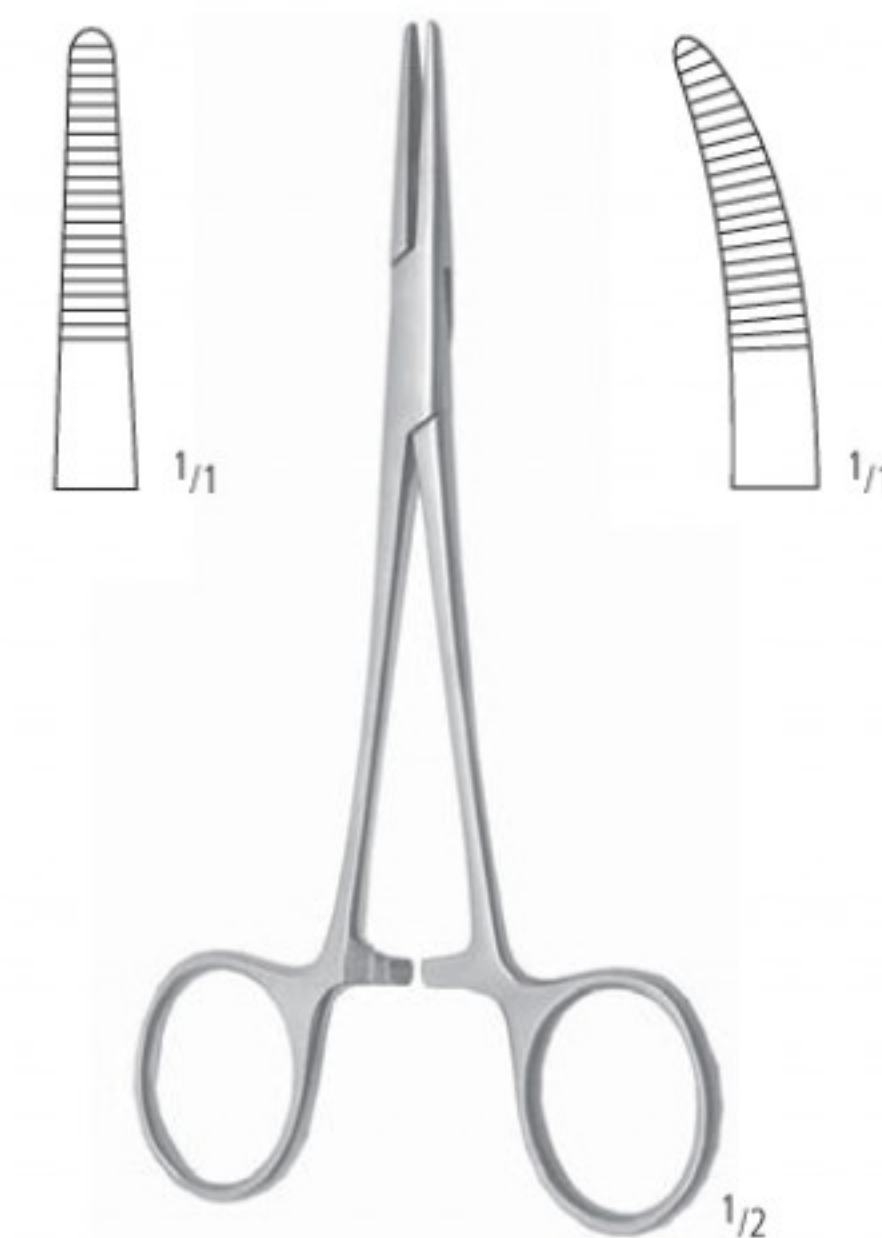

CAIRNS

AA 218/15	15,0 cm/6"	AA 219/15
-----------	------------	-----------

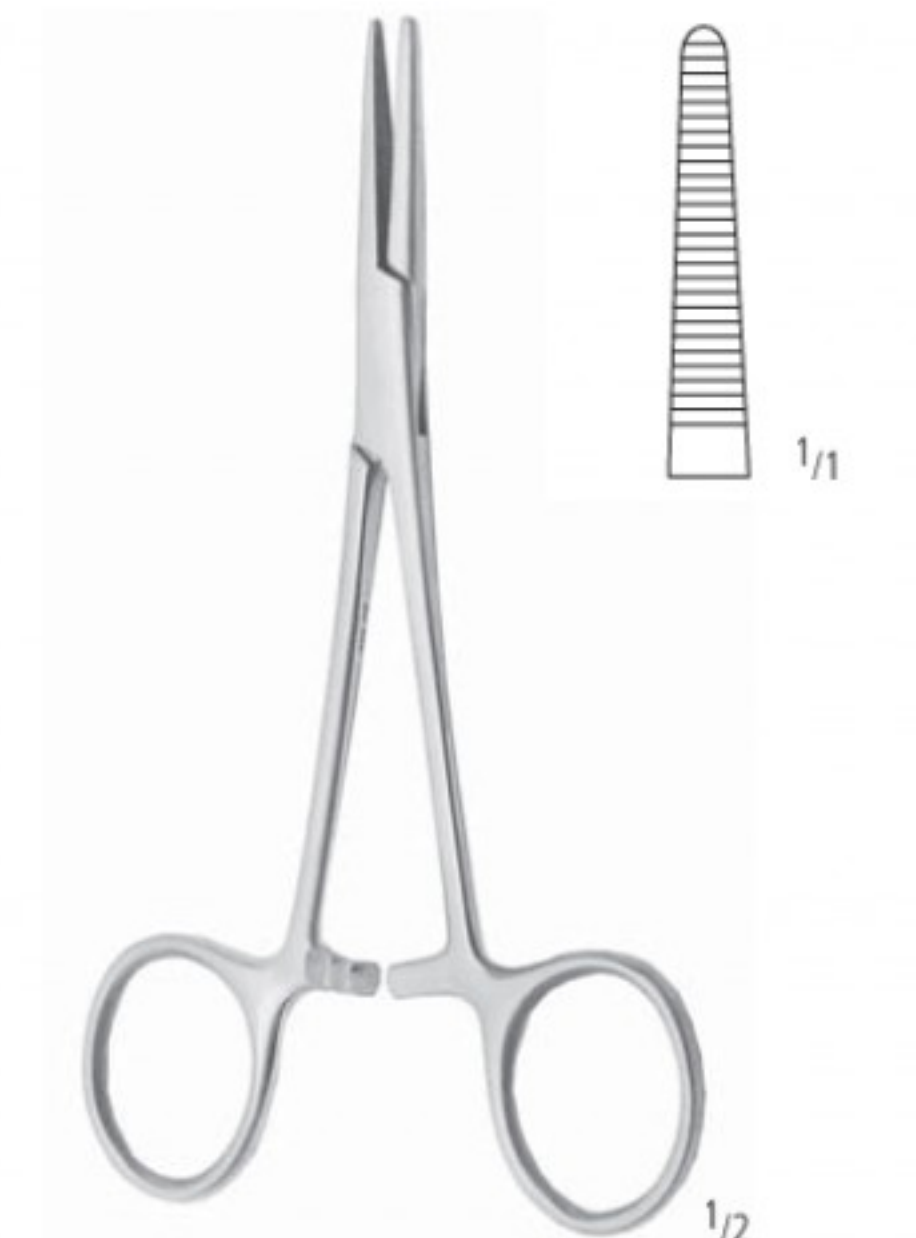

DUNHILL

AA 220/13
 13,0 cm/5"

KLEMMEN HEMOSTATS PINZAS HEMOSTATICAS PINCES HEMOSTATIQUES PINZE EMOSTATICHE

Arterienklemmen, Präparier- und Ligaturklemmen
 Artery Forceps, Dissecting and Ligature Forceps
 Pinzas hemostáticas, Pinzas para preparaciones y ligaduras
 Pincas hémostatiques, Pincas à disséquer et à ligatures
 Pinze emostatiche, Pinze per preparazioni e legature

AA
 AB
 AC
 AD
 AE
 AF
 AK
 AL
 AO
 KA
 KK
 X



OVERHOLT-GEISSENDOERFER

21,0 cm/8¹/₄"
 27,0 cm/10³/₄"

21,0 cm/8¹/₄"
 27,0 cm/10³/₄"
 29,5 cm/11¹/₂"

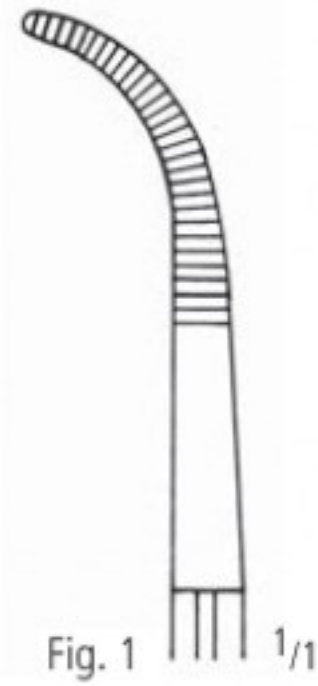

Fig. 1 1/1

AA 221/01
 AA 223/01

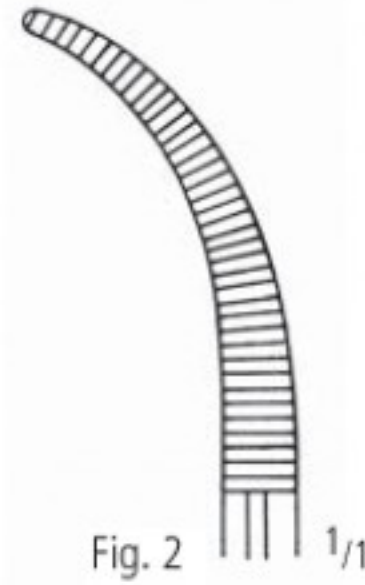

Fig. 2 1/1

AA 221/02
 AA 223/02

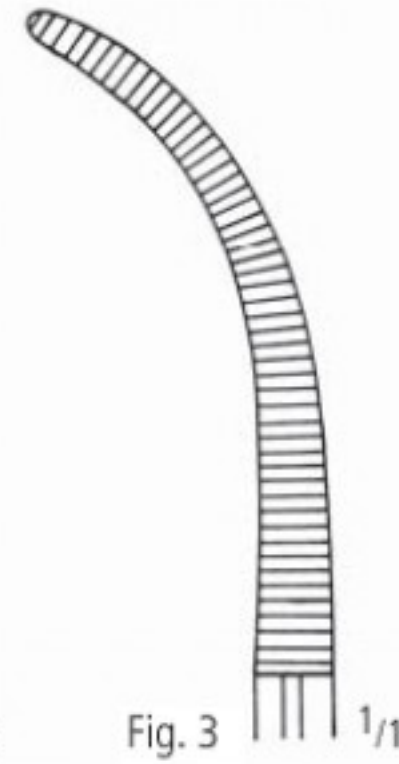

Fig. 3 1/1

AA 221/03
 AA 223/03

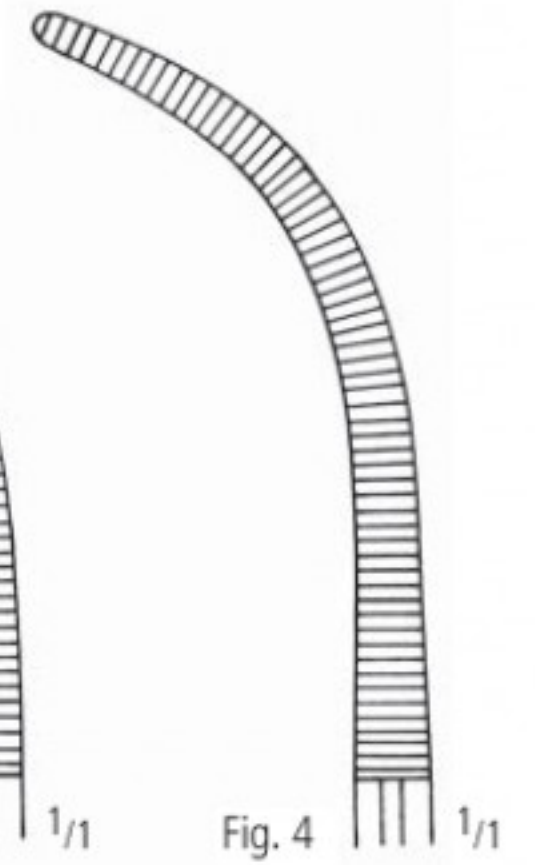

Fig. 4 1/1

AA 221/04
 AA 223/04

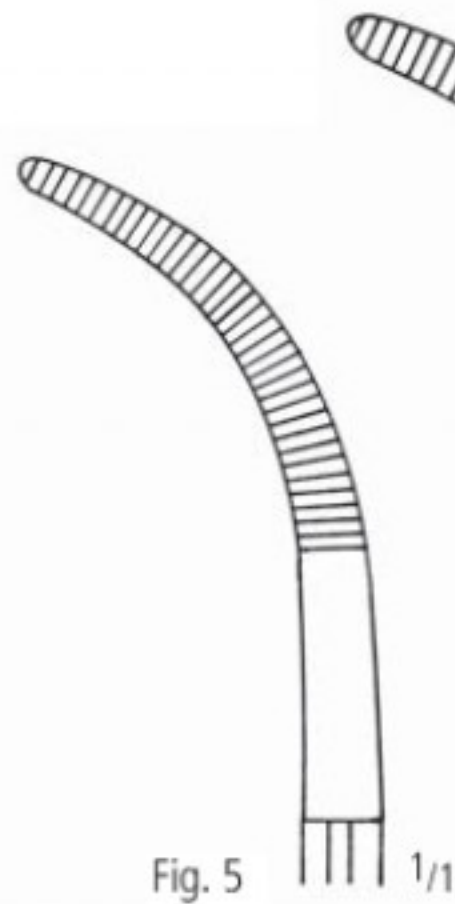

Fig. 5 1/1

AA 221/05
 AA 223/05

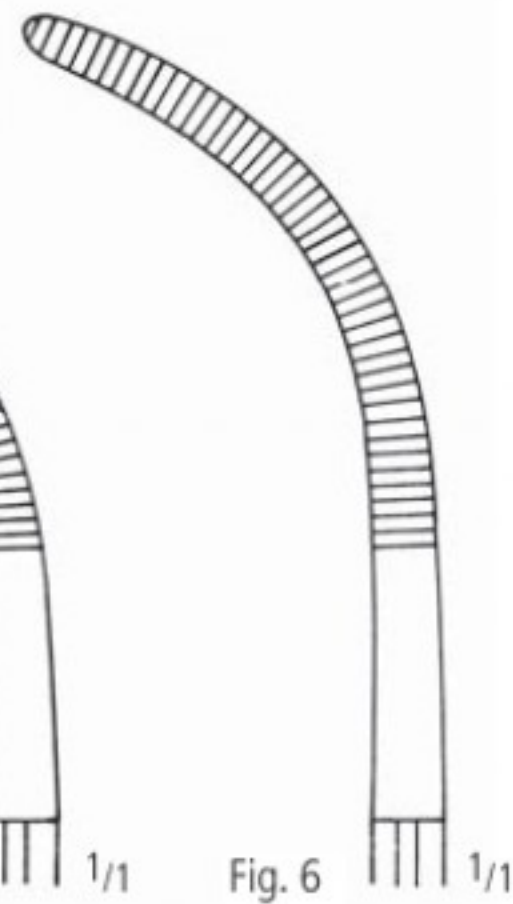

Fig. 6 1/1

AA 221/06
 AA 223/06

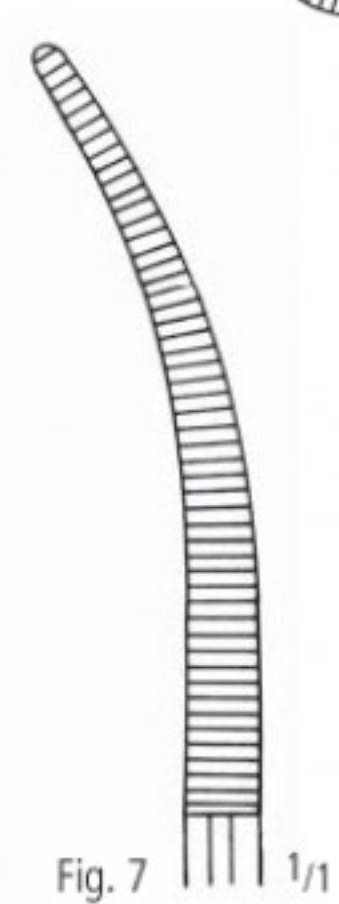

Fig. 7 1/1

AA 221/07
 AA 223/07

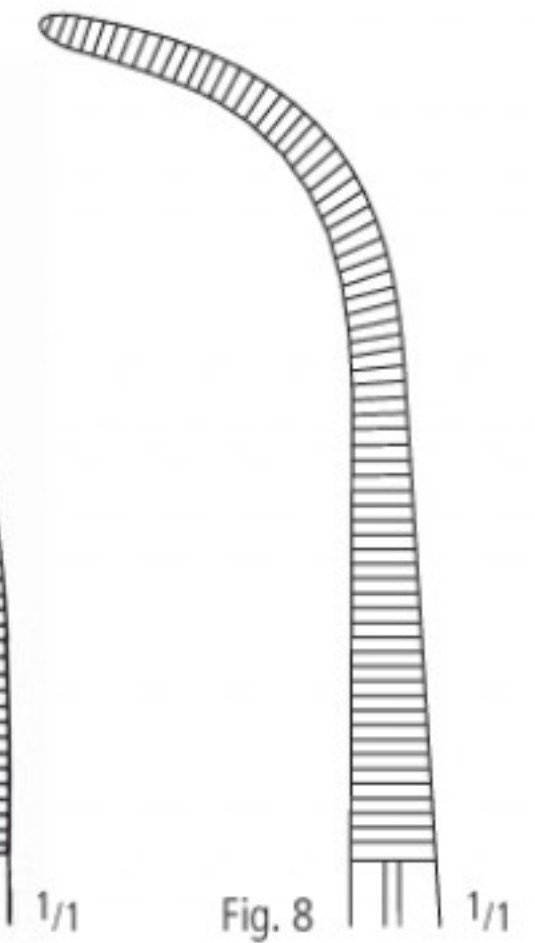

Fig. 8 1/1

AA 224/08



BABY-OVERHOLT

AA 225/13
 13,5 cm/5¹/₄"

Präparier- und Ligaturklemmen
 Dissecting and Ligature Forceps
 Pinzas para preparaciones y ligaduras
 Pincès à disséquer et à ligatures
 Pinze per preparazioni e legature

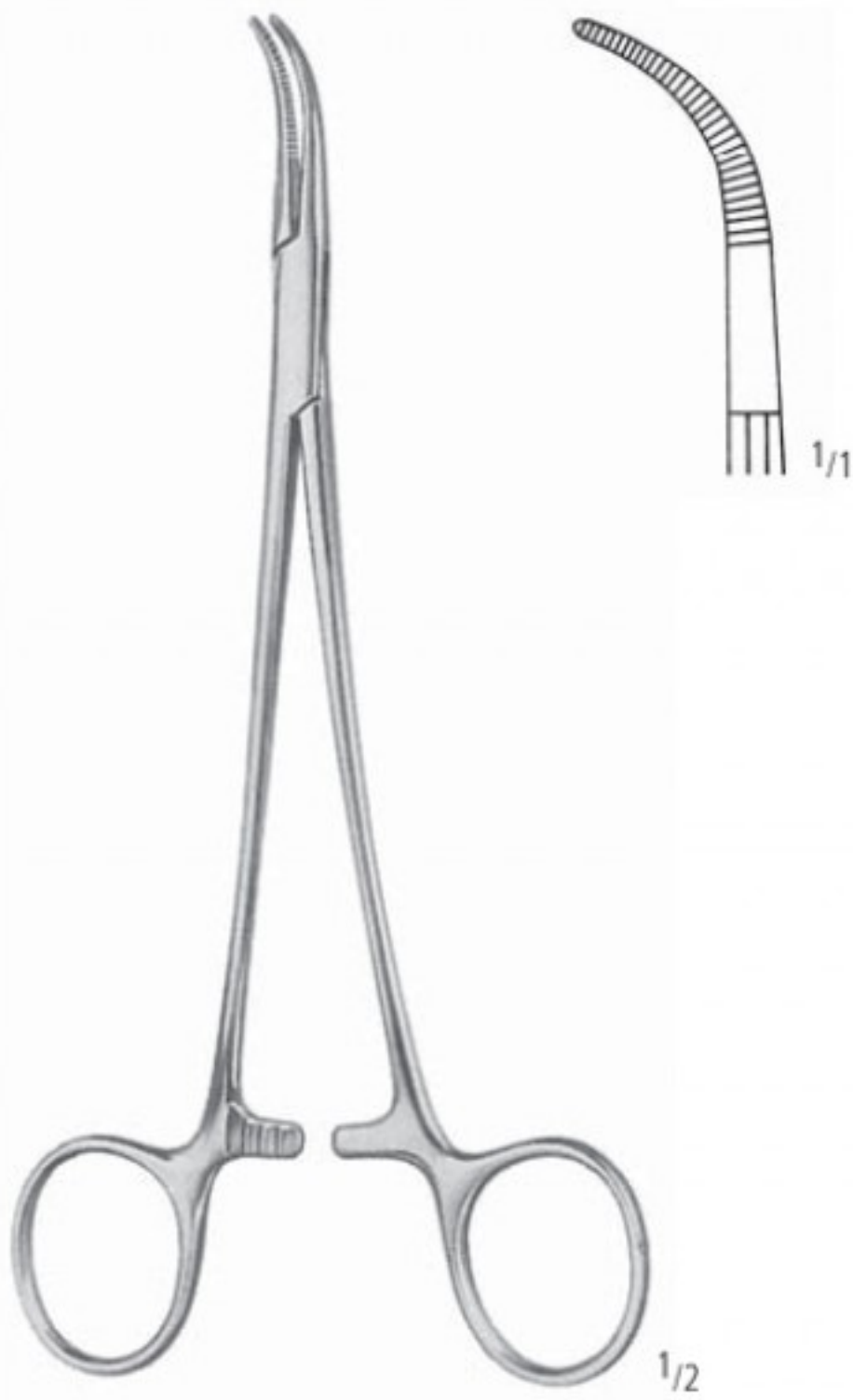

OVERHOLT
 AA 229/01
 18,5 cm/7¹/₃"



OVERHOLT
 AA 229/02
 20,5 cm/8"

S-förmig gebogen
 S-shaped
 curvas en S
 courbes en S
 curve in S

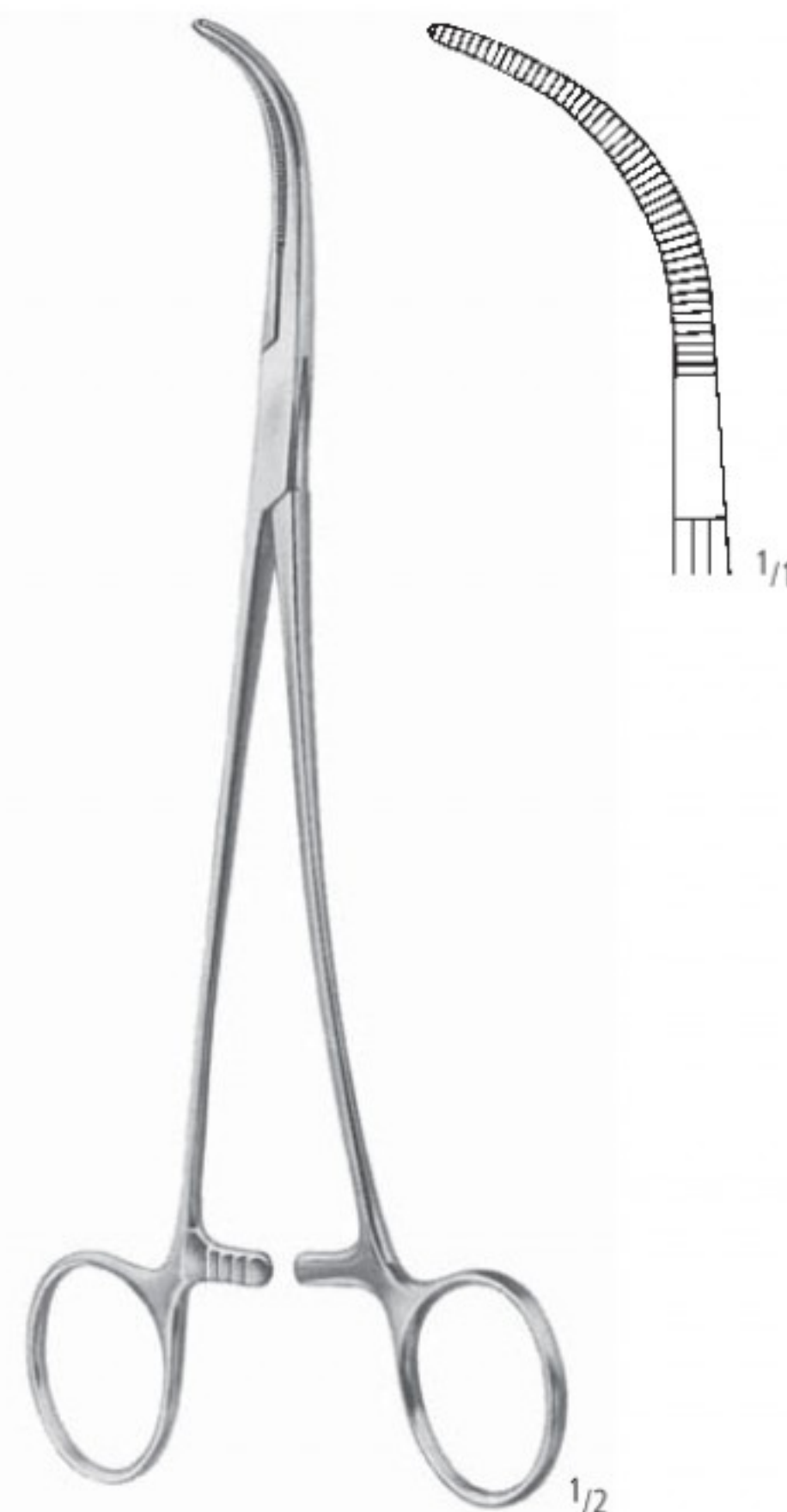

OVERHOLT
 AA 229/03
 21,0 cm/8¹/₄"

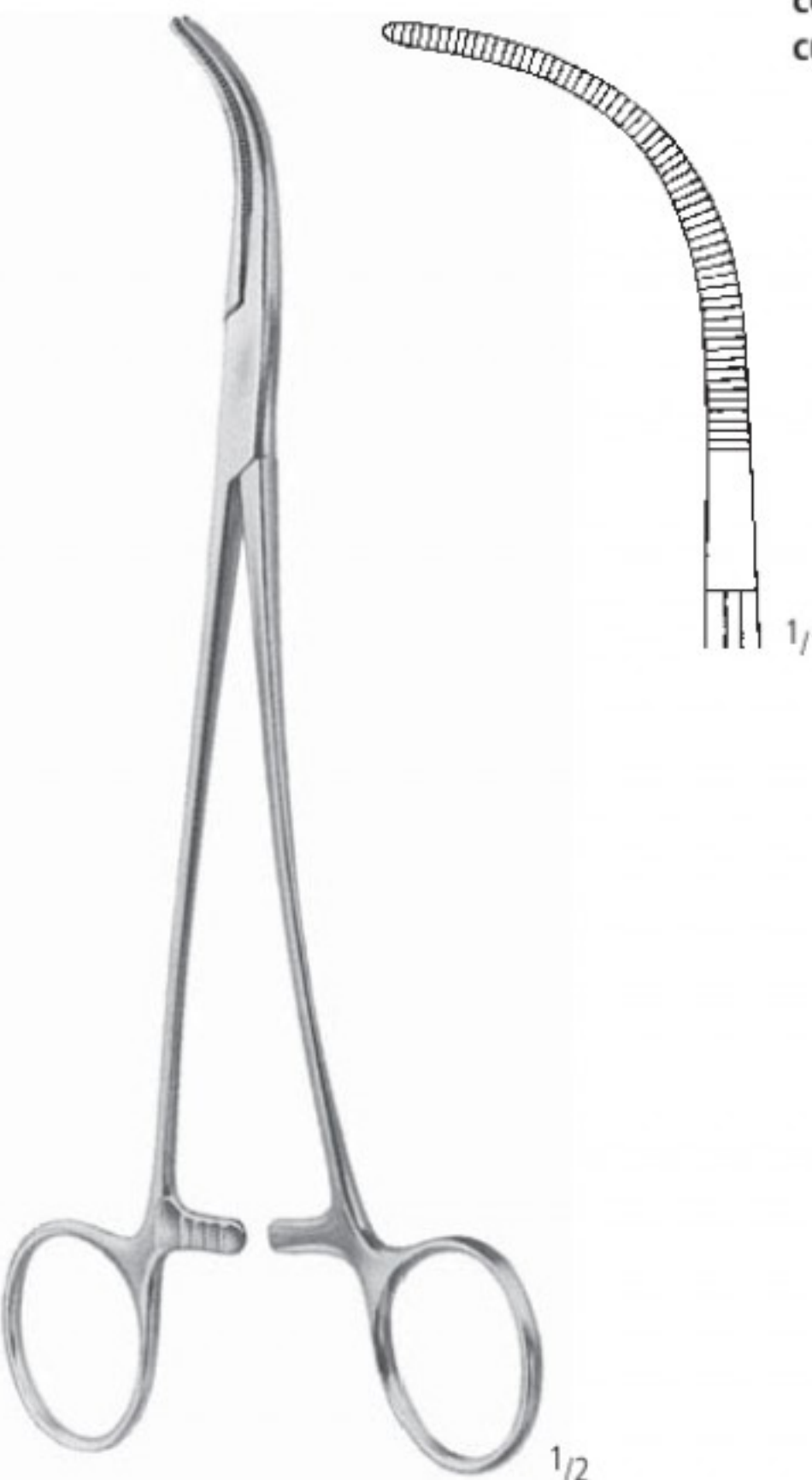

OVERHOLT
 AA 229/04
 21,5 cm/8¹/₂"

KLEMMEN HEMOSTATS PINZAS HEMOSTATICAS PINCES HEMOSTATIQUES PINZE EMOSTATICHE

Arterienklemmen, Präparier- und Ligaturklemmen
 Artery Forceps, Dissecting and Ligature Forceps
 Pinzas hemostáticas, Pinzas para preparaciones y ligaduras
 Pincés hémostatiques, Pincés à disséquer et à ligatures
 Pinze emostatiche, Pinze per preparazioni e legature

AA
 AB
 AC
 AD
 AE
 AF
 AK
 AL
 AO
 KA
 KK
 X



BABY-ADSON
 AA 235/14
 14,0 cm/5 1/2"

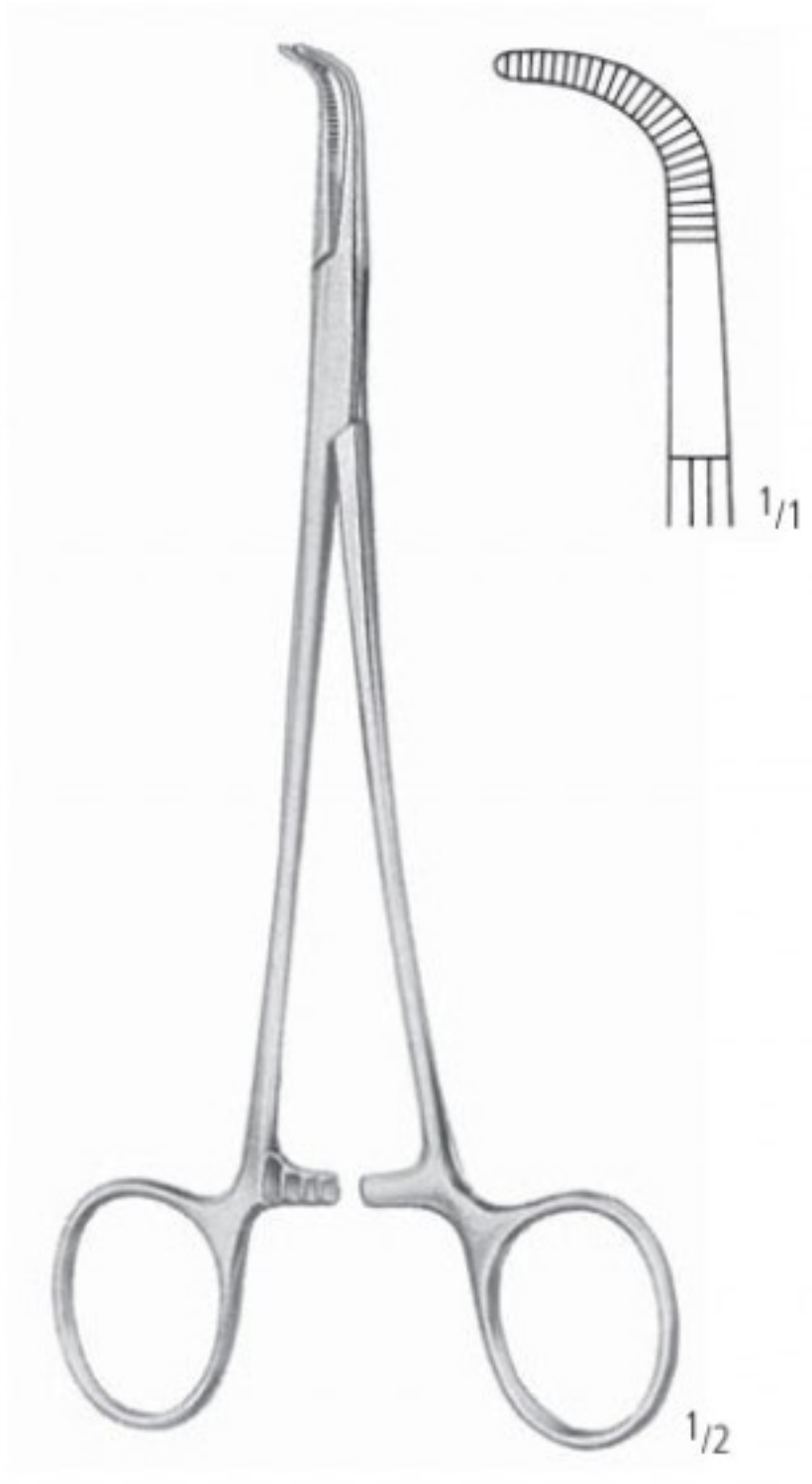

BABY-ADSON
 AA 237/18
 18,0 cm/7"

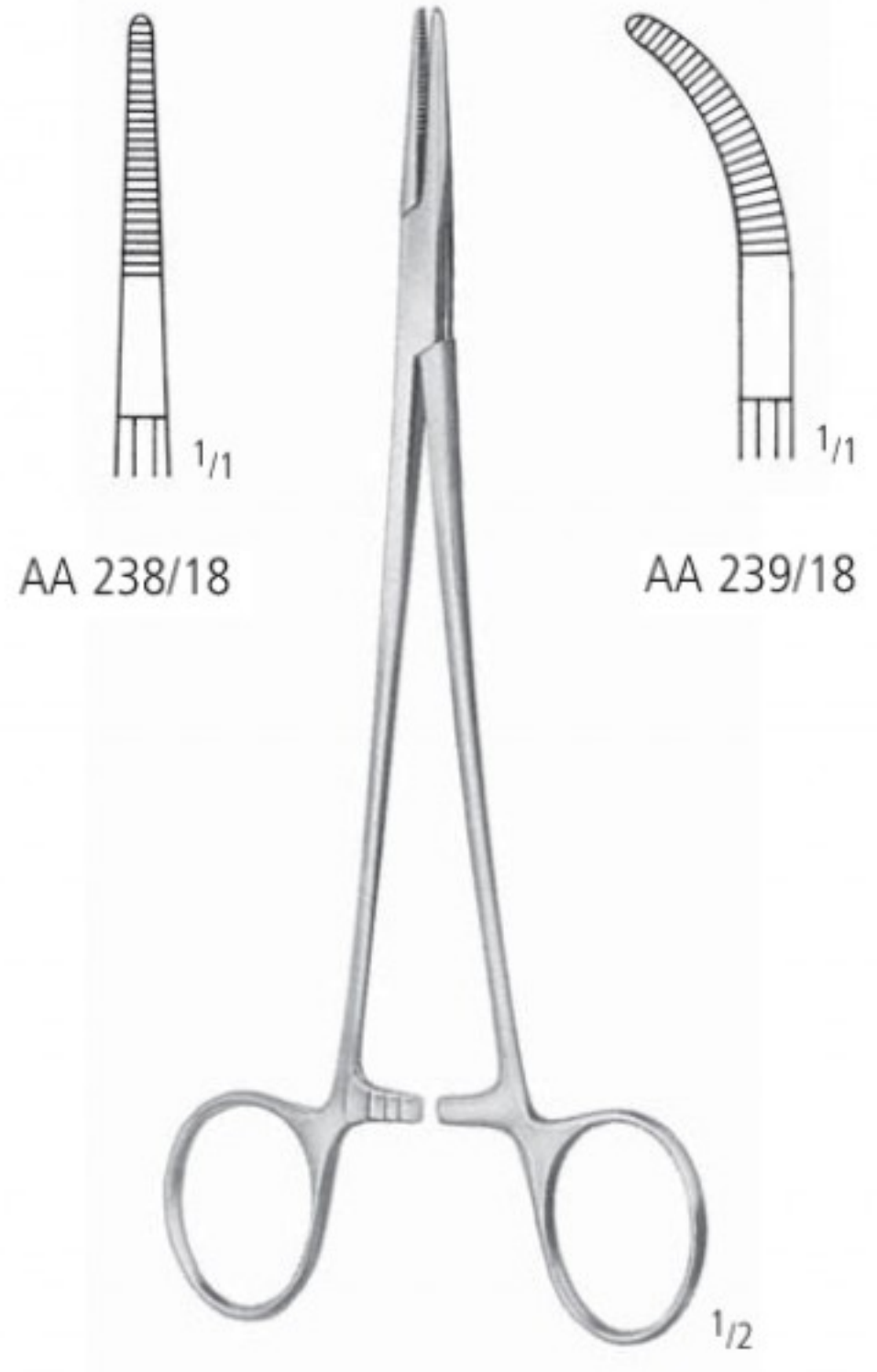

AA 238/18

AA 239/18



ADSON
 18,5 cm/7 1/3"

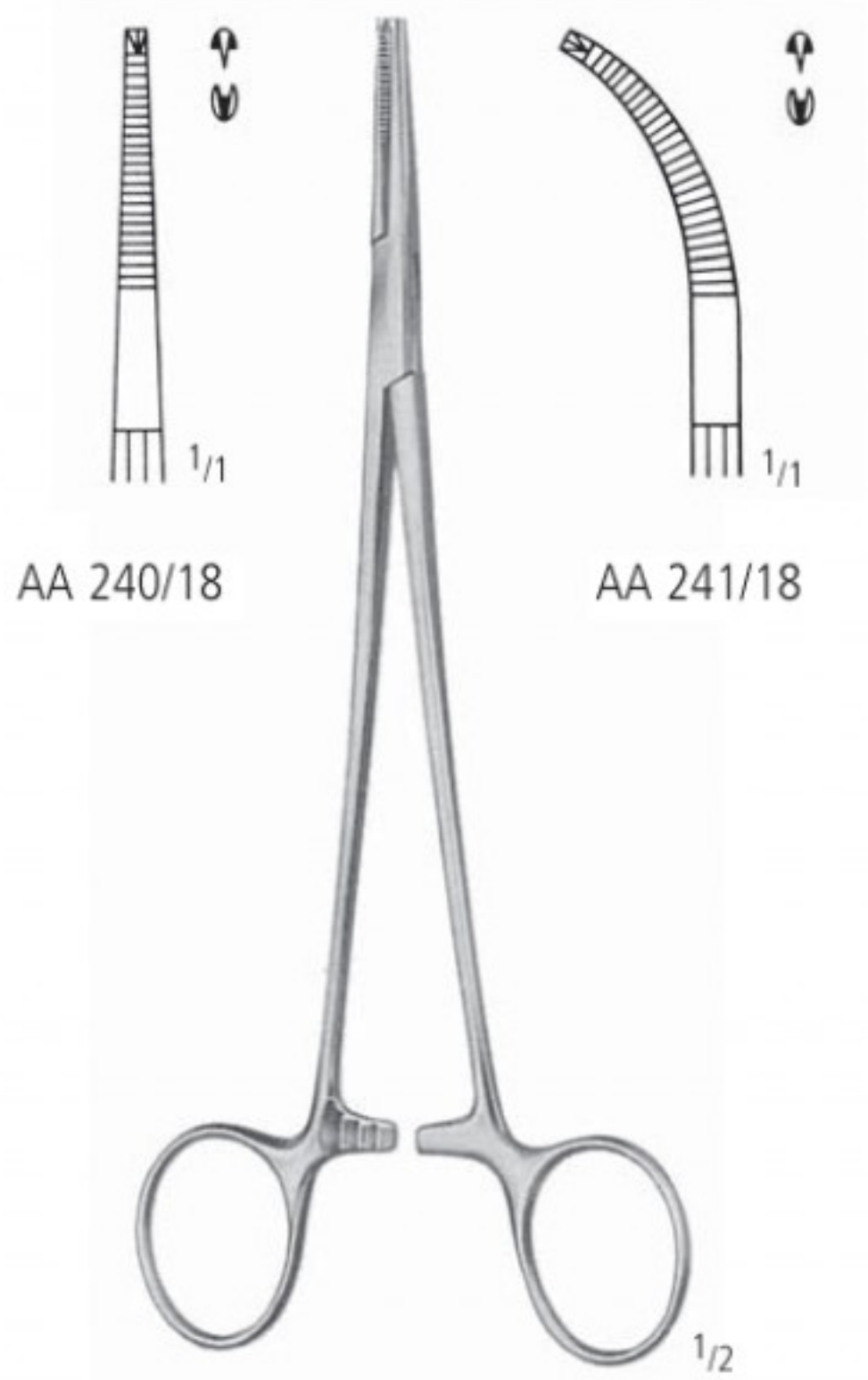

AA 240/18

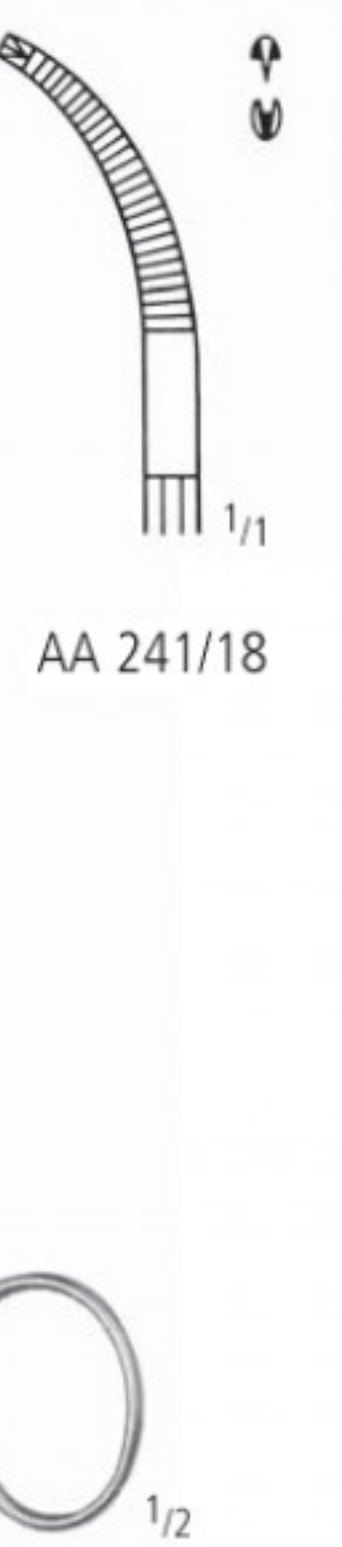

AA 241/18

ADSON 1:2
 18,5 cm/7 1/3"



MEEKER

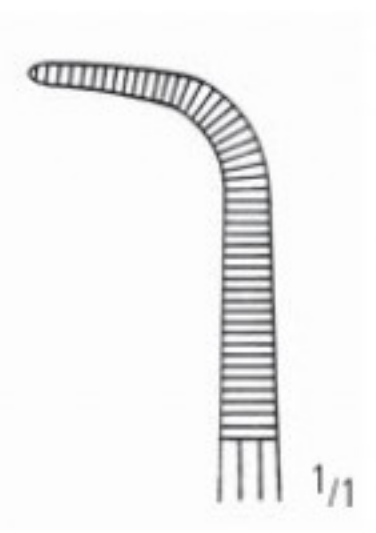

AA 251/18
 18,0 cm/7"

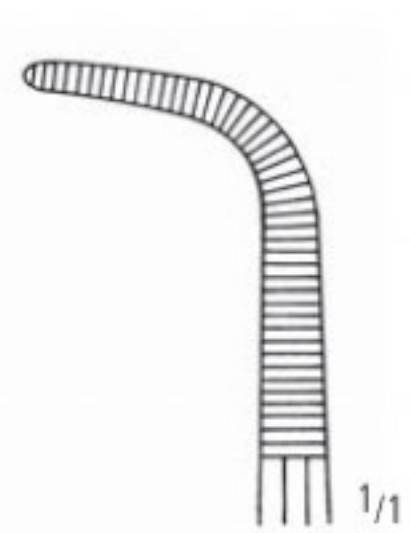

AA 251/28
 28,0 cm/11"

Arterienklemmen
 Artery Forceps
 Pinzas hemostáticas
 Pincés hémostatiques
 Pinze emostatiche



DIXON-LOVELACE
 AA 286/15
 15,5 cm/6"



DIXON-LOVELACE 1:2
 AA 288/15
 15,5 cm/6"

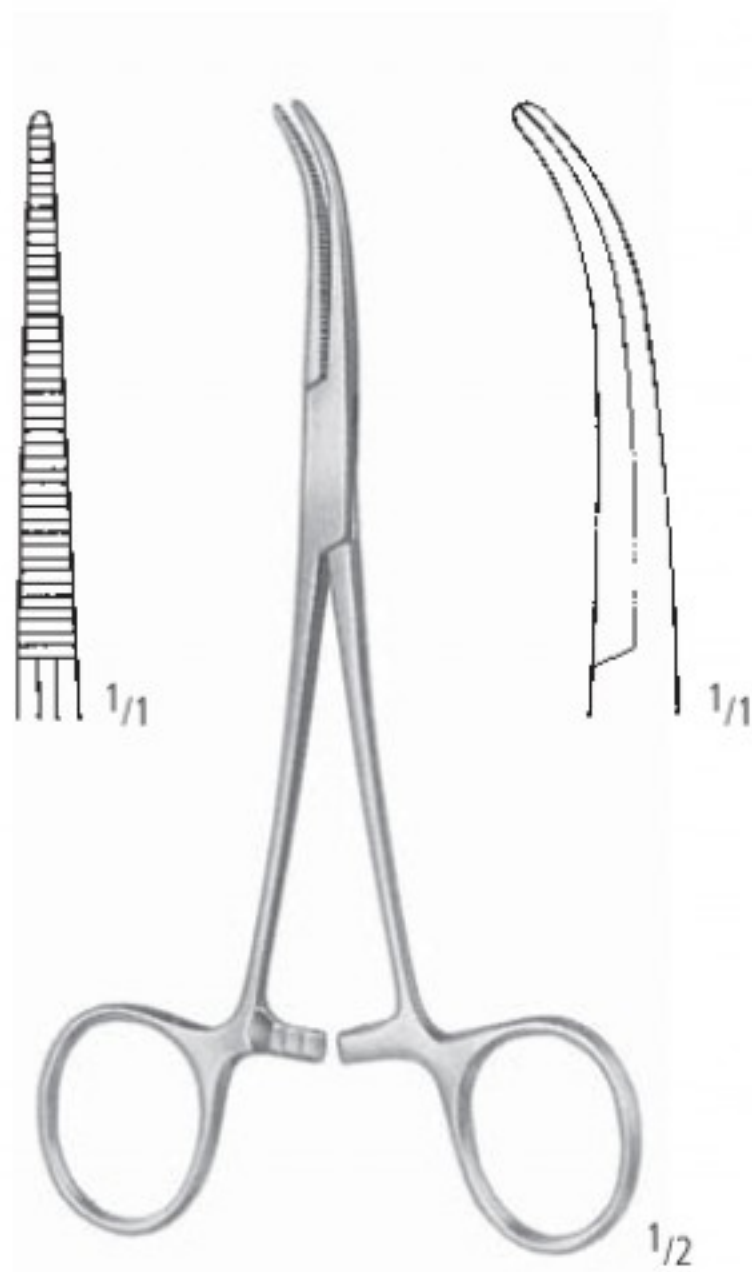

DANDY
 AA 291/14
 14,0 cm/5 1/2"

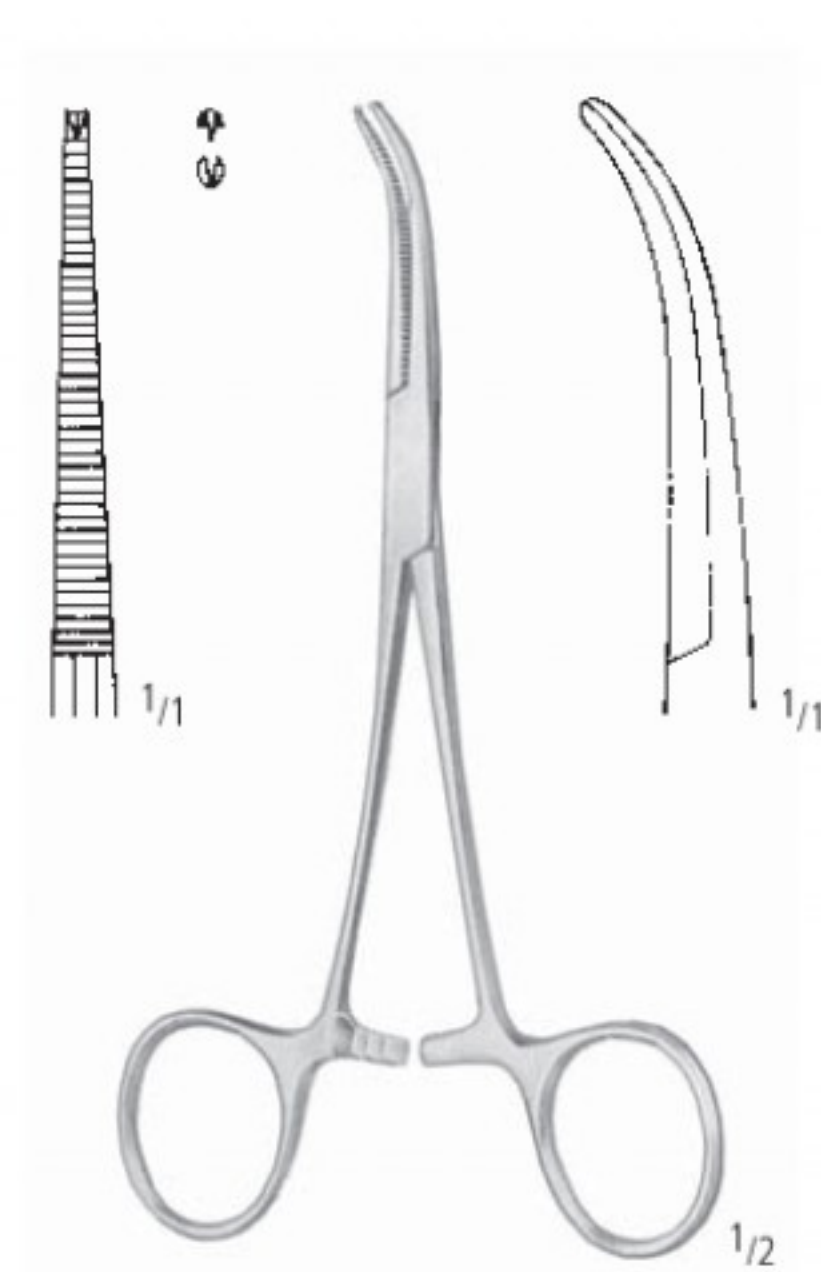

DANDY 1:2
 AA 293/14
 14,0 cm/5 1/2"

KLEMMEN HEMOSTATS PINZAS HEMOSTATICAS PINCES HEMOSTATIQUES PINZE EMOSTATICHE

Arterienklemmen, Tonsillenklemmen
 Artery Forceps, Tonsil Hemostatic Forceps
 Pinzas hemostáticas, pinzas hemostáticas para amígdalas
 Pincés hémostatiques, pincés hémostatiques pour amygdales
 Pinze emostatiche, pinze emostatiche per tonsille

AA
 AB
 AC
 AD
 AE
 AF
 AK
 AL
 AO
 KA
 KK
 X

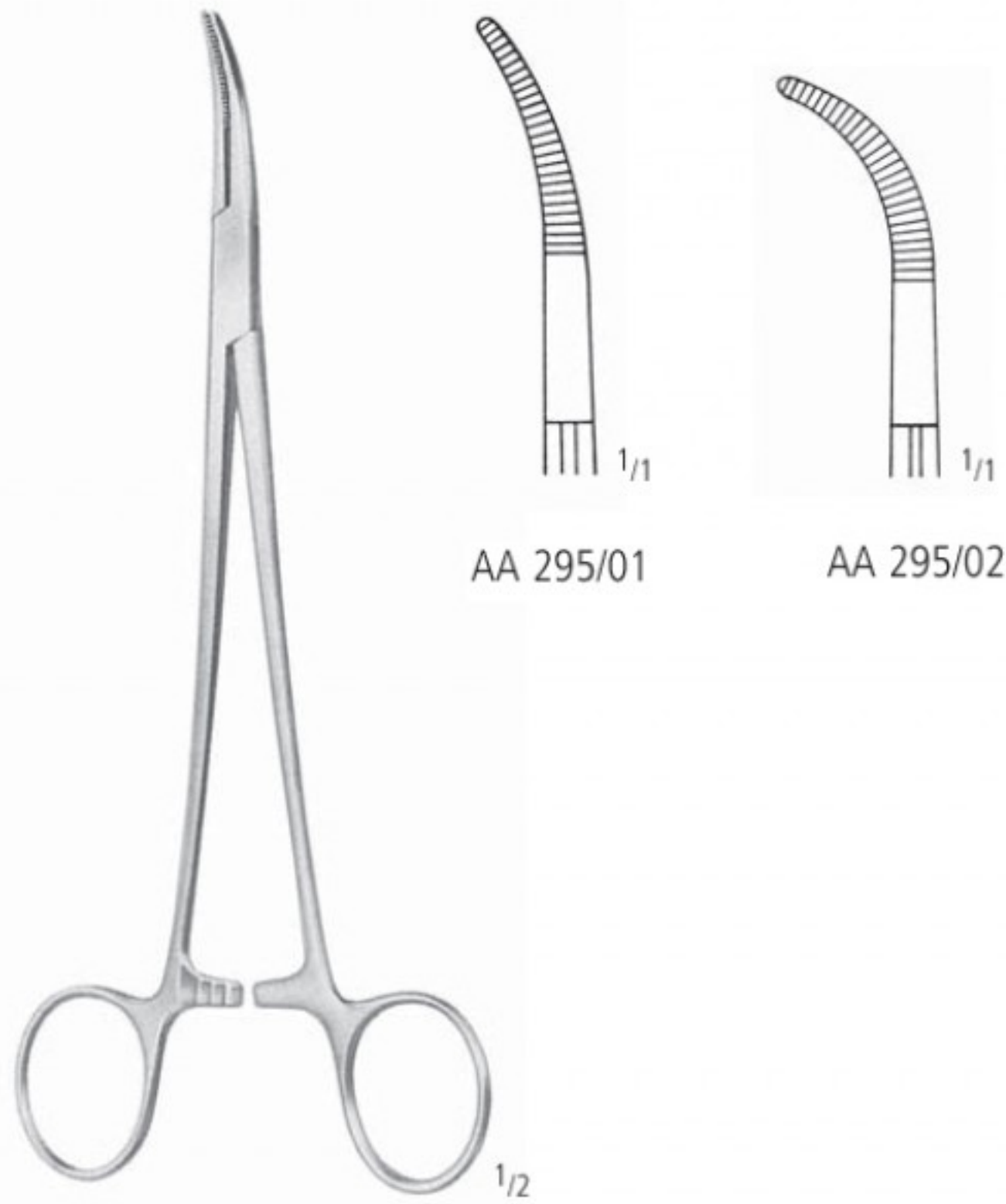

AA 295/01

AA 295/02

SCHNIDT-SAWTELL
 19,0 cm/7¹/₂"

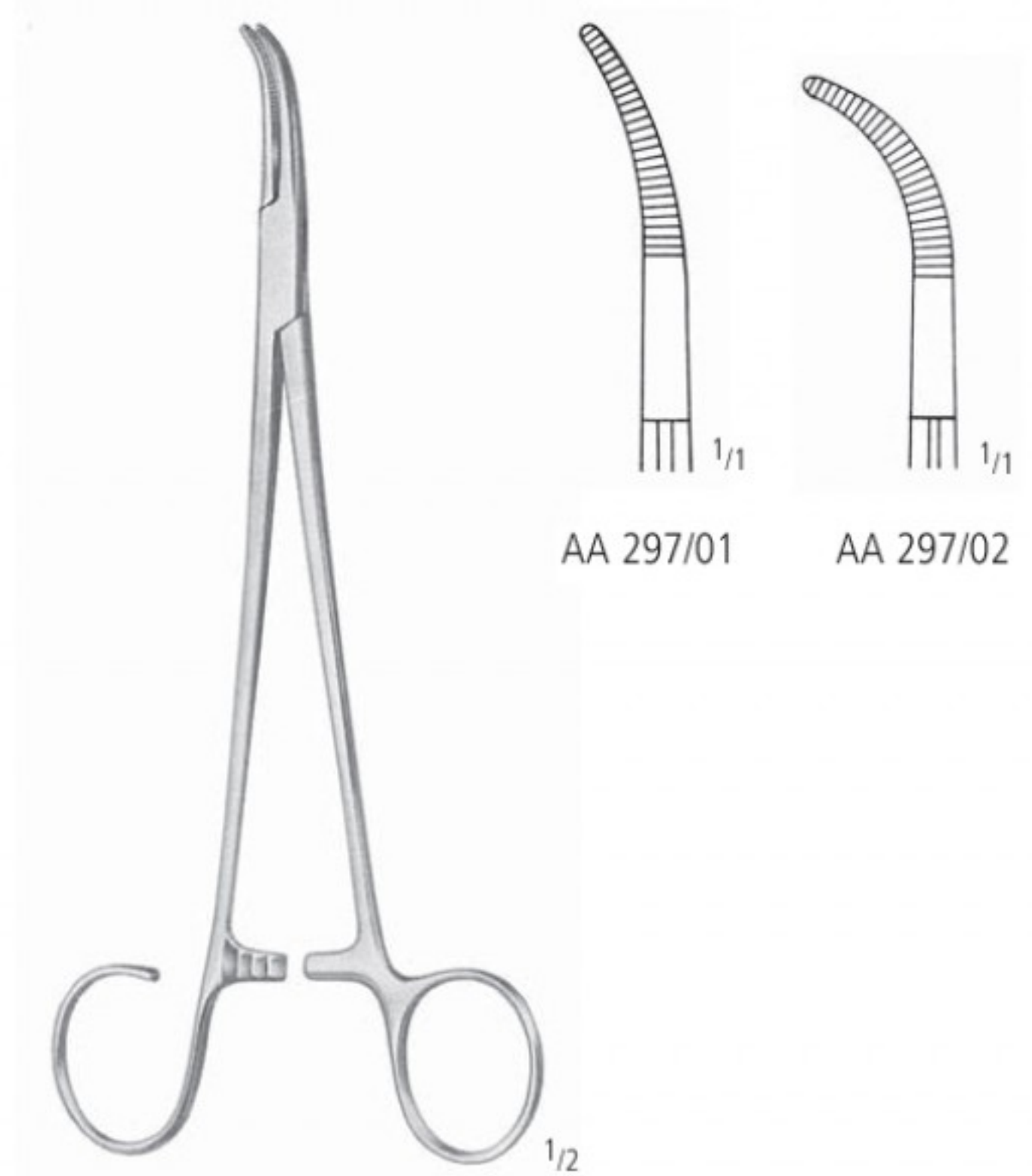

AA 297/01

AA 297/02

SCHNIDT-SAWTELL
 19,0 cm/7¹/₂"

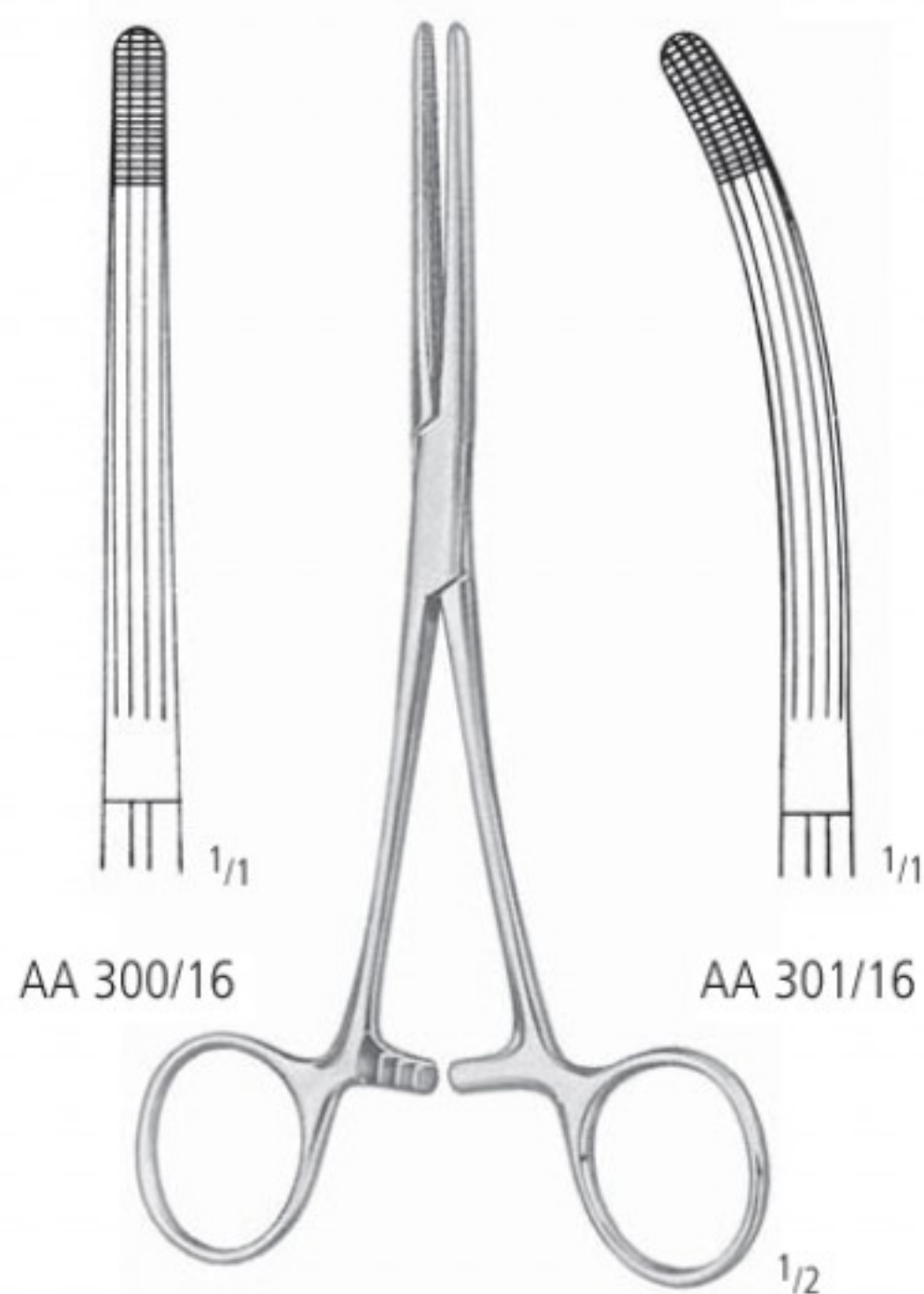

AA 300/16

AA 301/16

ROCHESTER-CARMALT

AA 300/16
 AA 300/20

16,0 cm/6¹/₄"
 20,0 cm/8"

AA 301/16
 AA 301/20

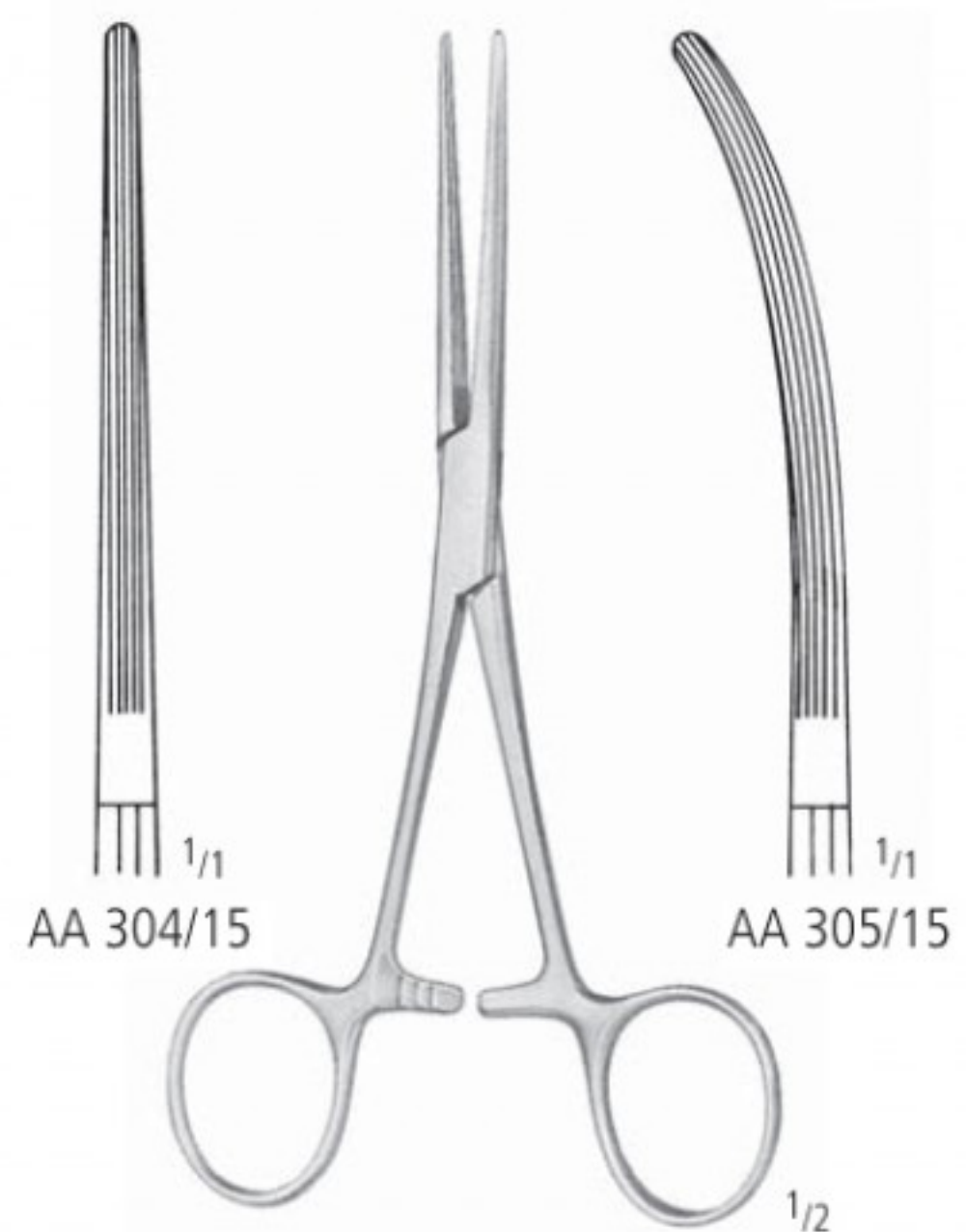

AA 304/15

AA 305/15

BAINBRIDGE

AA 304/15
 AA 304/18

15,0 cm/6"
 18,5 cm/7¹/₃"

AA 305/15
 AA 305/18

Arterienklemmen
 Artery Forceps
 Pinzas hemostáticas
 Pincas hémostatiques
 Pinze emostatiche

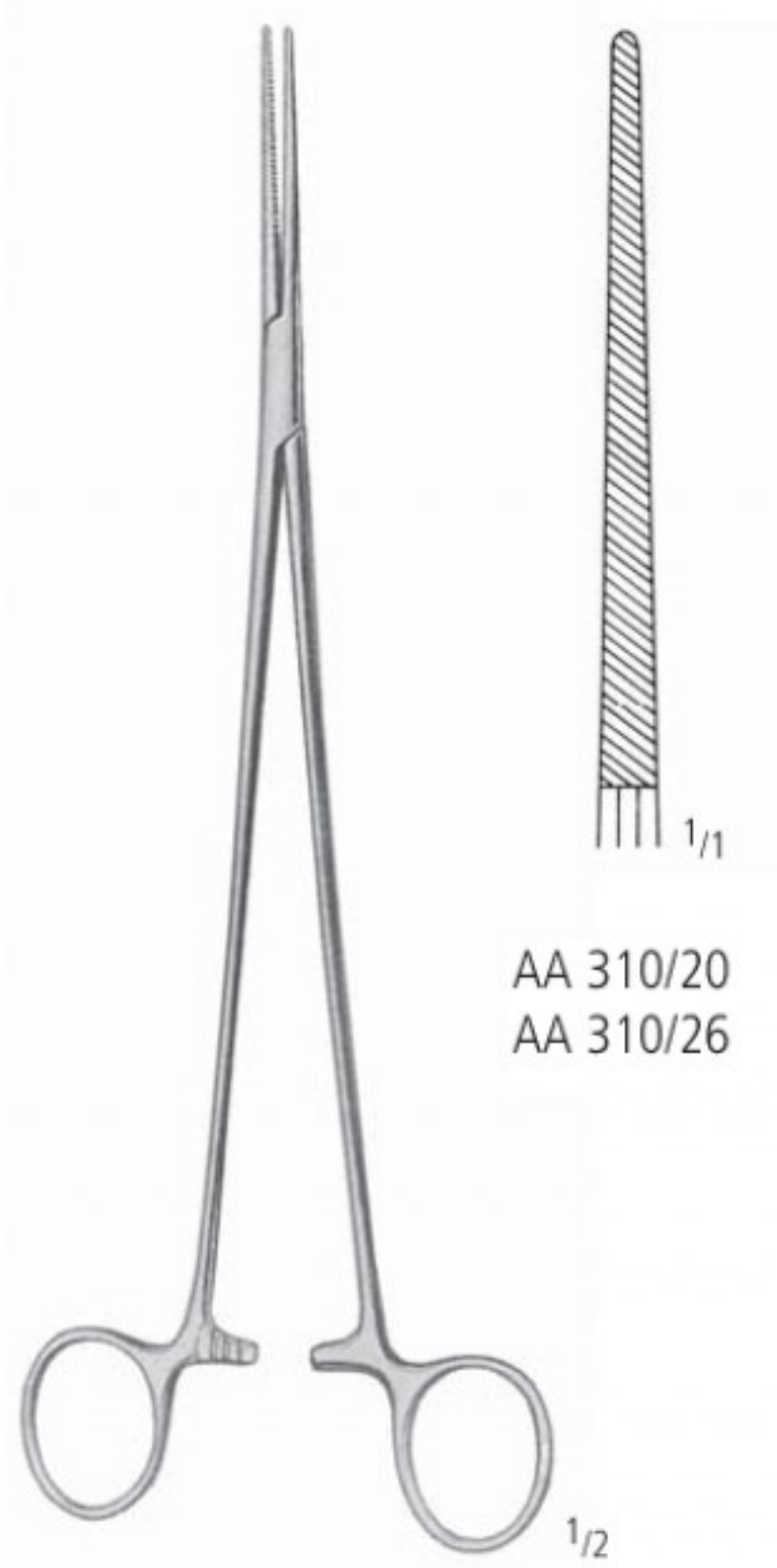

BENGOLEA

AA 310/20
 AA 310/26

20,0 cm/8"
 26,0 cm/10¹/₂"



AA 311/20
 AA 311/26

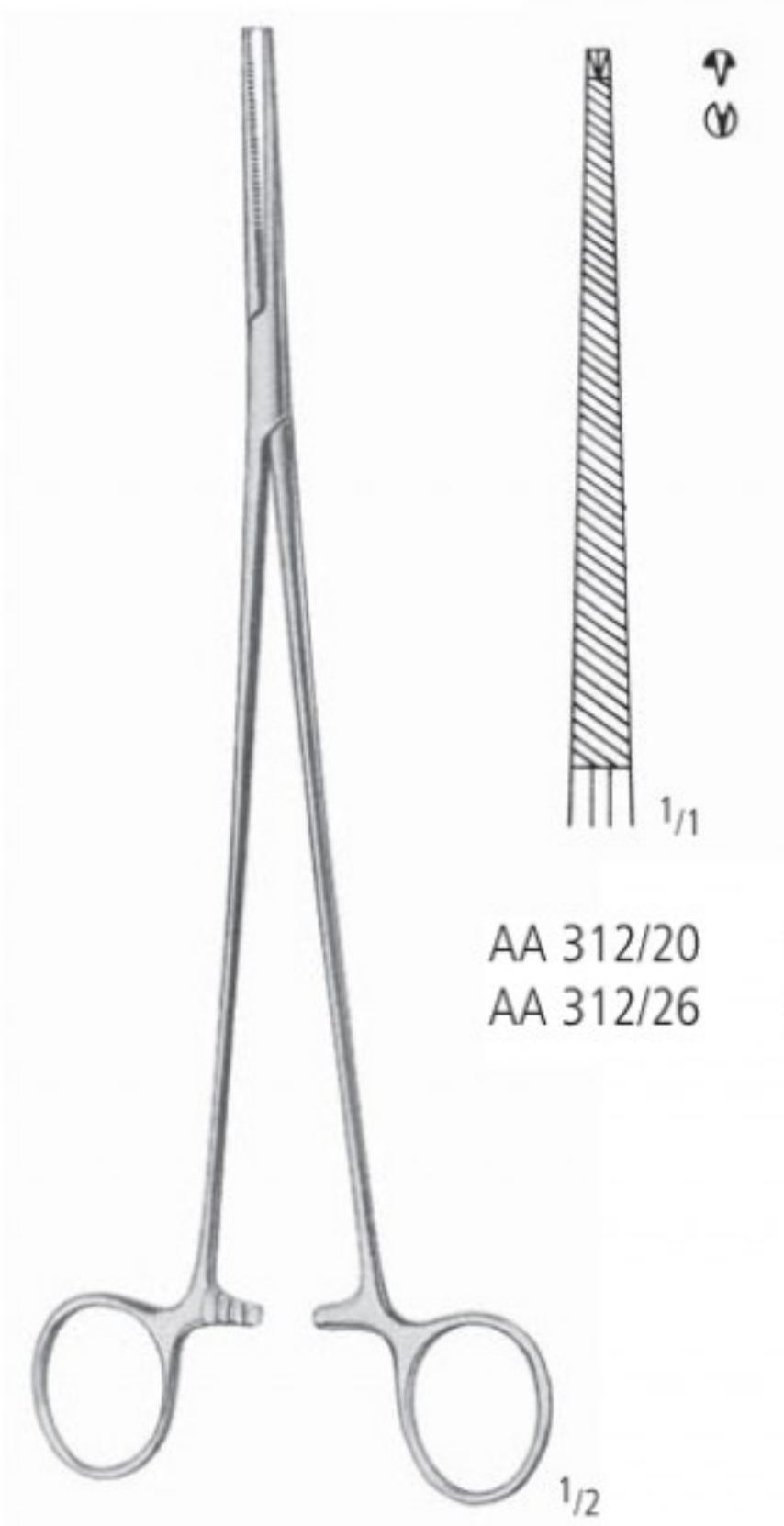

BENGOLEA 1:2

AA 312/20
 AA 312/26

20,0 cm/8"
 26,0 cm/10¹/₂"

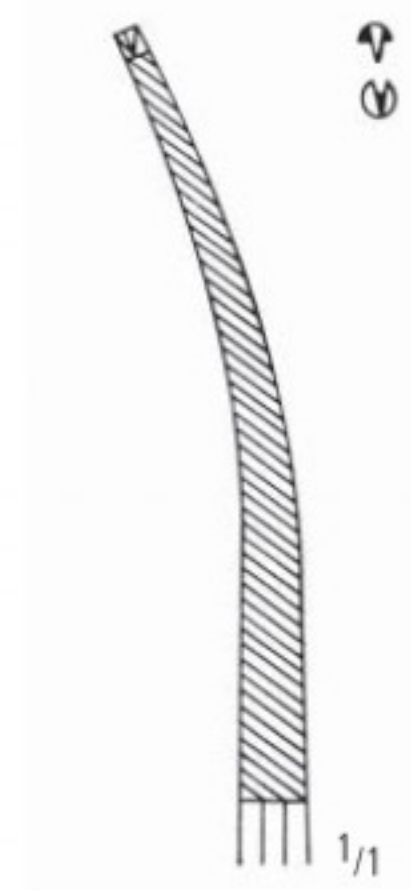

AA 313/20
 AA 313/26

Aurikelklemmen, Präparier- und Ligaturklemmen
 Auricle Forceps, Dissecting and Ligature Forceps
 Pinzas para aurícula, Pinzas para preparaciones y ligaduras
 Pincas auriculaires, Pincas à disséquer et à ligatures
 Pinze auricolari, Pinze per preparazioni e legature

AA
 AB
 AC
 AD
 AE
 AF
 AK
 AL
 AO
 KA
 KK
 X



CRAFOORD-SELLORS

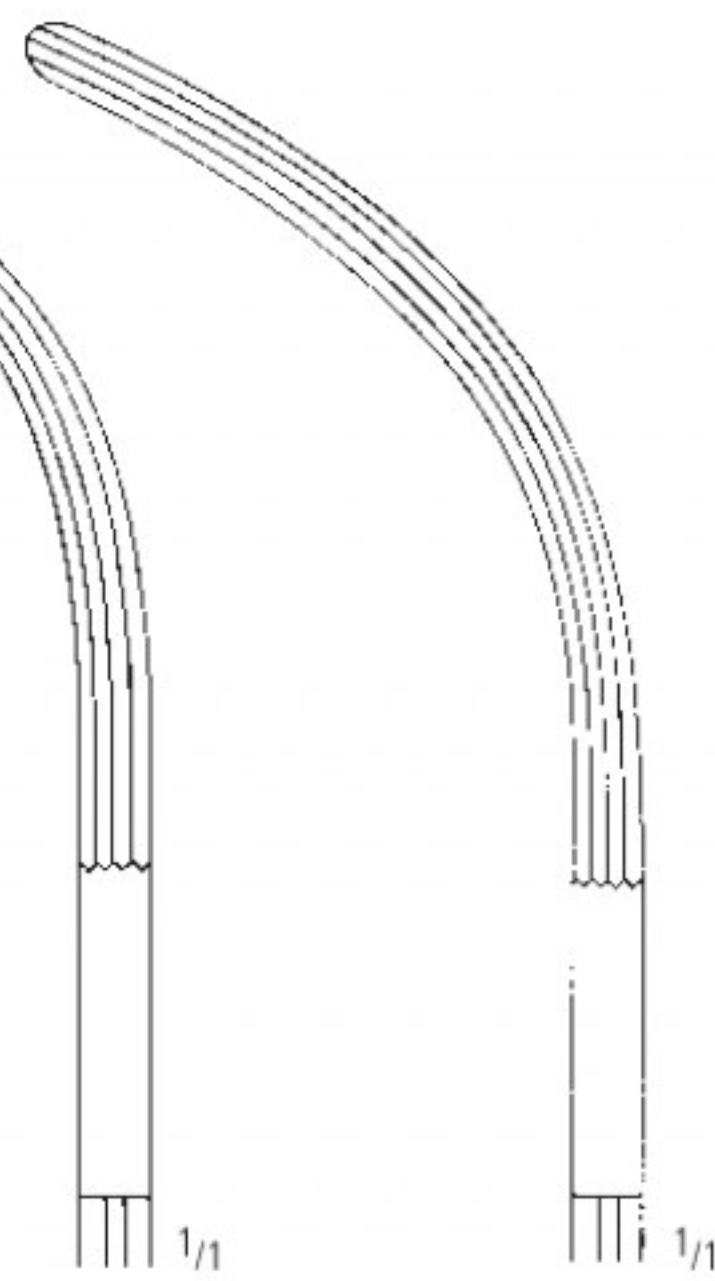

AA 317/22
 22,0 cm/8³/₄"

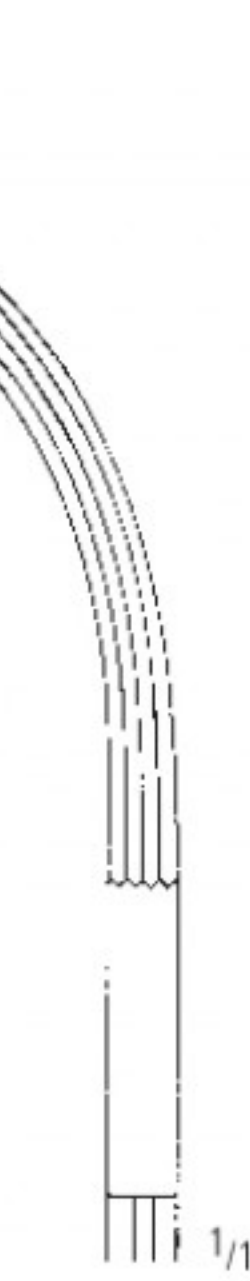

AA 317/23
 23,0 cm/9"

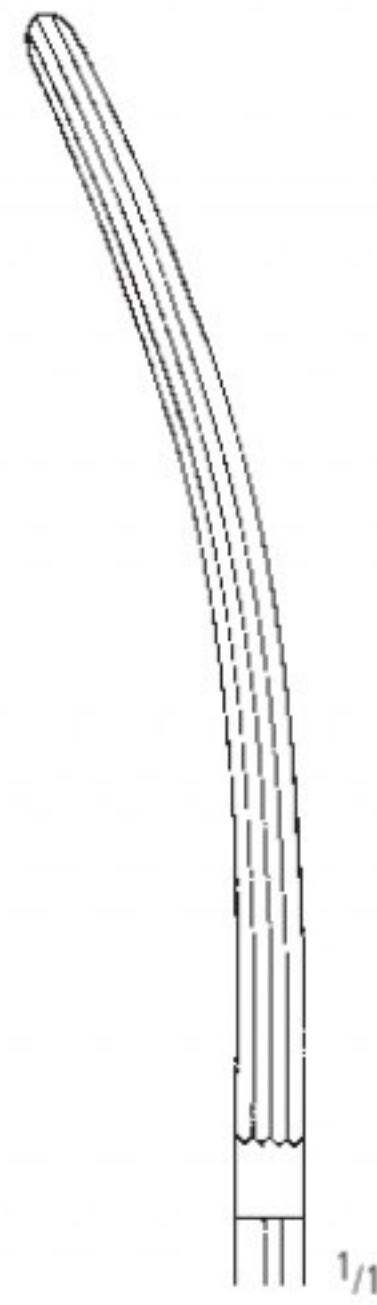

AA 317/24
 24,0 cm/9¹/₂"

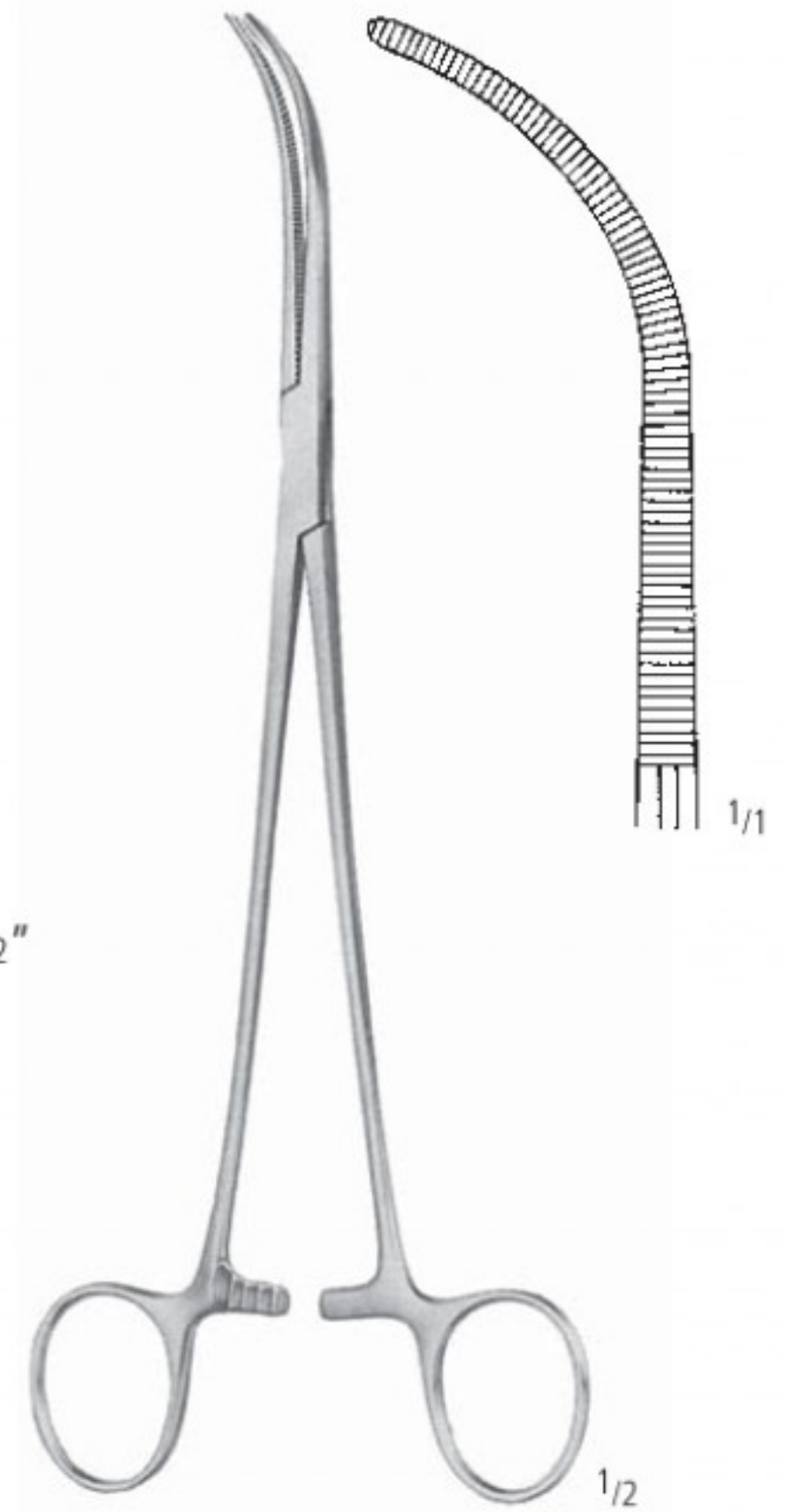

OVERHOLT-MIXTER

AA 319/21
 21,0 cm/8¹/₄"

Arterienklemmen, Bronchusklemmen
 Artery Forceps, Bronchus Forceps
 Pinzas hemostáticas, Pinzas-clamps bronquias
 Pincés hémostatiques, Pincés-clamps à bronches
 Pinze emostatiche, Pinze per bronchi

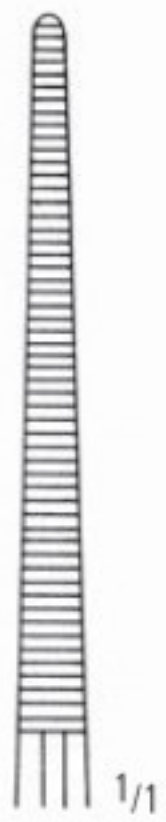

Fig. 1
AA 320/01

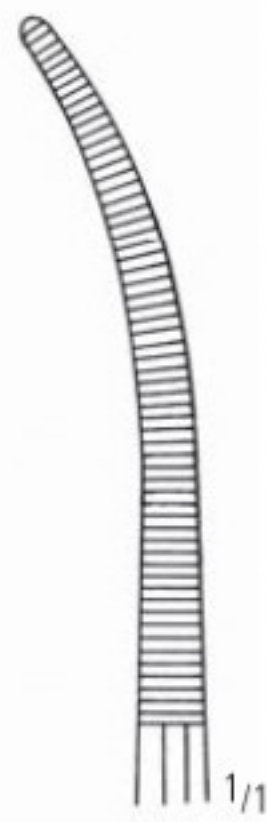

Fig. 2
AA 320/02

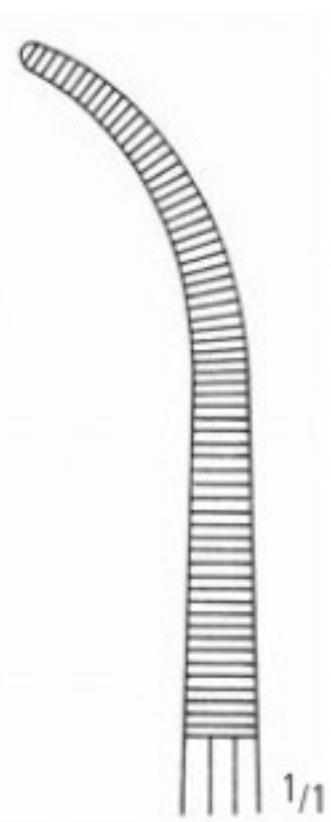
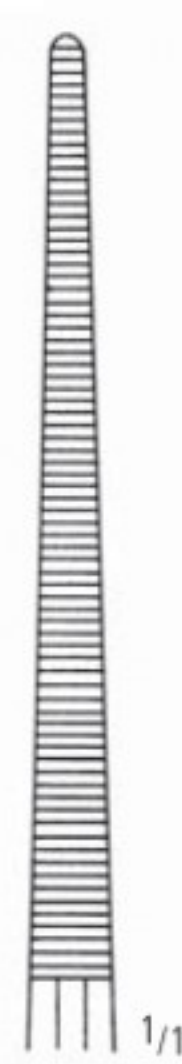
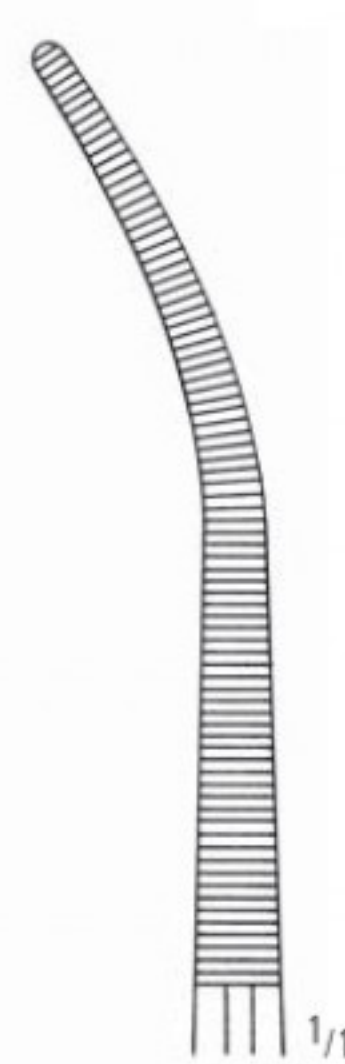

Fig. 3
AA 320/03



AA 322/22



AA 323/22

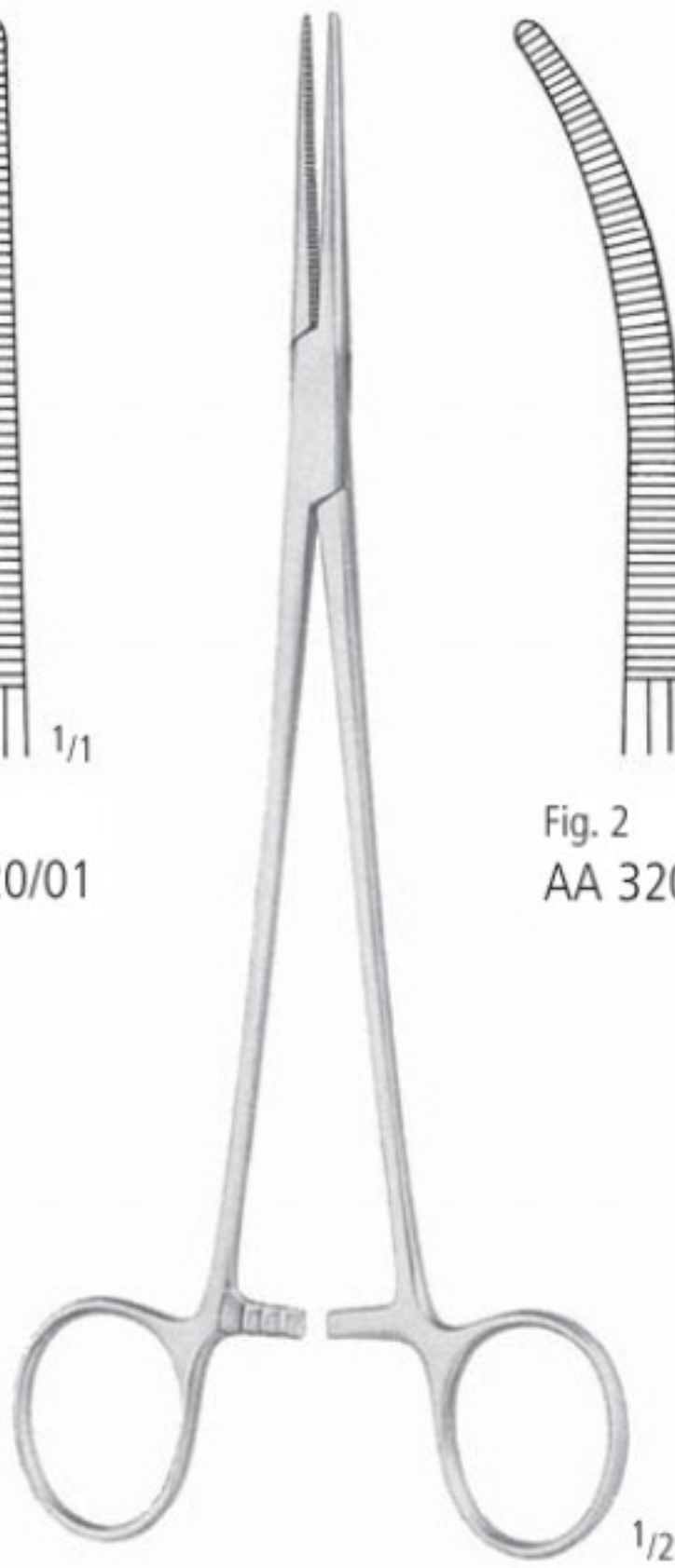

HEISS
20,0 cm/8"

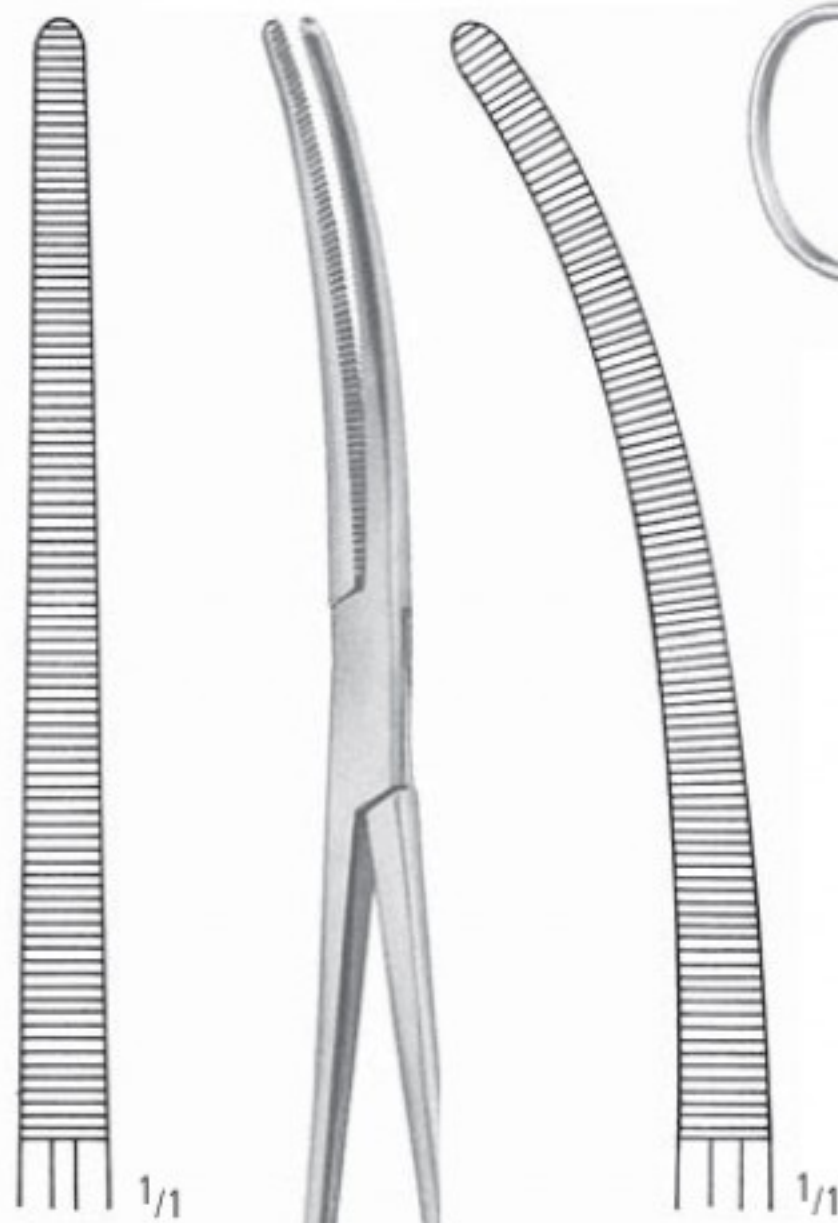

AA 328/24

AA 329/24

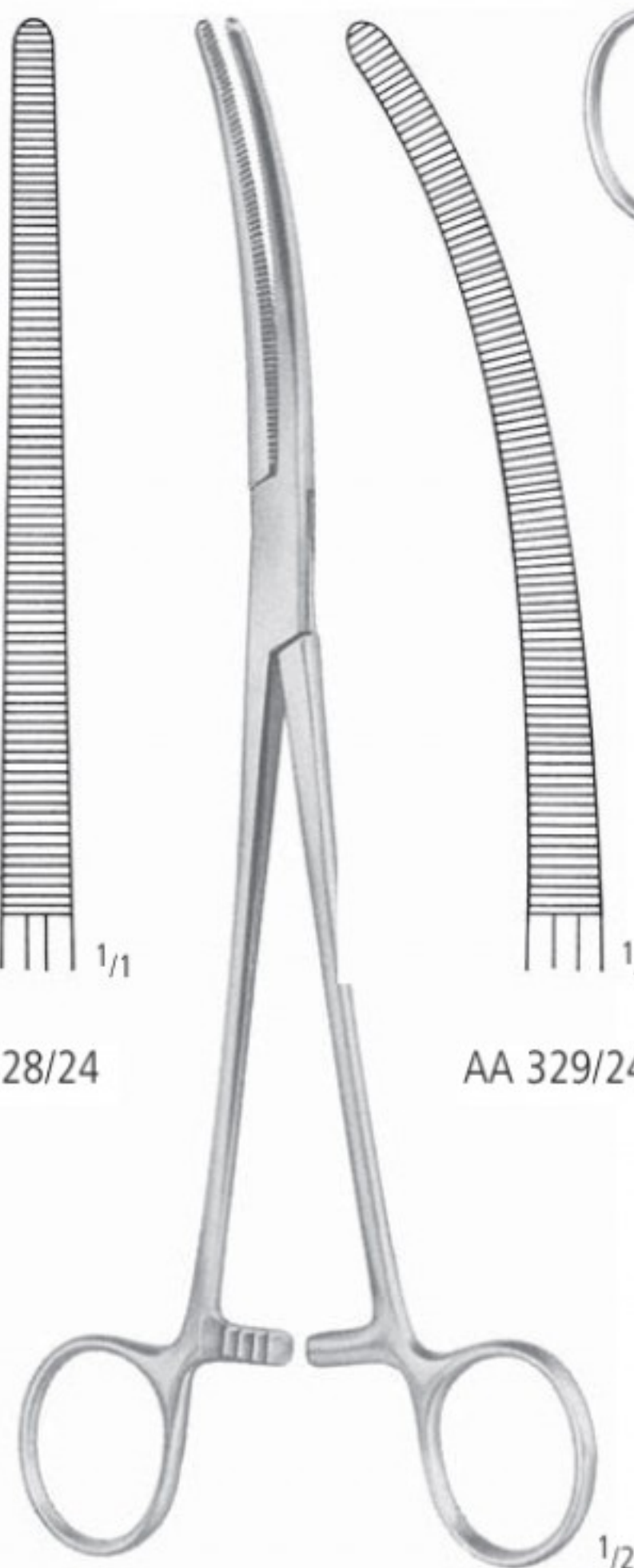

SAROT
24,0 cm/9¹/₂"

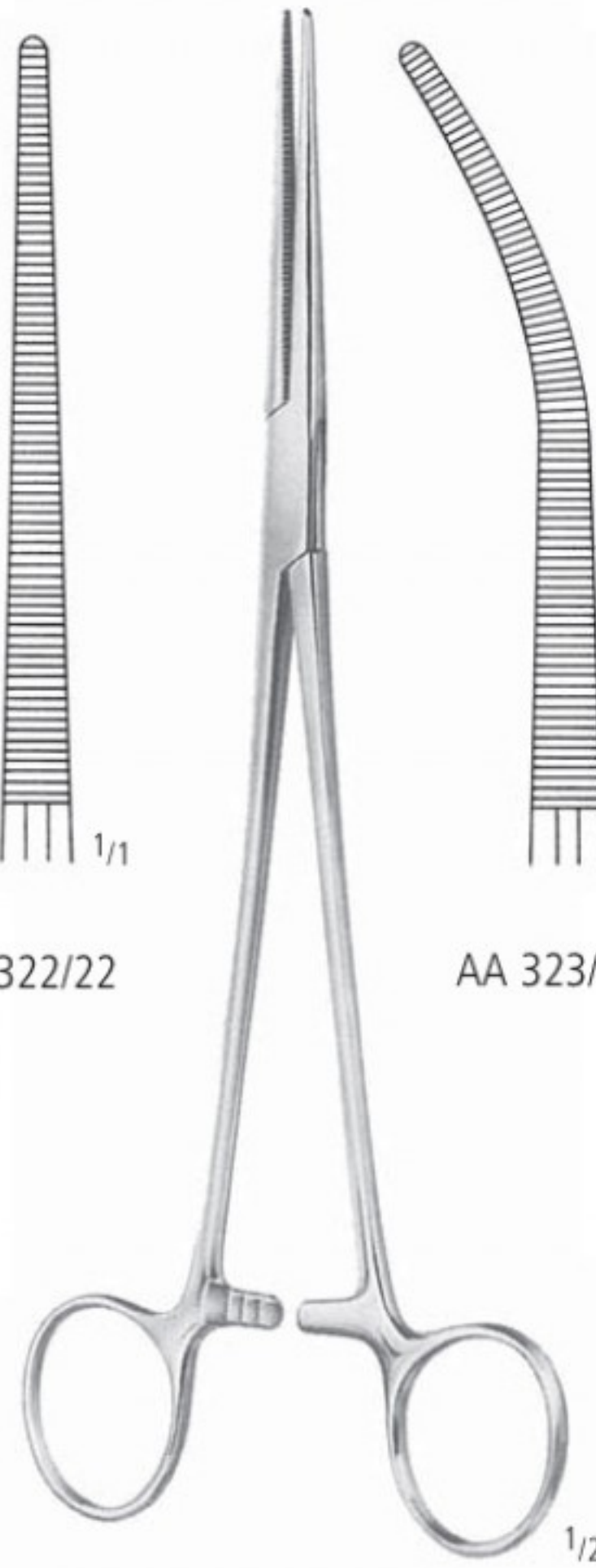

ROBERTS
22,0 cm/8³/₄"

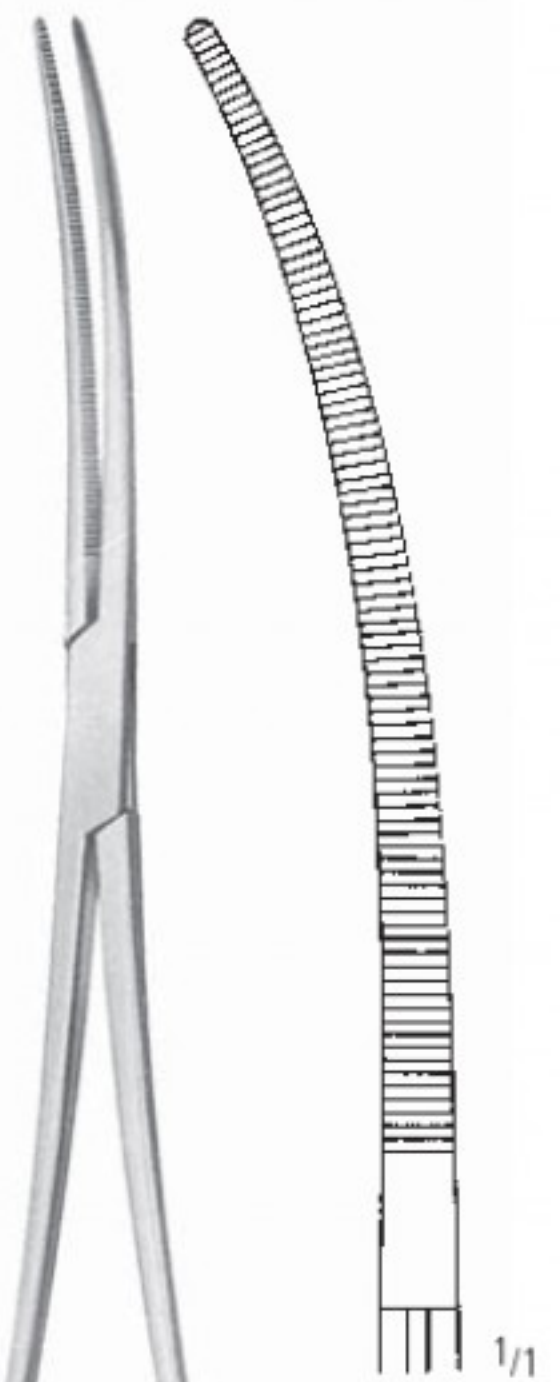

1/1

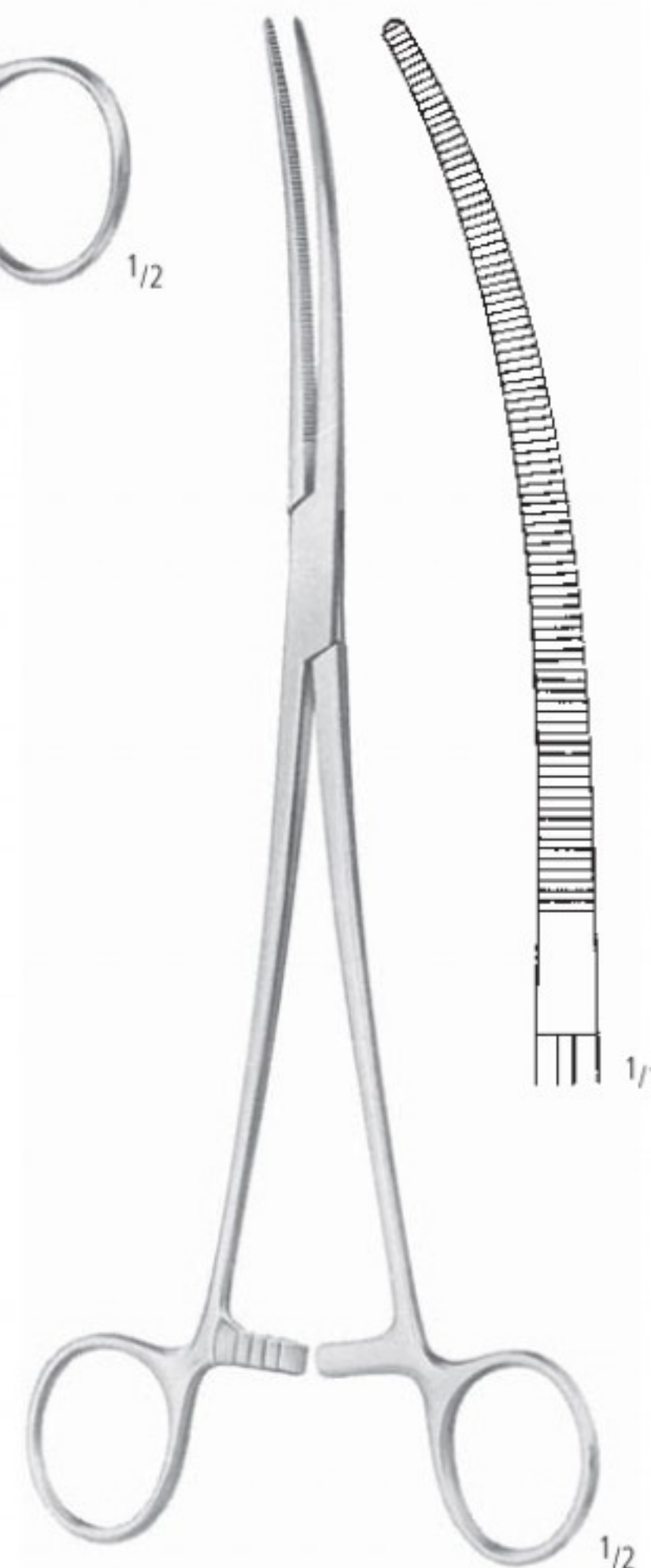

CRAFOORD
AA 330/24
24,0 cm/9¹/₂"

KLEMMEN HEMOSTATS PINZAS HEMOSTATICAS PINCES HEMOSTATIQUES PINZE EMOSTATICHE

Präparier- und Ligaturklemmen
 Dissecting and Ligature Forceps
 Pinzas para preparaciones y ligaduras
 Pincès à disséquer et à ligatures
 Pinze per preparazioni e legature

AA
 AB
 AC
 AD
 AE
 AF
 AK
 AL
 AO
 KA
 KK
 X



RUMEL
 23,0 cm/9"



AA 335/01

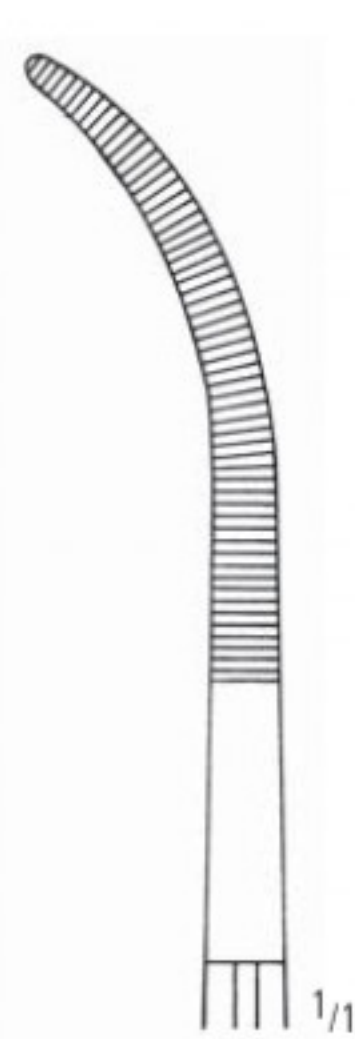

AA 335/02

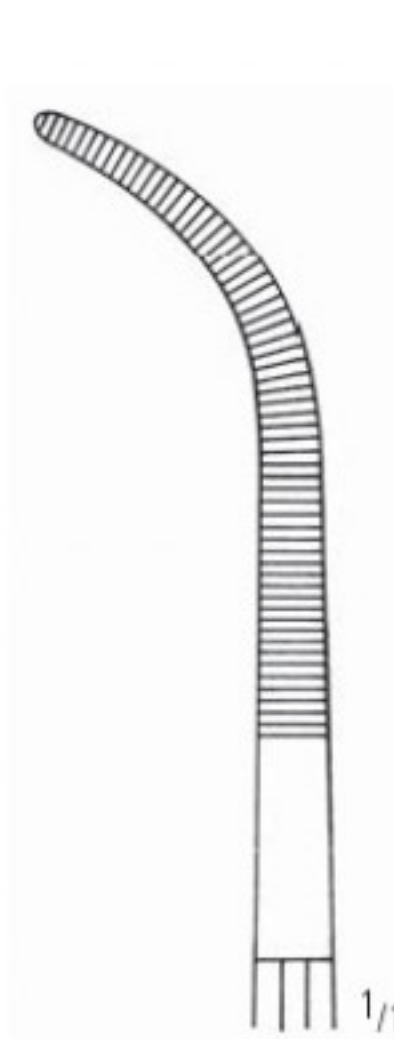

AA 335/03

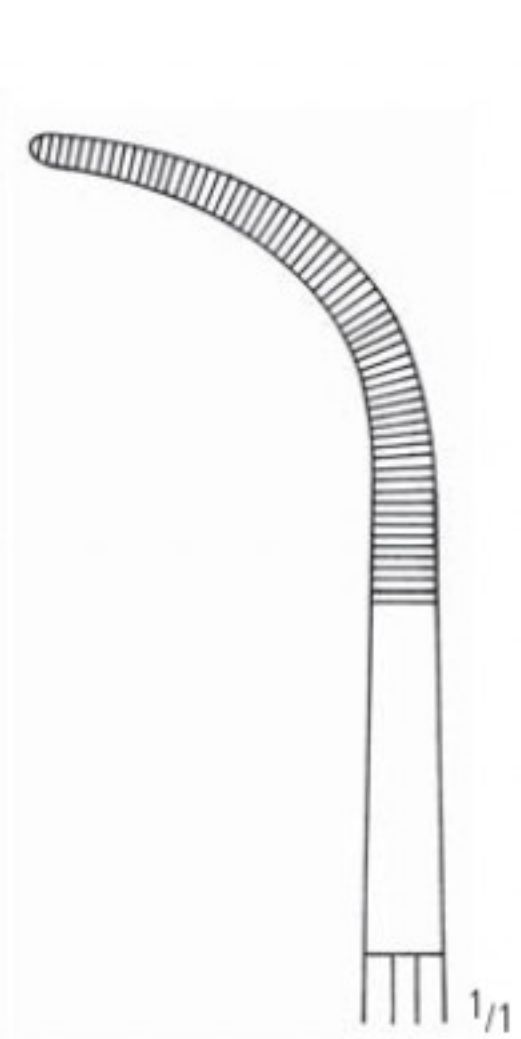

AA 335/04

Präparier- und Ligaturklemmen
 Dissecting and Ligature Forceps
 Pinzas para preparaciones y ligaduras
 Pincés à disséquer et à ligatures
 Pinze per preparazioni e legature

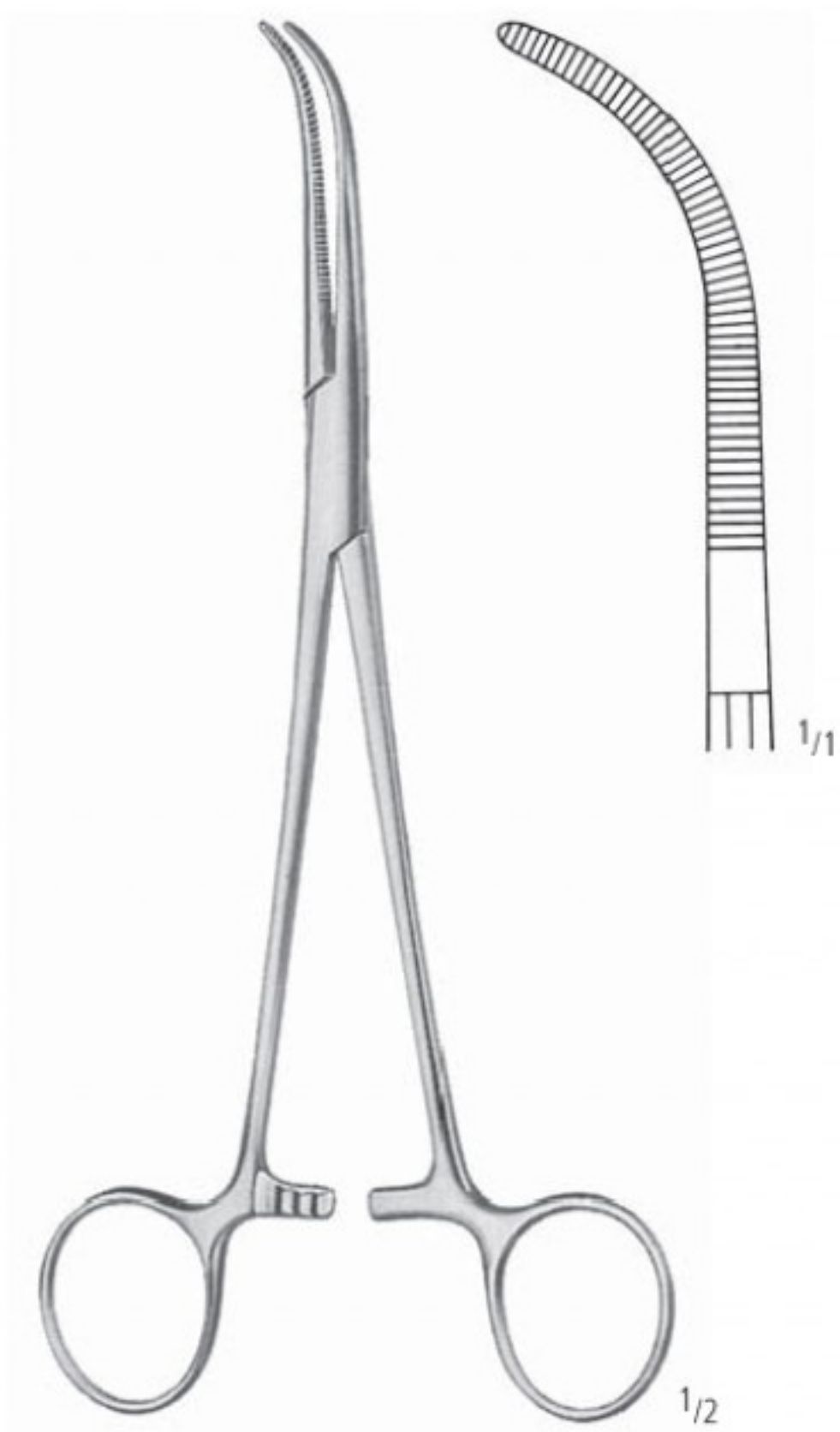

JOHNS HOPKINS
 AA 338/20
 20,0 cm/8"

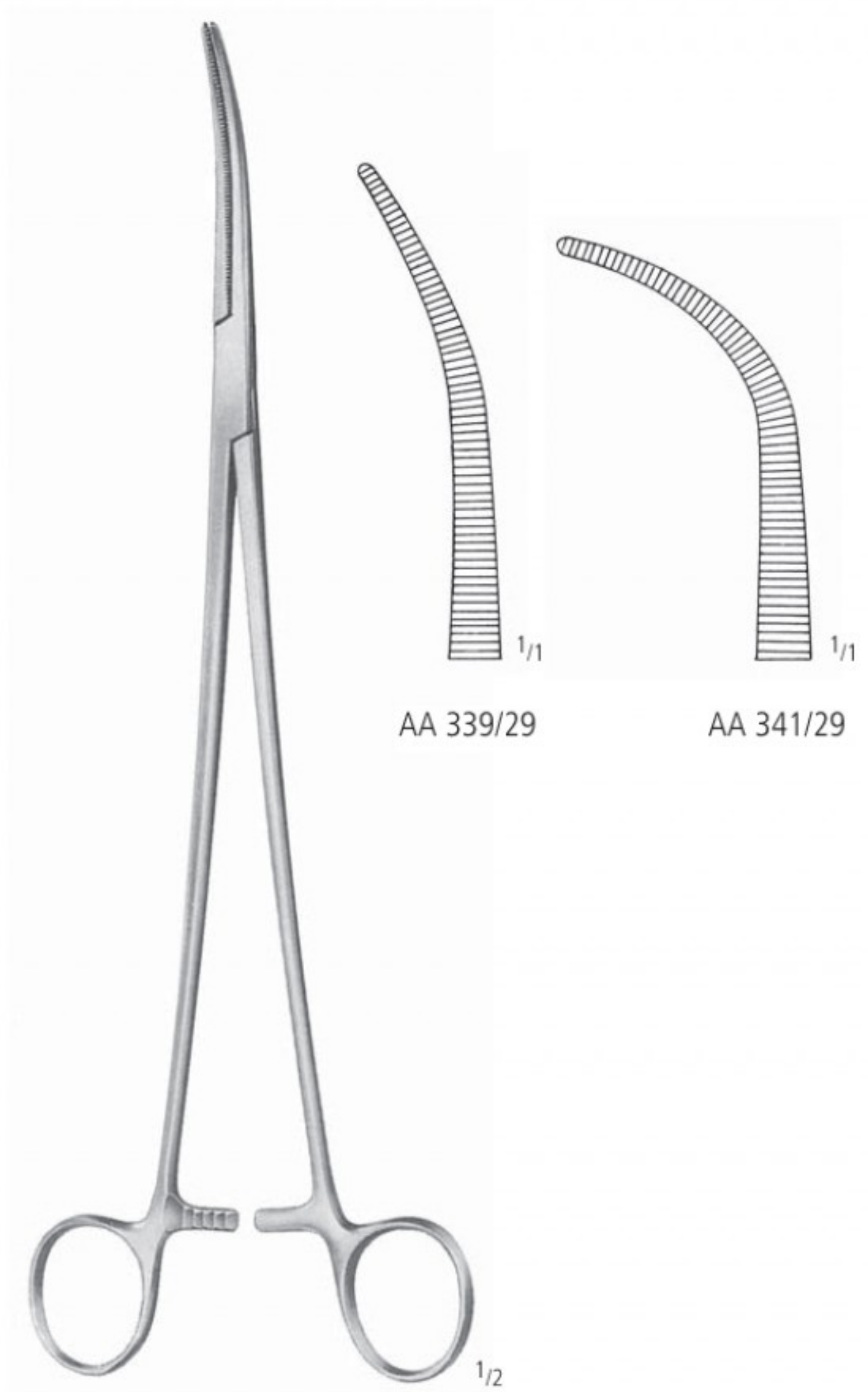

ZENKER
 29,5 cm/11 1/2"

KLEMMEN HEMOSTATS PINZAS HEMOSTATICAS PINCES HEMOSTATIQUES PINZE EMOSTATICHE

Präparier- und Ligaturklemmen
 Dissecting and Ligature Forceps
 Pinzas para preparaciones y ligaduras
 Pincès à disséquer et à ligatures
 Pinze per preparazioni e legature

AA
 AB
 AC
 AD
 AE
 AF
 AK
 AL
 AO
 KA
 KK
 X



MIXTER
 15,5 cm/6"
 19,0 cm/7½"

AA 345/15
 AA 345/19

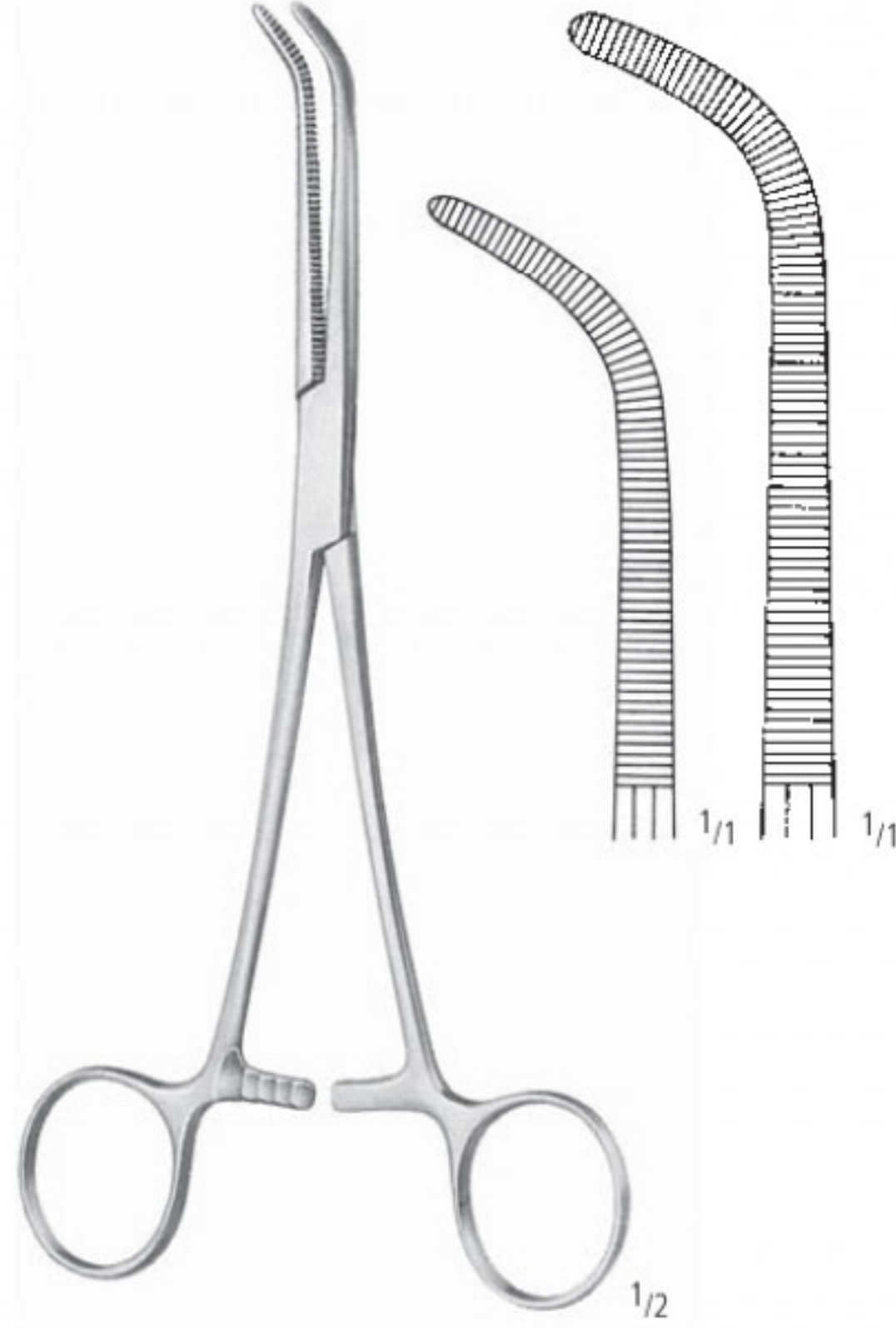

MIXTER-O'SHAUGNESSY
 15,5 cm/6"
 19,0 cm/7½"

AA 347/15
 AA 347/19

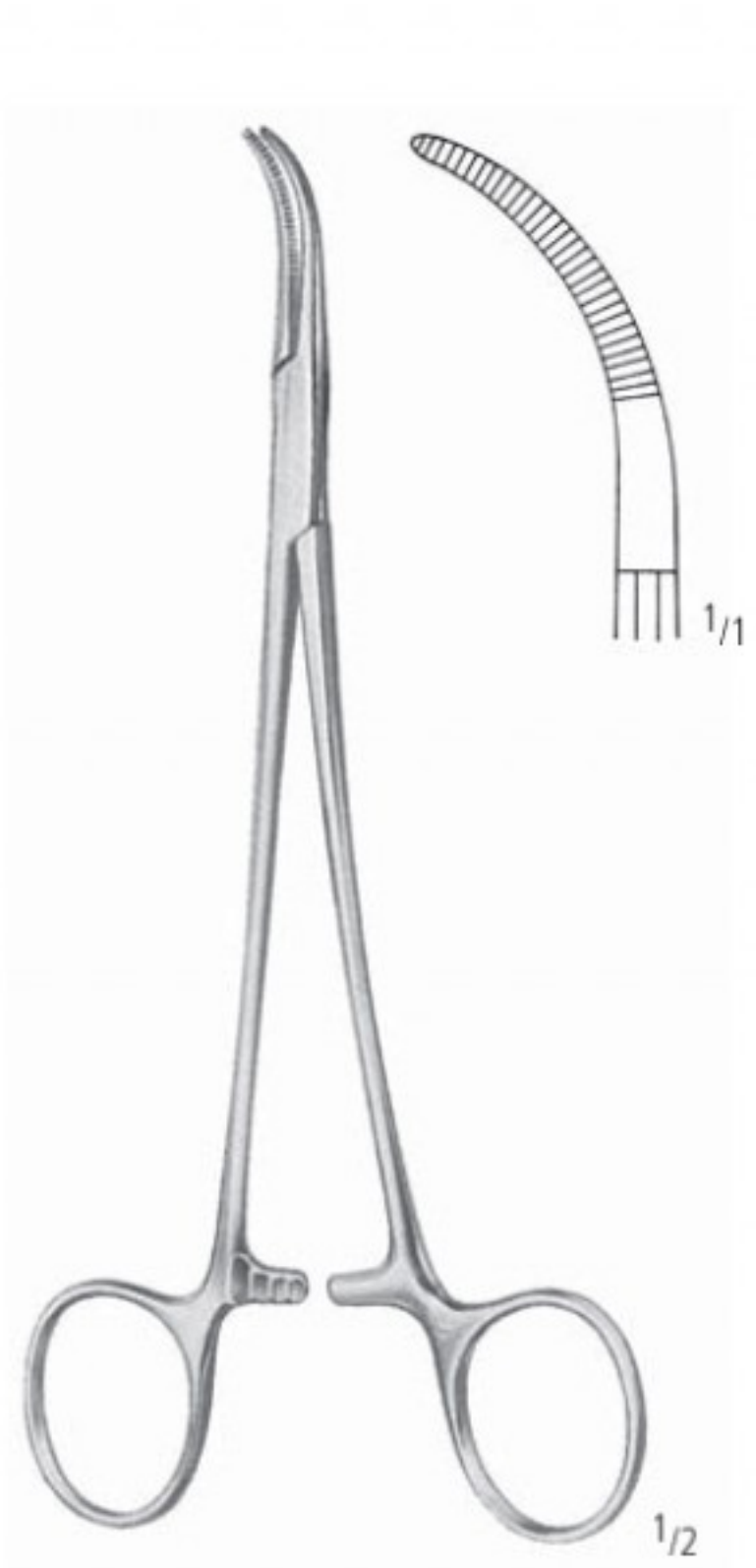

BABY-MIXTER
 18,0 cm/7"

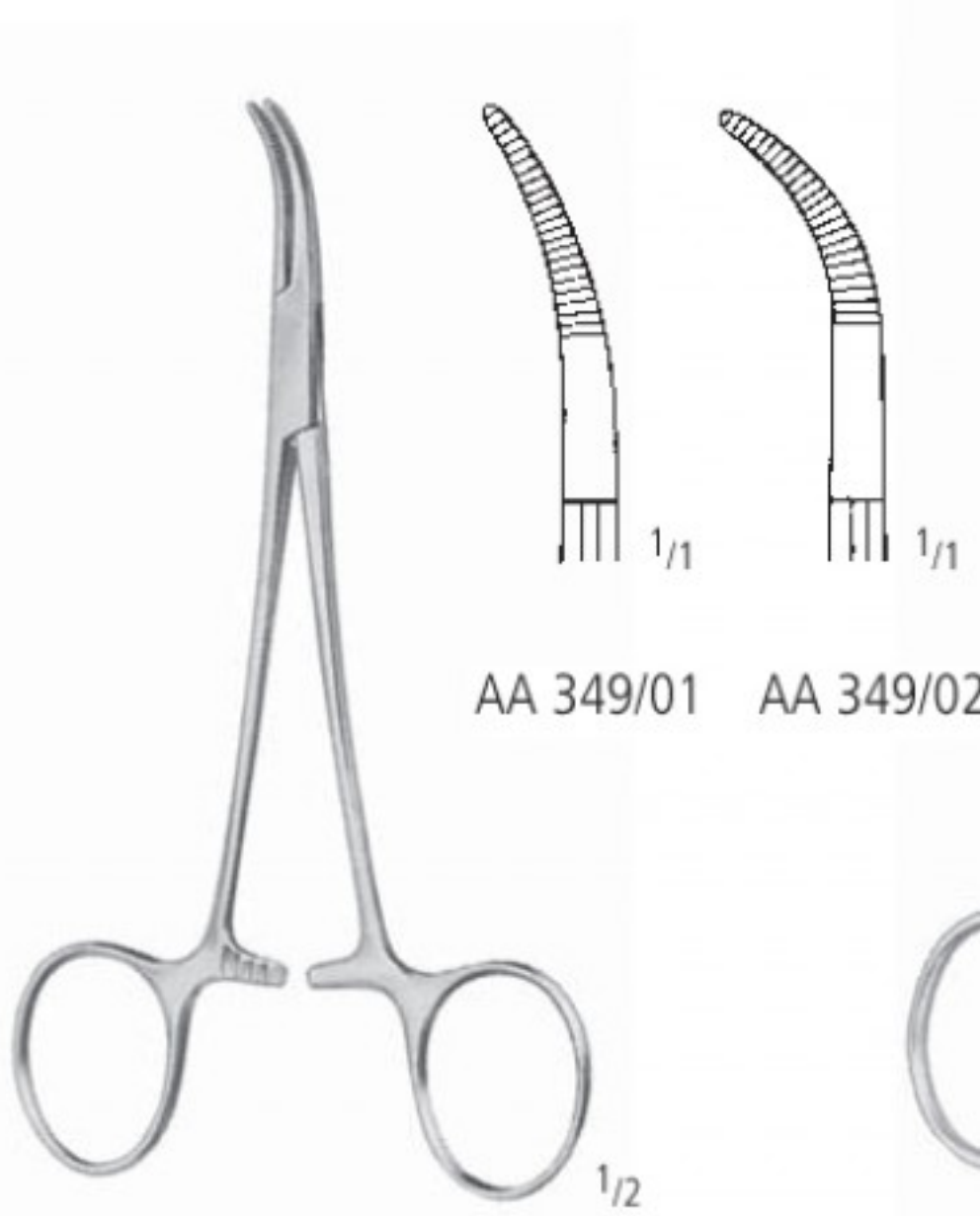

BABY-MIXTER
 14,0 cm/5½"

AA 349/01 AA 349/02

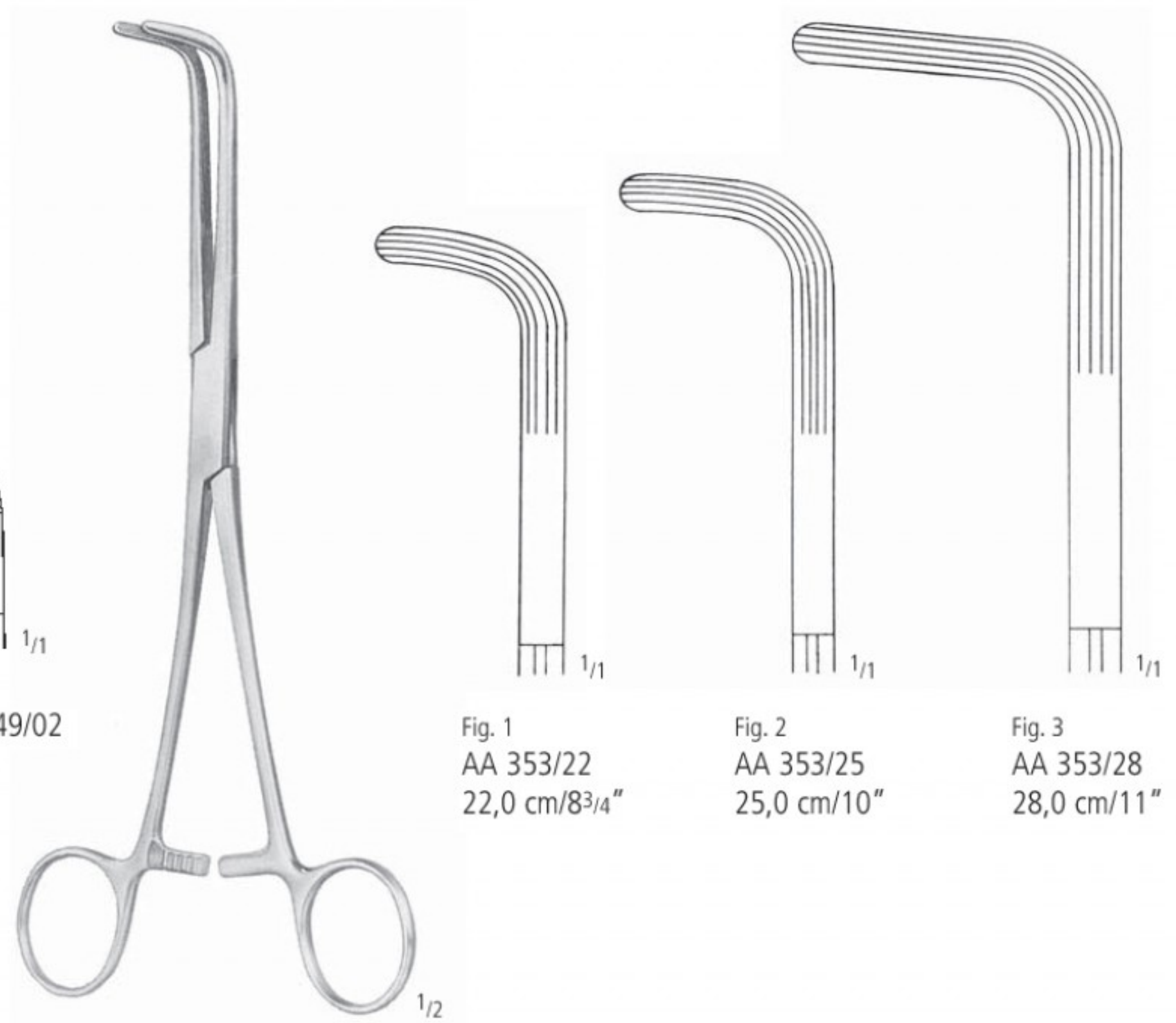

MIXTER

Fig. 1
 AA 353/22
 22,0 cm/8¾"

Fig. 2
 AA 353/25
 25,0 cm/10"

Fig. 3
 AA 353/28
 28,0 cm/11"

Präparier- und Ligaturklemmen
 Dissecting and Ligature Forceps
 Pinzas para preparaciones y ligaduras
 Pincès à disséquer et à ligatures
 Pinze per preparazioni e legature



MIXTER
 AA 355/23
 23,0 cm/9"



BRIDGE
 28,0 cm/11"



LAWRENCE
 AA 361/28
 28,0 cm/11"

KLEMMEN HEMOSTATS PINZAS HEMOSTATICAS PINCES HEMOSTATIQUES PINZE EMOSTATICHE

Präparier- und Ligaturklemmen
 Dissecting and Ligature Forceps
 Pinzas para preparaciones y ligaduras
 Pincès à disséquer et à ligatures
 Pinze per preparazioni e legature

AA
 AB
 AC
 AD
 AE
 AF
 AK
 AL
 AO
 KA
 KK
 X



KANTROWITZ

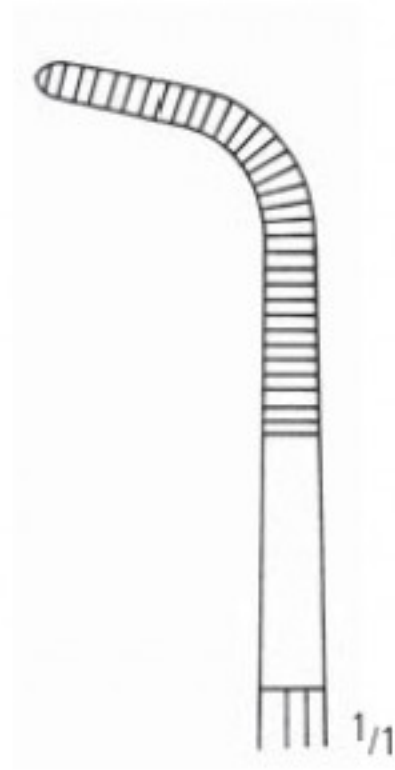

AA 363/20
 20,0 cm/8"

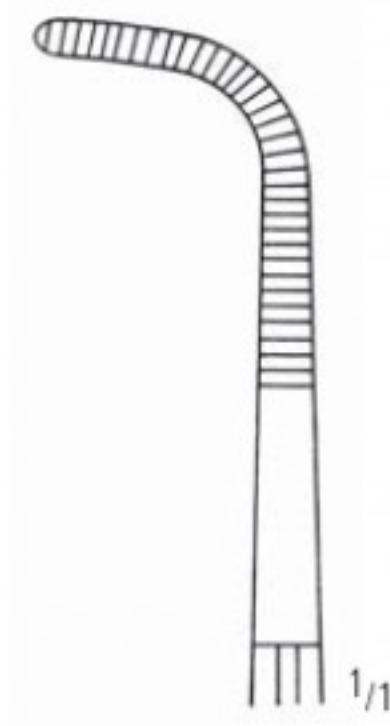

AA 363/24
 24,0 cm/9 1/2"

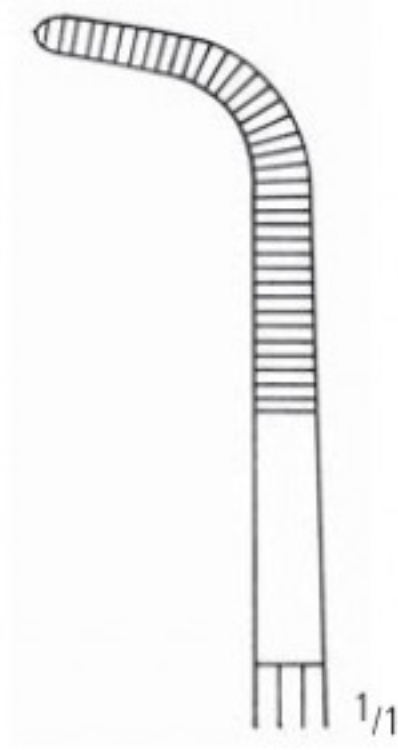

AA 363/28
 28,0 cm/11"



GEMINI



AA 365/14
 14,0 cm/5 1/2"

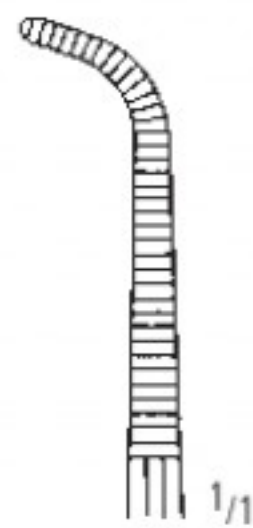

AA 365/18
 18,0 cm/7"

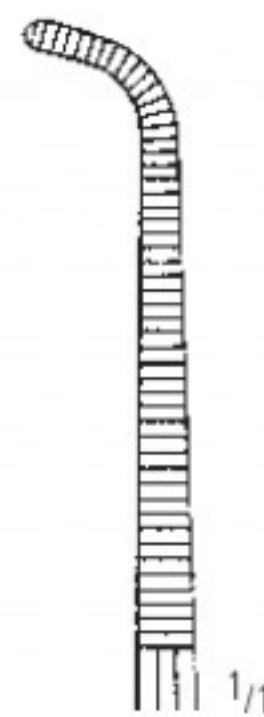

AA 365/22
 22,0 cm/8 3/4"

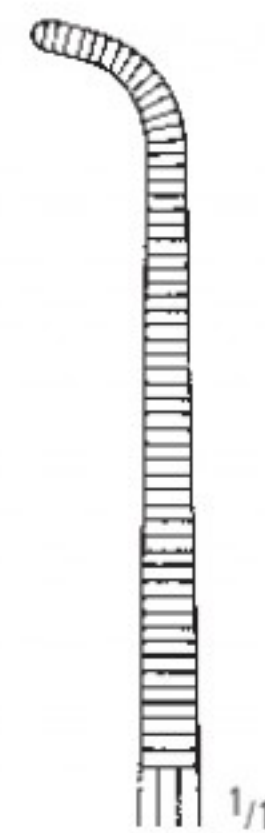

AA 365/25
 25,0 cm/10"

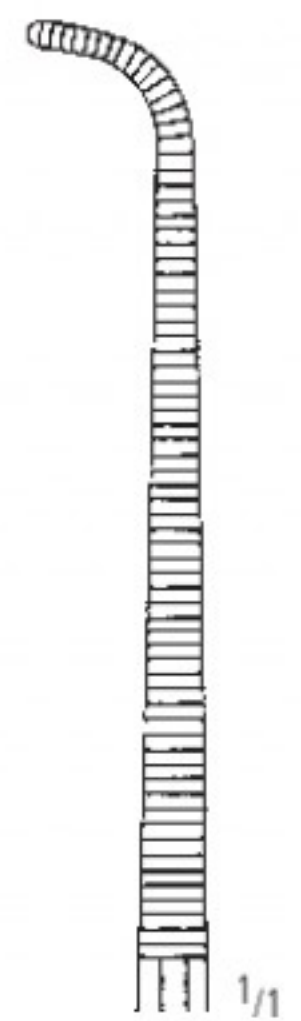

AA 365/28
 28,0 cm/11"

Präparier- und Ligaturklemmen
 Dissecting and Ligature Forceps
 Pinzas para preparaciones y ligaduras
 Pincès à disséquer et à ligatures
 Pinze per preparazioni e legature

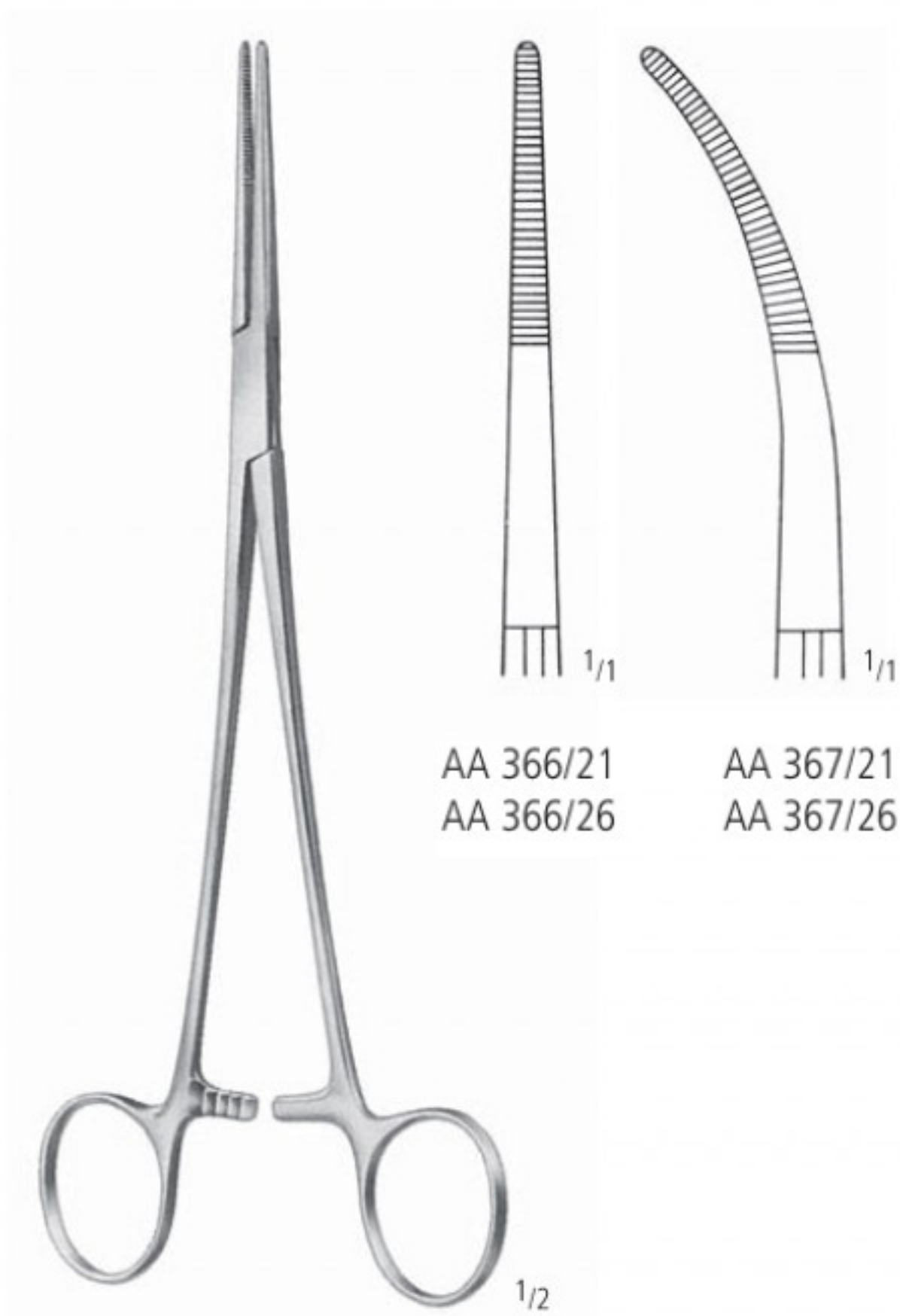

AA 366/21
 AA 366/26

AA 367/21
 AA 367/26

TOENNIS
 21,0 cm/8¹/₄"
 26,0 cm/10¹/₂"

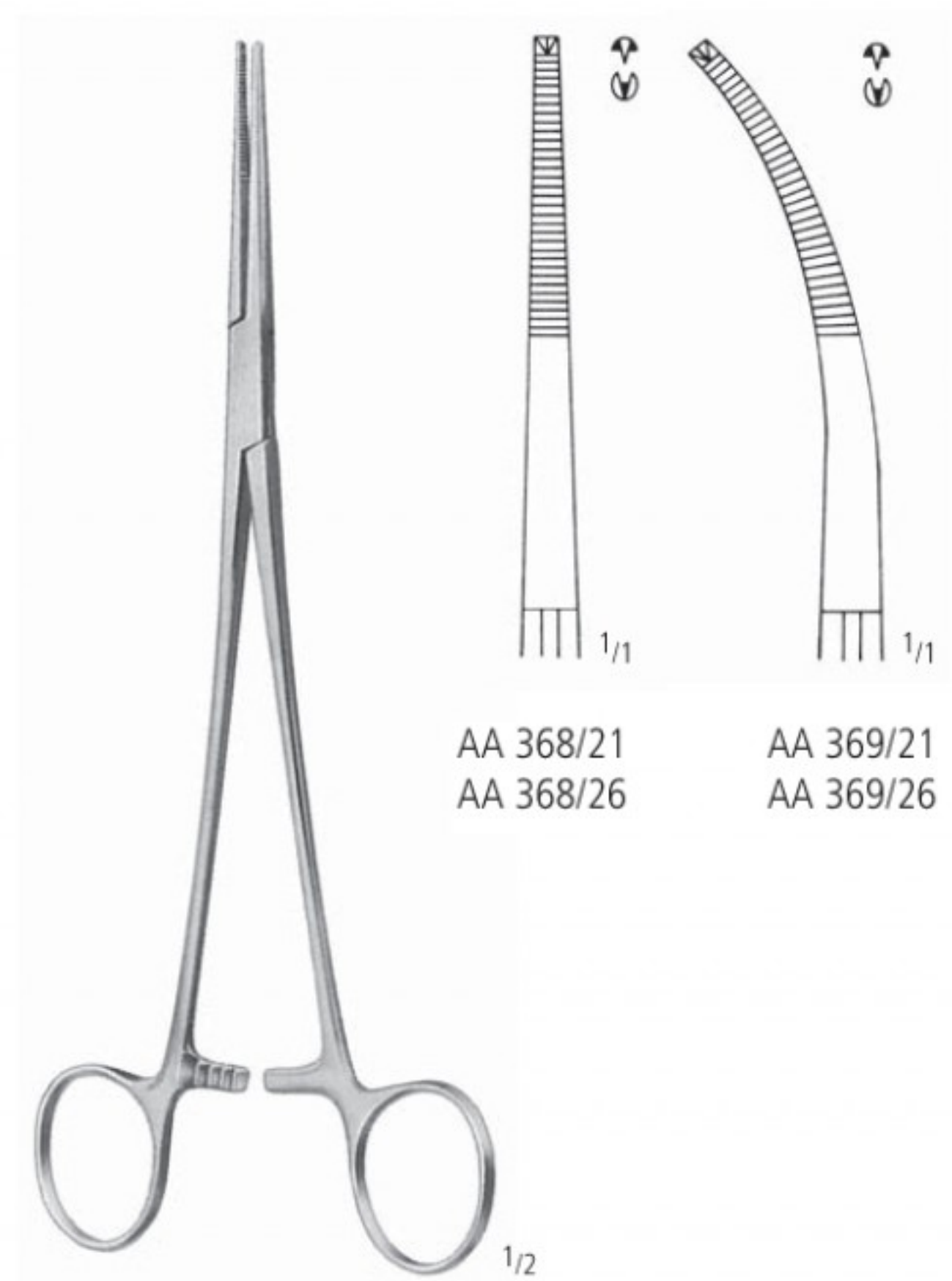

AA 368/21
 AA 368/26

AA 369/21
 AA 369/26

TOENNIS 1:2
 21,0 cm/8¹/₄"
 26,0 cm/10¹/₂"

Präparier- und Ligaturklemmen
 Dissecting and Ligature Forceps
 Pinzas para preparaciones y ligaduras
 Pincès à disséquer et à ligatures
 Pinze per preparazioni e legature

AA
 AB
 AC
 AD
 AE
 AF
 AG
 AH
 AI
 AJ
 AK
 AL
 AM
 AN
 AO
 AP
 AQ
 AR
 AS
 AT
 AU
 AV
 AW
 AX

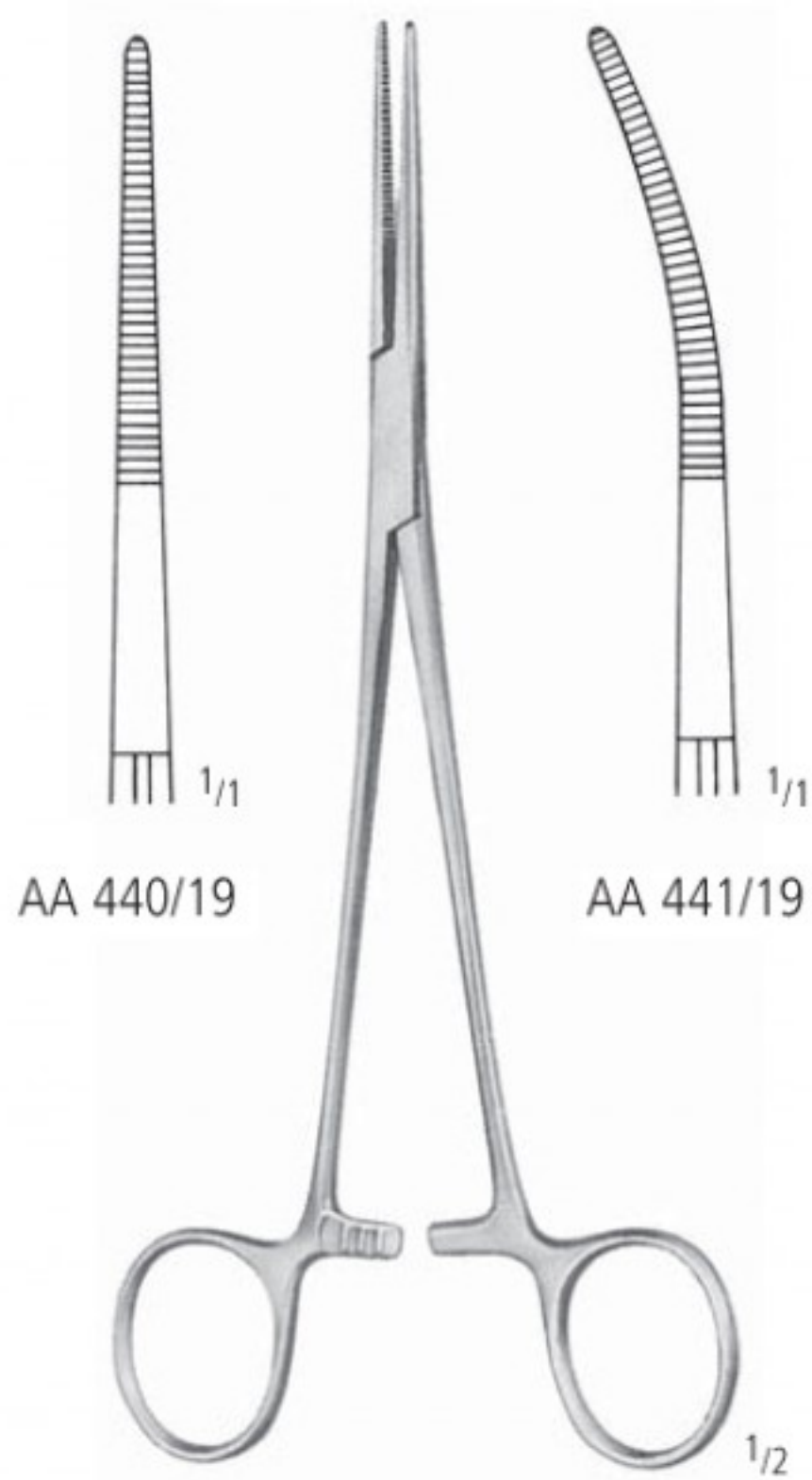

BIRKETT
 19,0 cm/7¹/₂"

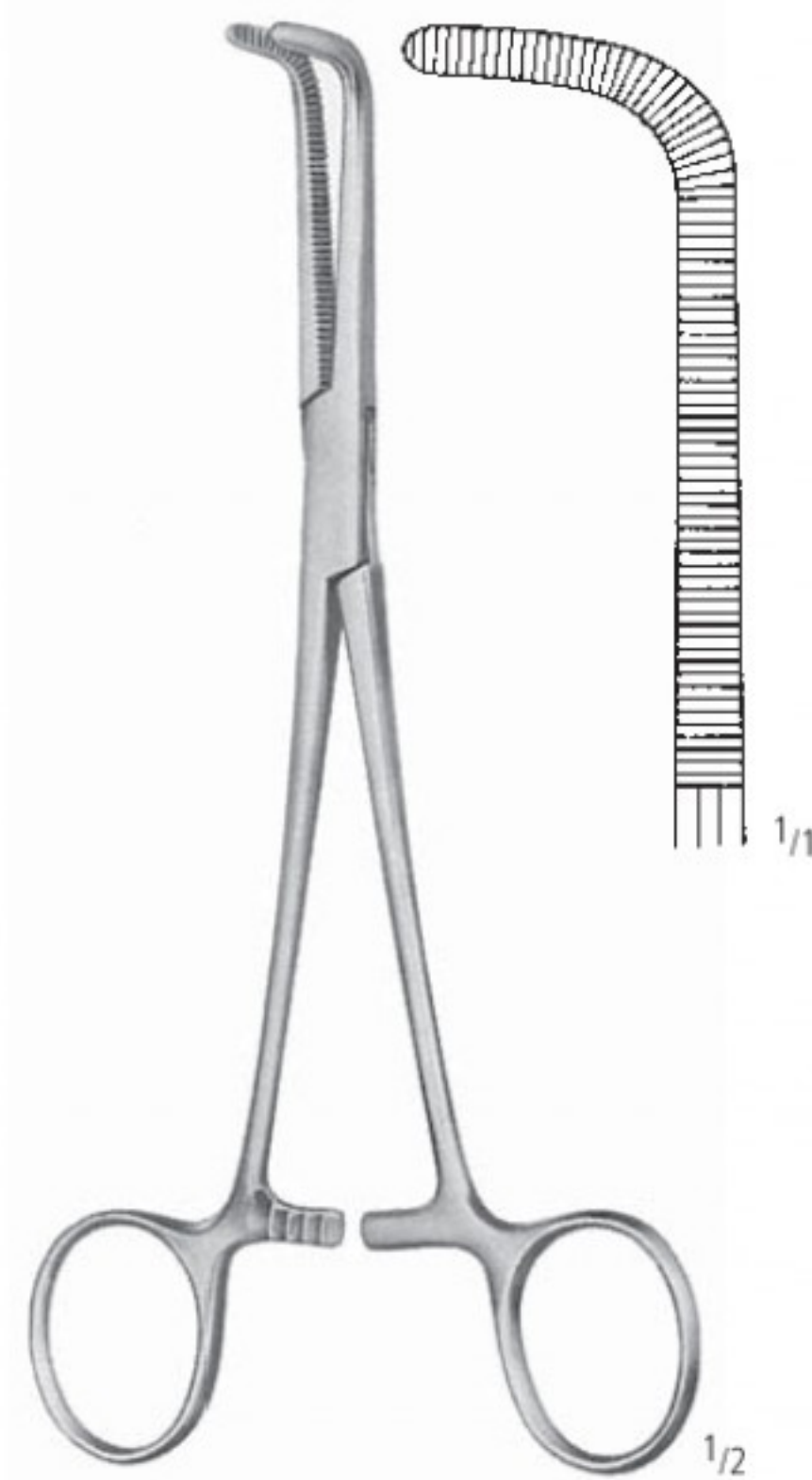

WIKSTROEM
 AA 443/19
 19,0 cm/7¹/₂"

Tuchklemmen
Towel Forceps
Pinzas para compresas, Pinzas de campo
Pinces à champs, Pinces à compresses
Pinze per fissare le compresse (Fissatele)

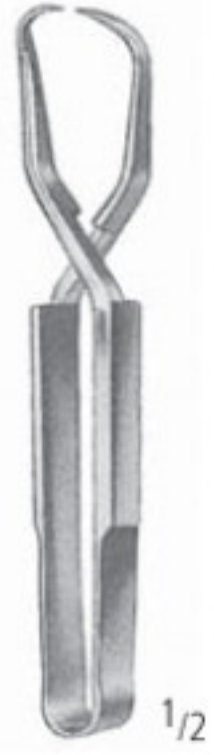

SCHAEDEL
AA 710/09
9,0 cm/3 1/2"



JONES
5,0 cm/2"
9,0 cm/3 1/2" AA 711/05
AA 711/09



ENGL. MODELL
AA 717/09
9,0 cm/3 1/2"



DOYEN
AA 721/18
18,0 cm/7"



BERNHARD
AA 726/16
16,5 cm/6 1/2"



LANE
15,0 cm/6"
18,0 cm/7"
20,0 cm/8" AA 730/15
AA 730/18
AA 730/20

KLEMMEN HEMOSTATS PINZAS HEMOSTATICAS PINCES HEMOSTATIQUES PINZE EMOSTATICHE

Tuchklemmen
Towel Forceps
Pinzas para compresas, Pinzas de campo
Pinces à champs, Pinces à compresses
Pinze per fissare le compresse (Fissatele)

AA

AB

AC

AD

AE

AF

AK

AL

AO

KA

KK

X



AA 749/11

11,0 cm/4¹/₃"

- mit Schlauch- oder Kabelhalter
- with clip for tubing or cable
- con porta-tubo o porta-cable
- avec clamp porte-tube ou porte-corton d'alimentation
- con porta tubo o porta cavo

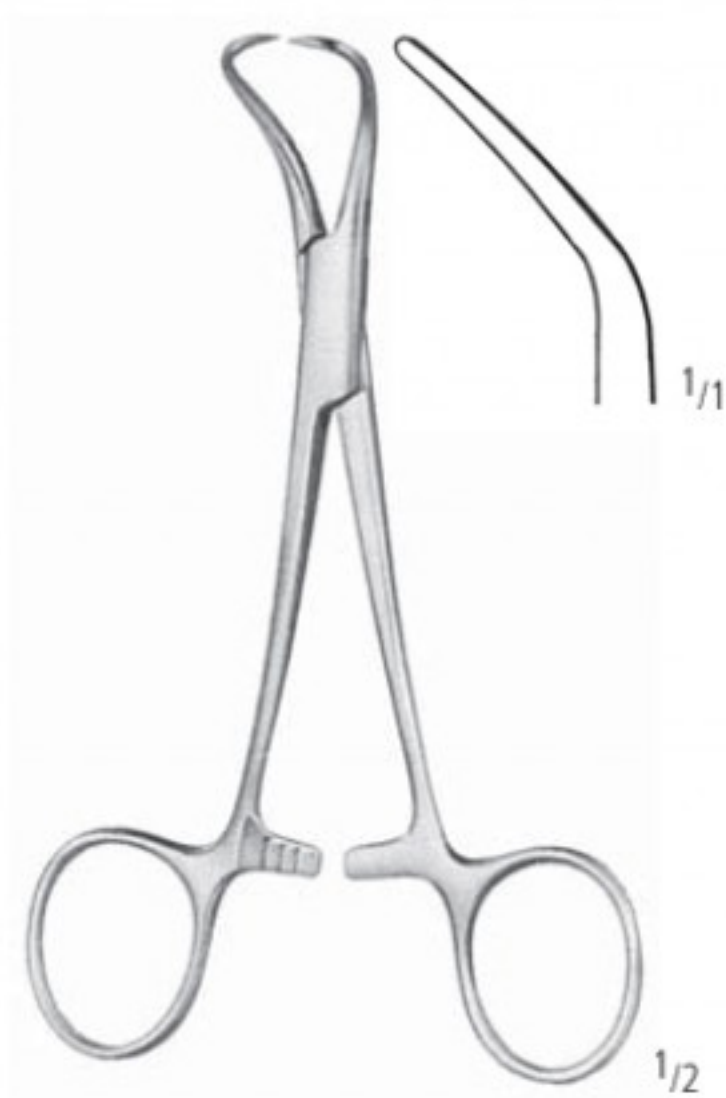

BACKHAUS

- | | |
|---|-----------|
| 8,0 cm/3" | AA 751/08 |
| 11,0 cm/4 ¹ / ₃ " | AA 751/11 |
| 13,0 cm/5" | AA 751/13 |
| 15,0 cm/6" | AA 751/15 |



BALL & SOCKET

- | | |
|---|-----------|
| 11,0 cm/4 ¹ / ₃ " | AA 753/11 |
| 13,0 cm/5" | AA 753/13 |



ROEDER

- | | |
|------------|-----------|
| 13,0 cm/5" | AA 761/13 |
| 15,0 cm/6" | AA 761/15 |

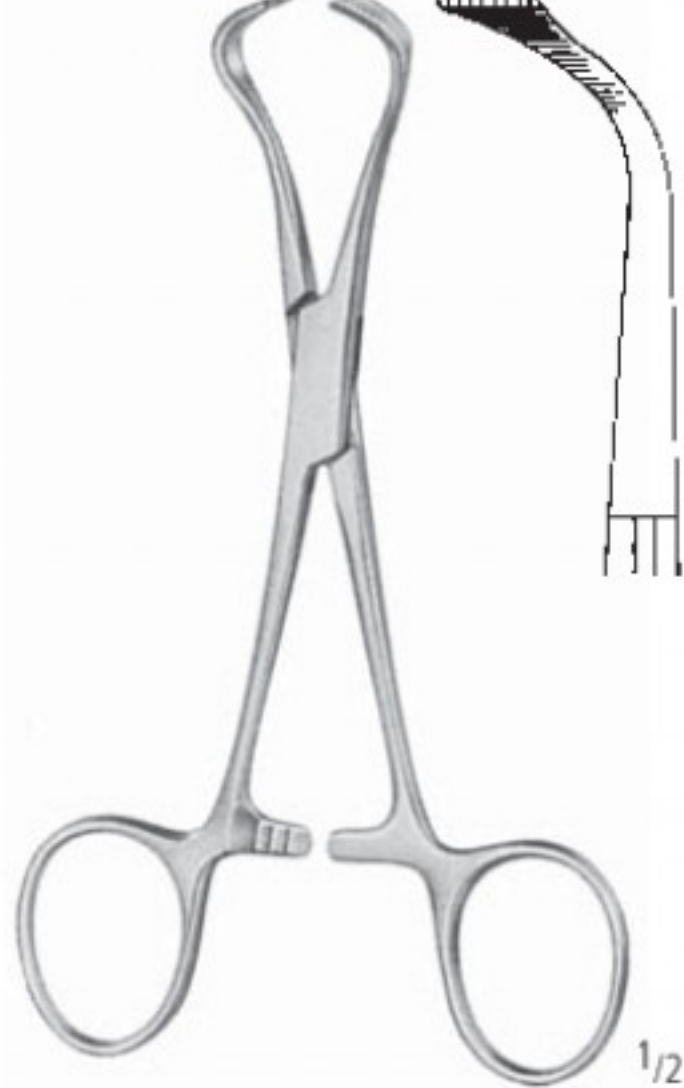

LORNA

- | | |
|------------|-----------|
| 10,0 cm/4" | AA 763/10 |
| 13,0 cm/5" | AA 763/13 |

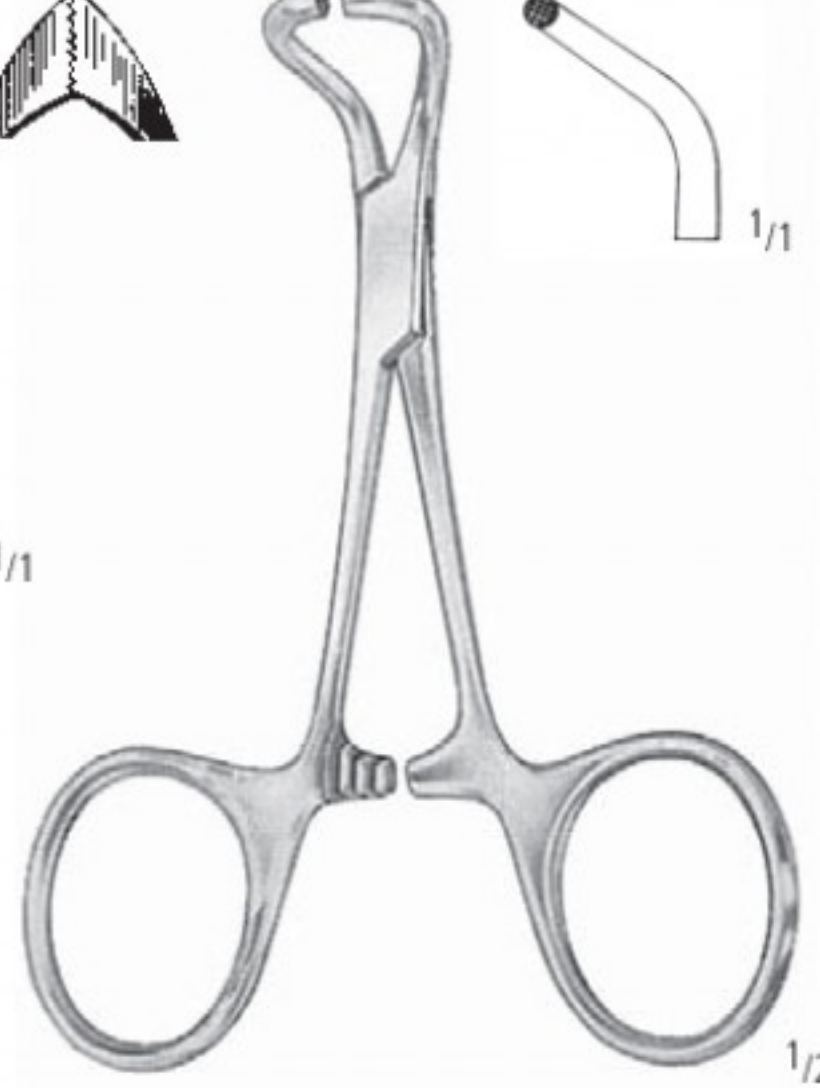

TOHOKU-JAPAN

- | | |
|------------|-----------|
| 10,0 cm/4" | AA 764/10 |
| 13,0 cm/5" | AA 764/13 |



PEERS

- | |
|---|
| AA 765/14 |
| 14,5 cm/5 ³ / ₄ " |

für Papiertücher
for paper tissues
para servilletas de papel
pour serviettes en papier
per tessuti di carta

Schlauchklemmen
Tubing Clamps
Pinzas para tubos
Presses-tube
Pinze serratubi

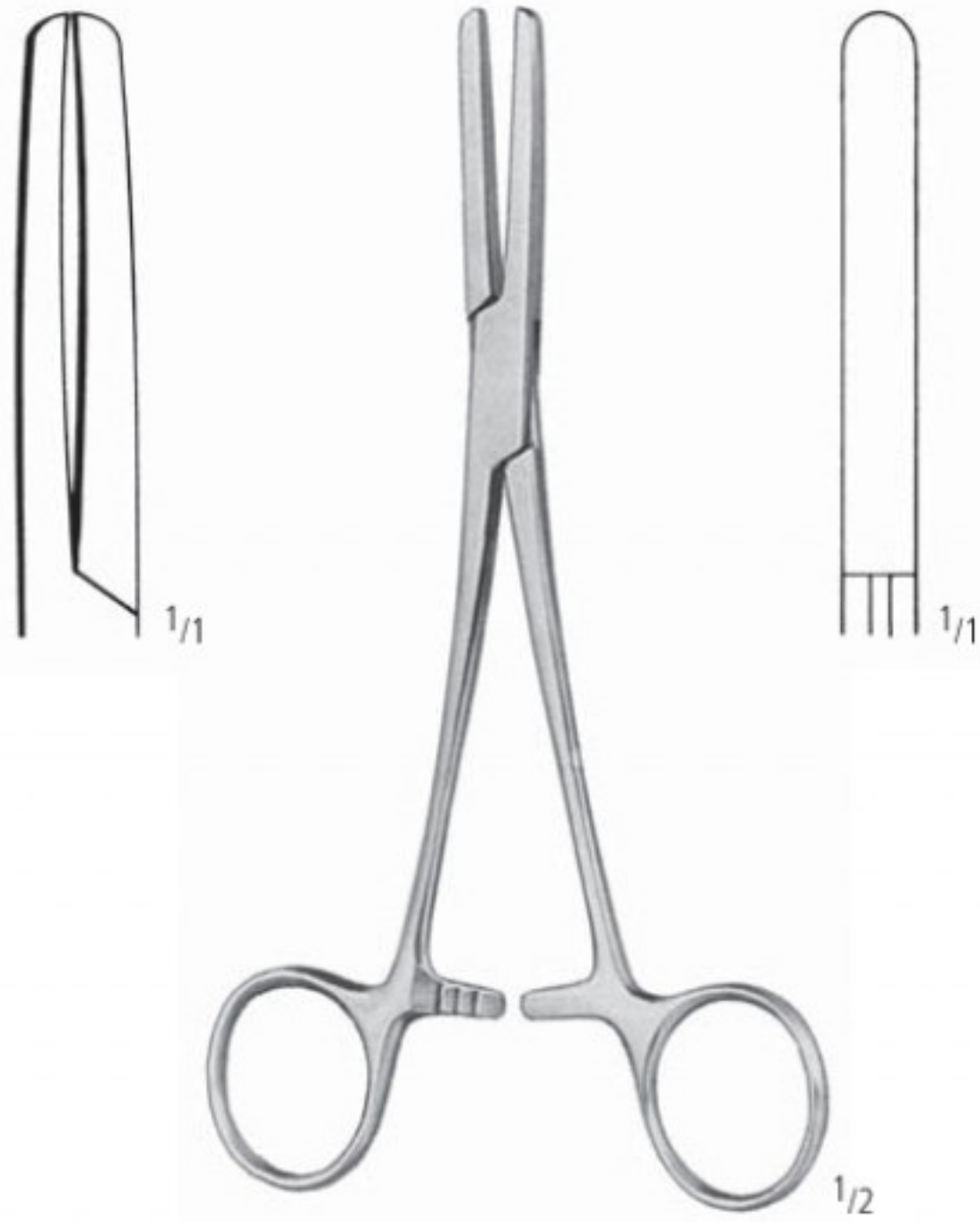

PRESBYTERIAN

16,5 cm/6¹/₂" AA 790/16
18,0 cm/7" AA 790/18



KLINIKUM BERLIN

AA 792/14
14,5 cm/5³/₄"
mit langer Sperre
with long ratchet
con cremallera larga
à crémaillère extra longue
con cremagliera extra lunga



AA 794/15

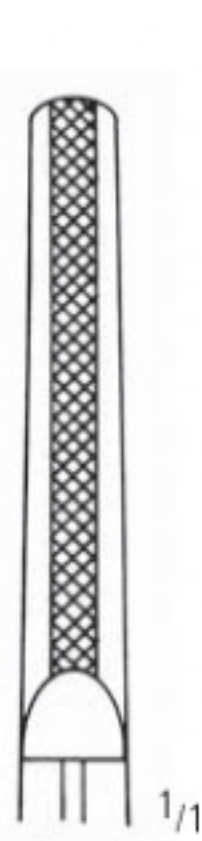

AA 794/18

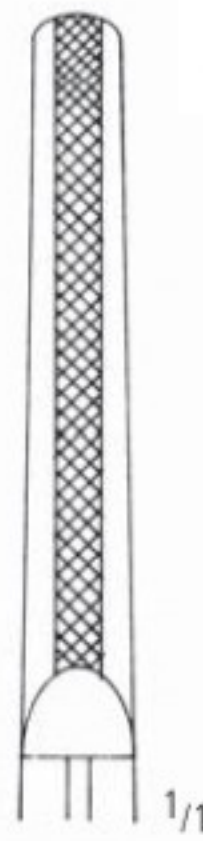

AA 794/20

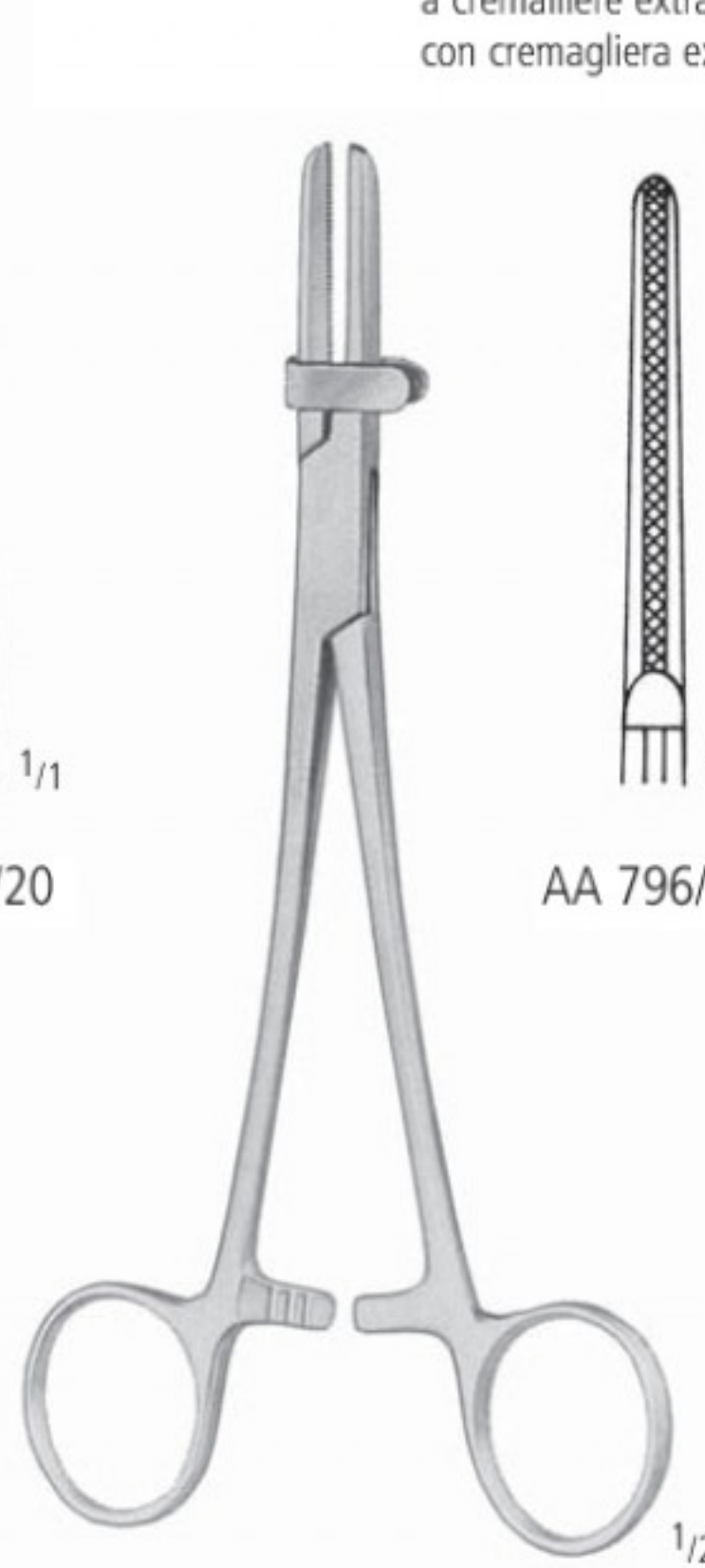

AA 796/15

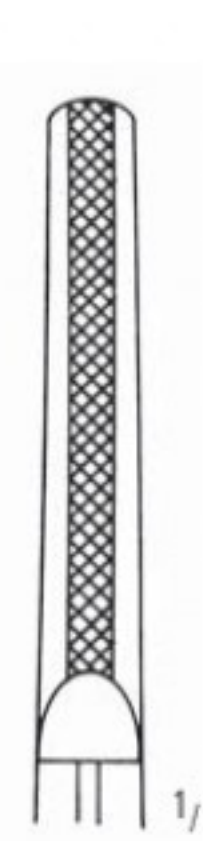

AA 796/18

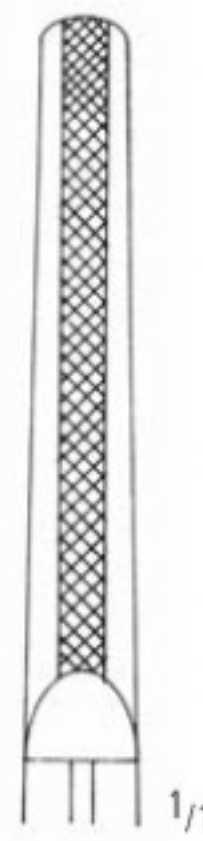

AA 796/20

AA 794/15
AA 794/18
AA 794/20

15,5 cm/6"
18,0 cm/7"
20,0 cm/8"

AA 796/15
AA 796/18
AA 796/20

tini[®] instruments

nopa[®] instruments

titan-nitrid Beschichtung
titan-nitride surface coating



tini

AB

>> Pinzetten • Forceps • Pinzas • Pinces • Pinze



AC

>> Scheren • Scissors • Tijeras • Ciseaux • Forbici



AE

>> Naht • Suture • Sutura • Suture • Sutura



KA

>> Orthopädie • Orthopaedics • Ortopedia • Orthopédie • Ortopedia

KK

>> Herz/Thorax • Cardiovascular • Cardiovascular • Cardiovasculaire • Cardiovascolare

KS

>> Neurochirurgie • Neurosurgery • Neurocirugía • Neurochirurgie • Neurochirurgia

- >> extrem lange Lebensdauer und Einsatzfähigkeit
- >> enorm hohe Verschleißfestigkeit - nur selten Nachschleifen notwendig
- >> blendfreie Oberfläche - keine störenden Lichtreflexionen
- >> mikroglatte Oberfläche - deutlich verbesserte Korrosionsbeständigkeit
- >> titan-nitrid ist gewebeverträglich und biokompatibel
- >> anti-allergene Schutzfunktion

- >> longer durability and usability
- >> enormous high abrasion resistance - sharpening is hardly ever necessary
- >> reduction of reflective glare - no incommoding luminous reflectance
- >> micro-smooth surface - obviously improved corrosion resistance
- >> titan-nitride is tissuecompatible and biocompatible
- >> anallergenic protection



PINZETTEN
FORCEPS
PINZAS
PINCES
PINZE

AB

nopa[®] instruments

Weitere Pinzetten finden Sie in unserem Katalog "Allgemeine Chirurgie" in Gruppe AB.

For further forceps kindly refer to our catalogue "General Surgery", section AB.

Para pinzas adicionales, por favor consulte nuestro catálogo de "Cirugía general", grupo AB.

Pour des pinces supplémentaires, consultez notre catalogue "Chirurgie Generale", section AB.

Per gli altri pinze, consultare il nostro catalogo "Chirurgia Generale", gruppo AB.







titan instruments

nopa[®] instruments

Besonderheit:

nopa Titan Instrumente bieten insbesondere in der Herz-Thorax-Chirurgie Vorteile gegenüber herkömmlichen Instrumenten. Titan ist ca. 45% leichter als rostfreier Edelstahl, weshalb Titan Instrumente weniger traumatisierend sind. Titan ist außerdem ein vollkommen korrosionsbeständiges und antimagnetisches Material. **nopa** Titan Instrumente bedeuten größtmöglichen Komfort für den Chirurgen.

Features:

nopa Titan Instruments provide especially in Cardiovascular surgery a significant advantage compared to other Instruments. Titan is approximately 45% lighter than stainless steel. For that reason, Titan Instruments are less traumatic. Besides that, Titan is a completely stainless and anti-magnetic material. **nopa** Titan Instruments are the most comfortable choice for the Cardiovascular surgeon.

AB 100/12 T	ADSON DRESSING FORCEPS 12,0 CM
AB 110/12 T	ADSON TISSUE FCPS 1X2 TEETH 12,0 CM
AB 116/07 T	ADSON-BROWN TISS. FCPS STR 7X7 TEETH 12,0 CM
AB 120/15 T	SEMKEN DRESSING FORCEPS STR 15,5 CM
AB 160/18 T	GERALD DRESSING FORCEPS STR 18,0 CM
AB 170/18 T	GERALD TISSUE FORCEPS STR 1X2 TEETH 17,0 CM
AB 542/15 T	SUTURE TYING FORCEPS 0,3 MM STR 15,0 CM
AB 860/16 T	DE BAKEY ATRAUMA FCPS STR 1,5 MM 16,0 CM
AB 860/20 T	DE BAKEY ATRAUMA FCPS STR 1.5 MM 20,0 CM
AB 860/24 T	DE BAKEY ATRAUMA FCPS STR 1.5 MM 24,0 CM
AB 862/16 T	DE BAKEY ATRAUMA FCPS STR 2.0 MM 16,0 CM
AB 862/20 T	DE BAKEY ATRAUMA FCPS STR 2.0 MM 20,0 CM
AB 862/24 T	DE BAKEY ATRAUMA FCPS STR 2.0 MM 24,0 CM
AB 864/16 T	DE BAKEY ATRAUMA FCPS STR 2.8 MM 16,0 CM
AB 864/20 T	DE BAKEY ATRAUMA FCPS STR 2.8 MM 20,0 CM



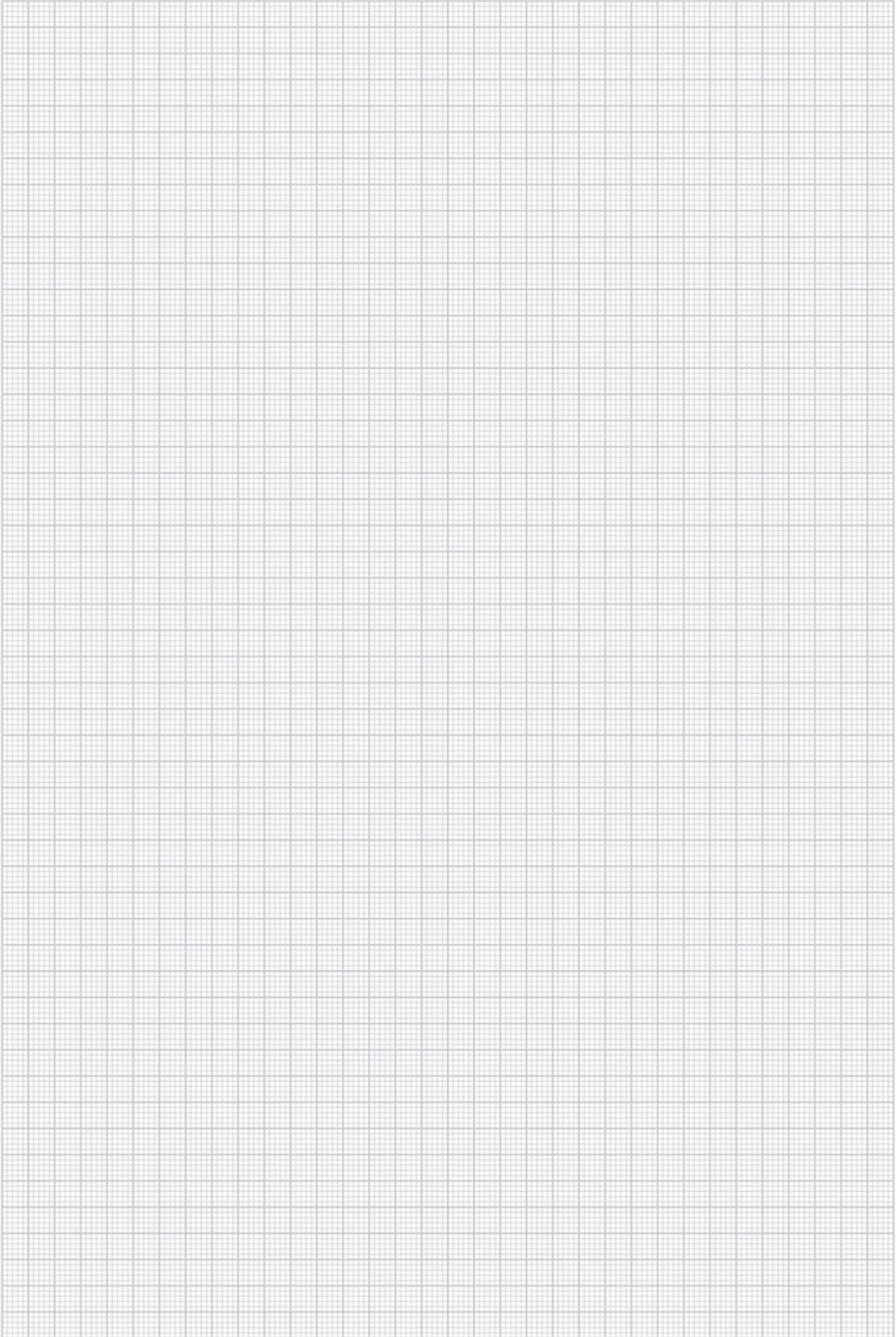

PINZETTEN FORCEPS PINZAS PINCES PINZE

Anatomische Pinzetten, Chirurgische Pinzetten
 Dressing Forceps, Tissue Forceps
 Pinzas de disección, Pinzas de disección con dientes
 Pincés à dissection, Pincés à griffes
 Pinze anatomiche per dissezione, Pinze chirurgiche a denti di topo

AA

AB

AC

AD

AE

AF

AK

AL

AO

KA

KK

X



1/2

STANDARD

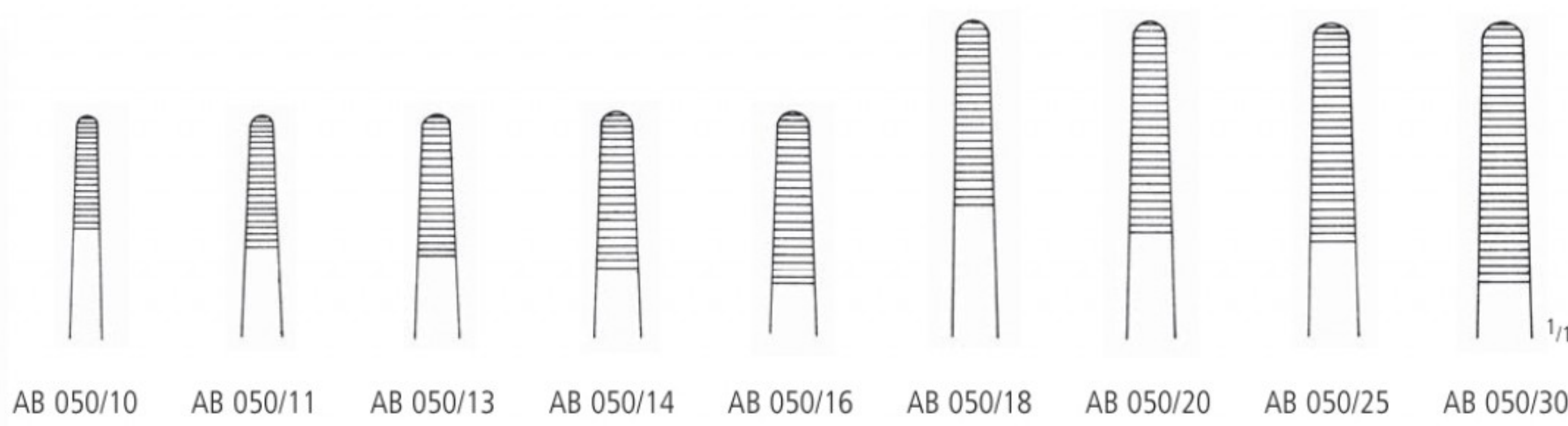

AB 050/10 AB 050/11 AB 050/13 AB 050/14 AB 050/16 AB 050/18 AB 050/20 AB 050/25 AB 050/30

10,5 cm/4 ¹ / ₄ "	AB 050/10
11,5 cm/4 ¹ / ₂ "	AB 050/11
13,0 cm/5"	AB 050/13
14,5 cm/5 ³ / ₄ "	AB 050/14
16,0 cm/6 ¹ / ₄ "	AB 050/16
18,0 cm/7"	AB 050/18
20,0 cm/8"	AB 050/20
25,0 cm/10"	AB 050/25
30,0 cm/12"	AB 050/30



1/2

1:2
STANDARD

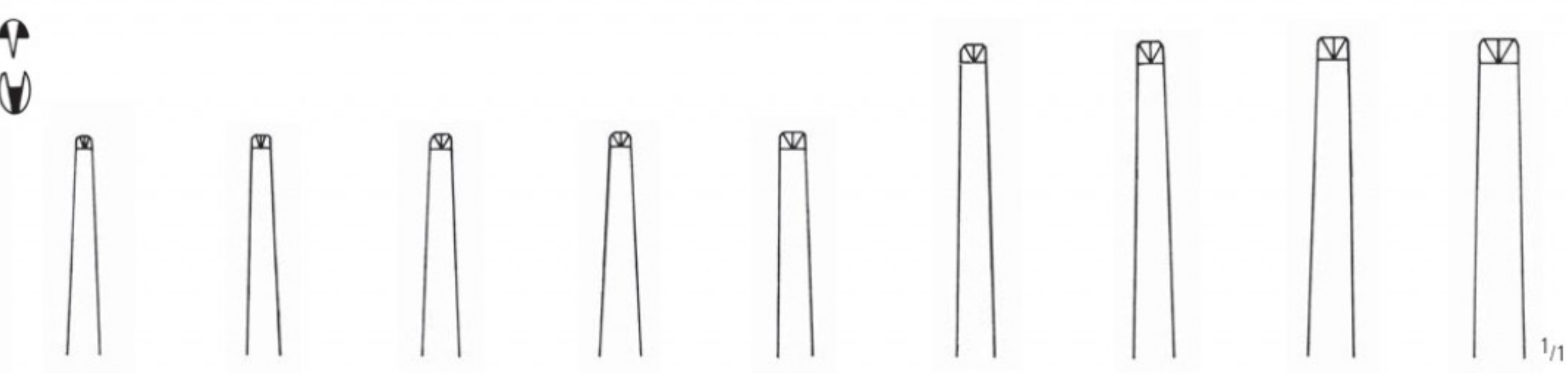

AB 060/10 AB 060/11 AB 060/13 AB 060/14 AB 060/16 AB 060/18 AB 060/20 AB 060/25 AB 060/30

10,5 cm/4 ¹ / ₄ "	AB 060/10
11,5 cm/4 ¹ / ₂ "	AB 060/11
13,0 cm/5"	AB 060/13
14,5 cm/5 ³ / ₄ "	AB 060/14
16,0 cm/6 ¹ / ₄ "	AB 060/16
18,0 cm/7"	AB 060/18
20,0 cm/8"	AB 060/20
25,0 cm/10"	AB 060/25
30,0 cm/12"	AB 060/30

AB PINZETTEN FORCEPS PINZAS PINCES PINZE

Anatomische Pinzetten, Chirurgische Pinzetten
 Dressing Forceps, Tissue Forceps
 Pinzas de disección, Pinzas de disección con dientes
 Pincés à dissection, Pincés à griffes
 Pinze anatomiche per dissezione, Pinze chirurgiche a denti di topo

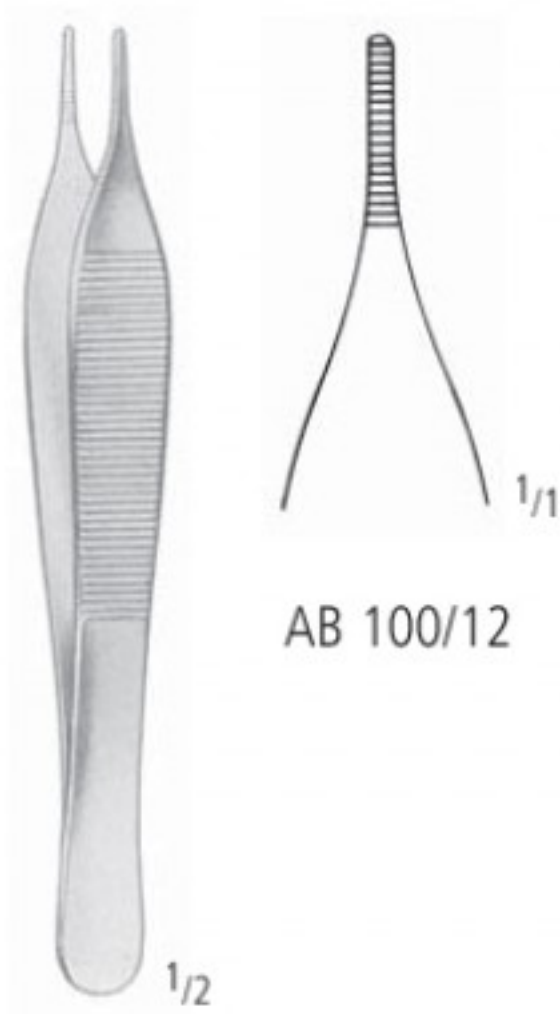

AB 100/12



AB 102/12

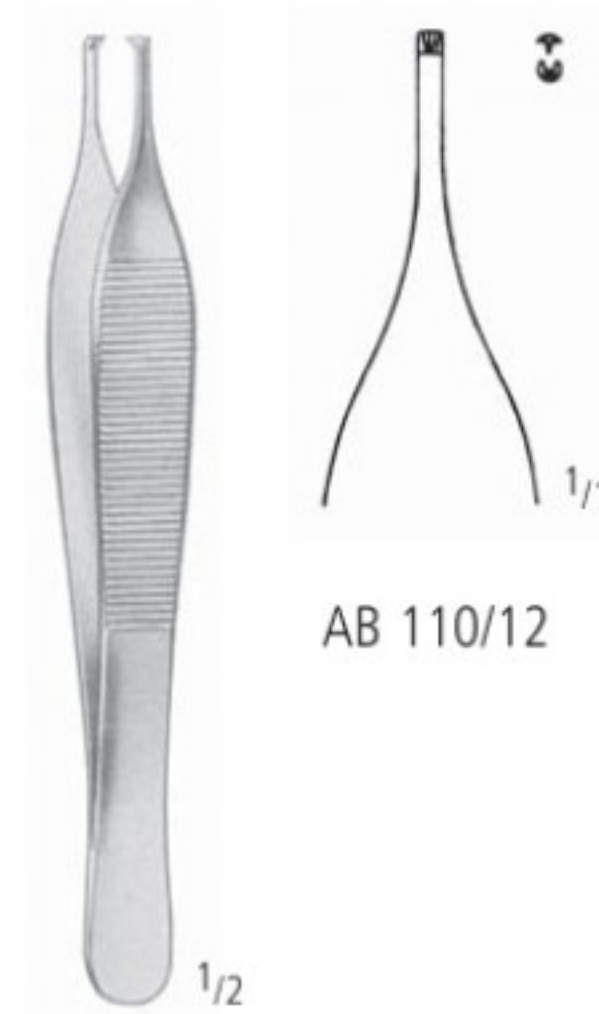

AB 110/12

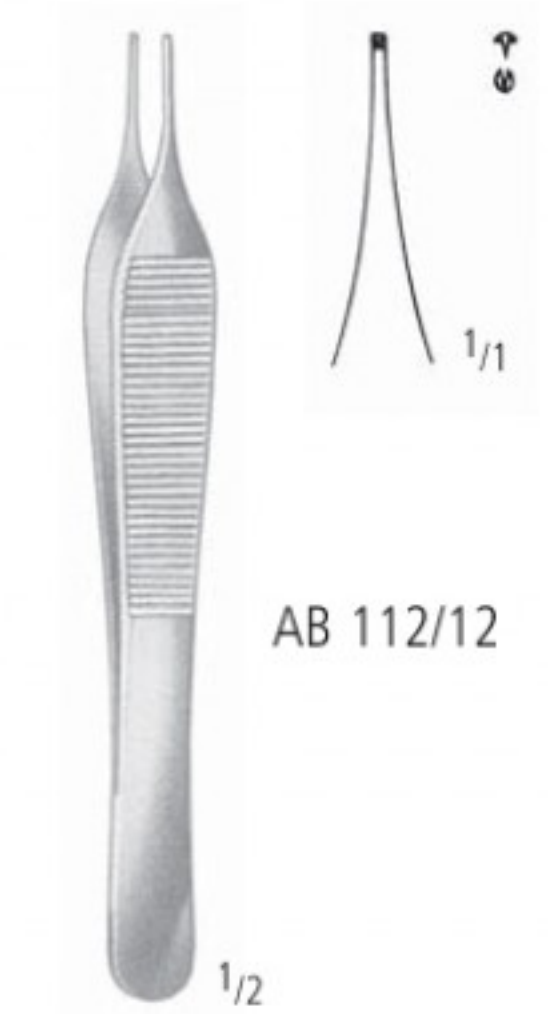

AB 112/12

12,0 cm/4³/₄"
 15,0 cm/6"

ADSON
 AB 100/12
 AB 100/15

MICRO-ADSON
 AB 102/12
 AB 102/15

ADSON 1:2
 AB 110/12
 AB 110/15

MICRO-ADSON 1:2
 AB 112/12
 AB 112/15

PINZETTEN FORCEPS PINZAS PINCES PINZE

Anatomische Pinzetten, Chirurgische Pinzetten
 Dressing Forceps, Tissue Forceps
 Pinzas de disección, Pinzas de disección con dientes
 Pincès à dissection, Pincès à griffes
 Pinze anatomiche per dissezione, Pinze chirurgiche a denti di topo

AA

AB

AC

AD

AE

AF

AK

AL

AO

KA

KK

X

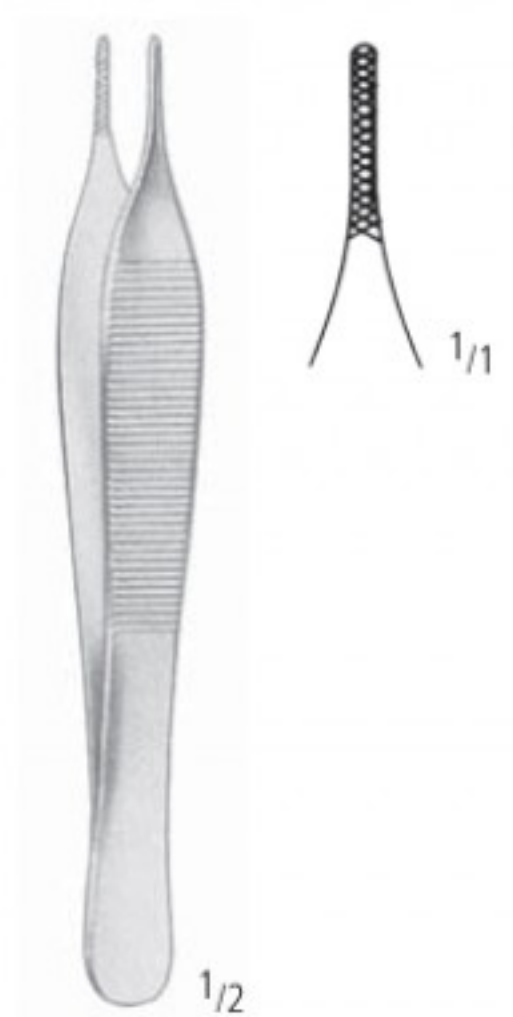

ADSON
 AB 114/12
 12,0 cm/4³/₄"

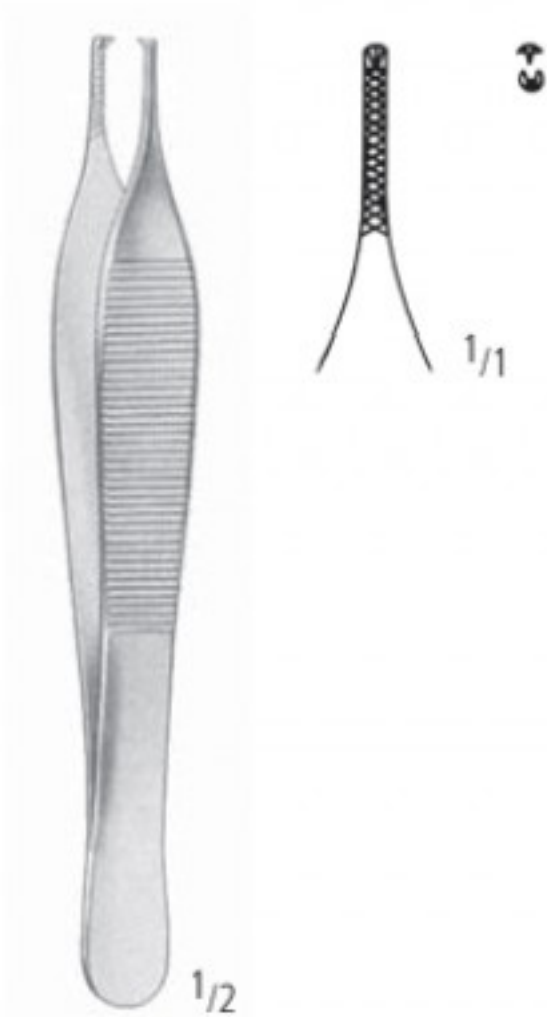

ADSON 1:2
 AB 115/12
 12,0 cm/4³/₄"

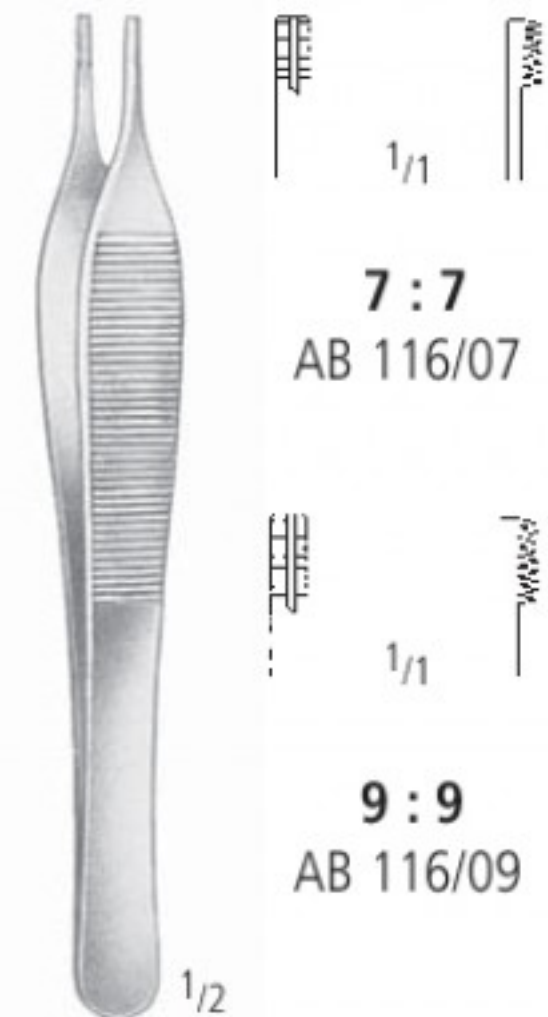

ADSON-BROWN
 12,0 cm/4³/₄"



ADSON-BROWN
 AB 117/09
 12,0 cm/4³/₄"

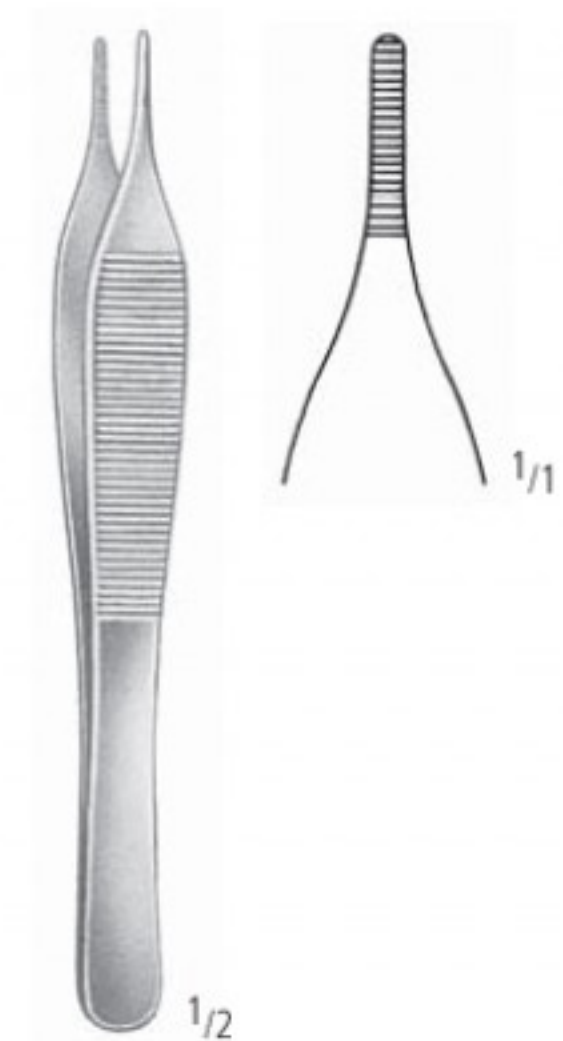

EWALD
 AB 118/01
 12,0 cm/4³/₄"

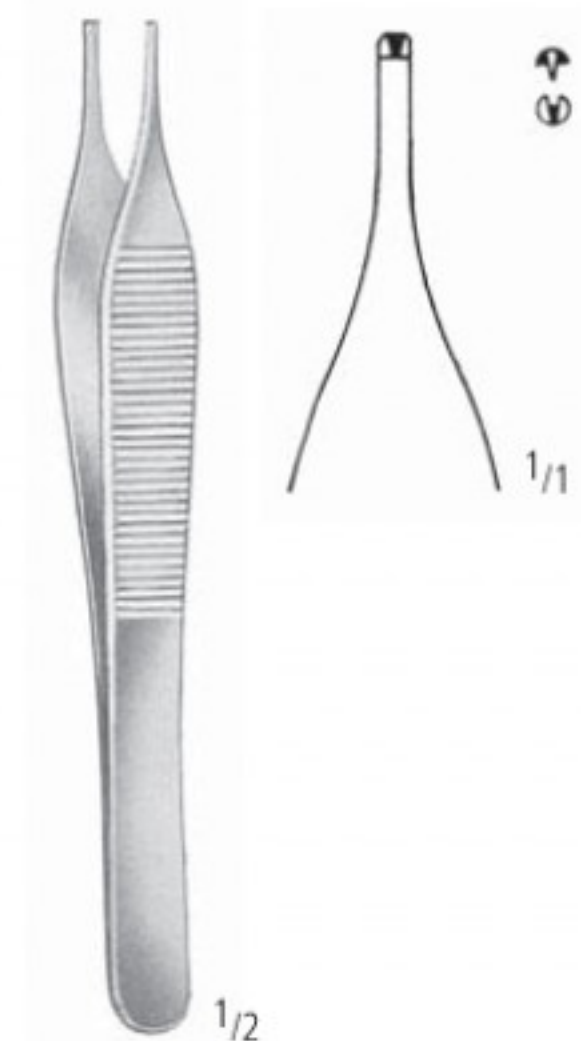

EWALD 1:2
 AB 118/02
 12,0 cm/4³/₄"



McINDOE
 AB 119/15
 15,0 cm/6"



AB 120/12
 AB 120/15

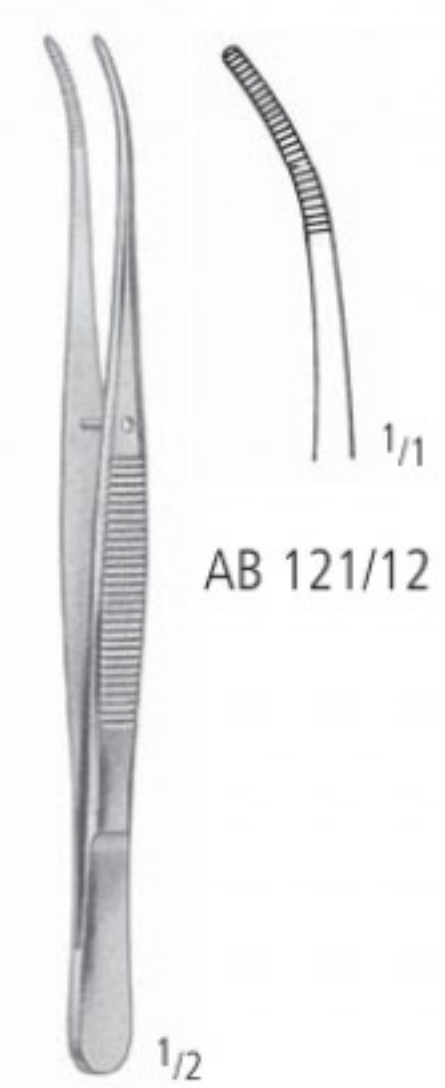

SEMKEN
 12,5 cm/5"
 15,5 cm/6"
 AB 121/12
 AB 121/15

AB PINZETTEN FORCEPS PINZAS PINCES PINZE

Anatomische Pinzetten, Chirurgische Pinzetten
 Dressing Forceps, Tissue Forceps
 Pinzas de disección, Pinzas de disección con dientes
 Pincés à dissection, Pincés à griffes
 Pinze anatomiche per dissezione, Pinze chirurgiche a denti di topo



AB 130/12

AB 130/12
 AB 130/15
SEMKEN 1:2
 12,5 cm/5"
 15,5 cm/6"

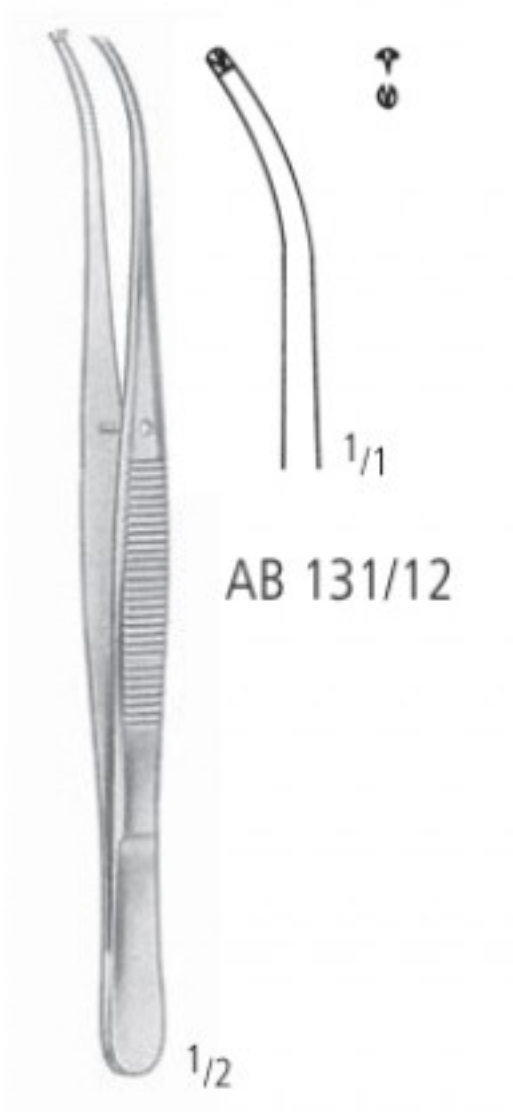

AB 131/12

AB 131/12
 AB 131/15



TAYLOR
 AB 140/17
 17,5 cm/7"



TAYLOR
 AB 141/17
 17,5 cm/7"



TAYLOR
 AB 142/17
 17,5 cm/7"



TAYLOR
 AB 143/17
 17,5 cm/7"

PINZETTEN FORCEPS PINZAS PINCES PINZE

Anatomische Pinzetten, Chirurgische Pinzetten
 Dressing Forceps, Tissue Forceps
 Pinzas de disección, Pinzas de disección con dientes
 Pincés à dissection, Pincés à griffes
 Pinze anatomiche per dissezione, Pinze chirurgiche a denti di topo

AA

AB

AC

AD

AE

AF

AK

AL

AO

KA

KK

X

The image displays six pairs of surgical forceps, categorized into Taylor and Lane types. Each pair includes a main illustration of the forceps and a smaller technical drawing showing the tip and handle details. The Taylor forceps (models 150/17, 151/17, 152/17, and 153/17) are 1:2 forceps with a 17.5 cm length. The Lane forceps (models 156/14, 156/20, 158/14, and 158/20) are 1:2 and 2:3 forceps with lengths of 14.5 cm, 20.0 cm, 14 cm, and 20 cm respectively. The technical drawings show the serrated tips and the locking mechanism of the handles.

Model	Type	Length
AB 150/17	TAYLOR 1:2	17,5 cm/7"
AB 151/17	TAYLOR 1:2	17,5 cm/7"
AB 152/17	TAYLOR 1:2	17,5 cm/7"
AB 153/17	TAYLOR 1:2	17,5 cm/7"
AB 156/14	LANE 1:2	14,5 cm/5 ³ / ₄ "
AB 156/20	LANE 1:2	20,0 cm/8"
AB 158/14	LANE 2:3	14 cm/5 ¹ / ₂ "
AB 158/20	LANE 2:3	20 cm/8"

AB PINZETTEN FORCEPS PINZAS PINCES PINZE

Anatomische Pinzetten, Chirurgische Pinzetten
 Dressing Forceps, Tissue Forceps
 Pinzas de disección, Pinzas de disección con dientes
 Pincés à dissection, Pincés à griffes
 Pinze anatomiche per dissezione, Pinze chirurgiche a denti di topo

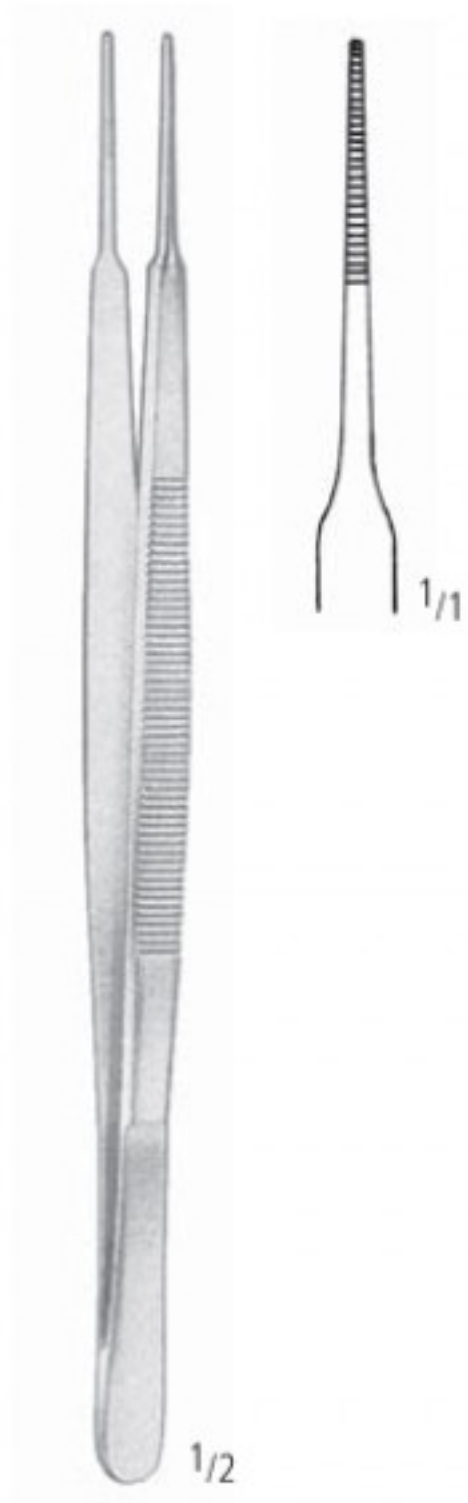

GERALD
 AB 160/18 18,0 cm/7"

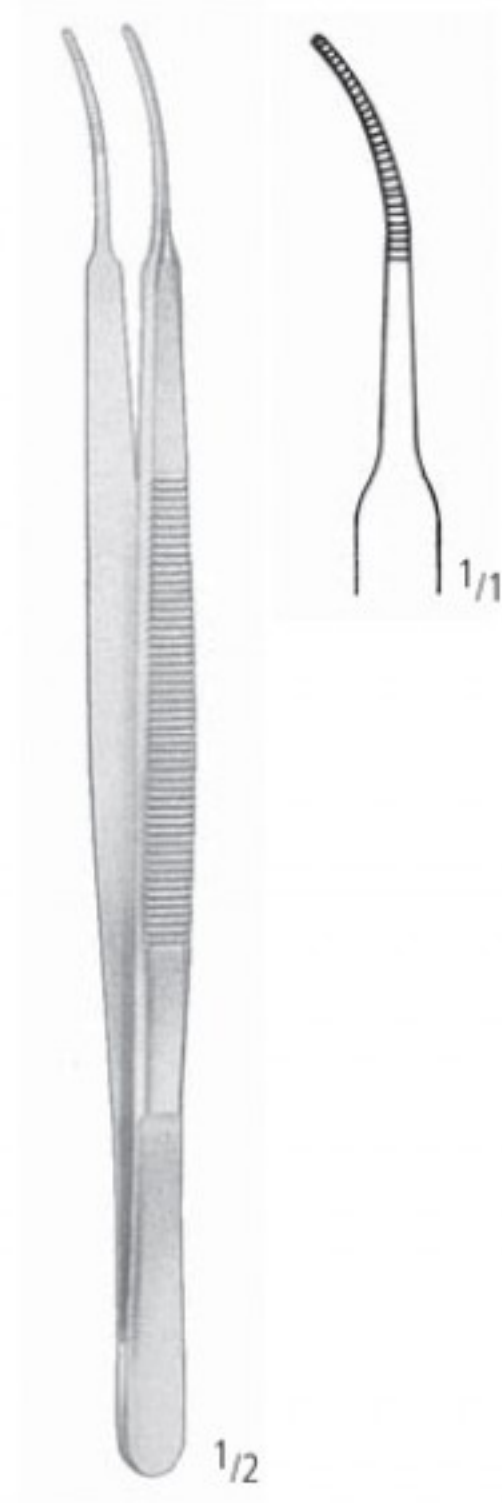

GERALD
 AB 161/18

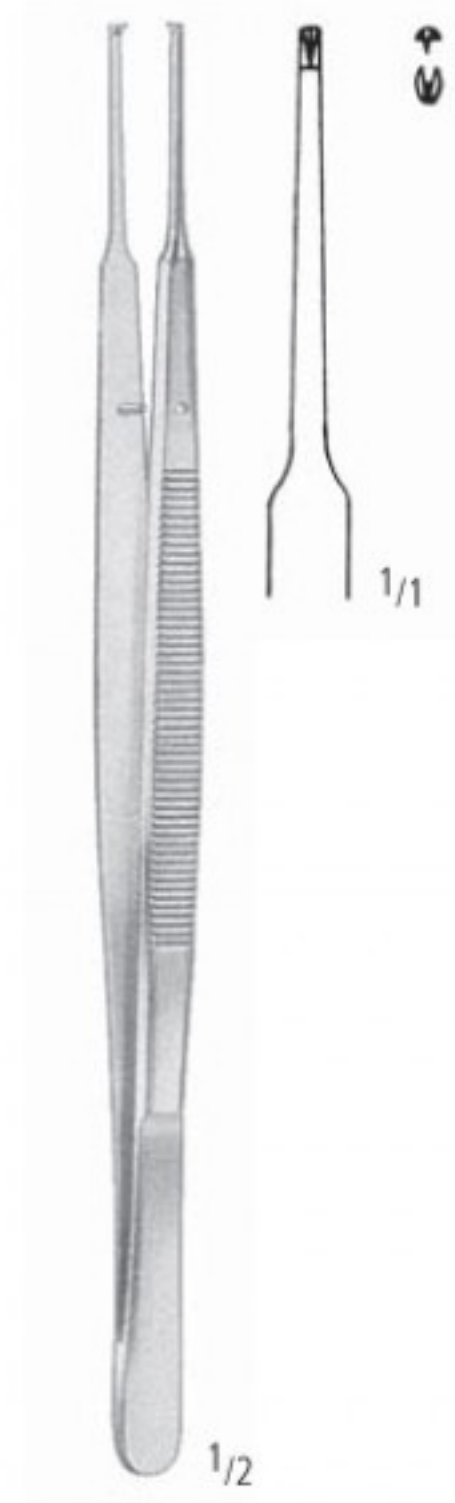

GERALD 1:2
 AB 170/18 18,0 cm/7"



GERALD 1:2
 AB 171/18



CUSHING
 AB 180/17 17,5 cm/7"



CUSHING
 AB 181/17



CUSHING 1:2
 AB 190/17 17,5 cm/7"



CUSHING 1:2
 AB 191/17

PINZETTEN FORCEPS PINZAS PINCES PINZE

Anatomische Pinzetten, Chirurgische Pinzetten
 Dressing Forceps, Tissue Forceps
 Pinzas de disección, Pinzas de disección con dientes
 Pincés à dissection, Pincés à griffes
 Pinze anatomiche per dissezione, Pinze chirurgiche a denti di topo

AA
AB
 AC
 AD
 AE
 AF
 AK
 AL
 AO
 KA
 KK
 X



AB 200/18

POTTS-SMITH

1/2



AB 201/18



AB 210/18

**POTTS-SMITH
 1:2**

1/2



AB 211/18

18,0 cm/7"
 21,0 cm/8 1/4"
 25,0 cm/10"

AB 200/18
 AB 200/21
 AB 200/25

AB 201/18
 AB 201/21
 AB 201/25

AB 210/18
 AB 210/21
 AB 210/25

AB 211/18
 AB 211/21
 AB 211/25



BROPHY

1/2

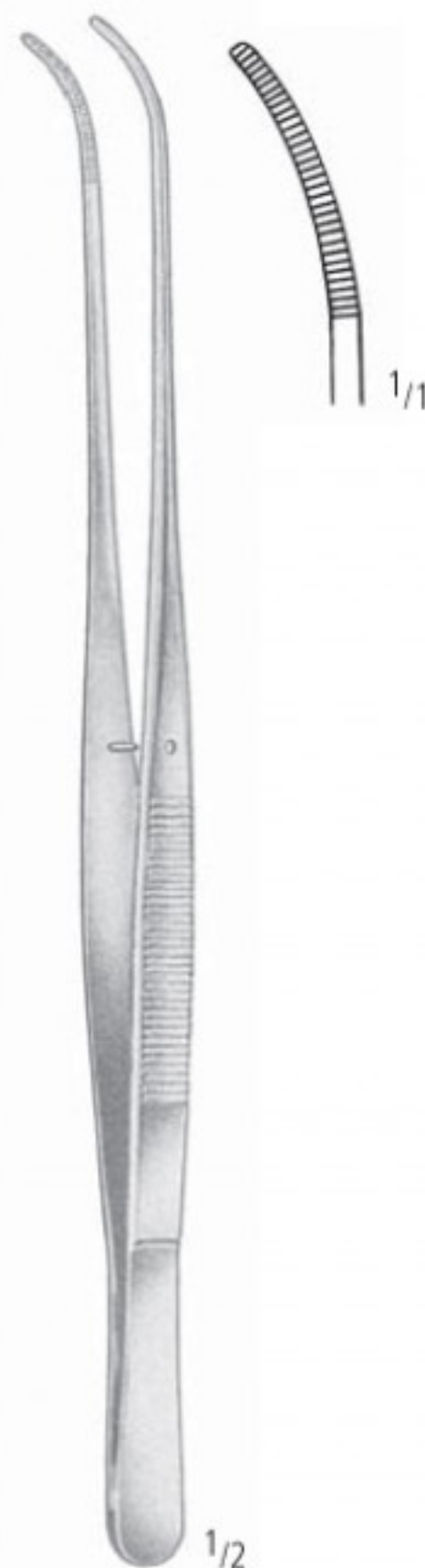

AB 251/20



**BROPHY
 1:2**

1/2



AB 261/20

20,0 cm/8"

AB 250/20

AB 260/20

AB PINZETTEN FORCEPS PINZAS PINCES PINZE

Mikro-Pinzetten, Knüpppinzetten mit Plateau
 Micro Forceps, Suture Tying Forceps with platform
 Micro-Pinzas, Pinzas de ligadura con plataforma
 Micro-Pinces, Pinces à ligature avec plate-forme
 Micro-Pinze, Pinze per ligature con piattaforma

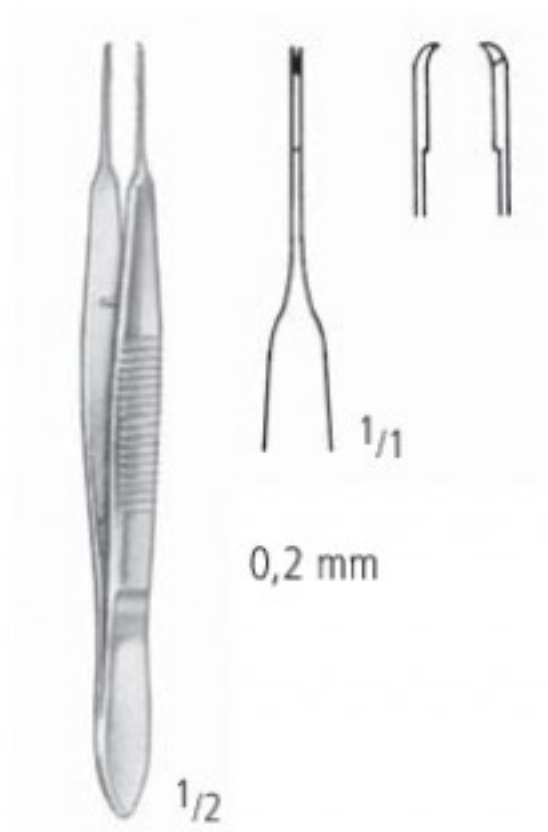

1:2
 AB 530/09
 9,5 cm/3³/₄"

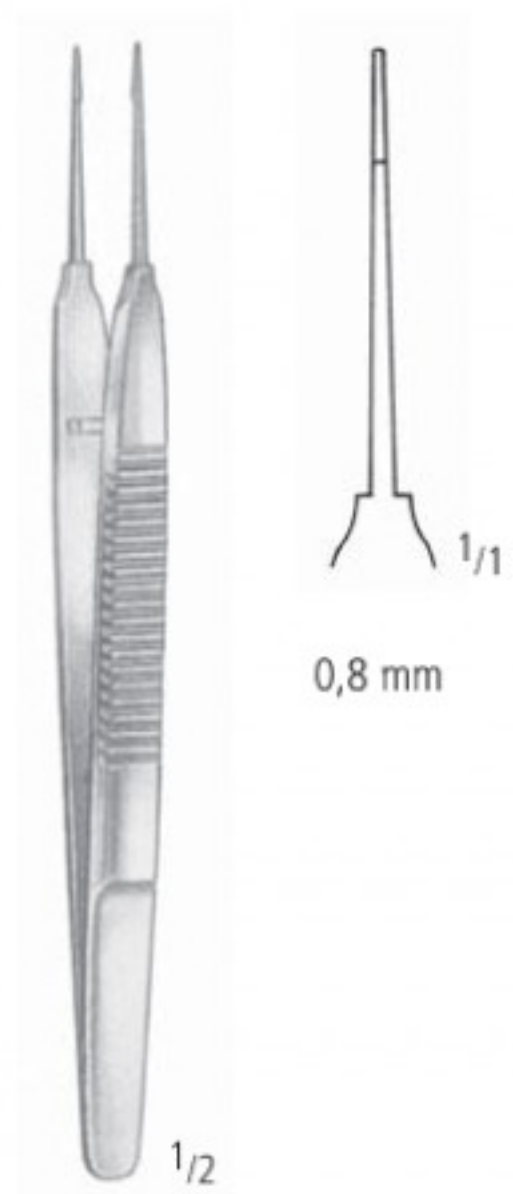

AUSTIN
 AB 532/14
 14,0 cm/5¹/₂"

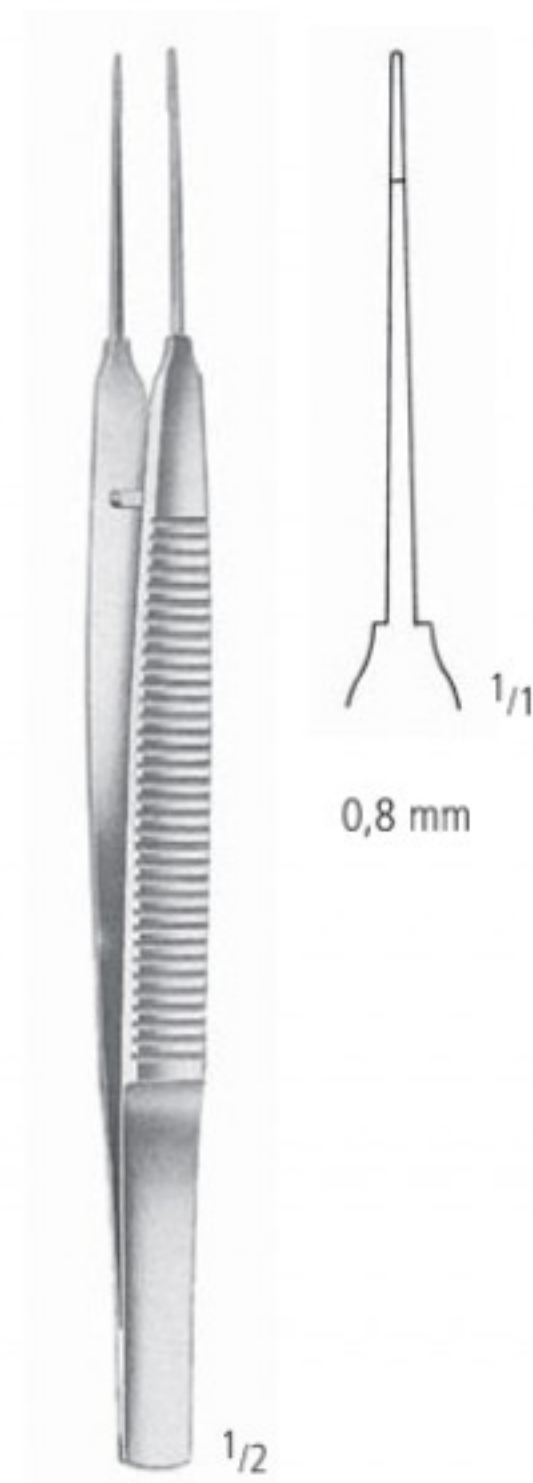

AUSTIN
 AB 532/18
 18,0 cm/7"

PINZETTEN FORCEPS PINZAS PINCES PINZE

Mikro-Pinzetten, Knüpfpinzetten mit Plateau, Gefäßdilator
 Micro Forceps, Suture Tying Forceps with platform, Vessel Dilator
 Micro-Pinzas, Pinzas de ligadura con plataforma, Dilatador para vasos
 Micro-Pinces, Pinces à ligature avec plate-forme, Dilatateur pour vaisseaux
 Micro-Pinze, Pinze per ligature con piattaforma, Dilatatore per vasi

AA

AB

AC

AD

AE

AF

AK

AL

AO

KA

KK

X



AB 536/14
14,0 cm/5 1/2"



AB 538/14 1:2
14,0 cm/5 1/2"



AB 540/14 1:2
14,0 cm/5 1/2"

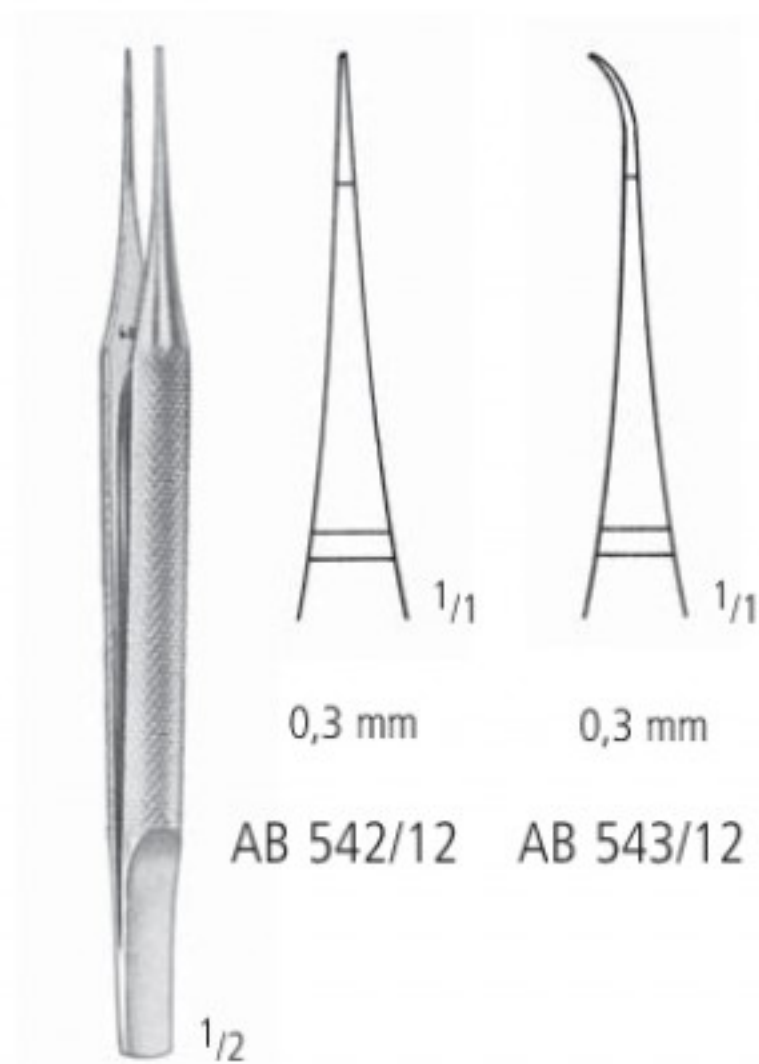

12,0 cm/4 3/4" AB 542/12 AB 543/12
15,0 cm/6" AB 542/15 AB 543/15

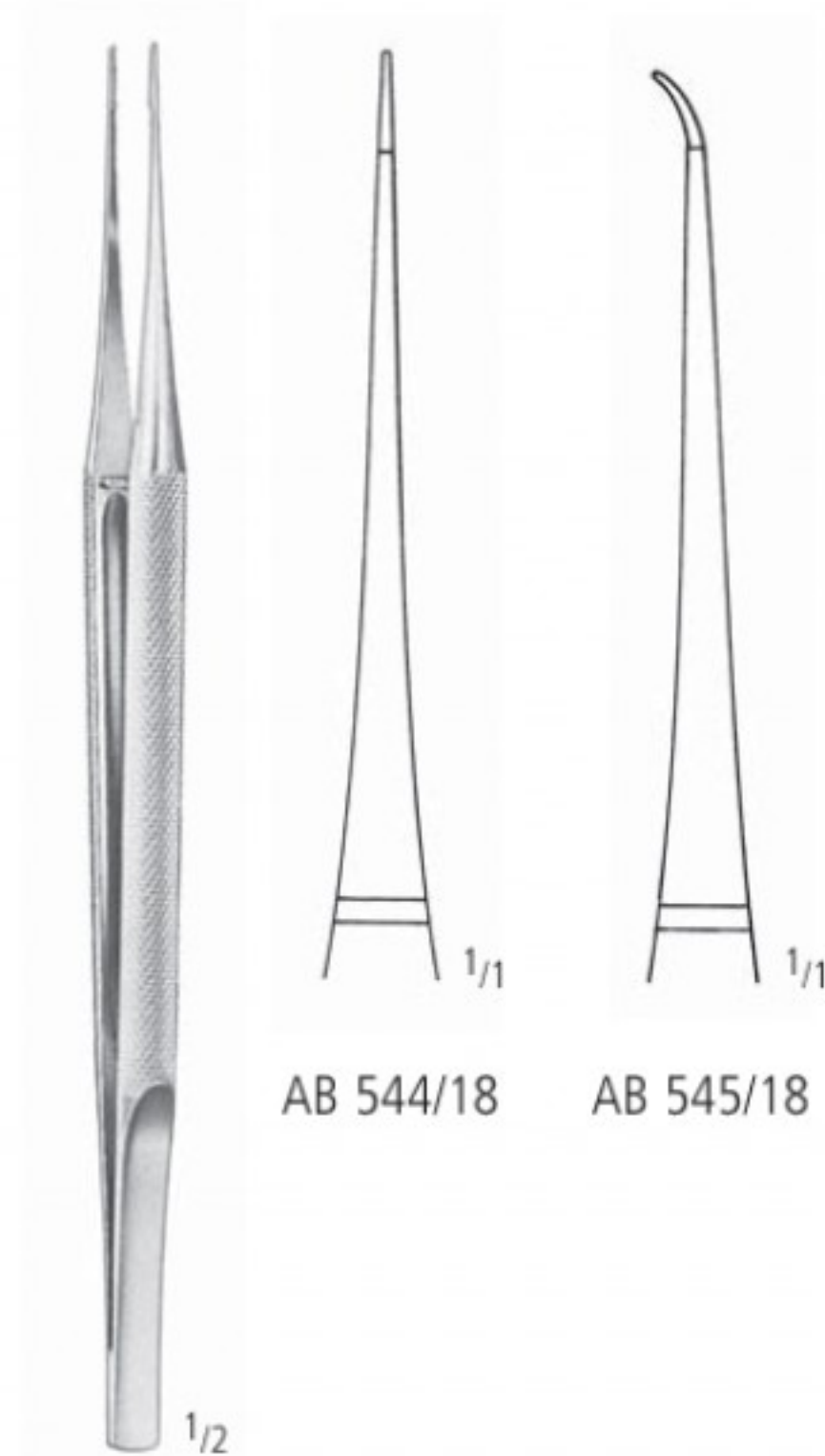



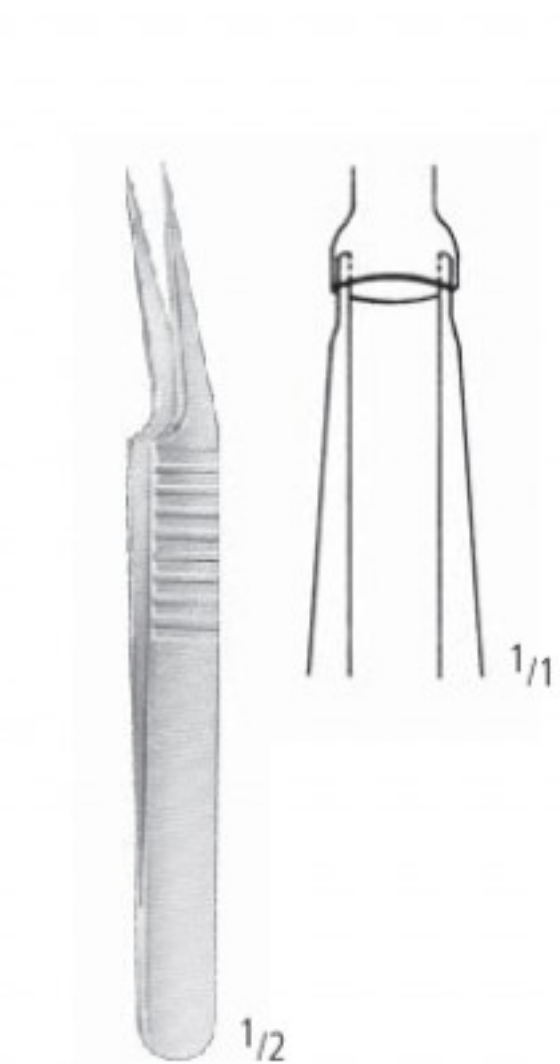

18,0 cm/7"



AB 546/11
11,0 cm/4 1/3"

AB PINZETTEN FORCEPS PINZAS PINCES PINZE

Atraumatische Pinzetten
 Non-traumatic Vascular Tissue Forceps
 Pinzas Atrauma
 Pincas Atrauma
 Pinze Atrauma

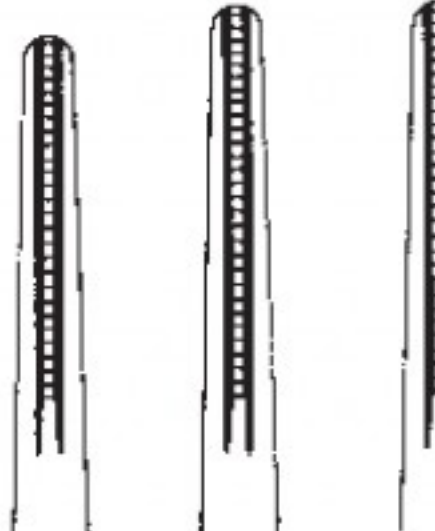
 1/2	 1/1 1,5 mm	<p>AB 860/16 = 16,0 cm/6¹/₄" AB 860/20 = 20,0 cm/8" AB 860/24 = 24,0 cm/9¹/₂"</p>	 1/2	 1/1 2,0 mm	<p>AB 862/16 = 16,0 cm/6¹/₄" AB 862/20 = 20,0 cm/8" AB 862/24 = 24,0 cm/9¹/₂" AB 862/30 = 30,0 cm/12"</p>	 1/2	 1/1 2,8 mm	<p>AB 864/16 = 16,0 cm/6¹/₄" AB 864/20 = 20,0 cm/8" AB 864/24 = 24,0 cm/9¹/₂" AB 864/30 = 30,0 cm/12"</p>
DE BAKAY			DE BAKAY			DE BAKAY		

 1/2	 1/1 3,5 mm	<p>AB 866/20 = 20,0 cm/8" AB 866/24 = 24,0 cm/9¹/₂" AB 866/30 = 30,0 cm/12"</p>	 1/2	 1/1 2,0 mm	<p>AB 869/16 = 16,0 cm/6¹/₄" AB 869/20 = 20,0 cm/8" AB 869/24 = 24,0 cm/9¹/₂" AB 869/30 = 30,0 cm/12"</p>
DE BAKAY			DE BAKAY		

PINZETTEN FORCEPS PINZAS PINCES PINZE

Pinzetten mit Hartmetalleinsätzen
 Dissecting Forceps with Tungsten Carbide Inserts
 Pinzas de disección con bocas de carburo de tungsteno
 Pincès à dissection avec mors en carbure de tungstène
 Pinze per dissezione con punte di carburo di tungsteno

AA
 AB
 AC
 AD
 AE
 AF
 AK
 AL
 AO
 KA
 KK
 X

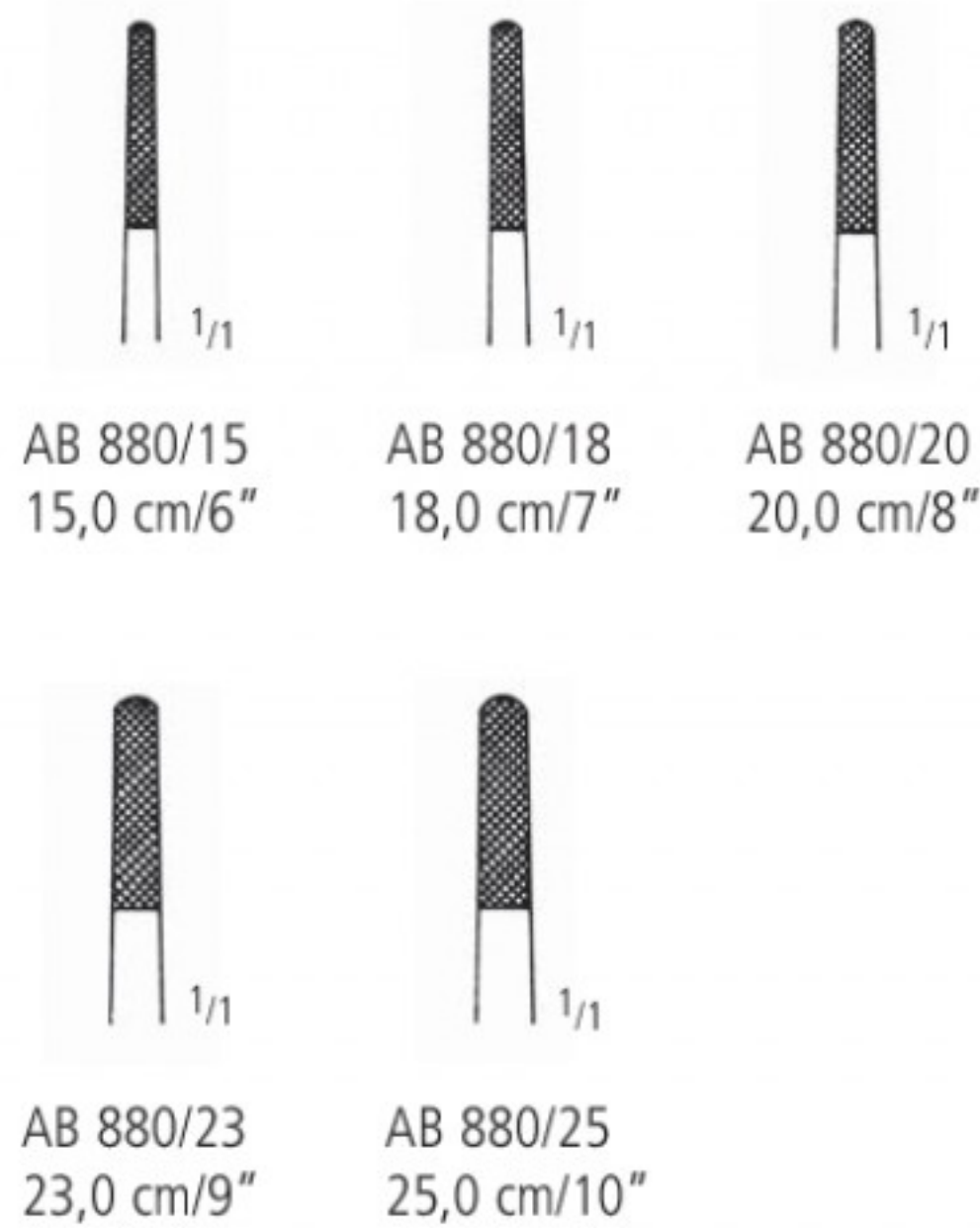

POTTS-SMITH

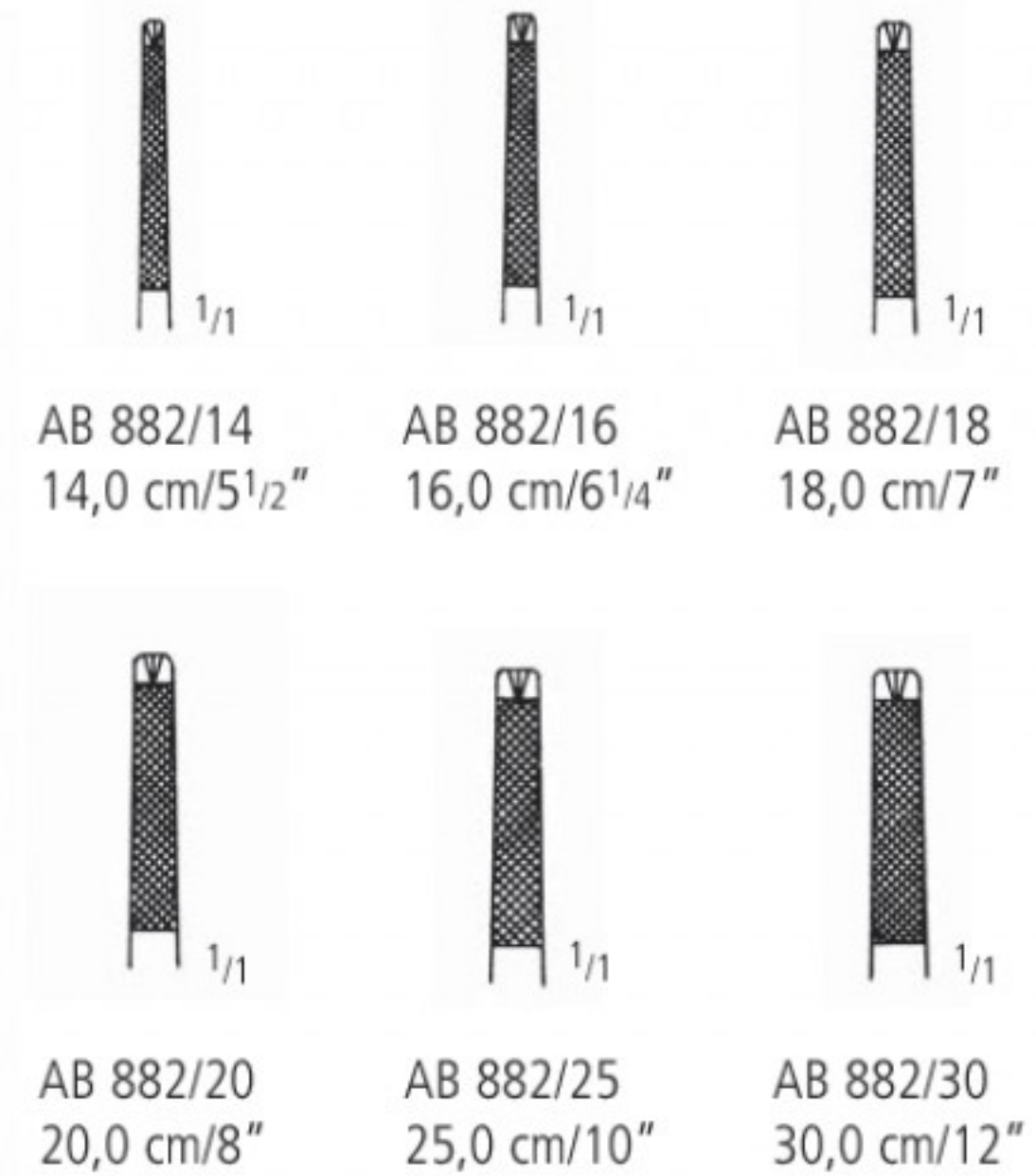

OEHLER 1:2

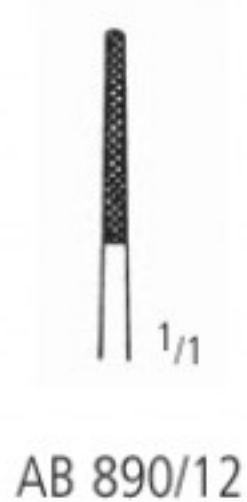

SEMKEN
 AB 890/12 12,5 cm/5"
 AB 890/15 15,5 cm/6"



GILLIES 1:2
 AB 900/15 15,0 cm/6"



JEWELER
 AB 902/15 15,0 cm/6"

AB PINZETTEN FORCEPS PINZAS PINCES PINZE

Pinzetten mit Hartmetalleinsätzen
 Dissecting Forceps with Tungsten Carbide Inserts
 Pinzas de disección con bocas de carburo de tungsteno
 Pincas à dissection avec mors en carbure de tungstène
 Pinze per dissezione con punte di carburo di tungsteno



ADSON

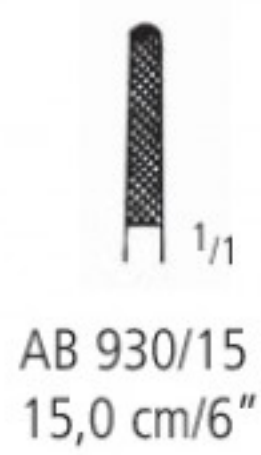
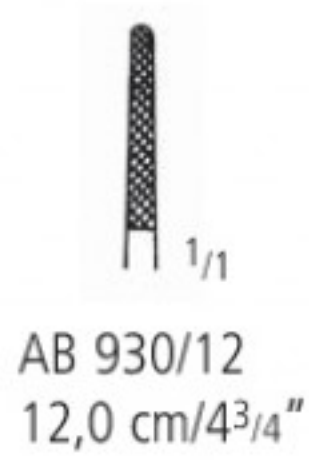

CUSHING
17,5 cm/7"



← mit Dissektor-Ende
 with dissector end
 con cabo disecador
 avec bout dissecteur
 con dissetore →



CUSHING-TAYLOR
AB 943/18
18,0 cm/7"



PINZETTEN FORCEPS PINZAS PINCES PINZE

Pinzetten mit Hartmetalleinsätzen
 Dissecting Forceps with Tungsten Carbide Inserts
 Pinzas de disección con bocas de carburo de tungsteno
 Pincès à dissection avec mors en carbure de tungstène
 Pinze per dissezione con punte di carburo di tungsteno



DE BAKEY
 16,0 cm/6¹/₄"
 20,0 cm/8"
 24,0 cm/9¹/₂"

1,5 mm	2,0 mm
AB 944/16	AB 946/16
AB 944/20	AB 946/20
AB 944/24	AB 946/24



BONNEY 1:2
 AB 948/18
 18,0 cm/7"



AB 950/15
 15,0 cm/6"



AB 950/23
 23,0 cm/9"

WANGENSTEEN

AA
 AB
 AC
 AD
 AE
 AF
 AG
 AH
 AI
 AJ
 AK
 AL
 AM
 AN
 AO
 AP
 AQ
 AR
 AS
 AT
 AU
 AV
 AW
 AX

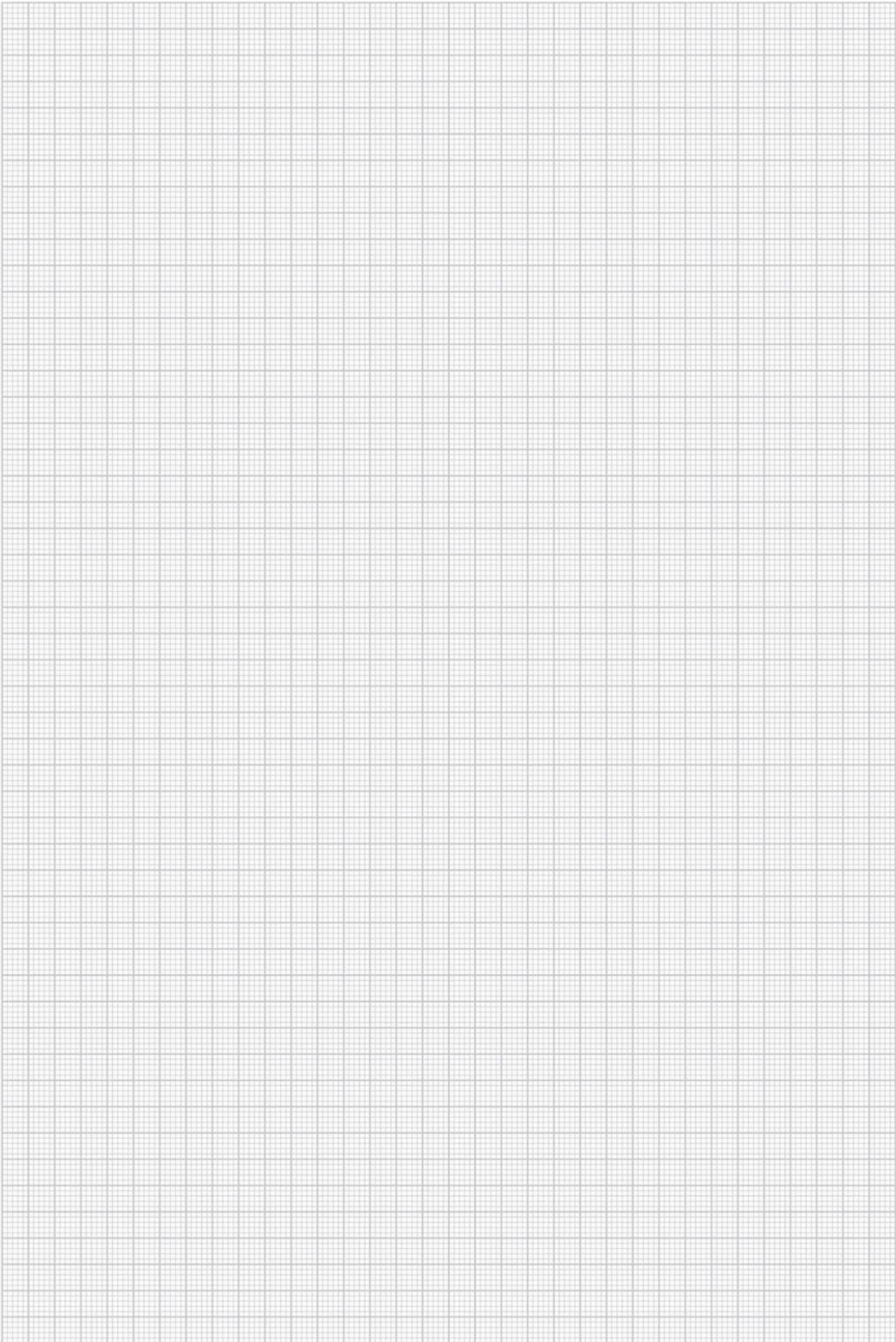

SCHEREN
SCISSORS
TIJERAS
CISEAUX
FORBICI

AC

nopa[®] instruments

Weitere Scheren finden Sie in unserem Katalog
"Allgemeine Chirurgie" in Gruppe AC.

For further scissors kindly refer to our catalogue
"General Surgery", section AC.

Para tijeras adicionales, por favor consulte nuestro
catálogo de "Cirugía general", grupo AC.

Pour des ciseaux supplémentaires, consultez notre
catalogue "Chirurgie Generale", section AC.

Per gli altri forbici, consultare il nostro catalogo
"Chirurgia Generale", gruppo AC.





nopa® SC
SUPER CUT



SUPER CUT

Verfügbare Modelle / Available Patterns

Im Katalog durch * markiert. / Marked in catalog with *.

AC	110/18	SC	METZENBAUM-NELSON	SCS STR.	BL/BL	18,0	CM	SC
AC	110/20	SC	METZENBAUM-NELSON	SCS STR.	BL/BL	20,0	CM	SC
AC	110/23	SC	METZENBAUM-NELSON	SCS STR.	BL/BL	23,0	CM	SC
AC	111/18	SC	METZENBAUM-NELSON	SCS CVD.	BL/BL	18,0	CM	SC
AC	111/20	SC	METZENBAUM-NELSON	SCS CVD.	BL/BL	20,0	CM	SC
AC	111/23	SC	METZENBAUM-NELSON	SCS CVD.	BL/BL	23,0	CM	SC
AC	141/14	SC	METZENBAUM-DELICATE	SCS BL/BL	CVD.	14,5	CM	SC
AC	151/18	SC	METZENBAUM-DELICATE	SCS BL/BL	CVD.	18,0	CM	SC
AC	214/15	SC	REYNOLDS DISS.	SCS STR.	SH/SH	15,0	CM	SC
AC	214/18	SC	REYNOLDS DISS.	SCS CVD.	SH/SH	18,0	CM	SC
AC	450/11	SC	IRIS	SCS STR.	SH/SH	11,5	CM	SC
AC	451/11	SC	IRIS	SCS CVD.	SH/SH	11,5	CM	SC
AC	476/11	SC	STEVENS TENOTOMY	SCS STR.	BL/BL	11,5	CM	SC
AC	477/11	SC	STEVENS TENOTOMY	SCS CVD.	BL/BL	11,5	CM	SC

Besonderheit:

nopa Super Cut Scheren haben eine rasierklingenscharfe Schneide, kombiniert mit einer mikrogezahnten Schneide.

>> Diese Scheren sind durch schwarze Ringe gekennzeichnet.

Features:

nopa Super Cut scissors have a razor-like edge combined with one micro serrated blade.

>> Black rings for easy identification.



titan instruments

nopa[®] instruments

Besonderheit:

nopa Titan Instrumente bieten insbesondere in der Herz-Thorax-Chirurgie Vorteile gegenüber herkömmlichen Instrumenten. Titan ist ca. 45% leichter als rostfreier Edelstahl, weshalb Titan Instrumente weniger traumatisierend sind. Titan ist außerdem ein vollkommen korrosionsbeständiges und antimagnetisches Material. **nopa** Titan Instrumente bedeuten größtmöglichen Komfort für den Chirurgen.

AC 870/11 T	MICRO SCISSORS 18,0 CM, 25°
AC 870/12 T	MICRO SCISSORS 18,0 CM, 45°
AC 870/13 T	MICRO SCISSORS 18,0 CM, 60°
AC 870/14 T	MICRO SCISSORS 18,0 CM, 90°
AC 870/15 T	MICRO SCISSORS 18,0 CM, 125°
AC 871/11 T	MICRO SCISSORS 18,0 CM, 25°
AC 871/12 T	MICRO SCISSORS 18,0 CM, 45°
AC 871/13 T	MICRO SCISSORS 18,0 CM, 60°
AC 871/14 T	MICRO SCISSORS 18,0 CM, 90°
AC 871/15 T	MICRO SCISSORS 18,0 CM, 125°

Features:

nopa Titan Instruments provide especially in Cardiovascular surgery a significant advantage compared to other Instruments. Titan is approximately 45% lighter than stainless steel. For that reason, Titan Instruments are less traumatic. Besides that, Titan is a completely stainless and anti-magnetic material. **nopa** Titan Instruments are the most comfortable choice for the Cardiovascular surgeon.





SCHEREN SCISSORS TIJERAS CISEAUX FORBICI

Präparierscheren
Dissecting Scissors
Tijeras para preparaciones
Ciseaux à dissection
Forbici per preparazioni

AA
AB
AC
AD
AE
AF
AK
AL
AO
KA
KK
X

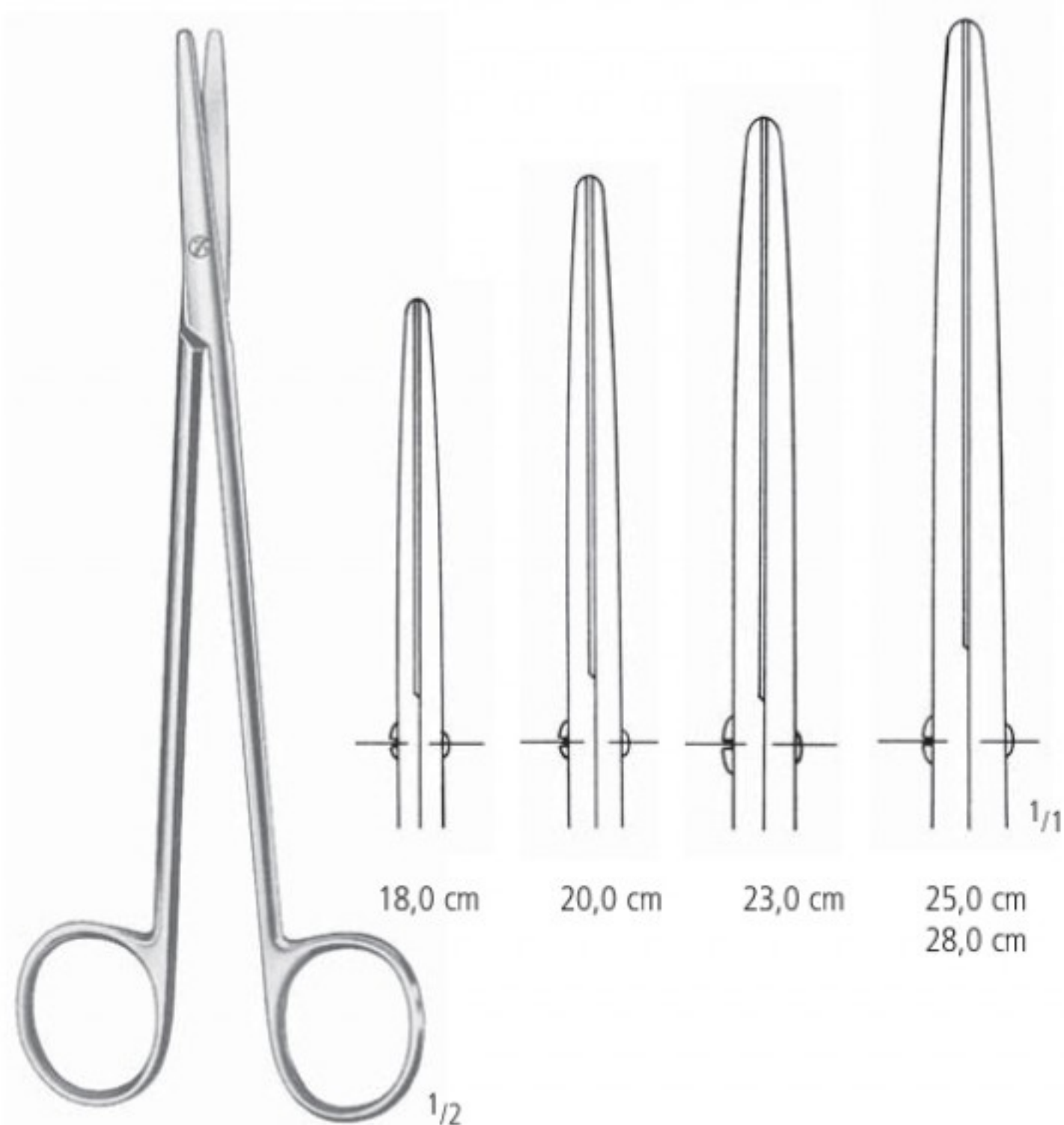

METZENBAUM-NELSON



METZENBAUM-NELSON



Fig. 1



Fig. 2



Fig. 3

18,0 cm/7"	AC 110/18*	AC 111/18*	AC 120/18	AC 121/18	AC 130/18	AC 131/18
20,0 cm/8"	AC 110/20*	AC 111/20*	AC 120/20	AC 121/20	AC 130/20	AC 131/20
23,0 cm/9"	AC 110/23*	AC 111/23*	AC 120/23	AC 121/23	AC 130/23	AC 131/23
25,0 cm/10"	AC 110/25	AC 111/25	AC 120/25	AC 121/25	AC 130/25	AC 131/25
28,0 cm/11"	AC 110/28	AC 111/28	AC 120/28	AC 121/28	AC 130/28	AC 131/28
30,0 cm/12"	AC 110/30	AC 111/30	AC 120/30	AC 121/30	AC 130/30	AC 131/30

* Auch erhältlich als SC * Also available as SC

Präparierscheren, DELICATE
 Dissecting Scissors, DELICATE
 Tijeras para preparaciones, DELICATE
 Ciseaux à dissection, DELICATE
 Forbici per preparazioni, DELICATE

METZENBAUM-DELICATE



Fig. 1
 AC 140/14
 14,5 cm/5³/₄"

Fig. 1
 AC 141/14*
 14,5 cm/5³/₄"

Fig. 3
 AC 142/14
 14,5 cm/5³/₄"

Fig. 3
 AC 143/14
 14,5 cm/5³/₄"

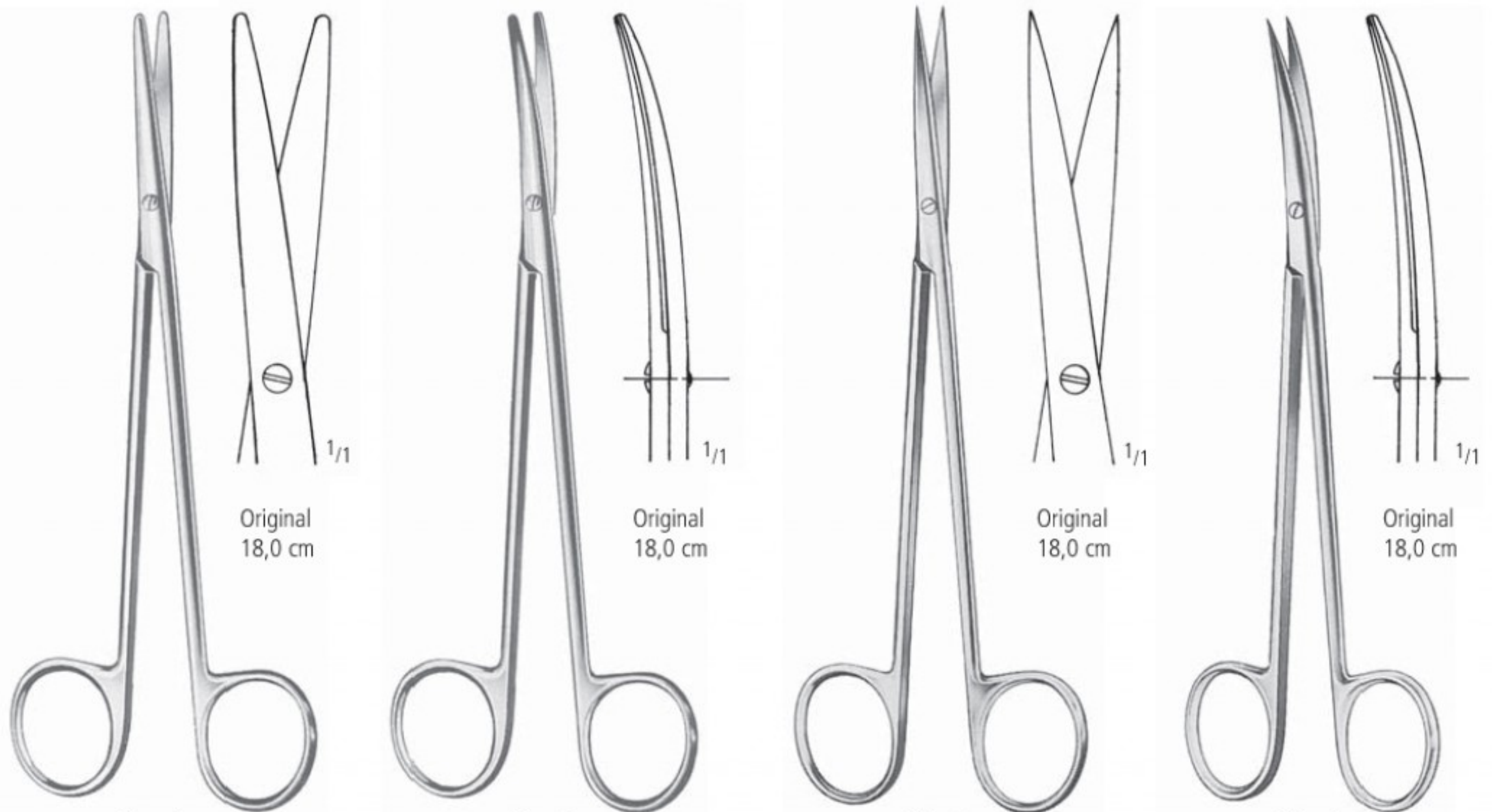

Fig. 1

Fig. 1

Fig. 3

Fig. 3

Original
 18,0 cm

Original
 18,0 cm

Original
 18,0 cm

Original
 18,0 cm

18,0 cm/7"	AC 150/18	AC 151/18*	AC 152/18	AC 153/18
20,0 cm/8"	AC 150/20	AC 151/20	AC 152/20	AC 153/20
23,0 cm/9"	AC 150/23	AC 151/23	AC 152/23	AC 153/23
25,0 cm/10"			AC 152/25	AC 153/25
28,0 cm/11"			AC 152/28	AC 153/28
30,0 cm/12"			AC 152/30	AC 153/30

SCHEREN SCISSORS TIJERAS CISEAUX FORBICI

Präparierscheren
Dissecting Scissors
Tijeras para preparaciones
Ciseaux à dissection
Forbici per preparazioni

AA

AB

AC

AD

AE

AF

AK

AL

AO

KA

KK

X

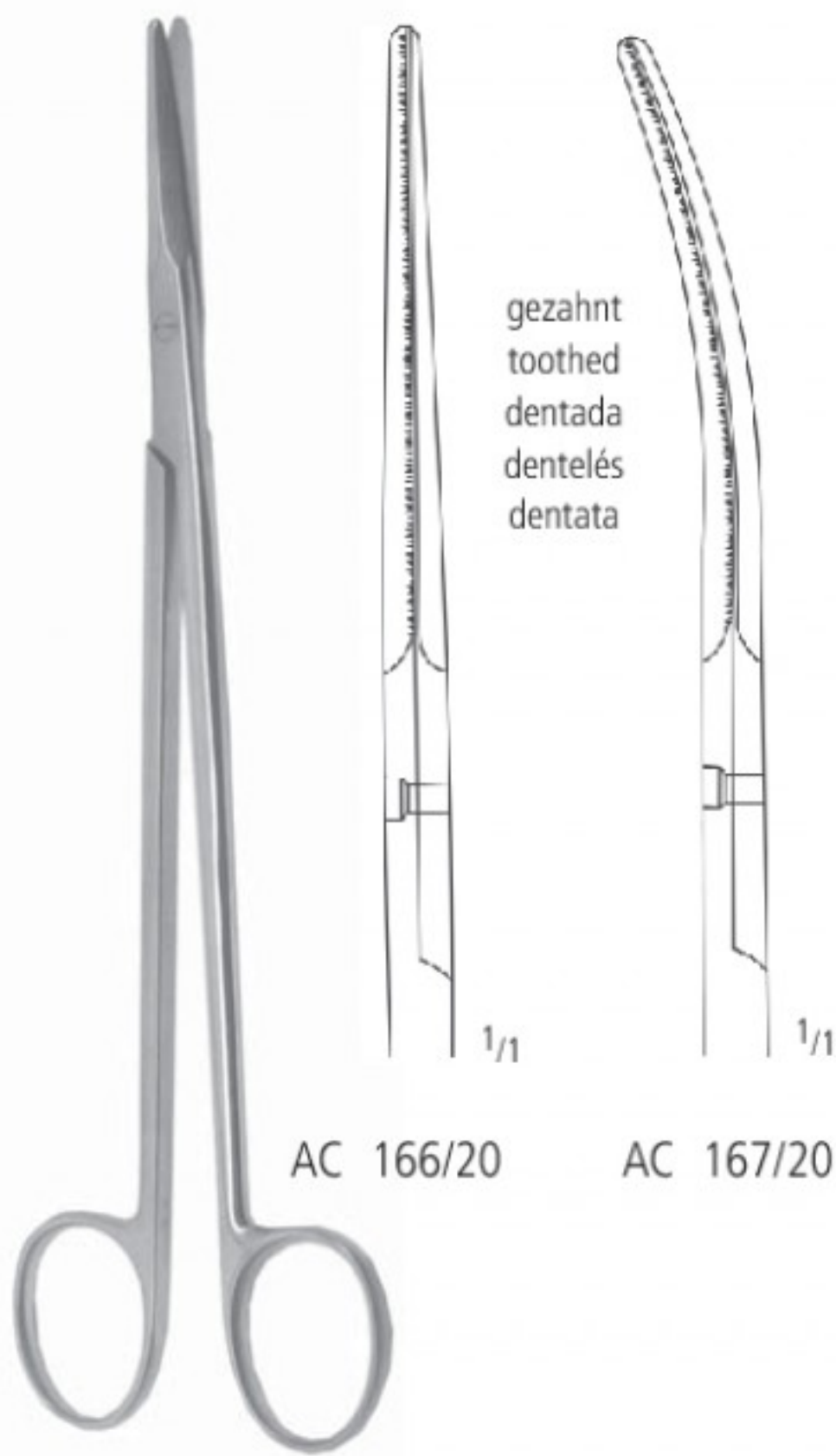

GORNEY
19,5 cm/7³/₄"

Nerv-Präparierschere
Nerve dissecting scissors
Tijeras para nervios
Ciseaux pour nerfs
Forbici per nervi

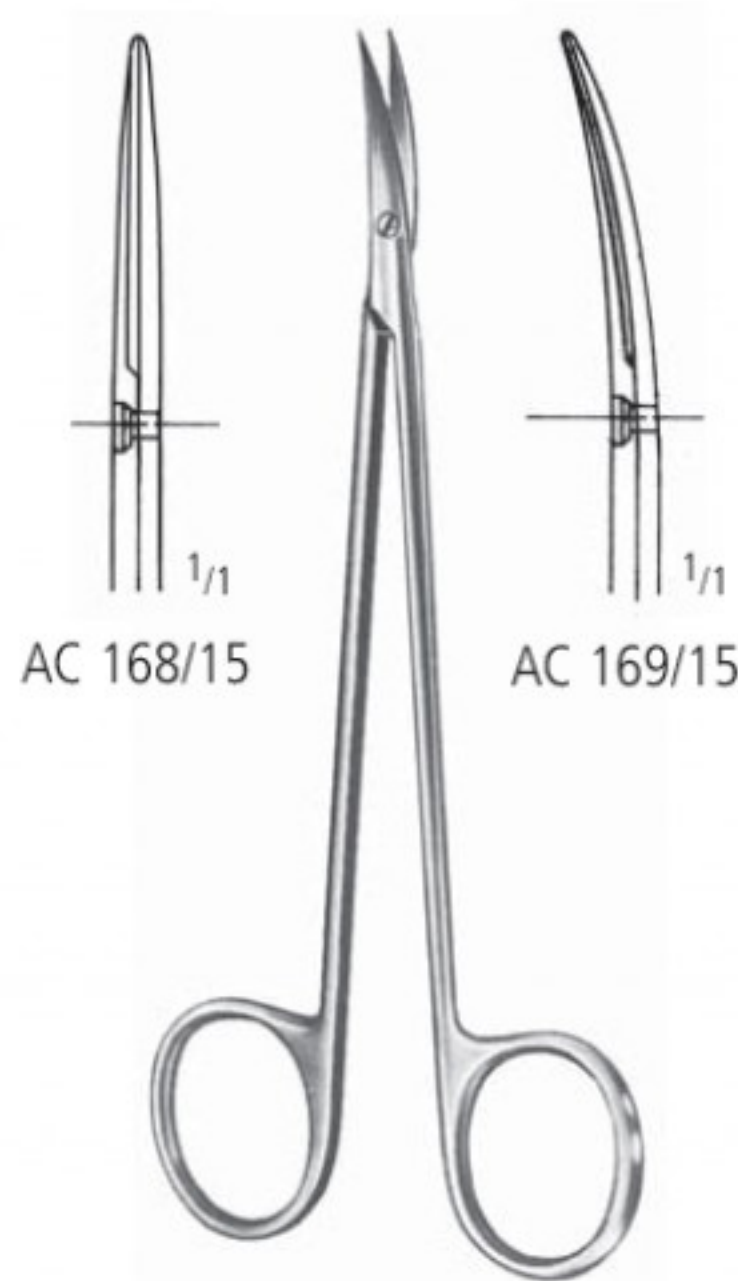

15,0 cm/6"



LEXER
AC 170/16
16,0 cm/6¹/₄"



LEXER
AC 171/16
16,0 cm/6¹/₄"

AC SCHEREN SCISSORS TIJERAS CISEAUX FORBICI

Präparierscheren
Dissecting Scissors
Tijeras para preparaciones
Ciseaux à dissection
Forbici per preparazioni

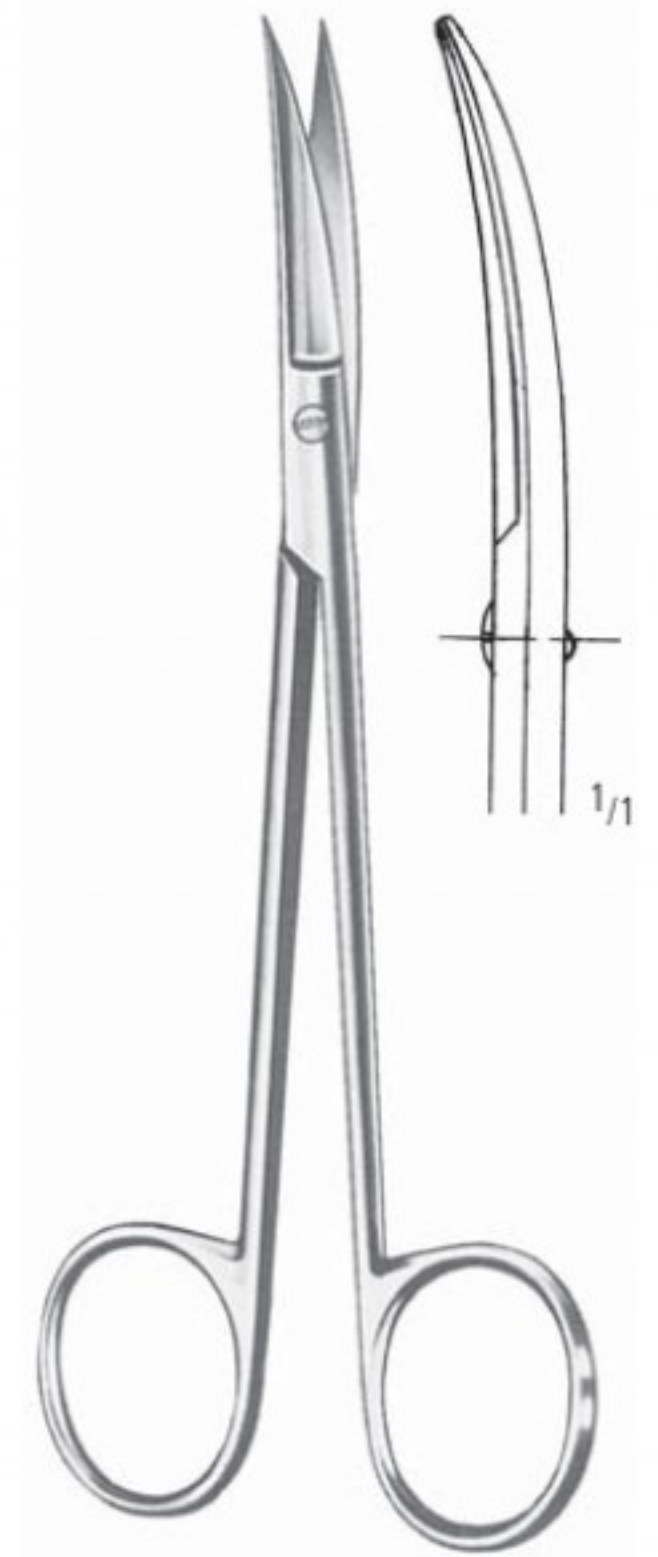
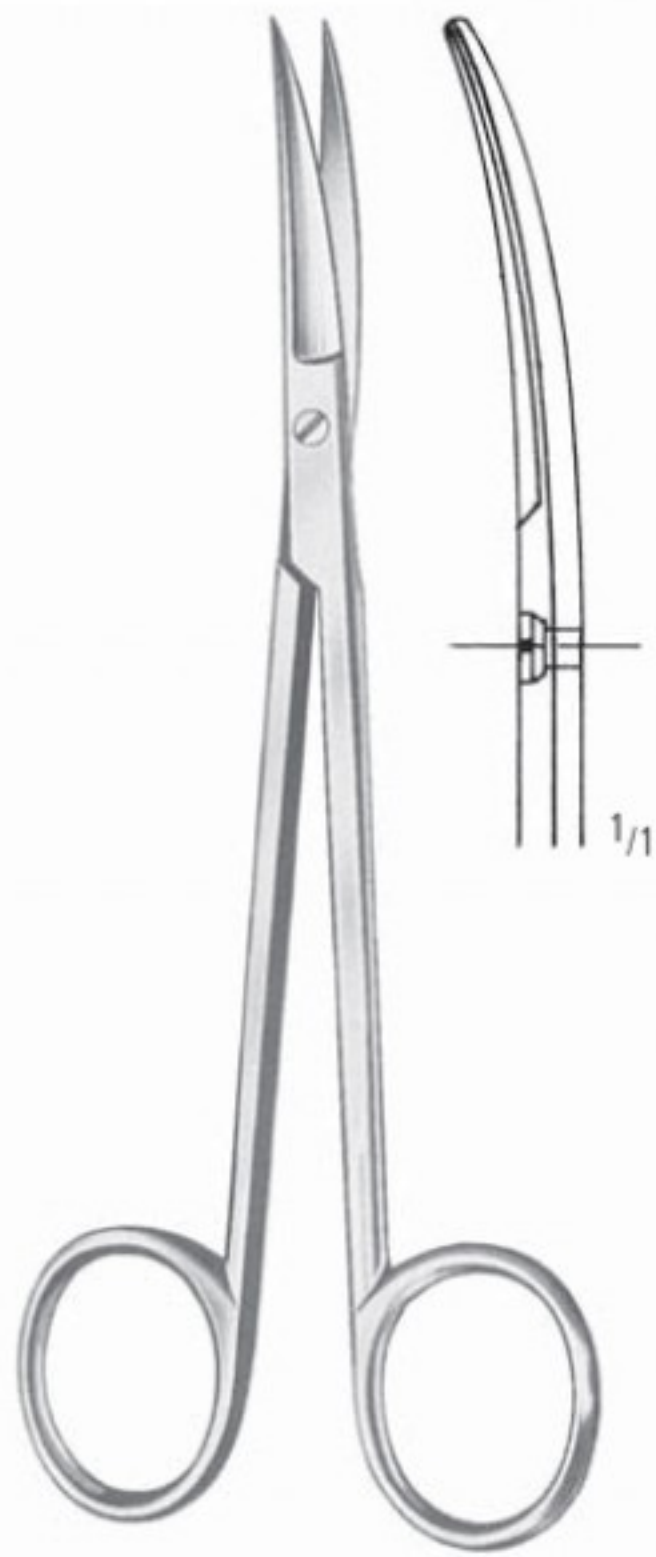

SANVENERO

AC 200/14
14,0 cm/5 1/2"

AC 201/14
14,0 cm/5 1/2"

JOSEPH

AC 204/14
14,0 cm/5 1/2"

AC 205/14
14,0 cm/5 1/2"

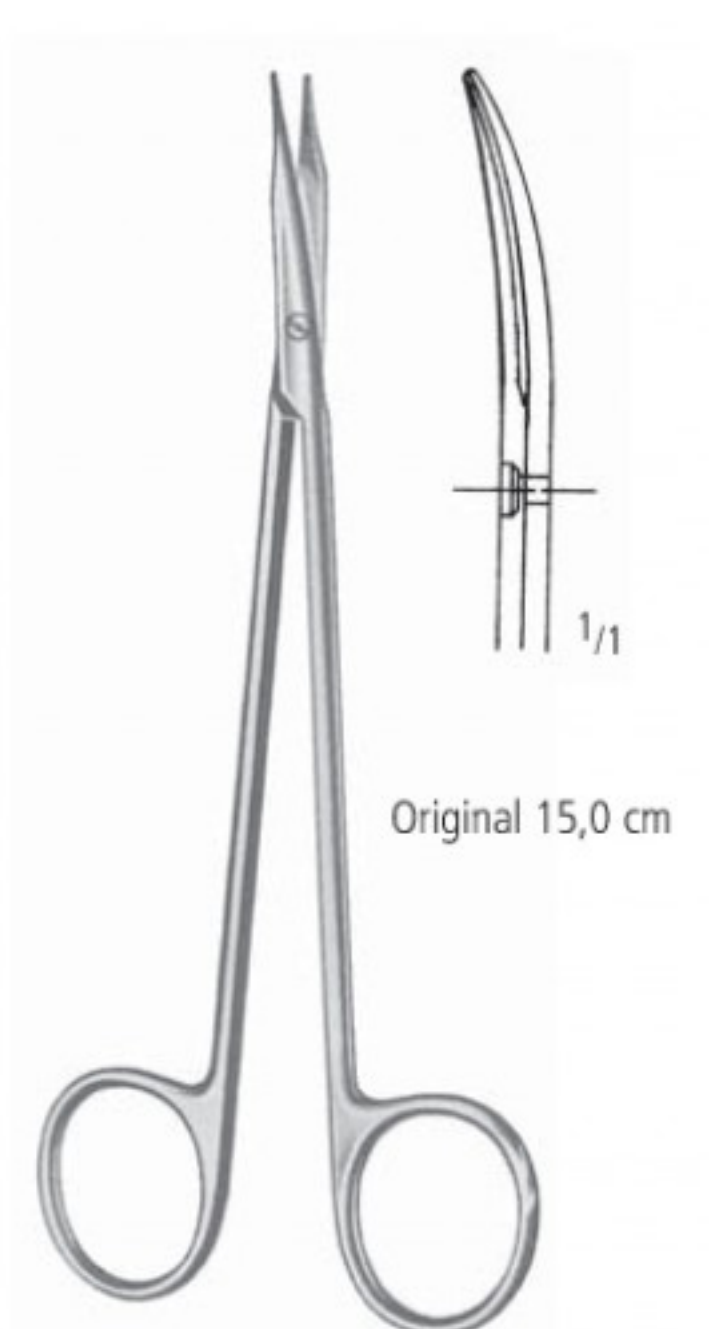
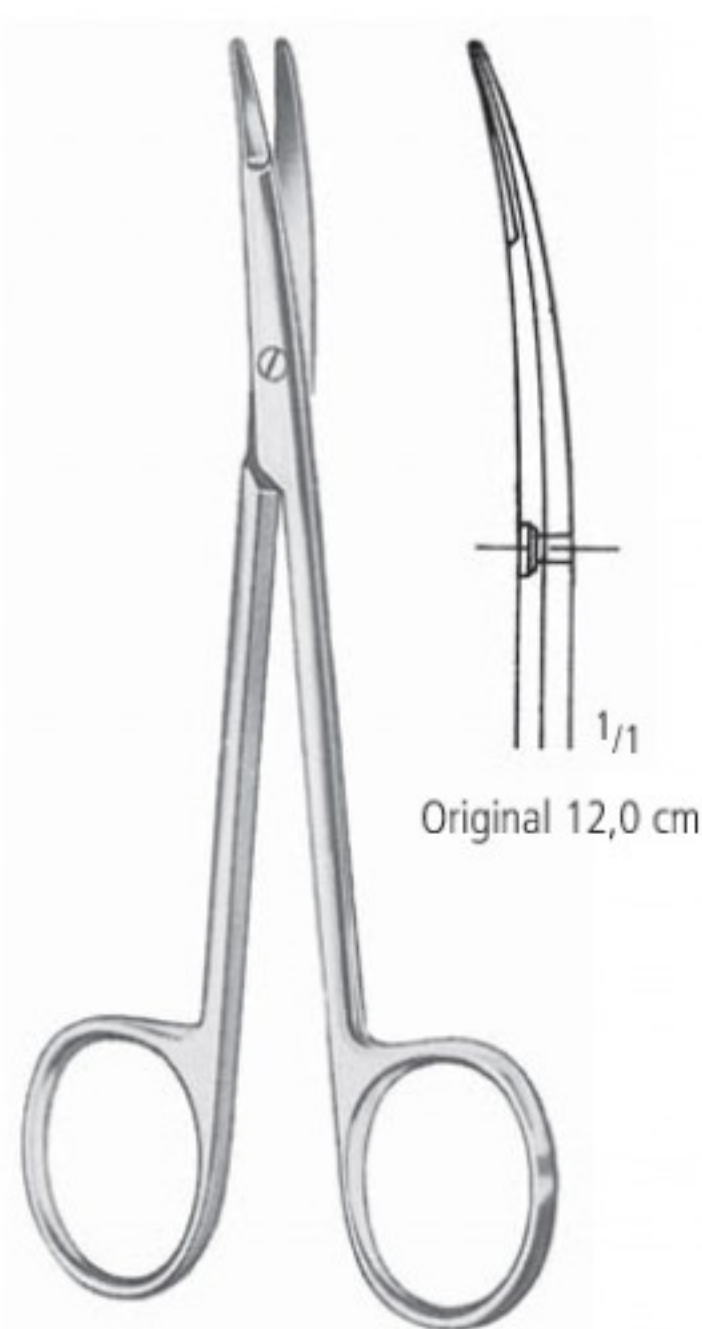

KILNER (RAGNELL)

AC 208/12	12,0 cm/4 3/4"	AC 210/12
AC 208/15	15,0 cm/6"	AC 210/15
AC 208/18	18,0 cm/7"	AC 210/18
AC 208/20	20,0 cm/8"	AC 210/20

REYNOLDS

AC 214/15*	15,0 cm/6"	AC 215/15
AC 214/18*	18,0 cm/7"	AC 215/18

SCHEREN SCISSORS TIJERAS CISEAUX FORBICI

Scheren für Gefäß-Chirurgie
 Scissors for Vascular Surgery
 Tijeras para cirugía vasculares
 Ciseaux pour chirurgie vasculaire
 Forbici per chirurgia vascolare

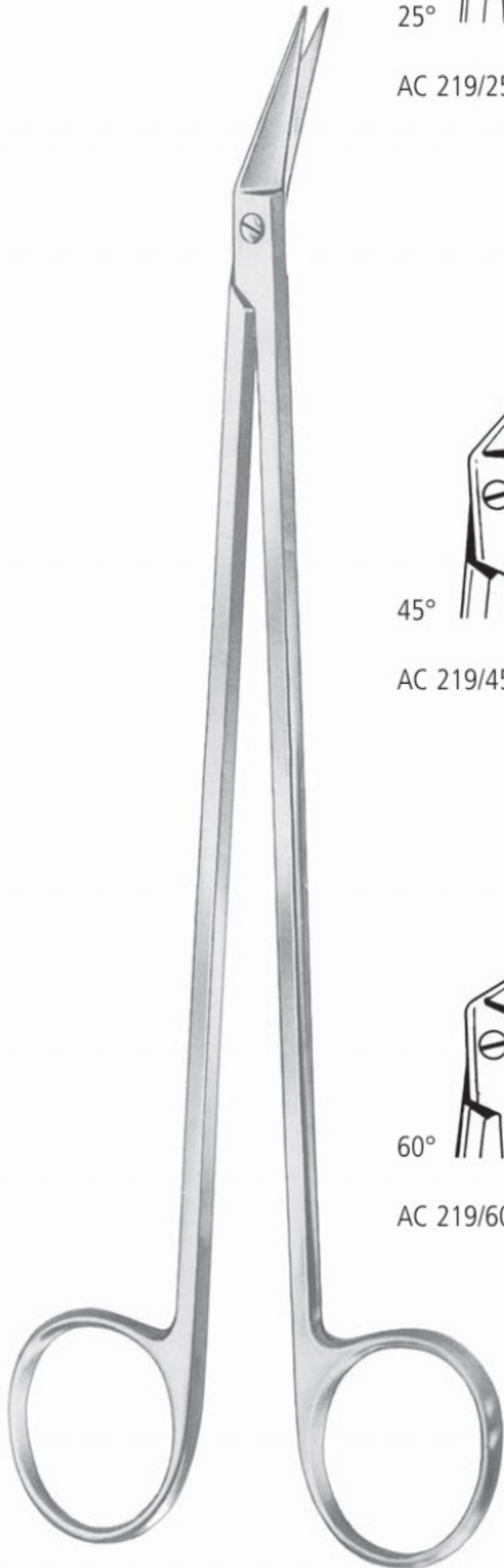

25°

AC 219/25



45°

AC 219/45

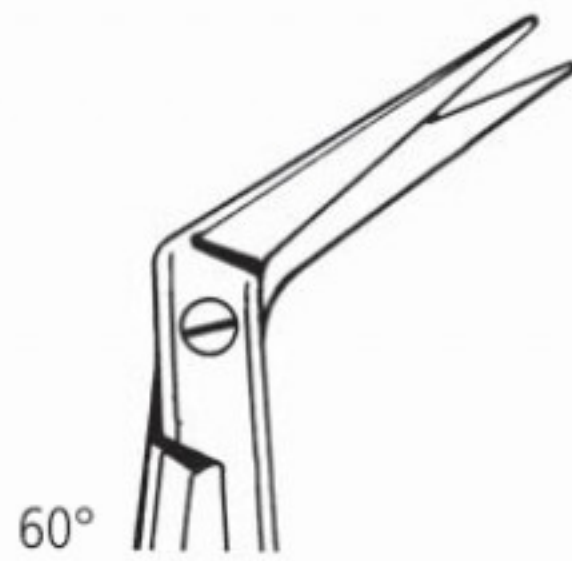

60°

AC 219/60

POTT-SMITH
 19,0 cm/7¹/₂"

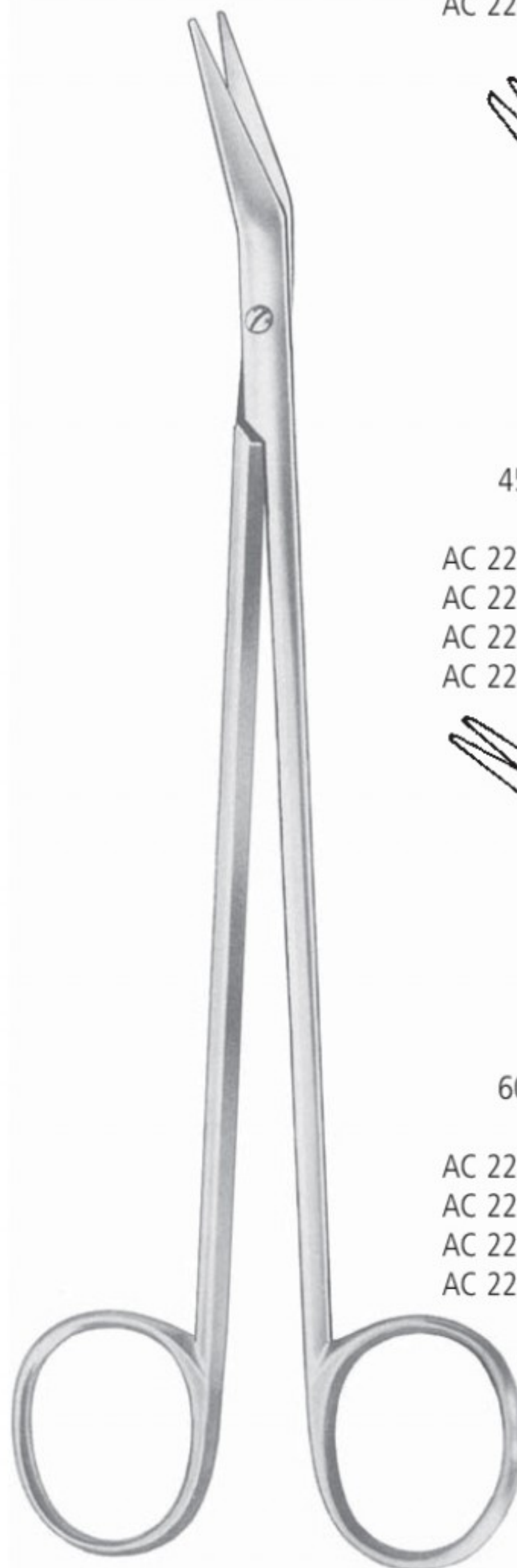

25°

AC 220/16 16,0 cm/6¹/₄"
 AC 220/19 19,0 cm/7¹/₂"
 AC 220/23 23,0 cm/9"
 AC 220/28 28,0 cm/11"



45°

AC 221/16 16,0 cm/6¹/₄"
 AC 221/19 19,0 cm/7¹/₂"
 AC 221/23 23,0 cm/9"
 AC 221/28 28,0 cm/11"

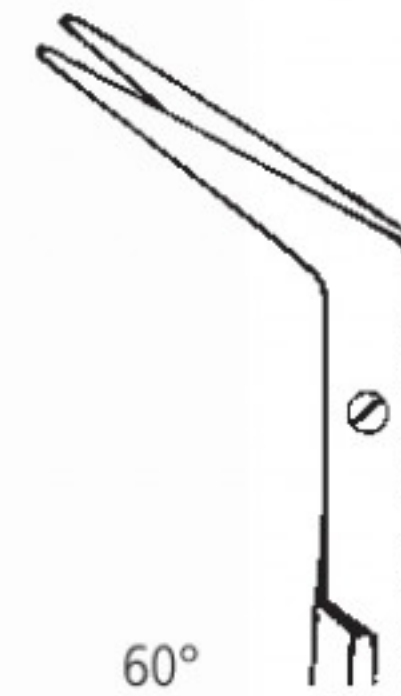

60°

AC 222/16 16,0 cm/6¹/₄"
 AC 222/19 19,0 cm/7¹/₂"
 AC 222/23 23,0 cm/9"
 AC 222/28 28,0 cm/11"

DE BAKERY

AA
 AB
 AC
 AD
 AE
 AF
 AK
 AL
 AO
 KA
 KK
 X

AC SCHEREN SCISSORS TIJERAS CISEAUX FORBICI

Scheren für Gefäß-Chirurgie
 Scissors for Vascular Surgery
 Tijeras para cirugía vasculares
 Ciseaux pour chirurgie vasculaire
 Forbici per chirurgia vascolare

Angle	Model Numbers	Dimensions
25°	AC 223/01 AC 224/01	18,0 cm/7" 19,0 cm/7½"
45°	AC 223/02 AC 224/02	18,0 cm/7" 19,0 cm/7½"
60°	AC 223/03 AC 224/03	17,5 cm/7" 19,0 cm/7½"
90°	AC 223/04 AC 224/04	17,0 cm/6¾" 19,0 cm/7½"
125°	AC 223/05 AC 224/05	17,0 cm/6¾" 19,0 cm/7½"

18,0 cm/7"

HEGEMANN-DIETRICH

AC 225/19
19,0 cm/7½"

SCHEREN SCISSORS TIJERAS CISEAUX FORBICI

Scheren für Gefäß- und Neurochirurgie
 Scissors for Vascular and Neuro Surgery
 Tijeras para cirugía vasculares y neurocirugía
 Ciseaux pour chirurgie vasculaire et neurochirurgie
 Forbici vascolari, Forbici per neurochirurgia

AA

AB

AC

AD

AE

AF

AK

AL

AO

KA

KK

X

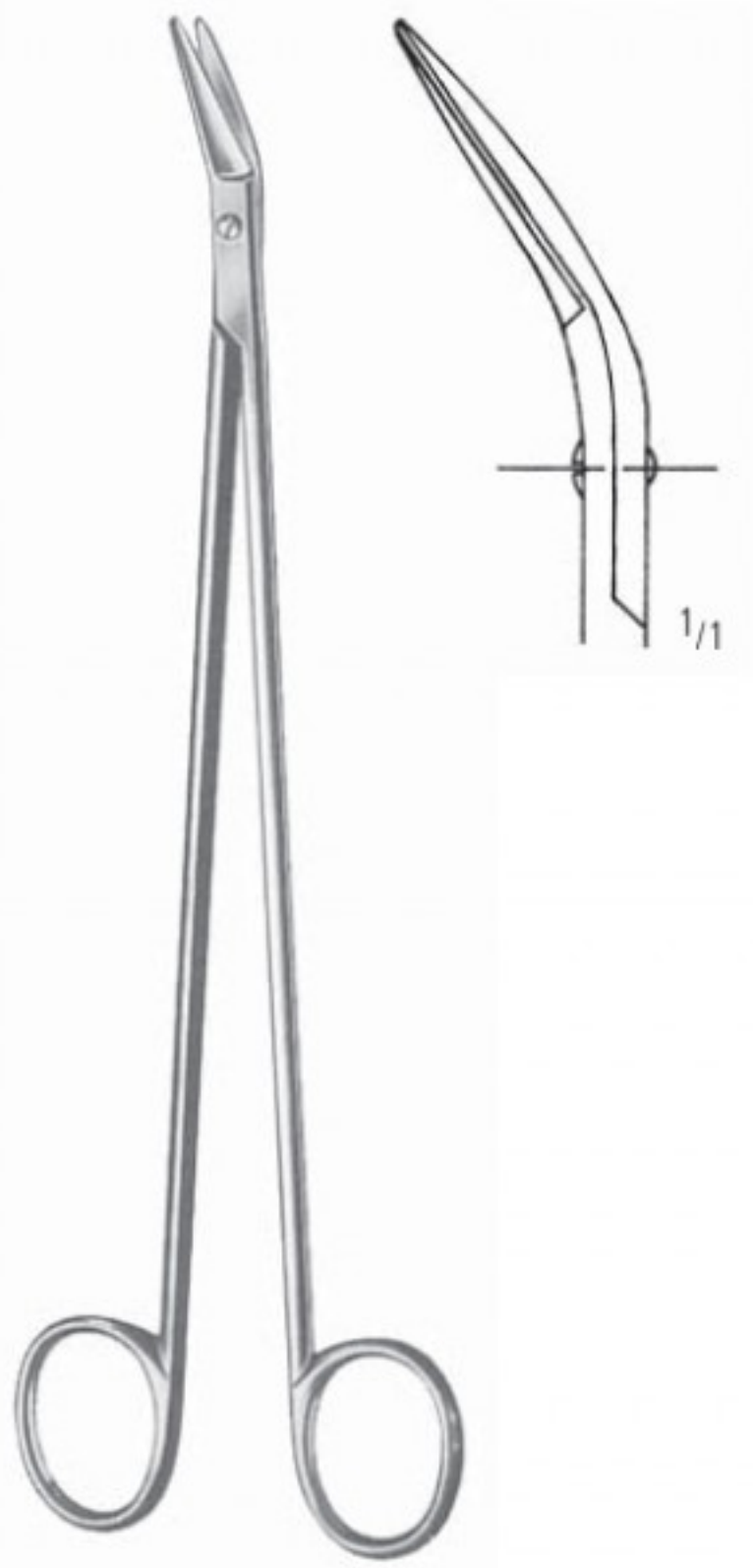

POTTS-SMITH
 AC 227/19
 19,5 cm/7³/₄"



Coronar-Schere
 Coronary-Scissors
 Tijeras coronarias
 Ciseaux coronaires
 Forbici coronaria

AC 228/11
 11,5 cm/4¹/₂"



AC 230/14
 14,5 cm/5³/₄"



geknöpft
 probe pointed
 con botón
 boutonne
 bottenuto

STRULLY

AC 231/22
 22,0 cm/8³/₄"



AC 232/22
 22,0 cm/8³/₄"



DANDY

AC 233/17
 17,0 cm/6³/₄"

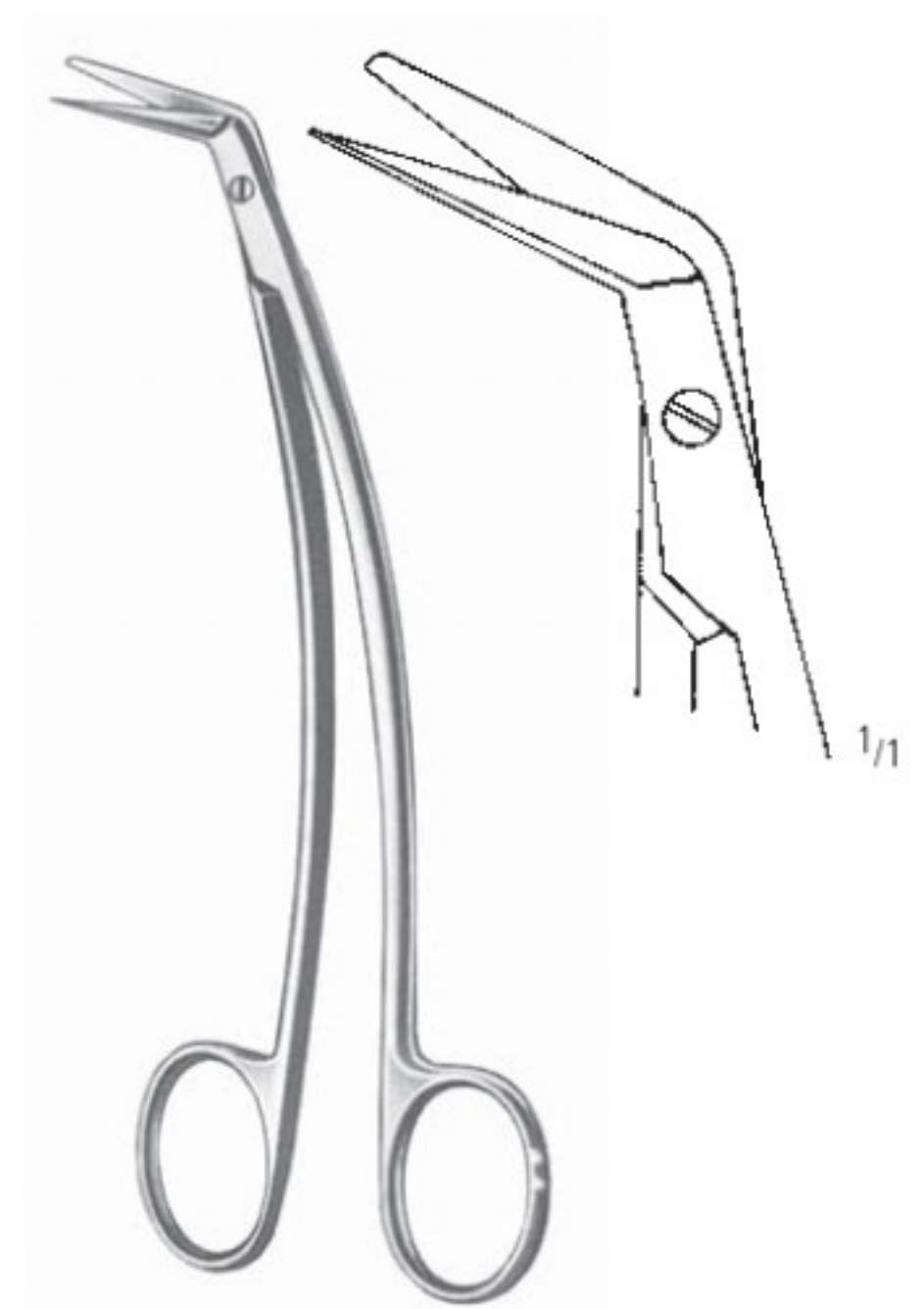

FAVALORO

AC 234/15
 15,0 cm/6"

AC SCHEREN SCISSORS TIJERAS CISEAUX FORBICI

Scheren für Gefäß- und Neurochirurgie
 Scissors for Vascular and Neuro Surgery
 Tijeras para cirugía vasculares y neurocirugía
 Ciseaux pour chirurgie vasculaire et neurochirurgie
 Forbici vascolari, Forbici per neurochirurgia

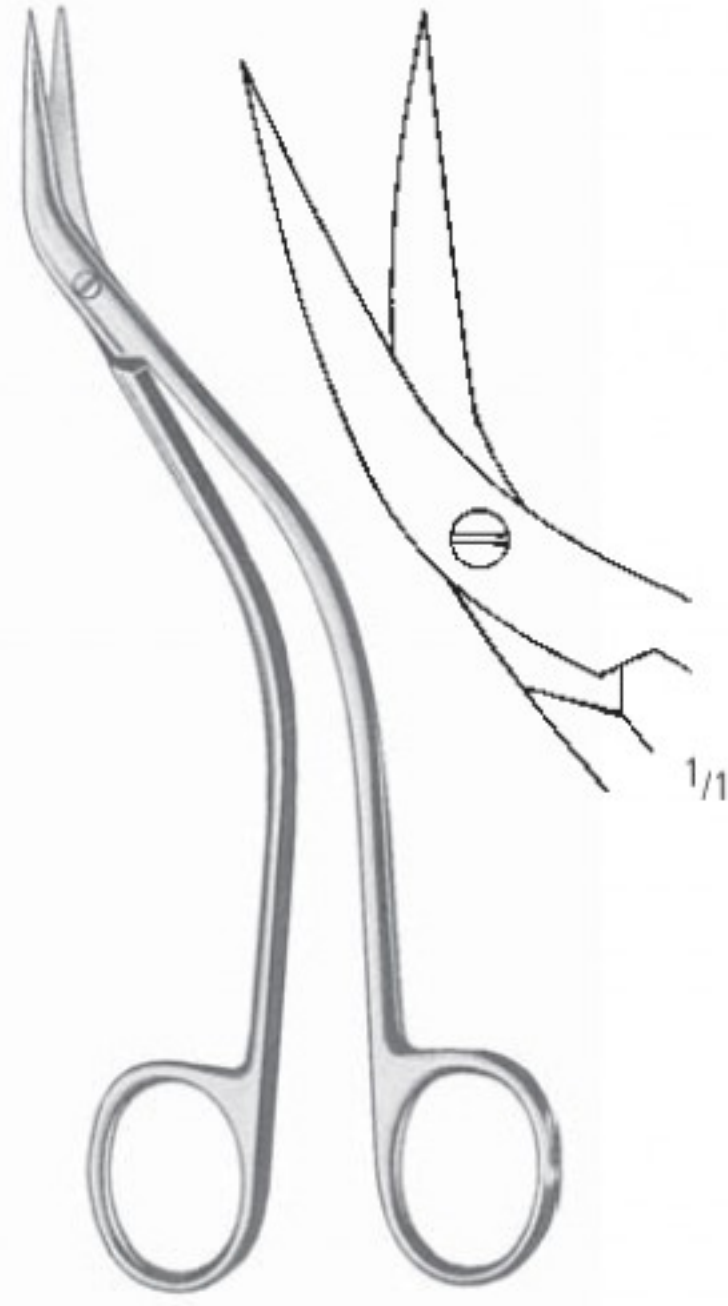
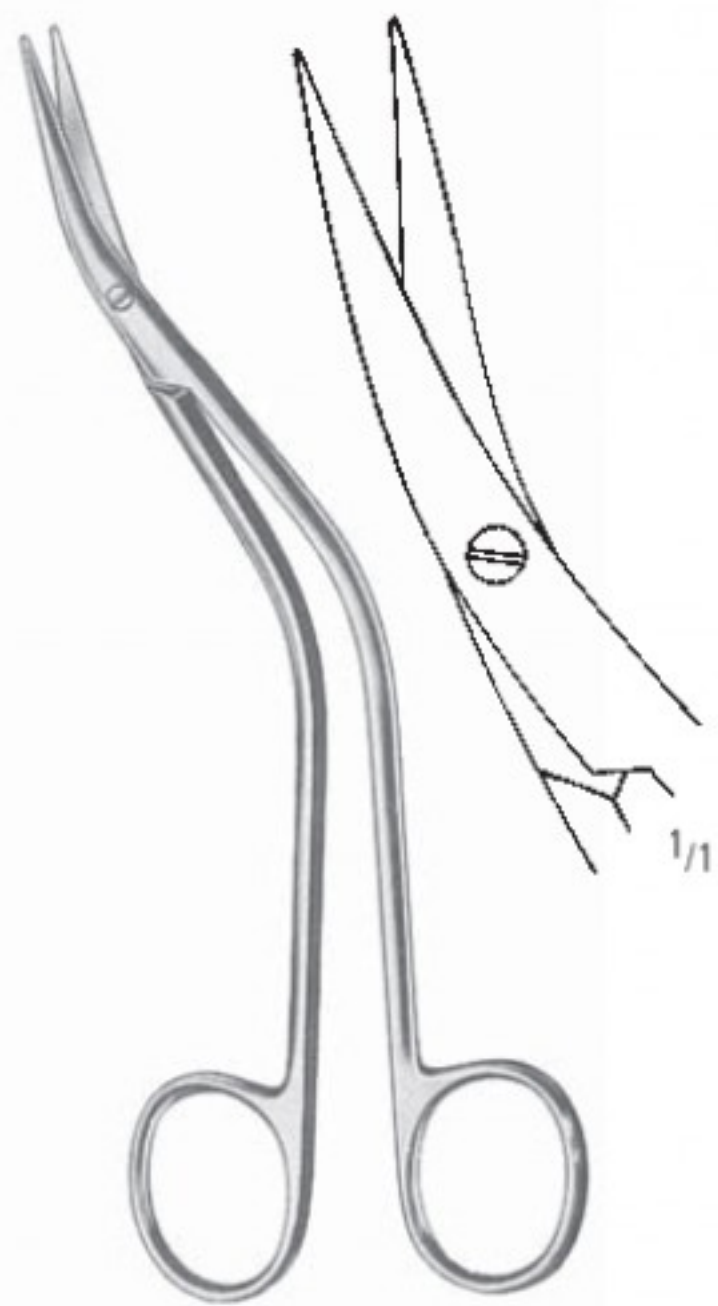

DE BAKEY

AC 235/15
 15,5 cm/6"

AC 236/15
 15,5 cm/6"



POTTS-DE MARTEL

AC 237/21
 21,0 cm/8¹/₄"

MILLS

AC 238/21
 21,0 cm/8¹/₄"

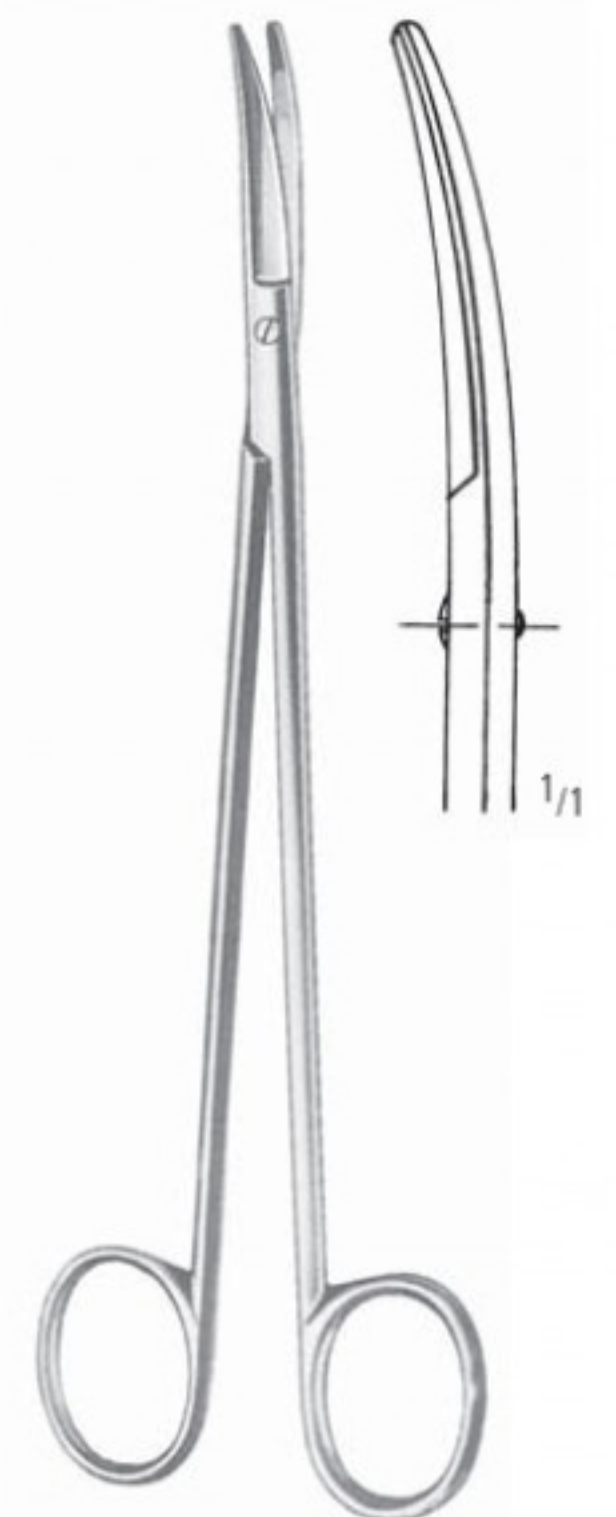
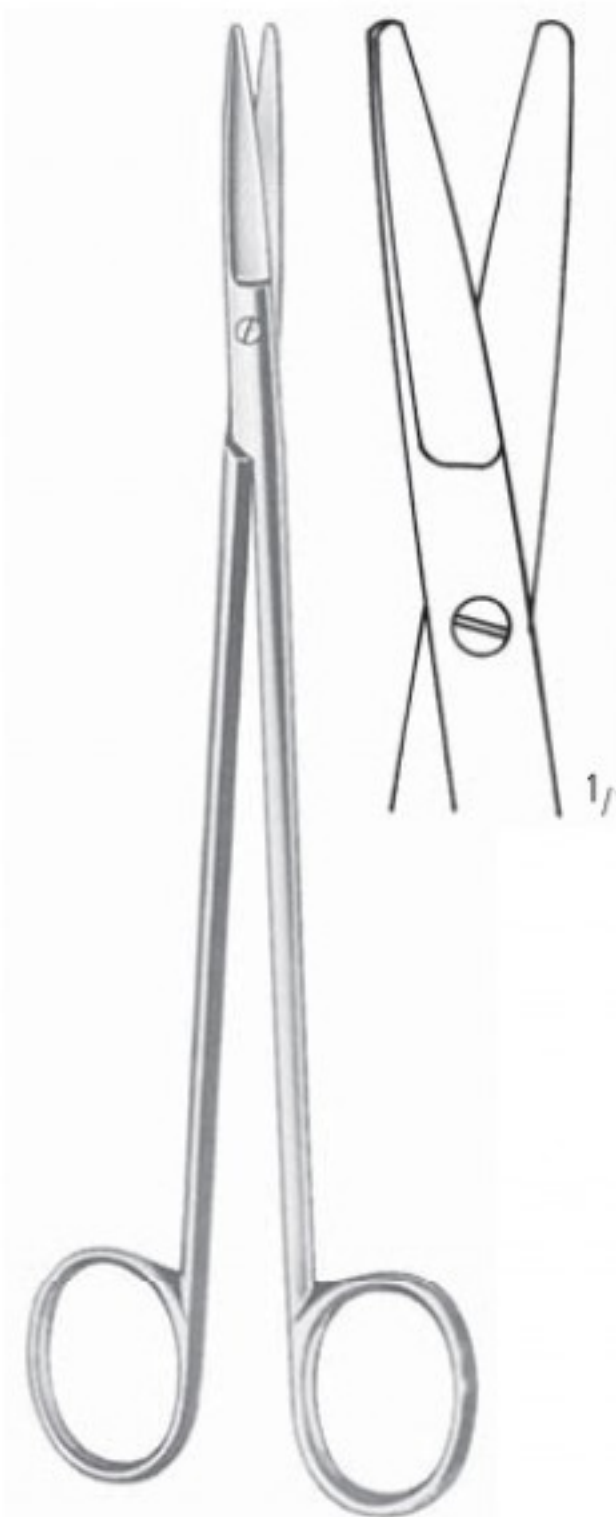
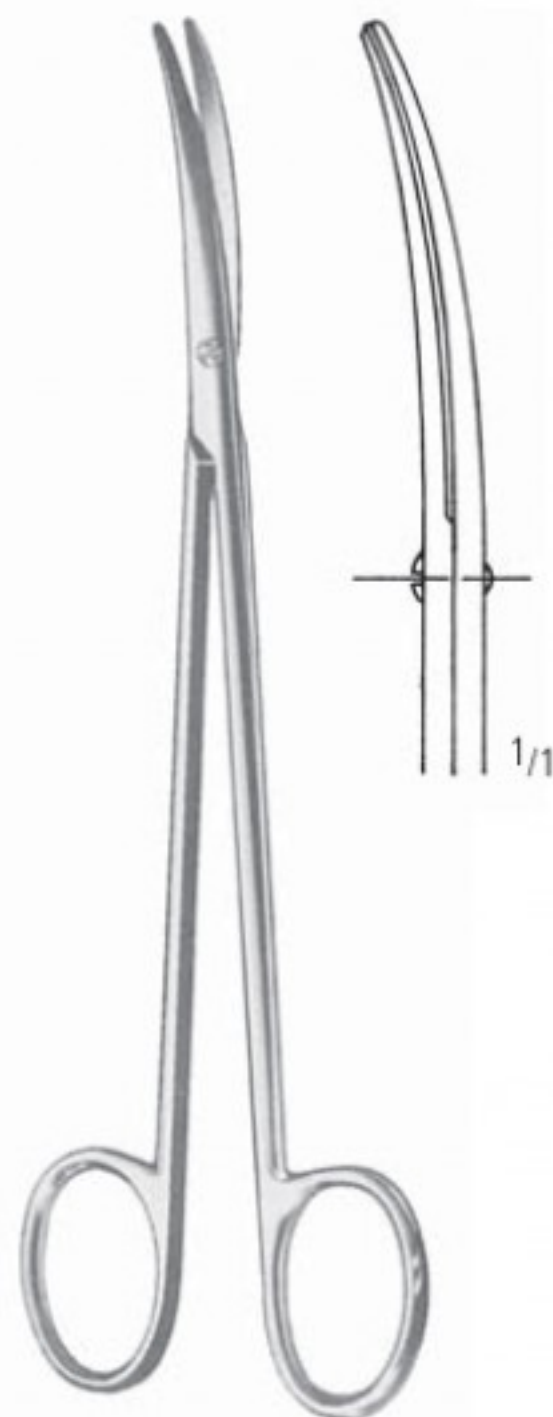

SCHMIEDEN-TAYLOR

14,5 cm/5¹/₂" AC 241/15
 17,0 cm/6³/₄" AC 241/17

TOENNIS-ADSON

AC 247/17
 17,5 cm/7"

TOENNIS

AC 248/18
 18,0 cm/7"

AC 249/18
 18,0 cm/7"

SCHEREN SCISSORS TIJERAS CISEAUX FORBICI

Scheren für Gefäß- und Neurochirurgie
 Scissors for Vascular and Neuro Surgery
 Tijeras para cirugía vasculares y neurocirugía
 Ciseaux pour chirurgie vasculaire et neurochirurgie
 Forbici vascolari, Forbici per neurochirurgia

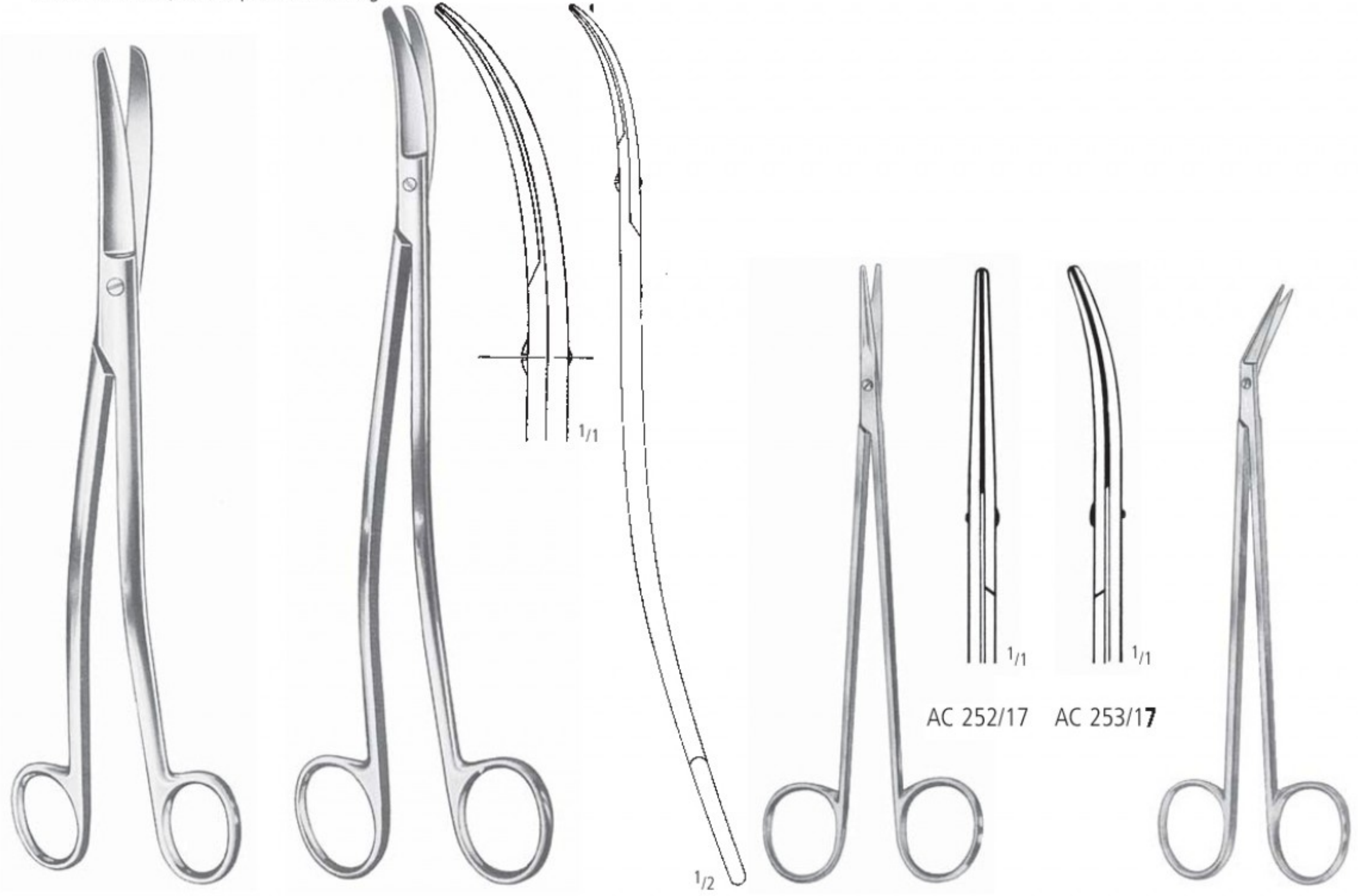

KLINKENBERGH-LOTH
 AC 250/23
 23,0 cm/9"

SATINSKY
 AC 251/24
 24,5 cm/9³/₄"

LINCOLN
 17,0 cm/6³/₄"

FULTON
 AC 255/17
 17,0 cm/6³/₄"

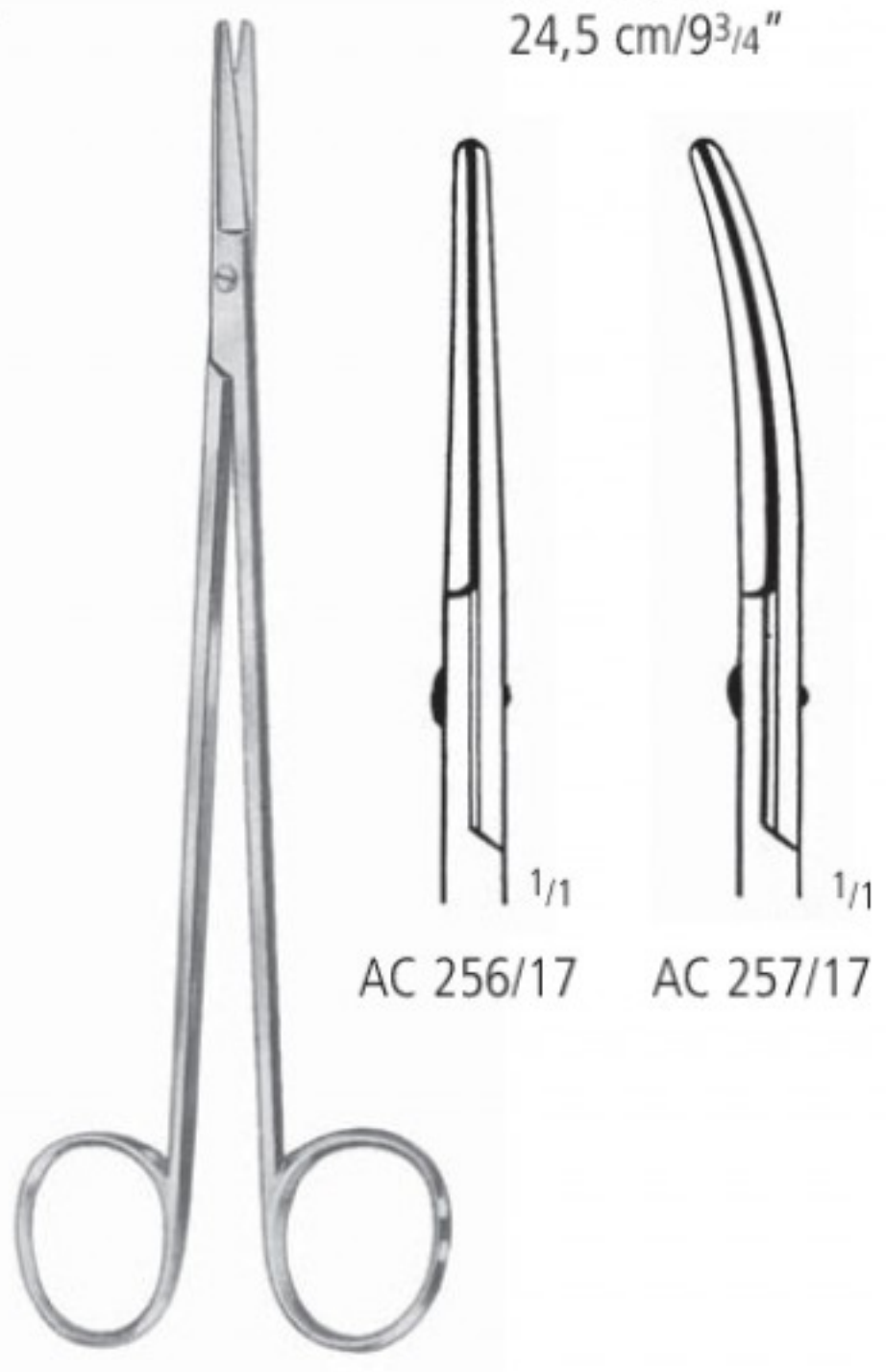

CHURCH
 17,0 cm/6³/₄"

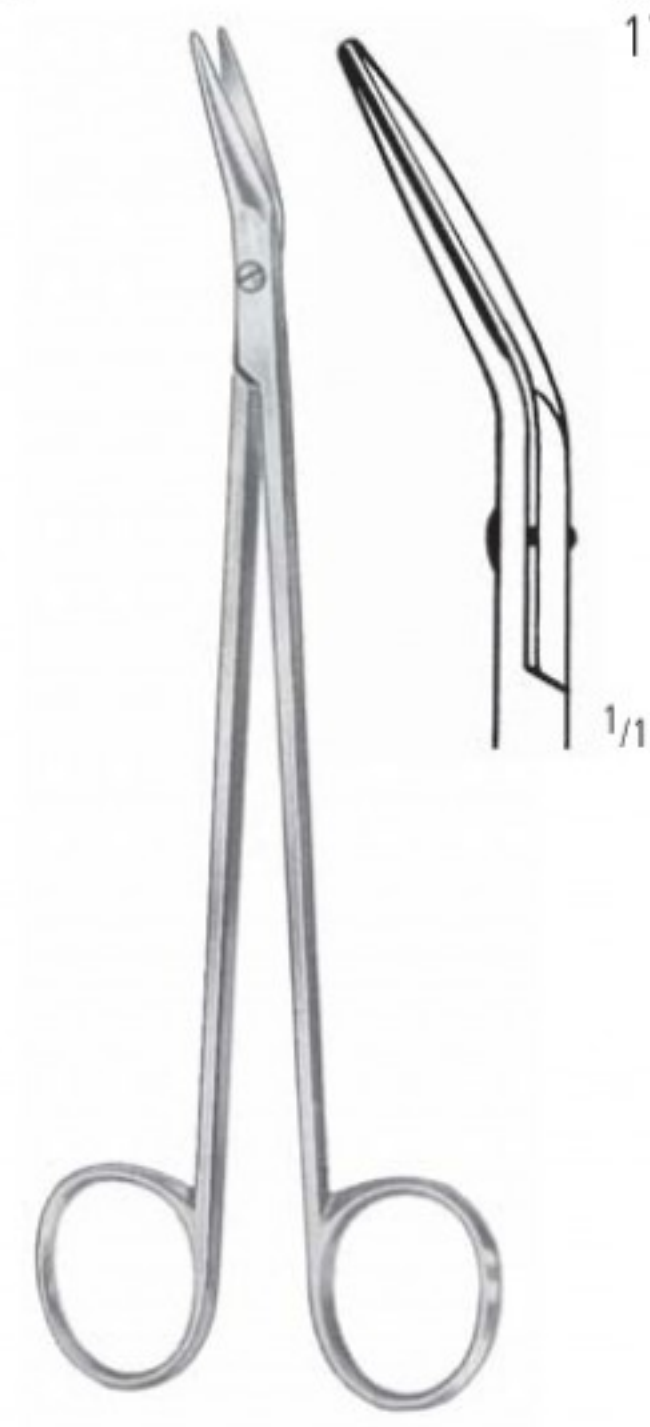

CLASSON
 AC 258/17
 17,0 cm/6³/₄"

AA
 AB
 AC
 AD
 AE
 AF
 AG
 AH
 AI
 AJ
 AK
 AL
 AM
 AN
 AO
 AP
 AQ
 AR
 AS
 AT
 AU
 AV
 AW
 AX

AC SCHEREN SCISSORS TIJERAS CISEAUX FORBICI

Knorpel-, Lungenlappen-, Darm- und Anatomiescheren
 Cartilage-, Lobectomy-, Enterotomy- and Dissecting Scissors
 Tijeras para cartilago, lobectomia, enterótomos y disección
 Ciseaux pour le cartilage, à lobectomie, à episiotomie et à préparation
 Forbici per cartilagini, lobectomia, episiotomia e anatomia



MARTIN-CARTILAGE
 AC 275/20
 20,0 cm/8"

MC INDOE
 AC 276/19
 19,0 cm/7¹/₂"

POTTS-SMITH
 AC 277/19
 19,0 cm/7¹/₂"

CRAFOORD
 AC 280/30
 30,0 cm/12"

FINOCHIETTO
 AC 281/27
 27,0 cm/10³/₄"

SCHEREN SCISSORS TIJERAS CISEAUX FORBICI

Feine Scheren
 Fine Scissors
 Tijeras finas
 Ciseaux fins
 Forbici fini

AA

AB

AC

AD

AE

AF

AG

AL

AO

KA

KK

X

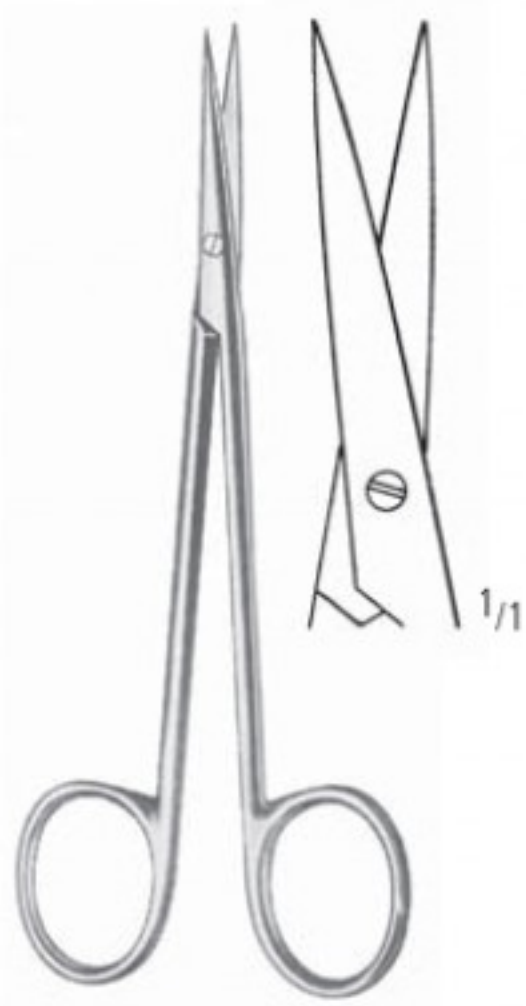

AC 410/11
 11,5 cm/4 1/2"

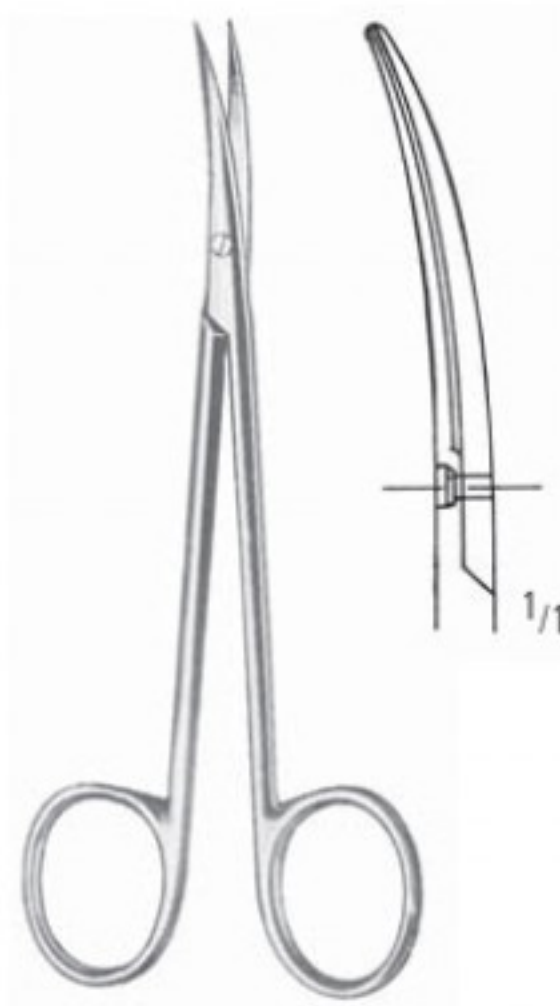

AC 411/11
 11,5 cm/4 1/2"

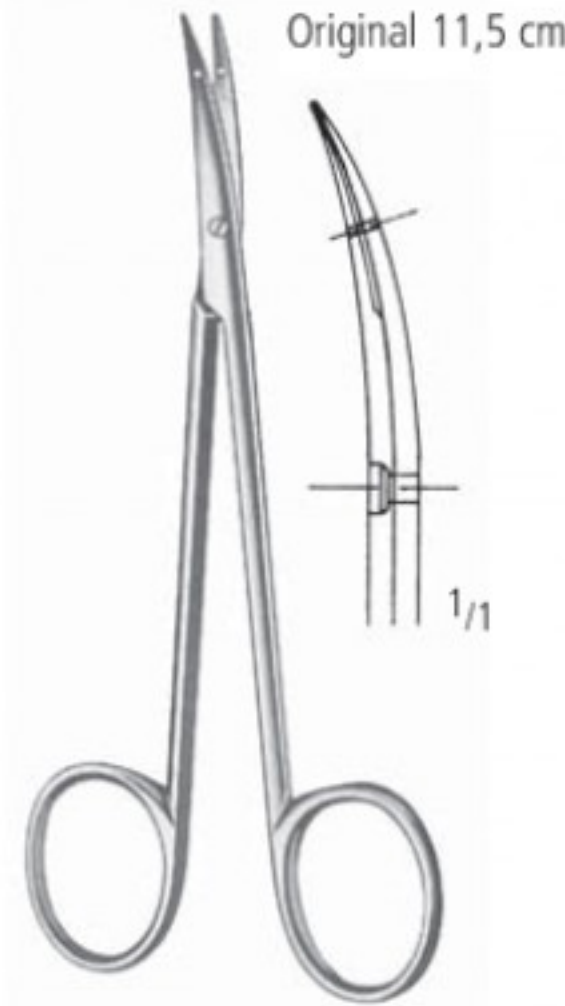

LITTLER
 AC 412/11 11,5 cm/4 1/2"
 AC 412/14 14,0 cm/5 1/2"

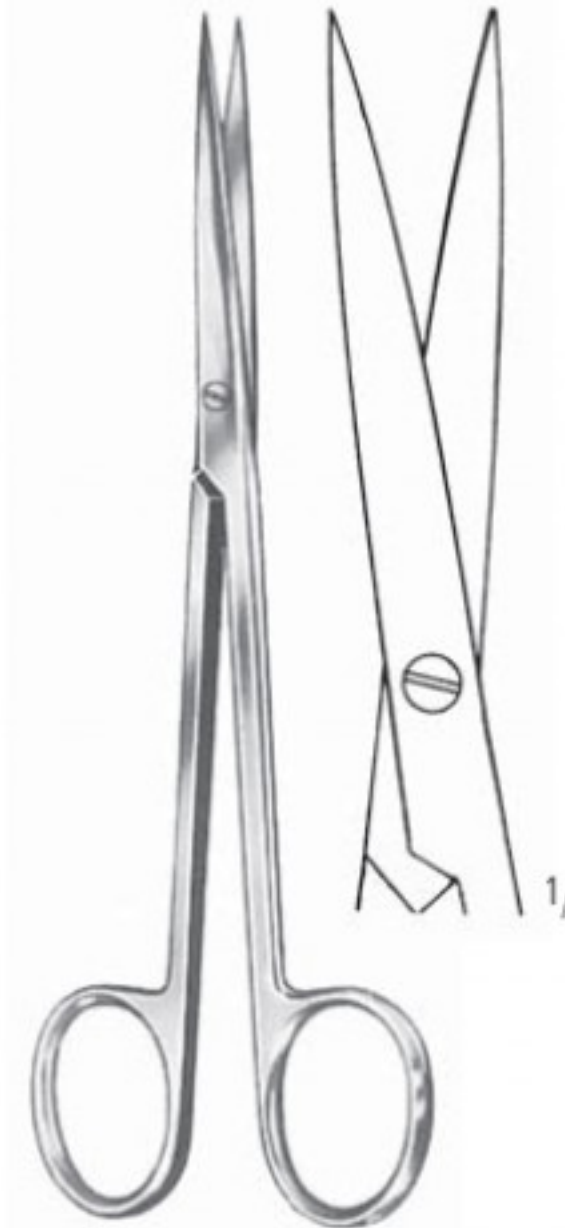

BROPHY (SULLIVAN)
 AC 414/14
 14,5 cm/5 3/4"

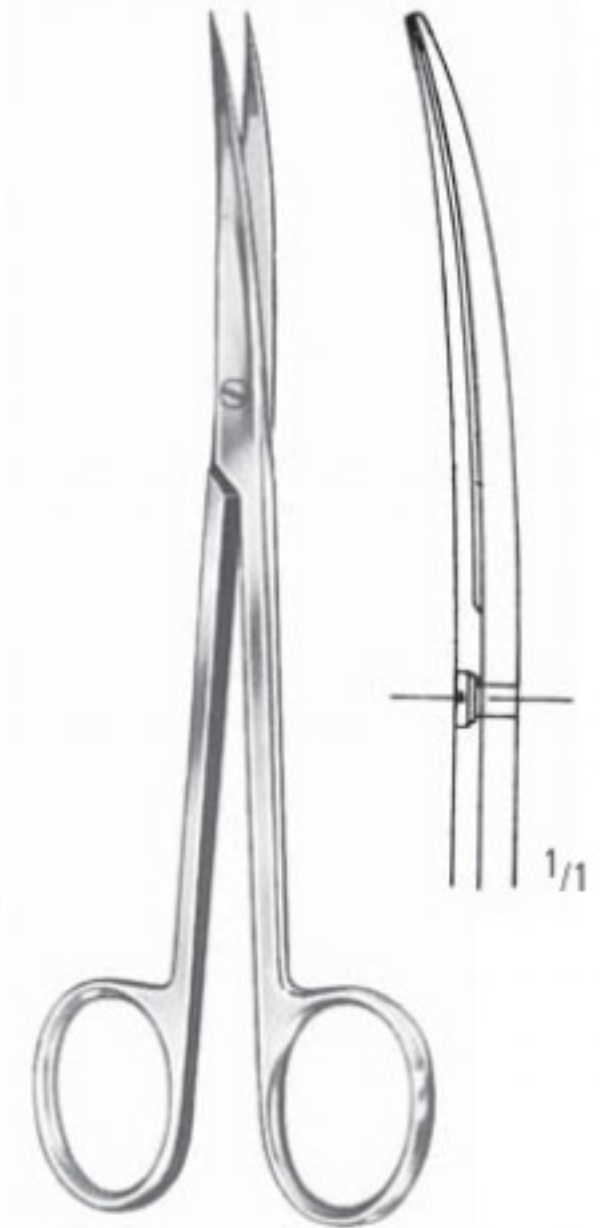

AC 415/14
 14,5 cm/5 3/4"

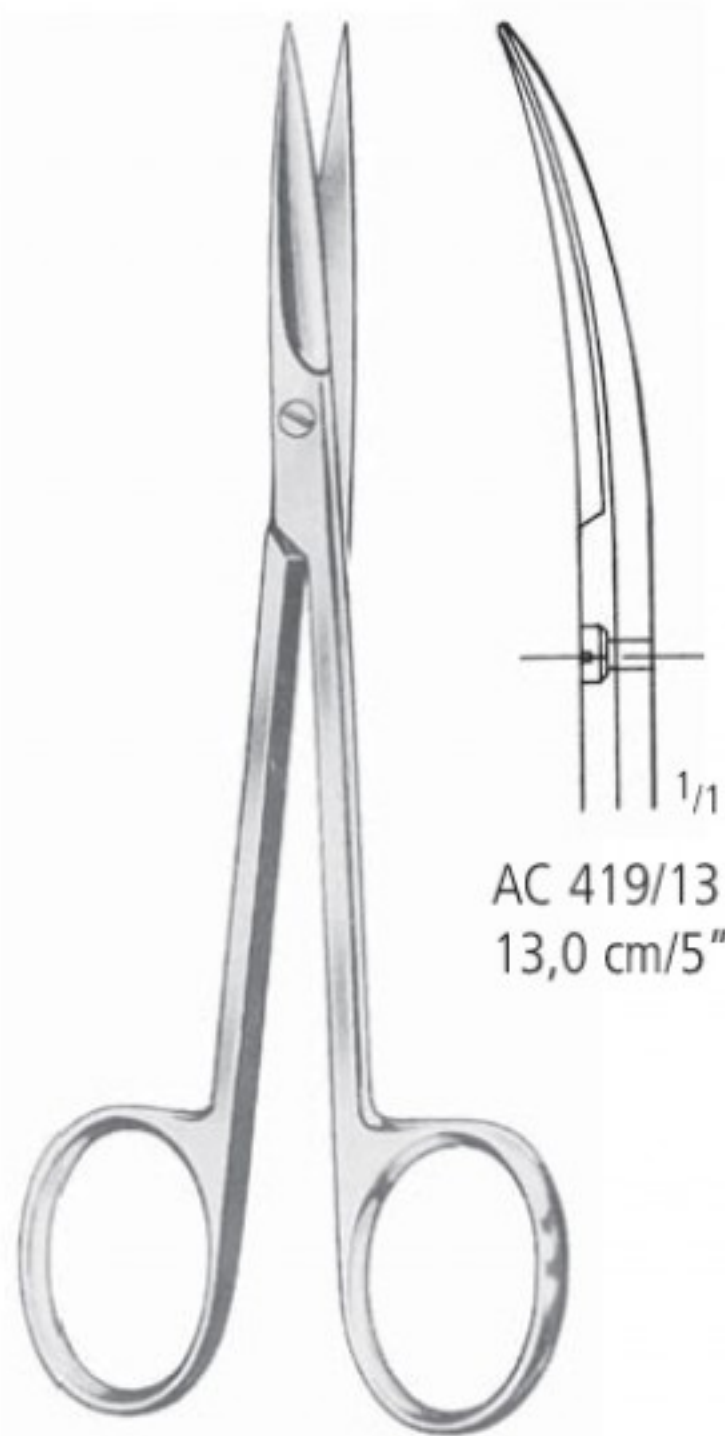

AC 418/13
 13,0 cm/5"

AC 419/13
 13,0 cm/5"



AC 422/10
 AC 422/11

10,5 cm/4 1/4"
 11,5 cm/4 1/2"



AC 423/10
 AC 423/11



AC 424/11
 11,5 cm/4 1/2"

AC SCHEREN SCISSORS TIJERAS CISEAUX FORBICI

Feine Scheren
 Fine Scissors
 Tijeras finas
 Ciseaux fins
 Forbici fini

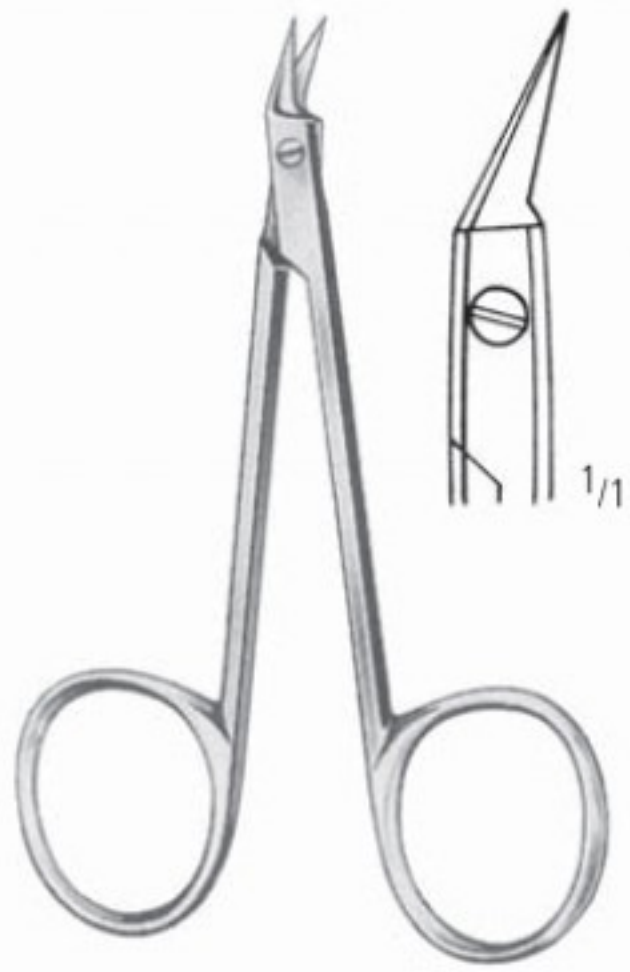

O'BRIEN
 AC 427/09
 9,0 cm/3 1/2"



WALTON
 AC 429/10
 10,0 cm/4"

sehr fein
 extra delicate
 muy finas
 très fin
 molto sottile



MOD. BONN
 AC 430/08
 8,0 cm/3"

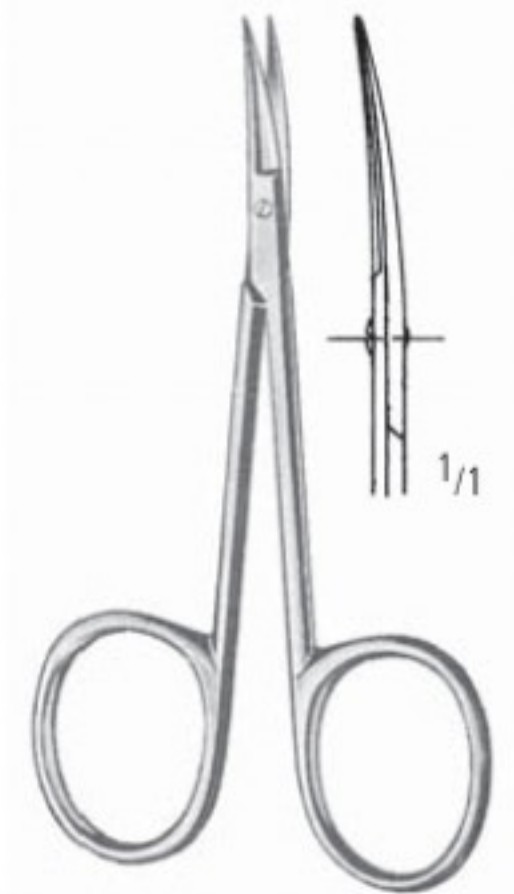

MOD. BONN
 AC 431/08
 8,0 cm/3"

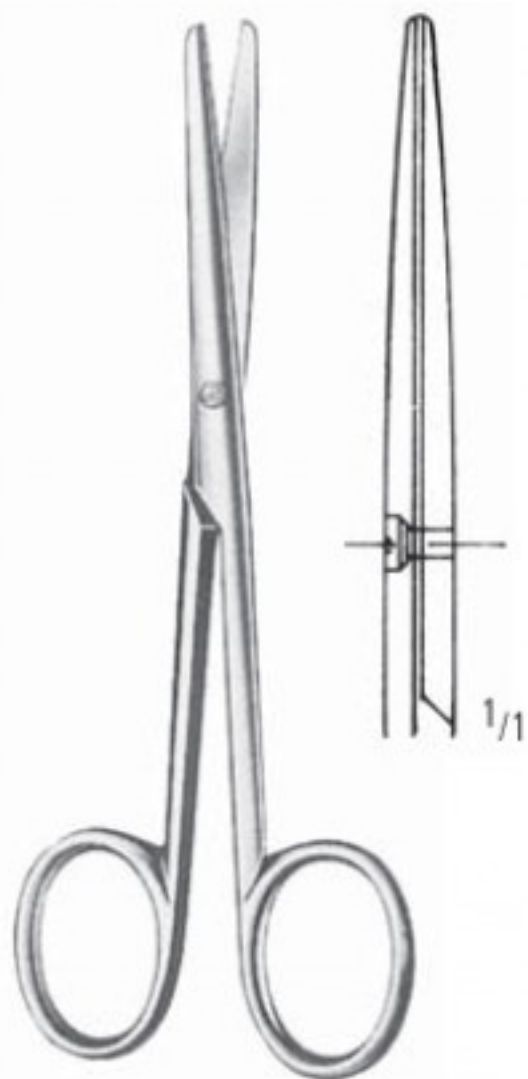

LANDOLT
 AC 434/12
 12,5 cm/5"

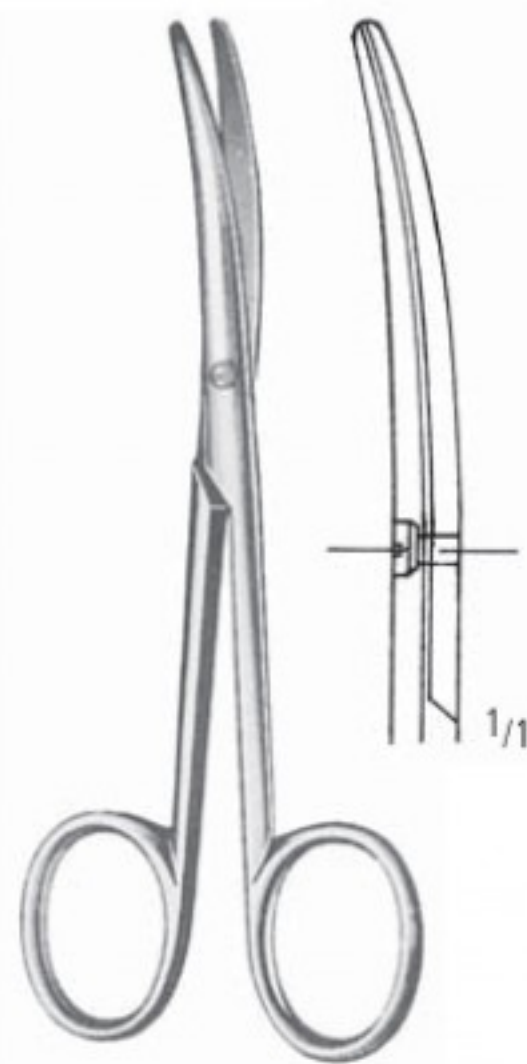

LANDOLT
 AC 435/12
 12,5 cm/5"

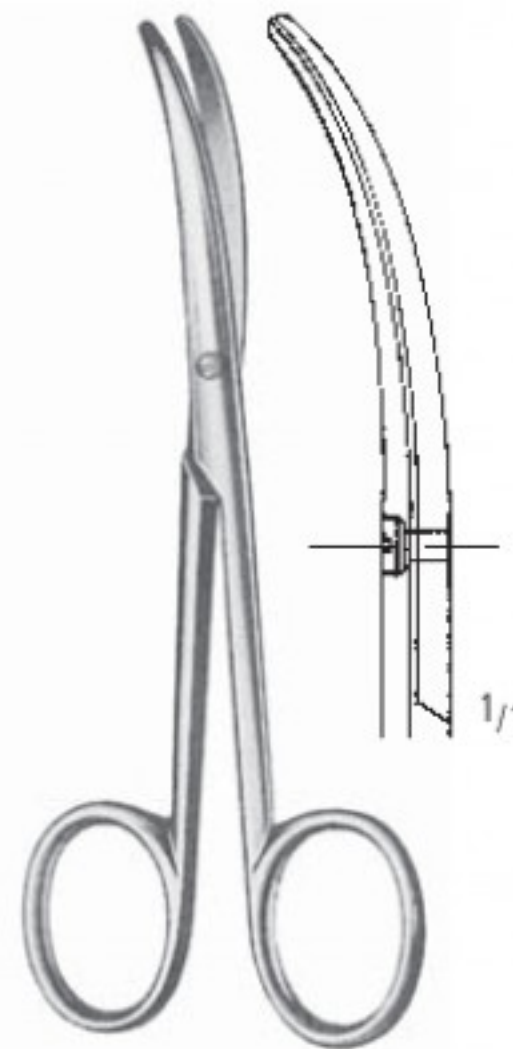

LANDOLT
 AC 436/12
 12,5 cm/5"

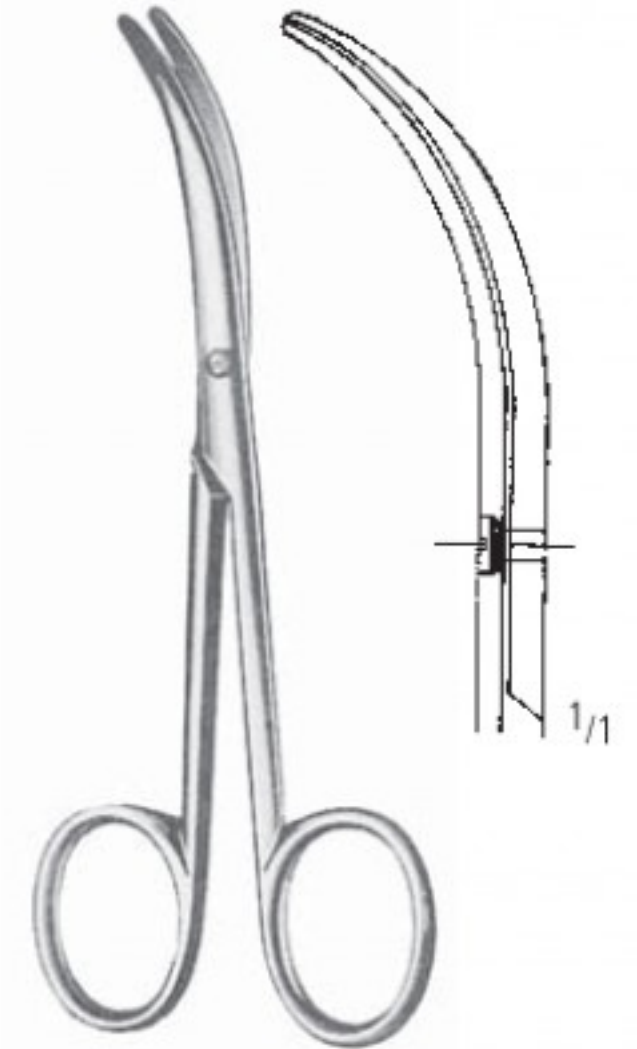

LANDOLT
 AC 437/12
 12,5 cm/5"

SCHEREN SCISSORS TIJERAS CISEAUX FORBICI

Feine Scheren
Fine Scissors
Tijeras finas
Ciseaux fins
Forbici fini

AA

AB

AC

AD

AE

AF

AK

AL

AO

KA

KK

X



11,5 cm/4 1/2"

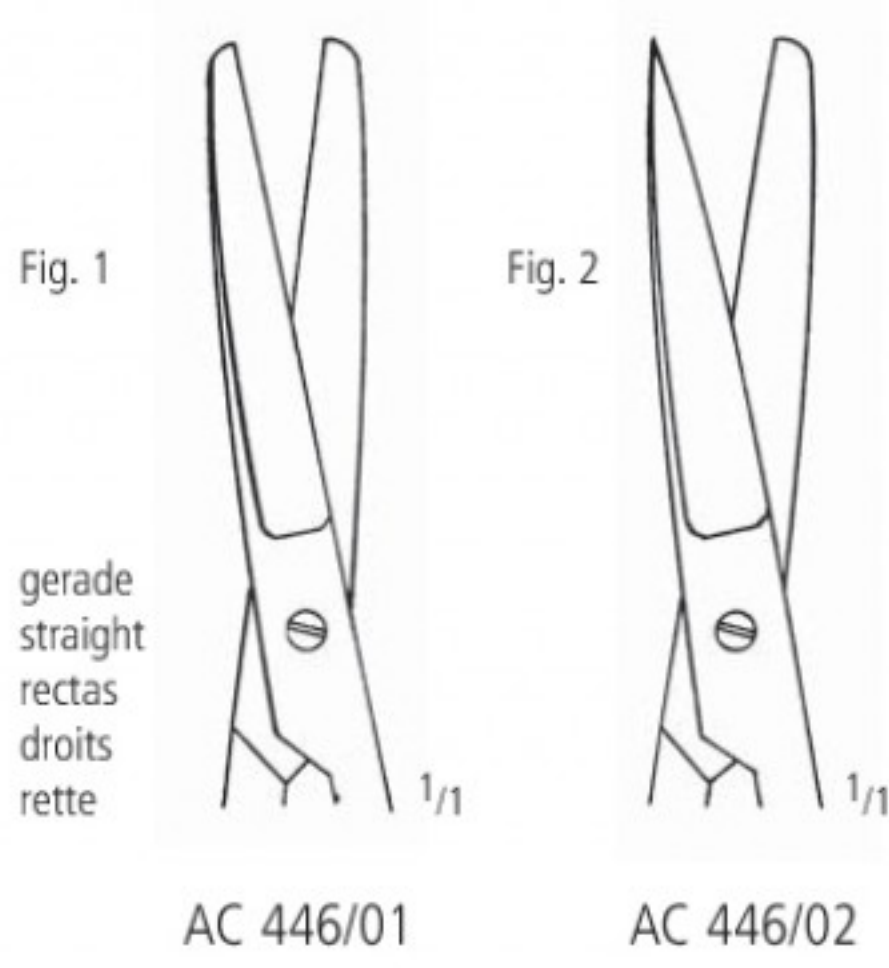

gerade
straight
rectas
droits
rette

AC 446/01

AC 446/02

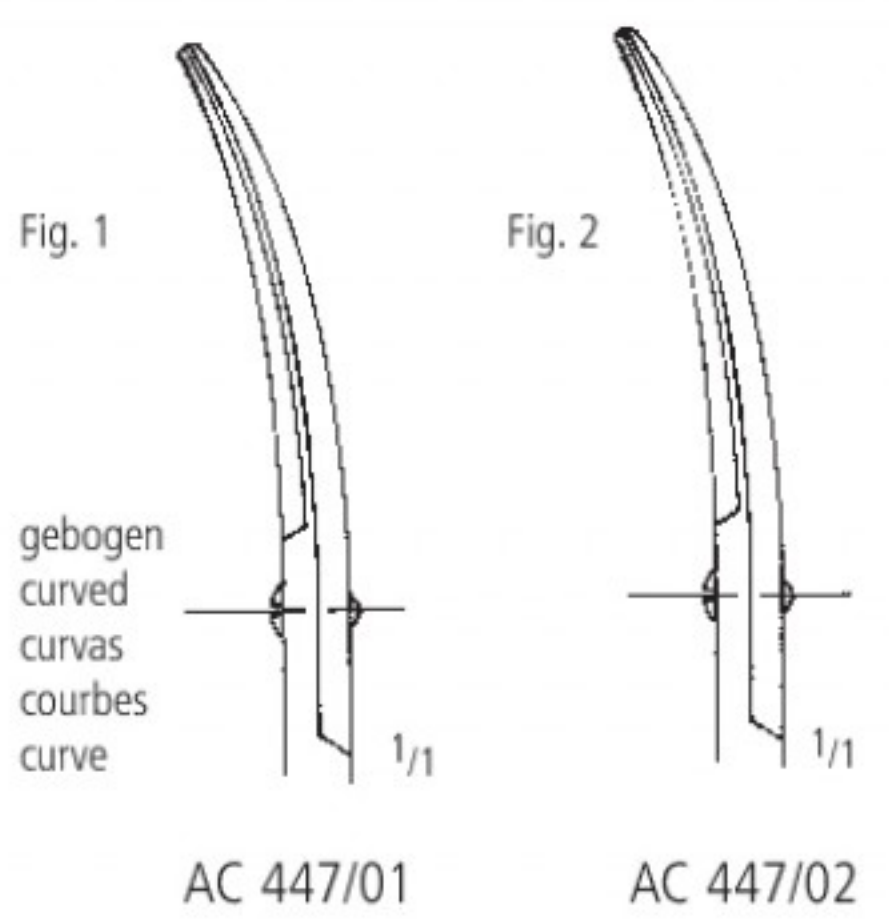

gebogen
curved
curvas
courbes
curve

AC 447/01

AC 447/02



AC 448/11
11,5 cm/4 1/2"



AC 449/11
11,5 cm/4 1/2"

Irisscheren
Iris Scissors
Tijeras para iridectomía
Ciseaux à iridectomie
Forbici per iridectomia



Original 10,5 cm



Original 10,5 cm

9,0 cm/3 1/2"	AC 450/09	AC 451/09
10,5 cm/4 1/4"	AC 450/10	AC 451/10
11,5 cm/4 1/2"	AC 450/11*	AC 451/11*

* Auch erhältlich als SC * Also available as SC

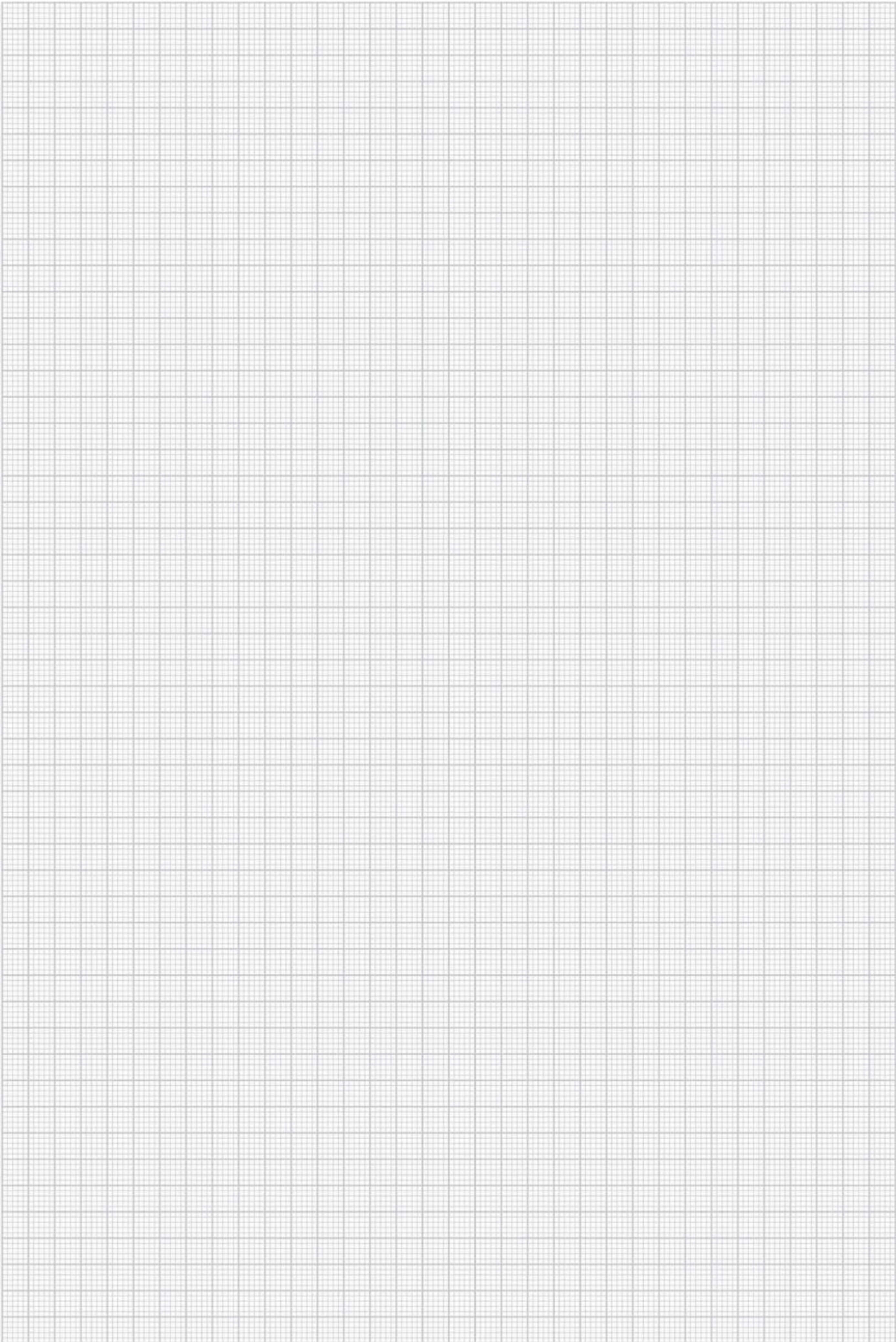

SCHEREN SCISSORS TIJERAS CISEAUX FORBICI

Feine Scheren
Fine Scissors
Tijeras finas
Ciseaux fins
Forbici fini

Sehnenscheren
Tenotomy Scissors
Tijeras para tenotomía
Ciseaux à ténotomie
Forbici per tenotomia

Original 11,5 cm

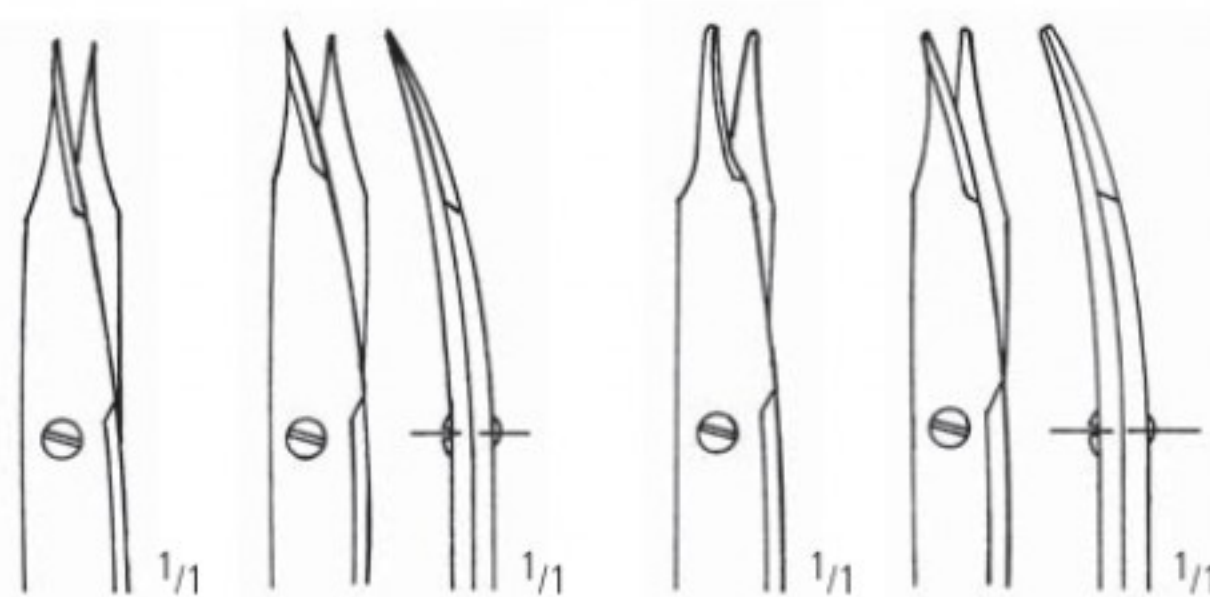

spitz
pointed
agudas
pointues
acuta

stumpf
blunt
romas
mousses
smussa

gerade
straight
rectas
droits
rette

gebogen
curved
curvas
courbes
curve

gerade
straight
rectas
droits
rette

gebogen
curved
curvas
courbes
curve

STEVENS

10,5 cm/4¹/₄"
11,5 cm/4¹/₂"

AC 474/10
AC 474/11

AC 475/10
AC 475/11

AC 476/10
AC 476/11*

AC 477/10
AC 477/11*

AA
AB
AC
AD
AE
AF
AK
AL
AO
KA
KK
X

Mikroscheren
Micro Scissors
Micro Tijeras
Micro Ciseaux
Micro Forbici

- >> Alle unsere Mikroscheren werden von Fachkräften mit jahrelanger Erfahrung hergestellt. Die Endkontrolle findet unter dem Mikroskop statt. Um Ihnen ein ermüdungsfreies Arbeiten zu ermöglichen, wird dem Federdruck größte Aufmerksamkeit gewidmet.
- >> Bitte wählen Sie unter Rund- oder Flachgriffscheren.

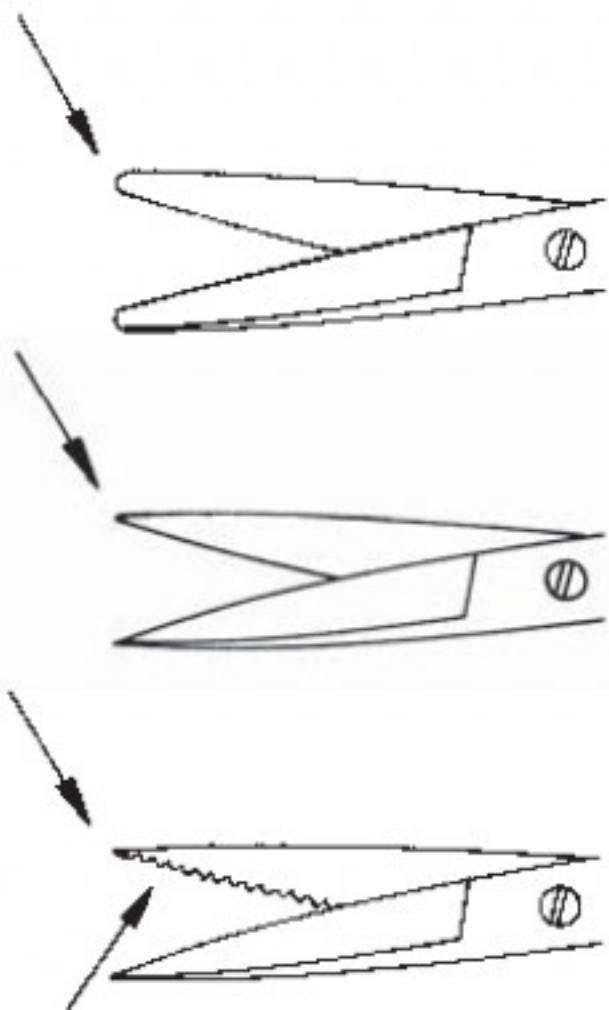

Dissection: **Gebogene Blätter, abgerundete Spitzen** ermöglichen eine gute und sichere Dissektion, ohne Nerven und Blutgefäße zu beschädigen.

Adventitia: **Gerade Blätter, sehr scharfe Spitzen** gewährleisten präzises Anfrischen von Gefäßenden.

Nerve: Ein Blatt ist **fein gezahnt**, um ein Herausgleiten des Nervs zu vermeiden.

- >> All our Micro Scissors are manufactured by skilled craftsmen with many years of experience. Final inspection is carried out under a microscope. Careful attention is paid to the closing pressure of the spring handle, to ensure precise work during surgeries, without fatigue.
- >> Round or flat handle scissors according to your preference.

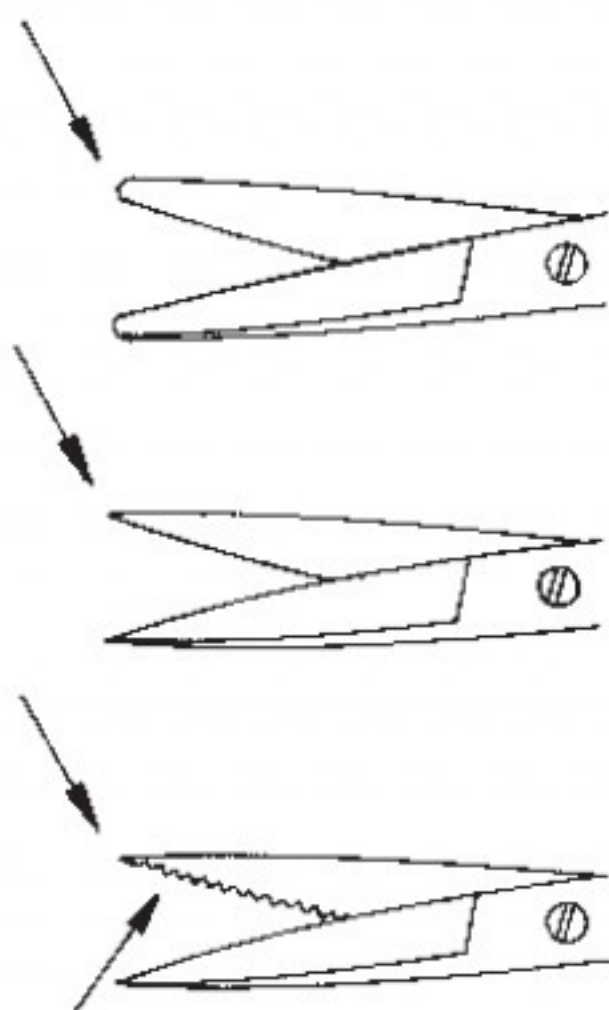

Dissection: **Curved blades, slightly rounded tips** ensure safe dissection without damage to nerves and vessels.

Adventitia: **Straight blades, very sharp tips** for finest trimming of vessel ends.

Nerve: One blade is **fine-toothed** to avoid slipping of the nerve.

SCHEREN SCISSORS TIJERAS CISEAUX FORBICI

Mikroscheren
Micro Scissors
Micro Tijeras
Micro Ciseaux
Micro Forbici

AA

AB

AC

AD

AE

AF

AK

AL

AO

KA

KK

X

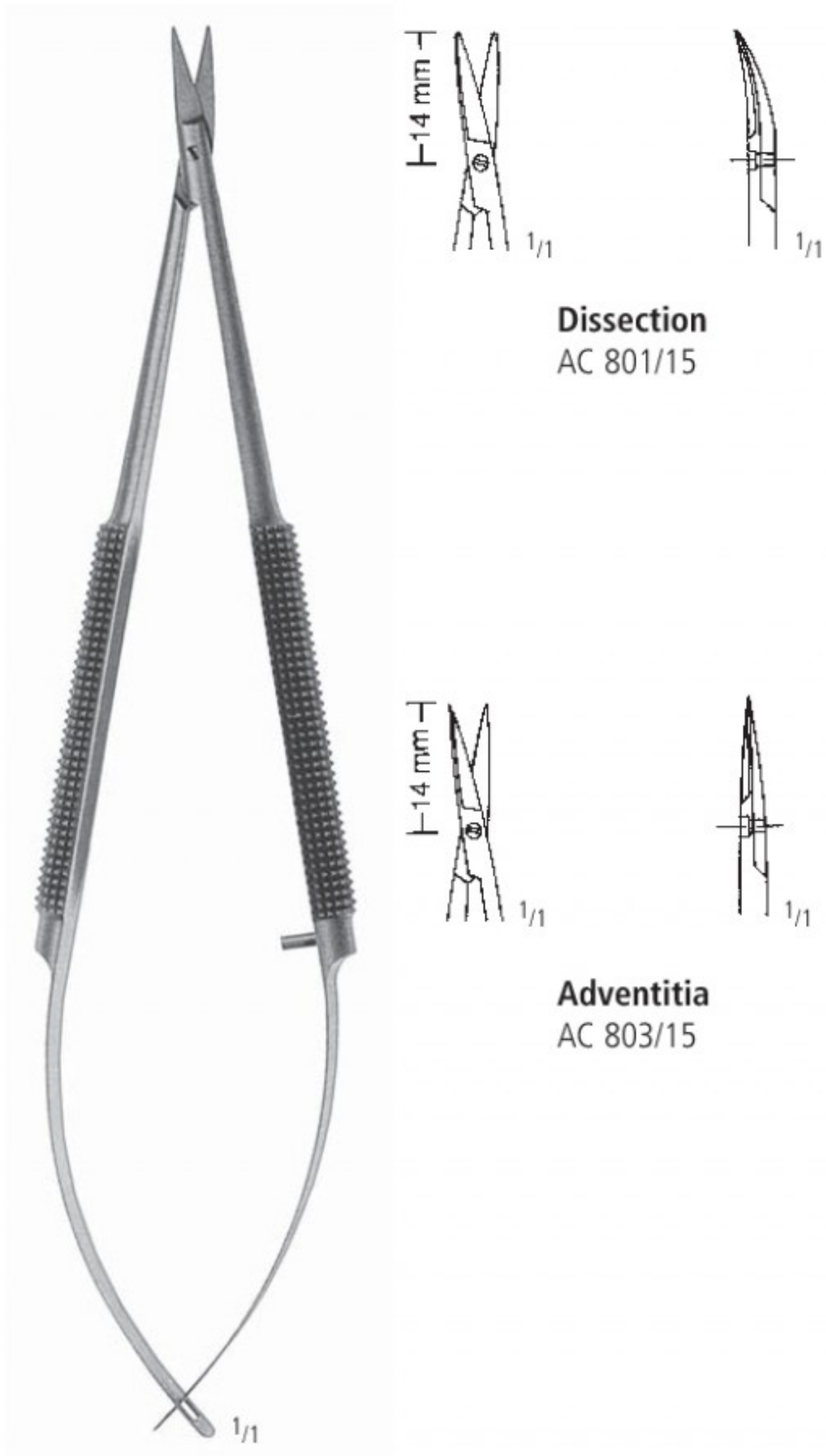

Dissection
AC 801/15

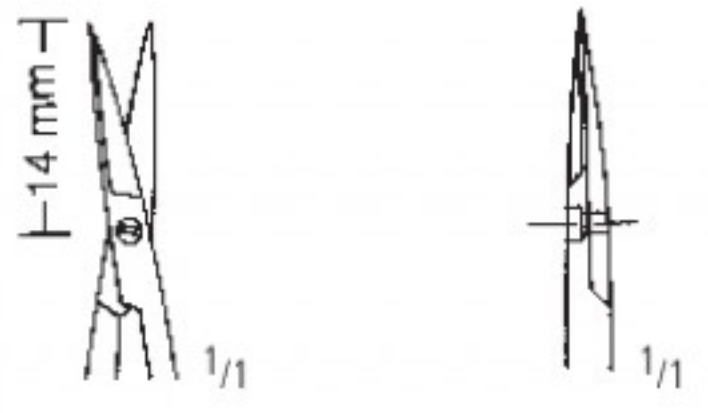

Adventitia
AC 803/15

14,5 cm/5³/₄"



Dissection
AC 801/18

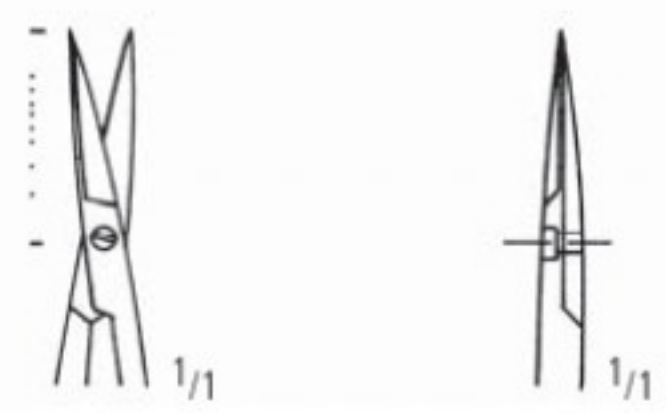

Adventitia
AC 803/18

18,0 cm/7"

Mikroscheren
 Micro Scissors
 Micro Tijeras
 Micro Ciseaux
 Micro Forbici



AC 807/14
 14,5 cm/5³/₄"



AC 812/18
 18,0 cm/7"



AC 817/18
 18,0 cm/7"

SCHEREN SCISSORS TIJERAS CISEAUX FORBICI

Mikroscheren
Micro Scissors
Micro Tijeras
Micro Ciseaux
Micro Forbici

AA

AB

AC

AD

AE

AF

AK

AL

AO

KA

KK

X



11,0 cm/4¹/₃"

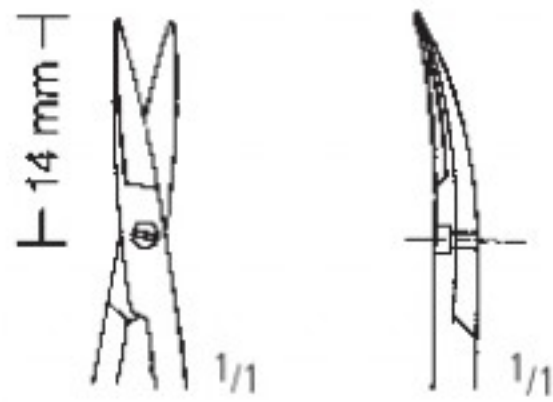

Dissection
AC 821/11

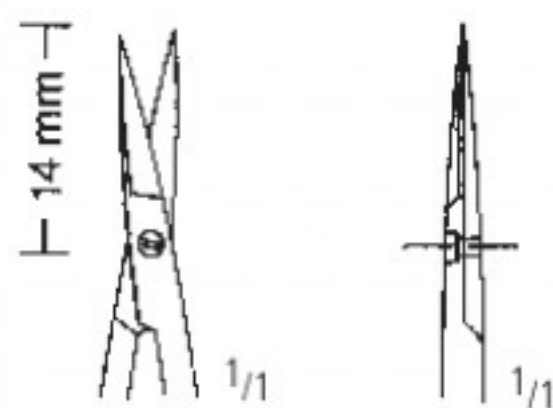

Adventitia
AC 830/11



15,0 cm/6"

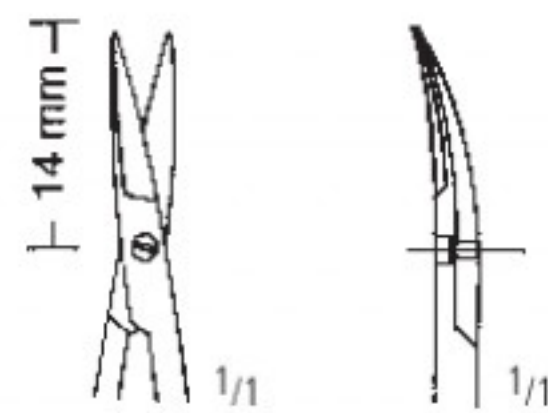

Dissection
AC 823/15

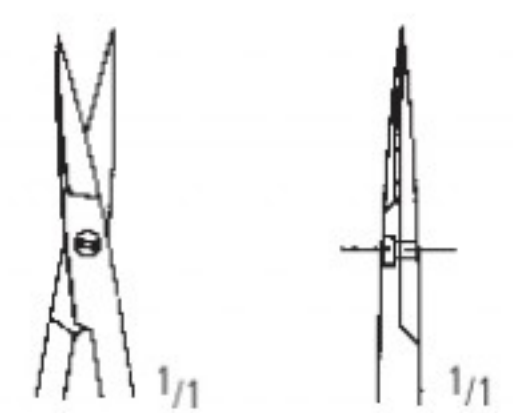

Adventitia
AC 832/15

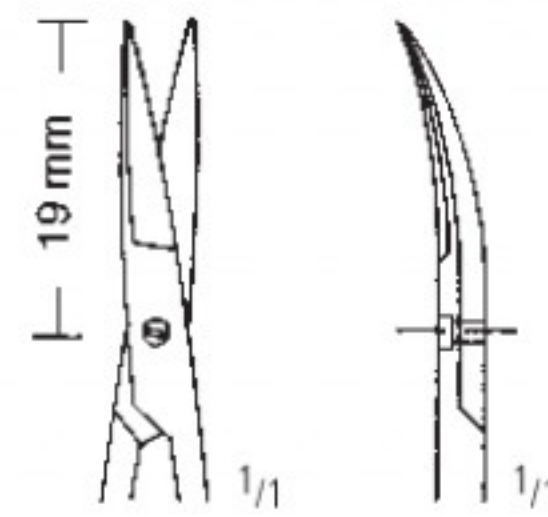

Dissection
AC 825/15

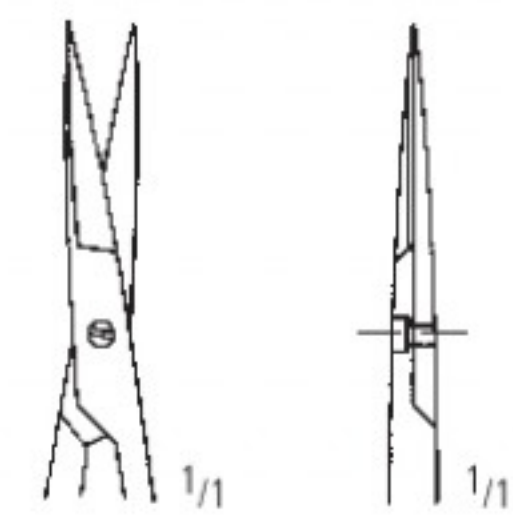

Adventitia
AC 834/15

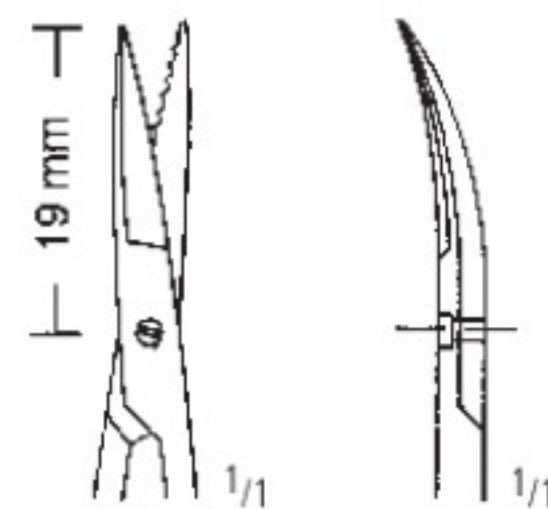

Dissection
AC 827/15

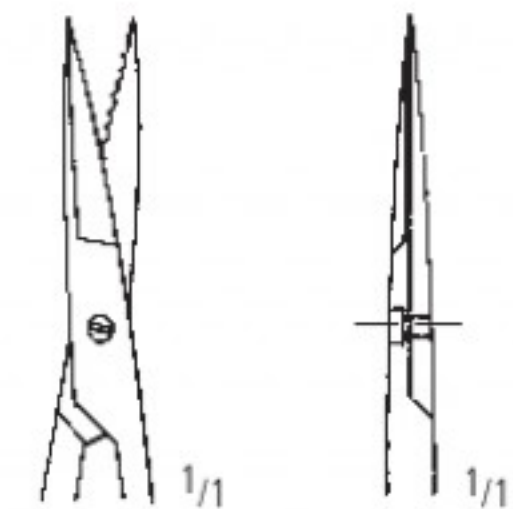

Adventitia
AC 836/15

>> Nerve >>

Adventitia
AC 836/15

AC SCHEREN SCISSORS TIJERAS CISEAUX FORBICI

Mikroscheren
Micro Scissors
Micro Tijeras
Micro Ciseaux
Micro Forbici

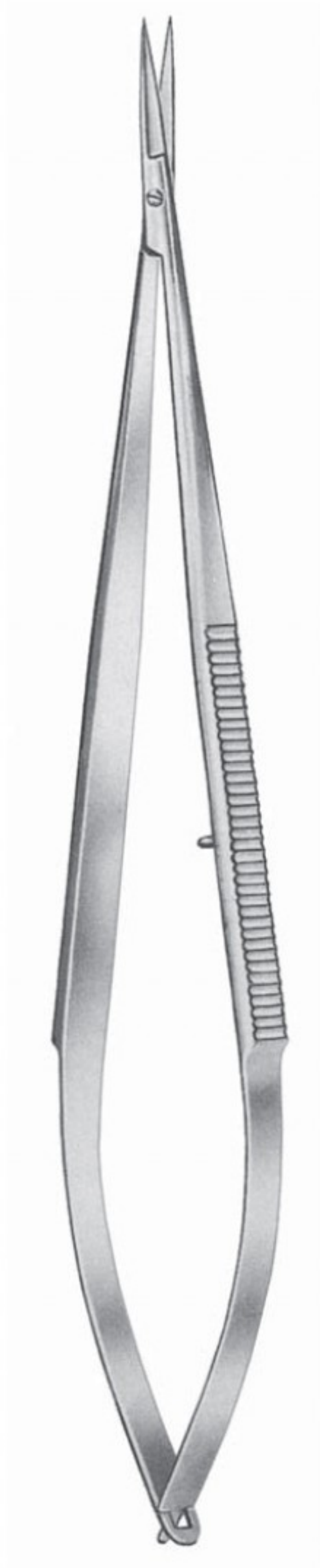

18,5 cm/7¹/₃"

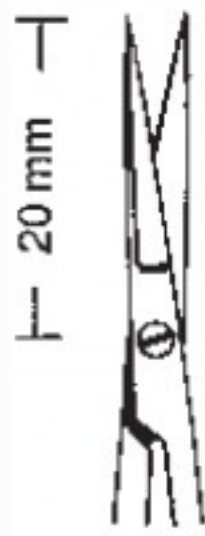

AC 850/19



AC 851/19



16,0 cm/6¹/₄"
20,0 cm/8"
22,5 cm/9"



AC 860/16
AC 860/20
AC 860/22



AC 861/16
AC 861/20
AC 861/22



AC 862/16
AC 862/20
AC 862/22



AC 863/16
AC 863/20
AC 863/22



AC 864/16
AC 864/20
AC 864/22



AC 865/16
AC 865/20
AC 865/22

SCHEREN SCISSORS TIJERAS CISEAUX FORBICI

Mikroscheren
Micro Scissors
Micro Tijeras
Micro Ciseaux
Micro Forbici

AA

AB

AC

AD

AE

AF

AK

AL

AO

KA

KK

X



18,0 cm/7"

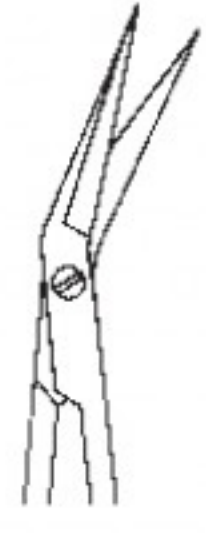

AC 870/01
25°

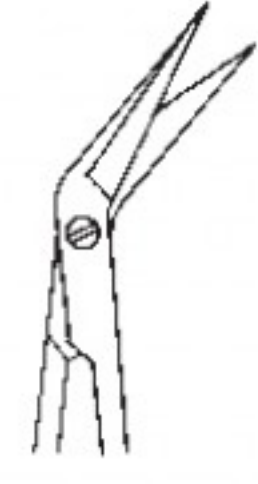

AC 870/02
45°

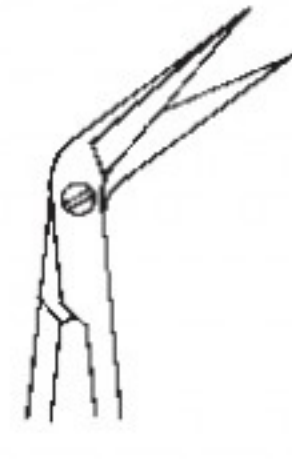

AC 870/03
60°



AC 870/04
90°

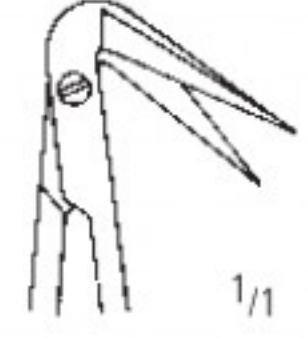

AC 870/05
125°



18,0 cm/7"



AC 871/01
25°



AC 871/02
45°



AC 871/03
60°



AC 871/04
90°

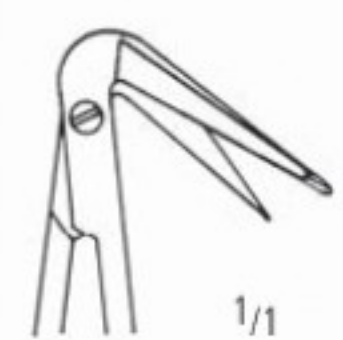

AC 871/05
125°

Mikroscheren
Micro Scissors
Micro Tijeras
Micro Ciseaux
Micro Forbici



18,0 cm/7"



AC 870/11 T
25°

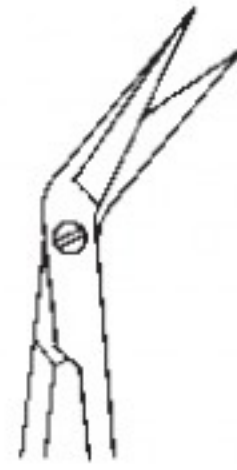

AC 870/12 T
45°

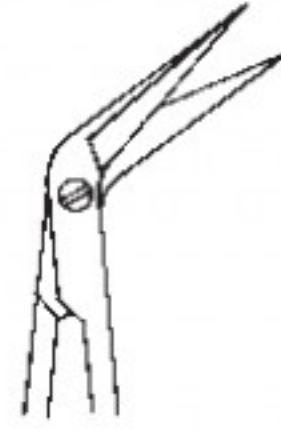

AC 870/13 T
60°

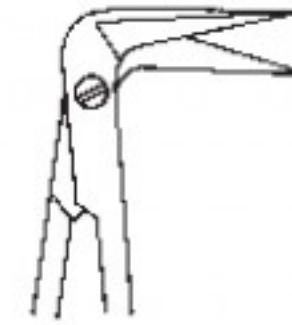

AC 870/14 T
90°

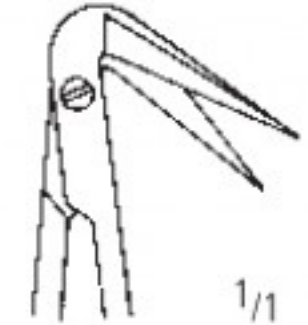

AC 870/15 T
125°

TITANIUM



18,0 cm/7"



AC 871/11 T
25°



AC 871/12 T
45°



AC 871/13 T
60°



AC 871/14 T
90°

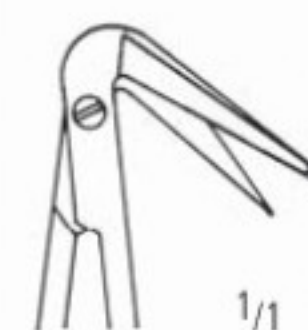

AC 871/15 T
125°

nopa® TUC®

SC Super Cut

SUPER CUT TUC



SUPER CUT TUC

Verfügbare Modelle / Available Patterns

Im Katalog durch * markiert. / Marked in catalog with *.

AC	902/14	SC	STANDARD	SCS TUC STR.	SH/BL	14,5	CM	SC
AC	903/14	SC	STANDARD	SCS TUC CVD.	SH/BL	14,5	CM	SC
AC	910/14	SC	MAYO DISS.	SCS TUC STR.	BL/BL	14,5	CM	SC
AC	910/17	SC	MAYO DISS.	SCS TUC STR.	BL/BL	17,0	CM	SC
AC	911/14	SC	MAYO DISS.	SCS TUC CVD.	BL/BL	14,5	CM	SC
AC	911/17	SC	MAYO DISS.	SCS TUC CVD.	BL/BL	17,0	CM	SC
AC	930/14	SC	METZENBAUM	SCS TUC STR.	BL/BL	14,5	CM	SC
AC	931/14	SC	METZENBAUM	SCS TUC CVD.	BL/BL	14,5	CM	SC
AC	940/18	SC	METZENBAUM	SCS TUC STR.	BL/BL	18,0	CM	SC
AC	940/20	SC	METZENBAUM	SCS TUC STR.	BL/BL	20,0	CM	SC
AC	941/18	SC	METZENBAUM	SCS TUC CVD.	BL/BL	18,0	CM	SC
AC	941/20	SC	METZENBAUM	SCS TUC CVD.	BL/BL	20,0	CM	SC
AC	941/23	SC	METZENBAUM	SCS TUC CVD.	BL/BL	23,0	CM	SC
AC	941/25	SC	METZENBAUM	SCS TUC CVD.	BL/BL	25,0	CM	SC
AC	941/28	SC	METZENBAUM	SCS TUC CVD.	BL/BL	28,0	CM	SC
AC	960/14	SC	METZENBAUM-DEL.	SCS TUC STR.	BL/BL	14,5	CM	SC
AC	961/14	SC	METZENBAUM-DEL.	SCS TUC CVD.	BL/BL	14,5	CM	SC
AC	970/18	SC	METZENBAUM-DEL.	SCS TUC STR.	BL/BL	18,0	CM	SC
AC	970/20	SC	METZENBAUM-DEL.	SCS TUC STR.	BL/BL	20,0	CM	SC
AC	971/18	SC	METZENBAUM-DEL.	SCS TUC CVD.	BL/BL	18,0	CM	SC
AC	971/20	SC	METZENBAUM-DEL.	SCS TUC CVD.	BL/BL	20,0	CM	SC
AC	974/11	SC	STEVENS TENOTOMY	SCS STR.	POINTED	11,5	CM	SC
AC	975/11	SC	STEVENS TENOTOMY	SCS CVD.	POINTED	11,5	CM	SC
AC	984/11	SC	IRIS	SCS TUC STR.	SH/SH	11,5	CM	SC
AC	985/11	SC	IRIS	SCS TUC CVD.	SH/SH	11,5	CM	SC

Besonderheit:

Nutzen Sie die Vorteile von Hartmetalleinsätzen.

nopa TUC Super Cut Scheren haben eine rasierklingscharfe Schneide, kombiniert mit einer mikrogezahnten Schneide.

>> Diese Scheren sind durch schwarz/goldene Ringe gekennzeichnet.

Features:

Use the advantages of Tungsten Carbide.

nopa TUC Super Cut scissors have a razor-like edge combined with one micro serrated blade.

>> Black/golden rings for easy identification.

AC SCHEREN SCISSORS TIJERAS CISEAUX FORBICI

Scheren mit Hartmetalleinlagen
 Scissors with Tungsten Carbide Inserts
 Tijeras con filos de carburo de tungsteno
 Ciseaux avec plaquettes en carbure de tungstène
 Forbici con taglio al carburo di tungsteno

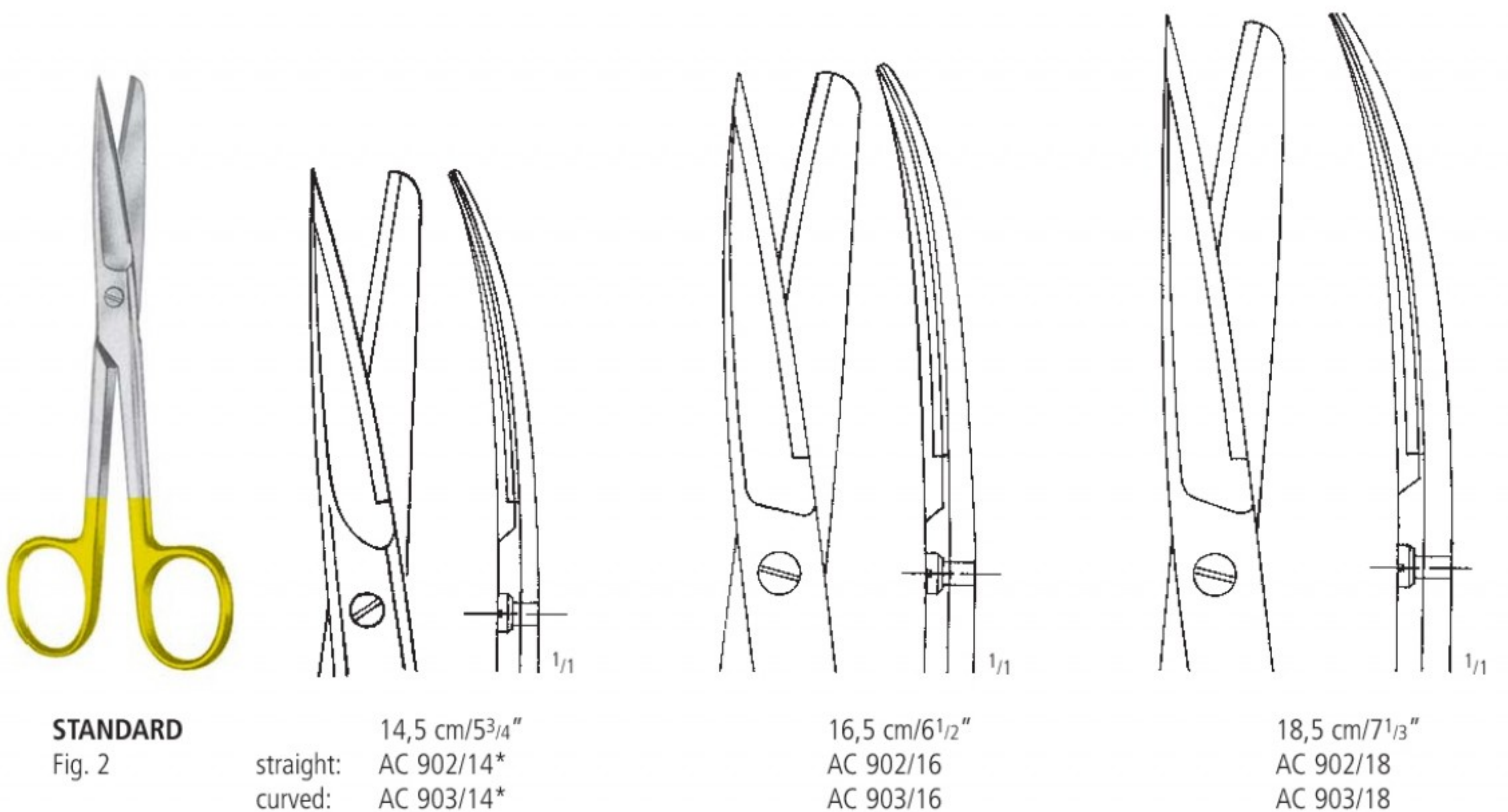
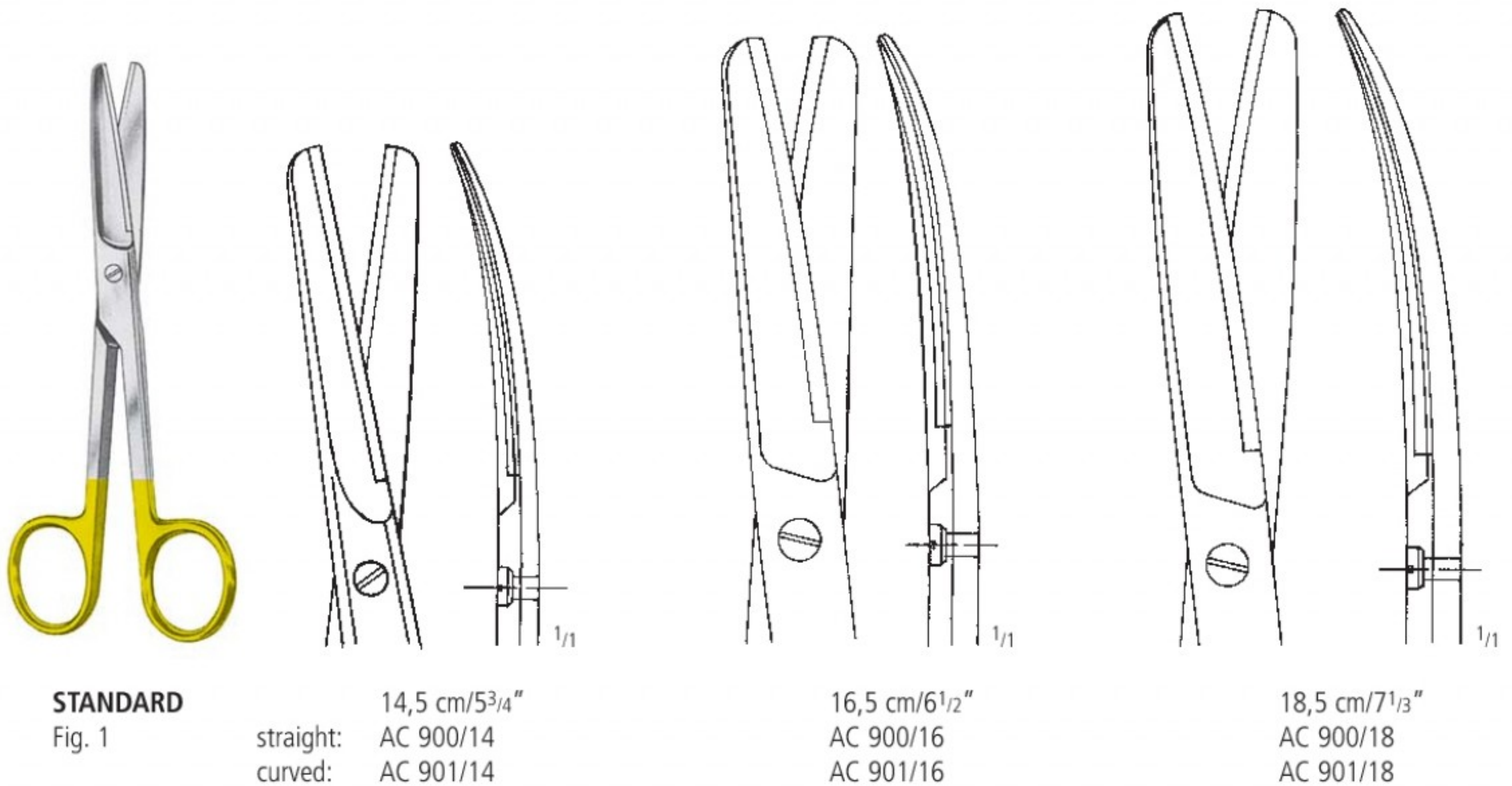

SCHEREN SCISSORS TIJERAS CISEAUX FORBICI

Scheren mit Hartmetalleinlagen
 Scissors with Tungsten Carbide Inserts
 Tijeras con filos de carburo de tungsteno
 Ciseaux avec plaquettes en carbure de tungstène
 Forbici con taglio al carburo di tungsteno

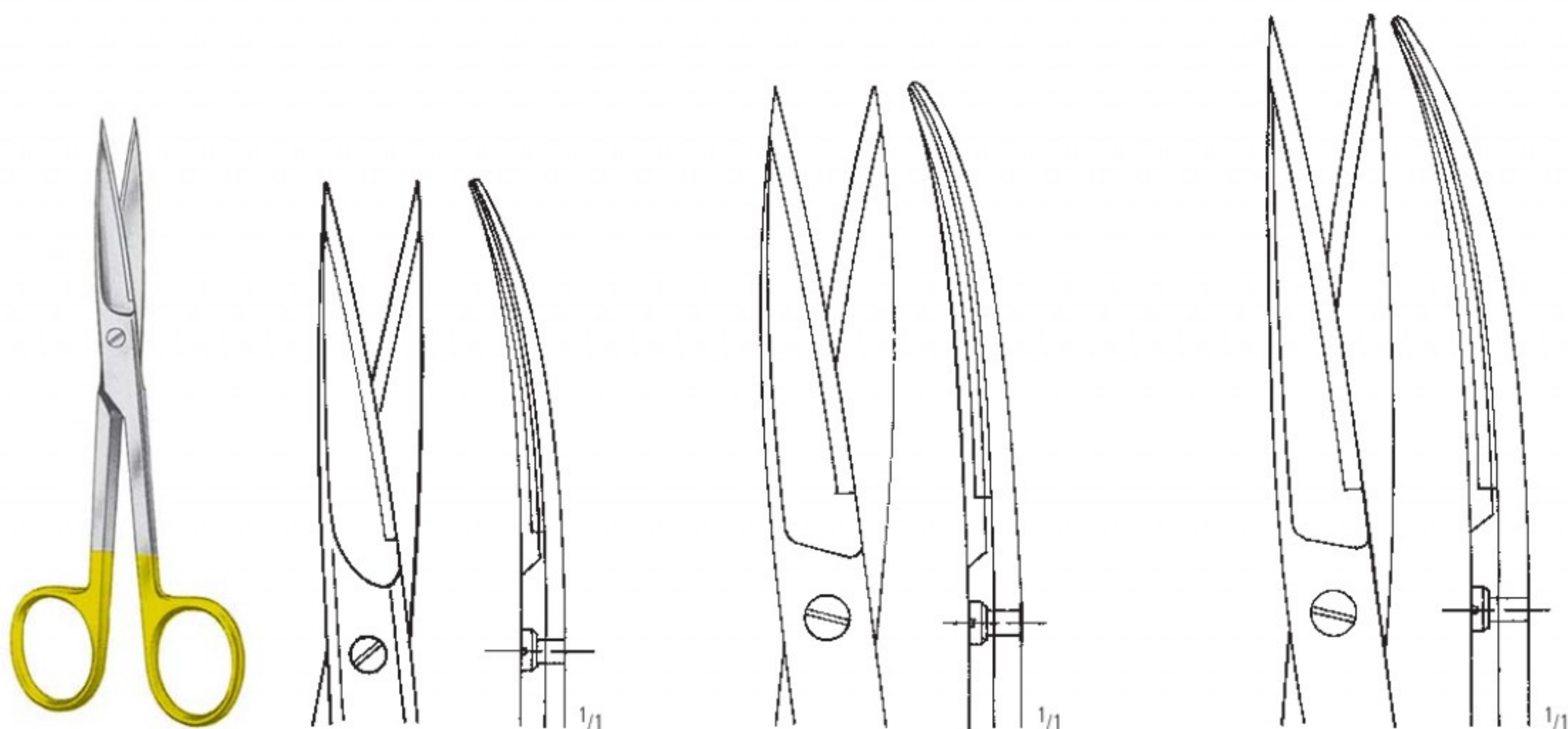

STANDARD
 Fig. 3

14,5 cm/5³/₄"
 straight: AC 904/14
 curved: AC 905/14

16,5 cm/6¹/₂"
 AC 904/16
 AC 905/16

18,5 cm/7¹/₃"
 AC 904/18
 AC 905/18

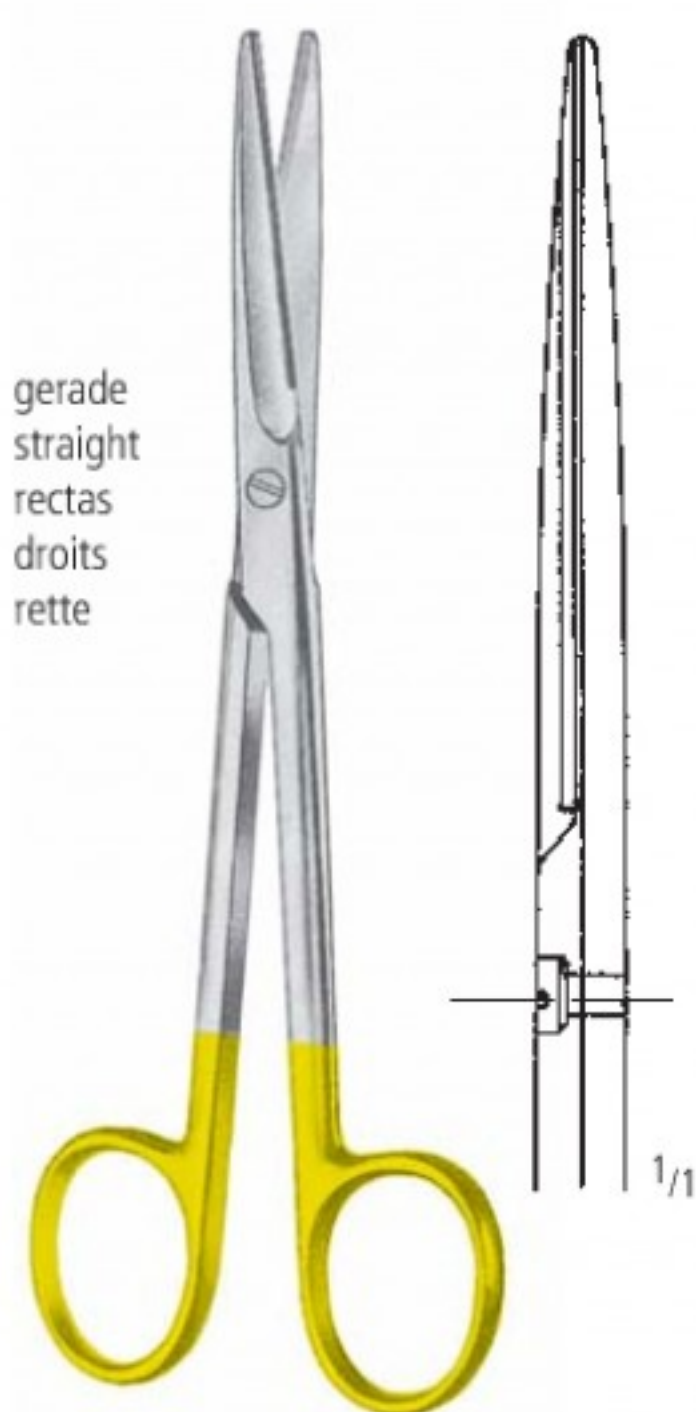

gerade
 straight
 rectas
 droits
 rette

MAYO
 AC 910/14*
 AC 910/17*
 AC 910/23

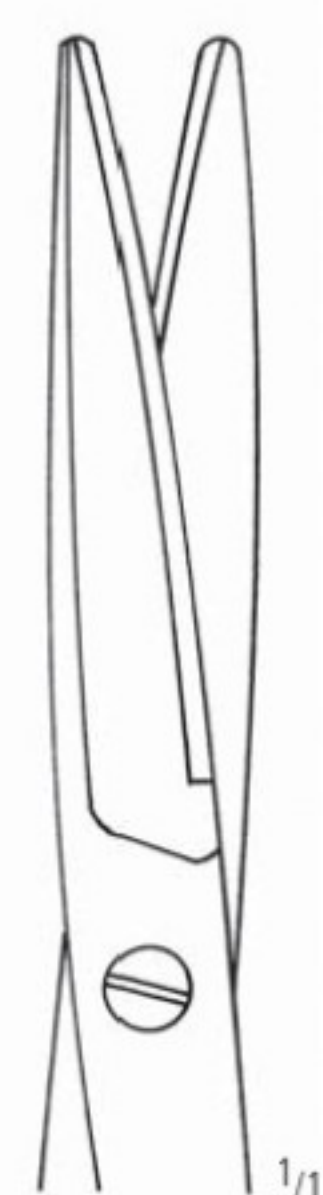

Original 17,0 cm

14,5 cm/5¹/₂"
 17,0 cm/6³/₄"
 23,0 cm/9"



gebogen
 curved
 curvas
 courbes
 curve



MAYO
 AC 911/14*
 AC 911/17*
 AC 911/23

AA
 AB
 AC
 AD
 AE
 AF
 AK
 AL
 AO
 KA
 KK
 X



SCHEREN SCISSORS TIJERAS CISEAUX FORBICI

Scheren mit Hartmetalleinlagen
 Scissors with Tungsten Carbide Inserts
 Tijeras con filos de carburo de tungsteno
 Ciseaux avec plaquettes en carbure de tungstène
 Forbici con taglio al carburo di tungsteno

AA

AB

AC

AD

AE

AF

AK

AL

AO

KA

KK

X

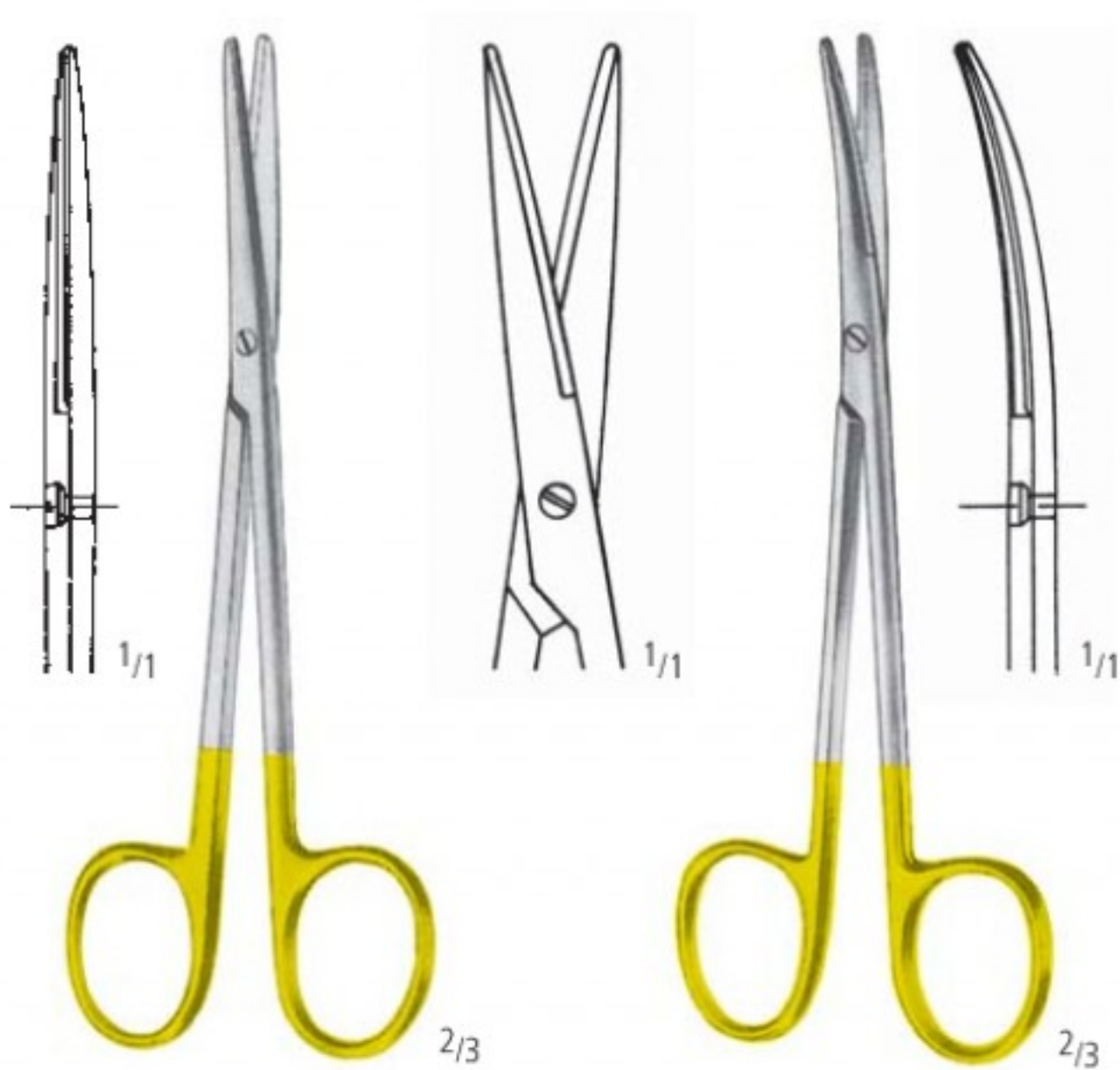

METZENBAUM

AC 922/11
 11,5 cm/4 1/2"

AC 923/11
 11,5 cm/4 1/2"



METZENBAUM

AC 930/14*
 14,5 cm/5 3/4"

AC 931/14*
 14,5 cm/5 3/4"

AC SCHEREN SCISSORS TIJERAS CISEAUX FORBICI

Scheren mit Hartmetalleinlagen
 Scissors with Tungsten Carbide Inserts
 Tijeras con filos de carburo de tungsteno
 Ciseaux avec plaquettes en carbure de tungstène
 Forbici con taglio al carburo di tungsteno

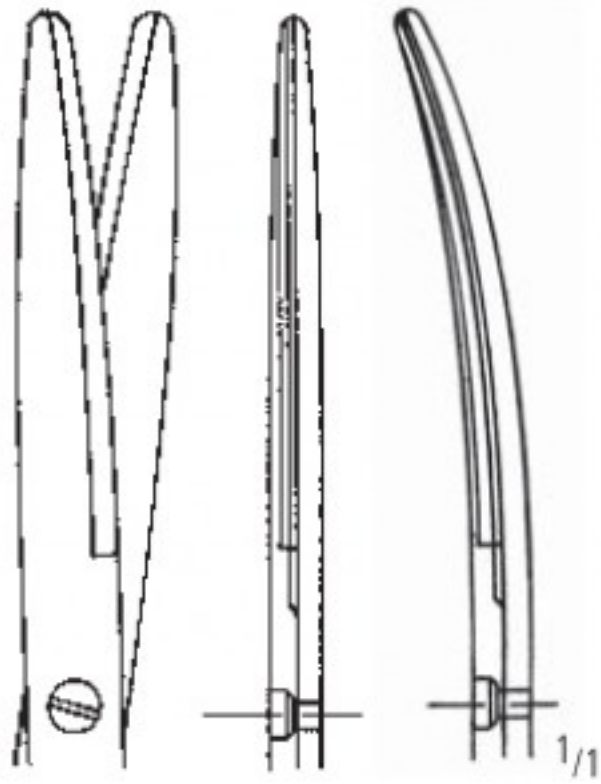

Original 18,0 cm

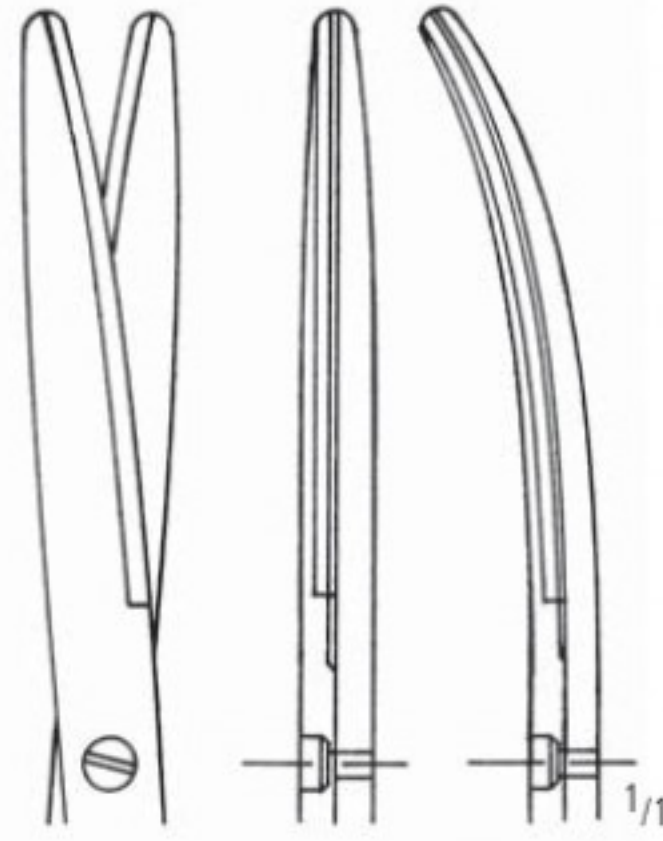

Original 20,0 cm

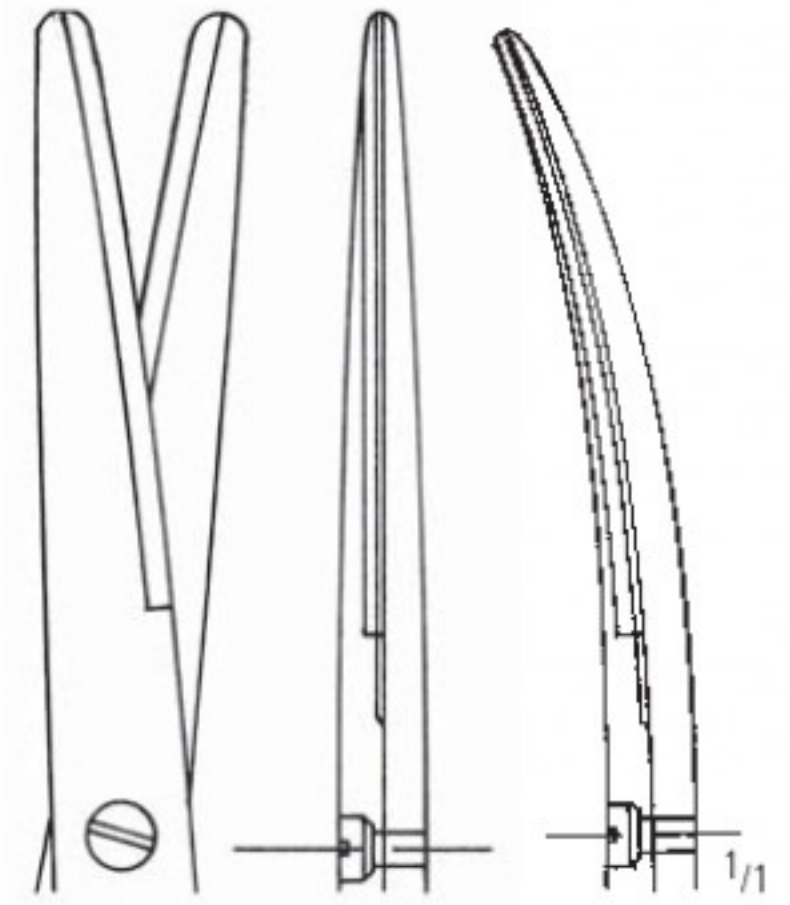

Original 23,0 cm



nopa
TUC[®]

gerade
 straight
 rectas
 droits
 rette

gebogen
 curved
 curvas
 courbes
 curve

AC 940/18*	18,0 cm/7"	AC 941/18*
AC 940/20*	20,0 cm/8"	AC 941/20*
AC 940/23	23,0 cm/9"	AC 941/23*
AC 940/25	25,0 cm/10"	AC 941/25*
AC 940/28	28,0 cm/11"	AC 941/28*
AC 940/30	30,0 cm/12"	AC 941/30

METZENBAUM

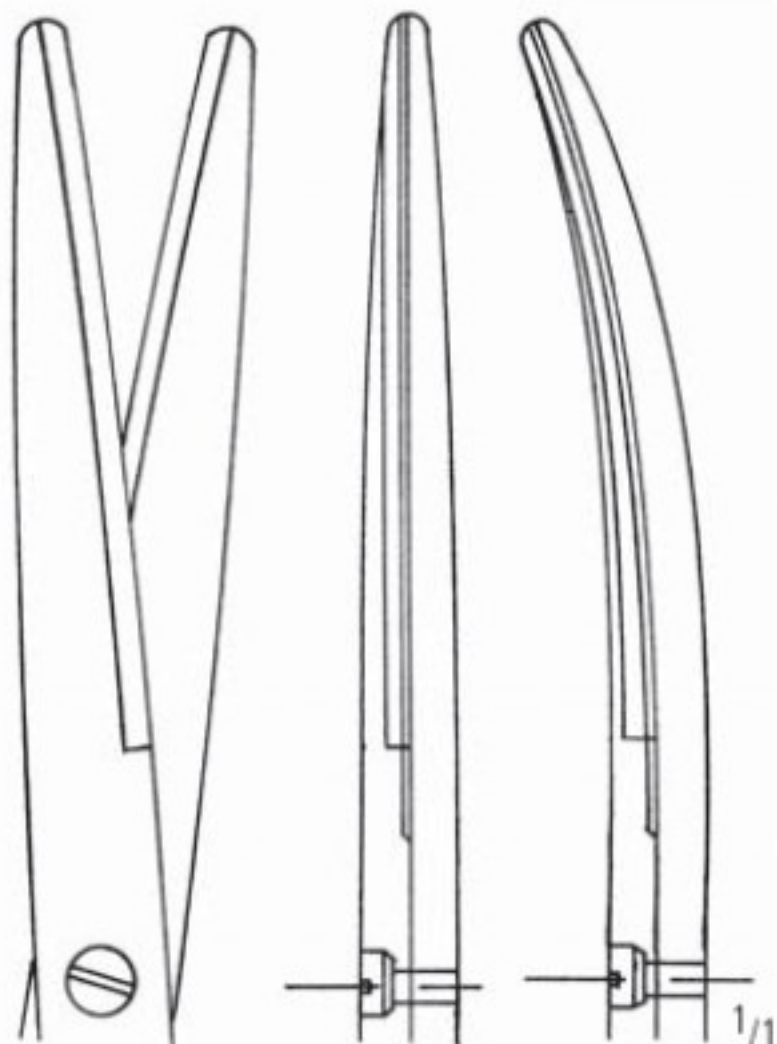

Original 25,0 cm

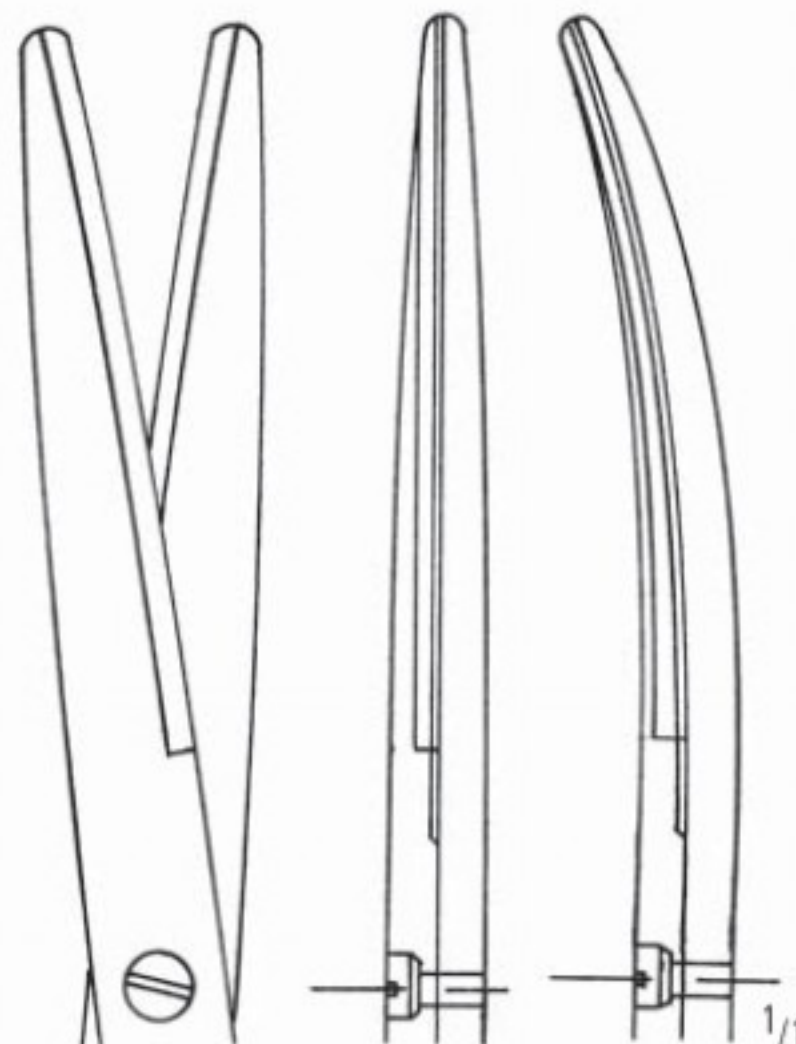

Original 28,0 cm

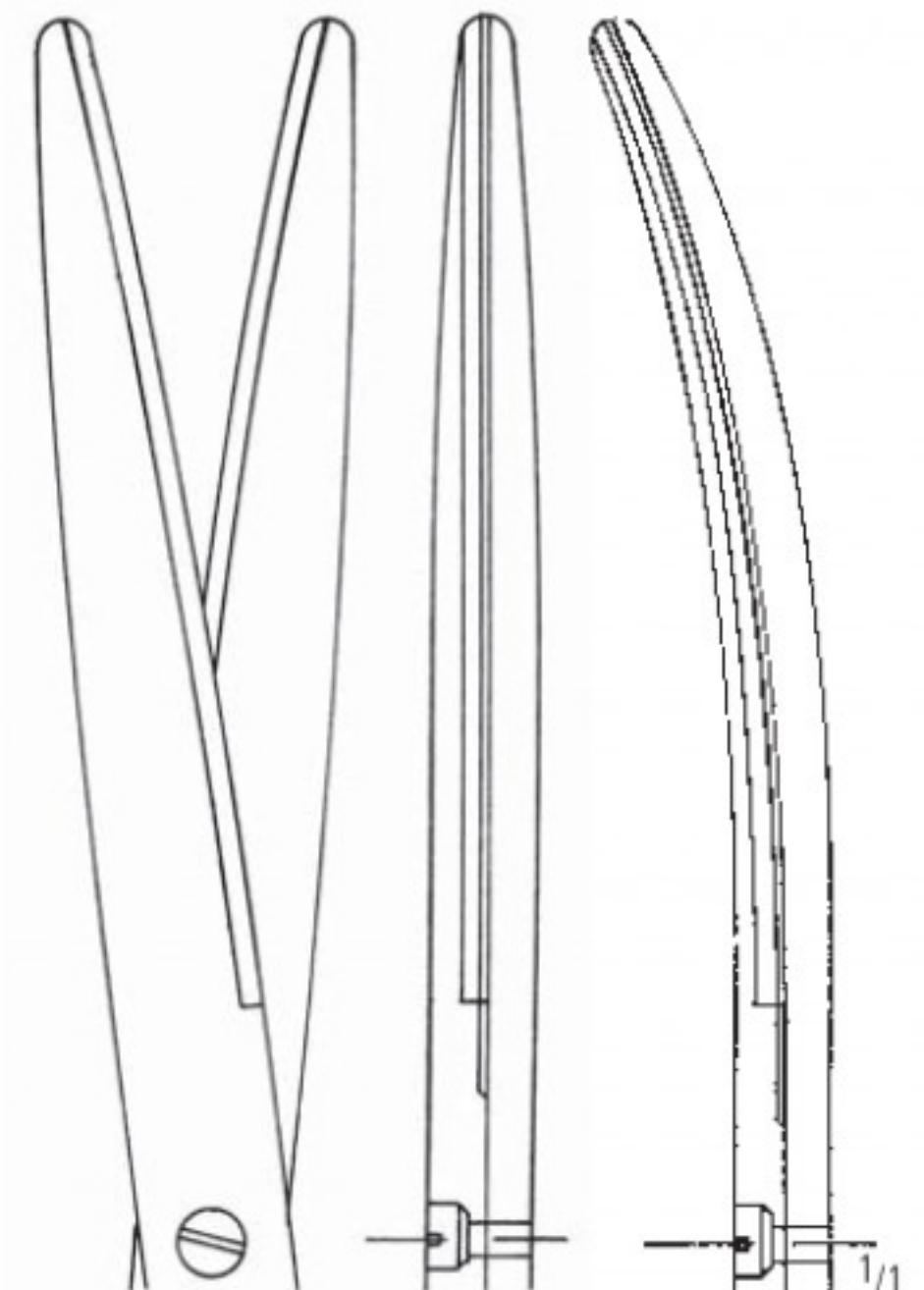

Original 30,0 cm

SCHEREN SCISSORS TIJERAS CISEAUX FORBICI

Scheren mit Hartmetalleinlagen
 Scissors with Tungsten Carbide Inserts
 Tijeras con filos de carburo de tungsteno
 Ciseaux avec plaquettes en carbure de tungstène
 Forbici con taglio al carburo di tungsteno



POTT-SMITH
 19,0 cm/7 1/2"

25°
 AC 948/25

45°
 AC 948/45

60°
 AC 948/60



DE BAKHEY
 18,0 cm/7"

25°
 AC 949/25

45°
 AC 949/45

60°
 AC 949/60

AA
 AB
 AC
 AD
 AE
 AF
 AK
 AL
 AO
 KA
 KK
 X

Scheren mit Hartmetalleinlagen
 Scissors with Tungsten Carbide Inserts
 Tijeras con filos de carburo de tungsteno
 Ciseaux avec plaquettes en carbure de tungstène
 Forbici con taglio al carburo di tungsteno



LEXER
 AC 952/16
 16,0 cm/6¹/₄"

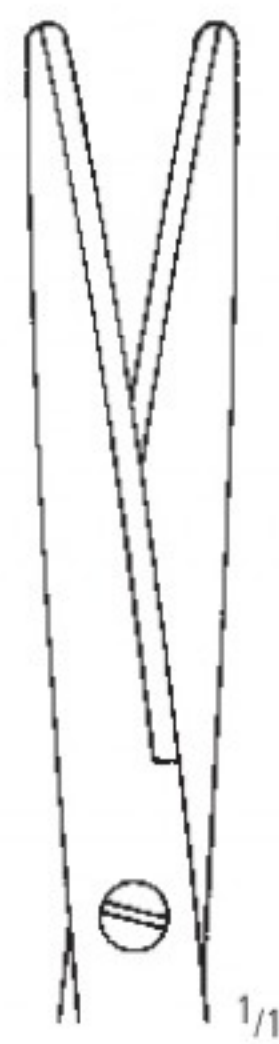

LEXER
 AC 953/16
 16,0 cm/6¹/₄"



AC 960/14*
 14,5 cm/5³/₄"



AC 961/14*
 14,5 cm/5³/₄"

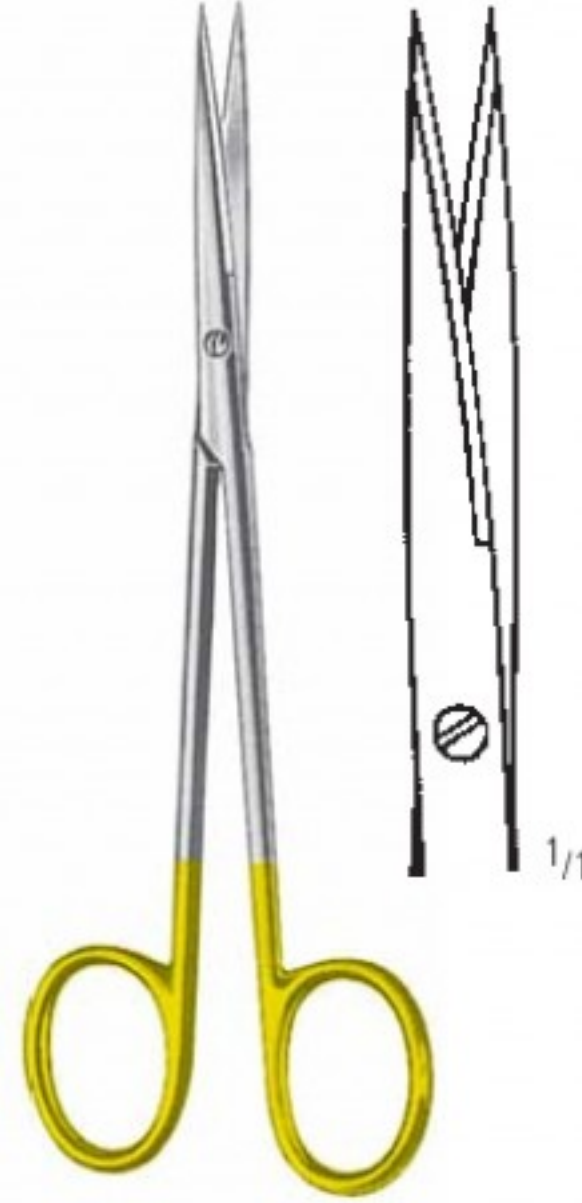

AC 962/14
 14,5 cm/5³/₄"

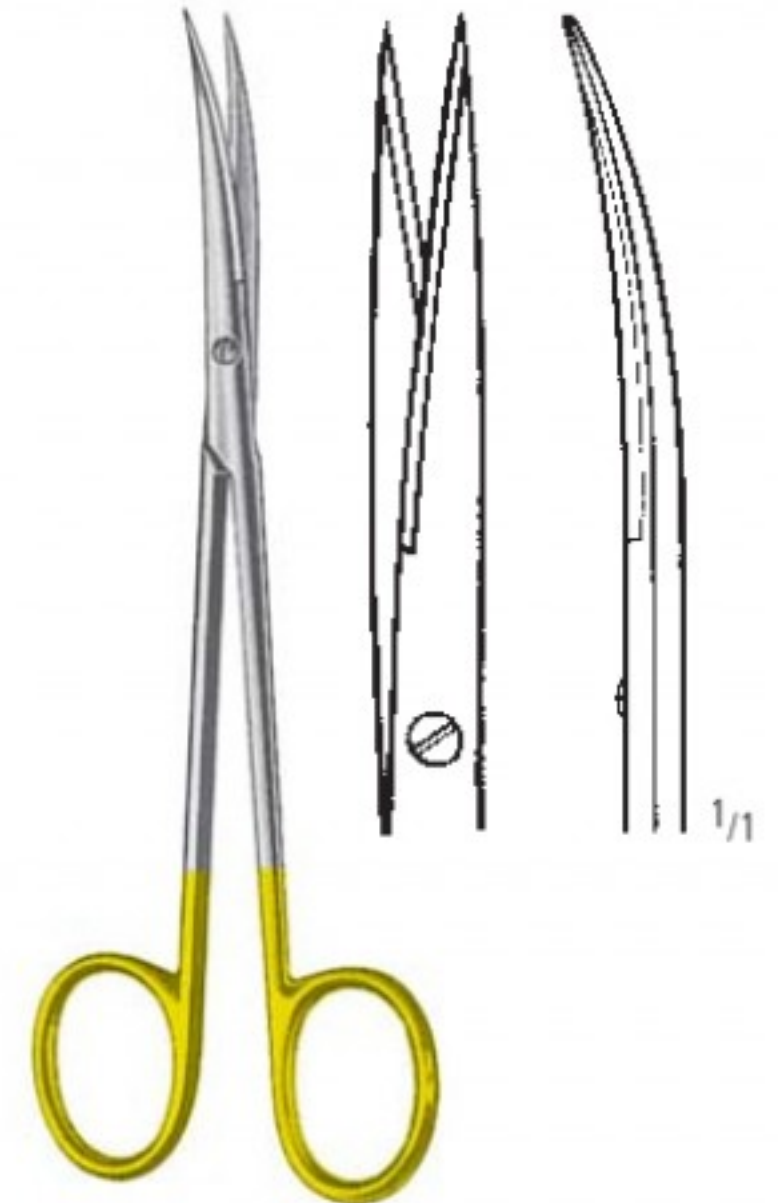

AC 963/14
 14,5 cm /5³/₄"

METZENBAUM-DELICATE

SCHEREN SCISSORS TIJERAS CISEAUX FORBICI

Scheren mit Hartmetalleinlagen
 Scissors with Tungsten Carbide Inserts
 Tijeras con filos de carburo de tungsteno
 Ciseaux avec plaquettes en carbure de tungstène
 Forbici con taglio al carburo di tungsteno

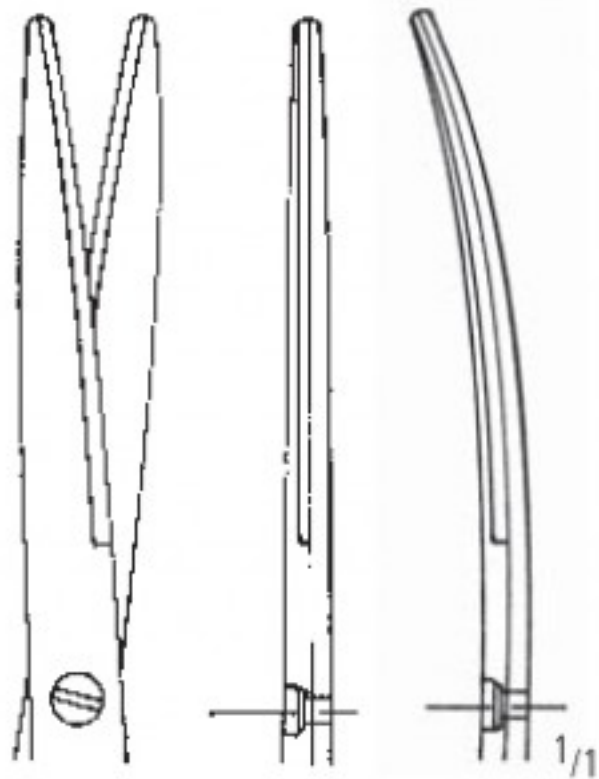

Original 18,0 cm

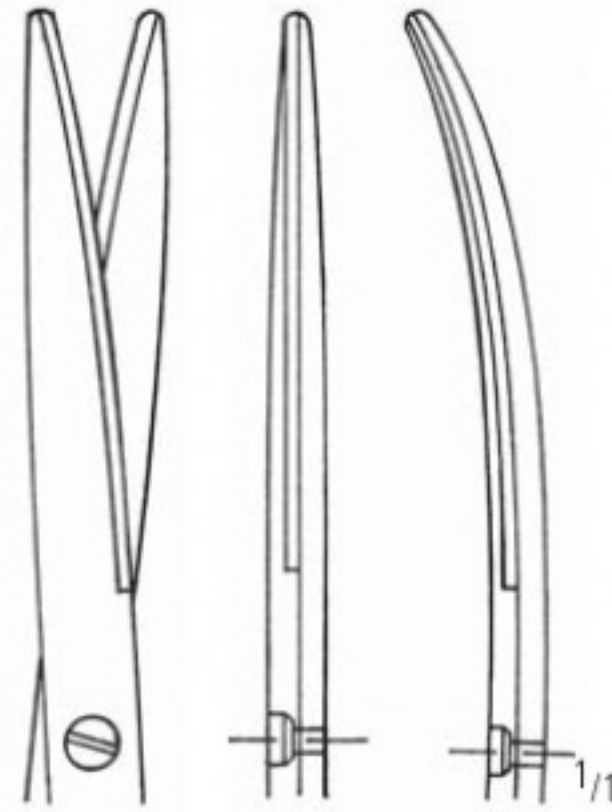

Original 20,0 cm

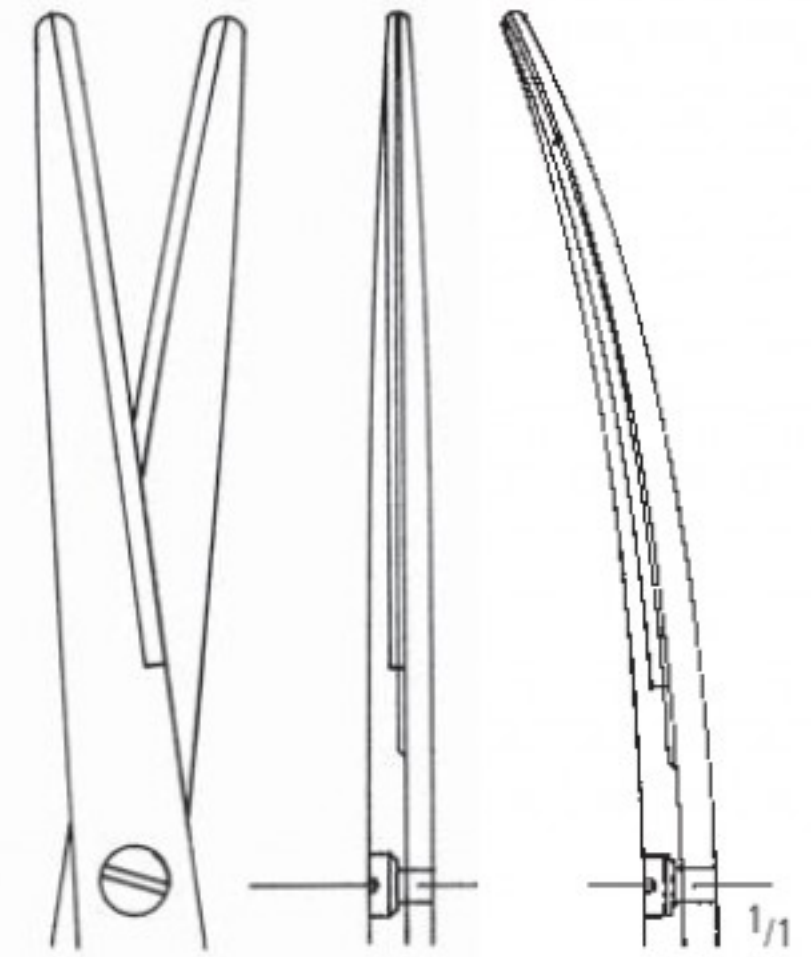

Original 23,0 cm



gerade
 straight
 rectas
 droits
 rette

gebogen
 curved
 curvas
 courbes
 curve

AC 970/18*	18,0 cm/7"	AC 971/18*
AC 970/20*	20,0 cm/8"	AC 971/20*
AC 970/23	23,0 cm/9"	AC 971/23
AC 970/25	25,0 cm/10"	AC 971/25
AC 970/28	28,0 cm/11"	AC 971/28

METZENBAUM-DELICATE

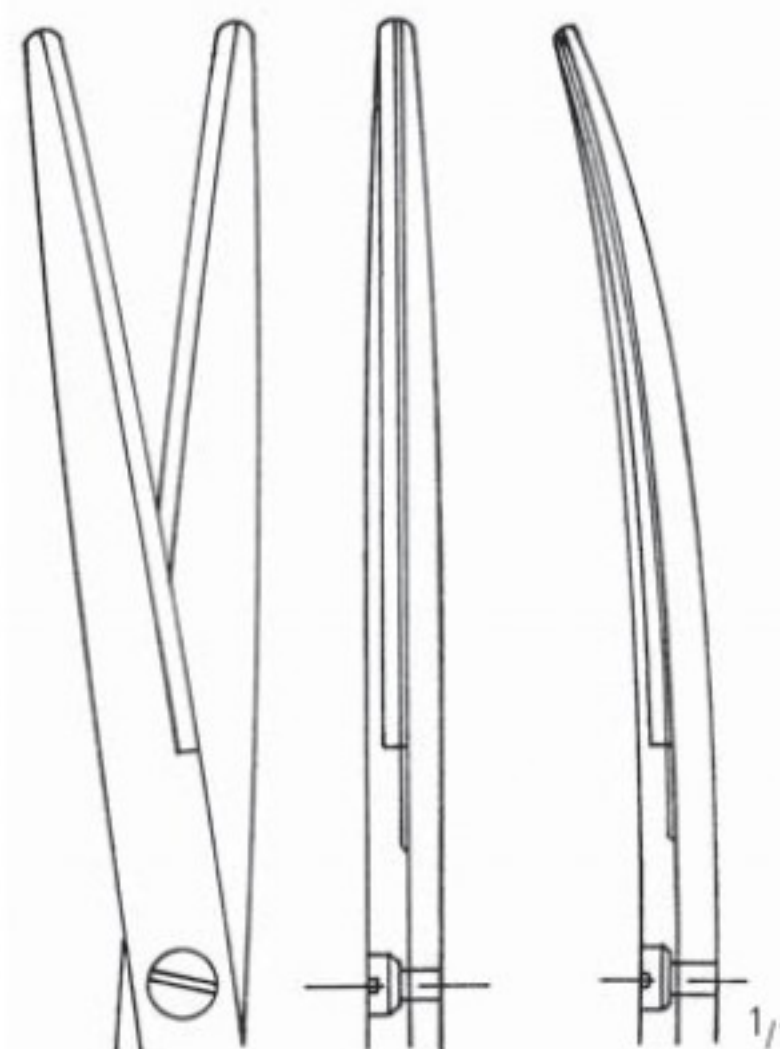

Original 25,0 cm

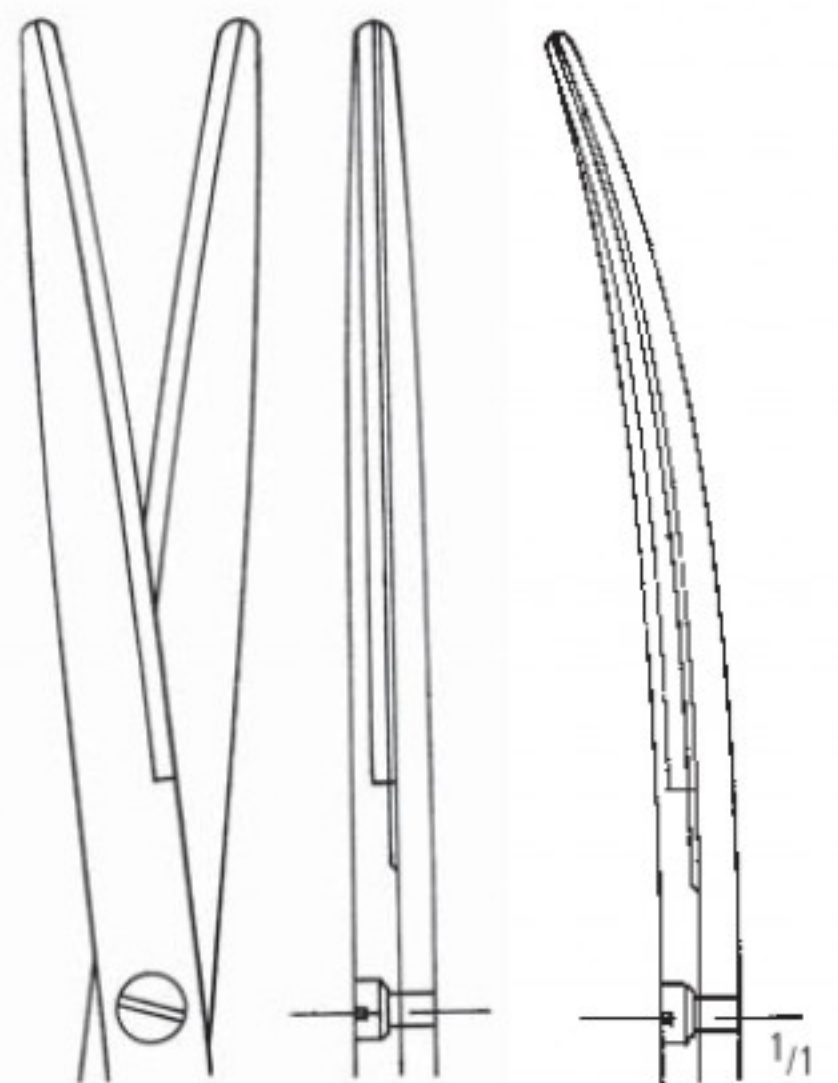

Original 28,0 cm

AA
 AB
 AC
 AD
 AE
 AF
 AG
 AH
 AI
 AJ
 AK
 AL
 AM
 AN
 AO
 AP
 AQ
 AR
 AS
 AT
 AU
 AV
 AW
 AX

AC SCHEREN SCISSORS TIJERAS CISEAUX FORBICI

Scheren mit Hartmetalleinlagen
 Scissors with Tungsten Carbide Inserts
 Tijeras con filos de carburo de tungsteno
 Ciseaux avec plaquettes en carbure de tungstène
 Forbici con taglio al carburo di tungsteno

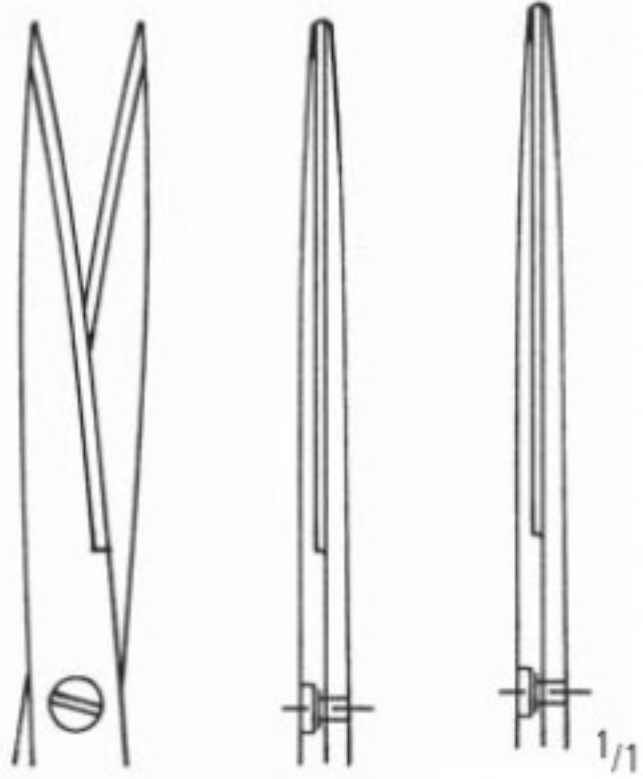

Original 18,0 cm

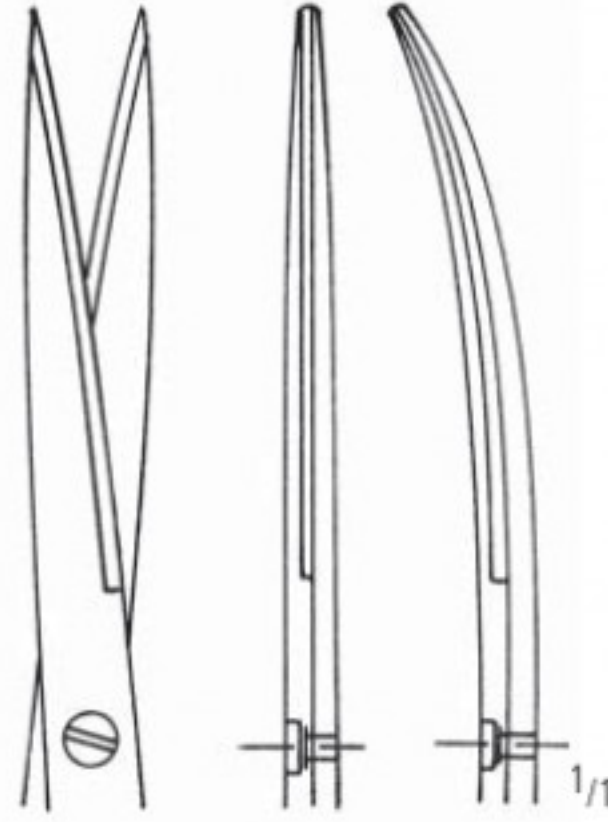

Original 20,0 cm

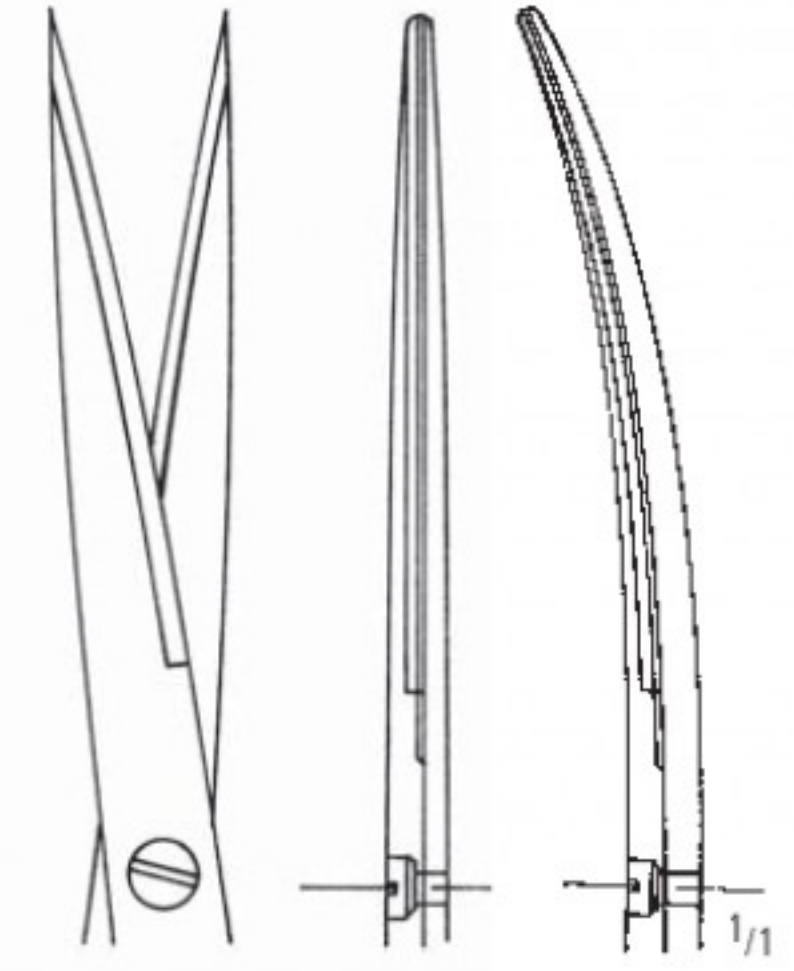

Original 23,0 cm



nopa
TUC[®]

gerade
 straight
 rectas
 droits
 rette

gebogen
 curved
 curvas
 courbes
 curve

AC 972/18	18,0 cm/7"	AC 973/18
AC 972/20	20,0 cm/8"	AC 973/20
AC 972/23	23,0 cm/9"	AC 973/23
AC 972/25	25,0 cm/10"	AC 973/25
AC 972/28	28,0 cm/11"	AC 973/28

METZENBAUM-DELICATE

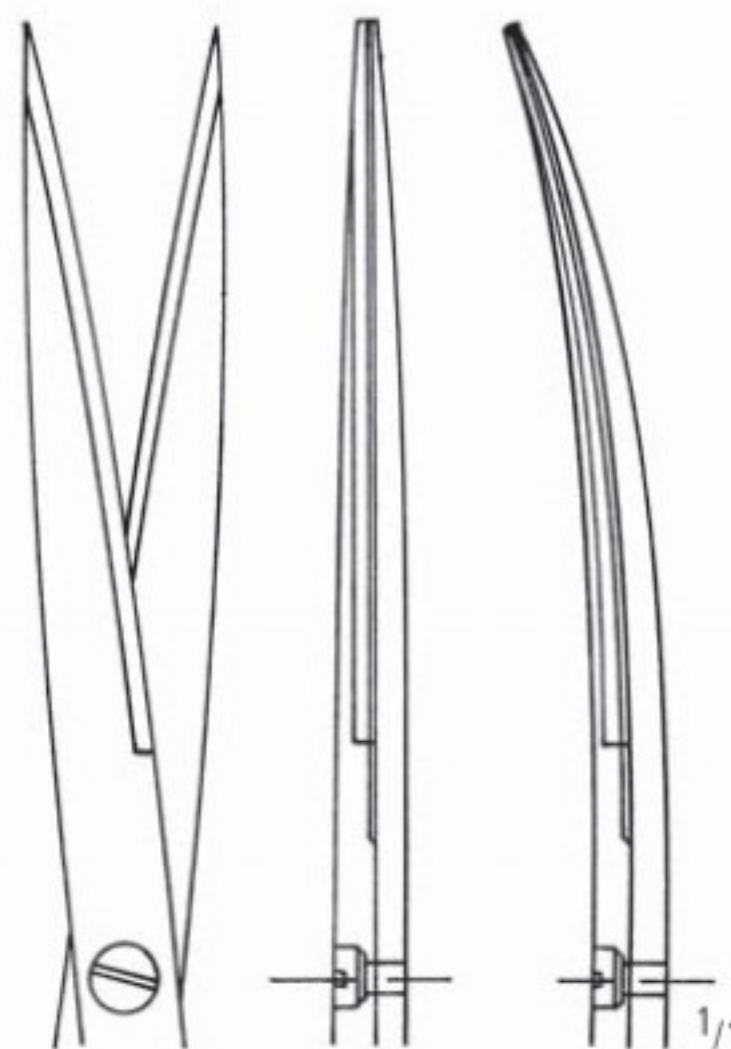

Original 25,0 cm

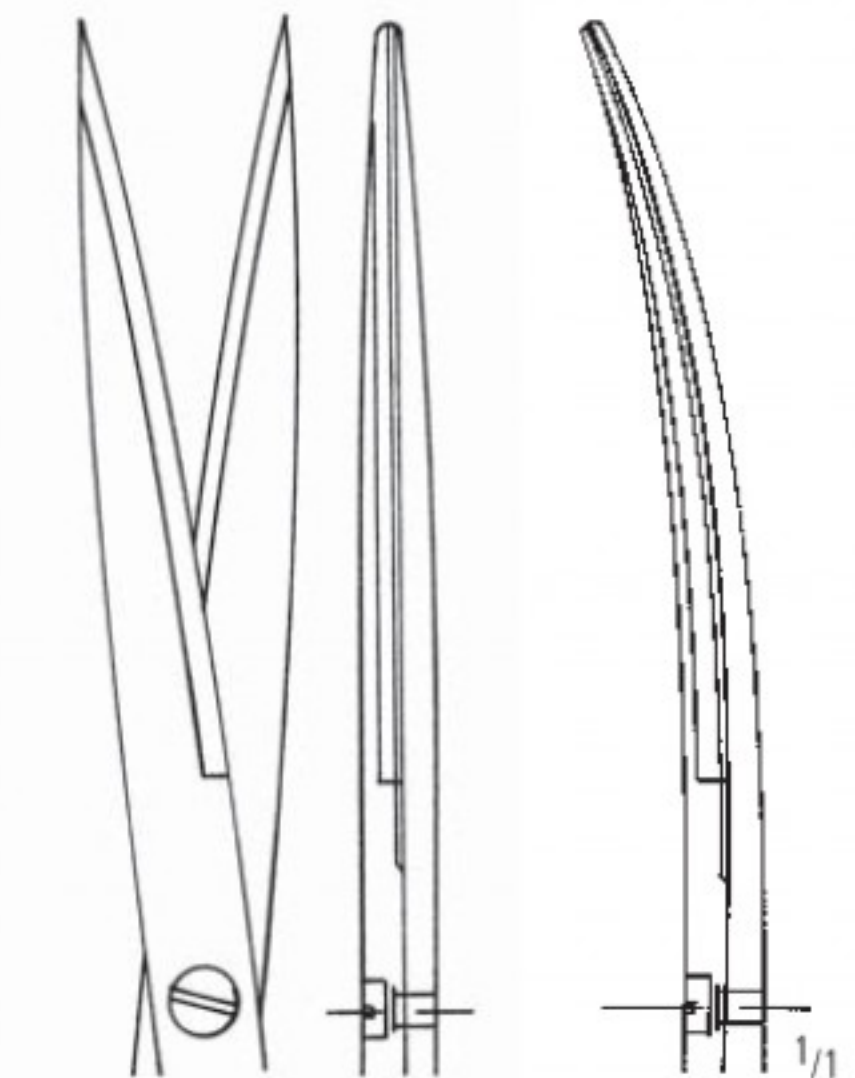

Original 28,0 cm

SCHEREN SCISSORS TIJERAS CISEAUX FORBICI

Scheren mit Hartmetalleinlagen
 Scissors with Tungsten Carbide Inserts
 Tijeras con filos de carburo de tungsteno
 Ciseaux avec plaquettes en carbure de tungstène
 Forbici con taglio al carburo di tungsteno



Original 11,5 cm

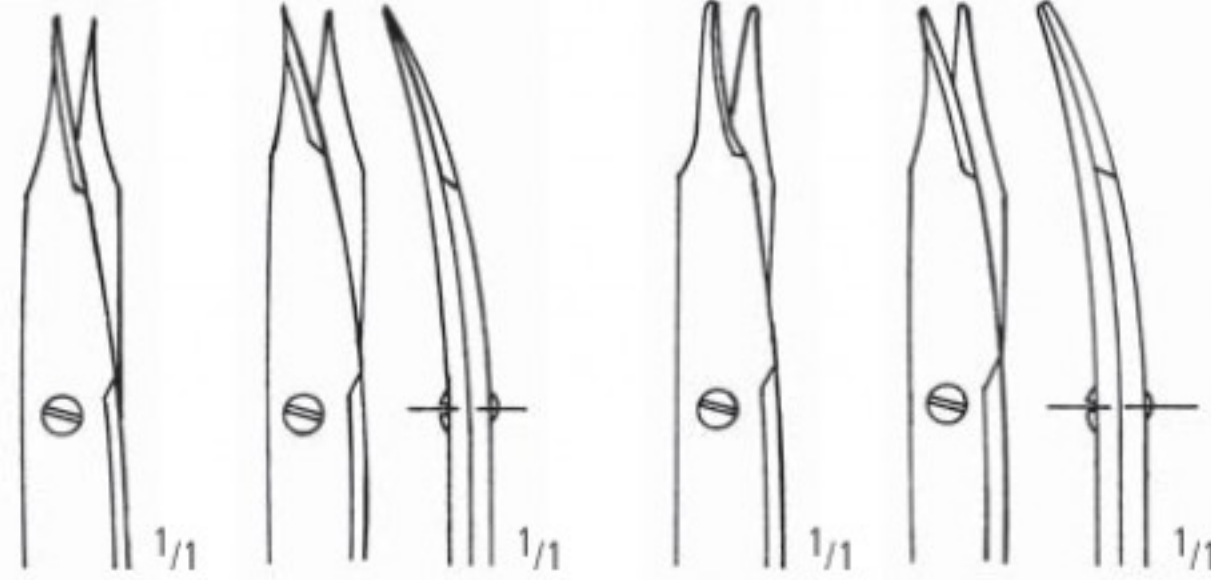

	spitz pointed agudas pointues acuta		stumpf blunt romas mousses smussa
gerade straight rectas droits rette	gebogen curved curvas courbes curve	gerade straight rectas droits rette	gebogen curved curvas courbes curve

STEVENS

10,5 cm/4 ¹ / ₄ "	AC 974/10	AC 975/10	AC 976/10	AC 977/10
11,5 cm/4 ¹ / ₂ "	AC 974/11*	AC 975/11*	AC 976/11	AC 977/11

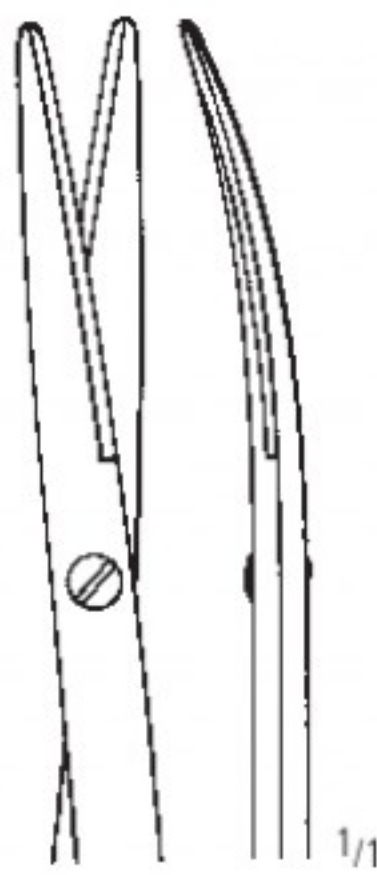

TOENNIS-ADSON-DELICATE

AC 977/17
 17,5 cm/7"

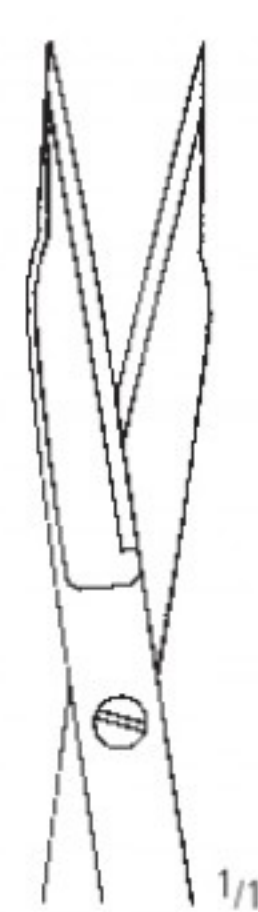

GOLDMAN-FOX

AC 980/13
 13,0 cm/5"



AC 981/13
 13,0 cm/5"

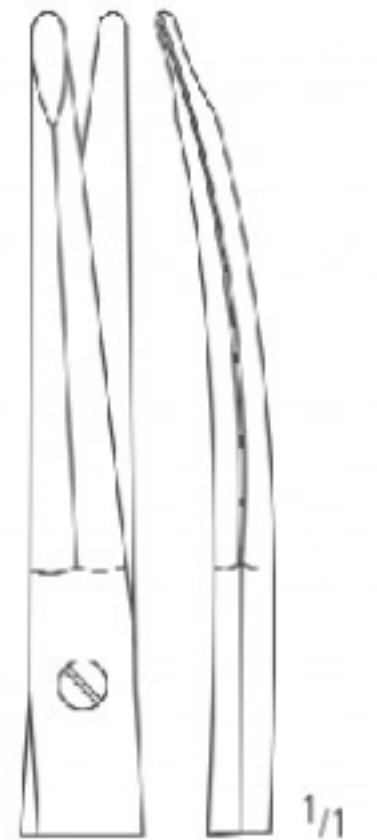
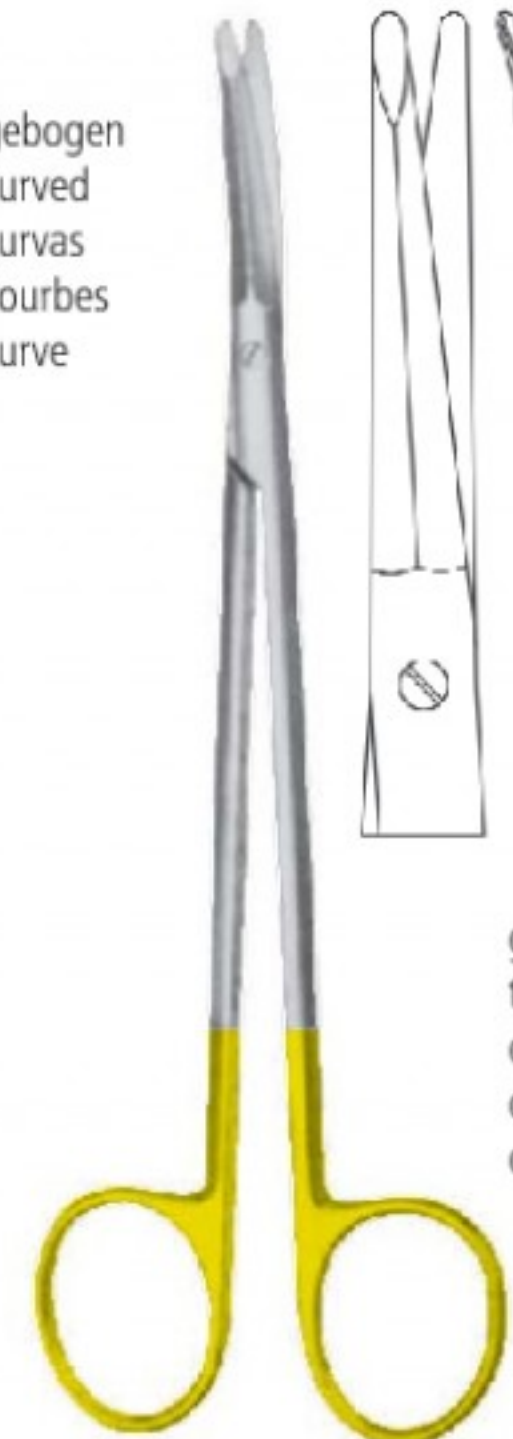

KAYE

AC 983/15
 15,0 cm/6"

gezahnt
 toothed
 dentada
 dentelés
 dentata

* Auch erhältlich als SC * Also available as SC

AA
 AB
 AC
 AD
 AE
 AF
 AG
 AH
 AI
 AJ
 AK
 AL
 AM
 AN
 AO
 AP
 AQ
 AR
 AS
 AT
 AU
 AV
 AW
 AX
 AY
 AZ

Scheren mit Hartmetalleinlagen
 Scissors with Tungsten Carbide Inserts
 Tijeras con filos de carburo de tungsteno
 Ciseaux avec plaquettes en carbure de tungstène
 Forbici con taglio al carburo di tungsteno



AC 984/11*
 11,5 cm/4¹/₂"



AC 985/11*
 11,5 cm/4¹/₂"



UNIVERSAL
 AC 987/12
 12,0 cm/4³/₄"



LISTER
 AC 999/18
 18,0 cm/7"

SKALPELLE
SCALPELS
BISTURIES
BISTOURIS
BISTURI

AD

nopa[®] instruments

Weitere Skalpelle finden Sie in unserem Katalog "Allgemeine Chirurgie" in Gruppe AD.

For further scalpels kindly refer to our catalogue "General Surgery", section AD.

Para bisturías adicionales, por favor consulte nuestro catálogo de "Cirugía general", grupo AD.

Pour des bistouris supplémentaires, consultez notre catalogue "Chirurgie Generale", section AD.

Per gli altri bisturi, consultare il nostro catalogo "Chirurgia Generale", gruppo AD.



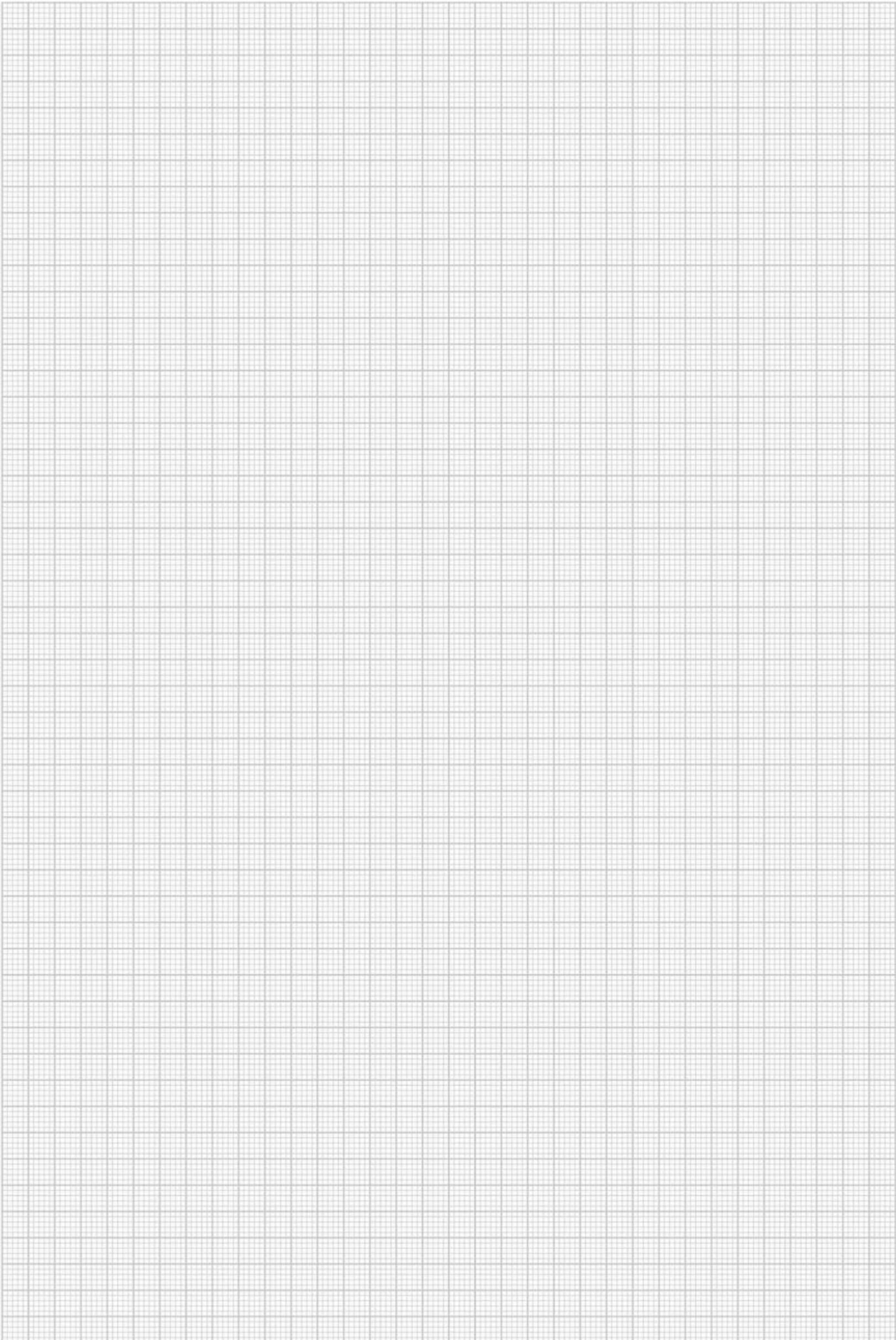

SKALPELLE SCALPELS BISTURIES BISTOURIS BISTURI

Skalpgriffe
 Scalpel Handles
 Mangos de bisturías
 Manches pour bistouris
 Manici per bisturi

AA

AB

AC

AD

AE

AF

AK

AL

AO

KA

KK

X

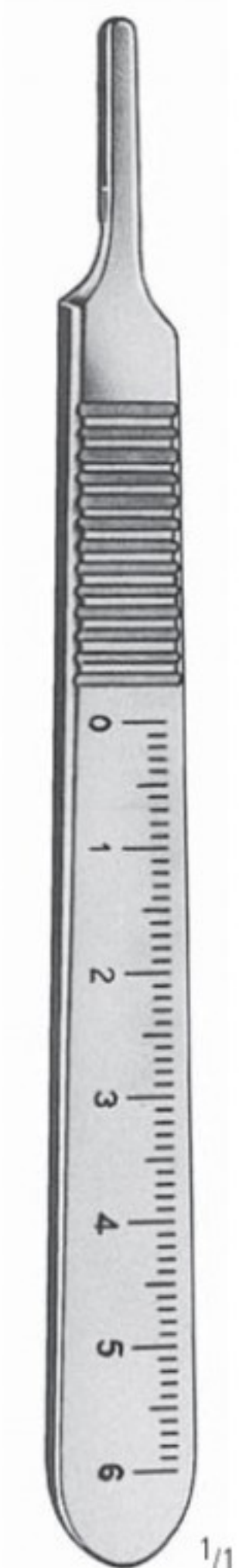

AD 009/03
No. 3



AD 010/03
No. 3

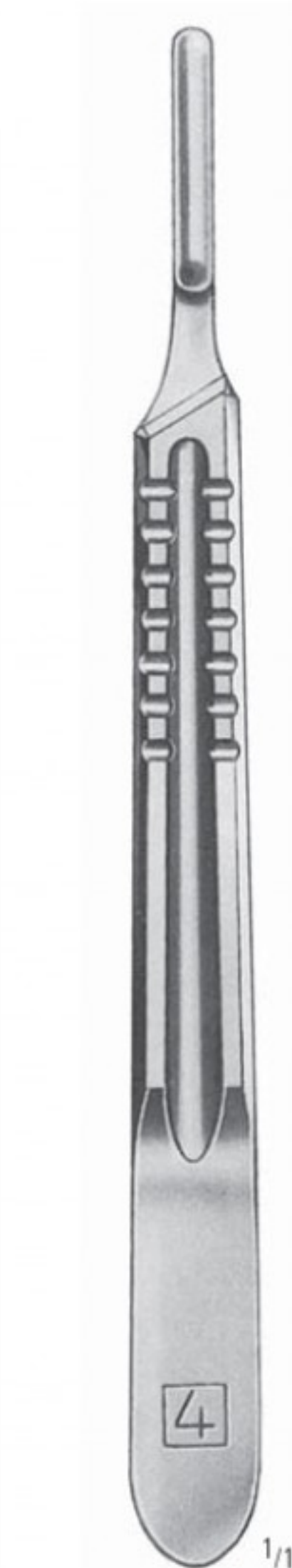

AD 010/04
No. 4



AD 010/05
No. 5K

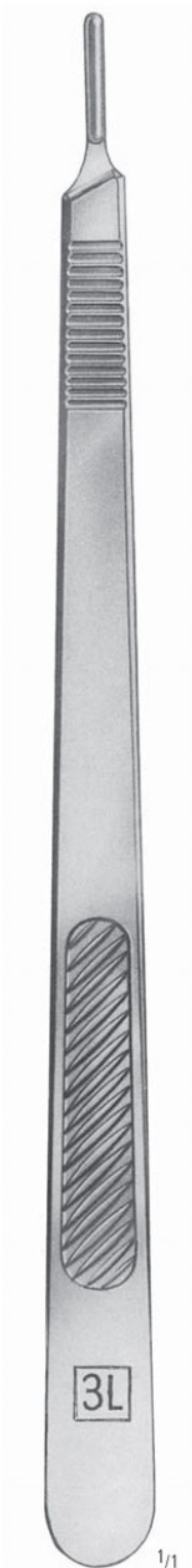

AD 020/13
No. 3L

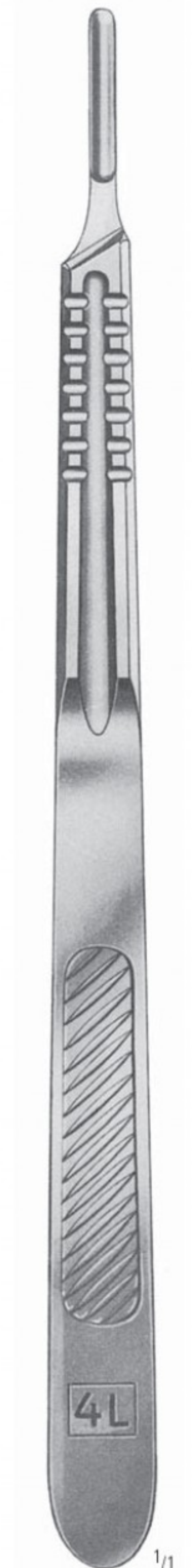

AD 020/14
No. 4L



AD 020/15
No. 5L

AD SKALPELLE SCALPELS BISTURIES BISTOURIS BISTURI

Skalpellgriffe
 Scalpel Handles
 Mangos de bisturías
 Manches pour bistouris
 Manici per bisturi



1/1

AD 025/07
 No. 7



1/1

AD 027/07
 No. 7K



1/1

AD 030/16



1/1

AD 031/21



1/1

COLLIN
 AD 040/08
 No. 8

hohl
 hollow
 hueco
 creux
 vuoto



1/1

COLLIN
 AD 042/09
 No. 9

SKALPELLE SCALPELS BISTURIES BISTOURIS BISTURI

Skalpellgriffe, Skalpellklingen
 Scalpel Handles, Scalpel Blades
 Mangos de bisturías, Hojas de busturías
 Manches pour bistouris, Lames de bistouris
 Manici per bisturi, Lame per bisturi

AA

AB

AC

AD

AE

AF

AK

AL

AO

KA

KK

X

MINI

Verpackungseinheit / packing unit = 10 St./pc.



Fig. 61
AD 065/61



Fig. 62
AD 065/62



Fig. 62S
AD 065/63



Fig. 64
AD 065/64



Fig. 65
AD 065/65



Fig. 67
AD 065/67



Fig. 69
AD 065/69

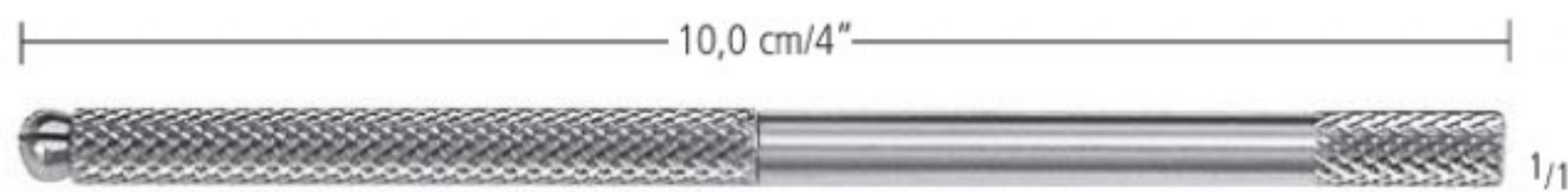

AD 065/10

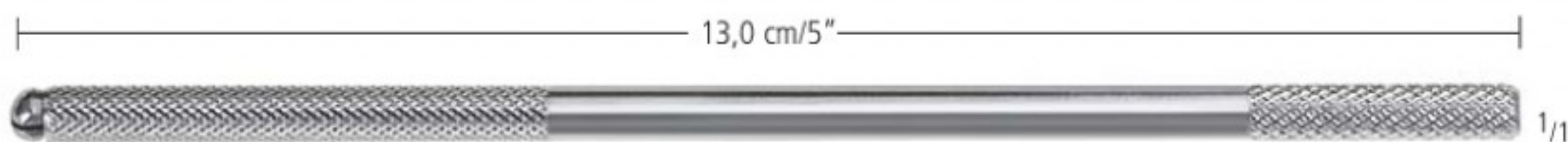

AD 065/13

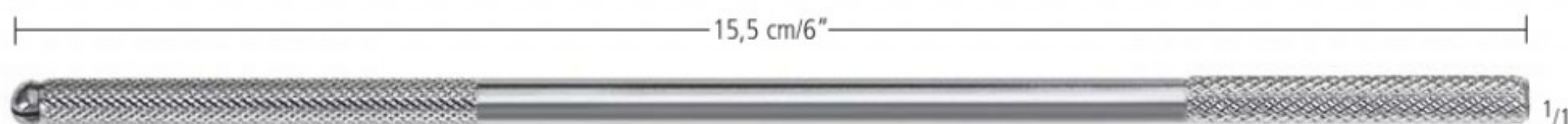

AD 065/15

AD SKALPELLE SCALPELS BISTURIES BISTOURIS BISTURI

Skalpellklingen
Scalpel Blades
Hojas de bisturías
Lames pour bistouris
Lame per bisturi

passend für die Griffe
for handles
para los mangos
pour les manches
per i manici

- AD 009/03
- AD 010/03
- AD 020/13
- AD 025/07
- AD 027/07
- AD 030/16
- AD 040/08



Fig.10
AD 075/10



Fig.11
AD 075/11



Fig.12d
AD 076/12



Fig.15
AD 075/15



Fig.15c
AD 076/15



steril
sterile
estériles
stériles
sterili

passend für die Griffe
for handles
para los mangos
pour les manches
per i manici

- AD 010/04
- AD 020/14
- AD 042/09



Fig.20
AD 075/20



Fig.21
AD 075/21



Fig.22
AD 075/22



Fig.23
AD 075/23



Fig.24
AD 075/24

NAHT
SUTURE
SUTURA
SUTURE
SUTURA

AE

nopa[®] instruments

Weitere Naht-Instrumente finden Sie in unserem Katalog "Allgemeine Chirurgie" in Gruppe AE.

For further suture instruments kindly refer to our catalogue "General Surgery", section AE.

Para instrumentos de sutura adicionales, por favor consulte nuestro catálogo de "Cirugía general", grupo AE.

Pour des instruments de suture supplémentaires, consultez notre catalogue "Chirurgie Generale", section AE.

Per gli altri accessori di sutura, consultare il nostro catalogo "Chirurgia Generale", gruppo AE.



AE NAHT SUTURE SUTURA SUTURE SUTURA

Hartmetalleinsatzplättchen mit Pyramidenprofil
 Tungsten Carbide Tips with pyramidal profile
 Bocas de carburo de tungsteno con perfil de estructura piramidal
 Plaquettes en carbure de tungstène avec profil pyramidal
 Placche di carburo di tungsteno con profilo in forma piramidale

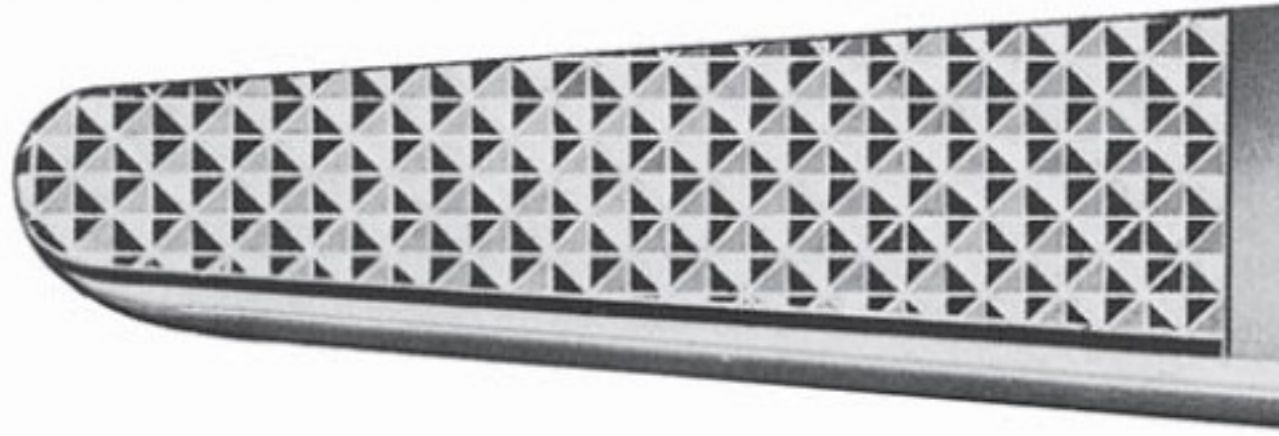

Teilung:	0,5 mm	Für Nahtmaterial 3/0 und größer
Serration:	0,5 mm	For suture sizes 3/0 and larger
Graduación:	0,5 mm	Para sutura 3/0 y más grande
Graduation:	0,5 mm	Pour suture 3/0 et plus grand
Graduazione:	0,5 mm	Per sutura 3/0 e più grande

"STANDARD"

(Mayo-Hegar, Mathieu, Bozeman, New Orleans, Stratte, etc.)

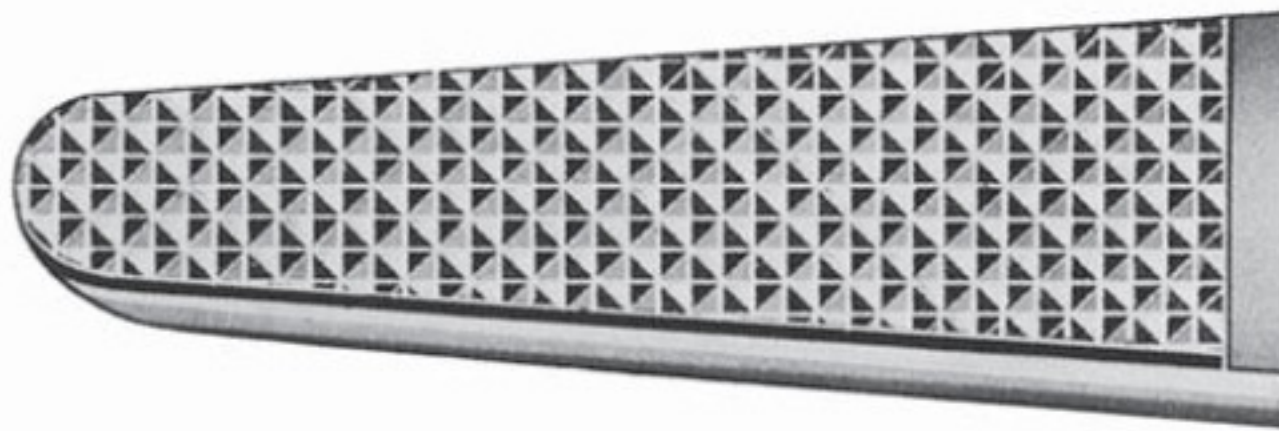

Teilung:	0,4 mm	Für Nahtmaterial zwischen 3/0 und 6/0
Serration:	0,4 mm	For suture sizes between 3/0 and 6/0
Graduación:	0,4 mm	Para suturas entre 3/0 y 6/0
Graduation:	0,4 mm	Pour sutures entre 3/0 et 6/0
Graduazione:	0,4 mm	Per sutura tra 3/0 e 6/0

"FINE"

(Crile-Wood, Halsey, DeBakey, Ryder, etc.)

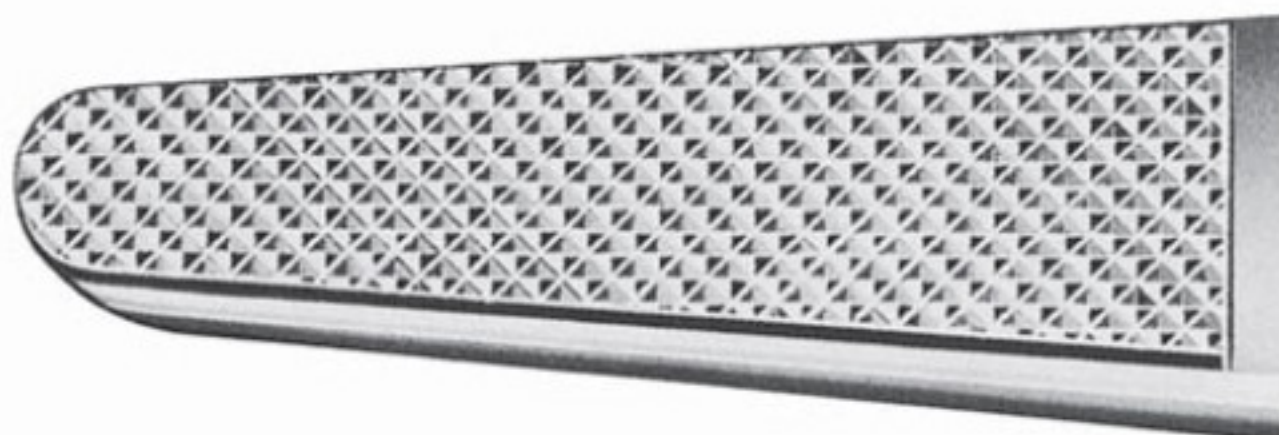

Teilung:	0,2 mm	Für Nahtmaterial zwischen 7/0 und 10/0
Serration:	0,2 mm	For suture sizes between 7/0 and 10/0
Graduación:	0,2 mm	Para suturas entre 7/0 y 10/0
Graduation:	0,2 mm	Pour sutures entre 7/0 et 10/0
Graduazione:	0,2 mm	Per sutura tra 7/0 e 10/0

"MICRO"

(Micro Ryder, Microvascular, Castroviejo, etc.)

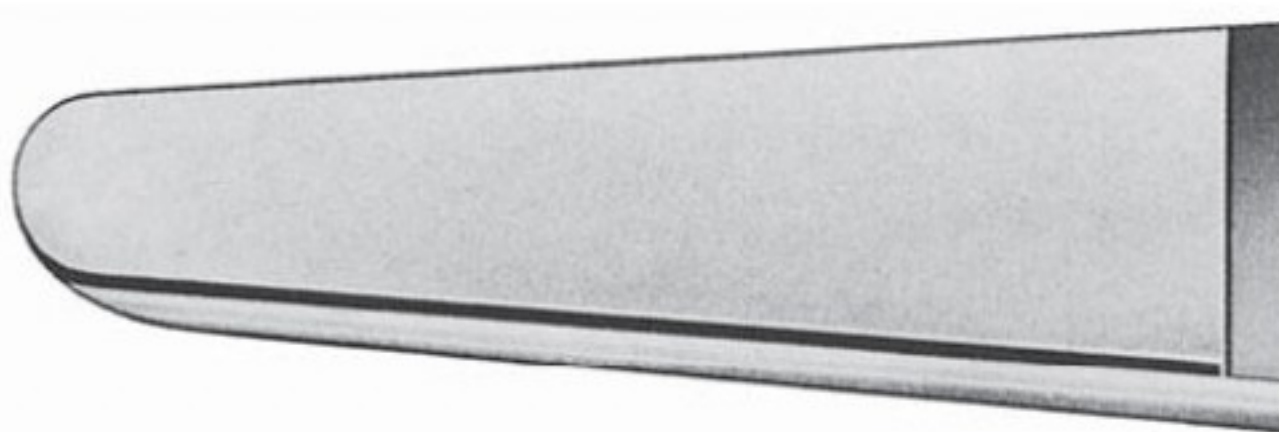

glatt	Für extrem feines Nahtmaterial
smooth	For the smallest suture sizes available
lisa	Para suturas extremamente finas
lisses	Pour matériel de suture extrêmement fin
liscio	Per materiale di sutura finissima

"SMOOTH"

(Eufrate Pasqué, Castroviejo, Jacobson, etc.)

NAHT SUTURE SUTURA SUTURE SUTURA

nopa-Service, Ersatzteile und Aufarbeitung aller Fabrikate
 nopa-Service, Spare Inserts and Refurbishing of all brands
 Servicio-nopa, piezas de recambio y renovar de todas las marcas
 Service-nopa, pièces de rechange et remise à neuf de toutes les marques
 Servizio-nopa, pezzi di ricambio e riparazione di tutte le marche

TUC-Einsätze
TUC-Inserts
TUC-Bocas
TUC-Plaquettes
TUC-Placche

AE 380/15	Smooth, 15 mm
AE 380/17	Smooth, 17 mm
AE 380/19	Smooth, 19 mm
AE 382/15	Micro, 0.2, 15 mm
AE 382/17	Micro, 0.2, 17 mm
AE 382/19	Micro, 0.2, 19 mm
AE 384/15	Fine, 0.4, 15 mm
AE 384/17	Fine, 0.4, 17 mm
AE 384/19	Fine, 0.4, 19 mm
AE 385/15	Standard, 0.5, 15 mm
AE 385/17	Standard, 0.5, 17 mm
AE 385/19	Standard, 0.5, 19 mm

Reparaturservice
Repair-Service
Servicio de reparación
Service de réparation
Servizio di riparazione

AE 390/00
 neue Plättchen einsetzen, aufarbeiten, Ringe vergolden
 replacement of inserts, refurbishing, gold handles refinished
 soldar bocas nuevas, reparar, dorar los anillos
 brasage des nouvelles plaquettes, remise à neuf, redorer les anneaux
 saldare placche nuove, rinnovare, dorare gli anelli

AE 390/01
 neue Plättchen einsetzen, aufarbeiten
 replacement of inserts, refurbishing
 soldar bocas nuevas, reparar
 brasage des nouvelles plaquettes, remise à neuf
 saldare placche nuove, rinnovare

AE 390/02
 neue Plättchen einsetzen
 replacement of inserts
 soldar bocas nuevas
 brasage des nouvelles plaquettes
 saldare placche nuove

AE 390/03
 aufarbeiten
 refurbishing
 reparar
 remise à neuf
 rinnovare

AE 390/04
 Ringe vergolden
 gold handles refinished
 dorar los anillos
 redorer les anneaux
 dorare gli anelli

AA

AB

AC

AD

AE

AF

AK

AL

AO

KA

KK

X



titan instruments

nopa[®] instruments

Besonderheit:

nopa Titan Instrumente bieten insbesondere in der Herz-Thorax-Chirurgie Vorteile gegenüber herkömmlichen Instrumenten. Titan ist ca. 45% leichter als rostfreier Edelstahl, weshalb Titan Instrumente weniger traumatisierend sind. Titan ist außerdem ein vollkommen korrosionsbeständiges und antimagnetisches Material. **nopa** Titan Instrumente bedeuten größtmöglichen Komfort für den Chirurgen.

Features:

nopa Titan Instruments provide especially in Cardiovascular surgery a significant advantage compared to other Instruments. Titan is approximately 45% lighter than stainless steel. For that reason, Titan Instruments are less traumatic. Besides that, Titan is a completely stainless and anti-magnetic material. **nopa** Titan Instruments are the most comfortable choice for the Cardiovascular surgeon.

AE 400/16 T	MAYO-HEGAR NEEDLE HOLDER TUC 16,0 CM
AE 400/18 T	MAYO-HEGAR NEEDLE HOLDER TUC 18,0 CM
AE 400/20 T	MAYO-HEGAR NEEDLE HOLDER TUC 20,0 CM
AE 420/18 T	DE BAKEY NEEDLE HOLDER TUC 18,0 CM
AE 420/20 T	DE BAKEY NEEDLE HOLDER TUC 20,0 CM
AE 420/23 T	DE BAKEY NEEDLE HOLDER TUC 23,0 CM
AE 420/26 T	DE BAKEY NEEDLE HOLDER TUC 26,0 CM
AE 430/15 T	RYDER/FRENCH-EYE NEEDLE HOLDER TUC 15,0 CM
AE 430/18 T	RYDER/FRENCH-EYE NEEDLE HOLDER TUC 18,0 CM
AE 430/20 T	RYDER/FRENCH-EYE NEEDLE HOLDER TUC 20,0 CM
AE 438/18 T	MICROVASCULAR NEEDLE HOLDER TUC 18,0 CM
AE 438/20 T	MICROVASCULAR NEEDLE HOLDER TUC 20,0 CM
AE 438/23 T	MICROVASCULAR NEEDLE HOLDER TUC 23,0 CM
AE 466/13 T	HALSEY NEEDLE HOLDER TUC 13,0 CM
AE 572/14 T	CASTROVIEJO NH TUC STR RA SERRATED 14,0 CM
AE 580/02 T	JACOBSON MICRO-NH TUC RA SERRATED 21,0CM
AE 632/18 T	MICRO-NEEDLE HOLDER STR 18,0 CM
AE 633/18 T	MICRO-NEEDLE HOLDER CVD 18,0 CM



AE NAHT SUTURE SUTURA SUTURE SUTURA

Nadelhalter mit Hartmetalleinsätzen
 Needle Holders with Tungsten Carbide Inserts
 Porta-agujas con bocas de carburo de Tungsteno
 Porte-aiguilles à mors en carbure de tungstène
 Portaghi con placche di carburo di tungsteno



MAYO-HEGAR



AE 400/14
14,0 cm/5¹/₂"



AE 400/16
16,0 cm/6¹/₄"



AE 400/18
18,0 cm/7"



AE 400/20
20,0 cm/8"



AE 400/24
24,0 cm/9¹/₂"



AE 400/26
26,0 cm/10¹/₂"



AE 400/30
30,0 cm/12"



**DE-BAKEY
 (MAYO-HEGAR-DELICATE)**



AE 420/18
18,0 cm/7"



AE 420/20
20,0 cm/8"



AE 420/23
23,0 cm/9"



AE 420/26
26,0 cm/10¹/₂"



AE 420/31
31,0 cm/12¹/₄"

NAHT SUTURE SUTURA SUTURE SUTURA

Nadelhalter mit Hartmetalleinsätzen
 Needle Holders with Tungsten Carbide Inserts
 Porta-agujas con bocas de carburo de Tungsteno
 Porte-aiguilles à mors en carbure de tungstène
 Portaghi con placche di carburo di tungsteno

RYDER/FRENCH-EYE

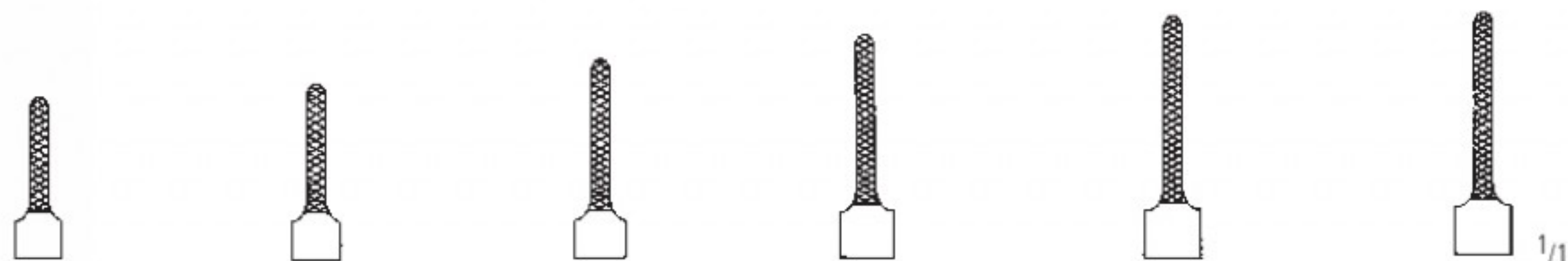

AE 430/13
13,0 cm/5"

AE 430/15
15,0 cm/6"

AE 430/18
18,0 cm/7"

AE 430/20
20,0 cm/8"

AE 430/23
23,0 cm/9"

AE 430/26
26,0 cm/10¹/₂"

MICRO RYDER

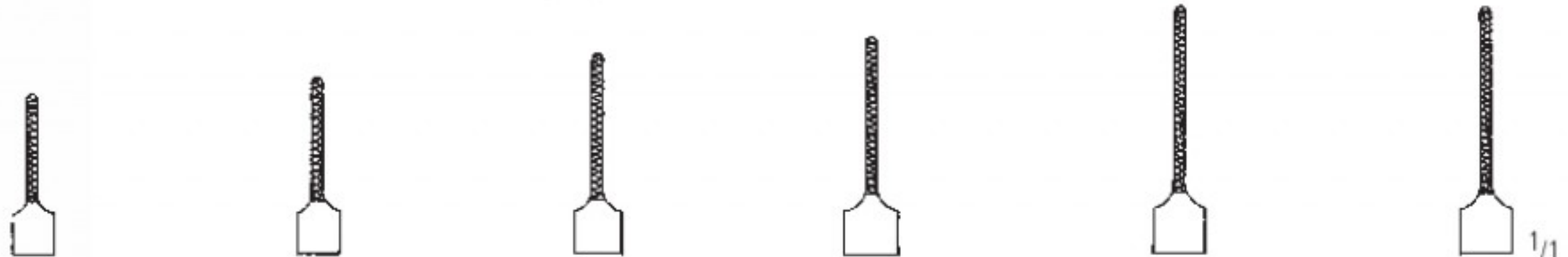

AE 434/13
13,0 cm/5"

AE 434/15
15,0 cm/6"

AE 434/18
18,0 cm/7"

AE 434/20
20,0 cm/8"

AE 434/23
23,0 cm/9"

AE 434/26
26,0 cm/10¹/₂"

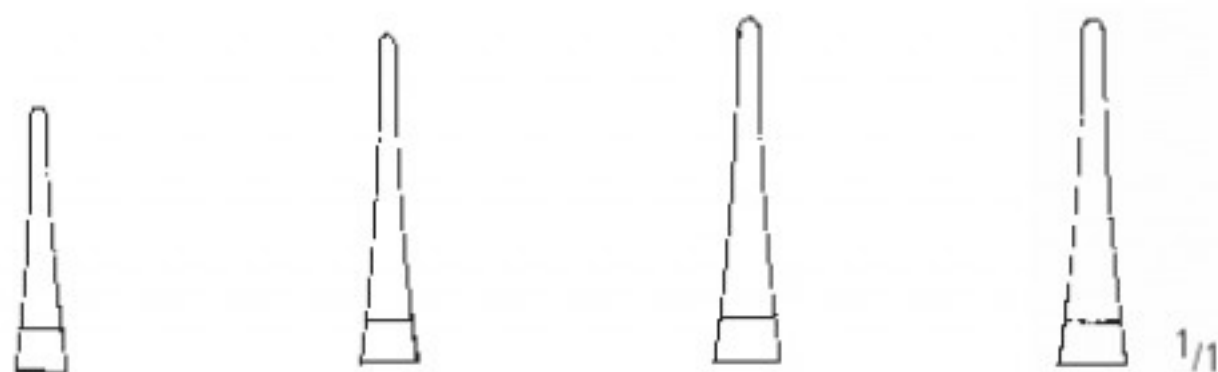

AE 436/14
14,0 cm/5¹/₂"

AE 436/18
18,0 cm/7"

AE 436/20
20,0 cm/8"

AE 436/23
23,0 cm/9"

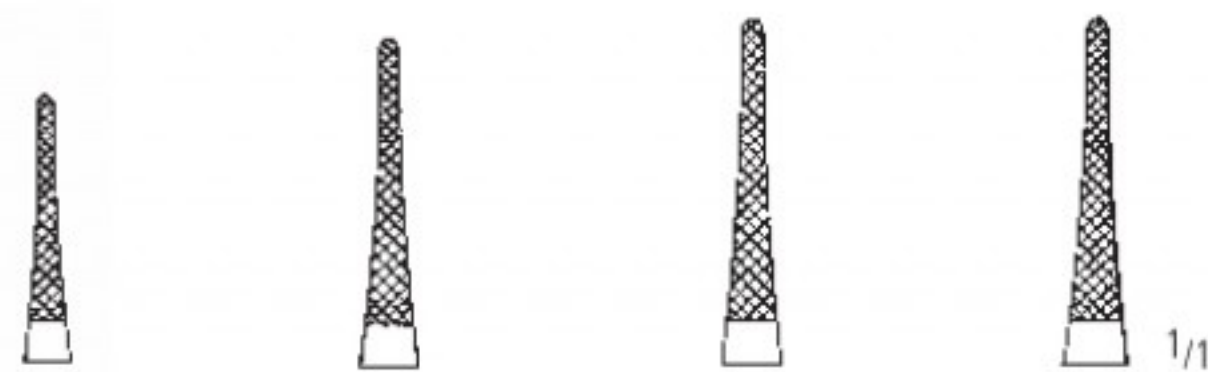

AE 438/14
14,0 cm/5¹/₂"

AE 438/18
18,0 cm/7"

AE 438/20
20,0 cm/8"

AE 438/23
23,0 cm/9"



EUFRATE PASQUÉ

extrem fein
 extremely delicate
 muy fino
 très fin
 molto fino

MICROVASCULAR

AA
AB
AC
AD
AE
AF
AK
AL
AO
KA
KK
X

Nadelhalter mit Hartmetalleinsätzen
 Needle Holders with Tungsten Carbide Inserts
 Porta-agujas con bocas de carburo de Tungsteno
 Porte-aiguilles à mors en carbure de tungstène
 Portaghi con placche di carburo di tungsteno



CARROLL
 AE 440/15
 15,0 cm/6"

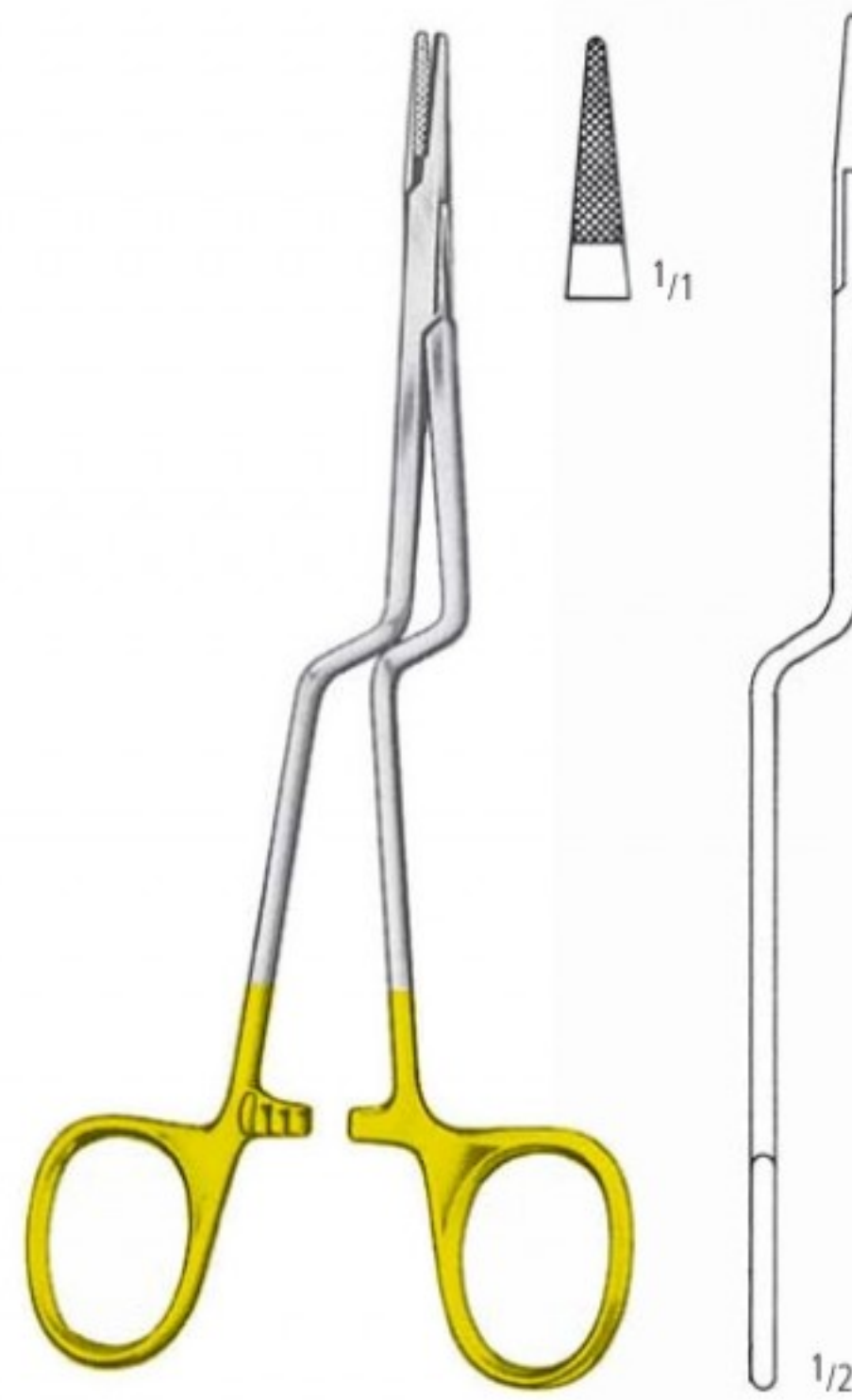

JACOBSON
 AE 444/18
 18,0 cm/7"



NEW ORLEANS
 AE 446/18
 18,0 cm/7"



SENNING
 (SWEDISH PATTERN)



NAHT SUTURE SUTURA SUTURE SUTURA

Nadelhalter mit Hartmetalleinsätzen
 Needle Holders with Tungsten Carbide Inserts
 Porta-agujas con bocas de carburo de Tungsteno
 Porte-aiguilles à mors en carbure de tungstène
 Portaghi con placche di carburo di tungsteno

AA
AB
AC
AD
AE
AF
AK
AL
AO
KA
KK
X



DERF
 AE 450/12
 12,5 cm/5"

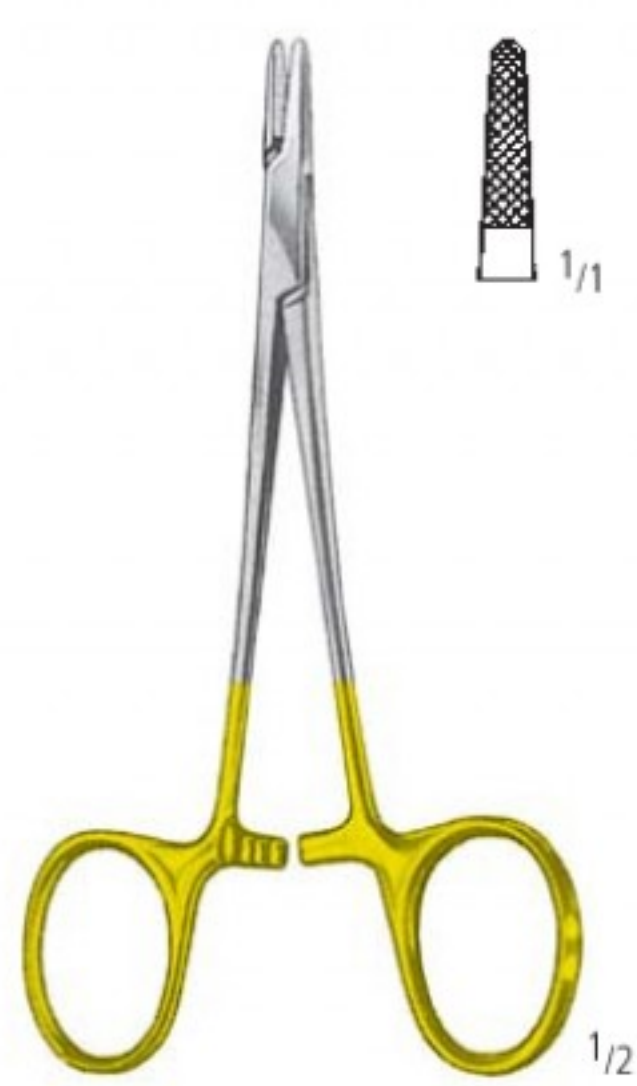

CONVERSE
 AE 452/12
 12,5 cm/5"

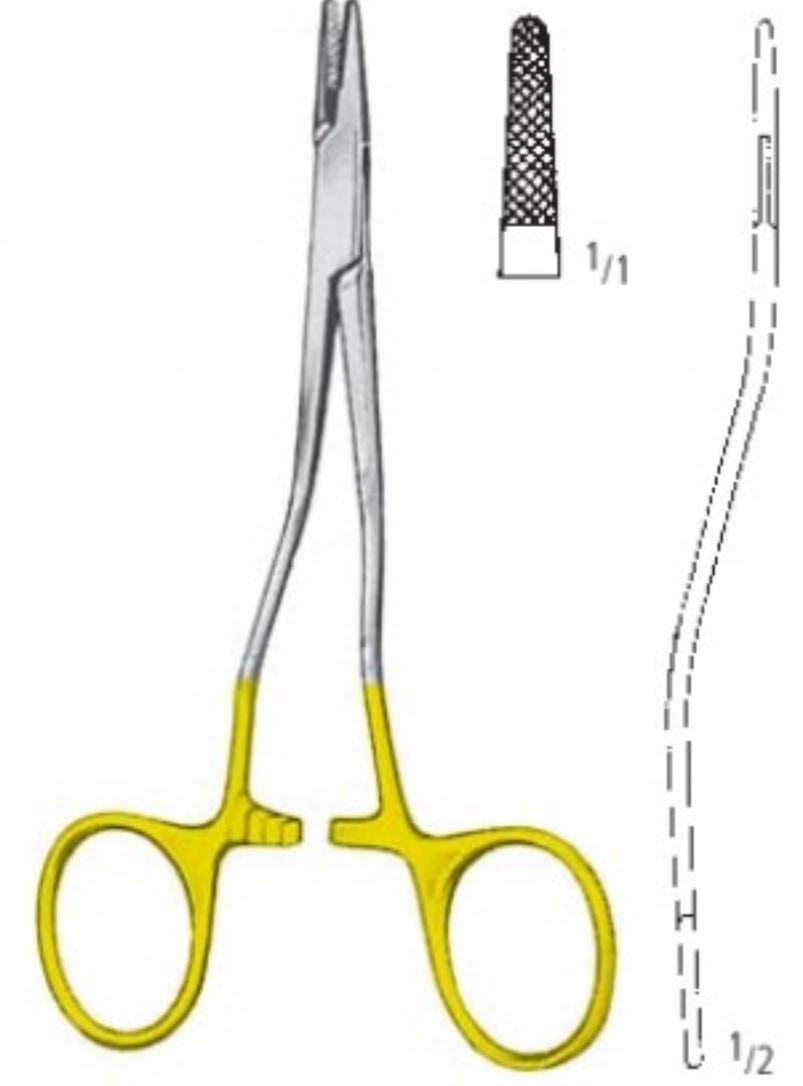

KILNER
 AE 455/13
 13,5 cm/5 1/4"

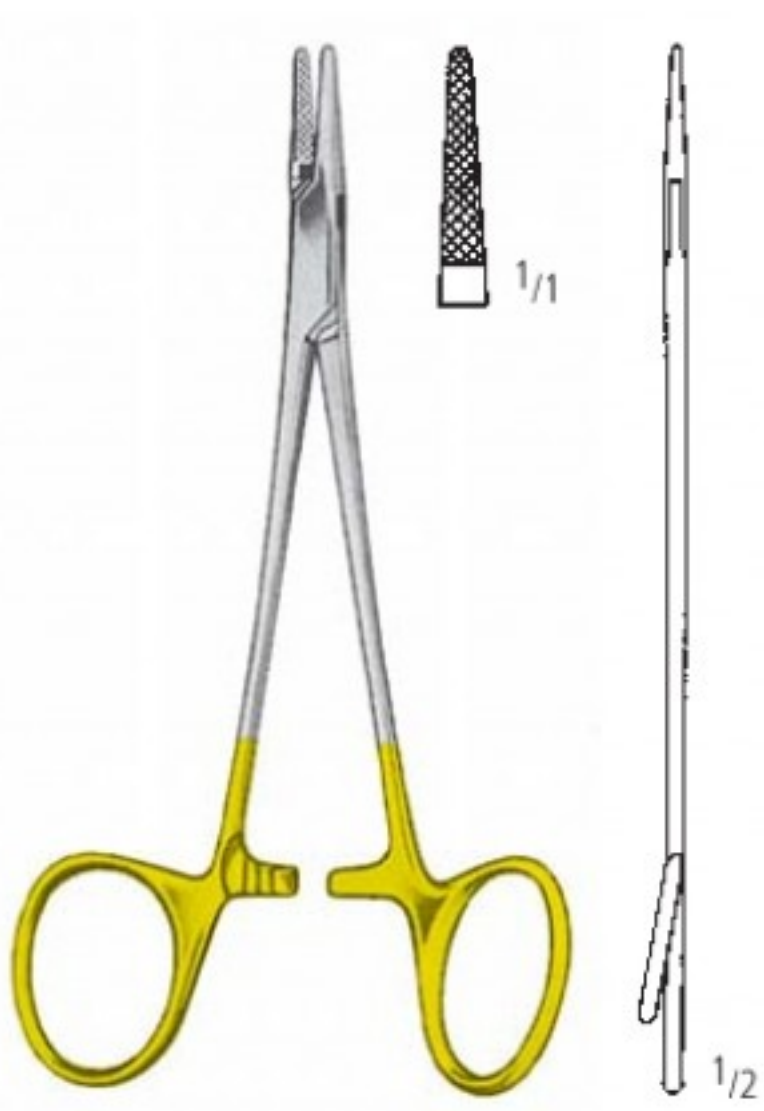

NEIVERT
 AE 456/13
 13,0 cm/5"

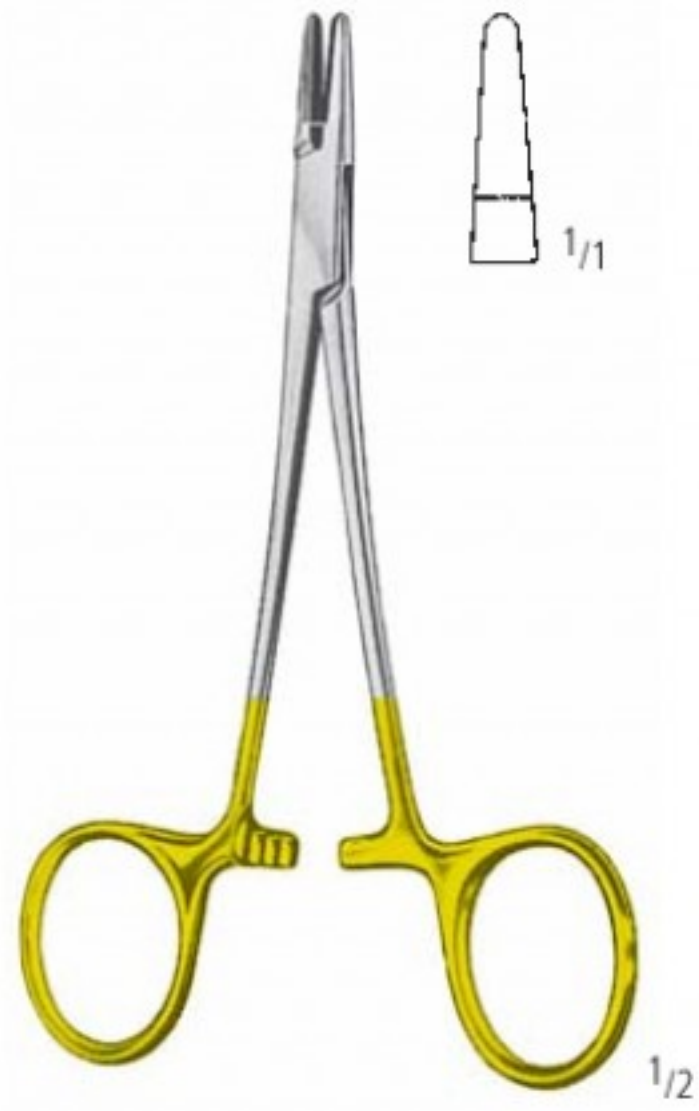

WEBSTER
 AE 460/13
 13,0 cm/5"



HALSEY
 13,0 cm/5"

AE NAHT SUTURE SUTURA SUTURE SUTURA

Nadelhalter mit Hartmetalleinsätzen
 Needle Holders with Tungsten Carbide Inserts
 Porta-agujas con bocas de carburo de Tungsteno
 Porte-aiguilles à mors en carbure de tungstène
 Portaghi con placche di carburo di tungsteno



BABY-CRILE-WOOD
 AE 468/15
 15,0 cm/6"

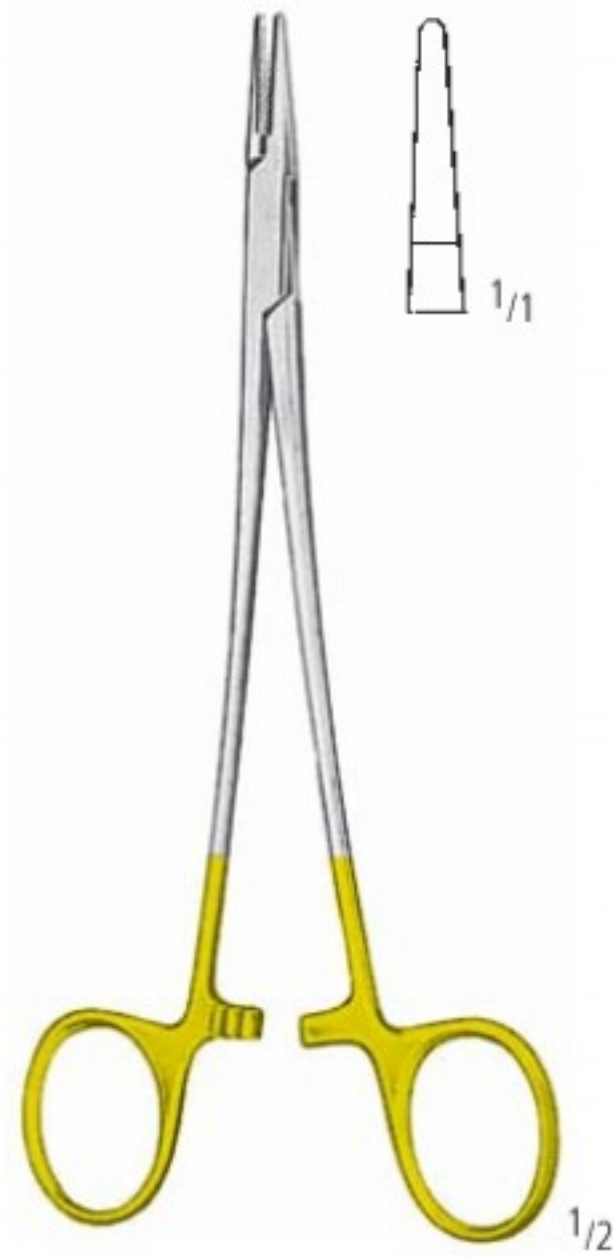

CRILE-WOOD
 AE 469/15
 15,0 cm/6"

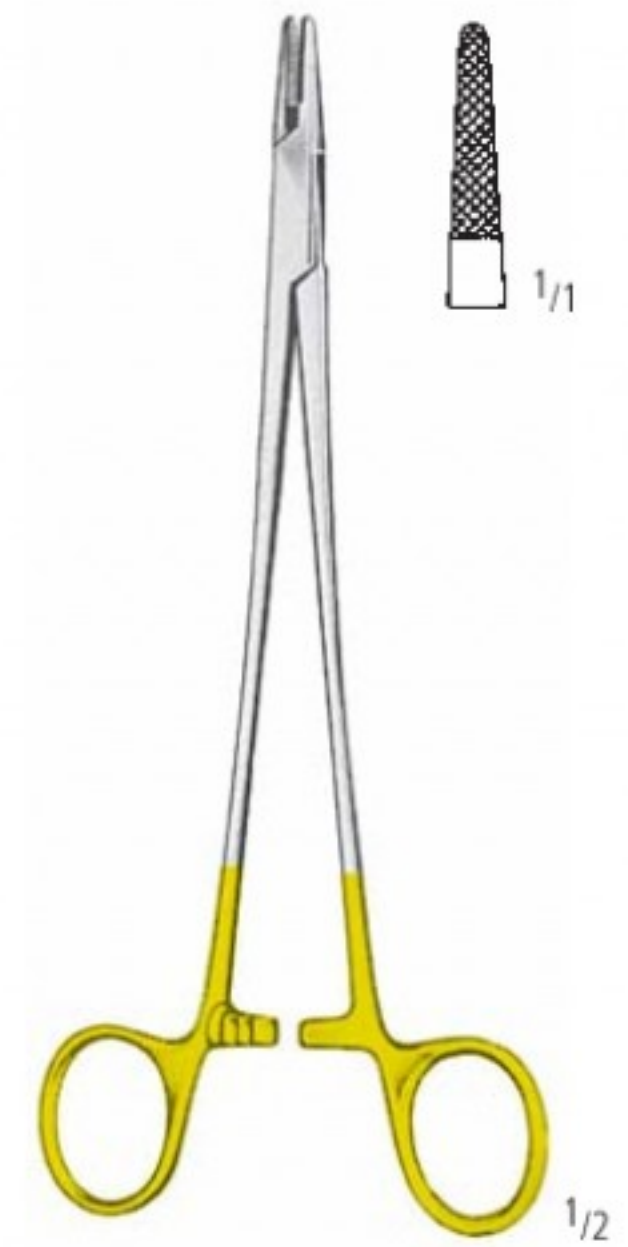

CRILE-WOOD
 AE 470/15
 15,0 cm/6"

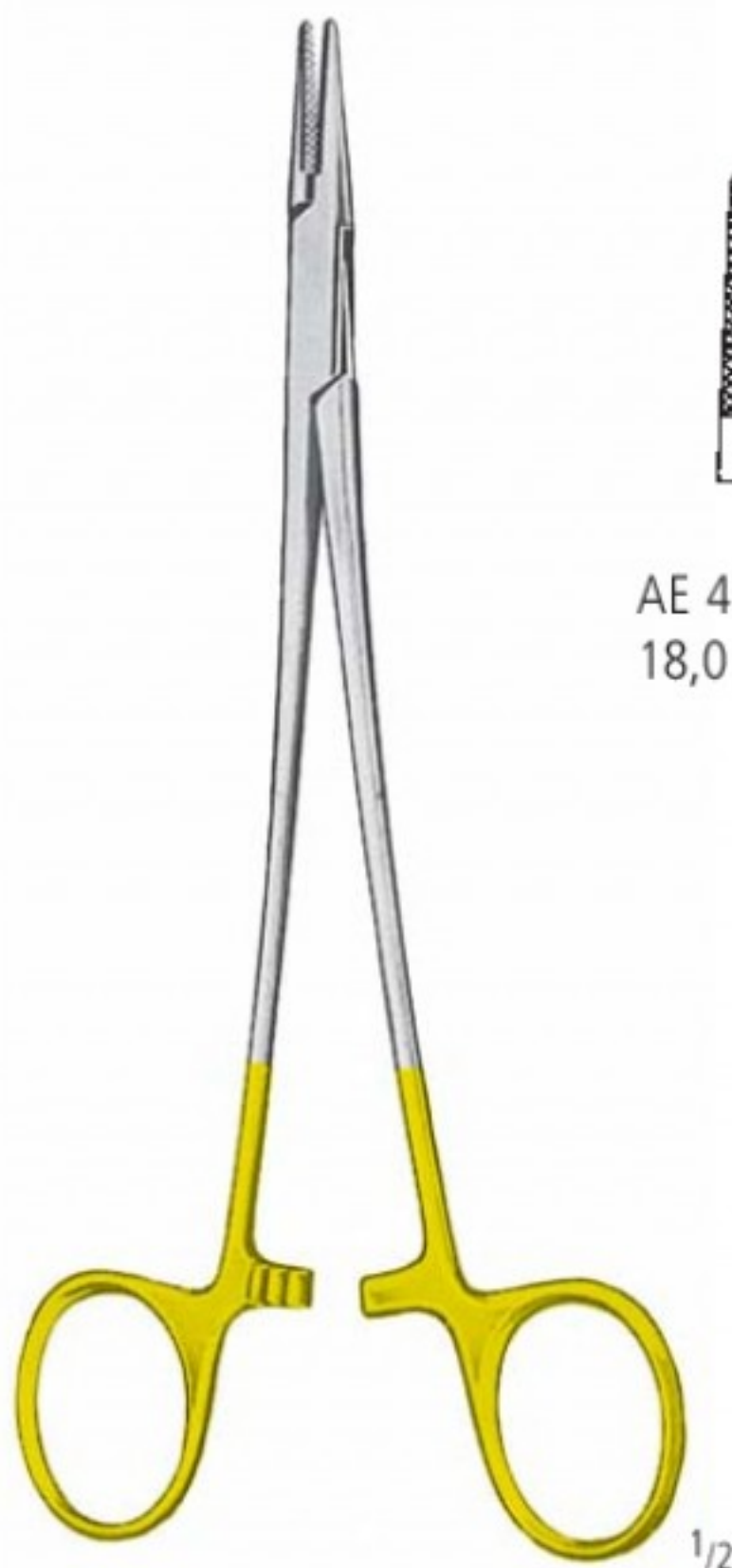

CRILE-WOOD



AE 470/18
 18,0 cm/7"



AE 470/20
 20,0 cm/8"



AE 470/23
 23,0 cm/9"



AE 471/18
 18,0 cm/7"



AE 471/23
 23,0 cm/9"

NAHT SUTURE SUTURA SUTURE SUTURA

Nadelhalter mit Hartmetalleinsätzen
 Needle Holders with Tungsten Carbide Inserts
 Porta-agujas con bocas de carburo de Tungsteno
 Porte-aiguilles à mors en carbure de tungstène
 Portaghi con placche di carburo di tungsteno



FINOCCHIETTO
 AE 472/27
 27,0 cm/10³/₄"

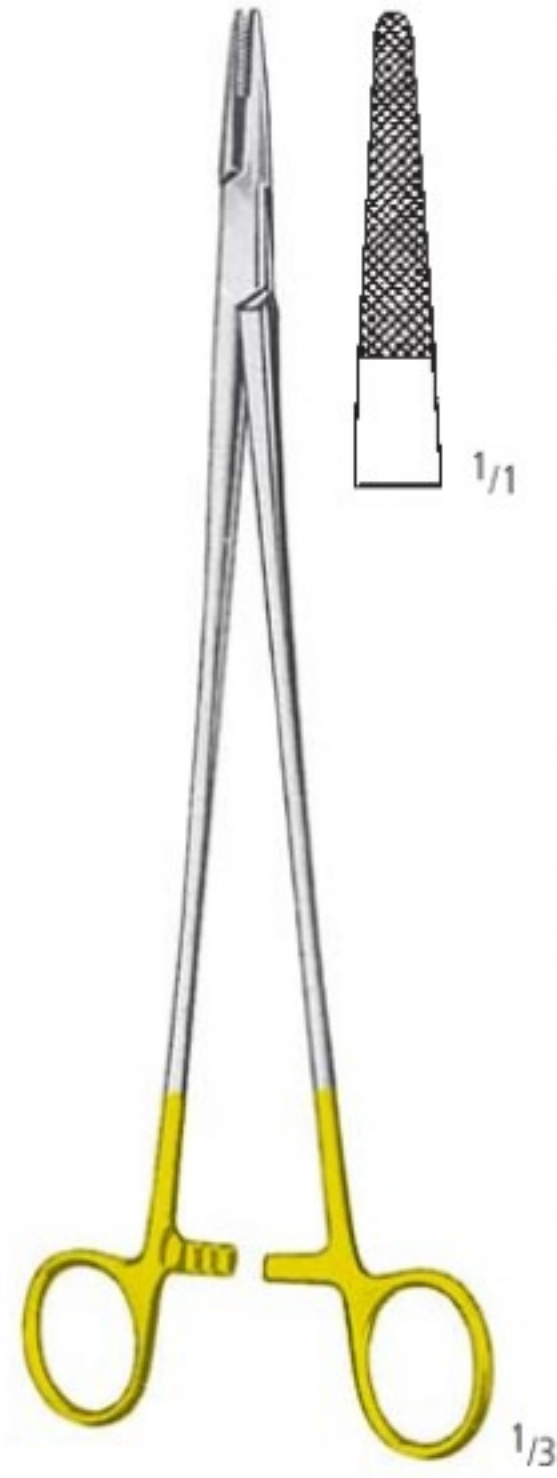

WANGENSTEEN
 AE 474/27
 27,0 cm/10³/₄"



BOZEMANN

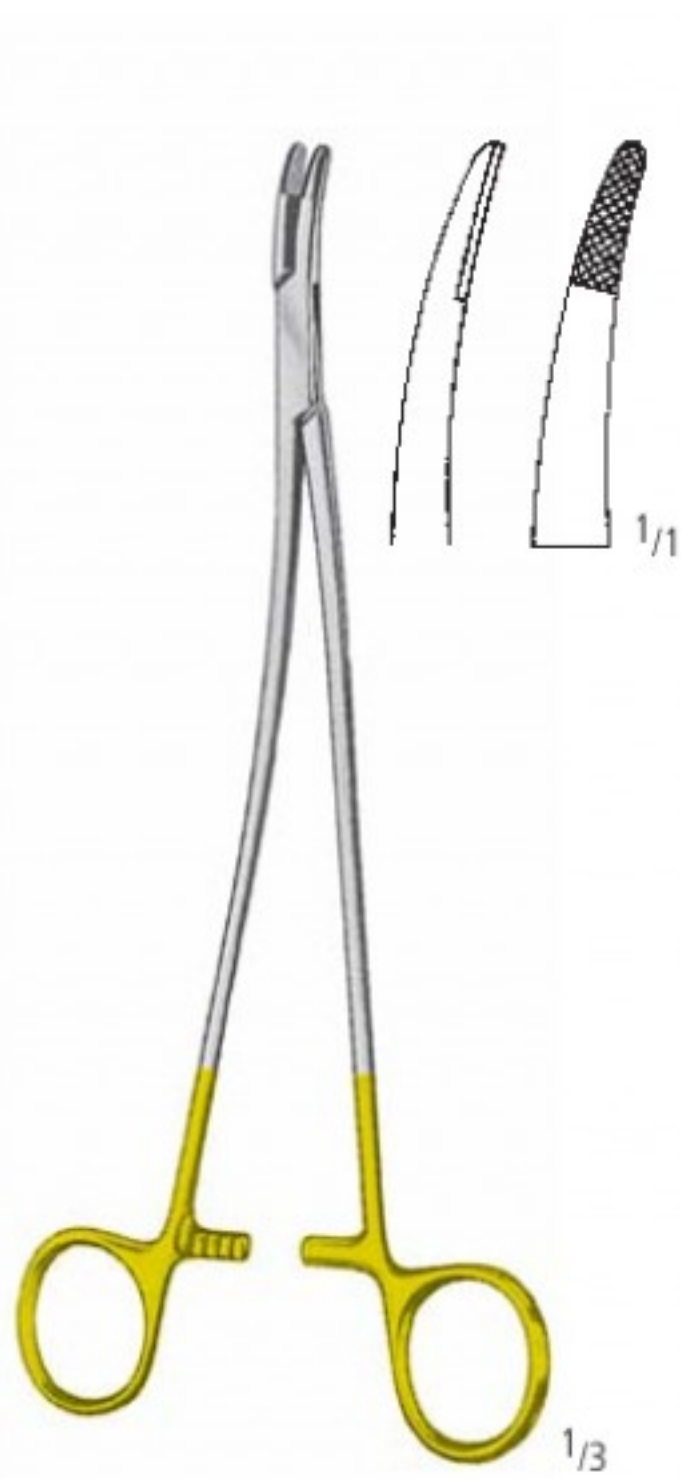
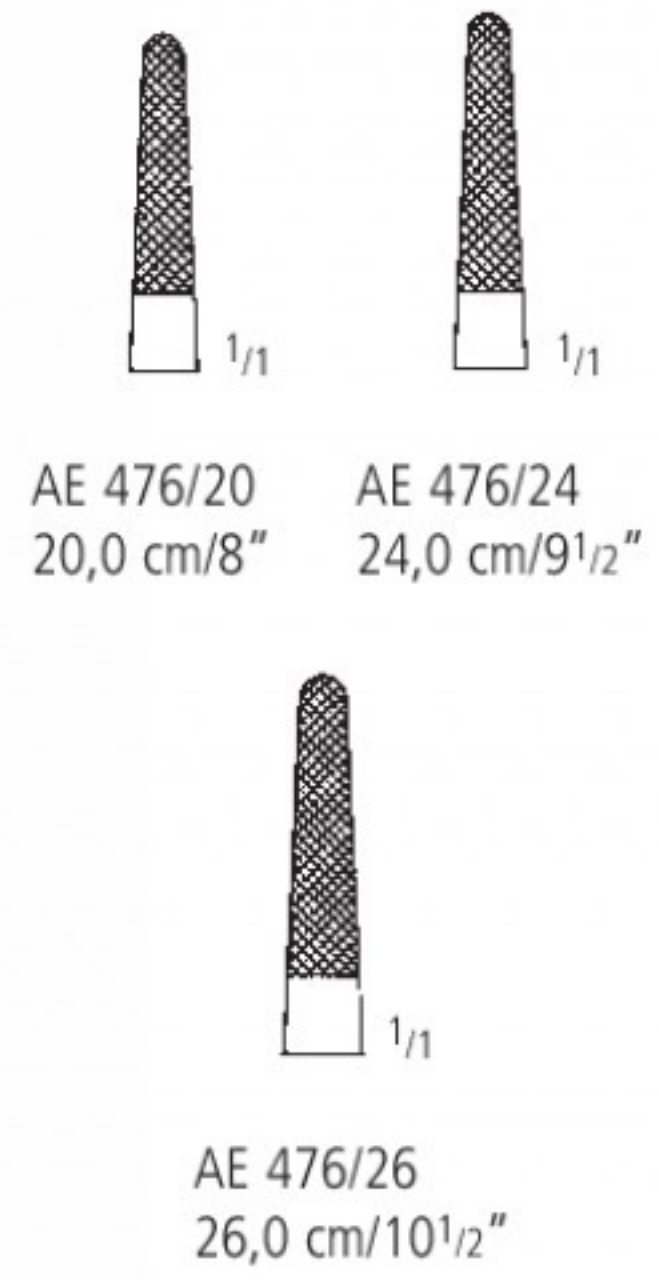

STRATTE
 AE 478/23
 23,0 cm/9"



SAROT

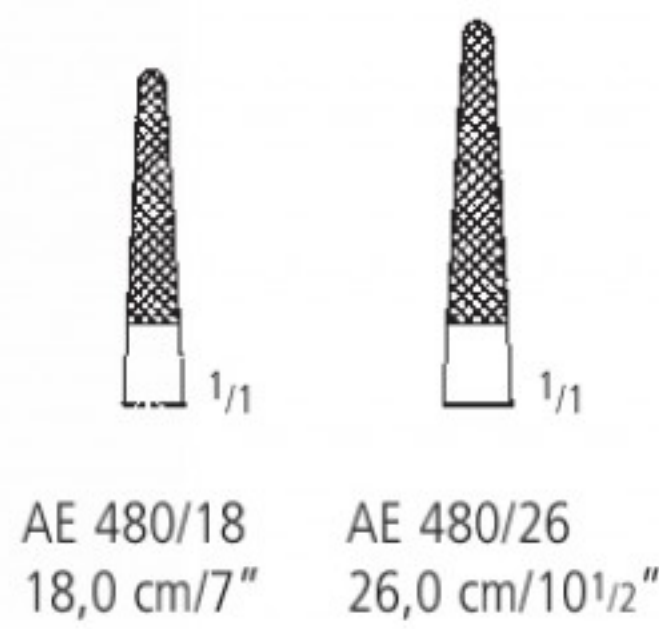

MASSON
 AE 482/27
 27,0 cm/10³/₄"

AA
 AB
 AC
 AD
 AE
 AF
 AK
 AL
 AO
 KA
 KK
 X

AE NAHT SUTURE SUTURA SUTURE SUTURA

Nadelhalter mit Hartmetalleinsätzen
 Needle Holders with Tungsten Carbide Inserts
 Porta-agujas con bocas de carburo de Tungsteno
 Porte-aiguilles à mors en carbure de tungstène
 Portaghi con placche di carburo di tungsteno



WERTHEIM



AE 487/20
20,0 cm/8"



AE 487/24
24,0 cm/9¹/₂"



AE 487/30
30,0 cm/12"



OLSEN-HEGAR



AE 488/14
14,0 cm/5¹/₂"



AE 488/17
17,0 cm/6³/₄"



AE 488/19
19,0 cm/7¹/₂"



AE 490/16
16,0 cm/6¹/₄"



GILLIES

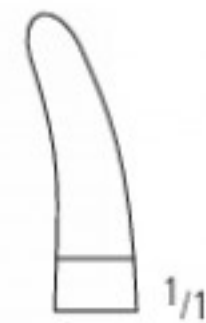

AE 491/16
16,0 cm/6¹/₄"

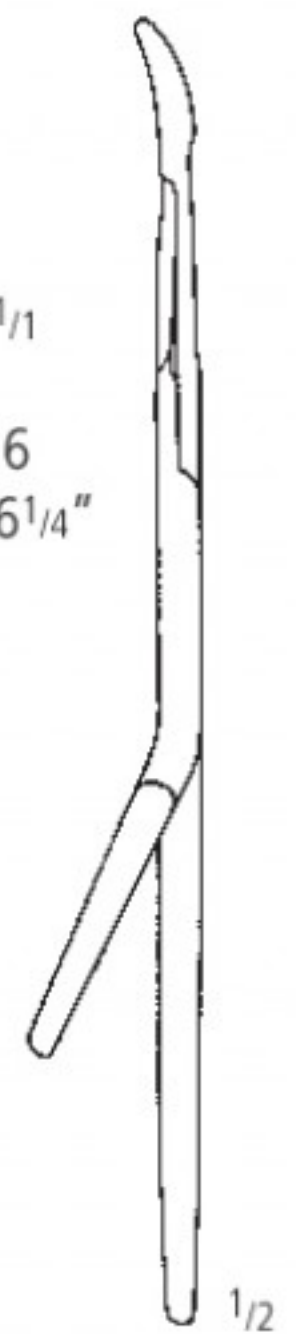

NAHT SUTURE SUTURA SUTURE SUTURA

Nadelhalter mit Hartmetalleinsätzen
 Needle Holders with Tungsten Carbide Inserts
 Porta-agujas con bocas de carburo de Tungsteno
 Porte-aiguilles à mors en carbure de tungstène
 Portaghi con placche di carburo di tungsteno

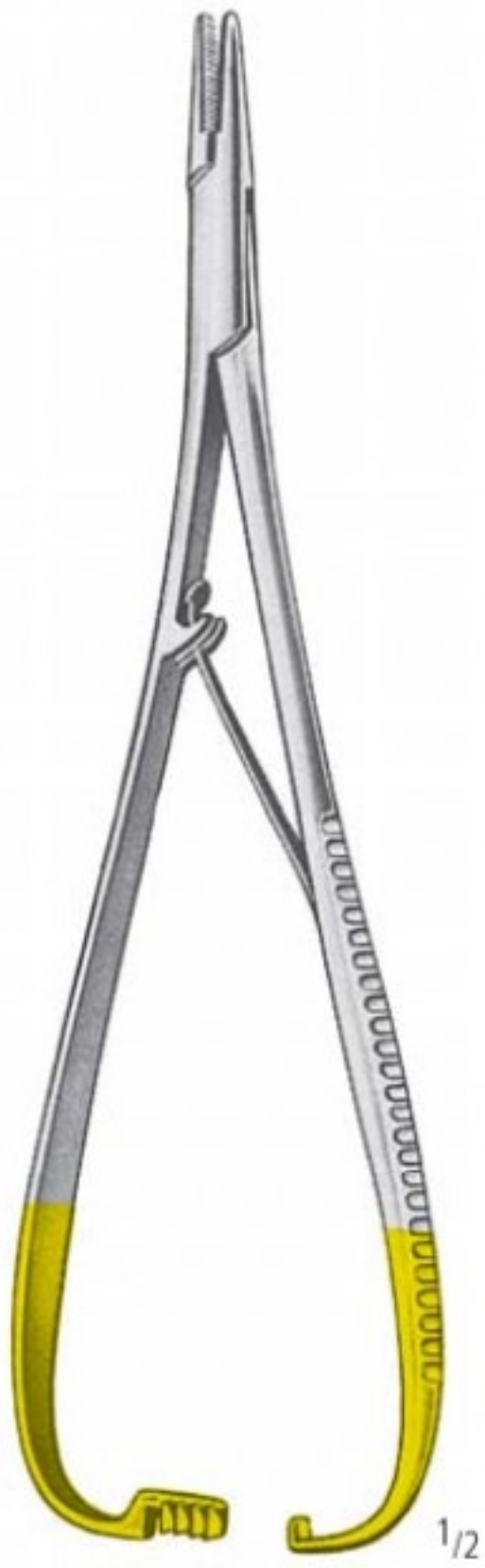

MATHIEU



AE 500/14
14,0 cm/5¹/₂"



AE 500/17
17,0 cm/6³/₄"



AE 500/20
20,0 cm/8"



AE 500/24
24,0 cm/9¹/₂"



MATHIEU



AE 501/14
14,0 cm/5¹/₂"



MATHIEU



AE 502/17
17,0 cm/6³/₄"



AE 502/20
20,0 cm/8"



AE 502/23
23,0 cm/9"



MATHIEU-DELICATE



AE 504/14
14,0 cm/5¹/₂"



AE 504/17
17,0 cm/6³/₄"



AE 504/20
20,0 cm/8"



METZENBAUM



AE 507/17
17,0 cm/6³/₄"



AE 507/19
19,5 cm/7¹/₂"

AA
AB
AC
AD
AE
AF
AK
AL
AO
KA
KK
X

Nadelhalter mit Hartmetalleinsätzen
 Needle Holders with Tungsten Carbide Inserts
 Porta-agujas con bocas de carburo de Tungsteno
 Porte-aiguilles à mors en carbure de tungstène
 Portaghi con placche di carburo di tungsteno



MATHIEU-RYDER



AE 510/17
17,0 cm/6³/₄"



AE 510/20
20,0 cm/8"

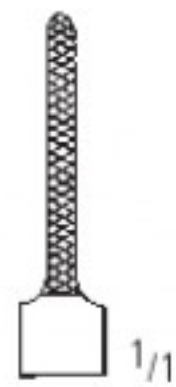

AE 510/24
24,0 cm/9¹/₂"



MATHIEU-RYDER VASCULAR

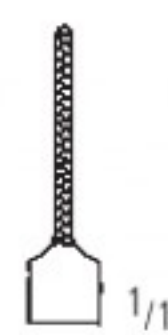

AE 512/17
17,0 cm/6³/₄"



AE 512/20
20,0 cm/8"



AE 512/24
24,0 cm/9¹/₂"

NAHT SUTURE SUTURA SUTURE SUTURA

Nadelhalter mit Hartmetalleinsätzen
 Needle Holders with Tungsten Carbide Inserts
 Porta-agujas con bocas de carburo de Tungsteno
 Porte-aiguilles à mors en carbure de tungstène
 Portaghi con placche di carburo di tungsteno

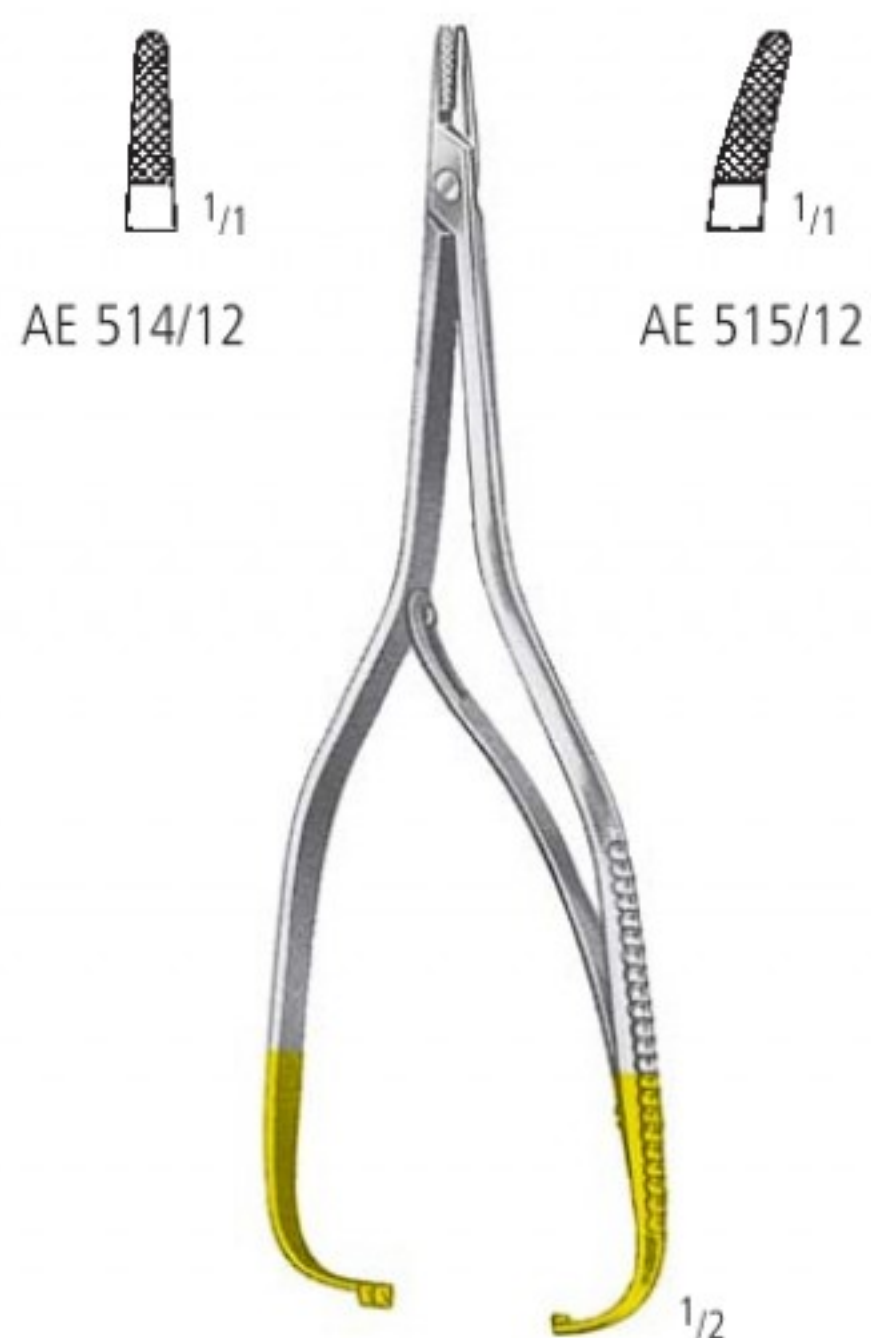

AE 514/12

AE 515/12



AE 516/16

AE 517/16



HÖSEL
 AE 520/25
 25,0 cm/10"

BOYNTON
 12,0 cm/4³/₄"



TOENNIS
 AE 522/18
 18,0 cm/7"

ARRUGA
 16,0 cm/6¹/₄"



LICHTENBERG
 AE 524/20
 20,0 cm/8"

AA
 AB
 AC
 AD
AE
 AF
 AK
 AL
 AO
 KA
 KK
 X

AE NAHT SUTURE SUTURA SUTURE SUTURA

Nadelhalter mit Hartmetalleinsätzen
 Needle Holders with Tungsten Carbide Inserts
 Porta-agujas con bocas de carburo de Tungsteno
 Porte-aiguilles à mors en carbure de tungstène
 Portaghi con placche di carburo di tungsteno



ZWEIFEL



AE 530/20
20,0 cm/8"



AE 530/23
23,0 cm/9"

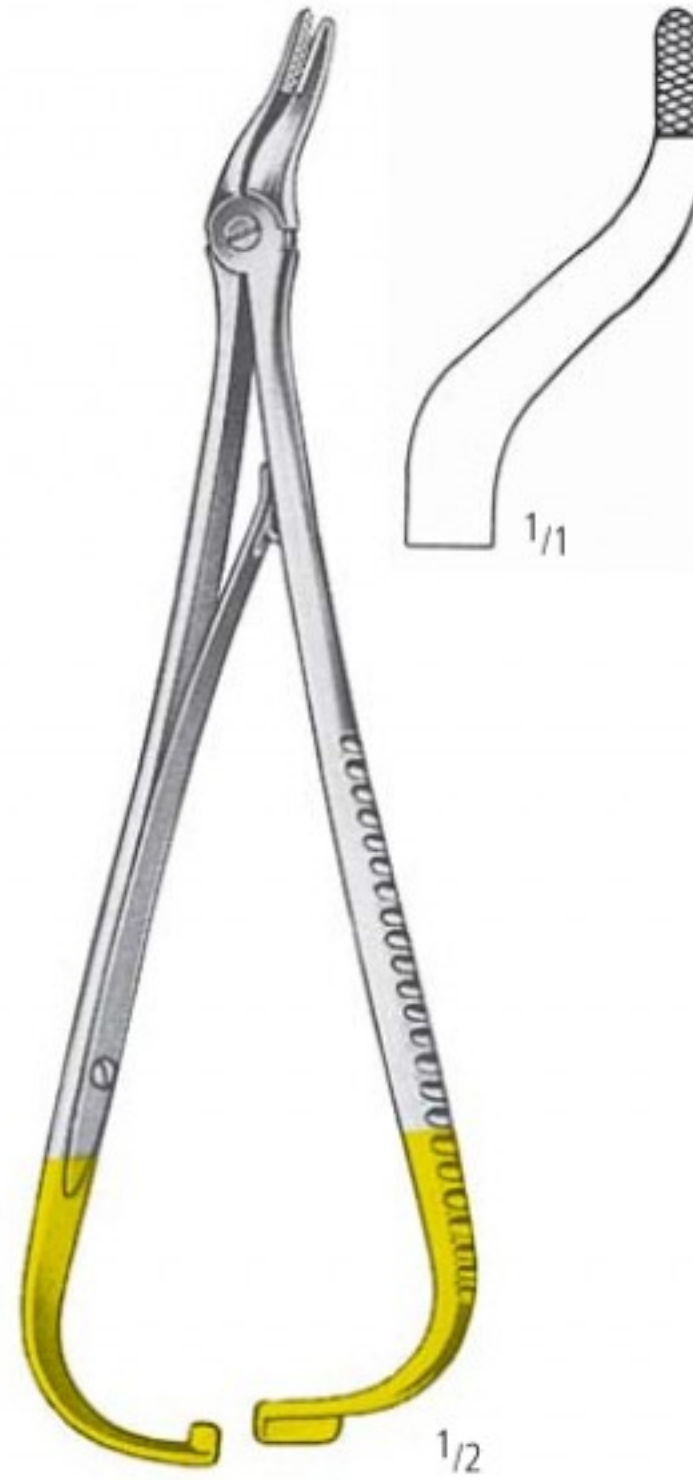

EISELSBERG-MATHIEU

AE 533/18
18,5 cm/7¹/₃"



LUETHY-BECK

AE 535/20
20,0 cm/8"

LANGENBECK

LANGENBECK-DELICATE

LANGENBECK-RYDER



AE 540/16
16,0 cm/6¹/₄"



AE 540/18
18,0 cm/7"



AE 540/20
20,0 cm/8"



AE 542/18
18,0 cm/7"



AE 542/20
20,0 cm/8"



AE 542/23
23,0 cm/9"



AE 544/18
18,0 cm/7"



AE 544/20
20,0 cm/8"

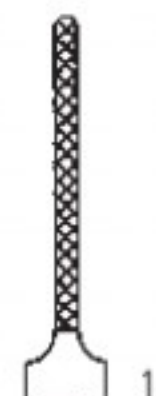

AE 544/23
23,0 cm/9"

NAHT SUTURE SUTURA SUTURE SUTURA

Drahtzangen mit Hartmetalleinsätzen
 Wire Twisting Forceps with Tungsten Carbide Inserts
 Pinzas para torcer hilos con bocas de carburo de Tungsteno
 Pinces à torsader le fil à mors en carbure de tungstène
 Pinze per ritorcere fili con placche di carburo di tungsteno



STERNUM



18,5 cm/7¹/₄"

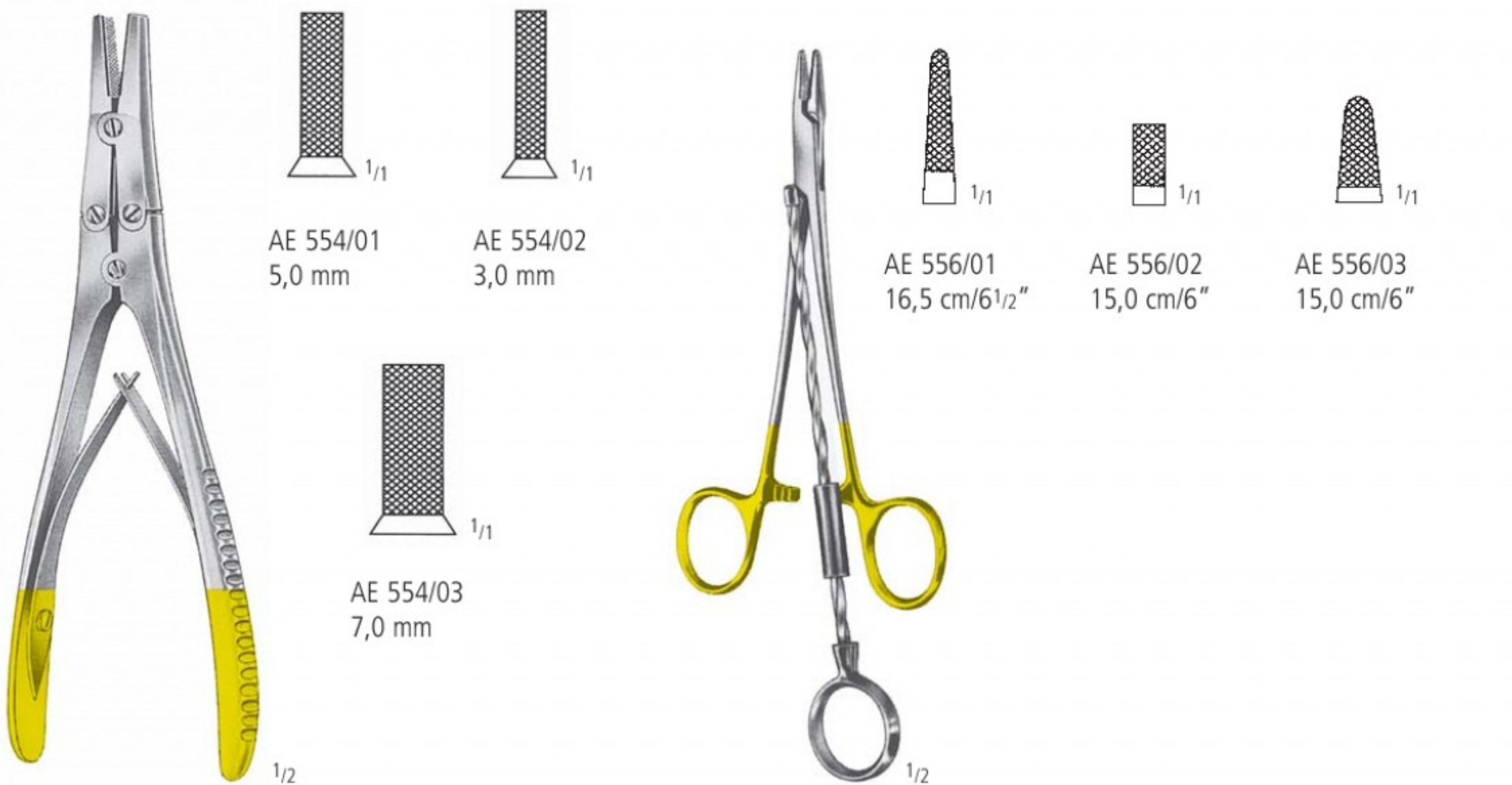

18,0 cm/7"

CORWIN

AA
AB
AC
AD
AE
AF
AK
AL
AO
KA
KK
X

AE NAHT SUTURE SUTURA SUTURE SUTURA

Mikro-Nadelhalter mit Hartmetalleinsätzen
 Micro-Needle Holders with Tungsten Carbide Inserts
 Micro-Porta-agujas con bocas de carburo de Tungsteno
 Micro-Porte-aiguilles à mors en carbure de tungstène
 Micro-Portaghi con placche di carburo di tungsteno



CASTROVIEJO
 14,0 cm/5 1/2"



CASTROVIEJO
 14,0 cm/5 1/2"



18,0 cm/7"

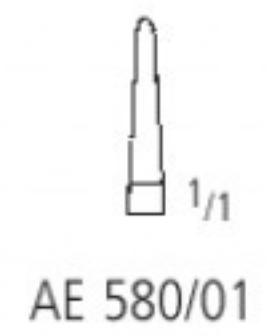
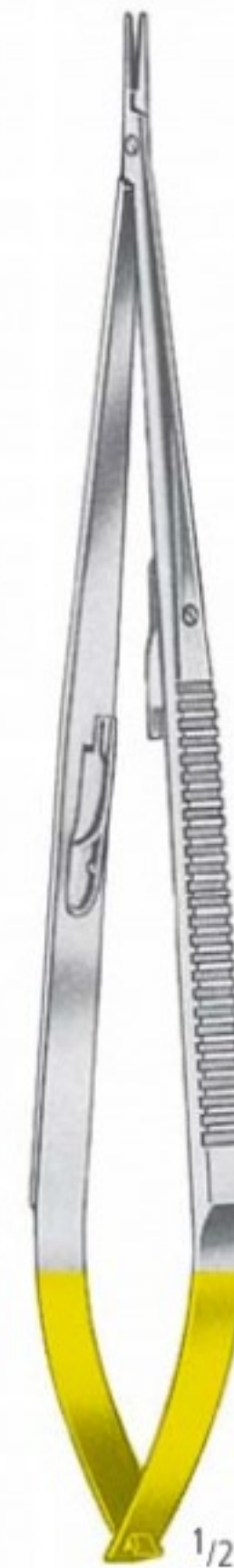

JACOBSON
 21,0 cm/8 1/4"

NAHT SUTURE SUTURA SUTURE SUTURA

Mikro-Nadelhalter mit Hartmetalleinsätzen
 Micro-Needle Holders with Tungsten Carbide Inserts
 Micro-Porta-agujas con bocas de carburo de Tungsteno
 Micro-Porte-aiguilles à mors en carbure de tungstène
 Micro-Portaghi con placche di carburo di tungsteno



DIETRICH



AE 582/16
16,0 cm/6¹/₄"

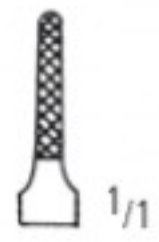

AE 582/18
18,0 cm/7"



AE 582/20
20,0 cm/8"

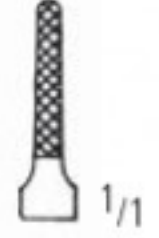

AE 582/23
23,0 cm/9"



AE 582/26
26,0 cm/10¹/₂"



KALT
AE 584/14
13,5 cm/5¹/₄"



CASTROVIEJO
AE 586/13
13,0 cm/5"

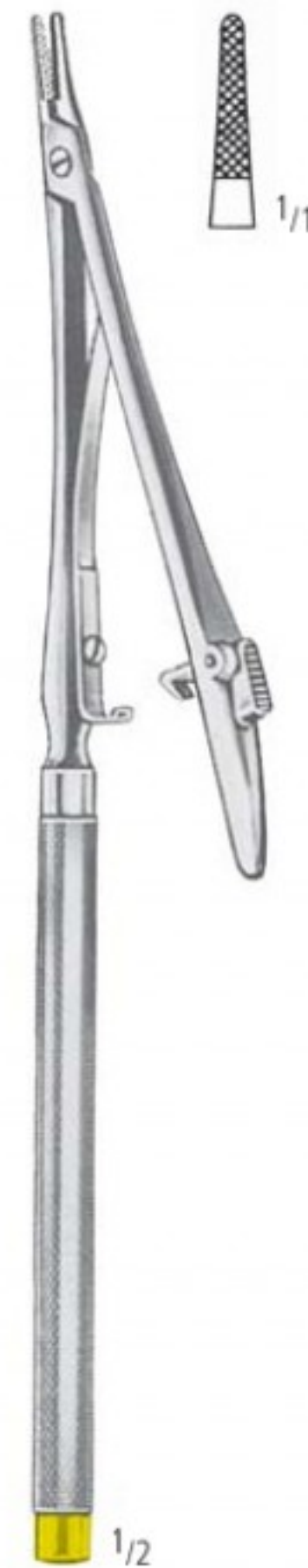

POTTS-SMITH
AE 588/22
22,0 cm/8³/₄"

AA
AB
AC
AD
AE
AF
AK
AL
AO
KA
KK
X

Nadelhalter
Needle Holders
Porta-agujas
Porte-aiguilles
Portaghi

nopa[®] DIAMOND



14,0 cm/5 1/2"

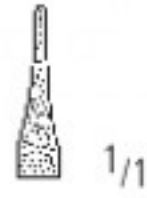

KS 080/14

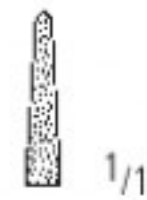

18,0 cm/7"
23,0 cm/9"

KS 080/18
KS 080/23



14,0 cm/5 1/2"



KS 081/14



18,0 cm/7"
23,0 cm/9"

KS 081/18
KS 081/23

Nadelhalter
Needle Holders
Porta-agujas
Porte-aiguilles
Portaghi

nopa® DIAMOND



21,0 cm/8¹/₄"

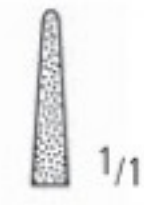

KS 082/21

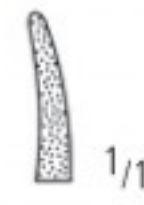

KS 083/21

AA
AB
AC
AD
AE
AF
AK
AL
AO
KA
KK
X

AE NAHT SUTURE SUTURA SUTURE SUTURA

Mikro-Nadelhalter mit Rundgriff
 Micro-Needle Holders with Pen-Type Handle
 Micro-Porta-agujas con mango redondo
 Micro-Porte-aiguilles à manches rondes
 Micro-Portaghi con manici rotondi

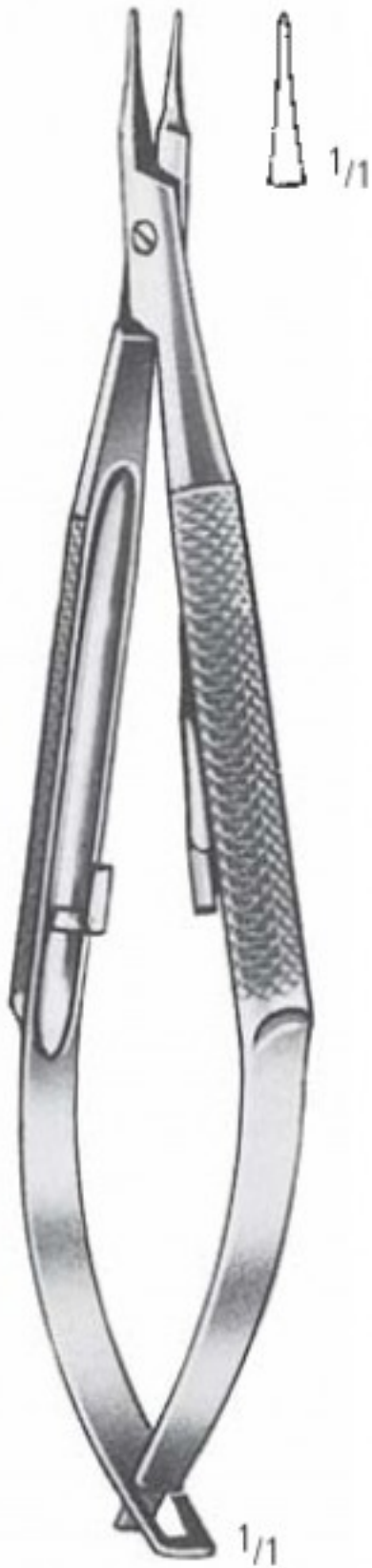

**BARRAQUER-
TROUTMAN**
 AE 600/10
 10,0 cm/4"

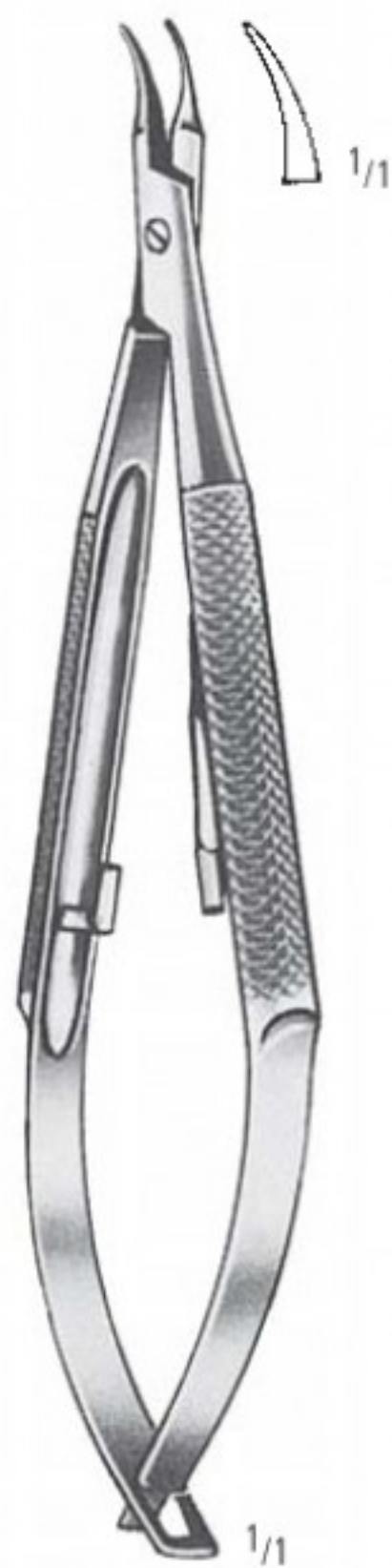

**BARRAQUER-
TROUTMAN**
 AE 601/10
 10,0 cm/4"



**BARRAQUER-
TROUTMAN**
 AE 602/10
 10,0 cm/4"



**BARRAQUER-
TROUTMAN**
 AE 603/10
 10,0 cm/4"



BARRAQUER
 AE 605/11
 11,0 cm/4¹/₃"



BARRAQUER
 AE 605/13
 13,0 cm/5"



BARRAQUER
 AE 605/14
 14,0 cm/5¹/₂"



BARRAQUER
 AE 606/14
 14,0 cm/5¹/₂"



BARRAQUER
 AE 607/14
 14,0 cm/5¹/₂"

NAHT SUTURE SUTURA SUTURE SUTURA

Mikro-Nadelhalter mit Rundgriff
 Micro-Needle Holders with Pen-Type Handle
 Micro-Porta-agujas con mango redondo
 Micro-Porte-aiguilles à manches rondes
 Micro-Portaghi con manici rotondi

AA

AB

AC

AD

AE

AF

AK

AL

AO

KA

KK

X



TROUTMAN
 AE 609/01
 12,0 cm/4³/₄"



TROUTMAN
 AE 609/02
 12,0 cm/4³/₄"



 1/11
 AE 610/15

 1/11
 AE 611/15

REILL
 15,0 cm/6"



 1/11
 AE 612/15

 1/11
 AE 613/15

REILL
 15,0 cm/6"

AE NAHT SUTURE SUTURA SUTURE SUTURA

Mikro-Nadelhalter mit Rundgriff
 Micro-Needle Holders with Pen-Type Handle
 Micro-Porta-agujas con mango redondo
 Micro-Porte-aiguilles à manches rondes
 Micro-Portaghi con manici rotondi



AE 621/14
 14,0 cm/5 1/2"



AE 623/14
 14,0 cm/5 1/2"

...für Rechtshänder
 ...for right handed surgeons
 ...para diestros
 ...pour des droitiers
 ...per destrimani

Maulteil konkav/konvex
 Jaws concave/convex
 Bocas concavas/convexas
 Mors concave/convexe
 Morso concavo/convesso

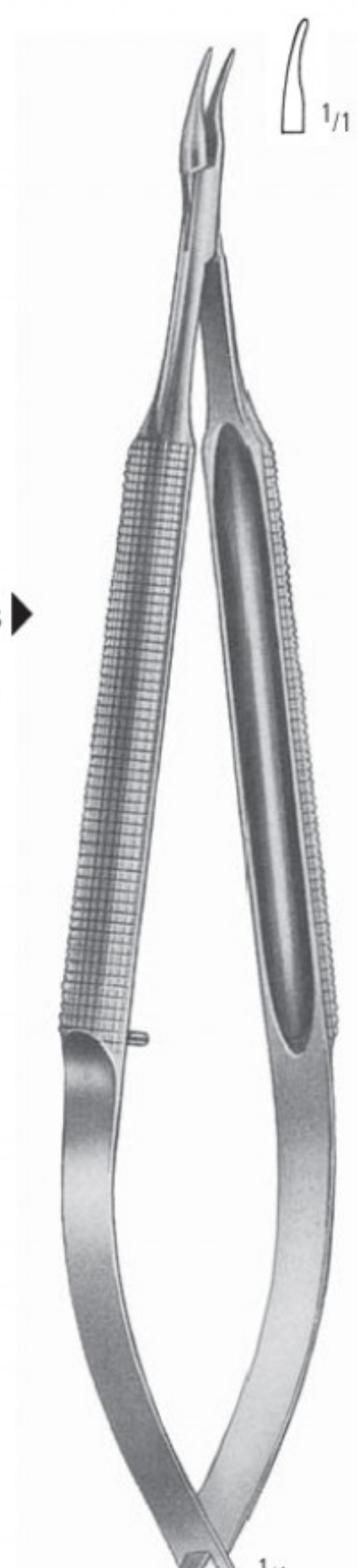

AE 625/14
 14,0 cm/5 1/2"

...für Linkshänder
 ...for left handed surgeons
 ...para zurdos
 ...pour gaucher
 ...per mancini

NAHT SUTURE SUTURA SUTURE SUTURA

Mikro-Nadelhalter mit Rundgriff
 Micro-Needle Holders with Pen-Type Handle
 Micro-Porta-agujas con mango redondo
 Micro-Porte-aiguilles à manches rondes
 Micro-Portaghi con manici rotondi



AE 630/18
 18,0 cm/7"



AE 631/18
 18,0 cm/7"



AE 632/18
 18,0 cm/7"



AE 633/18
 18,0 cm/7"

- AA
- AB
- AC
- AD
- AE
- AF
- AK
- AL
- AO
- KA
- KK
- X

AE NAHT SUTURE SUTURA SUTURE SUTURA

Mikro-Nadelhalter
 Micro-Needle Holders
 Micro-Porta-agujas
 Micro-Porte-aiguilles
 Micro-Portaghi

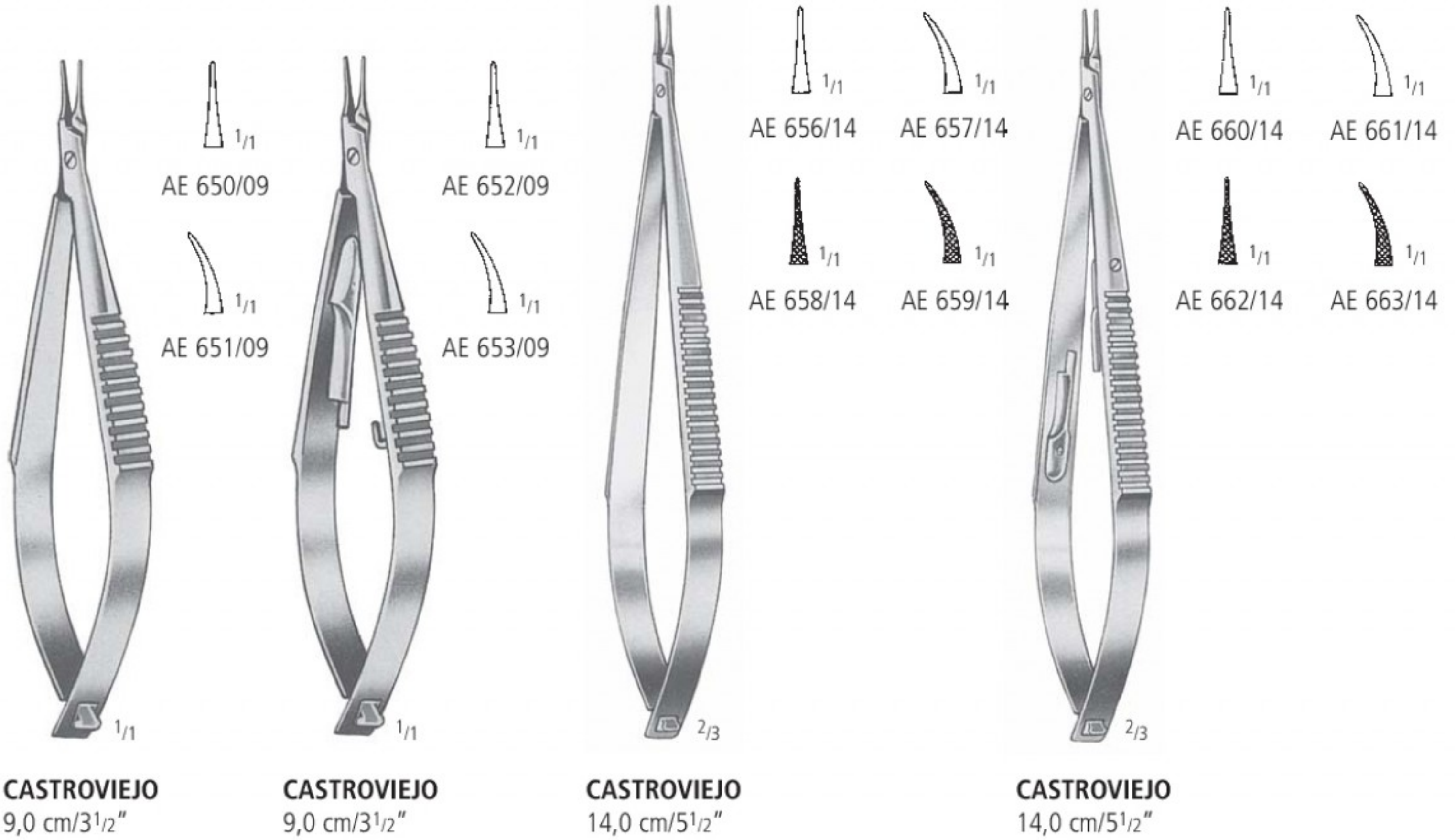

NAHT SUTURE SUTURA SUTURE SUTURA

Mikro-Nadelhalter
 Micro-Needle Holders
 Micro-Porta-agujas
 Micro-Porte-aiguilles
 Micro-Portaghi

AA

AB

AC

AD

AE

AF

AK

AL

AO

KA

KK

X

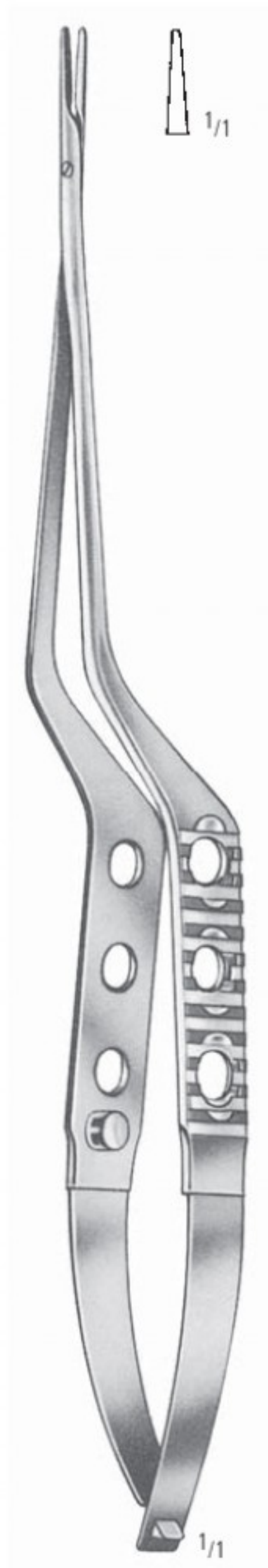

AE 680/16
 AE 680/18
 AE 680/20
 AE 680/22

16,5 cm/6¹/₂"
 18,0 cm/7"
 20,0 cm/8"
 22,0 cm/8³/₄"

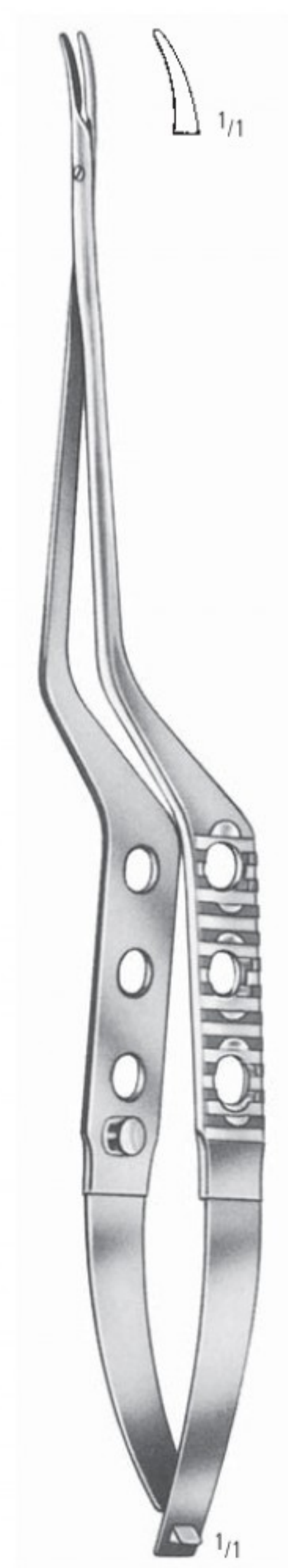

AE 681/16
 AE 681/18
 AE 681/20
 AE 681/22

TUPFERZANGEN
SPONGE FORCEPS
PINZAS PARA POLIPOS
PINCES A PANSEMENTS
PINZE PER POLIPI

AF

nopa[®] instruments

Weitere Tupferzangen finden Sie in unserem Katalog "Allgemeine Chirurgie" in Gruppe AF.

For further sponge forceps kindly refer to our catalogue "General Surgery", section AF.

Para pinzas polipos adicionales, por favor consulte nuestro catálogo de "Cirugía general", grupo AF.

Pour des pinces à pansements supplémentaires, consultez notre catalogue "Chirurgie Generale", section AF.

Per gli altri pinze per polipi, consultare il nostro catalogo "Chirurgia Generale", gruppo AF.



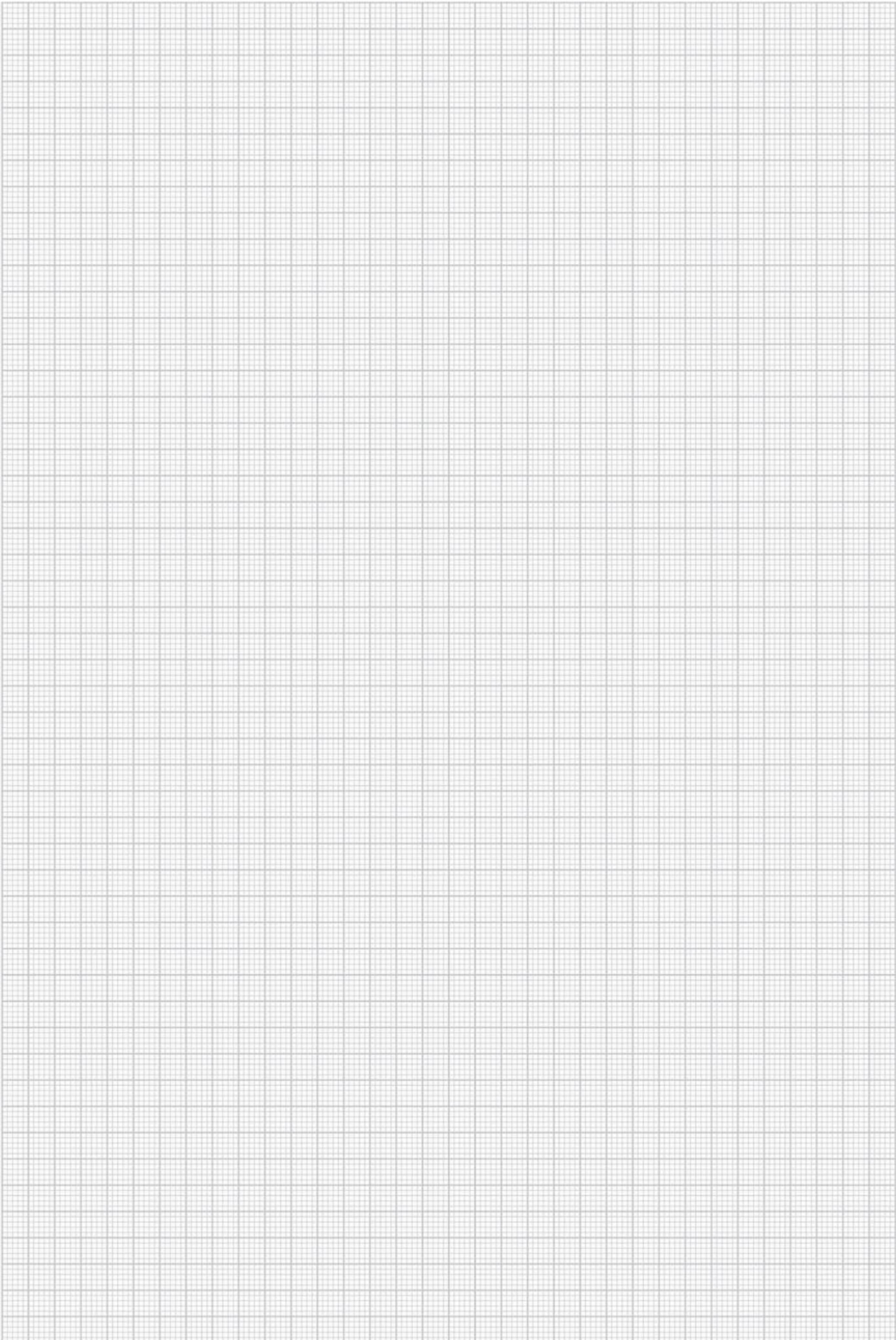

TUPFERZANGEN SPONGE FORCEPS PINZAS PARA POLIPOS PINCES A PANSEMENTS PINZE PER POLIPI

Korn- und Tupferzangen, Schwammzangen
 Polypus and Dressing Forceps, Sponge Holding Forceps
 Pinzas para pólipos, tapones y esponjas
 Pincers à pansements, à tampons et à éponges
 Pinze per polipi, tamponi e spugne

AA

AB

AC

AD

AE

AF

AK

AL

AO

KA

KK

X

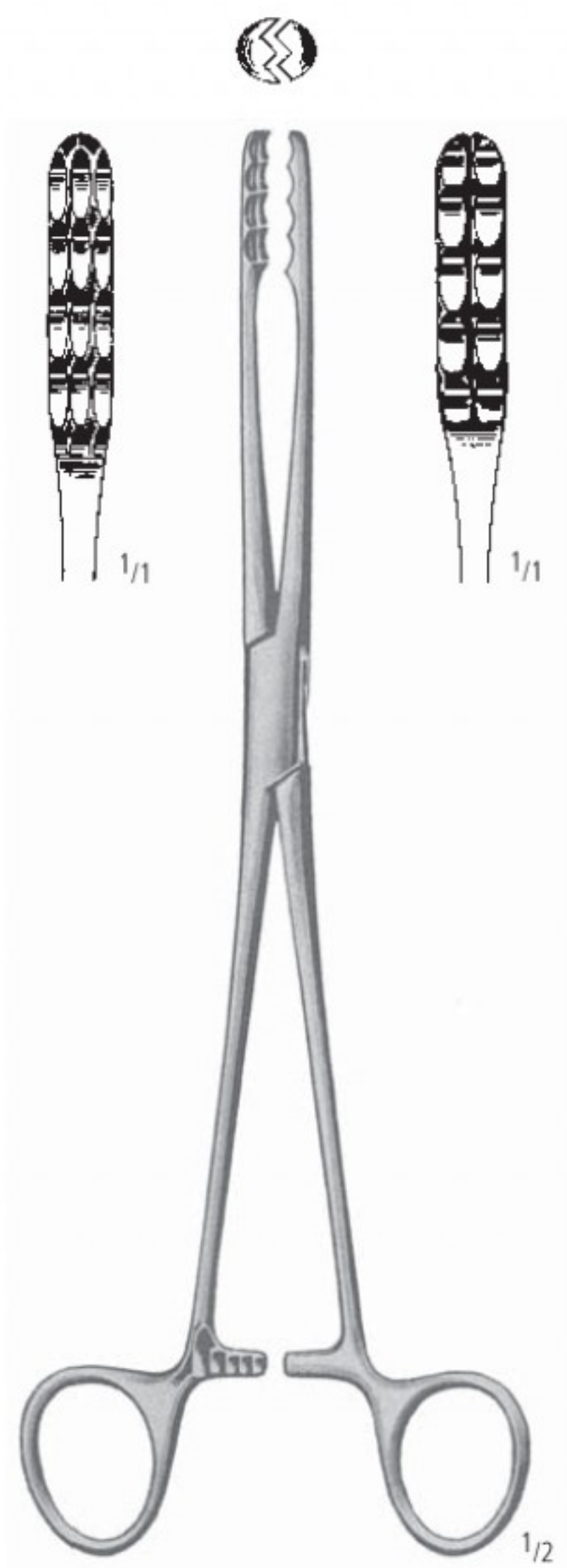

ULRICH
 AF 070/22
 AF 070/25

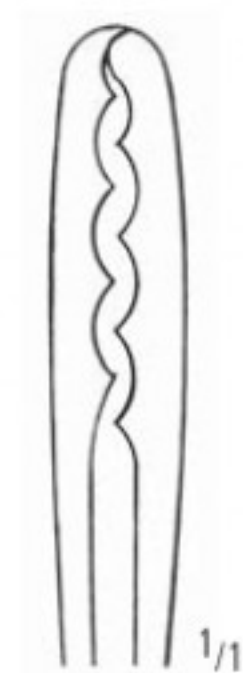

22,0 cm/8³/₄"
 25,0 cm/10"

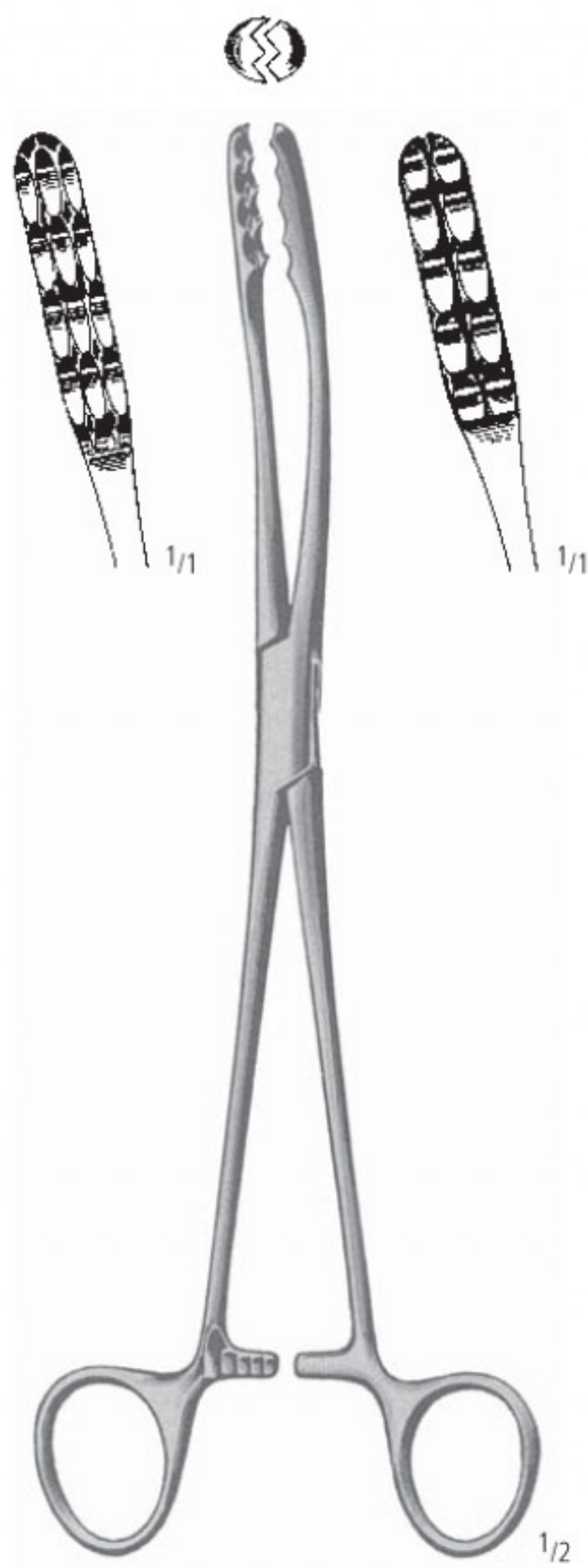

ULRICH
 AF 071/22
 AF 071/25

Korn- und Tupferzangen, Schwammzangen
 Polypus and Dressing Forceps, Sponge Holding Forceps
 Pinzas para pólipos, tapones y esponjas
 Pincas à pansements, à tampons et à éponges
 Pinze per polipi, tamponi e spugne



GROSS-MAIER

- AF 100/20
- AF 100/22
- AF 100/25
- AF 100/27

- 20,0 cm/8"
- 22,0 cm/8³/₄"
- 25,0 cm/10"
- 27,0 cm/10³/₄"

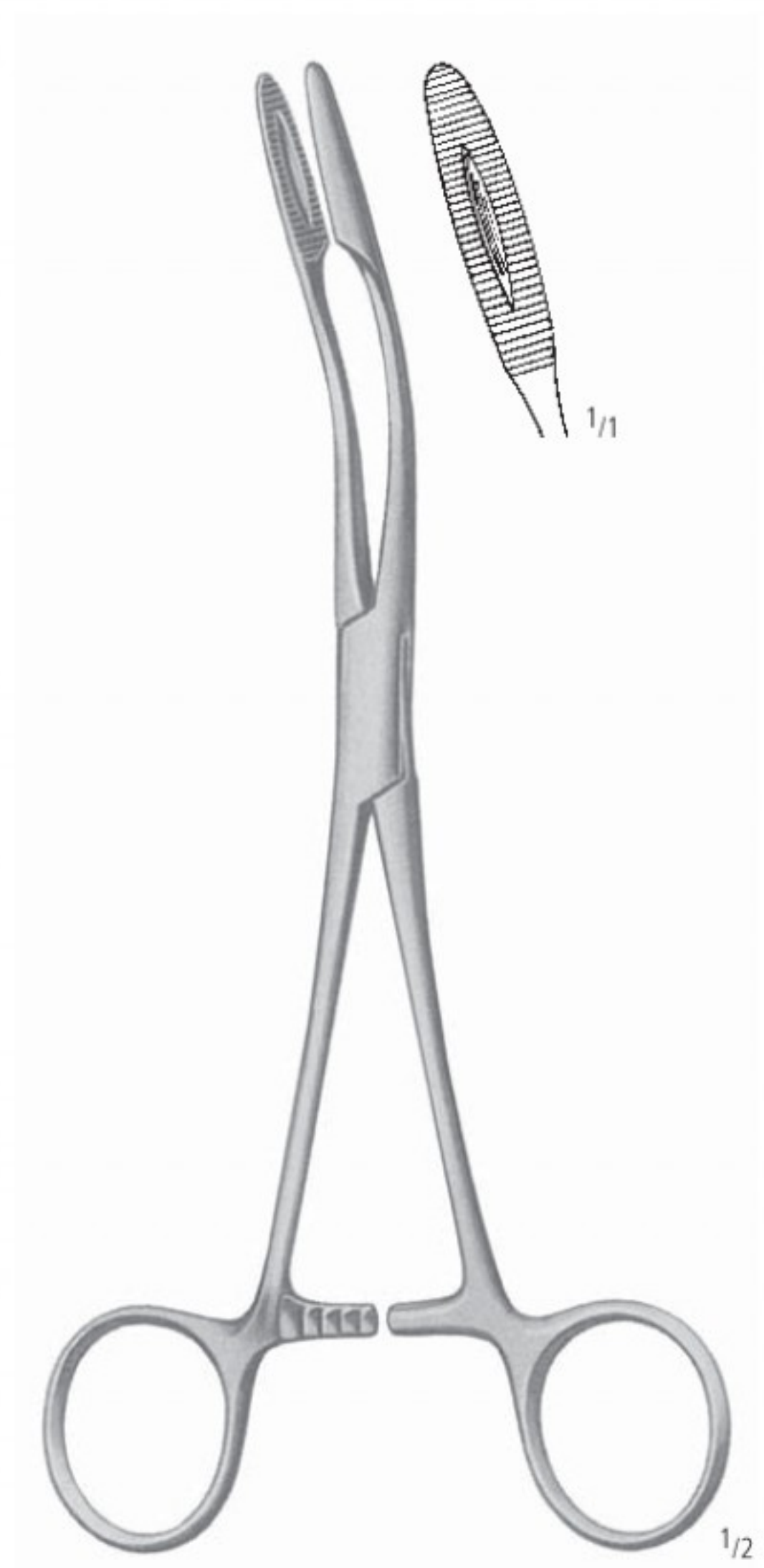

GROSS-MAIER

- AF 101/20
- AF 101/22
- AF 101/25
- AF 101/27

Korn- und Tupferzangen, Schwammzangen
 Polypus and Dressing Forceps, Sponge Holding Forceps
 Pinzas para pólipos, tapones y esponjas
 Pincers à pansements, à tampons et à éponges
 Pinze per polipi, tamponi e spugne

AA

AB

AC

AD

AE

AF

AK

AL

AO

KA

KK

X

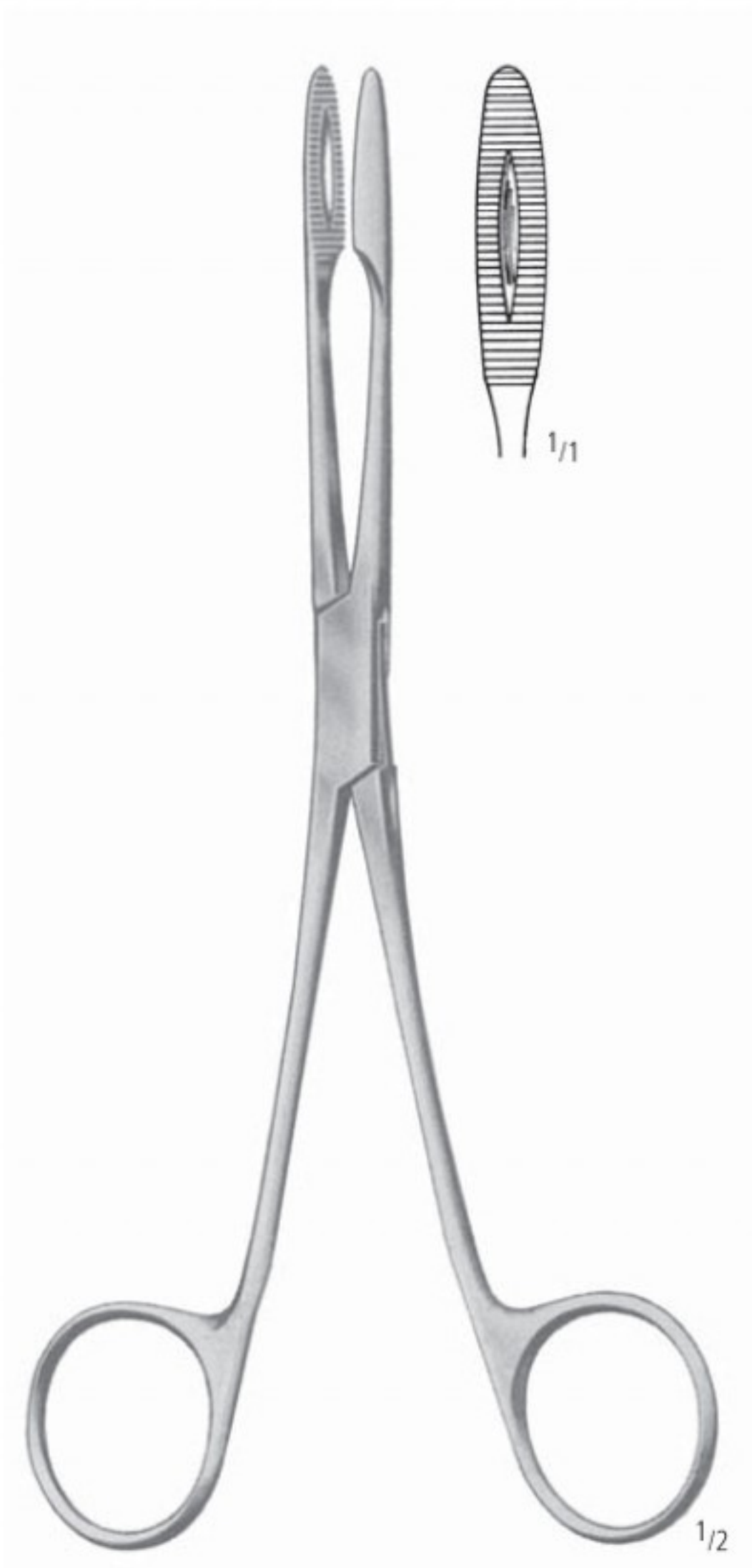

GROSS-MAIER

- AF 102/20
- AF 102/22
- AF 102/25
- AF 102/27

- 20,0 cm/8"
- 22,0 cm/8³/₄"
- 25,0 cm/10"
- 27,0 cm/10³/₄"



GROSS-MAIER

- AF 103/20
- AF 103/22
- AF 103/25
- AF 103/27

Korn- und Tupferzangen, Schwammzangen
 Polypus and Dressing Forceps, Sponge Holding Forceps
 Pinzas para pólipos, tapones y esponjas
 Pincas à pansements, à tampons et à éponges
 Pinze per polipi, tamponi e spugne



FOERSTER-BALLENGER

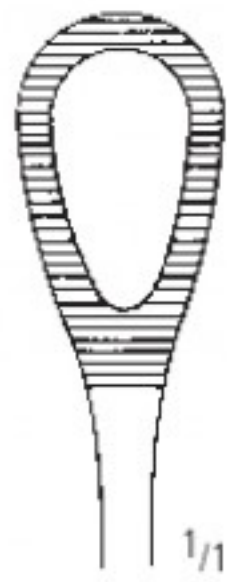

AF 200/18
 AF 200/20

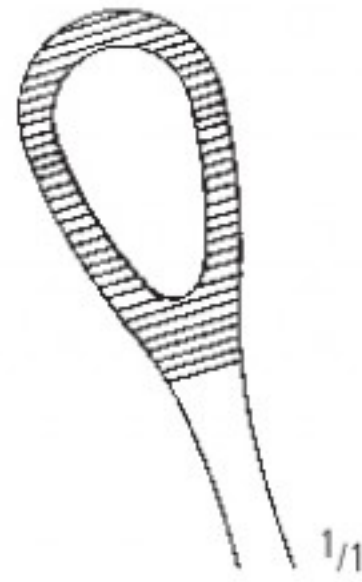

AF 201/18
 AF 201/20

18,0 cm/7"
 20,0 cm/8"



AF 202/18
 AF 202/20

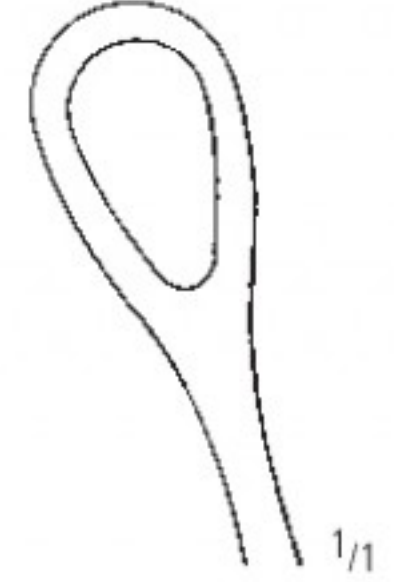

AF 203/18
 AF 203/20



FOERSTER-BALLENGER

25,0 cm/10"



AF 200/25

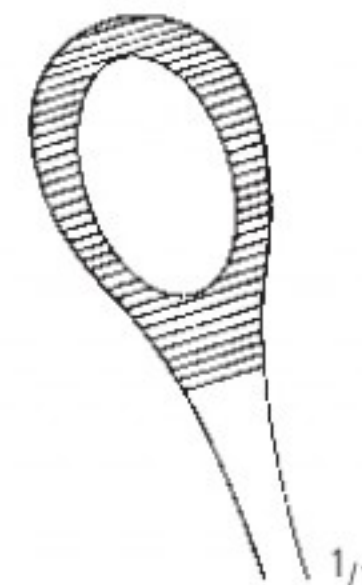

AF 201/25



AF 202/25

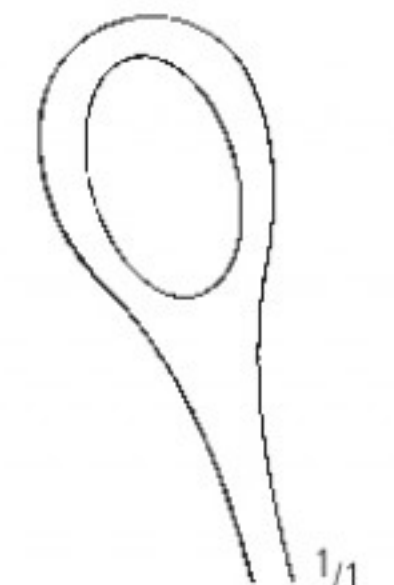

AF 203/25

TUPFERZANGEN SPONGE FORCEPS PINZAS PARA POLIPOS PINCES A PANSEMENTS PINZE PER POLIPI

Korn- und Tupferzangen, Schwammzangen
 Polypus and Dressing Forceps, Sponge Holding Forceps
 Pinzas para pólipos, tapones y esponjas
 Pincers à pansements, à tampons et à éponges
 Pinze per polipi, tamponi e spugne

AA

AB

AC

AD

AE

AF

AK

AL

AO

KA

KK

X

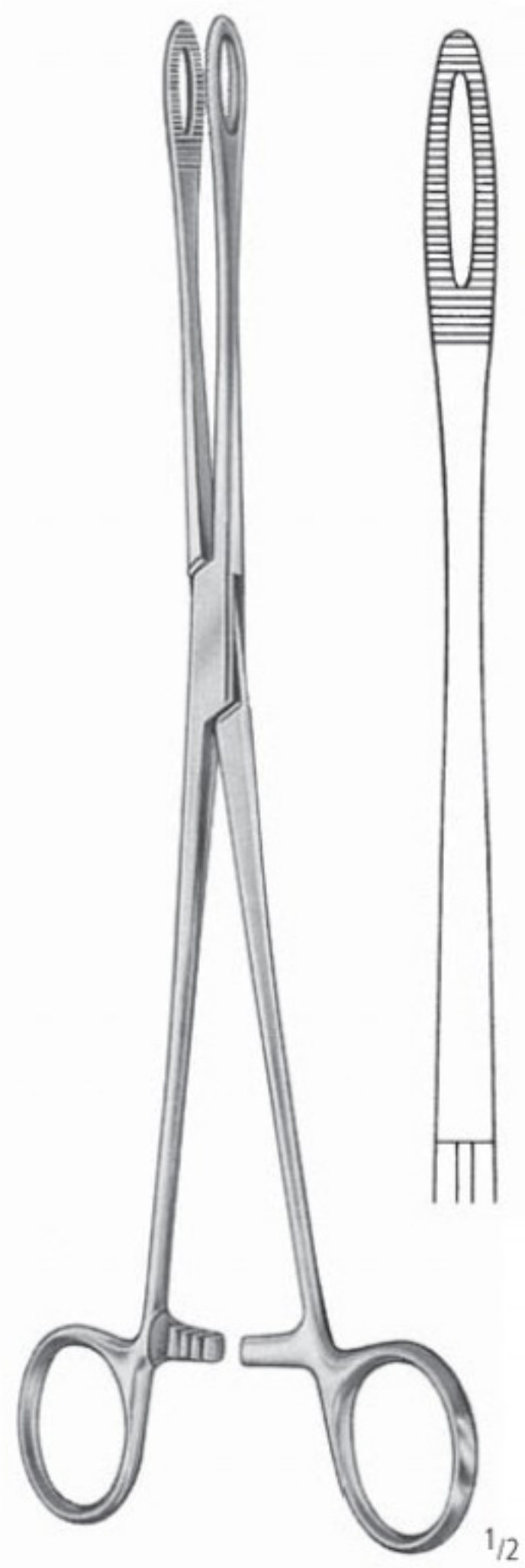

25,0 cm/10"



AF 210/25

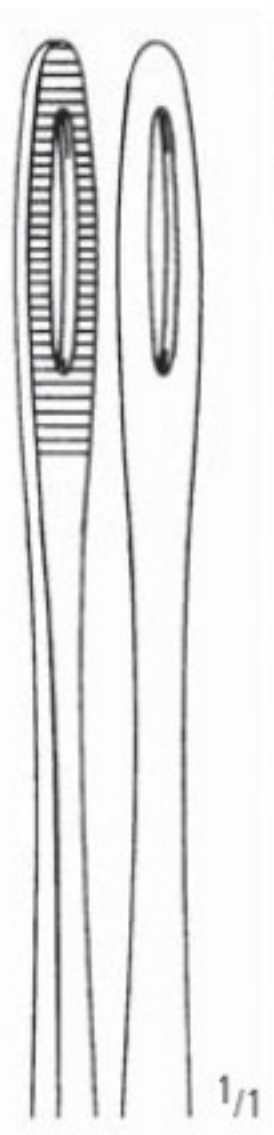

AF 211/25

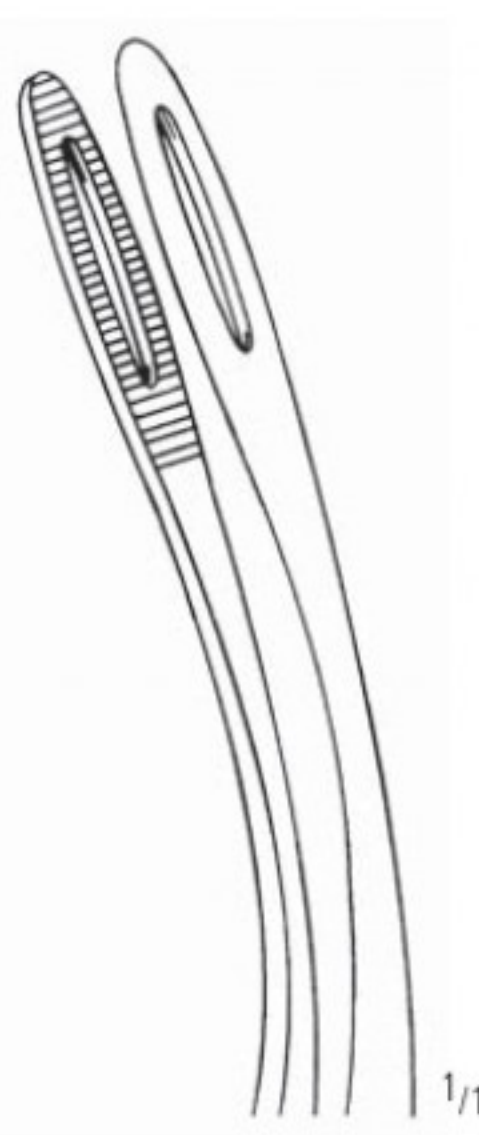

RAMPLEY



AF 216/18
18,0 cm/7"



AF 216/25
25,0 cm/10"

WUNDHAKEN
RETRACTORS
SEPARADORES
ECARTEURS
DIVARICATORI

AK

nopa[®] instruments

Weitere Wundhaken finden Sie in unserem Katalog "Allgemeine Chirurgie" in Gruppe AK.

For further retractors kindly refer to our catalogue "General Surgery", section AK.

Para separadores, por favor consulte nuestro catálogo de "Cirugía general", grupo AK.

Pour des ecarteurs, consultez notre catalogue "Chirurgie Generale", section AK.

Per gli altri divaricatori, consultare il nostro catalogo "Chirurgia Generale", gruppo AK.



AK WUNDHAKEN RETRACTORS SEPARADORES ECARTEURS DIVARICATORI

Feine Wundhaken
Delicate Hooks
Ganchos
Crochets très fins
Divaricatori sottili



CUSHING
28,0 cm/11"



AK 034/01



AK 034/02



CUSHING
19,0 cm/7¹/₂"



AK 036/01



AK 036/02

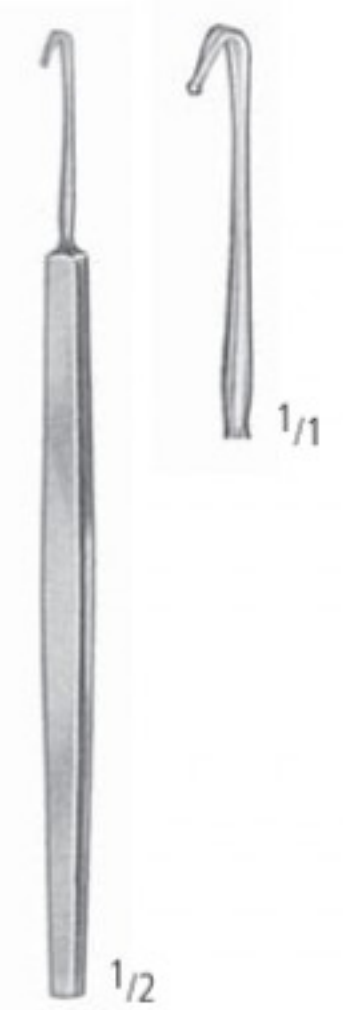

MOLDESTAD
AK 038/13
13,0 cm/5"



AK 040/05
5 mm



AK 040/07
7 mm

17,0 cm/6³/₄"



AK 042/10
Ø 1,0 mm



AK 042/12
Ø 1,2 mm

18,5 cm/7¹/₃"

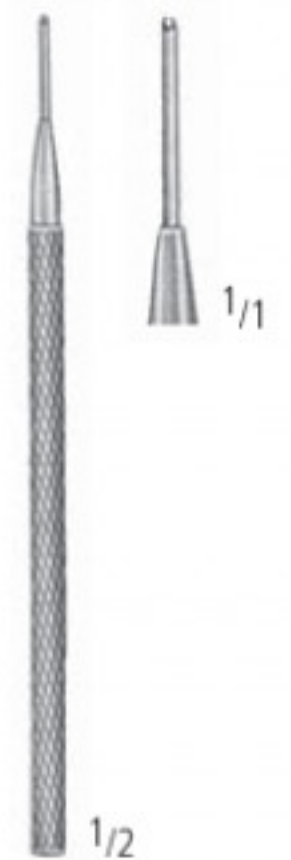

AK 044/11
11,0 cm/4¹/₃"

WUNDHAKEN RETRACTORS SEPARADORES ECARTEURS DIVARICATORI

Feine Wundhaken
Delicate Hooks
Ganchos
Crochets très fins
Divaricatori sottili

AA

AB

AC

AD

AE

AF

AK

AL

AO

KA

KK

X



1/2

MEYERDING
18,0 cm/7"



1/1

AK 080/01
18 x 7 mm



1/1

AK 080/02
16 x 5 mm



1/1

AK 080/03
7 x 4 mm



1/1

AK 080/04
10 x 3 mm



1/1

AK 080/05
7 x 4 mm



1/1

AK 080/06
4 x 10 mm



1/2

SENN-GREEN
15,0 cm/6"



1/1

AK 082/10
10 x 6 mm



1/1

AK 082/20
22 x 8 mm



1/2

MINI-LANGENBECK
16,0 cm/6 1/4"



1/1

AK 086/10
10 x 6 mm



1/1

AK 086/17
17 x 5 mm



1/1

AK 086/20
20 x 6 mm



1/1

AK 086/22
22 x 8 mm

AK WUNDHAKEN RETRACTORS SEPARADORES ECARTEURS DIVARICATORI

Feine Wundhaken
Delicate Hooks
Ganchos
Crochets très fins
Divaricatori sottili



-  $\frac{1}{1}$
AK 090/08
8 mm
-  $\frac{1}{1}$
AK 090/12
12 mm
-  $\frac{1}{1}$
AK 090/16
16 mm

DESMARRES
13,0 cm/5"



-  $\frac{1}{1}$
AK 092/08
8 mm
-  $\frac{1}{1}$
AK 092/12
12 mm
-  $\frac{1}{1}$
AK 092/16
16 mm

DESMARRES
16,0 cm/6 $\frac{1}{4}$ "



-  $\frac{1}{1}$
AK 090/08
8 mm
-  $\frac{1}{1}$
AK 090/12
12 mm
-  $\frac{1}{1}$
AK 090/16
16 mm



-  $\frac{1}{1}$
AK 092/08
8 mm
-  $\frac{1}{1}$
AK 092/12
12 mm
-  $\frac{1}{1}$
AK 092/16
16 mm



-  $\frac{1}{1}$
AK 100/08
8 mm
-  $\frac{1}{1}$
AK 100/12
12 mm
-  $\frac{1}{1}$
AK 100/16
16 mm

CUSHING
20,0 cm/8"



-  $\frac{1}{1}$
AK 102/08
8 mm
-  $\frac{1}{1}$
AK 102/12
12 mm
-  $\frac{1}{1}$
AK 102/16
16 mm

CUSHING
24,0 cm/9 $\frac{1}{2}$ "

WUNDHAKEN RETRACTORS SEPARADORES ECARTEURS DIVARICATORI

Feine Wundhaken
Delicate Hooks
Ganchos
Crochets très fins
Divaricatori sottili

AA
AB
AC
AD
AE
AF
AK
AL
AO
KA
KK
X

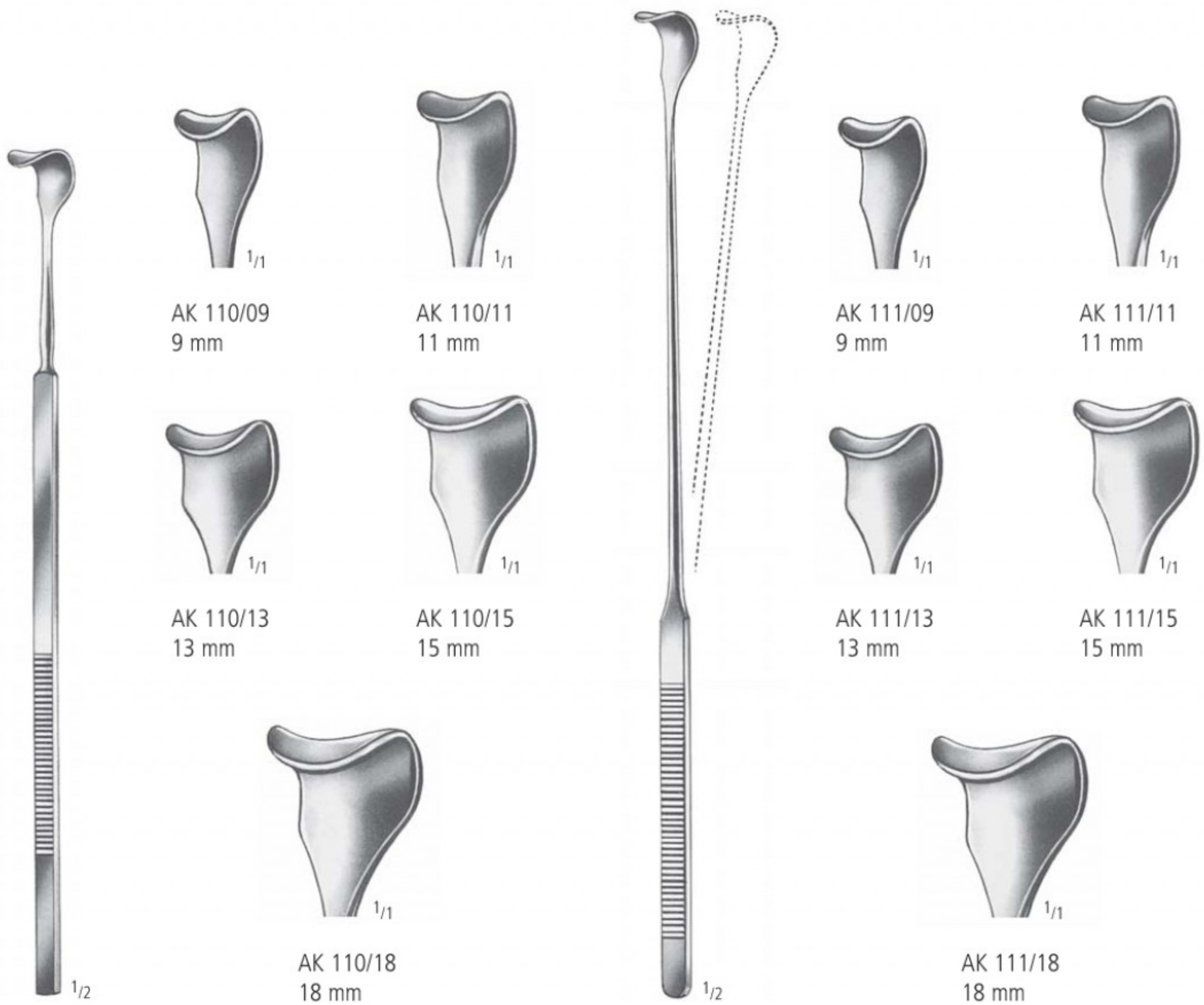

GIL-VERNET
24,5 cm/9³/₄"

GIL-VERNET
28,0 cm/11"

AK WUNDHAKEN RETRACTORS SEPARADORES ECARTEURS DIVARICATORI

Feine Wundhaken, Spinalhaken
 Delicate Retractors, Spinal Retractors
 Separadores finas, Separadores espinales
 Ecarteurs fins, Ecarteurs spinals
 Divaricatori sottili, Divaricatori spinali



BABY-SENN-MILLER
 15,0 cm/6"



SENN-MILLER
 16,0 cm/6 1/4"



RAGNELL-DAVIS
 AK 125/14
 14,0 cm/5 1/2"



CUSHING
 AK 130/20
 20,0 cm/8"



TAYLOR
 16,5 cm/6 1/2"



AK 132/10
 100 x 30 mm

WUNDHAKEN RETRACTORS SEPARADORES ECARTEURS DIVARICATORI

AA
AB
AC
AD
AE
AF
AK
AL
AO
KA
KK
X



1/2

VOLKMANN
21,5 cm/8 1/2"

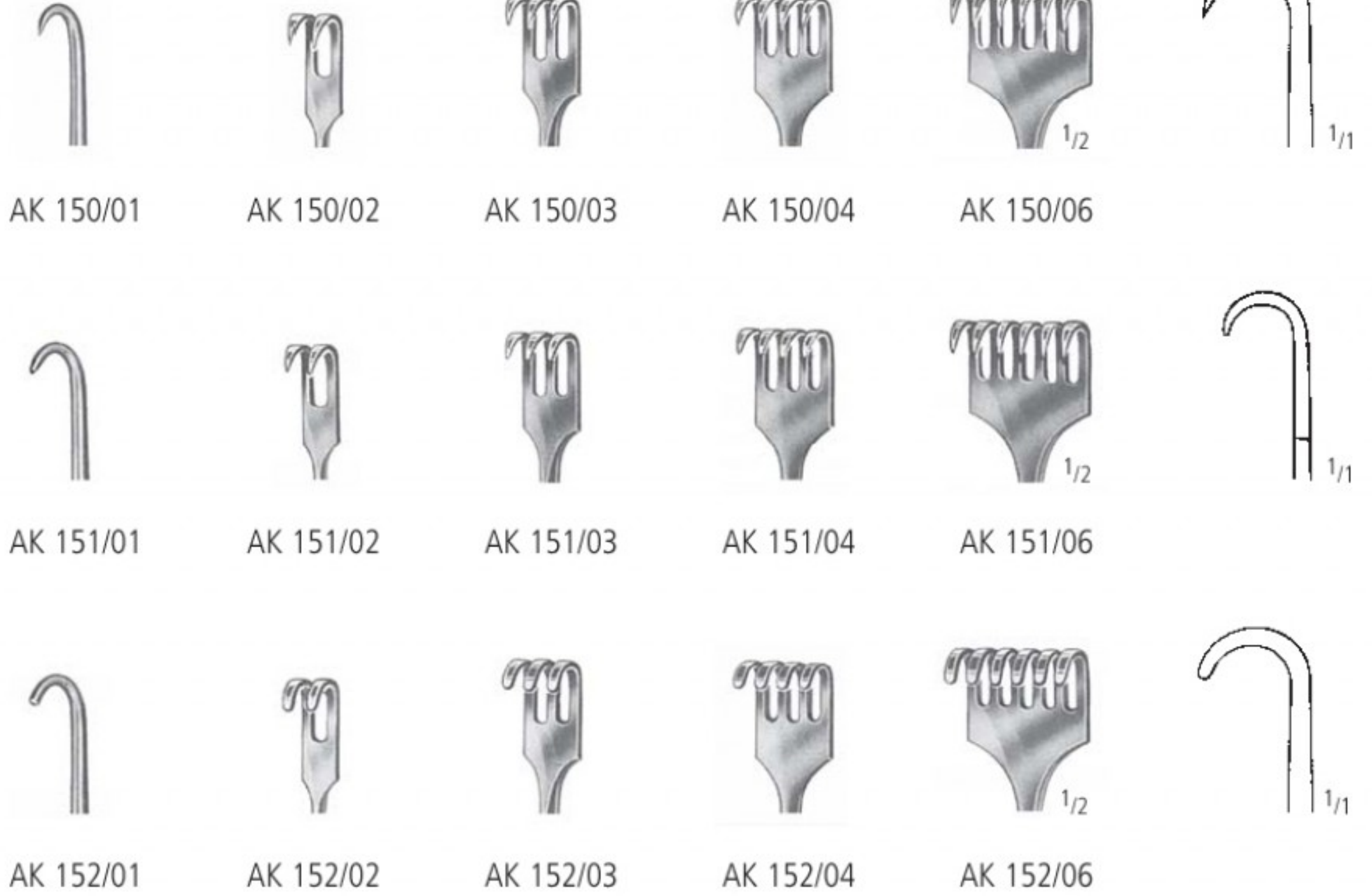

1/2

KOCHER
22,0 cm/8 3/4"





1/2

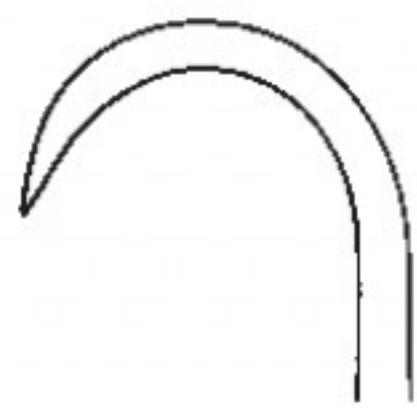

1/1

AK 170/21

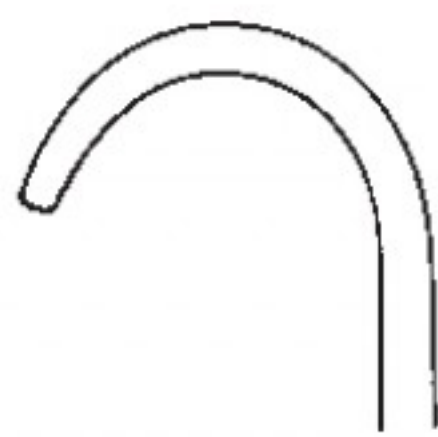

1/1

AK 171/21

VOLKMANN
21,5 cm/8 1/2"



1/2

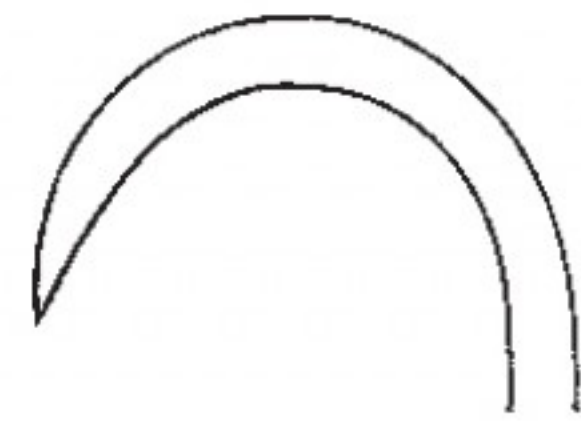

1/1

AK 172/20
20,0 cm/8"

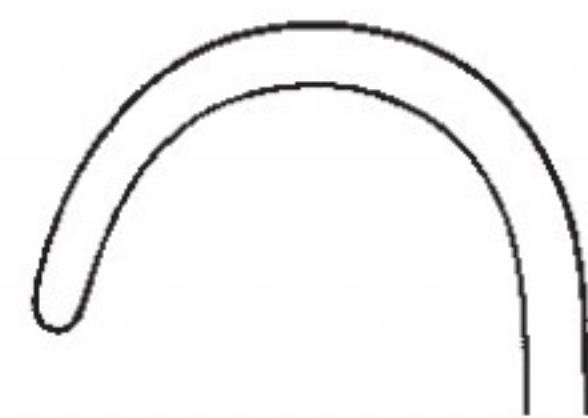

1/1

AK 173/20
20,0 cm/8"



1/2

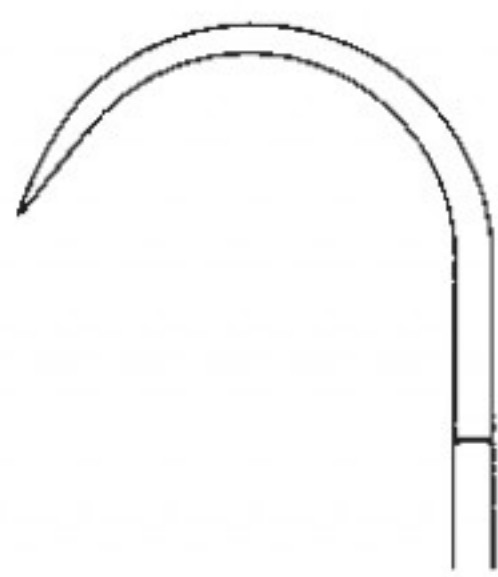

1/1

AK 180/08
26 x 40 mm

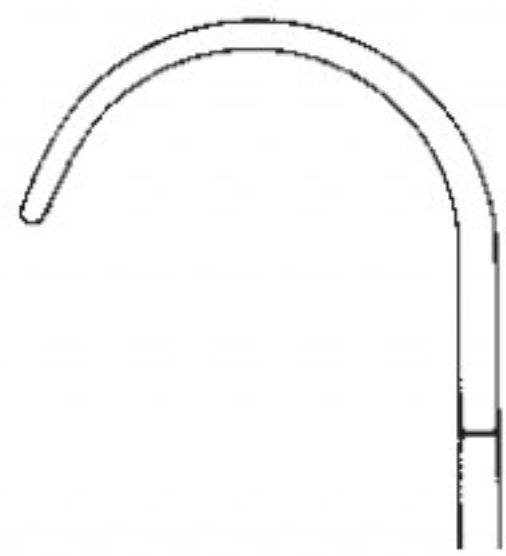

1/1

AK 181/08
26 x 40 mm

KOERTE
24,0 cm/9 1/2"



1/2



1/1

AK 185/35
35 x 40 mm



1/1

AK 185/43
43 x 35 mm



1/1

AK 185/45
45 x 50 mm

BILLROTH
25,0 cm/10"

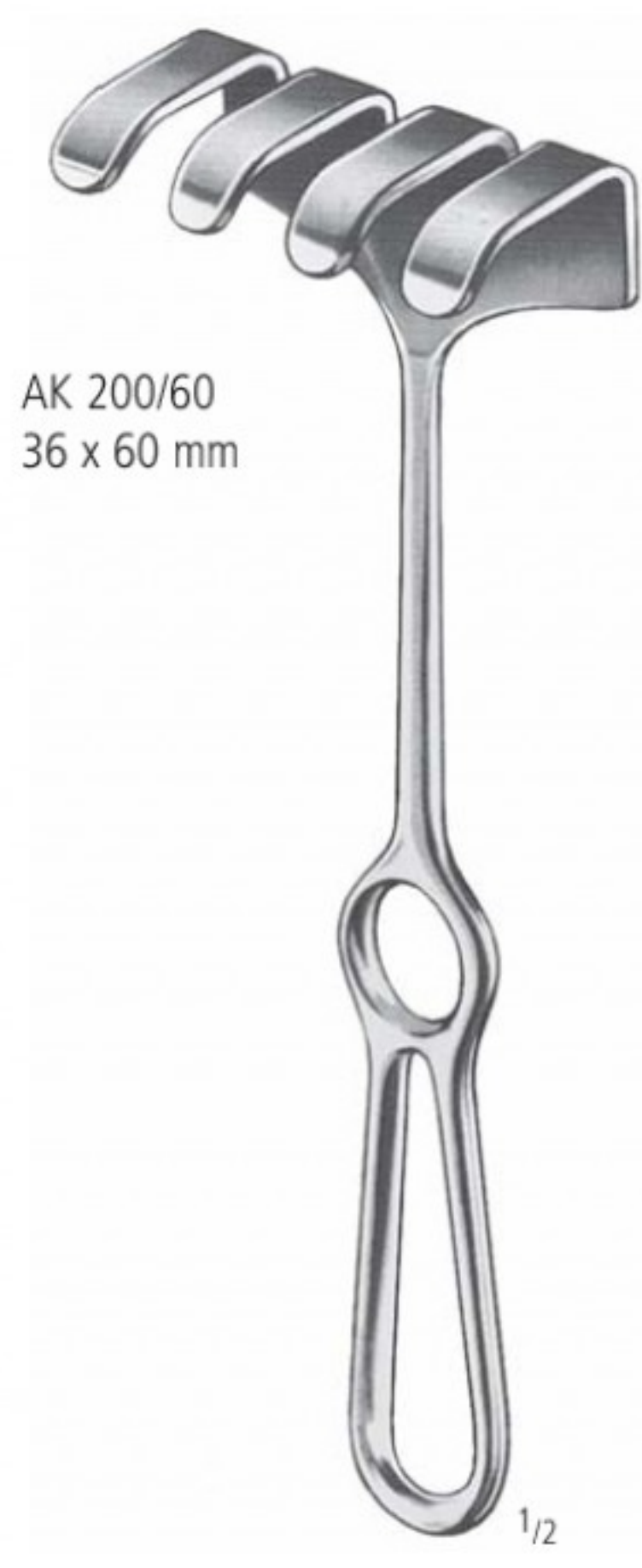

OLLIER
22,5 cm/9"



ISRAEL
25,0 cm/10"



AK 210/40
40 x 40 mm

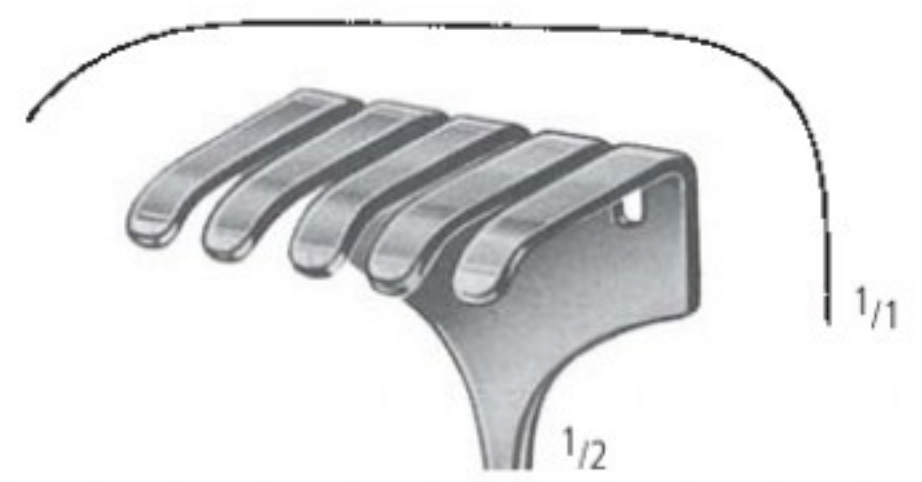

AK 210/50
45 x 50 mm

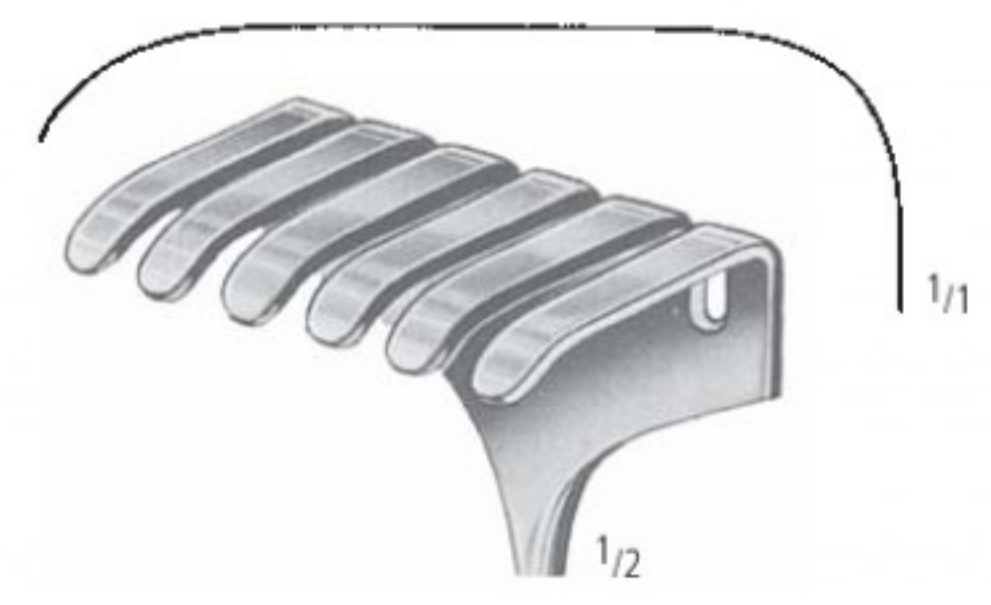

AK 210/60
50 x 60 mm

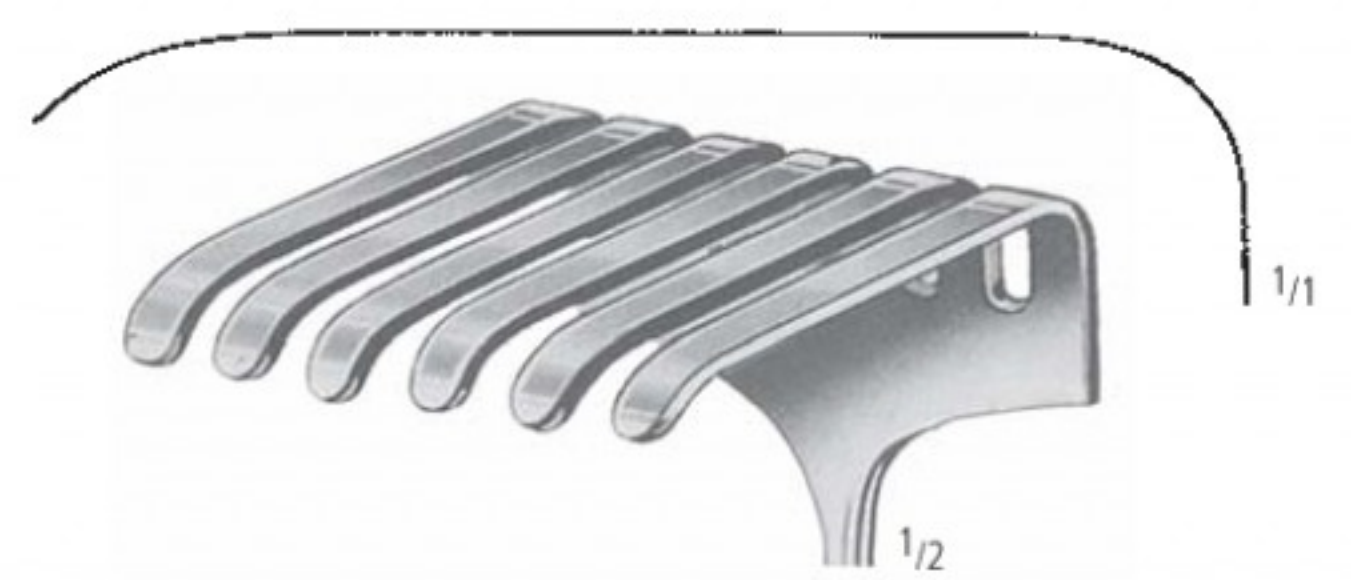

AK 210/70
70 x 70 mm



LANGENBECK
21,0 cm/8¹/₄"

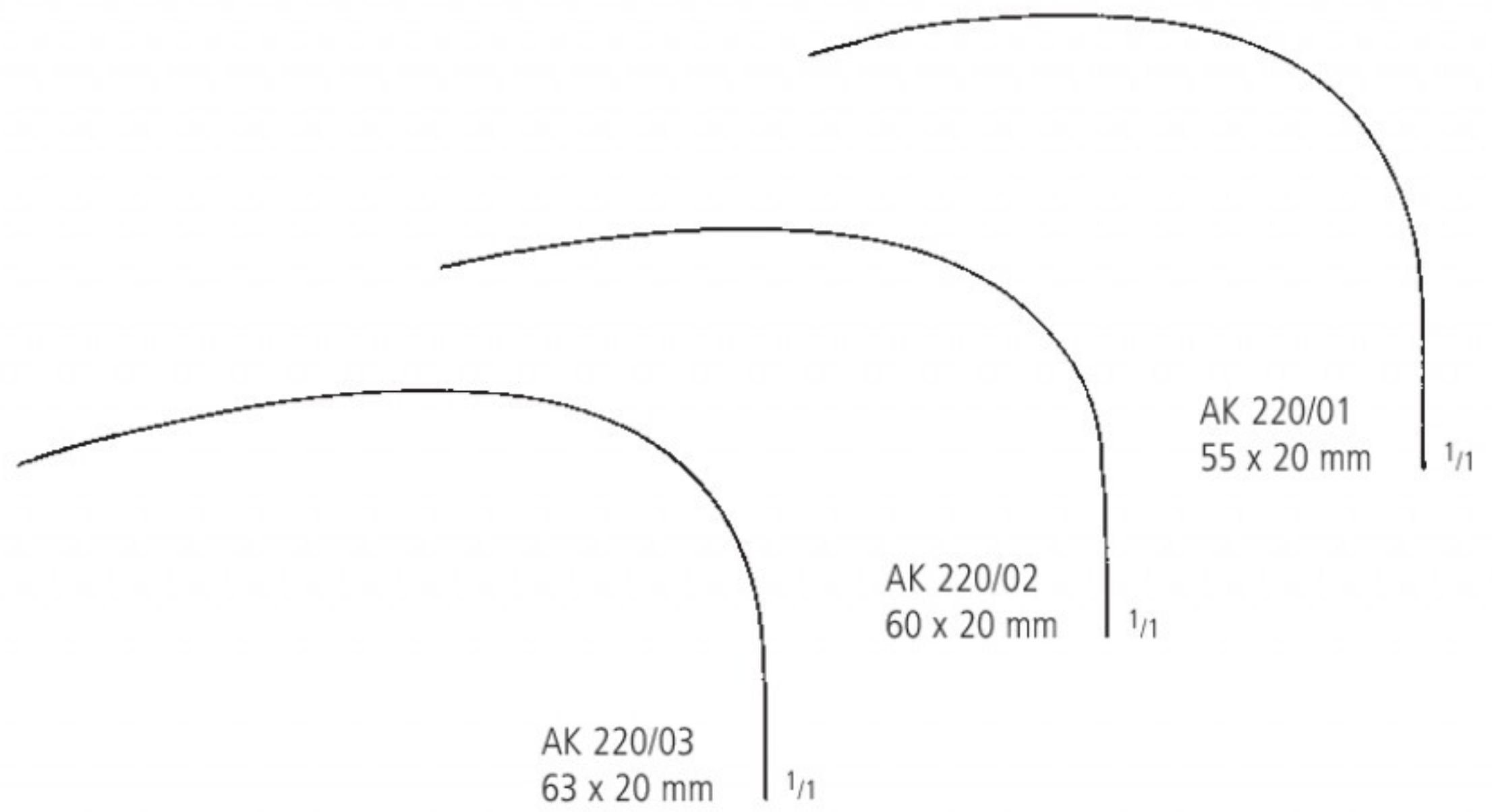

AK 220/01
55 x 20 mm ¹/₁

AK 220/02
60 x 20 mm ¹/₁

AK 220/03
63 x 20 mm ¹/₁



LANGENBECK
AK 230/01-05
22,0 cm/8³/₄"



AK 230/01
AK 231/01
30 x 11 mm



AK 230/02
AK 231/02
30 x 14 mm



AK 230/03
AK 231/03
30 x 16 mm



AK 230/04
AK 231/04
40 x 11 mm



AK 230/05
AK 231/05
50 x 11 mm



LANGENBECK
AK 231/01-05
22,0 cm/8³/₄"



KOCHER-LANGENBECK
21,5 cm/8½"



AK 233/01
25 x 6 mm



AK 233/02
35 x 8 mm



AK 233/03
35 x 11 mm



AK 233/04
35 x 15 mm



AK 233/05
40 x 11 mm



AK 233/06
55 x 11 mm



AK 233/07
70 x 14 mm



AK 233/08
80 x 12 mm



AK 233/09
80 x 16 mm



KOCHER
23,0 cm/9"

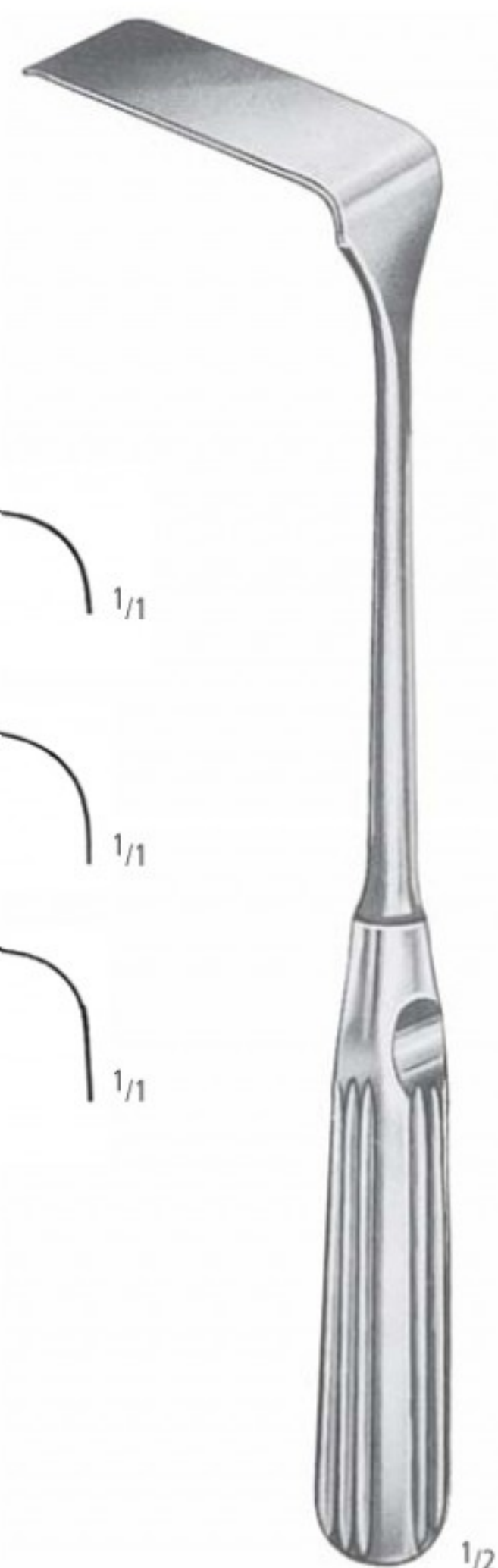
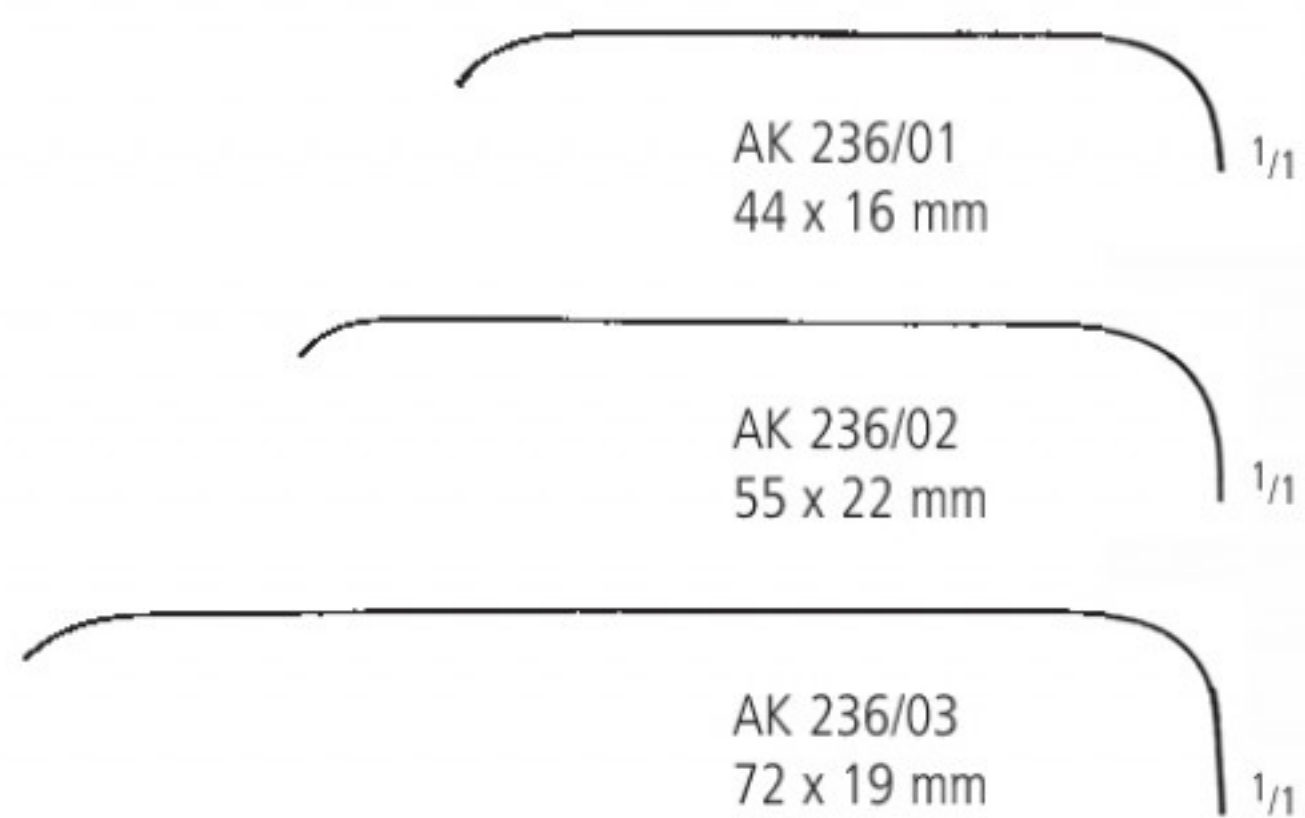
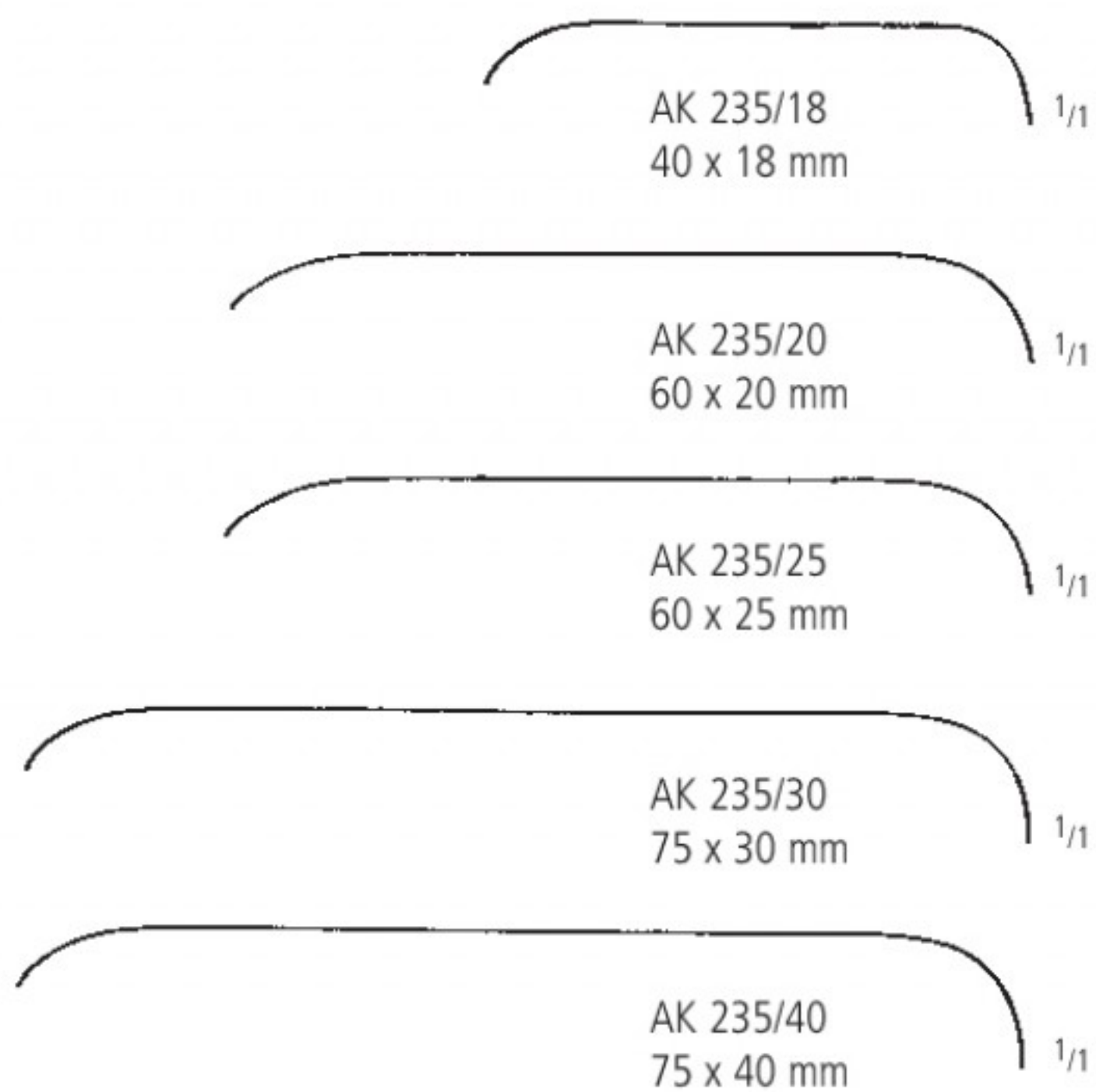

SAUERBRUCH
22,5 cm/8³/₄"

AA

AB

AC

AD

AE

AF

AK

AL

AO

KA

KK

X



AK 237/01
50 x 55 mm

MORRIS
26,0 cm/10¹/₂"



AK 237/02
70 x 40 mm

AK 237/03
70 x 50 mm

AK 237/04
70 x 65 mm

MORRIS
25 cm/10"



60 x 50 mm

60 x 45 mm

MORRIS
AK 238/24
25,0 cm/10"



AA

AB

AC

AD

AE

AF

AK

AL

AO

KA

KK

X

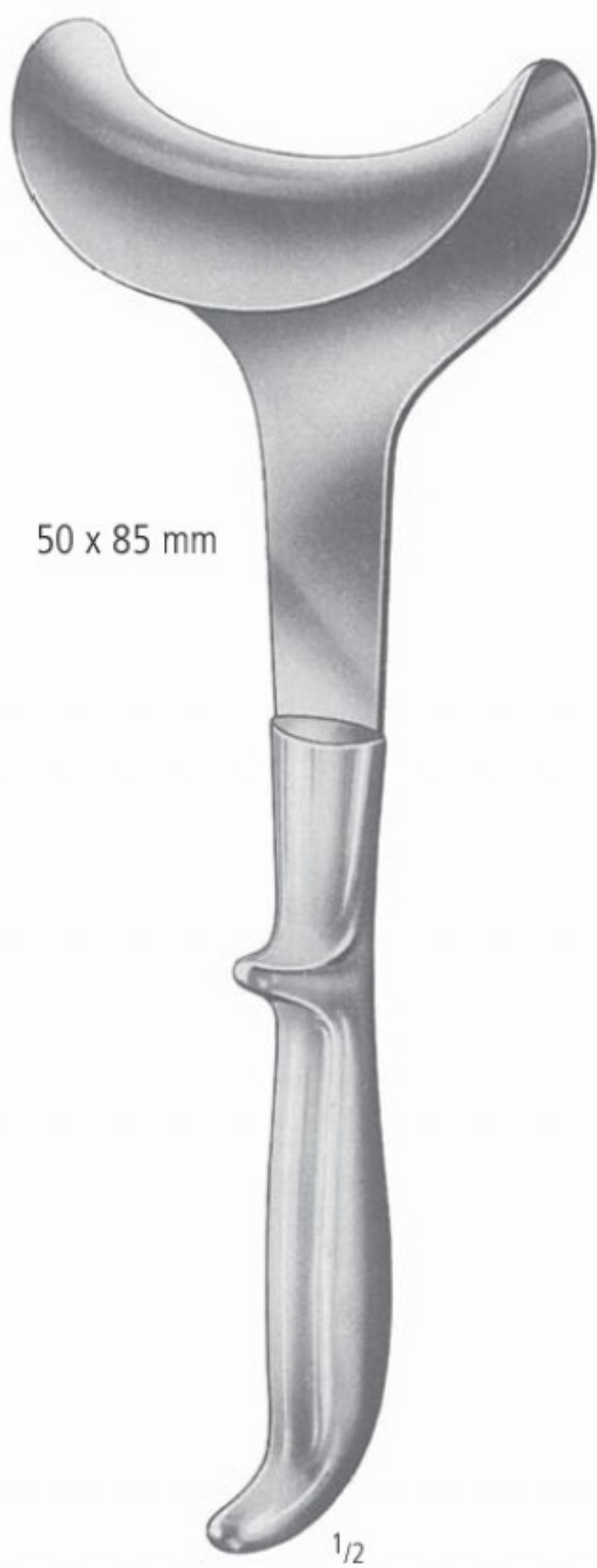
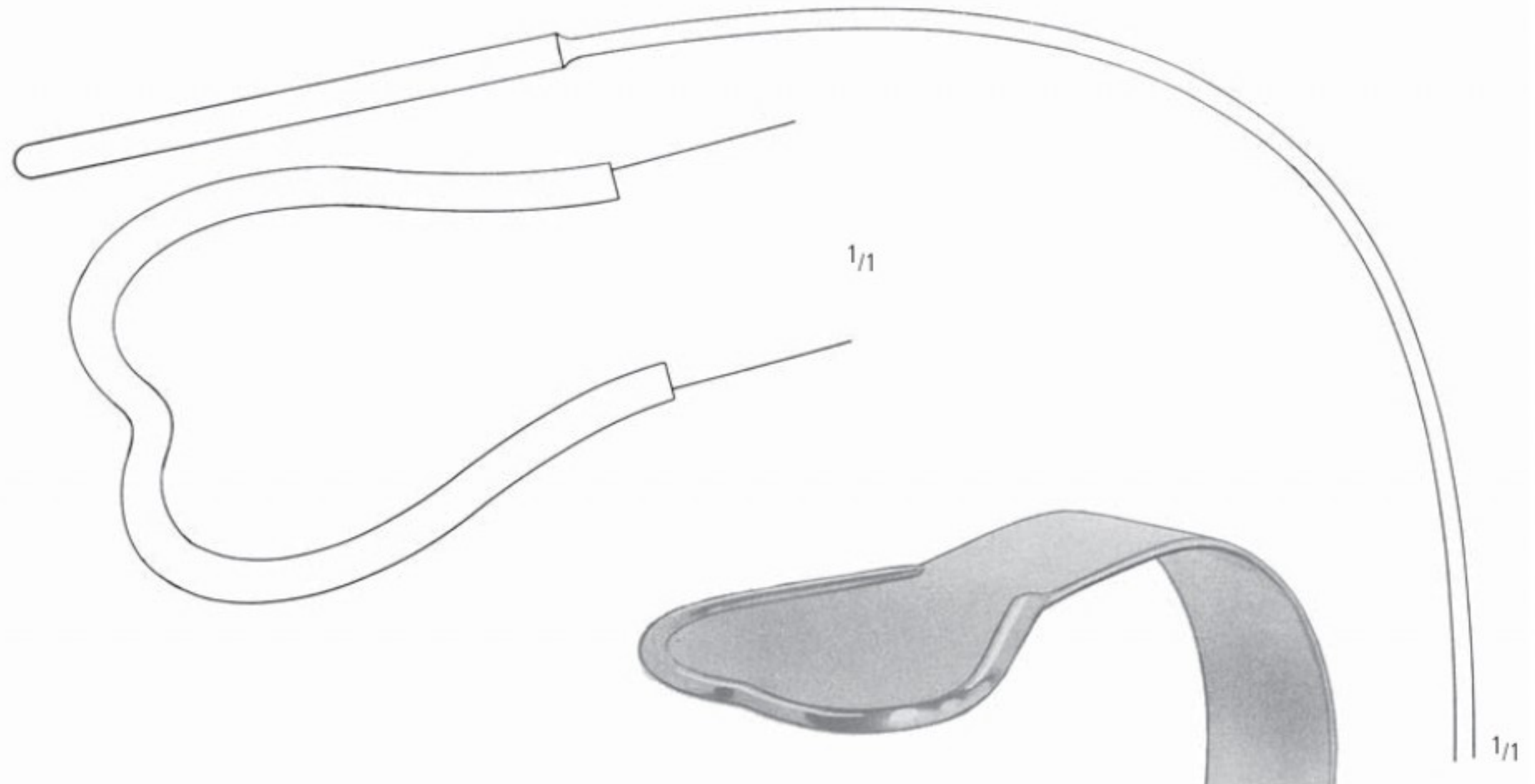

50 x 85 mm

DOYEN
AK 280/25
25,0 cm/10"

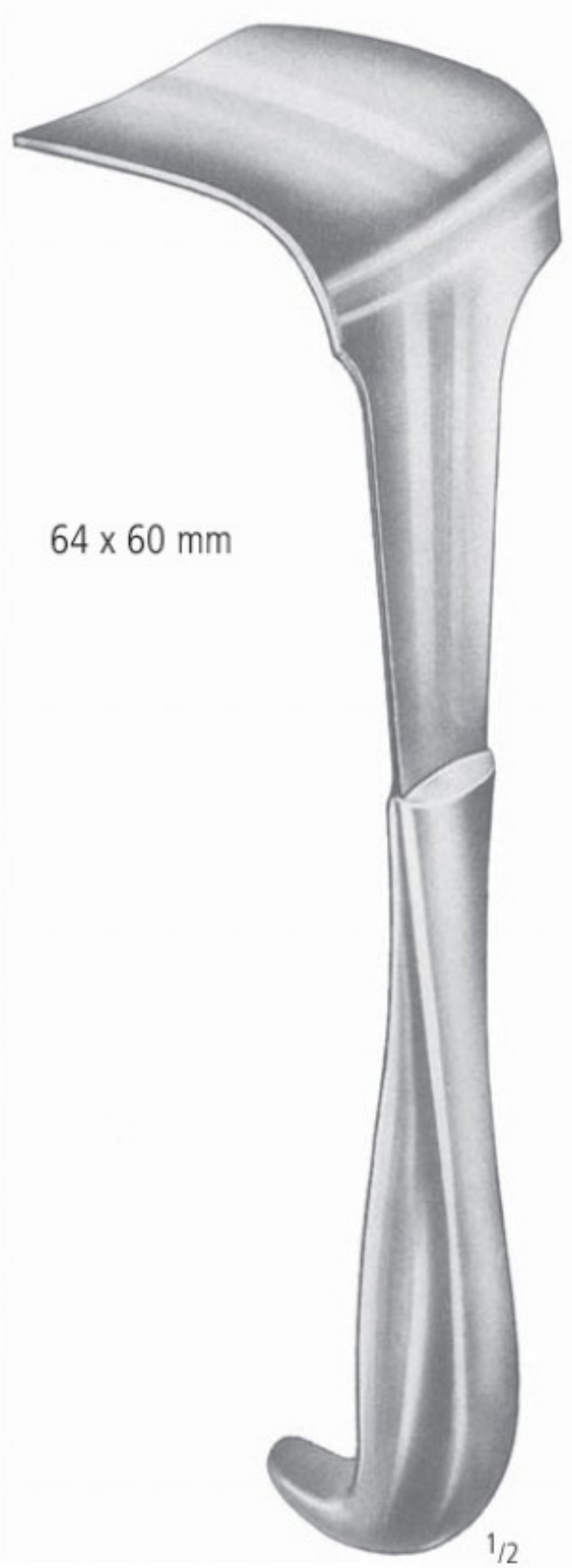

64 x 60 mm

TUFFIER
AK 282/23
23,0 cm/9"



HARRINGTON
32,0 cm/12³/₄"
127 x 40 mm AK 284/40
127 x 62 mm AK 284/62
175 x 64 mm AK 284/64



90 x 50 mm

MIKULICZ
AK 286/26
26,0 cm/10¹/₂"

MIKULICZ
26,0 cm/10¹/₂"
85 x 35 mm AK 290/01
120 x 50 mm AK 290/02
155 x 50 mm AK 290/03

KELLY
27,0 cm/10³/₄"
160 x 38 mm AK 292/01
160 x 57 mm AK 292/02
190 x 38 mm AK 292/03
190 x 57 mm AK 292/04



DEAVER
AK 300/01
18,0 cm/7"

DEAVER
AK 300/02
21,5 cm/8¹/₂"

DEAVER
AK 300/03
23,0 cm/9"

DEAVER
AK 300/04
30,0 cm/12"

DEAVER
AK 300/05
33,0 cm/13"

DEAVER
AK 300/06
36,0 cm/14"



DEAVER
AK 300/07
30,0 cm/12"



DEAVER
AK 300/08
30,0 cm/12"



DEAVER
AK 300/09
30,0 cm/12"



DEAVER
AK 310/01-05

	B	L	
Fig. 1	25 mm	30,5 cm/12"	AK 310/01
Fig. 2	25 mm	33,0 cm/13"	AK 310/02
Fig. 3	38 mm	30,5 cm/12"	AK 310/03
Fig. 4	50 mm	30,5 cm/12"	AK 310/04
Fig. 5	75 mm	30,5 cm/12"	AK 310/05



KOERTE
AK 312/28
28,0 cm / 11"

fest
rigid
rigida
rigide
rigide

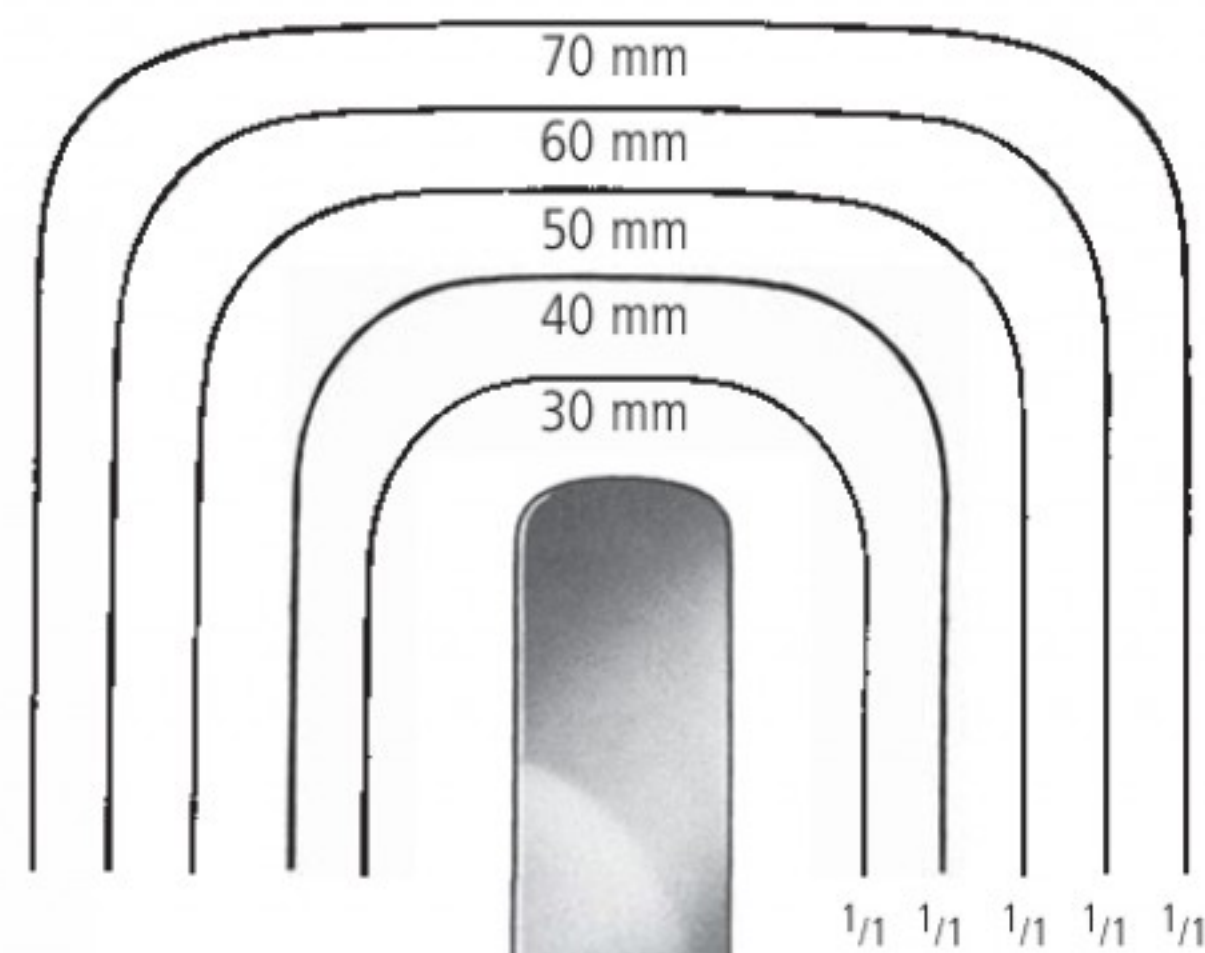

biegsam
malleable
maleable
malléable
malleabile

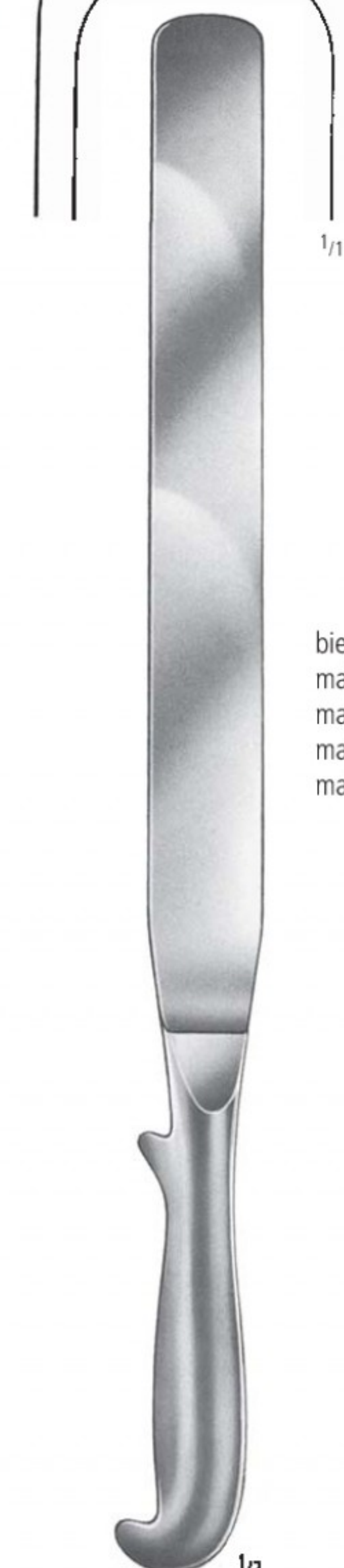

245 x 30 mm	AK 315/30	
245 x 40 mm	AK 315/40	
245 x 50 mm	AK 315/50	
245 x 60 mm	AK 315/60	
245 x 70 mm	AK 315/70	

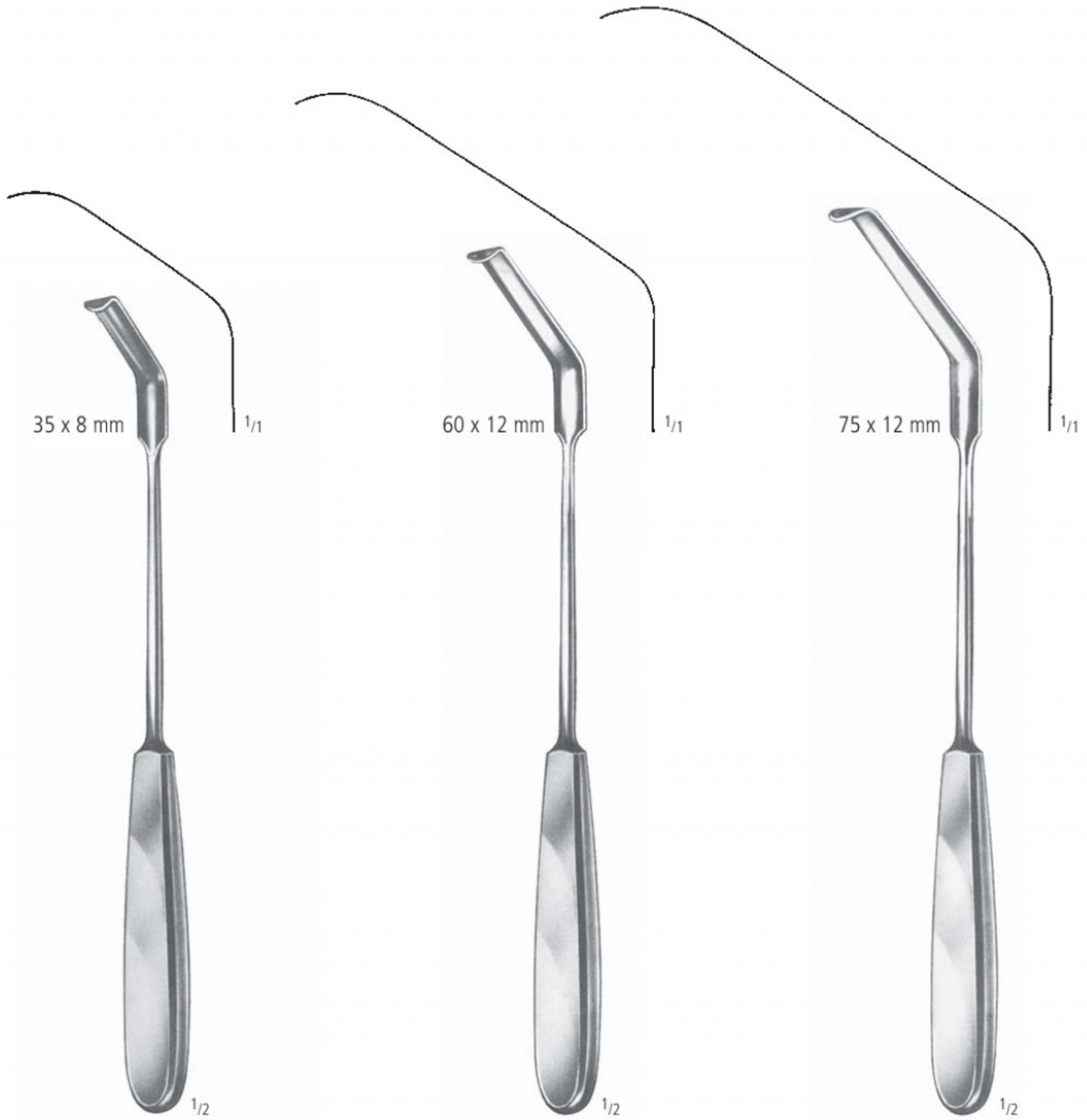

ZENKER
AK 318/35
25,0 cm/10"

ZENKER
AK 318/60
26,0 cm/10¹/₂"

ZENKER
AK 318/75
27,5 cm/10³/₄"

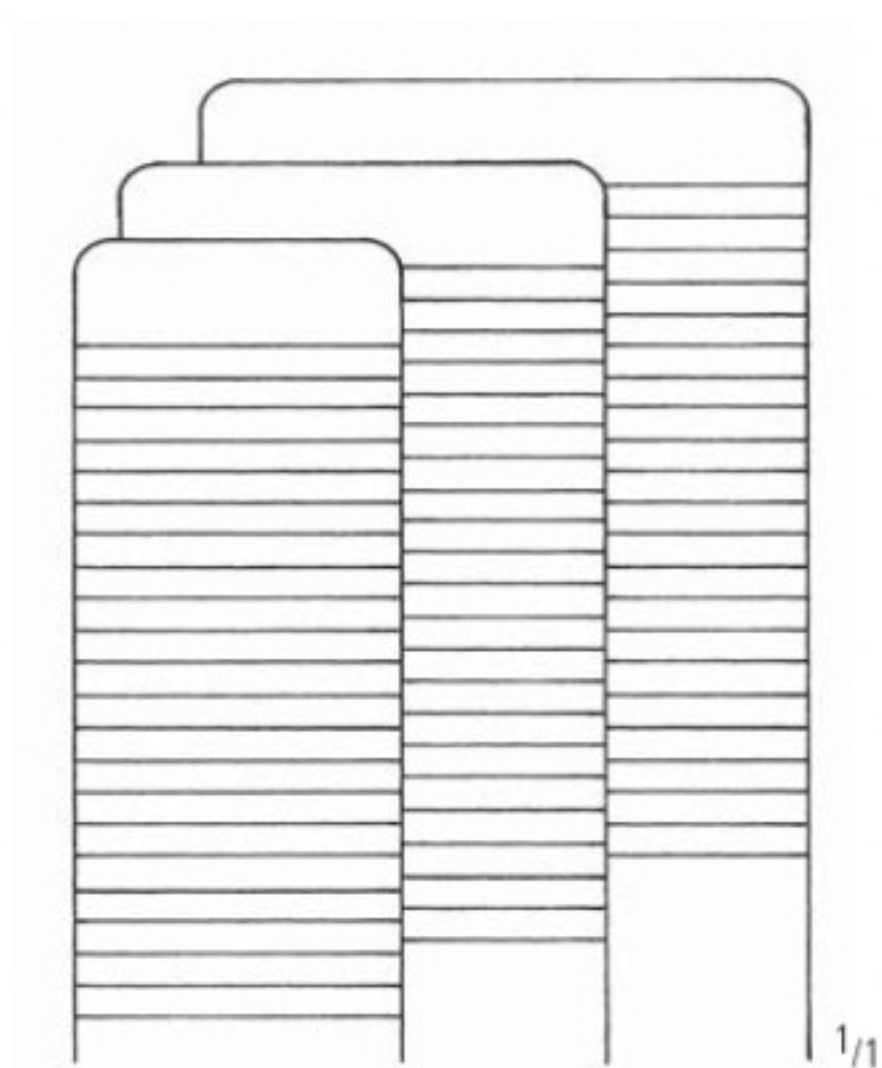

AK 325/20
 — 20 mm —
 AK 325/30
 — 30 mm —
 AK 325/40
 — 40 mm —

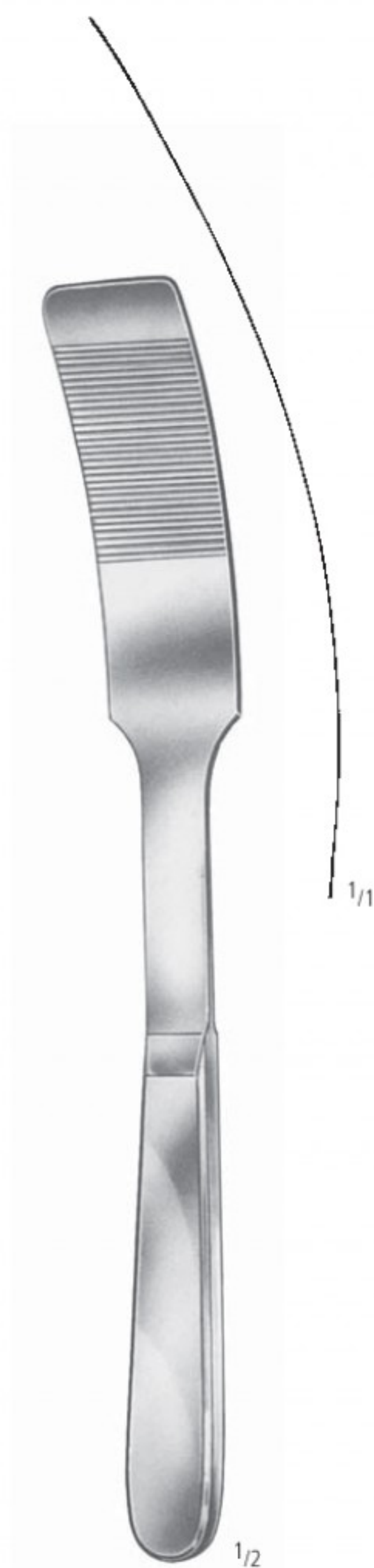

KADER
 27,0 cm/10³/₄"



CORYLLOS
24,0 cm/9¹/₂"



SAUERBRUCH
AK 330/25
25,0 cm/10"

AA

AB

AC

AD

AE

AF

AK

AL

AO

KA

KK

X



75 x 50 mm

DAVIDSON
AK 337/50
16,0 cm/6¹/₄"



75 x 90 mm

DAVIDSON
AK 337/90
16,0 cm/6¹/₄"

AK WUNDHAKEN RETRACTORS SEPARADORES ECARTEURS DIVARICATORI

Selbsthaltende Wundsperrer
Selfretaining Retractors
Separadores autoestaticos
Ecarteurs autostatiques
Divaricatori autostatici

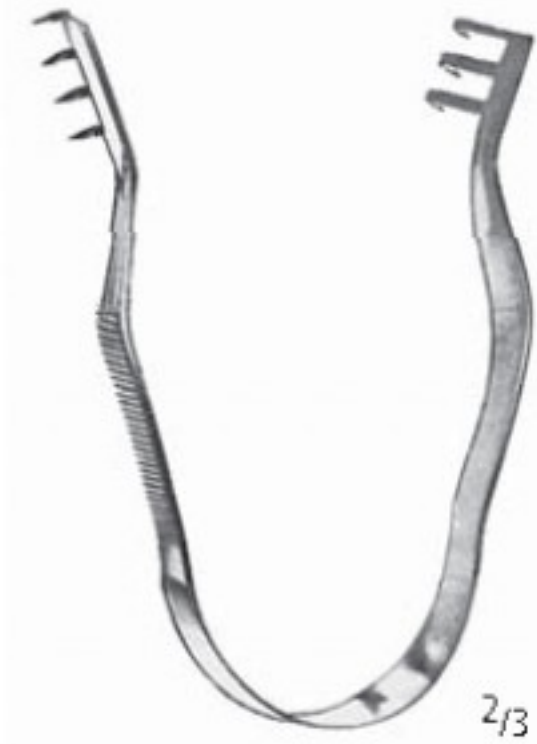

FINSEN

	^	
5,0 cm/2"	AK 500/05	AK 501/05
7,0 cm/2 ³ / ₄ "	AK 500/07	AK 501/07



	^	∩
AK 502/10		AK 503/10
	10,0 cm/4"	

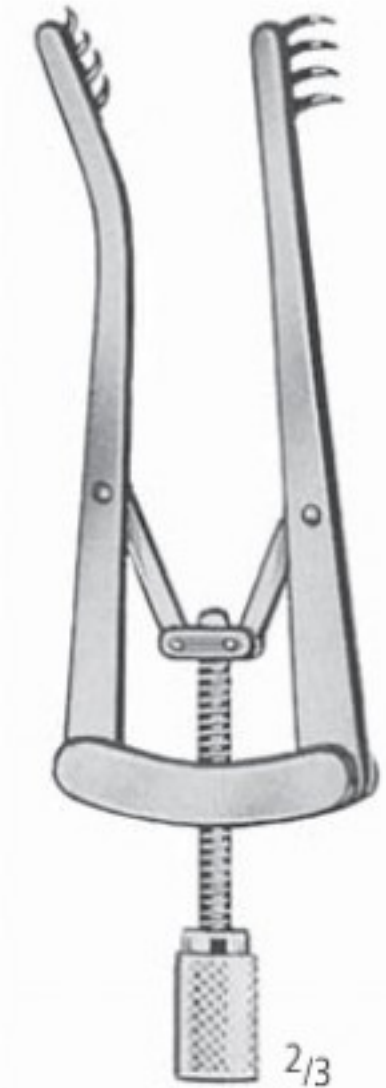

ALM

	^	∩
7,0 cm/2 ³ / ₄ "	AK 506/07	AK 507/07
10,0 cm/4"	AK 506/10	AK 507/10



JANSEN

	^	∩
AK 510/10		AK 511/10
	10,0 cm/4"	



JANSEN

	^	∩
AK 512/10		AK 513/10
	10,0 cm/4"	



SNITMAN

	^	∩
AK 514/10		AK 515/10
	10,5 cm/4 ¹ / ₄ "	

Selbsthaltende Wundsperrer
Selfretaining Retractors
Separadores autoestaticos
Ecarteurs autostatiques
Divaricatori autostatici

WEITLANER



WEITLANER-BABY
AK 519/14
14,0 cm/5¹/₂"



WEITLANER
AK 520/13 AK 521/13
13,0 cm/5"



WEITLANER

10,5 cm/4¹/₄"
13,0 cm/5"
16,5 cm/6¹/₂"
20,0 cm/8"
25,0 cm/10"
26,0 cm/10¹/₂"

2 x 3
3 x 4
3 x 4
3 x 4
3 x 4
5 x 6

AK 522/10
AK 524/13
AK 526/16
AK 528/20
AK 530/25
AK 532/26

AK 523/10
AK 525/13
AK 527/16
AK 529/20
AK 531/25
AK 533/26

AK WUNDHAKEN RETRACTORS SEPARADORES ECARTEURS DIVARICATORI

Selbsthaltende Wundsperrer
 Selfretaining Retractors
 Separadores autoestaticos
 Ecarteurs autostatiques
 Divaricatori autostatici

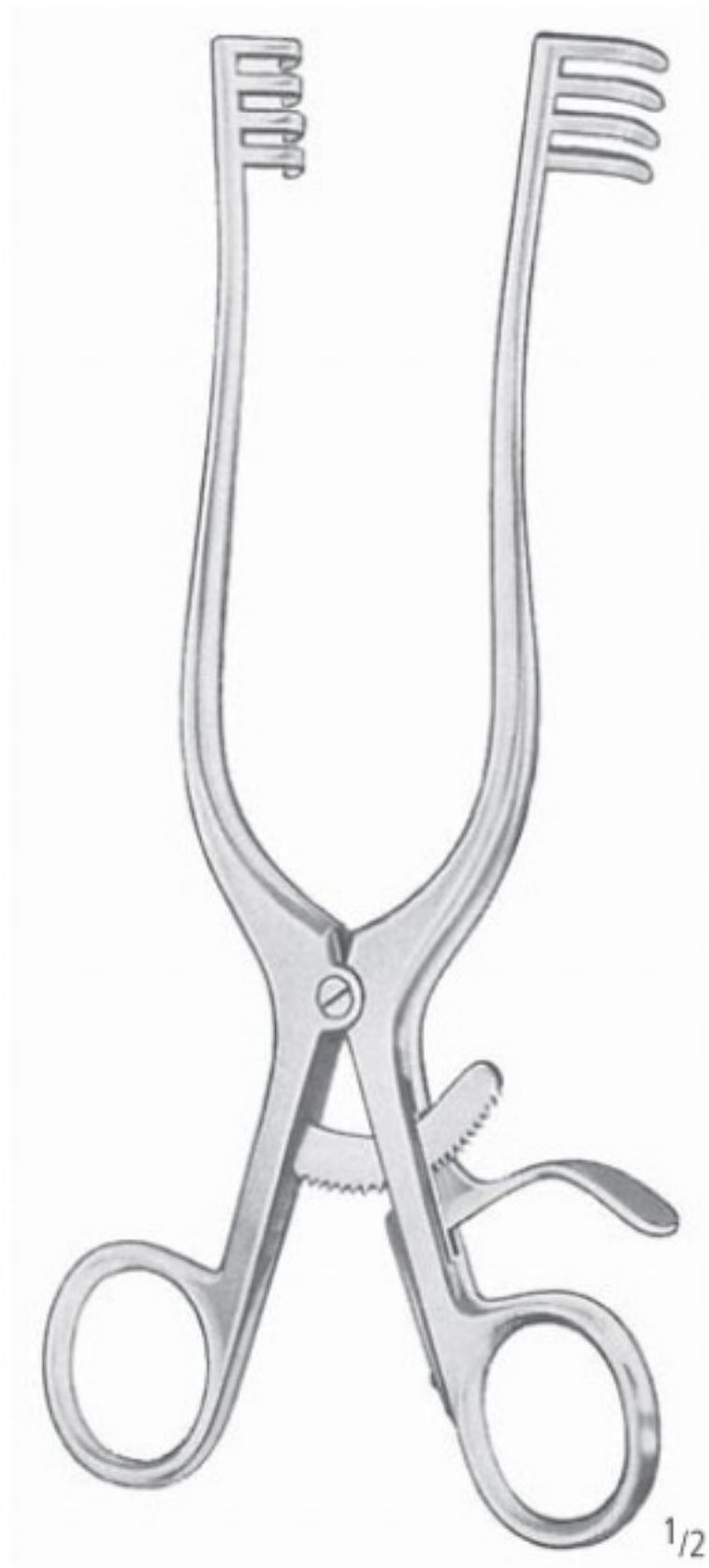

ADSON
 AK 554/20 AK 555/20
 20,0 cm/8"



ANDERSON-ADSON
 AK 556/20 AK 557/20
 20,0 cm/8"

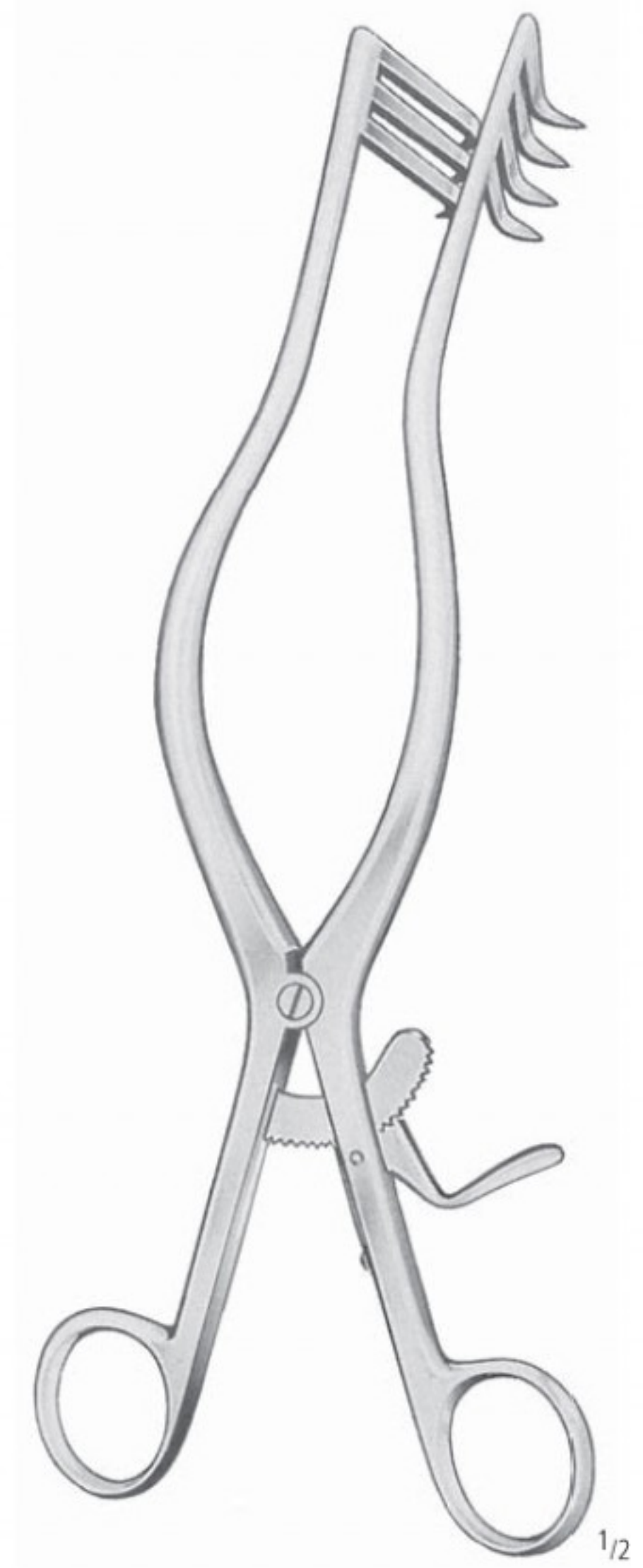

ADSON
 AK 558/27 AK 559/27
 27,0 cm/10³/₄"

WUNDHAKEN RETRACTORS SEPARADORES ECARTEURS DIVARICATORI

Selbsthaltende Wundsperrer
Selfretaining Retractors
Separadores autoestaticos
Ecarteurs autostatiques
Divaricatori autostatici

AA
AB
AC
AD
AE
AF
AK
AL
AO
KA
KK
X



ADSON
AK 560/27
27,0 cm/10³/₄"



ADSON-R
AK 561/01
27,0 cm/10³/₄"



ADSON-L
AK 561/02
27,0 cm/10³/₄"

Selbsthaltende Wundsperrer
 Selfretaining Retractors
 Separadores autoestaticos
 Ecarteurs autostatiques
 Divaricatori autostatici

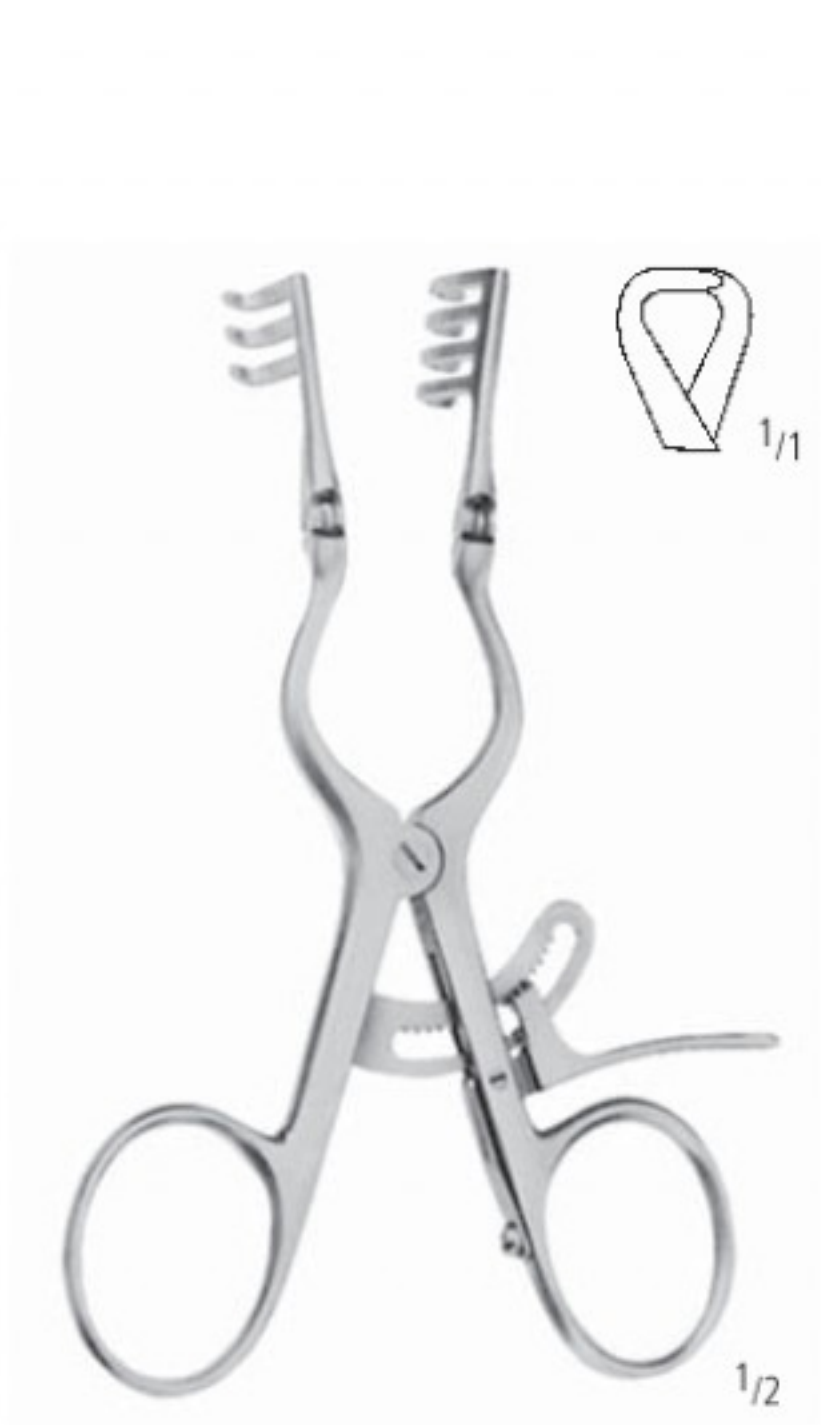

ADSON-BABY
 AK 562/14
 14,0 cm/5½"



CONE

13,0 cm/5"
 16,5 cm/6½"
 20,0 cm/8"
 25,0 cm/10"

3 x 4
 3 x 4
 3 x 4
 3 x 4

^
 AK 564/13
 AK 564/16
 AK 564/20
 AK 564/25

∩
 AK 565/13
 AK 565/16
 AK 565/20
 AK 565/25

GEFÄSSINSTRUMENTE UND SONDEN
VESSEL INSTRUMENTS AND PROBES
INSTRUMENTAL VASCULAR Y SONDAS
INSTRUMENTS VAISSEaux ET SONDES
STRUMENTI VASCOLARI E SONDE

AL

nopa[®] instruments

Weitere Sonden finden Sie in unserem Katalog
"Allgemeine Chirurgie" in Gruppe AL.

For further probes kindly refer to our catalogue
"General Surgery", section AL.

Para sondas adicionales, por favor consulte nuestro
catálogo de "Cirugía general", grupo AL.

Pour des sondes supplémentaires, consultez notre
catalogue "Chirurgie Generale", section AL.

Per gli altri sonde, consultare il nostro catalogo
"Chirurgia Generale", gruppo AL.



SONDEN PROBES SONDAS SONDES SONDE

Sonden
Probes
Sondas
Sondes
Sonde

AA

AB

AC

AD

AE

AF

AK

AL

AO

KA

KK

X



1/2



1/2



1/2

Silber
silver
de plata
en argent
d'argento



1/2

	1,0 mm	2,0 mm
11,5 cm/4 1/2"	AL 001/11	AL 002/11
13,0 cm/5"	AL 001/13	AL 002/13
14,5 cm/5 3/4"	AL 001/14	AL 002/14
16,0 cm/6 1/4"	AL 001/16	AL 002/16
18,0 cm/7"	AL 001/18	AL 002/18
20,0 cm/8"	AL 001/20	AL 002/20
25,0 cm/10"	AL 001/25	AL 002/25

AL 003/11
AL 003/13
AL 003/14
AL 003/16
AL 003/18
AL 003/20
AL 003/25

MYRTLE LEAF

AL 007/14
AL 007/16
AL 007/18
AL 007/20

STACKE
AL 013/10
10,5 cm/4 1/4"
Ø 1,0 mm



1/2



1/2



1/2



1/2

11,5 cm/4 1/2"	AL 015/11
13,0 cm/5"	AL 015/13
14,5 cm/5 3/4"	AL 015/14
16,0 cm/6 1/4"	AL 015/16
18,0 cm/7"	AL 015/18
20,0 cm/8"	AL 015/20

DOYEN

AL 017/14

AL 020/11
AL 020/13
AL 020/14
AL 020/16
AL 020/18

NELATON

AL 022/16

AL SONDEN PROBES SONDAS SONDES SONDE

Sonden und Watteträger
 Probes and Cotton Applicators
 Sondas y Porta-algodones
 Sondes et Porte-coton
 Sonde e Portacotone

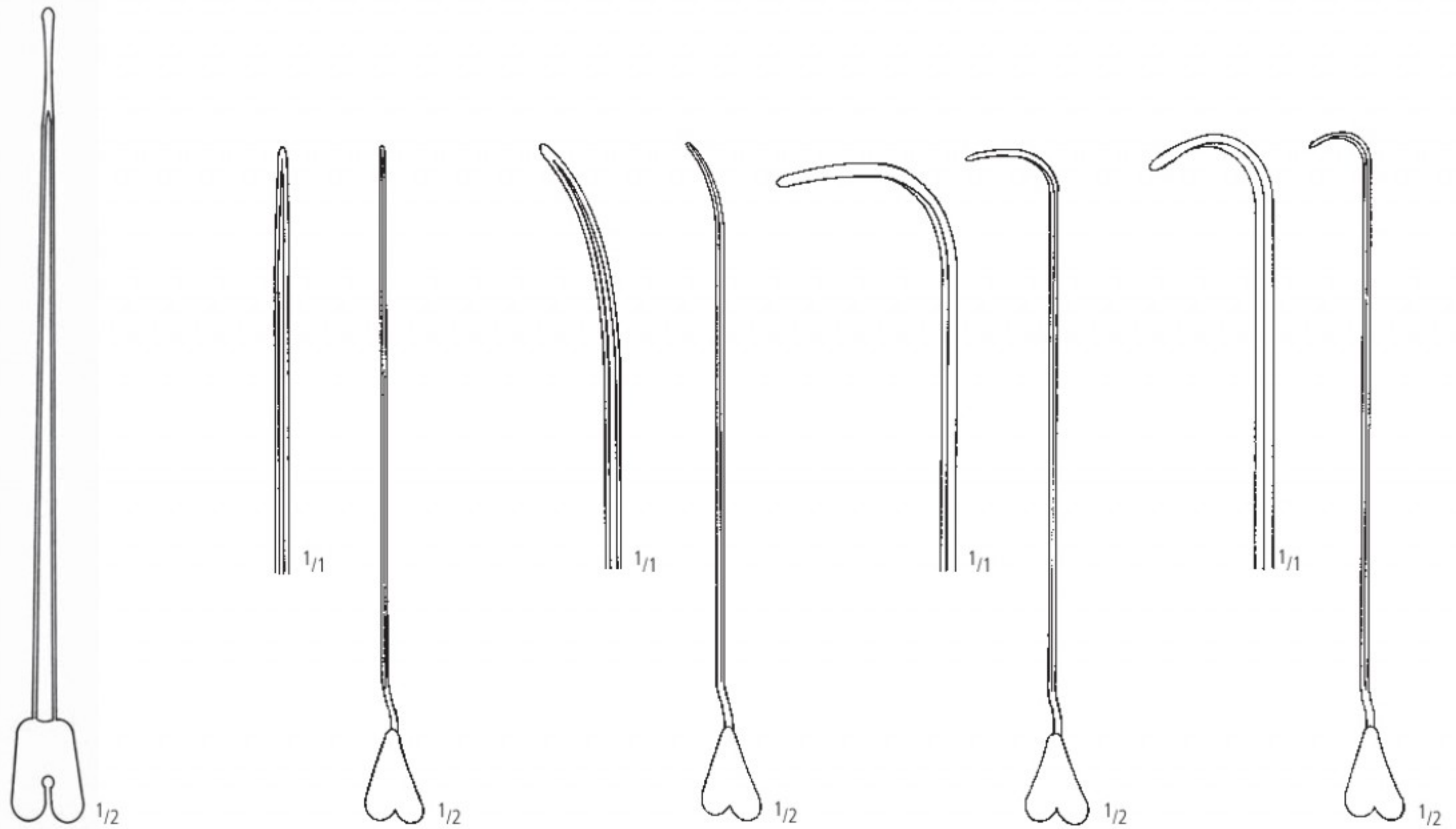

BRODIE

AL 026/20
 20,0 cm/8"

LOCKHART-MUMMERY

Fig. 1
 AL 030/01

Fig. 2
 AL 030/02

LOCKHART-MUMMERY

Fig. 3
 AL 030/03

Fig. 4
 AL 030/04

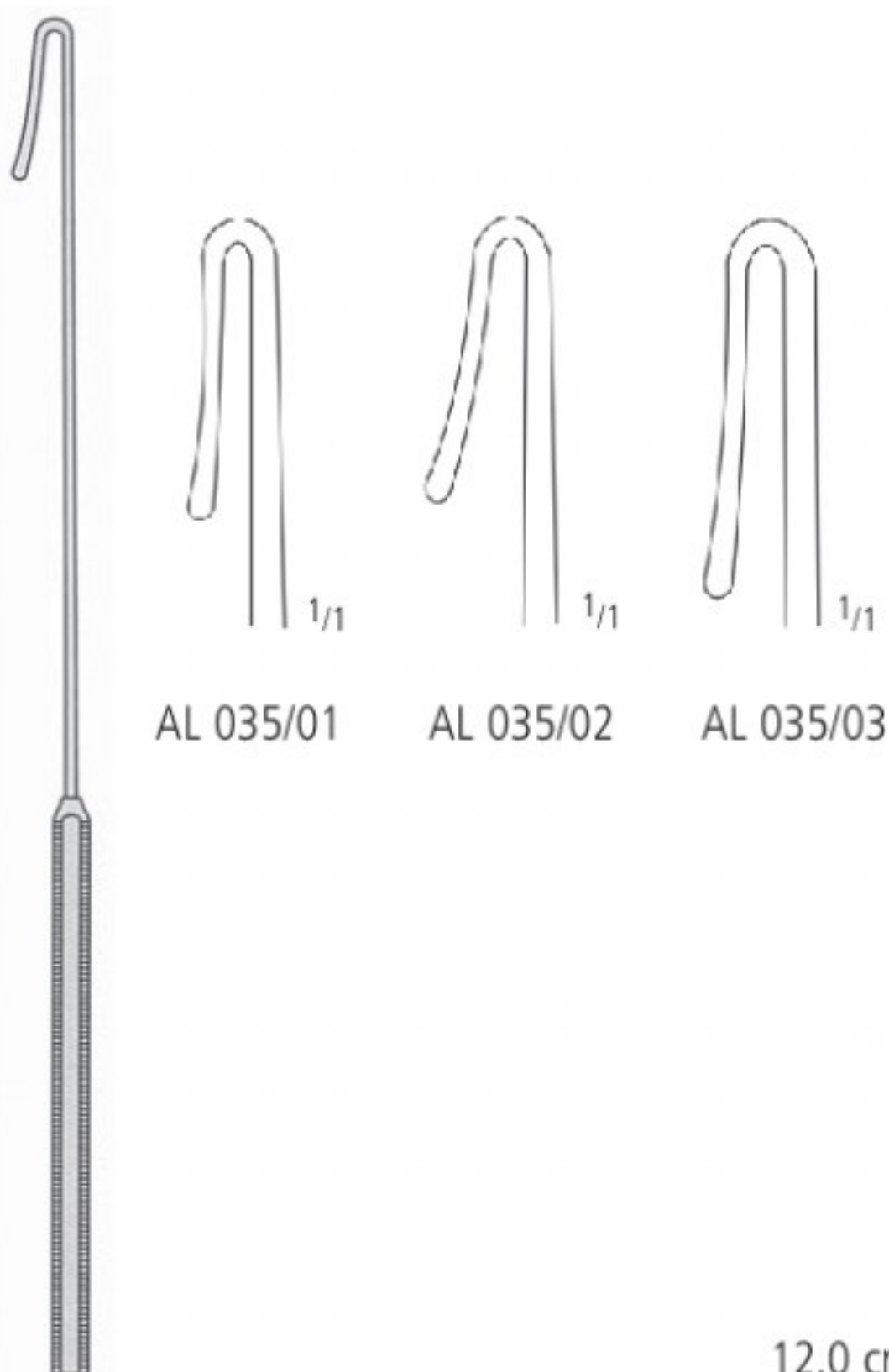

PRATT

21,0 cm/8¹/₄"

12,0 cm/4³/₄"
 14,0 cm/5¹/₂"
 16,5 cm/6¹/₂"
 18,0 cm/7"

FARRELL



0,9 mm
 1,1 mm
 1,2 mm
 AL 100/12
 AL 100/14
 AL 100/16
 AL 100/18

FARRELL

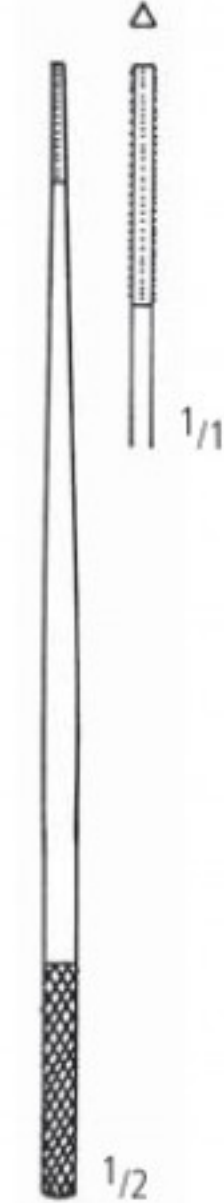

0,9 mm
 1,1 mm
 1,2 mm
 AL 120/12
 AL 120/14
 AL 120/16
 AL 120/18

SONDEN PROBES SONDAS SONDES SONDE

Watteträger und Krampfader-Besteck
 Cotton Applicators and Varicose Vein Probe Set
 Porta-algodones y sonda para várices
 Porte-coton et trousse à varices
 Portacotone e astuccio per varici

AA
AB
AC
AD
AE
AF
AK
AL
AO
KA
KK
X



UCKERMANN
 AL 160/16
 16,0 cm/6¹/₄"

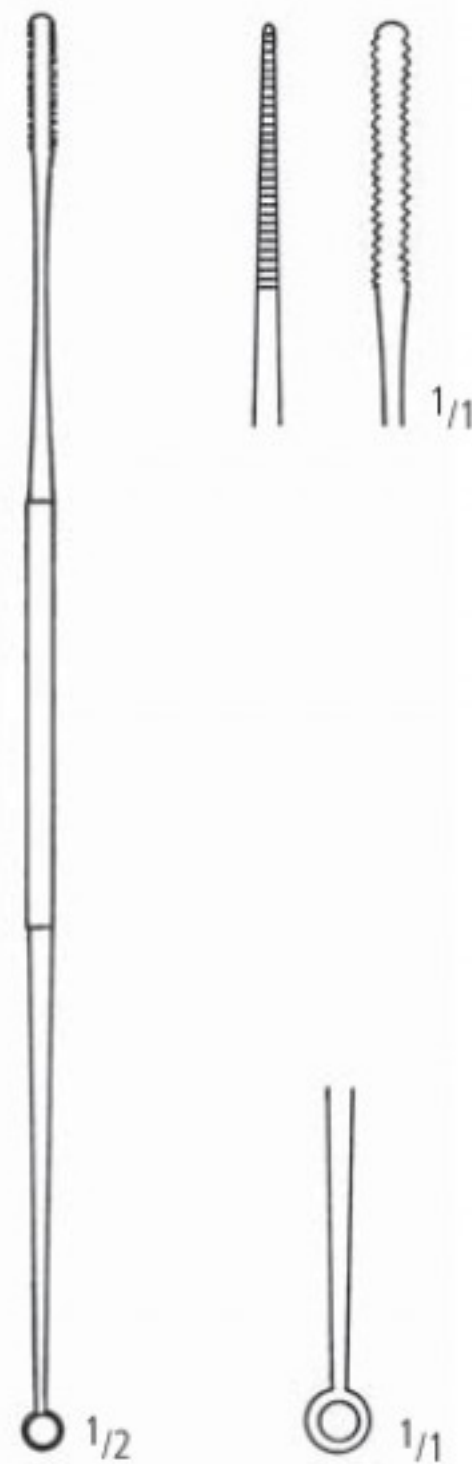

JOBSON-HORNE
 AL 162/18
 18,0 cm/7"

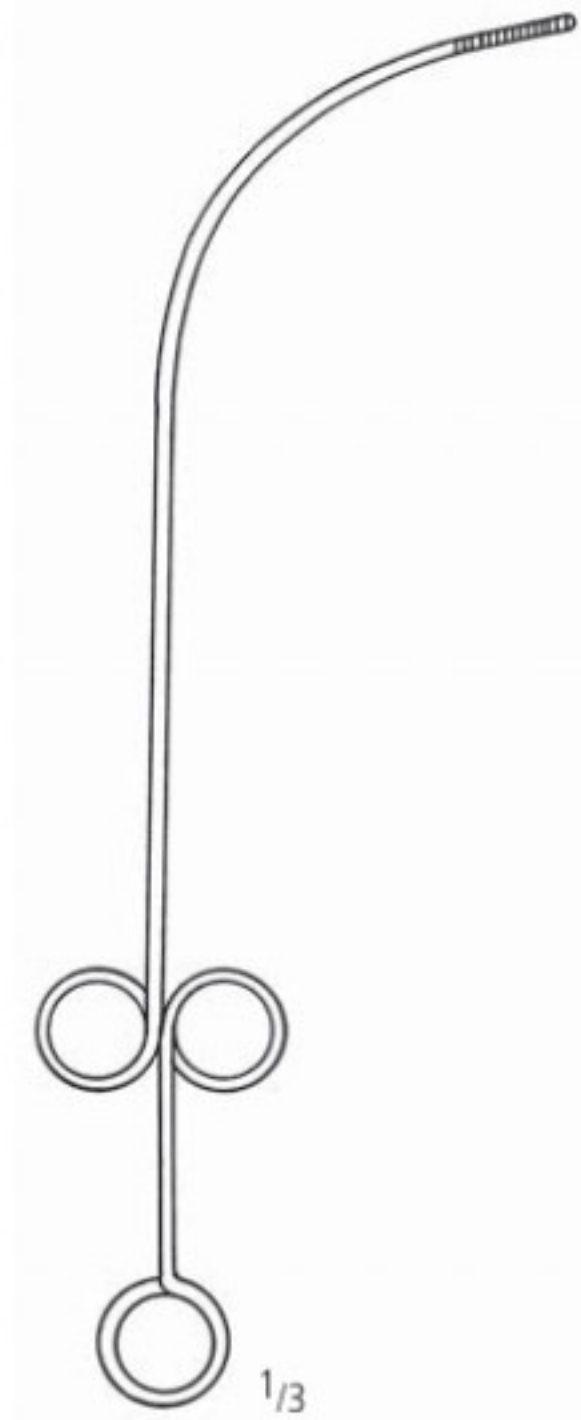

FEIN
 AL 170/28
 28,0 cm/11"



3,0 mm
 AL 182/03



6,0 mm
 AL 182/06



9,0 mm
 AL 182/09



12,0 mm
 AL 182/12

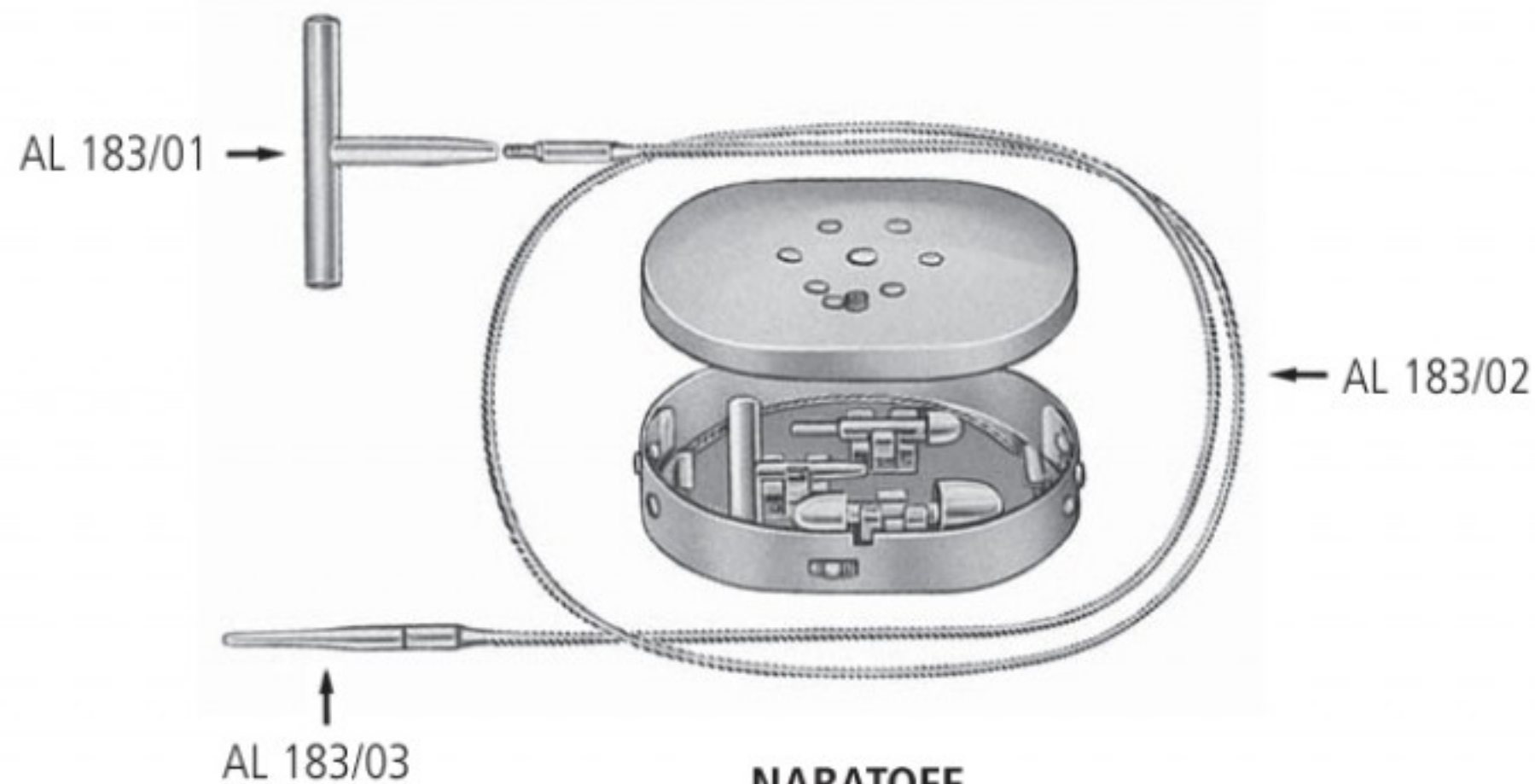

NABATOFF
 AL 180/00
 komplett-complete-completo-complet-completo

AL SONDEN PROBES SONDAS SONDES SONDE

Gefäß-Dilatatoren
 Vascular Dilators
 Dilatadores vasculares
 Dilatateurs vasculaires
 Dilatatori per vasi

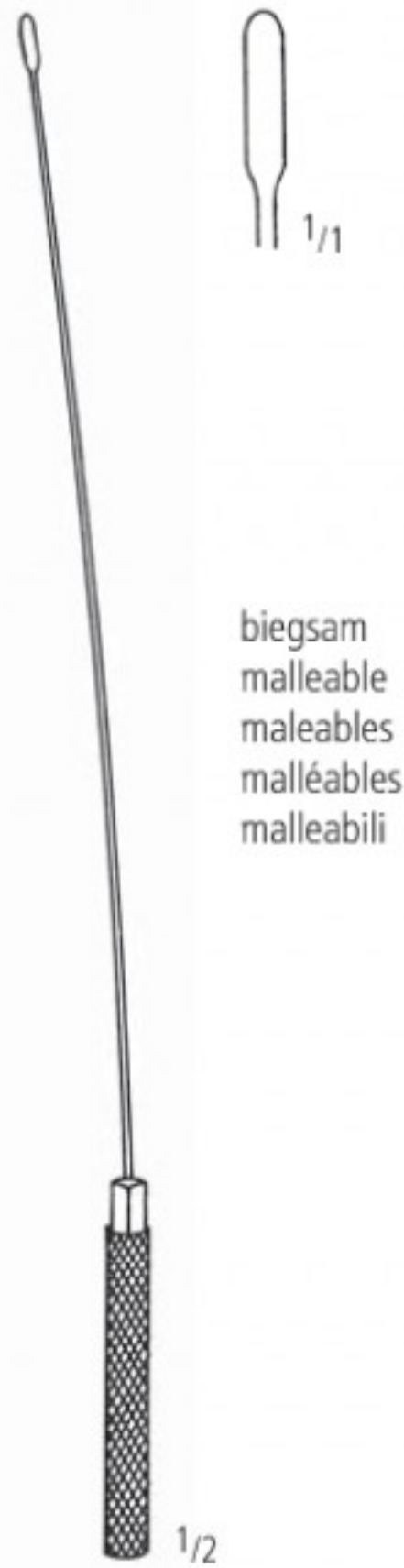









biegsam
 malleable
 maleables
 malléables
 malleabili

	14,0 cm/5 ¹ / ₂ "	21,0 cm/8 ¹ / ₄ "
1,0 mm	AL 190/10	AL 192/10
1,5 mm	AL 190/15	AL 192/15
2,0 mm	AL 190/20	AL 192/20
2,5 mm	AL 190/25	AL 192/25
3,0 mm	AL 190/30	AL 192/30
3,5 mm	AL 190/35	AL 192/35
4,0 mm	AL 190/40	AL 192/40
4,5 mm	AL 190/45	AL 192/45
5,0 mm	AL 190/50	AL 192/50

GARRETT



biegsam
 malleable
 maleables
 malléables
 malleabili

				
	0,5 mm Ø AL 196/05	1,0 mm Ø AL 196/10	1,5 mm Ø AL 196/15	2,0 mm Ø AL 196/20
				
	2,5 mm Ø AL 196/25	3,0 mm Ø AL 196/30	4,0 mm Ø AL 196/40	5,0 mm Ø AL 196/50

COOLEY
 13,0 cm/5"

SONDEN PROBES SONDAS SONDES SONDE

Gefäß-Dilatatoren
 Vascular Dilators
 Dilatadores vasculares
 Dilatateurs vasculaires
 Dilatatori per vasi

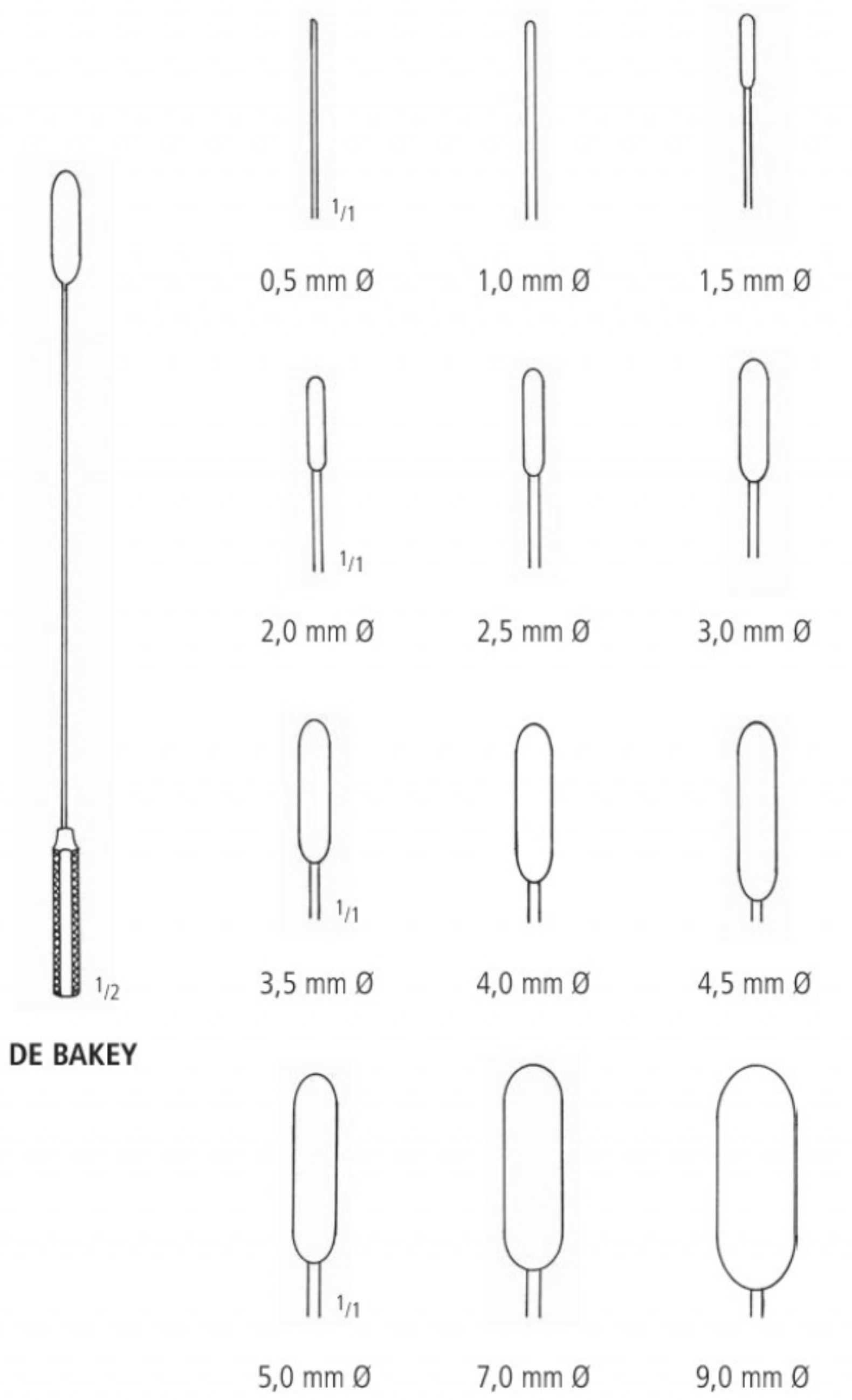

DE BAKEY

biegsam-malleable-maleables-malléables-malleabili

mm Ø	19,0 cm / 7 ¹ / ₂ "	35,0 cm / 14"
0,5	AL 200/05	AL 201/05
1,0	AL 200/10	AL 201/10
1,5	AL 200/15	AL 201/15
2,0	AL 200/20	AL 201/20
2,5	AL 200/25	AL 201/25
3,0	AL 200/30	AL 201/30
3,5	AL 200/35	AL 201/35
4,0	AL 200/40	AL 201/40
4,5	AL 200/45	AL 201/45
5,0	AL 200/50	AL 201/50
7,0	AL 200/70	AL 201/70
9,0	AL 200/90	AL 201/90

AA
AB
AC
AD
AE
AF
AK
AL
AO
KA
KK
X

Gefäß-Stripper
 Vascular Strippers
 Desobliteradores de vasos
 Tire-veines
 Tiravene

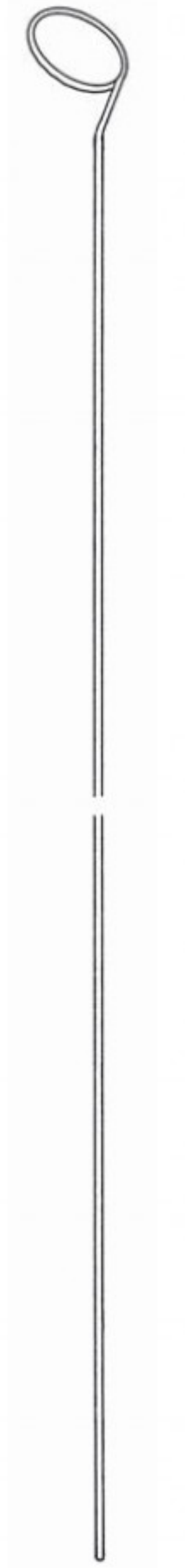

50,0 cm / 20"

○ 1/1
 2,0 mm
 AL 220/02

○ 1/1
 6,0 mm
 AL 220/06

○ 1/1
 10,0 mm
 AL 220/10

○
 3,0 mm
 AL 220/03

○
 7,0 mm
 AL 220/07

○
 12,0 mm
 AL 220/12

○
 4,0 mm
 AL 220/04

○
 8,5 mm
 AL 220/08

○
 14,0 mm
 AL 220/14



AL 222/12
 12,0 cm / 4³/₄"

SONDEN PROBES SONDAS SONDES SONDE

Fasszangen
Grasping Forceps
Pinzas para coger
Pinces pour saisir
Pinze per afferrare

AA

AB

AC

AD

AE

AF

AK

AL

AO

KA

KK

X



FRANKENFELDT
AL 248/36
36,0 cm/14¹/₄"



38,0 cm / 15¹/₄"

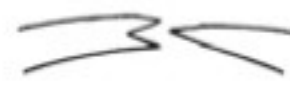

AL 250/38

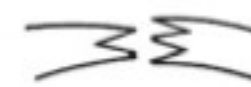

AL 251/38



AL 252/38

- 1,0 mm KB 100/02
- 2,0 mm KB 100/04
- 3,0 mm KB 100/06
- 4,0 mm KB 100/08
- 5,0 mm KB 100/10
- 6,0 mm KB 100/12
- 7,0 mm KB 100/14
- 8,0 mm KB 100/16
- 9,0 mm KB 100/18
- 10,0 mm KB 100/20
- 11,0 mm KB 100/22
- 12,0 mm KB 100/24
- 13,0 mm KB 100/26
- 14,0 mm KB 100/28
- 15,0 mm KB 100/30
- 16,0 mm KB 100/32
- 17,0 mm KB 100/34
- 18,0 mm KB 100/36
- 19,0 mm KB 100/38
- 20,0 mm KB 100/40
- 21,0 mm KB 100/42
- 22,0 mm KB 100/44
- 23,0 mm KB 100/46
- 24,0 mm KB 100/48
- 25,0 mm KB 100/50
- 26,0 mm KB 100/52
- 27,0 mm KB 100/54
- 28,0 mm KB 100/56
- 29,0 mm KB 100/58
- 30,0 mm KB 100/60



HEGAR

- 1,5 mm KB 100/03
- 2,5 mm KB 100/05
- 3,5 mm KB 100/07
- 4,5 mm KB 100/09
- 5,5 mm KB 100/11
- 6,5 mm KB 100/13
- 7,5 mm KB 100/15
- 8,5 mm KB 100/17
- 9,5 mm KB 100/19
- 10,5 mm KB 100/21
- 11,5 mm KB 100/23
- 12,5 mm KB 100/25
- 13,5 mm KB 100/27
- 14,5 mm KB 100/29
- 15,5 mm KB 100/31
- 16,5 mm KB 100/33
- 17,5 mm KB 100/35
- 18,5 mm KB 100/37
- 19,5 mm KB 100/39

KB 110/14

Satz zu 14 Dilatatoren 4,0 mm - 17,0 mm
 Set of 14 dilators 4,0 mm - 17,0 mm
 Juego de 14 dilatadores 4,0 mm - 17,0 mm
 Jeu de 14 dilateurs 4,0 mm - 17,0 mm
 Serie di 14 dilatatori 4,0 mm - 17,0 mm

KB 110/26

Satz zu 26 Dilatatoren 1,0 mm - 26,0 mm
 Set of 26 dilators 1,0 mm - 26,0 mm
 Juego de 26 dilatadores 1,0 mm - 26,0 mm
 Jeu de 26 dilateurs 1,0 mm - 26,0 mm
 Serie di 26 dilatatori 1,0 mm - 26,0 mm

KB 112/14

Satz zu 14 Dilatatoren 4,0 mm - 17,0 mm
 Set of 14 dilators 4,0 mm - 17,0 mm
 Juego de 14 dilatadores 4,0 mm - 17,0 mm
 Jeu de 14 dilateurs 4,0 mm - 17,0 mm
 Serie di 14 dilatatori 4,0 mm - 17,0 mm



HEGAR



HEGAR

1,0/ 2,0 mm	KB 113/02
3,0/ 4,0 mm	KB 113/04
5,0/ 6,0 mm	KB 113/06
7,0/ 8,0 mm	KB 113/08
9,0/10,0 mm	KB 113/10
11,0/12,0 mm	KB 113/12
13,0/14,0 mm	KB 113/14
15,0/16,0 mm	KB 113/16
17,0/18,0 mm	KB 113/18
19,0/20,0 mm	KB 113/20
21,0/22,0 mm	KB 113/22
23,0/24,0 mm	KB 113/24
25,0/26,0 mm	KB 113/26

KB 114/08
 Satz zu 8 Dilatatoren 3,0/4,0 mm - 17,0/18,0 mm
 Set of 8 dilators 3,0/4,0 mm - 17,0/18,0 mm
 Juego 8 dilatadores 3,0/4,0 mm - 17,0/18,0 mm
 Jeu de 8 dilateurs 3,0/4,0 mm - 17,0/18,0 mm
 Serie di 8 dilatatori 3,0/4,0 mm - 17,0/18,0 mm

KB 114/13
 Satz zu 13 Dilatatoren 1,0/2,0 mm - 25,0/26,0 mm
 Set of 13 dilators 1,0/2,0 mm - 25,0/26,0 mm
 Juego de 13 dilatadores 1,0/2,0 mm - 25,0/26,0 mm
 Jeu de 13 dilateurs 1,0/2,0 mm - 25,0/26,0 mm
 Serie di 13 dilatatori 1,0/2,0 mm - 25,0/26,0 mm

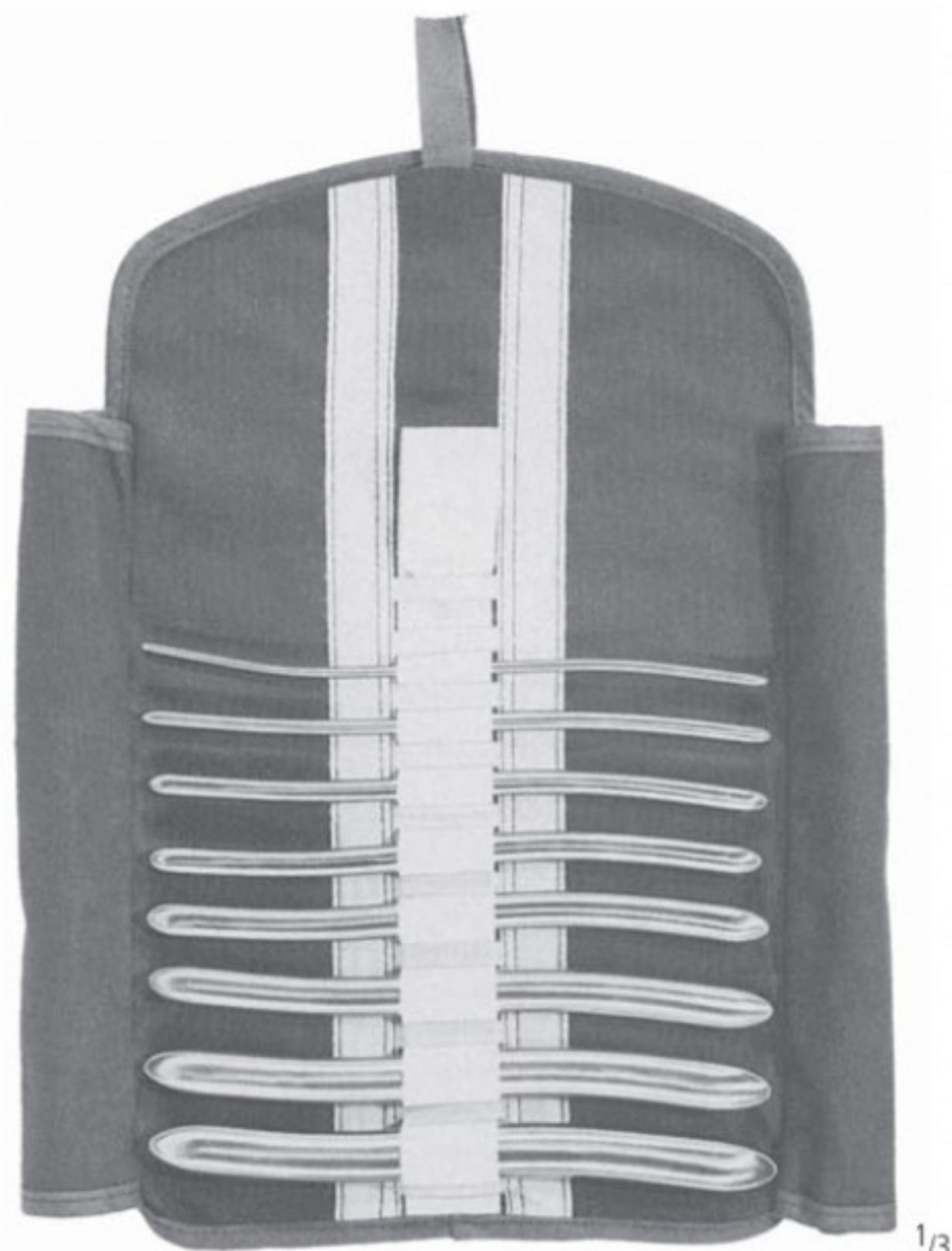

HEGAR

KB 115/08
 Satz zu 8 Dilatatoren 3,0/4,0 mm - 17,0/18,0 mm
 Set of 8 dilators 3,0/4,0 mm - 17,0/18,0 mm
 Juego 8 dilatadores 3,0/4,0 mm - 17,0/18,0 mm
 Jeu de 8 dilateurs 3,0/4,0 mm - 17,0/18,0 mm
 Serie di 8 dilatatori 3,0/4,0 mm - 17,0/18,0 mm

AA
 AB
 AC
 AD
 AE
 AF
 AK
 AL
 AO
 KA
 KK
 X

SAUGROHRE UND KANÜLEN
SUCTION TUBES AND CANNULAE
TUBOS DE ASPIRACION Y CANULAS
TUBES D'ASPIRATION ET CANULES
TUBI D'ASPIRAZIONE E CANNULE

AO

nopa[®] instruments

Weitere Instrumente für den Bereiche AO finden Sie in unserem Katalog "Allgemeine Chirurgie" in der Gruppe AO.

For further instruments of the section AO kindly refer to our catalogue "General Surgery", section AO.

Para instrumentos adicionales del este grupo AO, por favor consulte nuestro catálogo de "Cirugía general", grupo AO.

Pour instruments supplémentaires AO, consultez notre catalogue "Chirurgie Generale", section AO.

Per altri strumenti de questo gruppo AO, consultare il nostro catalogo "Chirurgia Generale", gruppo AO.



Saugrohre
Suction Tubes
Tubos de aspiración
Canules d'aspiration
Cannule per aspirazione

AA
AB
AC
AD
AE
AF
AK
AL
AO
KA
KK
X



YANKAUER
AO 400/00
27,0 cm/11"

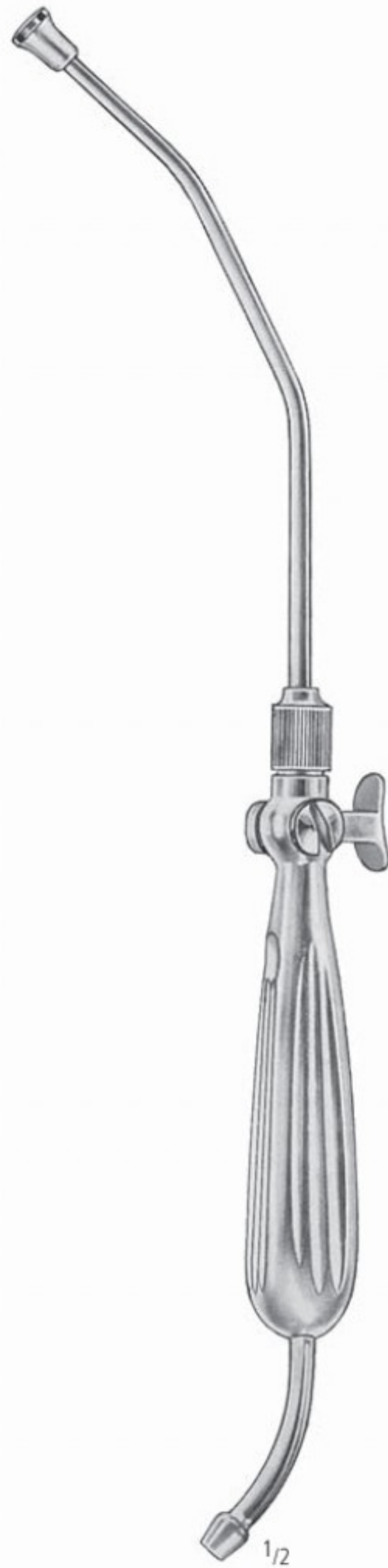

WALTON-YANKAUER
AO 404/00
32,5 cm/13"

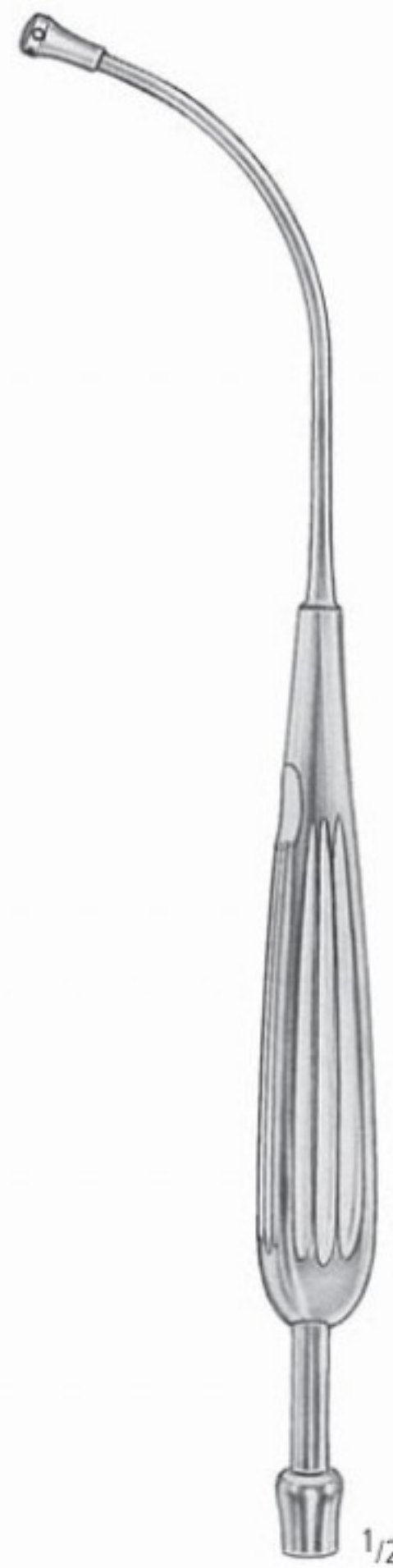

ANDREWS-PYNCHON
AO 406/00
23,5 cm/9¹/₃"



DE BAKEY
AO 408/00
27,5 cm/10³/₄"

Saugrohre
Suction Tubes
Tubos de aspiración
Canules d'aspiration
Cannule per aspirazione

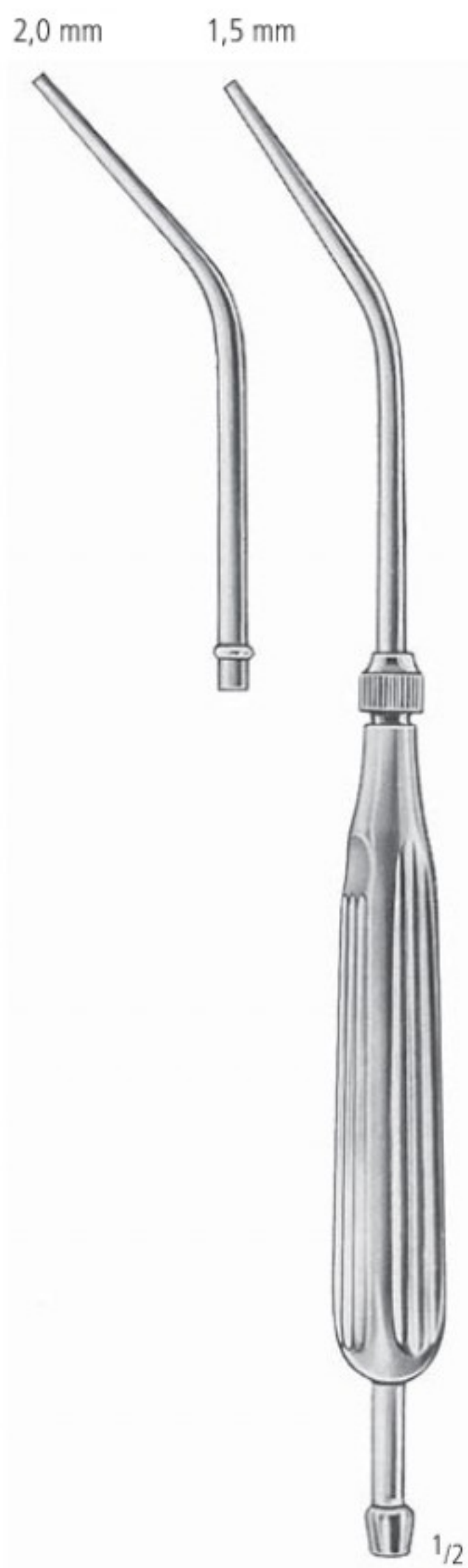

COUPLAND
AO 410/00



BYRD
1,5 mm AO 412/15
2,5 mm AO 412/25
3,5 mm AO 412/35



POOLE
AO 420/22
10,0 mm



POOLE
AO 421/22
8,0 mm



BABY-POOLE
AO 422/20
5,5 mm

Saugrohre
Suction Tubes
Tubos de aspiración
Canules d'aspiration
Cannule per aspirazione

AA
AB
AC
AD
AE
AF
AK
AL
AO
KA
KK
X

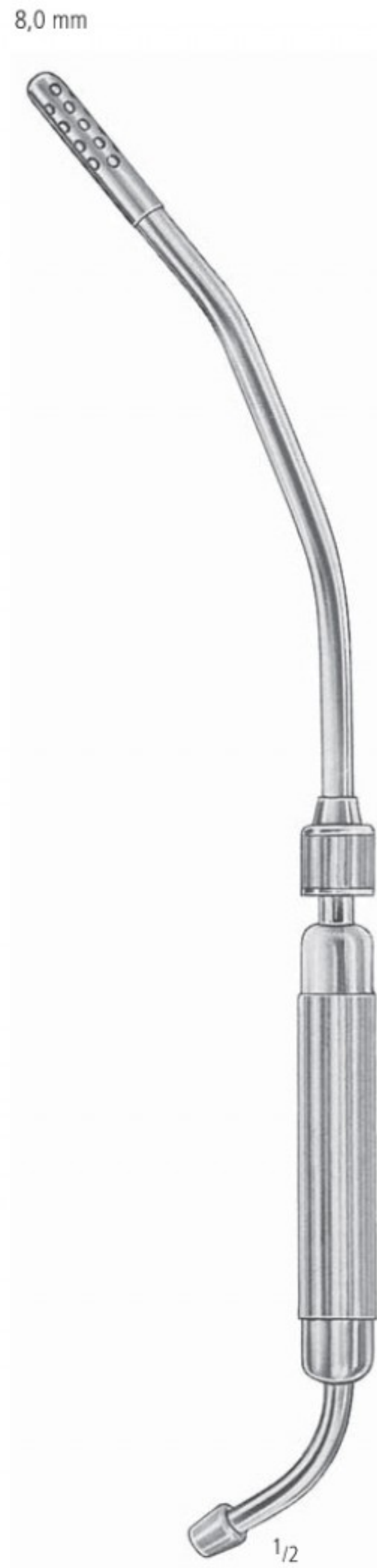

COOLEY
AO 424/01
33,0 cm/13"



COOLEY
AO 424/02
35,0 cm/14"



COOLEY
AO 424/03
30,0 cm/12"



COOLEY
AO 424/04
31,0 cm/12¹/₄"

Saugrohre
Suction Tubes
Tubos de aspiración
Canules d'aspiration
Cannule per aspirazione

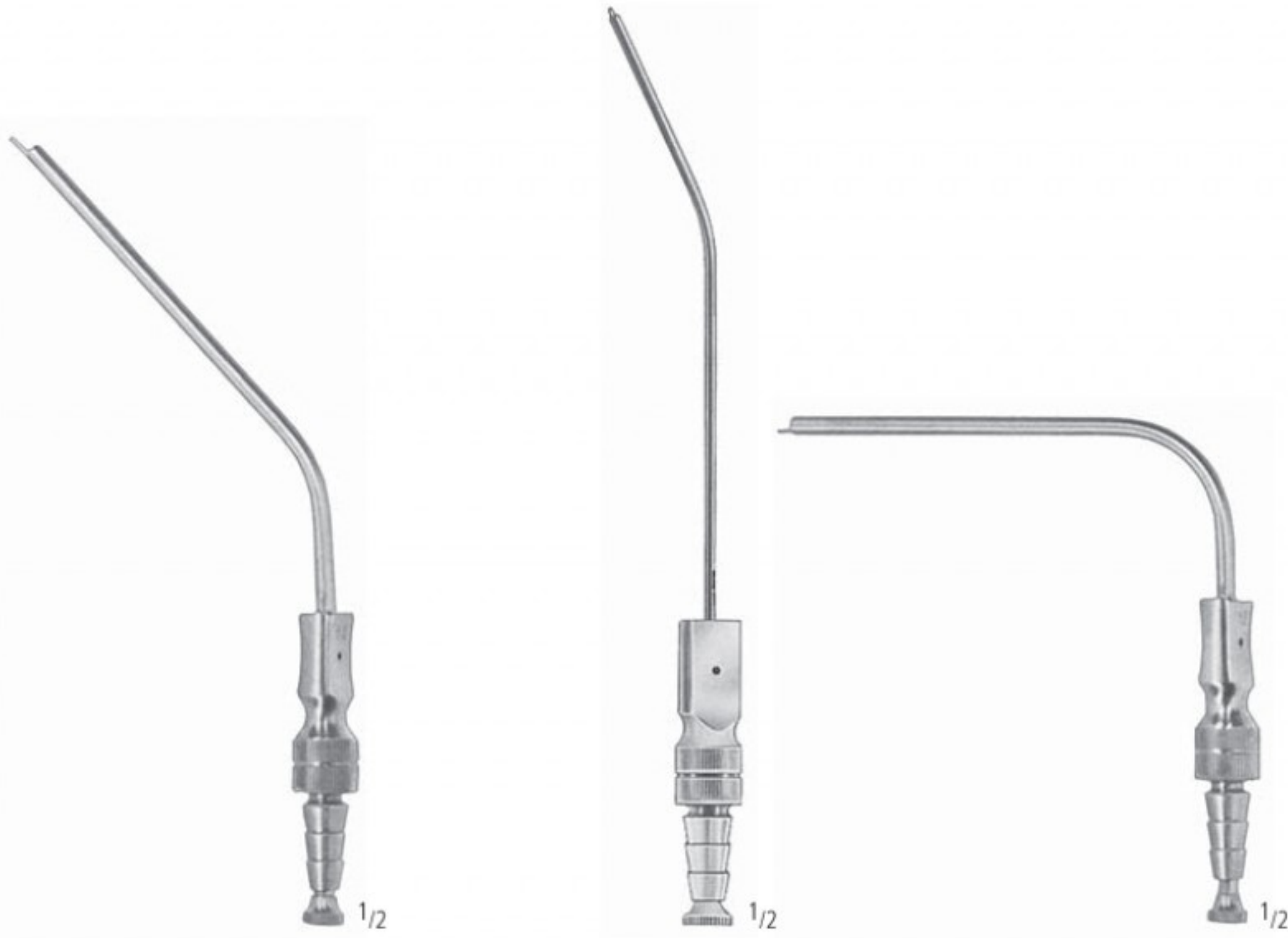

FRAZIER

6 Charr.	AO 430/06
8 Charr.	AO 430/08
10 Charr.	AO 430/10
12 Charr.	AO 430/12

PLESTER

1,5 mm	AO 432/15
2,0 mm	AO 432/20
2,5 mm	AO 432/25
3,0 mm	AO 432/30

FERGUSSON

5 Charr.	AO 434/05
6 Charr.	AO 434/06
7 Charr.	AO 434/07
8 Charr.	AO 434/08
9 Charr.	AO 434/09
10 Charr.	AO 434/10
12 Charr.	AO 434/12

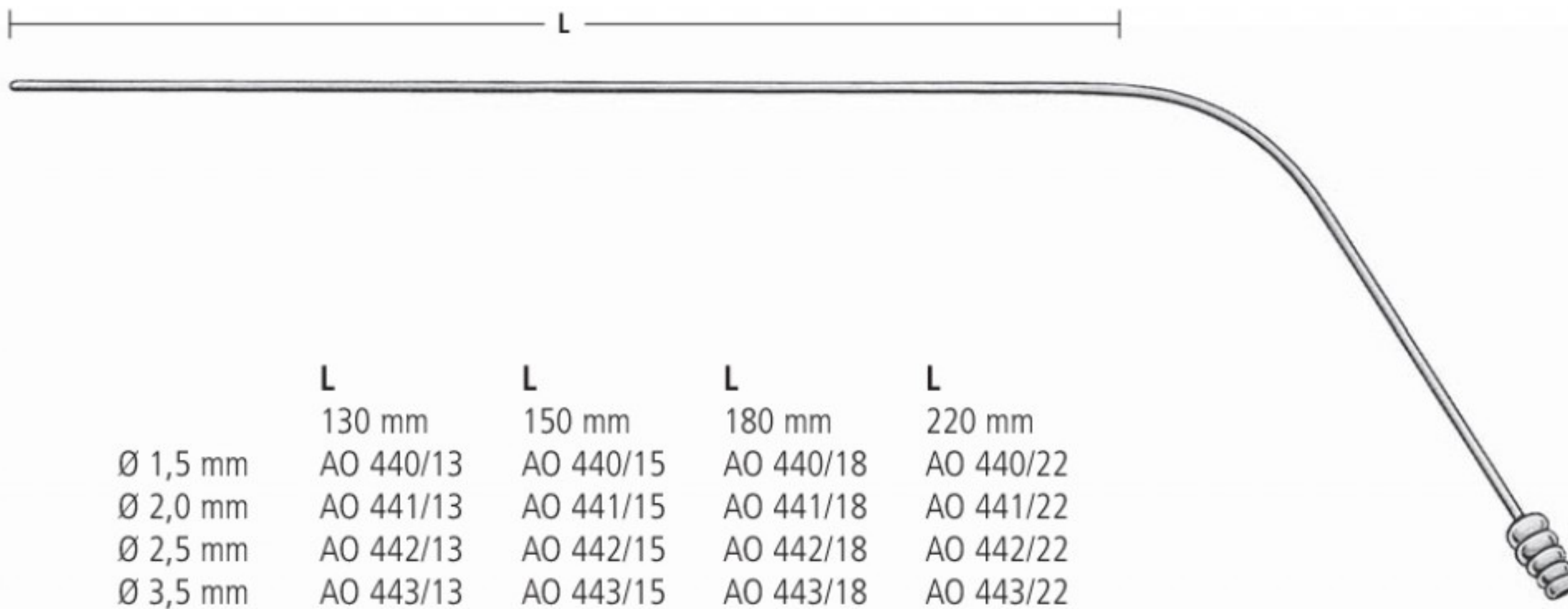

	L	L	L	L
	130 mm	150 mm	180 mm	220 mm
Ø 1,5 mm	AO 440/13	AO 440/15	AO 440/18	AO 440/22
Ø 2,0 mm	AO 441/13	AO 441/15	AO 441/18	AO 441/22
Ø 2,5 mm	AO 442/13	AO 442/15	AO 442/18	AO 442/22
Ø 3,5 mm	AO 443/13	AO 443/15	AO 443/18	AO 443/22



ADSON
AO 450/04
21,0 cm/8¹/₄"
Ø 4,0 mm

KNOCHENINSTRUMENTE
BONE INSTRUMENTS
INSTUMENTOS PARA HUESOS
INSTRUMENTS DES OS
STRUMENTI PER OSSA

KA

nopa[®] instruments

Bohrapparate u. Zubehör	Seite	219-221
Drilling devices and accessories	Page	219-221
Taladradoras y accesorios	Página	219-221
Perceuses et accessoires	Page	219-221
Alesatrici e accessori	Pagina	219-221
Drahtzangen	Seite	222-223
Wire forceps	Page	222-223
Pinzas para hilos	Página	222-223
Pinces à fil	Page	222-223
Tenaglie fili	Pagina	222-223
Hohlmeißel- und Knochensplitterzangen	Seite	224-232
Bone rongeurs and bone cutting forceps	Page	224-232
Pinzas gubias y pinzas cortantes para huesos	Página	224-232
Pinces gouges et pinces coupantes à os	Page	224-232
Pinze sgorbie e pinze cesoie per ossa	Pagina	224-232



Bohrapparate und Zubehör
 Drilling devices and accessories
 Taladradoras y accesorios
 Perceuses et accessoires
 Alesatrici e accessori



KA 120/00
 Akku Bohrapparat / Accu power drill

Spannung / Voltage	9,6 Volt
Drehzahl / Revolutions	0-750 U/min
Leistung / Power	130/200 Watt



KA 121/00
 Luft Bohrapparat / Air power drill

Drehzahl / Revolutions	600 U/min
Druck / Compression	6,5 bar

AA

AB

AC

AD

AE

AF

AK

AL

AO

KA

KK

X

Zubehör für KA 120/00 und KA 121/00
 Accessories for KA 120/00 and KA 121/00
 Accesorios para KA 120/00 y KA 121/00
 Accessoires pour KA 120/00 et KA 121/00
 Accessori per KA 120/00 e KA 121/00



KA 122/10
 Adapter mit Jacobs Spannfutter
 Adapter with Jacobs chuck



KA 122/16
 Schnellspannfutter für Kirschnerdrähte 0,8 bis 3,0 mm
 Quick-action chuck for Kirschner wires 0,8 to 3,0 mm



KA 122/11
 Adapter für AO Schaft
 Adapter for AO shank



KA 123/01
 Osteotomie Säge oszillierend
 Sagittal saw oscillating



KA 122/13
 Adapter für DIN Schaft
 Adapter for DIN shank



KA 123/02
 Sternum Säge
 Sternum Saw



KA 122/14
 Adapter für Harris Schaft
 Adapter for Harris shank



KA 122/15
 Adapter für Hudson Schaft
 Adapter for Hudson shank

Ladegerät / Akku
 Charger / Battery
 Cargador / acumulador
 Chargeur d'accus / accumulateur
 Caricabatteria / accumulatore

AA

AB

AC

AD

AE

AF

AK

AL

AO

KA

KK

X



KA 124/01
 Ladegerät Netzspannung 115V / 240V Ladezeit 60 min
 Charger main voltage 115V / 240V charging time 60 min



KA 124/02
 Ladegerät für 2 Akkus Netzspannung 115V / 240V
 Ladezeit 60 min
 Charger for 2 batteries main voltage 115V / 240V
 Charging time 60 min



KA 124/10
 9,6V 2600mAh



KA 124/11
 12V 2600mAh

Drahtzangen
Wire Forceps
Pinzas para hilos
Pinces à fil
Tenaglie fili



KA 270/15
15,0 cm/6"



KA 271/16
16 cm/6¹/₄"



KA 272/18
18,0 cm/7"

für weiche Drähte bis 2,0 mm Ø
for soft wires up to 2,0 mm Ø
para hilos blandos hasta 2,0 mm de Ø
pour fils mous jusqu'à 2,0 mm de Ø
per fili morbidi sino a mm. 2,0 di Ø

für harte Drähte bis 1,5 mm Ø
for hard wires up to 1,5 mm Ø
para hilos duros hasta 1,5 mm de Ø
pour fils durs jusqu'à 1,5 mm de Ø
per fili duri sino a mm. 1,5 di Ø



KA 273/17
17,0 cm/6³/₄"



für weiche Drähte bis 2,0 mm Ø
for soft wires up to 2,0 mm Ø
para hilos blandos hasta 2,0 mm de Ø
pour fils mous jusqu'à 2,0 mm de Ø
per fili morbidi sino a mm. 2,0 di Ø

für harte Drähte bis 1,6 mm Ø
for hard wires up to 1,6 mm Ø
para hilos duros hasta 1,6 mm de Ø
pour fils durs jusqu'à 1,6 mm de Ø
per fili duri sino a mm. 1,6 di Ø



KA 273/22
22 cm/8³/₄"

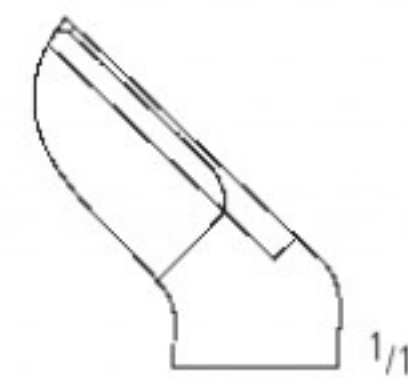

für Drähte bis 2,5 mm Ø
for wires up to 2,5 mm Ø
para hilos hasta 2,5 mm de Ø
pour fils jusqu'à 2,5 mm de Ø
per fili sino a mm. 2,5 di Ø

Drahtzangen
Wire Forceps
Pinzas para hilos
Pinces à fil
Tenaglie fili



KA 275/47
47,0 cm/18¹/₂"

AA
AB
AC
AD
AE
AF
AK
AL
AO
KA
KK
X

Hohlmeißelzangen
 Bone Rongeurs
 Pinzas-gubias
 Pincès-gouges
 Pinze-sgorbie



MARQUARDT
 KA 821/20
 20,0 cm/8"



MAYFIELD
 KA 823/17
 17,0 cm/6³/₄"



BEYER
 KA 830/18
 18,0 cm/7"



ZAUFAL-JANSEN
 KA 835/18
 18,0 cm/7"

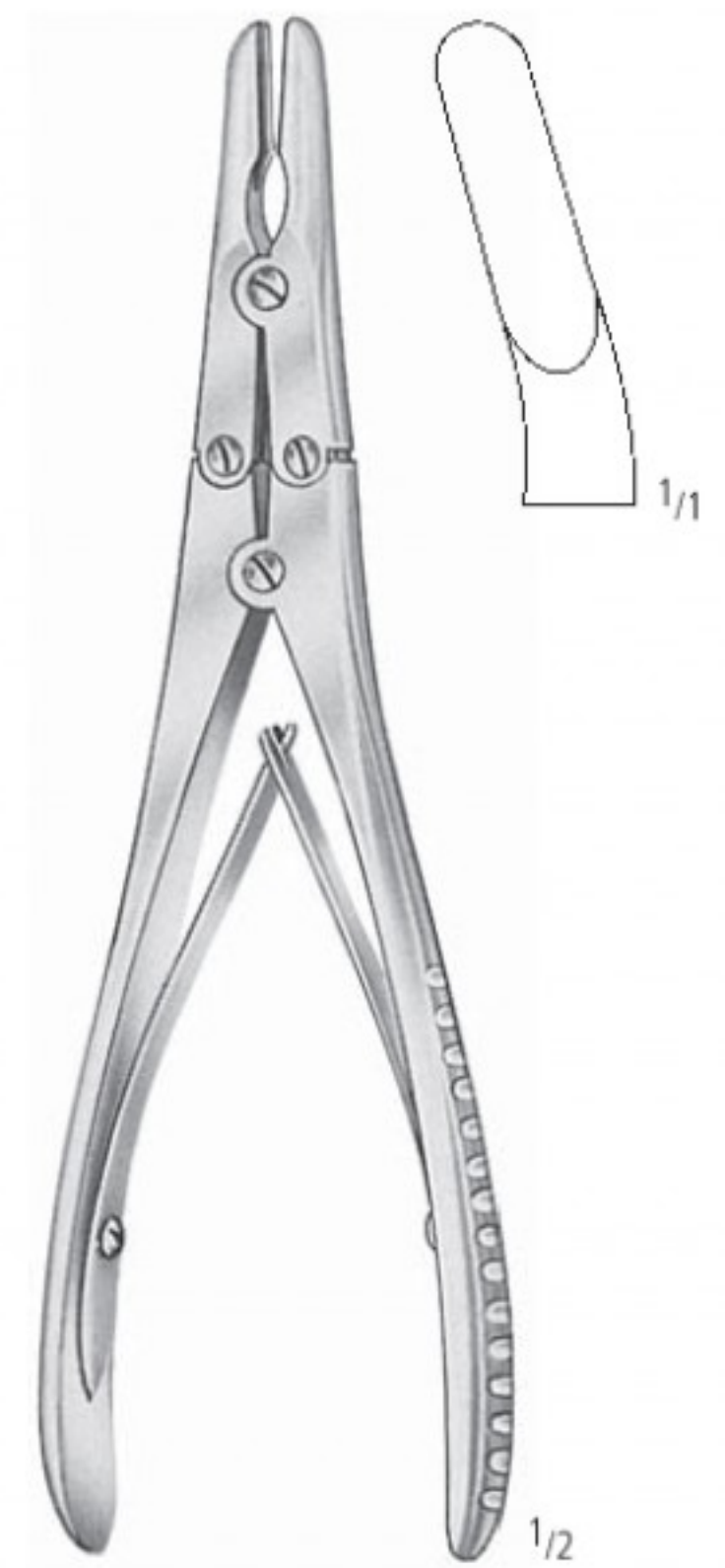

RUSKIN
 KA 836/18
 18,0 cm/7"

Hohlmeißelzangen
 Bone Rongeurs
 Pinzas-gubias
 Pinces-gouges
 Pinze-sgorbie

AA
 AB
 AC
 AD
 AE
 AF
 AK
 AL
 AO
 KA
 KK
 X

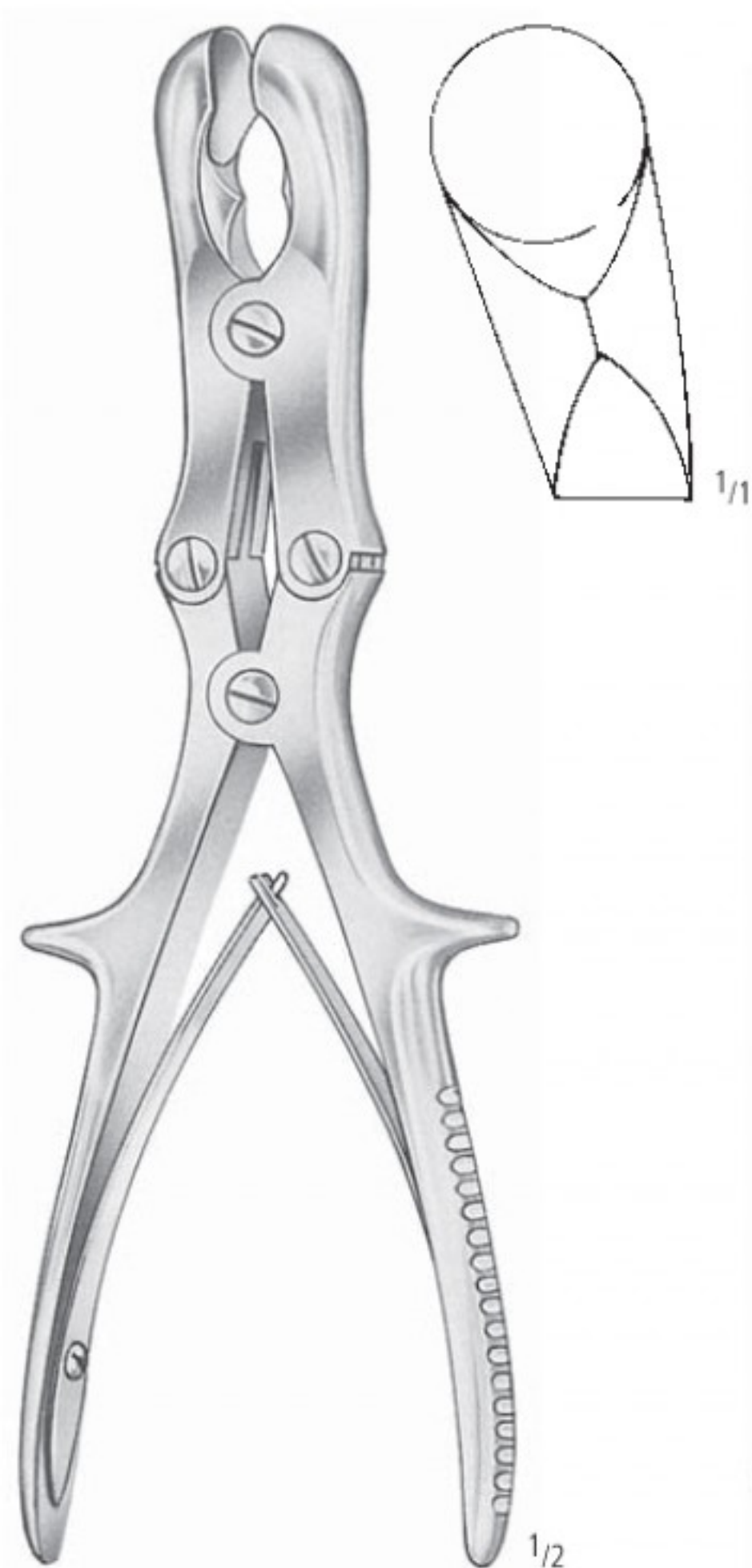

SEMB
 KA 838/22
 22,5 cm/9"



STILLE
 KA 840/23
 23,0 cm/9"



STILLE-RUSKIN
 KA 841/23
 23,0 cm/9"

Hohlmeißelzangen
 Bone Rongeurs
 Pinzas-gubias
 Pincès-gouges
 Pinze-sgorbie



ROETTGEN-RUSKIN
 KA 845/24
 24,0 cm/9¹/₂"



LEKSELL-STILLE
 24,0 cm/9¹/₂"

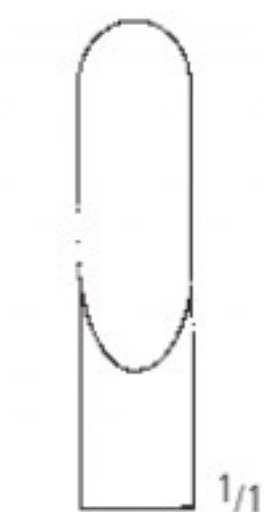

KA 848/01
 8 mm

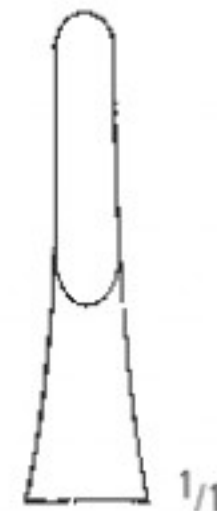

KA 848/02
 4 mm



STILLE-LUER
 22,0 cm/8³/₄"

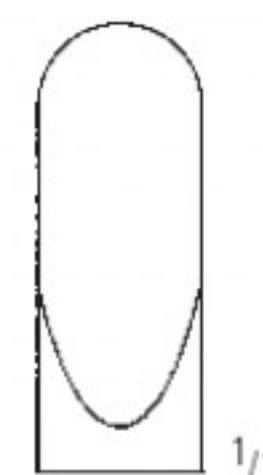

KA 852/22

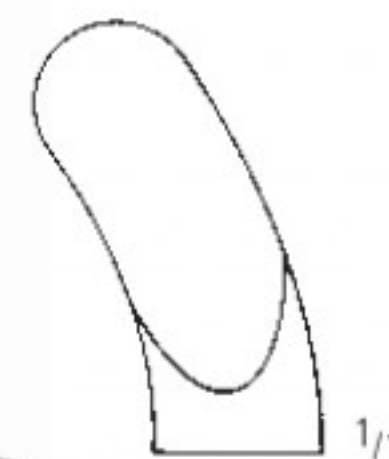

KA 853/22

Hohlmeißelzangen
 Bone Rongeurs
 Pinzas-gubias
 Pincès-gouges
 Pinze-sgorbie

AA

AB

AC

AD

AE

AF

AK

AL

AO

KA

KK

X

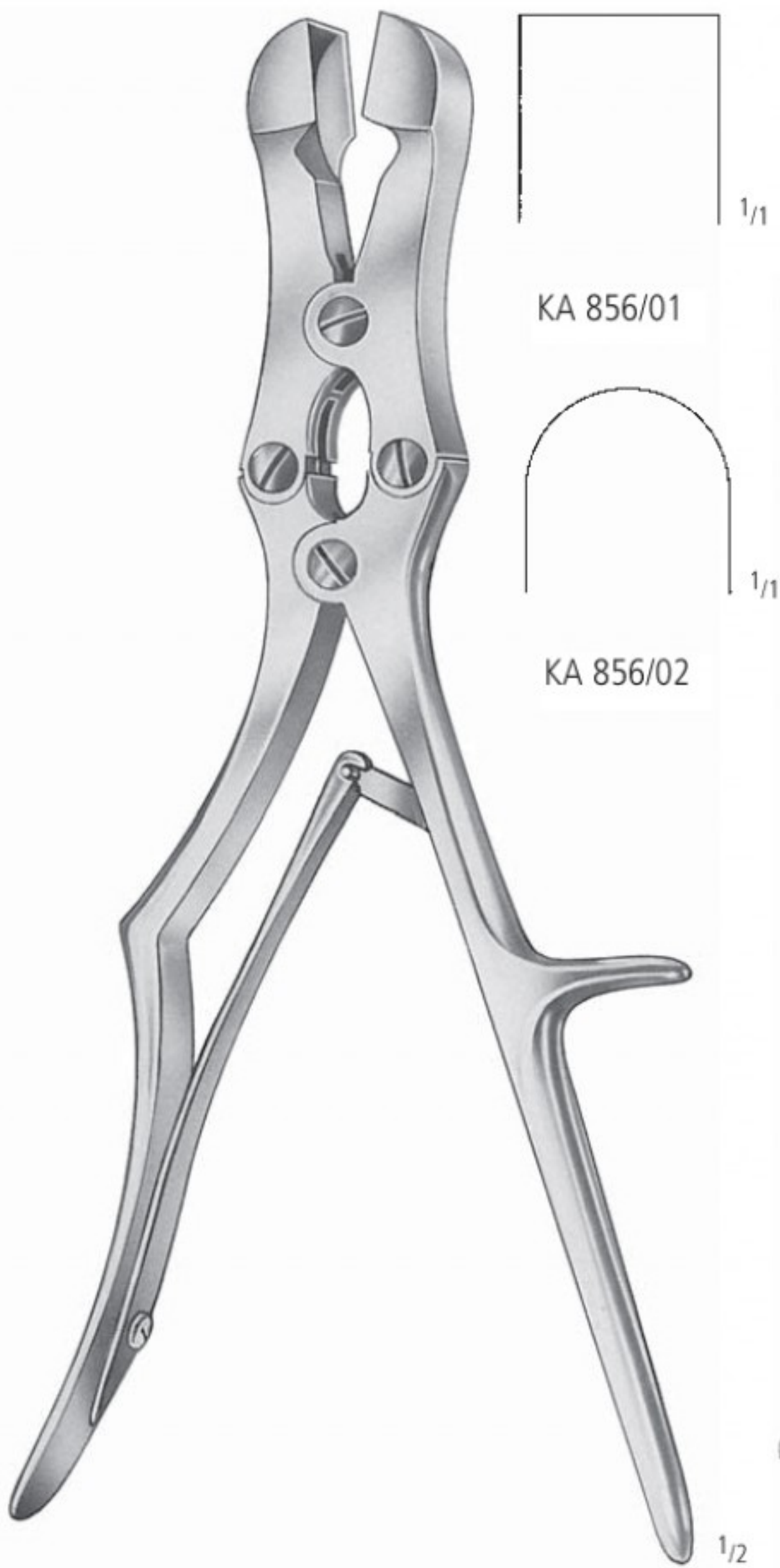

SAUERBRUCH
 30,0 cm/12"



FRYKHOLM
 KA 859/23
 23,0 cm/9"

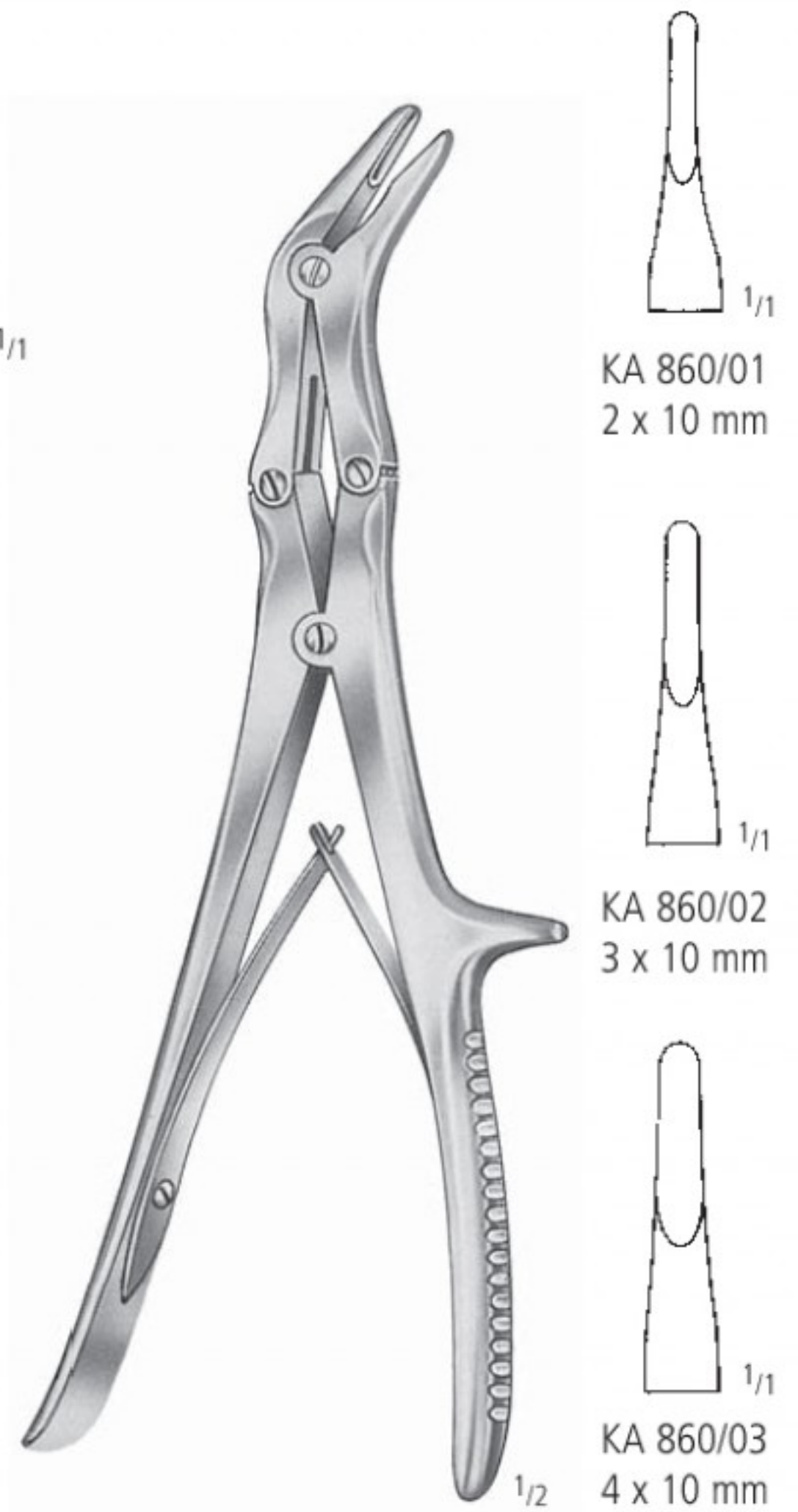

ECHLIN
 23,0 cm/9"

Hohlmeißelzangen
 Bone Rongeurs
 Pinzas-gubias
 Pincés-gouges
 Pinze-sgorbie



RUSKIN
 KA 862/23
 23,0 cm/9"



SMITH-PETERSON
 24,0 cm/9 1/2"



3,0 mm
 KA 863/03



4,0 mm
 KA 863/04

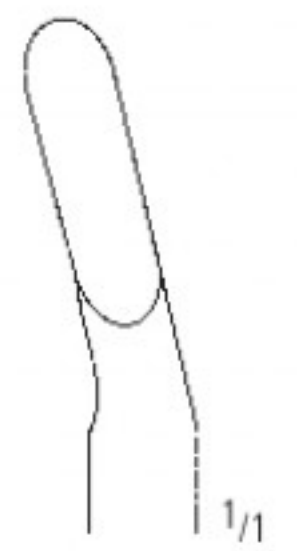

5,0 mm
 KA 863/05



3,0 mm
 KA 863/13

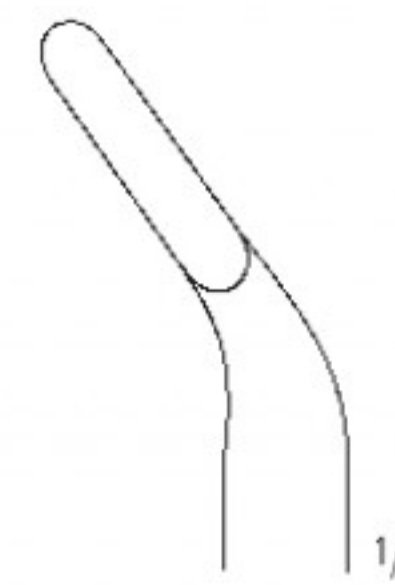

4,0 mm
 KA 863/14

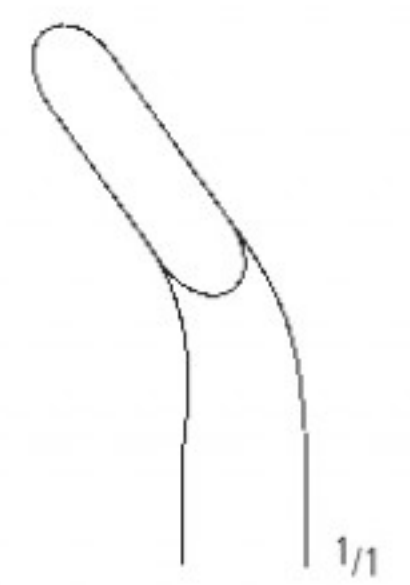

5,0 mm
 KA 863/15

Knochensplitterzangen
 Bone Cutting Forceps
 Pinzas cortantes para huesos
 Pincas coupantes à os
 Cesioie per ossa

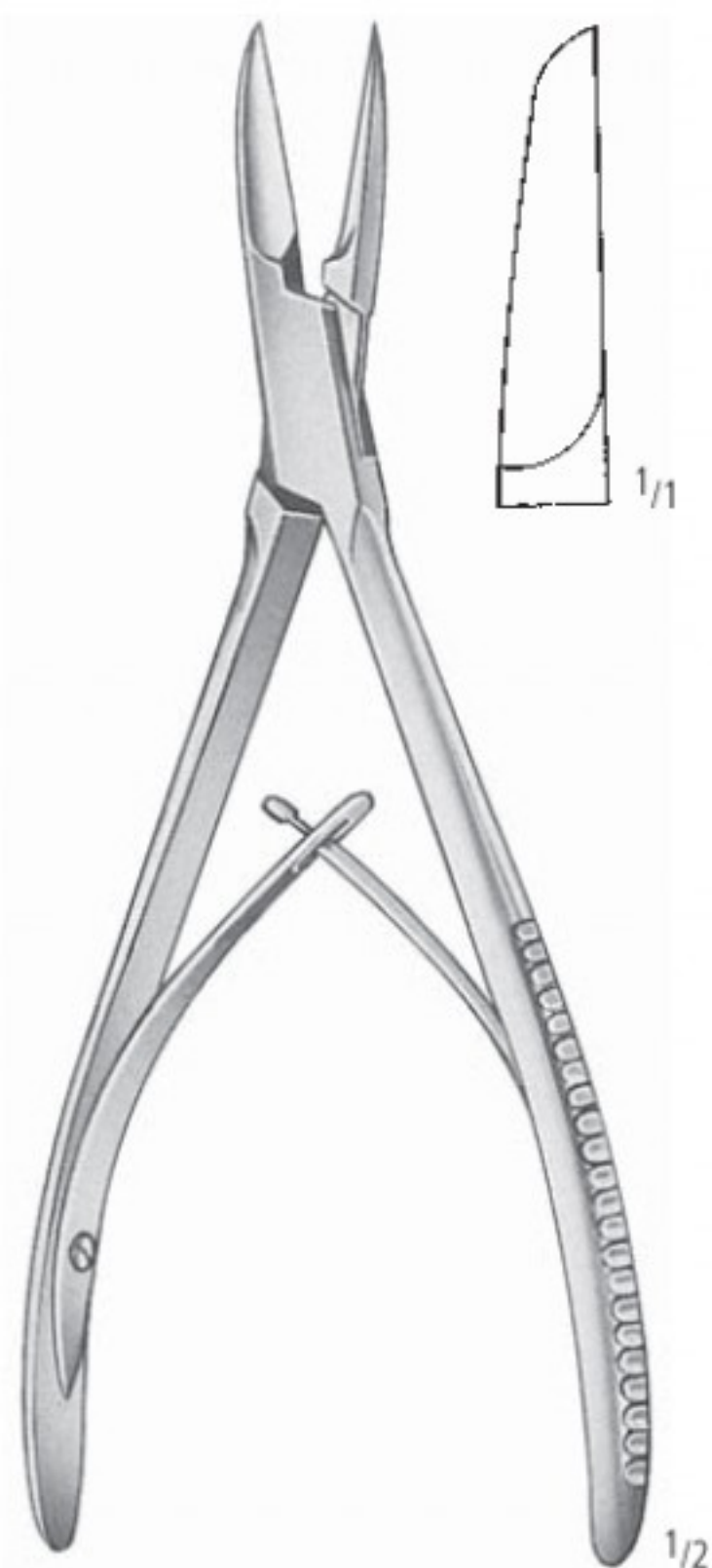

COTTLE KAZANJIAN
 KA 870/19
 19,0 cm/7 1/2"

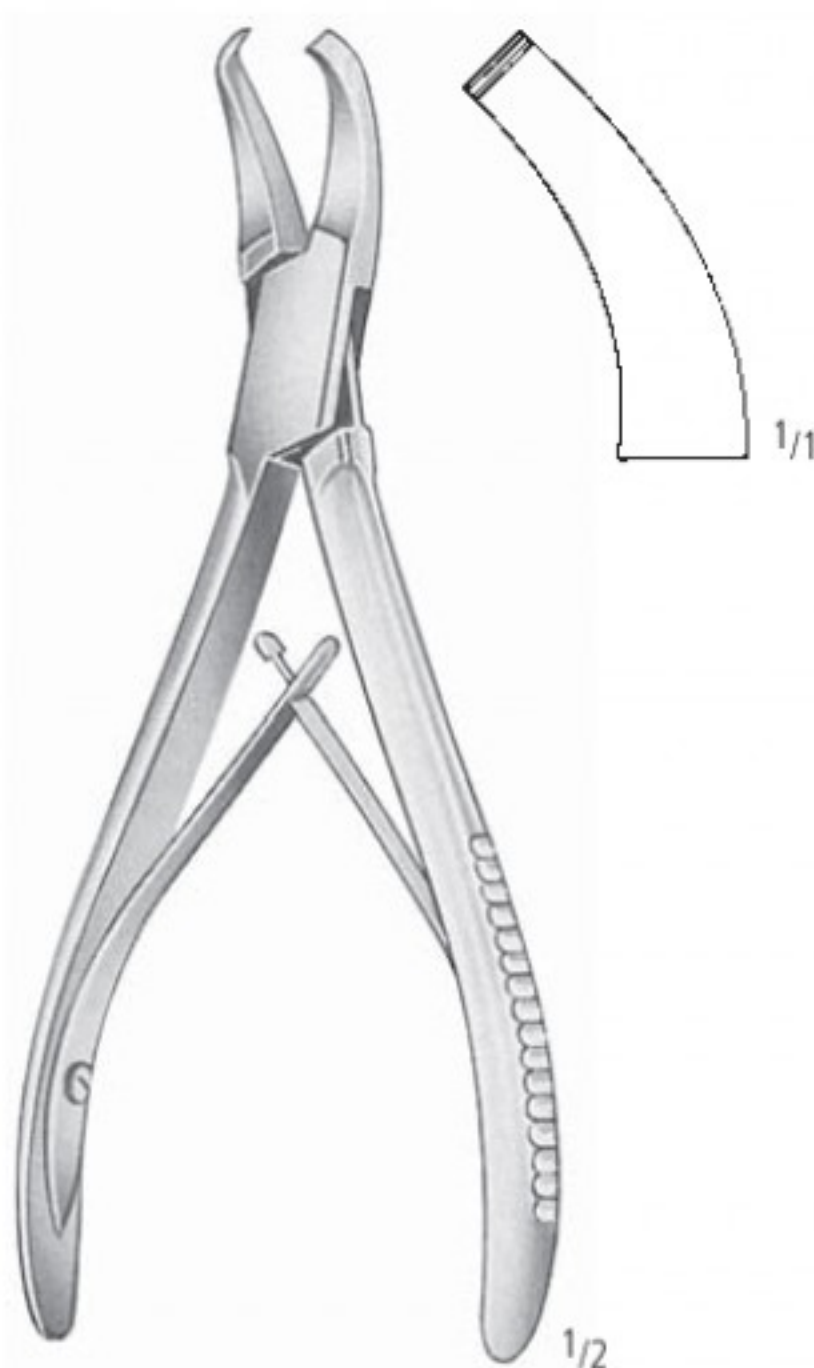

CLEVELAND-GARDNER
 KA 872/16
 18,0 cm/6 1/4"

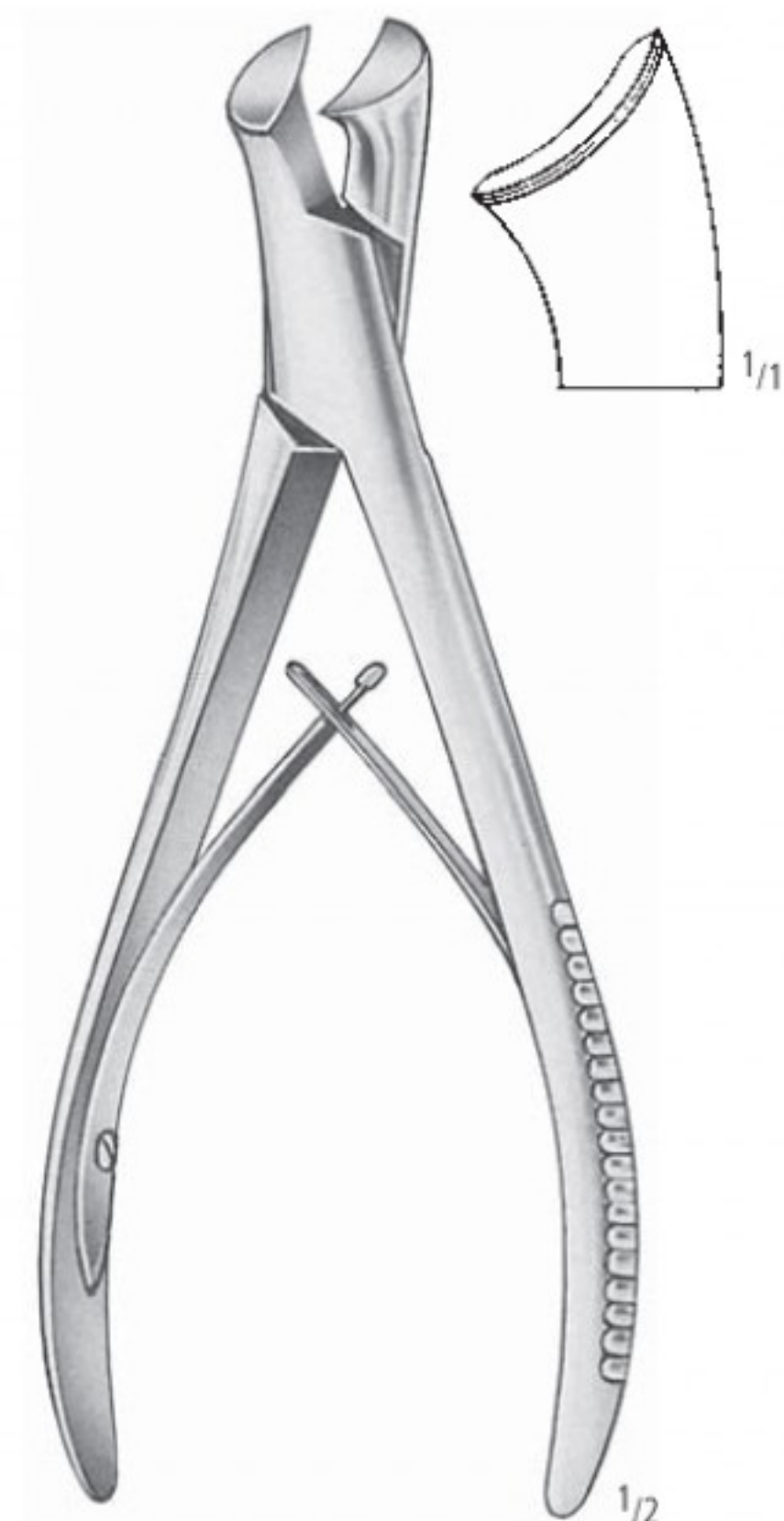

MARKWALDER
 KA 874/20
 20,0 cm/8"

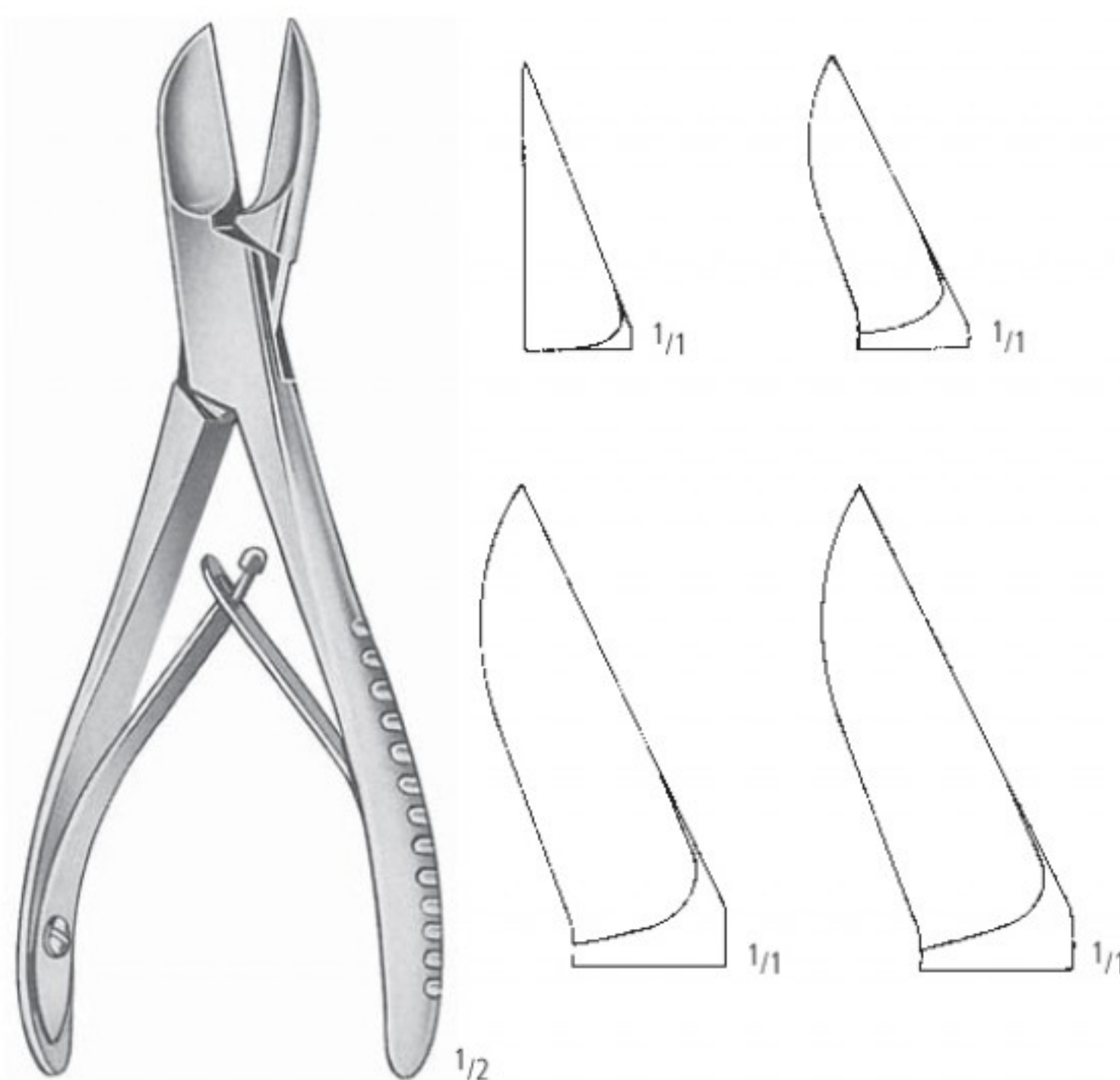
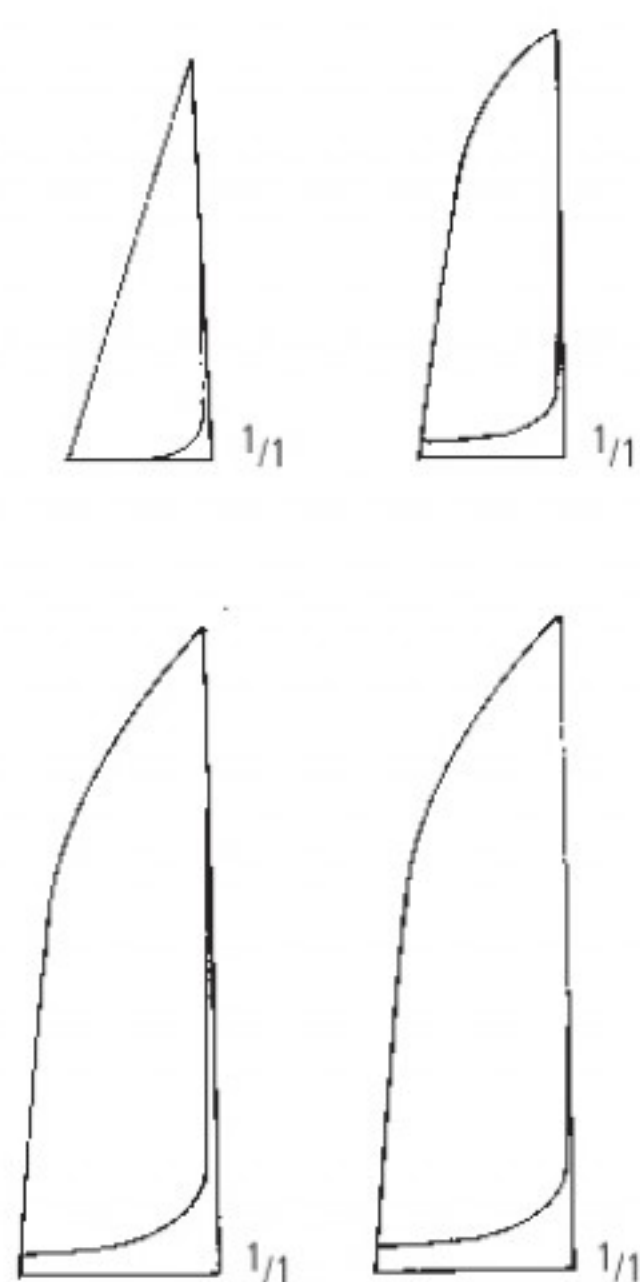

LISTON
 14,0 cm/5 1/2"
 17,0 cm/6 3/4"
 19,0 cm/7 1/2"
 22,0 cm/8 3/4"

KA 881/14
 KA 881/17
 KA 881/19
 KA 881/22



LITTAUER-LISTON
 KA 882/15
 15,0 cm/6"

AA
 AB
 AC
 AD
 AE
 AF
 AK
 AL
 AO
 KA
 KK
 X

KA

KA 880/14
 KA 880/17
 KA 880/19
 KA 880/22

Knochensplitterzangen
 Bone Cutting Forceps
 Pinzas cortantes para huesos
 Pincas coupantes à os
 Cesoie per ossa

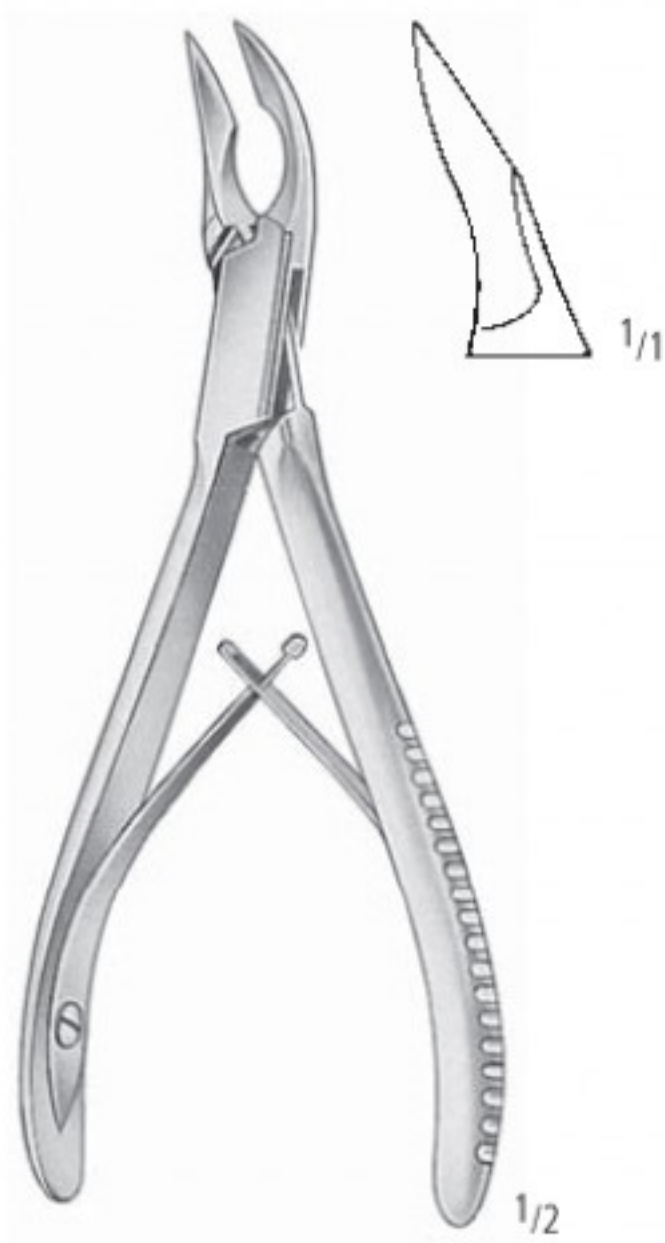

CLEVELAND
 KA 884/15
 15,0 cm/6"



CLEVELAND
 KA 884/17
 17,0 cm/6³/₄"



KA 885/12
 12,0 cm/4³/₄"

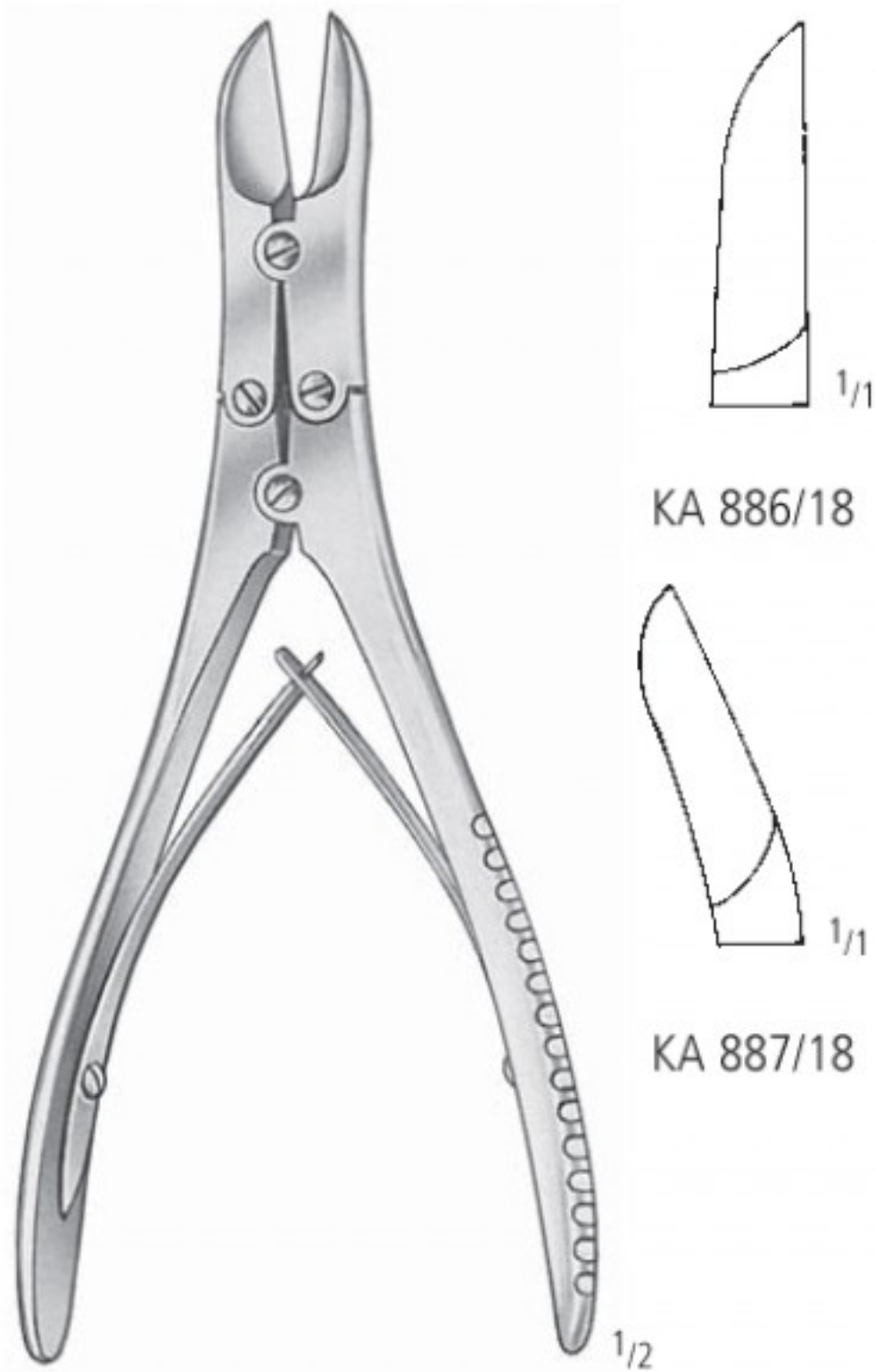

KA 886/18



KA 887/18

RUSKIN-LISTON
 18,5 cm/7¹/₄"



MC INDOE
 KA 888/17
 17,5 cm/7"

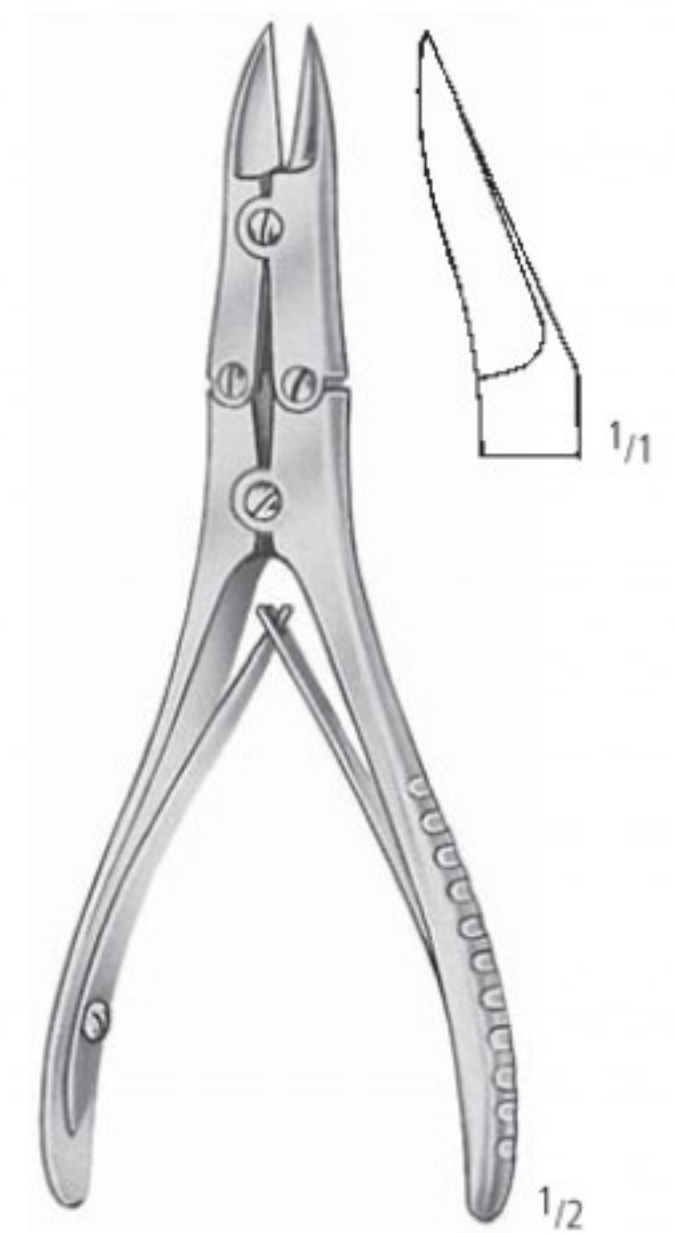

WALTON-LISTON
 KA 889/01
 15,0 cm/6"

Knochensplitterzangen
 Bone Cutting Forceps
 Pinzas cortantes para huesos
 Pincas coupantes à os
 Cesoie per ossa

AA

AB

AC

AD

AE

AF

AK

AL

AO

KA

KK

X

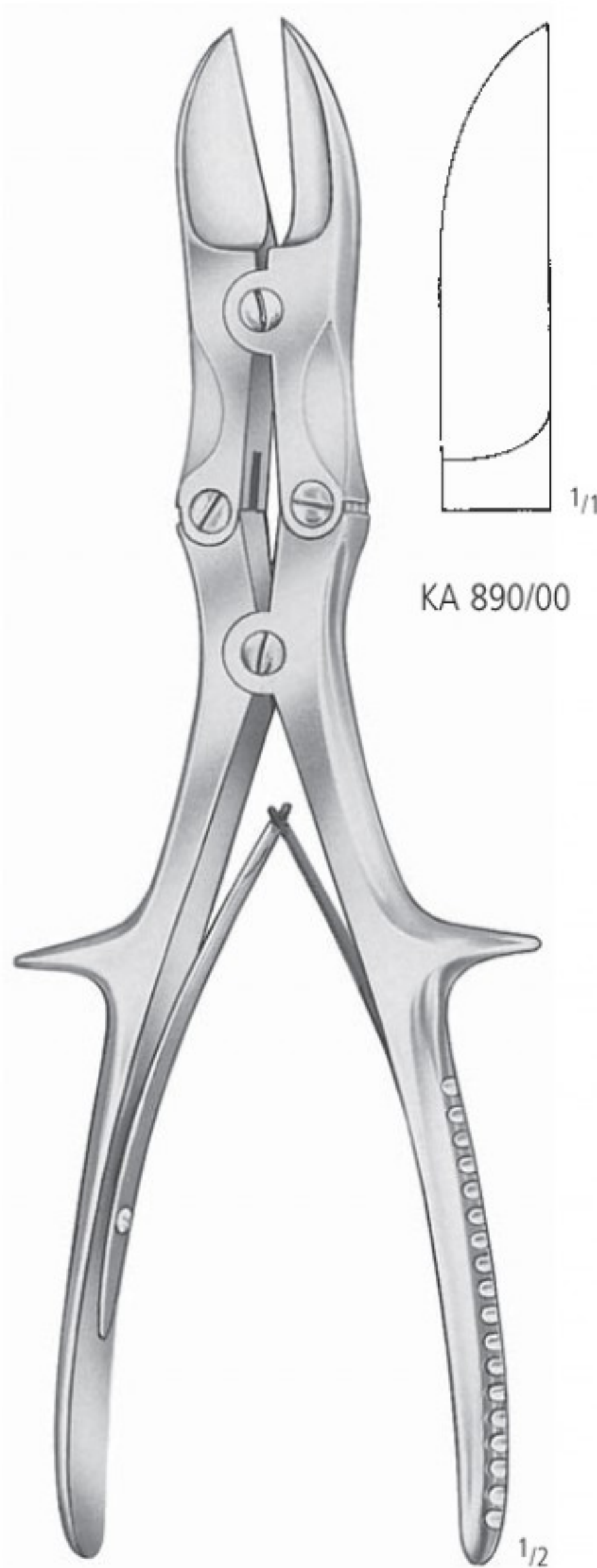

KA 890/00



KA 890/30

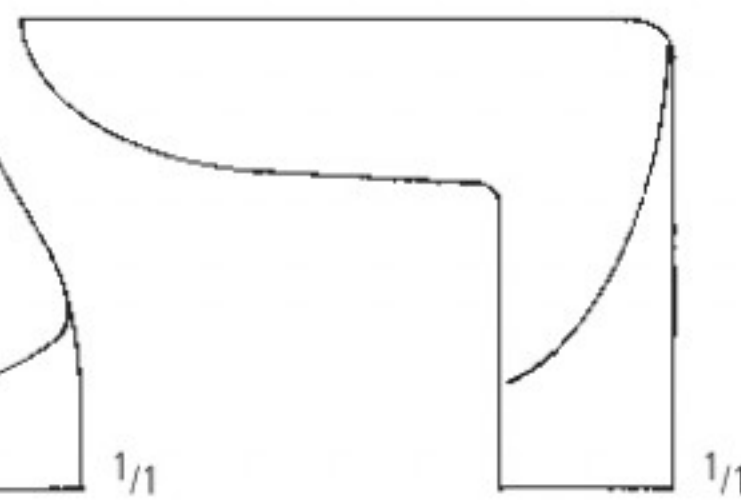

KA 890/90



LISTON-KEY (TUDOR-EDWARDS)
 KA 892/27
 27,0 cm/10¹/₂"

STILLE-LISTON
 27,0 cm/10¹/₂"

Knochensplitterzangen
 Bone Cutting Forceps
 Pinzas cortantes para huesos
 Pincas coupantes à os
 Cesioie per ossa



SEMB
 KA 893/24
 24,0 cm/9¹/₂"

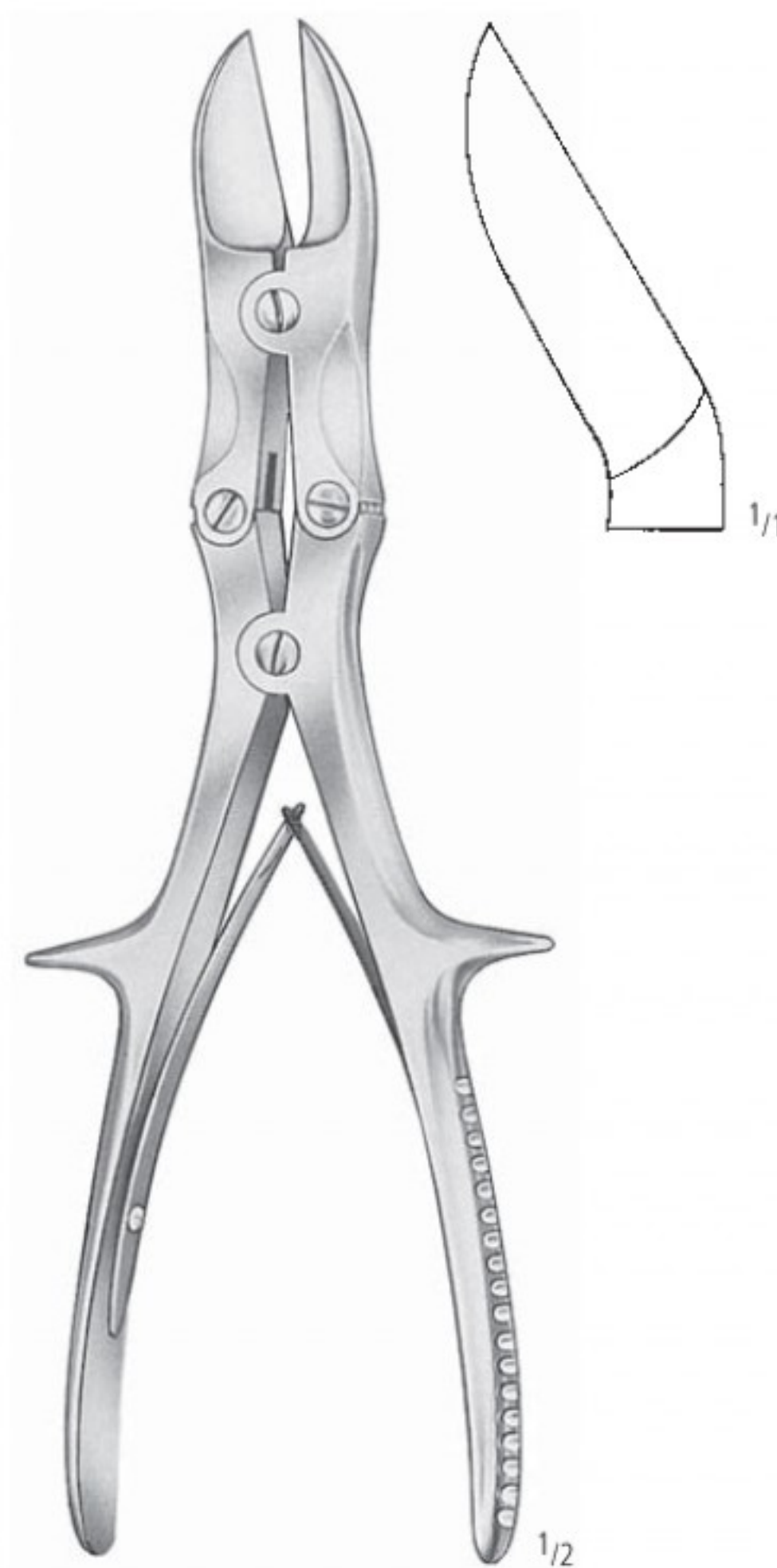

LISTON
 KA 894/23
 23,5 cm/9¹/₄"

HERZ/THORAX
CARDIOVASCULAR
CARDIOVASCULAR
CARDIOVASCULAIRE
CARDIOVASCOLARE

KK

nopa[®] instruments

Rippen-Instrumente	Seite	235-238
Rib Instruments	Page	235-238
Instrumentos costales	Página	235-238
Instrumentes des côtes	Page	235-238
Strumenti per costali	Pagina	235-238
Rippensperrer	Seite	239-250
Rib Spreaders	Page	239-250
Separadores costales	Página	239-250
Ecateurs des côtes	Page	239-250
Divaricatori costali	Pagina	239-250
Clips, Bulldogklemmen	Seite	257-263
Clips, Bulldog Clamps	Page	257-263
Clips, Clamps Bulldog	Página	257-263
Clips, Clamps Bulldog	Page	257-263
Clips, Pinze Bulldog	Pagina	257-263
Atrauma-Klemmen	Seite	260-296
Atrauma Forceps	Page	260-296
Pinzas Atrauma	Página	260-296
Pinces atraumatiques	Page	260-296
Pinze Atrauma	Pagina	260-296



Rippen-Raspatorien
 Costal periosteotomes
 Periostótomos para costillas
 Rugines raspatoires
 Periostotomi costali

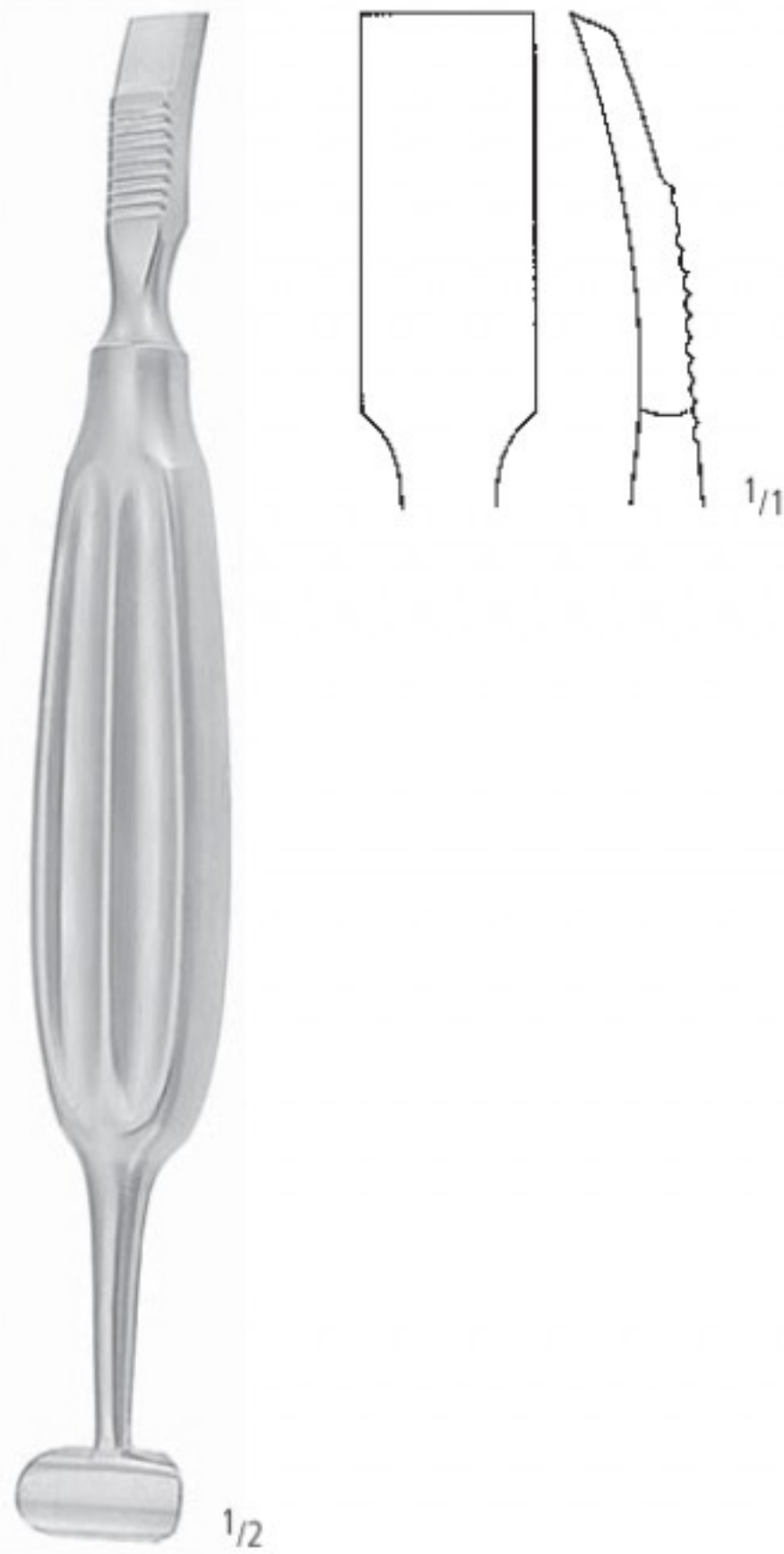

ALEXANDER
 KK 001/20
 20,0 cm/8"

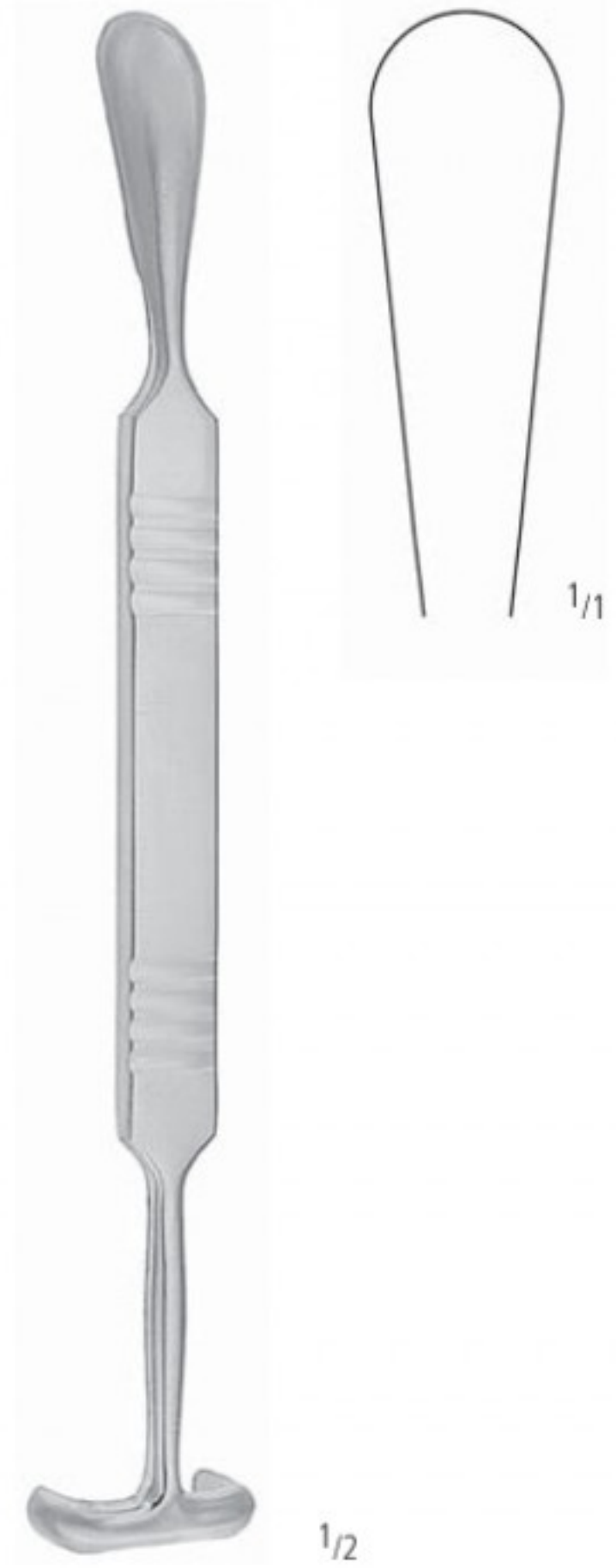

MATSON
 KK 002/22
 22,0 cm/8³/₄"



DOYEN
 KK 004/01
 17,0 cm/6³/₄"



DOYEN
 KK 004/02
 17,0 cm/6³/₄"



DOYEN
 KK 004/03
 18,0 cm/7"



DOYEN
 KK 004/04
 18,0 cm/7"

AA
 AB
 AC
 AD
 AE
 AF
 AK
 AL
 AO
 KA
 X
KK

Rippen-Raspatorien
 Costal periosteotomes
 Periostótomos para costillas
 Rugines raspatoires
 Periostotomi costali

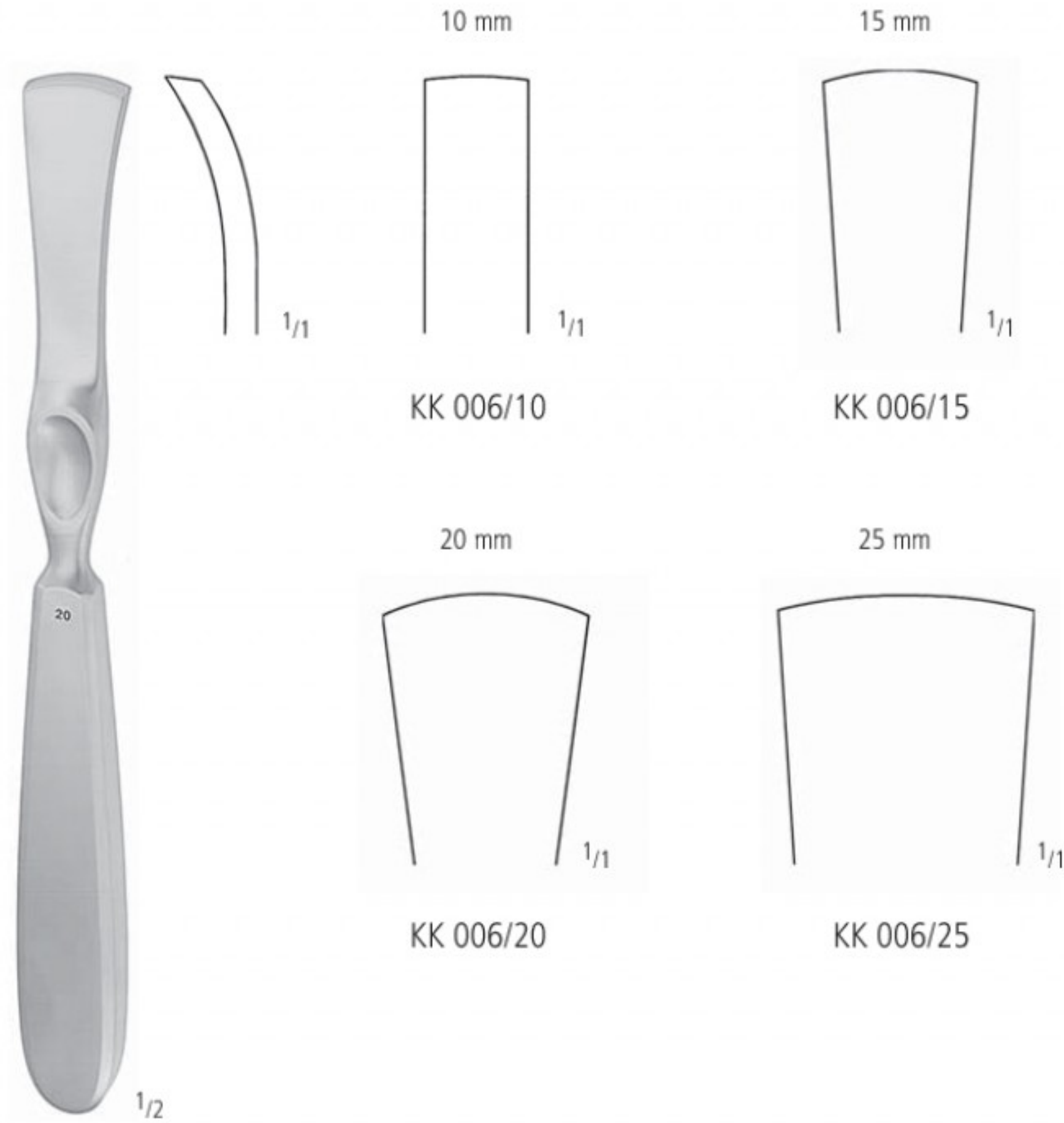

LAMBOTTE
 21,0 cm/8¹/₄"

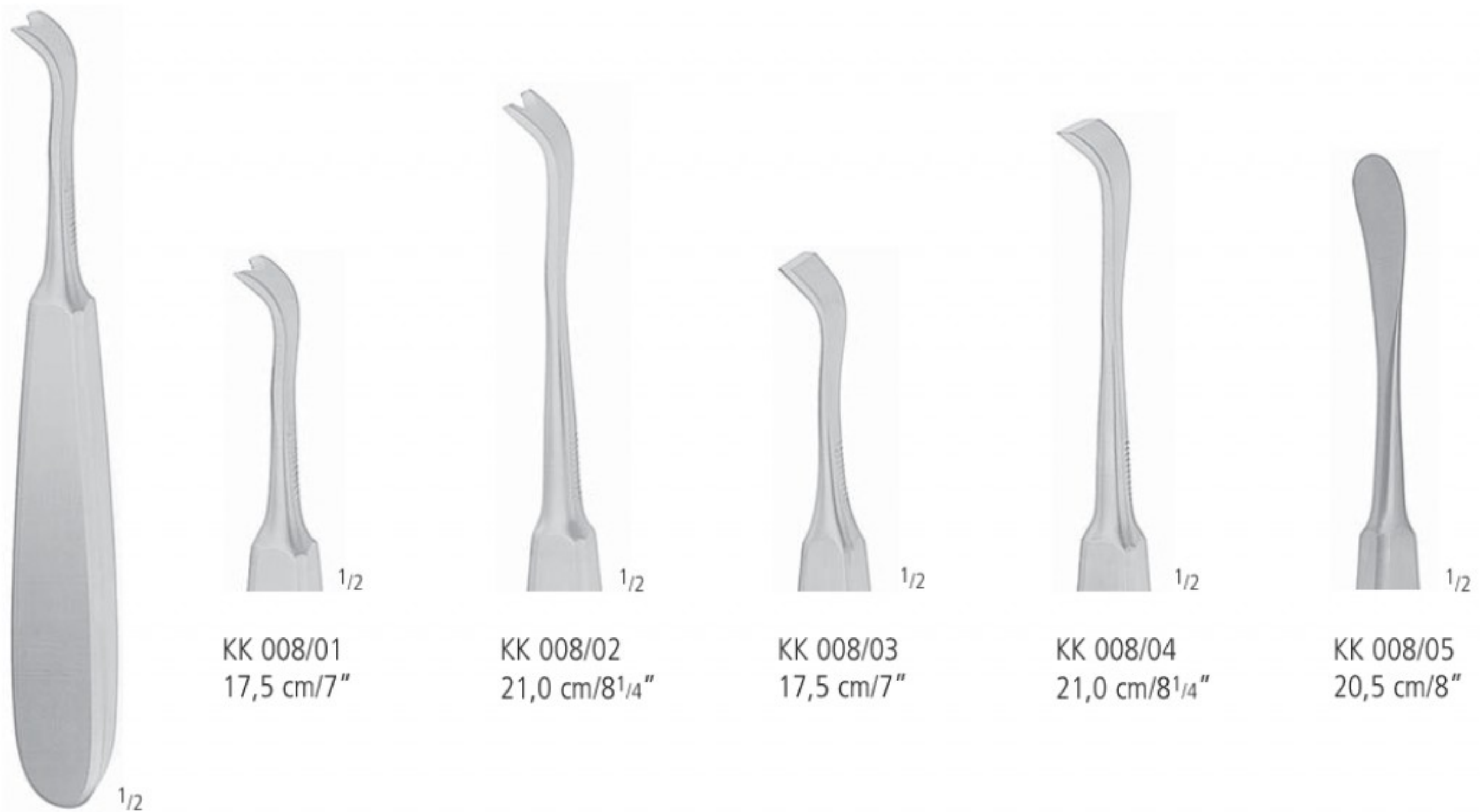

SEMB

Knochen- und Rippenscheren
 Bone and Rib Shears
 Cizallas para huesos, Costotomos
 Cisailles pour os, Costotomes
 Pinze per ossa e costole, Costotomi

AA
AB
AC
AD
AE
AF
AK
AL
AO
KA
X



1/3

KK 010/23
23,0 cm/9"



1/3

KK 011/22
22,0 cm/8³/₄"



1/3

GLUCK
KK 013/22
22,0 cm/8³/₄"



1/3

BETHUNE
KK 018/34
34,0 cm/13¹/₂"



1/3

SAUERBRUCH
KK 019/26
26,0 cm/10¹/₄"



1/3

KK 023/35
35,0 cm/13³/₄"

CORYLLOS
KK 021/35
35,0 cm/13³/₄"



Knochen- und Rippenscheren
 Bone and Rib Shears
 Cizallas para huesos, Costotomos
 Cisailles pour os, Costotomes
 Pinze per ossa e costole, Costotomi



1/3

GIERTZ-STILLE
 KK 024/27
 27,0 cm/10¹/₂"



1/3

BRUNNER



1/3

KK 027/32
 32,0 cm/12¹/₂"



1/3

KK 029/32
 32,0 cm/12¹/₂"



1/3

LEBSCHE
 KK 040/25
 25,0 cm/10"

Rippensperrer
 Rib Spreaders
 Separadores costales
 Ecarteurs des côtes
 Divaricatori costali



B H C
 40 mm 150 mm 110 mm

I.M.A. MAMMARIA RETRACTOR
 KK 056/00

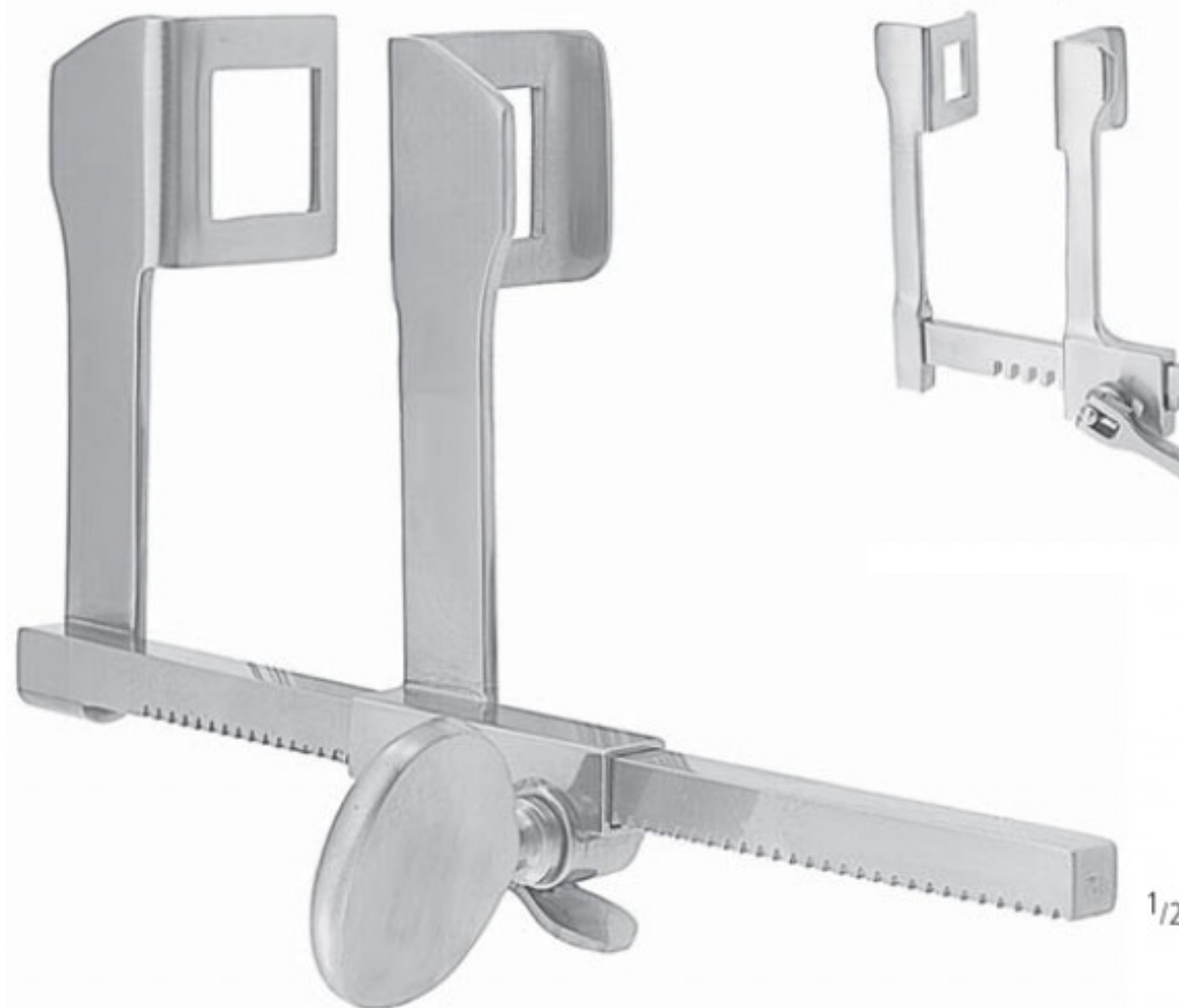

B H C
 30 mm 30 mm 90 mm

HAIGHT
 KK 080/00

AA
 AB
 AC
 AD
 AE
 AF
 AK
 AL
 AO
 KA
 X

KK

Rippensperrer
 Rib Spreaders
 Separadores costales
 Ecarteurs des côtes
 Divaricatori costali



B 45 mm H 45 mm C 160 mm

TUFFIER
 KK 084/16



B 44 mm H 48 mm C 178 mm

BADGLEY
 KK 086/18



B 20 mm H 25 mm C 105 mm

HERTZLER
 KK 088/10

Rippensperrer
 Rib Spreaders
 Separadores costales
 Ecarteurs des côtes
 Divaricatori costali

AA

AB

AC

AD

AE

AF

AK

AL

AO

KA

KK

X



B	H	C	FINOCCHIETTO-BABY
14 mm	15 mm	75 mm	KK 090/07



B	H	C	FINOCCHIETTO
30 mm	45 mm	150 mm	KK 092/01
46 mm	62 mm	190 mm	KK 092/02
80 mm	65 mm	190 mm	KK 092/03

Rippensperrer
Rib Spreaders
Separadores costales
Ecarteurs des côtes
Divaricatori costali

ALUMINIUM



B	H	C	ANKENEY
19 mm	25 mm	127 mm	KK 093/04

Rippensperrer
 Rib Spreaders
 Separadores costales
 Ecarteurs des côtes
 Divaricatori costali

AA

AB

AC

AD

AE

AF

AK

AL

AO

KA

KK

X

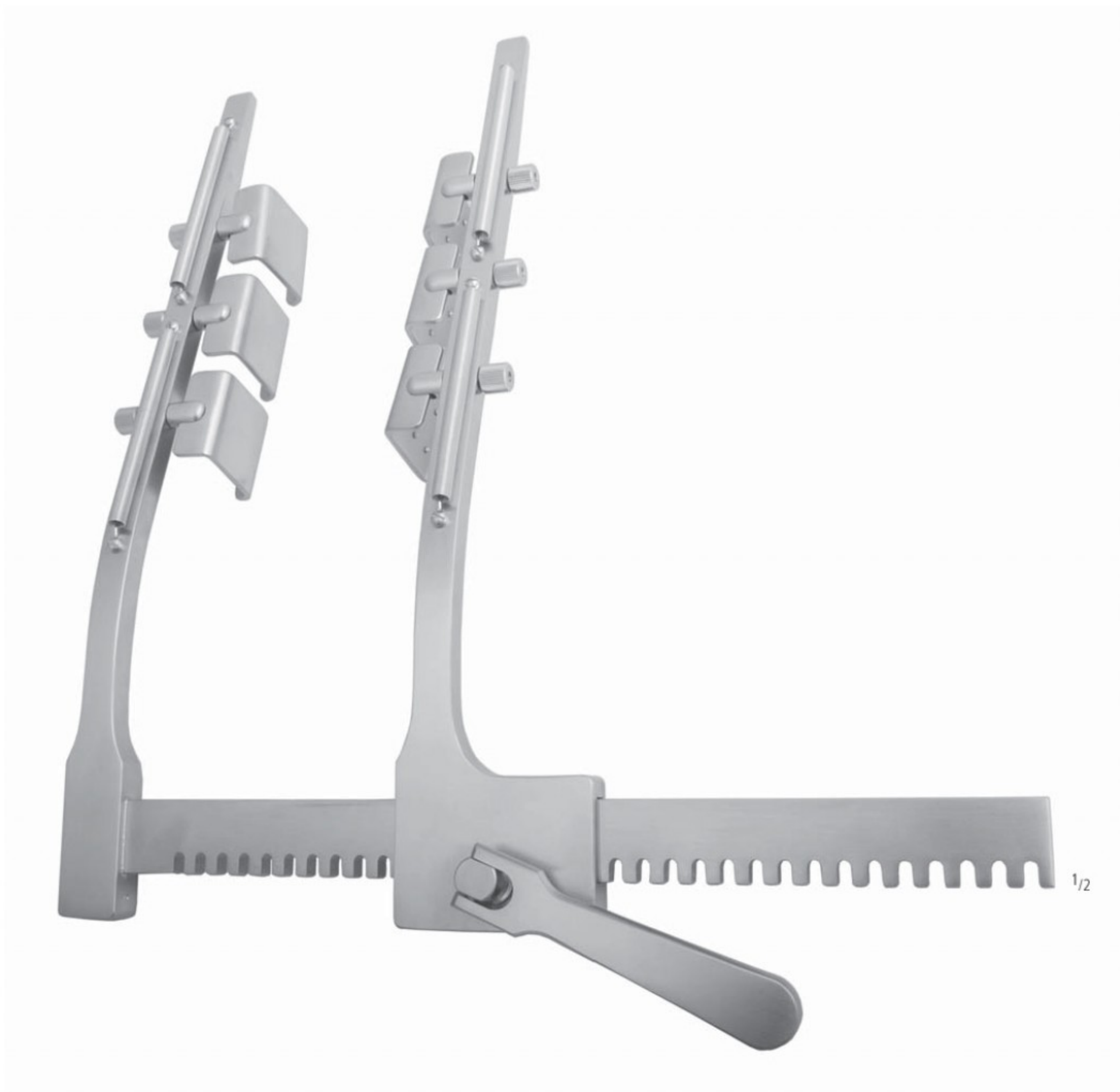

B	H	C	ANKENY
35 mm	32 mm	178 mm	KK 093/06



Rippensperrer
 Rib Spreaders
 Separadores costales
 Ecarteurs des côtes
 Divaricatori costali

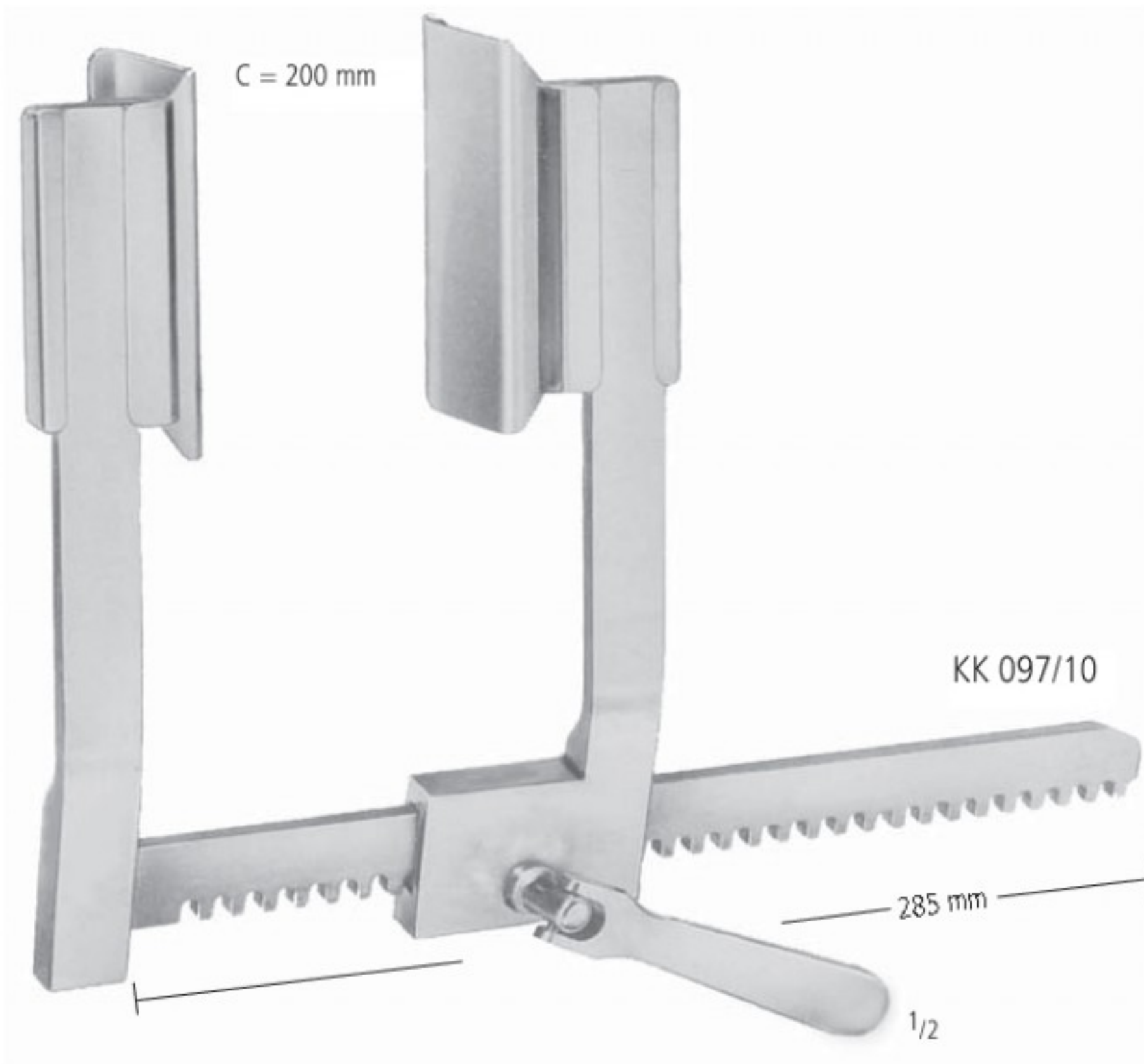

DE BAKEY

- KK 097/00 = 1 x KK 097/10
- + 2 x KK 097/01
- + 2 x KK 097/02
- + 2 x KK 097/03

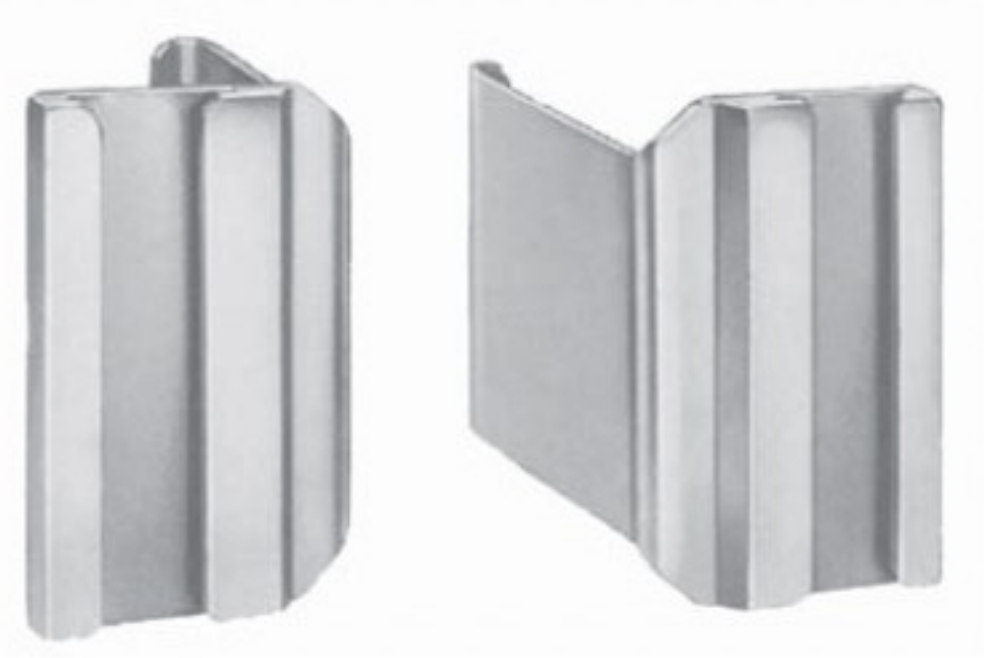

KK 097/01
 60 x 60 mm



KK 097/02
 50 x 80 mm



KK 097/03
 40 x 100 mm



KK 097/05
 50 x 66 mm



KK 097/04
 80 x 60 mm

Sternotomy

AA
 AB
 AC
 AD
 AE
 AF
 AK
 AL
 AO
 KA
 KK
 X

KK

Rippensperrer
 Rib Spreaders
 Separadores costales
 Ecarteurs des côtes
 Divaricatori costali

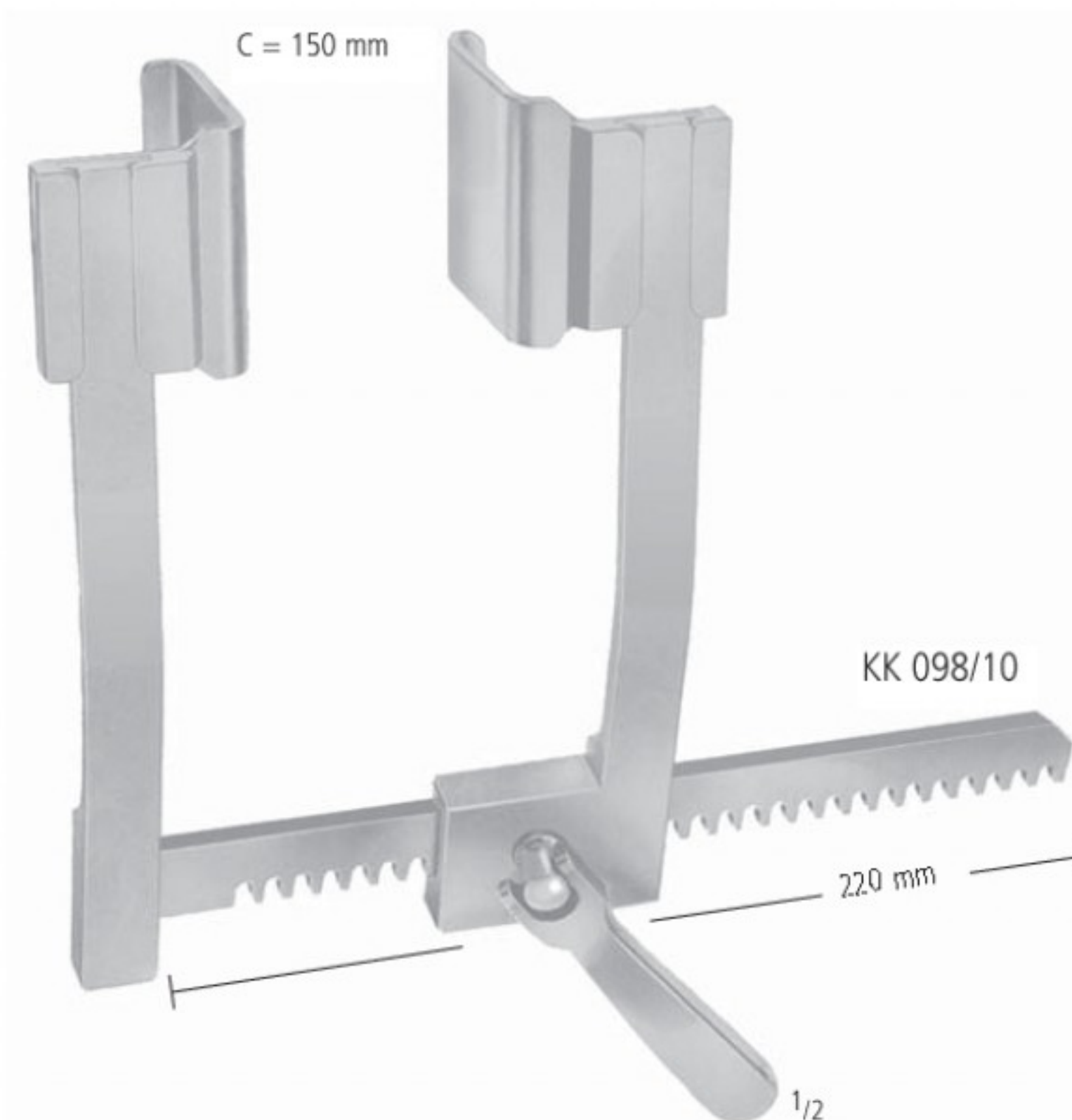

DE BAKEY

- KK 098/00 = 1 x KK 098/10
 + 2 x KK 098/01
 + 2 x KK 098/02
 + 2 x KK 098/03



KK 098/01
 30 x 30 mm



KK 098/02
 40 x 40 mm



KK 098/03
 50 x 50 mm

Rippensperrer
 Rib Spreaders
 Separadores costales
 Ecarteurs des côtes
 Divaricatori costali

AA

AB

AC

AD

AE

AF

AK

AL

AO

KA

KK

X



MORSE FAVALORO

B	H	C	
19 mm	29 mm	200 mm	KK 099/01
12 mm	20 mm	200 mm	KK 099/02

Rippensperrer
 Rib Spreaders
 Separadores costales
 Ecarteurs des côtes
 Divaricatori costali

ALUMINIUM

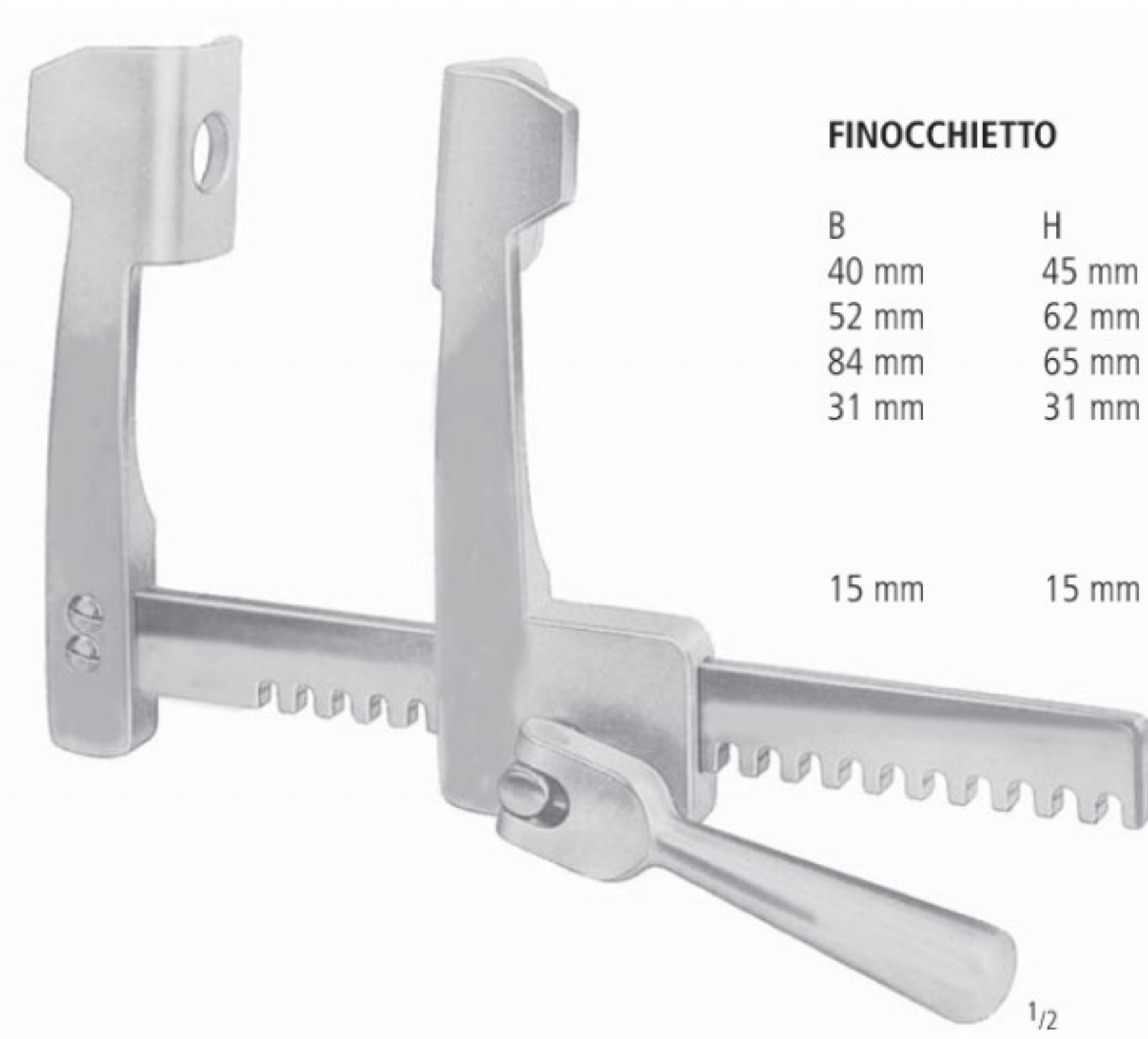

FINOCCHIETTO

B	H	C	
40 mm	45 mm	135 mm	KK 100/01
52 mm	62 mm	175 mm	KK 100/02
84 mm	65 mm	175 mm	KK 100/03
31 mm	31 mm	100 mm	KK 102/30
15 mm	15 mm	75 mm	KK 104/00



Rippensperrer
 Rib Spreaders
 Separadores costales
 Ecarteurs des côtes
 Divaricatori costali

ALUMINIUM

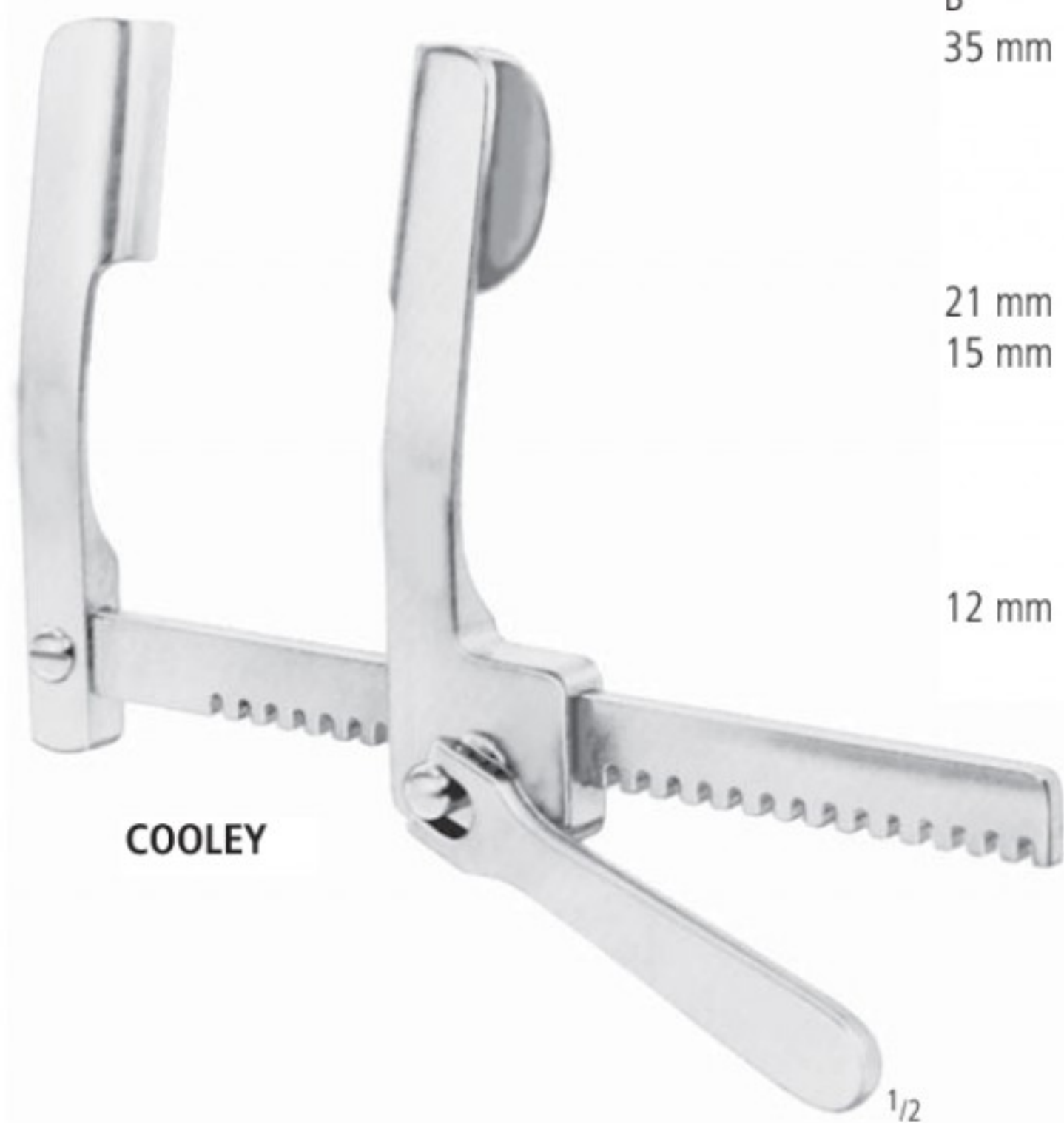

COOLEY

B	H	C	
35 mm	50 mm	200 mm	KK 106/01

21 mm	44 mm	150 mm	KK 106/02
15 mm	30 mm	140 mm	KK 106/03

12 mm	16 mm	95 mm	KK 106/04
-------	-------	-------	-----------



CASTANEDA

B	H	C	
15 mm	60 mm	120 mm	KK 110/01

12 mm	45 mm	70 mm	KK 110/02
-------	-------	-------	-----------

10,5 mm	32 mm	65 mm	KK 110/03
---------	-------	-------	-----------



AA

AB

AC

AD

AE

AF

AK

AL

AO

KA

KK

X

Rippensperrer
 Rib Spreaders
 Separadores costales
 Ecarteurs des côtes
 Divaricatori costali

ALUMINIUM

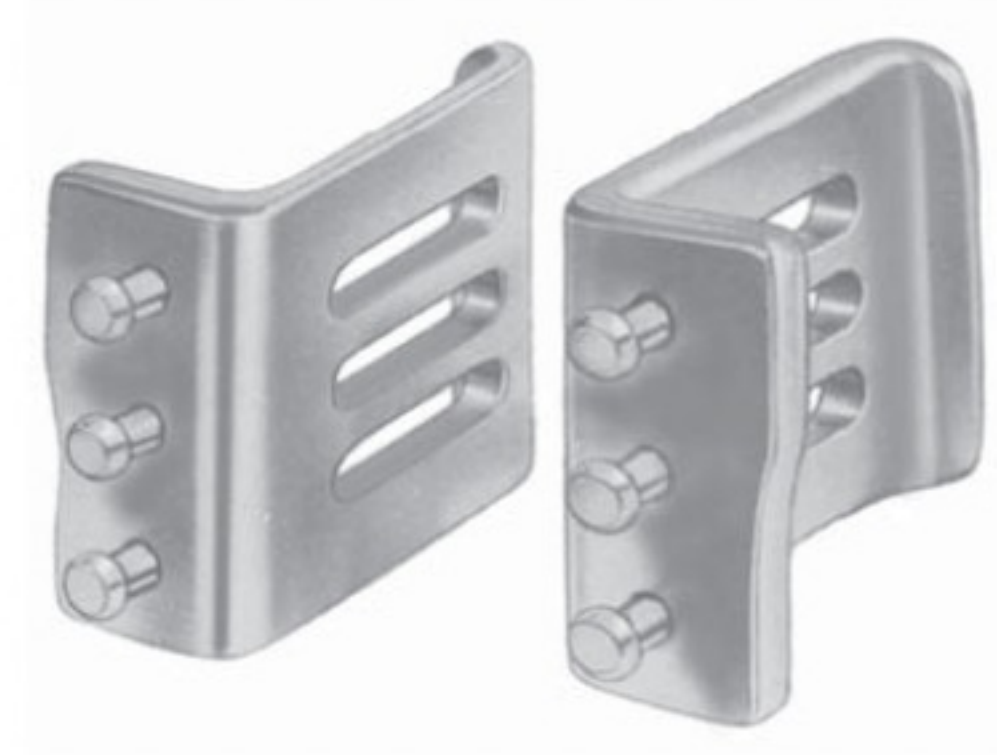

mit 2 Paar Valven
 with 2 pairs of blades
 con 2 pares de valvas
 avec 2 paires des valves
 con 2 paia di valve

BURFORD

B	H	C	
65 mm	62 mm		
47 mm	62 mm	200 mm	KK 120/01
65 mm	62 mm		
47 mm	62 mm	250 mm	KK 120/02
65 mm	62 mm		
47 mm	62 mm	300 mm	KK 120/03
48 mm	42 mm		
34 mm	42 mm	135 mm	KK 120/04



HERZ/THORAX CARDIOVASCULAR CARDIOVASCULAR CARDIOVASCULAIRE CARDIOVASCOLARE

Spatel
Spatulas
Espátulas
Spatules
Spatole



3 mm
stumpf
blunt
romo
mousse
smusse

KK 150/18
18,5 cm/7¹/₄"

KK 150/21
21,5 cm/8¹/₂"



KK 152/23
23,0 cm/9"

DAVIS
KK 153/24
24,5 cm/9³/₄"

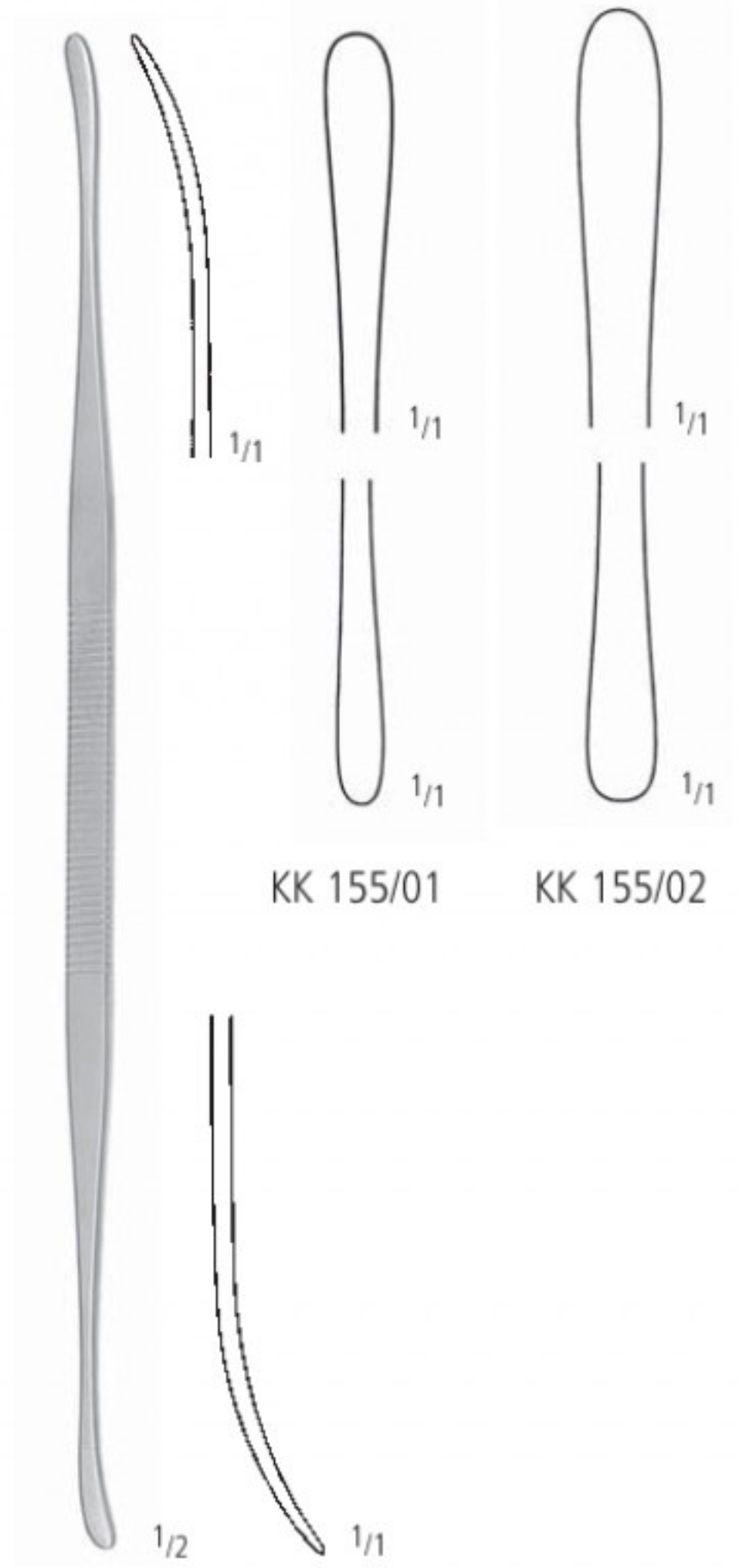

KK 155/01

KK 155/02

TÖNNIS
24,0 cm/9¹/₂"



KK 156/01
14,0 cm/5¹/₂"

KK 156/02
23,5 cm/9¹/₄"

SCHMID



PENFIELD
KS 638/01
17,5 cm/7"

AA
AB
AC
AD
AE
AF
AK
AL
AO
KA
X

KK

Feine Wundhaken
 Delicate Hooks
 Ganchos
 Crochets très fins
 Divaricatori sottili



BROM
 KK 160/17
 17,0 cm/6³/₄"



CRILE
 KK 162/20
 20,0 cm/8"



CUSHING
 19,0 cm/7¹/₂"



AK 036/01



AK 036/02



KRAYENBÜHL
 18,5 cm/7¹/₄"



KK 164/01



KK 164/02



KK 164/03



KK 164/04

Feine Wundhaken
 Delicate Hooks
 Ganchos
 Crochets très fins
 Divaricatori sottili

AA

AB

AC

AD

AE

AF

AK

AL

AO

KA

KK

X

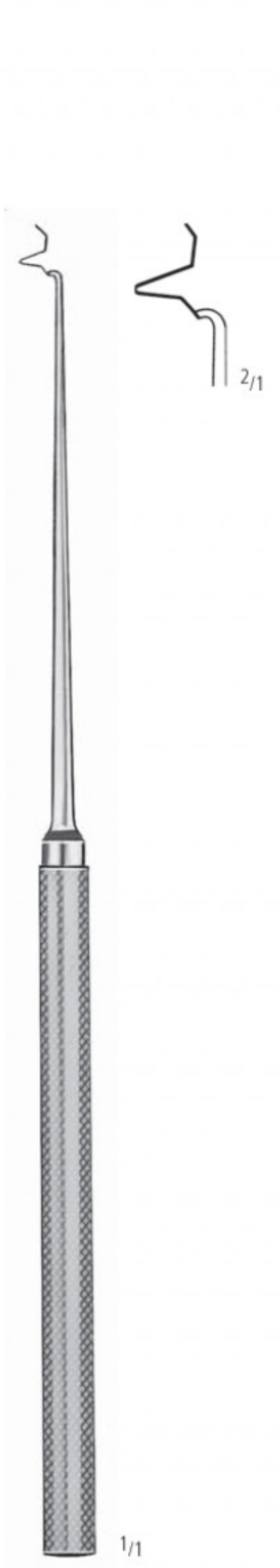

BIEMER
 KK 165/16
 16,0 cm/6¹/₄"

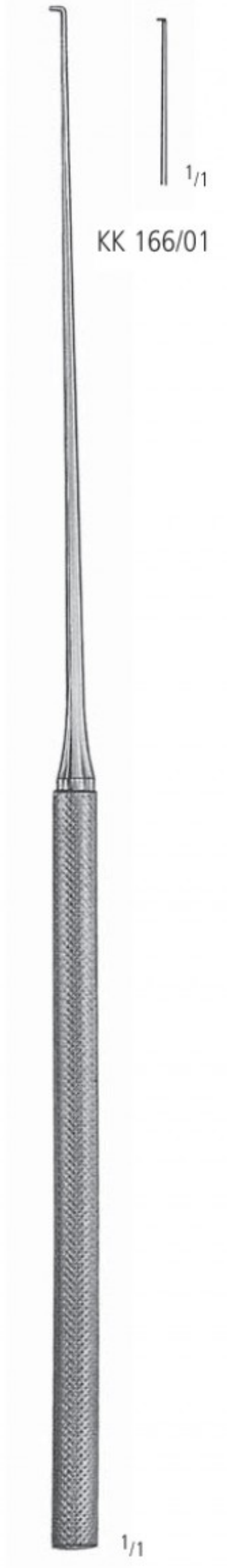

FISCH
 18,5 cm/7¹/₄"

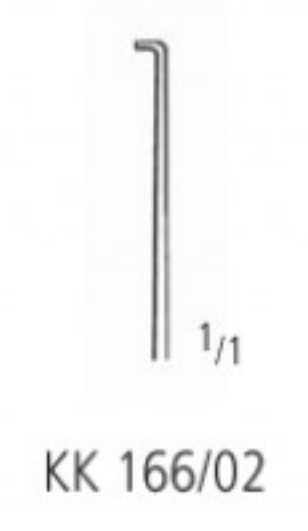

KK 166/01 KK 166/02

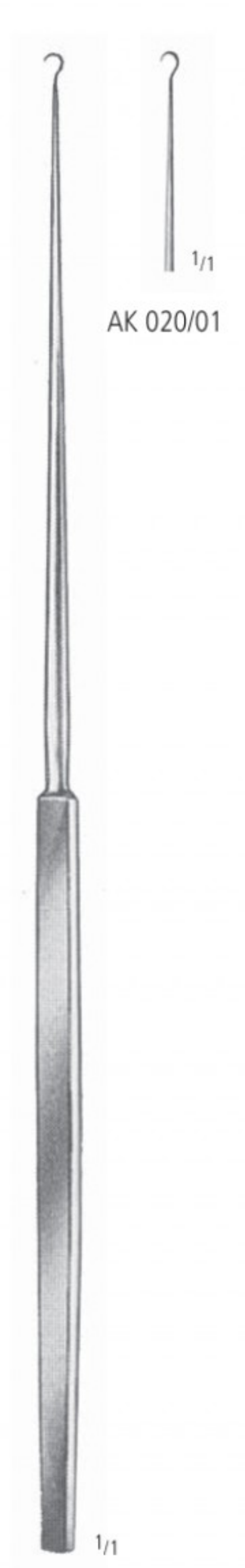

GILLIES
 18,0 cm/7"



AK 020/01 AK 020/02



KILNER
 AK 022/15
 15,0 cm/6"

Rippenkonraktoren
 Rib contractors
 Aproximadores para costillas
 Rapprocheurs des côtes
 Approssimatori costali



SELLORS
 KK 170/19
 19,0 cm/7½"



BAILEY-BABY
 KK 172/14
 14,0 cm/5½"

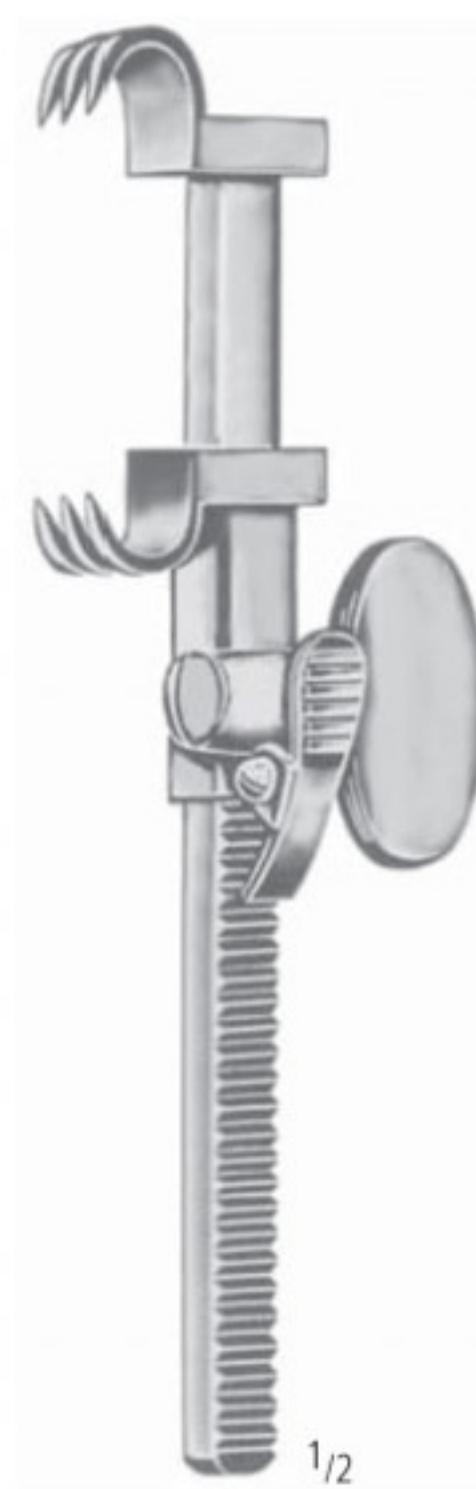

BAILEY
 KK 174/16
 16,0 cm/6¼"

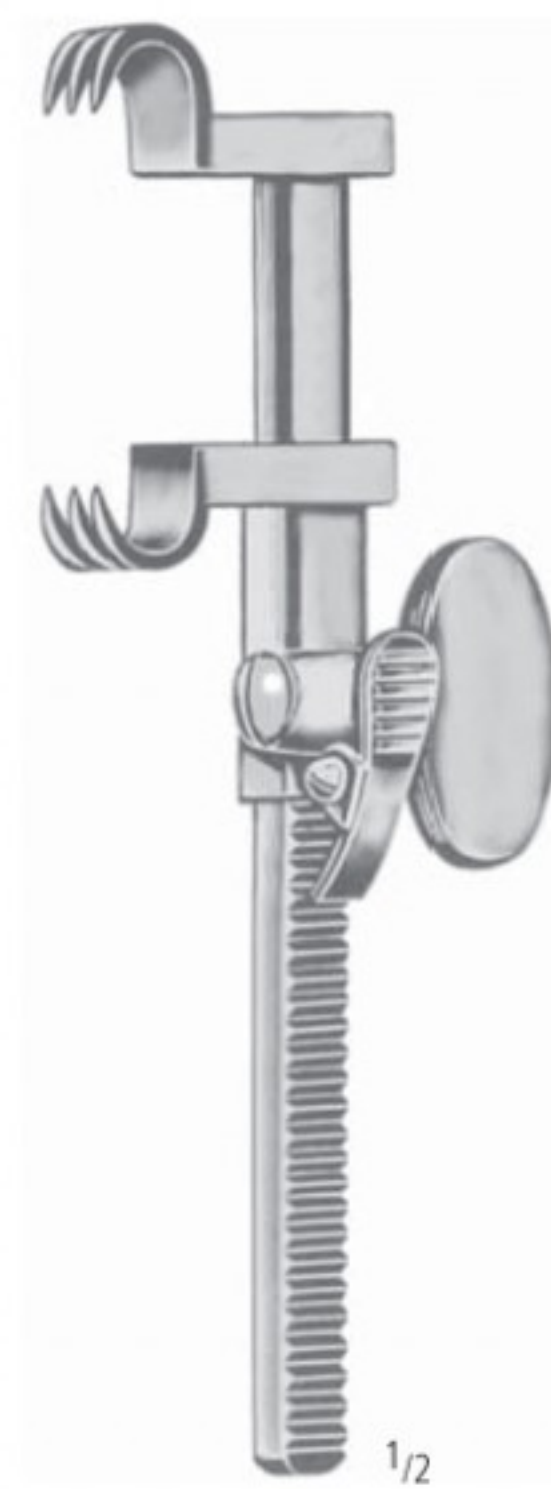

BAILEY-GIBBON
 KK 176/16
 16,0 cm/6¼"

Lungenspatel
 Lung Spatulas
 Espátulas pulmonares
 Spatules pulmonaires
 Spatole per polmone

AA
 AB
 AC
 AD
 AE
 AF
 AK
 AL
 AO
 KA
 KK
 X



ALLISON

KK 180/26	KK 180/32
26,0 cm/10 ¹ / ₄ "	32,0 cm/12 ¹ / ₂ "

Atriumhaken
 Atrium retractor
 Separadores auriculares
 Ecarteurs à atrium
 Divaricatori atriali

leicht gezahnt
 slightly serrated

45 x 30 mm

leicht gezahnt
 slightly serrated

45 x 35 mm

45 x 48 mm

leicht gezahnt
 slightly serrated

45 x 48 mm

25 x 46 mm

COOLEY-STRUCK
 KK 188/01
 24,0 cm/9¹/₂"

COOLEY-STRUCK
 KK 188/02
 24,0 cm/9¹/₂"

COOLEY
 KK 190/01
 24,5 cm/9³/₄"

COOLEY
 KK 190/02
 24,5 cm/9³/₄"

COOLEY
 KK 190/03
 25,5 cm/10"

HERZ/THORAX CARDIOVASCULAR CARDIOVASCULAR CARDIOVASCULAIRE CARDIOVASCOLARE

Clips
Clips
Clips
Clips
Clips

AA
AB
AC
AD
AE
AF
AK
AL
AO
KA
KK
X

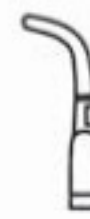

F
Schließkraft
Closing force
Presión
Pression
Pressione

L	KK 300/01	KK 300/02	KK 300/03	KK 300/04	KK 300/05	KK 300/06	KK 300/07	
	4 mm	6 mm	8 mm	10 mm	6 mm	6 mm	6 mm	
W	0,75 mm	1 mm	2 mm	2 mm	1 mm	1 mm	1 mm	
F	125 gr	100 gr	85 gr	60 gr	85 gr	85 gr	85 gr	



KK 302/14
14,0 cm/5 1/2"



KK 303/18
18,0 cm/7"

Clips
Clips
Clips
Clips
Clips



BIEMER

	KK 306/01	KK 306/02	KK 306/03
L	6 mm	9 mm	9 mm
W	4 mm	5 mm	5 mm
F	30-40 gr	30-40 gr	20-25 gr

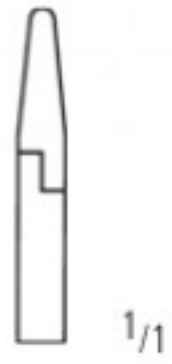
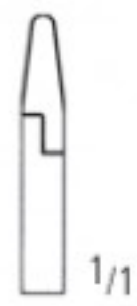

KK 308/01
14,5 cm/5³/₄"



KK 308/02
14,5 cm/5³/₄"



F
Schließkraft
Closing force
Presión
Pression
Pressione

W
Maulöffnung
Opening
Abertura
Overture
Apertura

MEHDORN



	KK 310/01
L	4 mm
W	1,0 mm
F	10-15 gr



	KK 310/02
L	4 mm
W	1,4 mm
F	15-20 gr



	KK 310/03
L	6 mm
W	1,0 mm
F	10-15 gr



	KK 310/04
L	6 mm
W	1,4 mm
F	15-20 gr

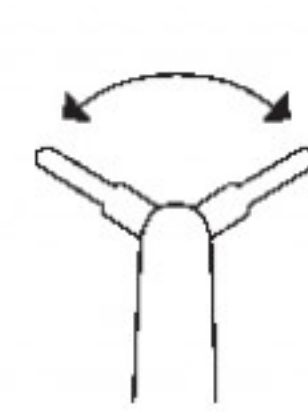

KK 312/15
15,0 cm/6"

Clips
Clips
Clips
Clips

AA

AB

AC

AD

AE

AF

AK

AL

AO

KA

KK

X



1/1

MÜLLER

F = 50gr
F = 80gr

F
Schließkraft
Closing force
Presión
Pression
Pressione



1/1

KK 314/50
KK 314/80



1/1

KK 315/50
KK 315/80



1/1

KK 316/50
KK 316/80



1/1

KK 317/50
KK 317/80



1/1

KK 318/50
KK 318/80



1/1

DE BAKEY-HESS
KK 320/01



1/1

DE BAKEY-HESS
KK 320/02

Atrauma Bulldogklemmen
 Atrauma Bulldog Clamps
 Atrauma Clamps Bulldog
 Clamps Atrauma Bulldog
 Pinze Atrauma Bulldog



DE BAKEY



1/1

DE BAKEY



1/1

KK 350/07
7,5 cm/3"



1/1

KK 350/08
8,5 cm/3 1/2"



1/1

KK 350/10
10,5 cm/4 1/4"



1/1

KK 350/12
12,0 cm/4 3/4"



1/1

DE BAKEY



1/1

KK 351/07
7,0 cm/2 3/4"



1/1

KK 351/08
8,0 cm/3 1/4"

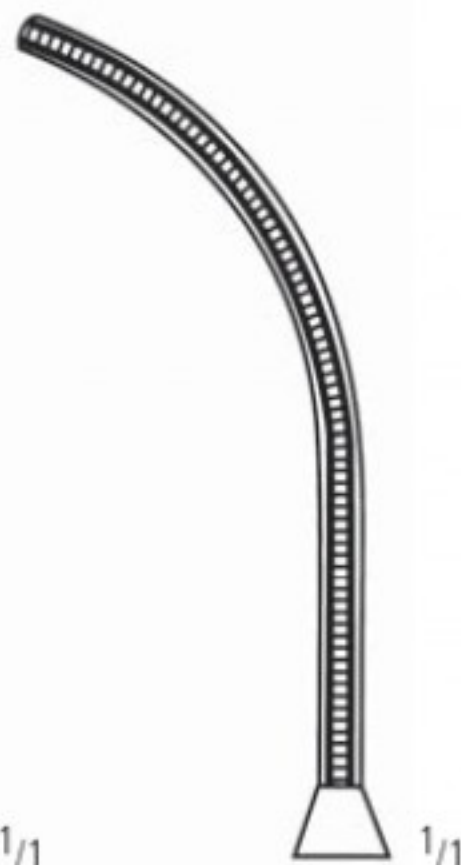

1/1

KK 351/10
10,0 cm/4"

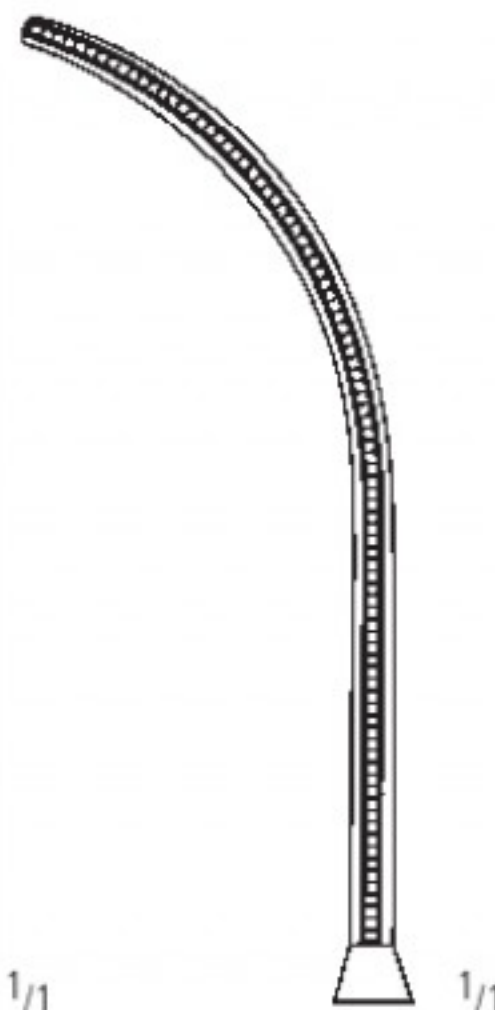

1/1

KK 351/12
11,5 cm/4 1/2"

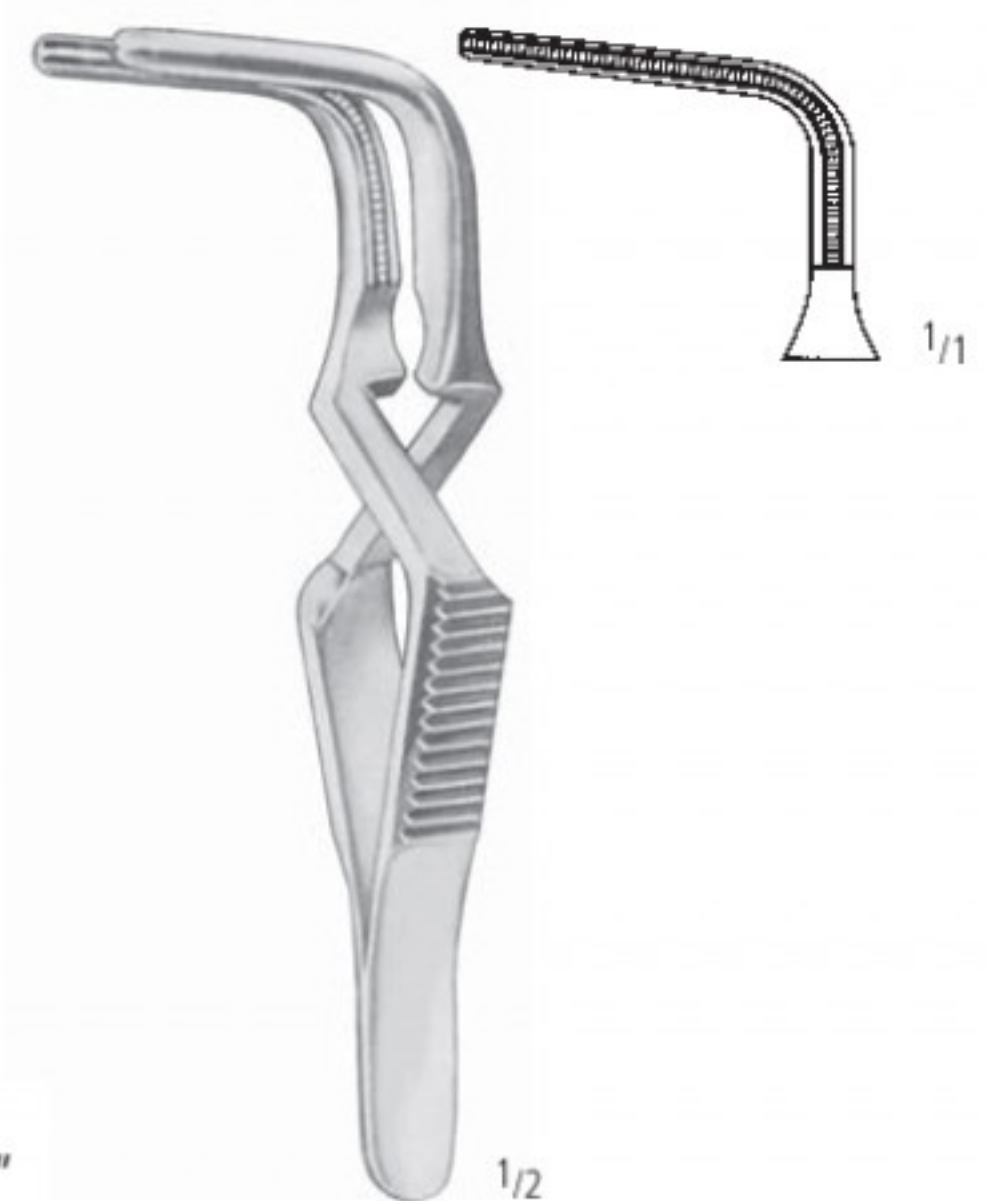

1/2

SANTULLI
 KK 357/07
 7,0 cm/2 3/4"

Atrauma Bulldogklemmen
 Atrauma Bulldog Clamps
 Atrauma Clamps Bulldog
 Clamps Atrauma Bulldog
 Pinze Atrauma Bulldog



DE BAKKEY



GLOVER



KK 370/06
6,0 cm/2 1/2"



KK 370/07
7,5 cm/2 3/4"



KK 370/09
9,0 cm/3 1/2"



KK 370/11
11,0 cm/4 1/2"



GLOVER



KK 371/06
5,5 cm/2 1/4"



KK 371/07
6,5 cm/2 1/2"



KK 371/09
8,5 cm/3 1/3"



KK 371/11
10,5 cm/4 1/4"



GLOVER
KK 372/05
5,0 cm/2"

AA
AB
AC
AD
AE
AF
AK
AL
AO
KA
KK
X

Atrauma Bulldogklemmen
 Atrauma Bulldog Clamps
 Atrauma Clamps Bulldog
 Clamps Atrauma Bulldog
 Pinze Atrauma Bulldog



DE BAKEY



DE BAKEY-SATINSKY
 KK 373/07
 7,0 cm/2³/₄"



DE BAKEY-CAROTIS
 KK 373/09
 9,0 cm/3¹/₂"

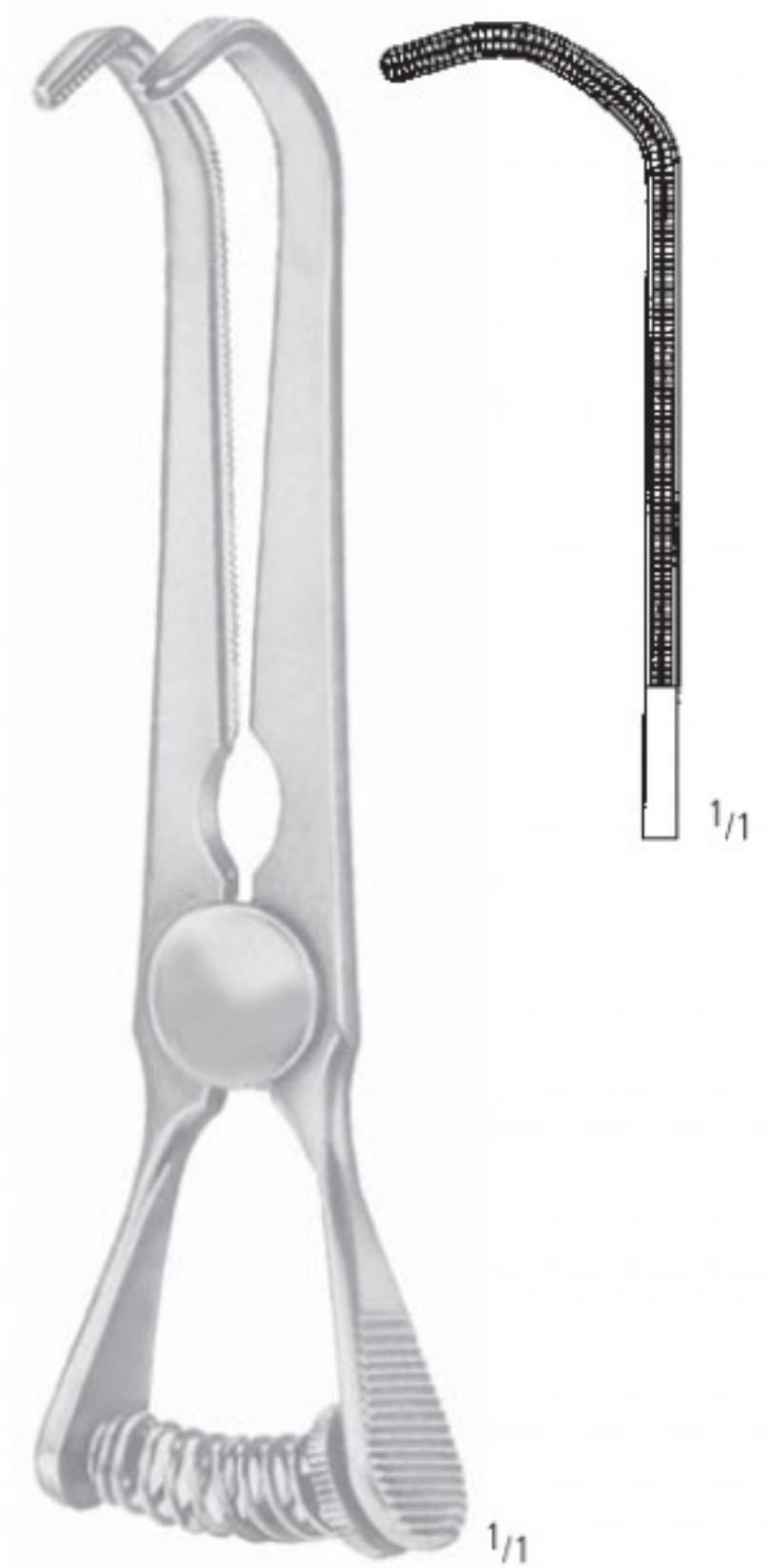

DE BAKEY-SATINSKY
 KK 373/10
 10,0 cm/4"

Atrauma Bulldogklemmen
 Atrauma Bulldog Clamps
 Atrauma Clamps Bulldog
 Clamps Atrauma Bulldog
 Pinze Atrauma Bulldog



DE BAKEY



GREGORY-SOFT

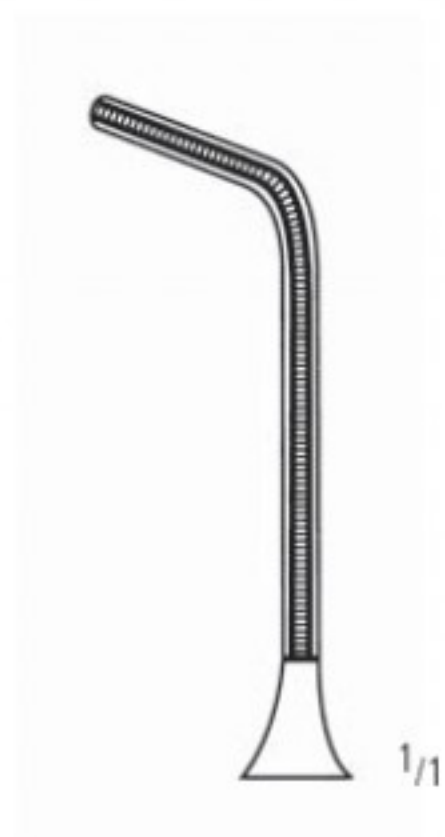

KK 375/01
 9,0 cm/3 1/2"

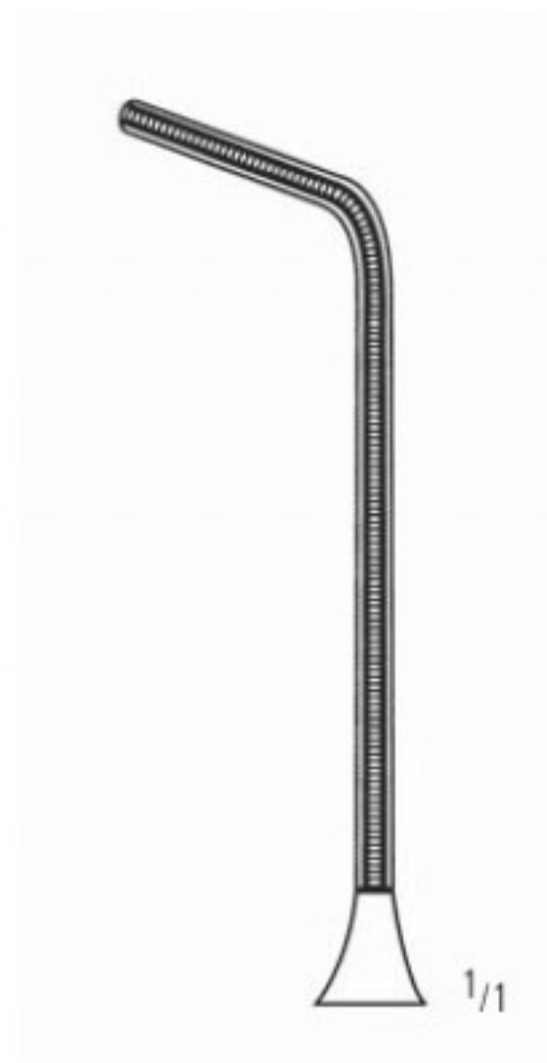

KK 375/02
 11,0 cm/4 1/2"

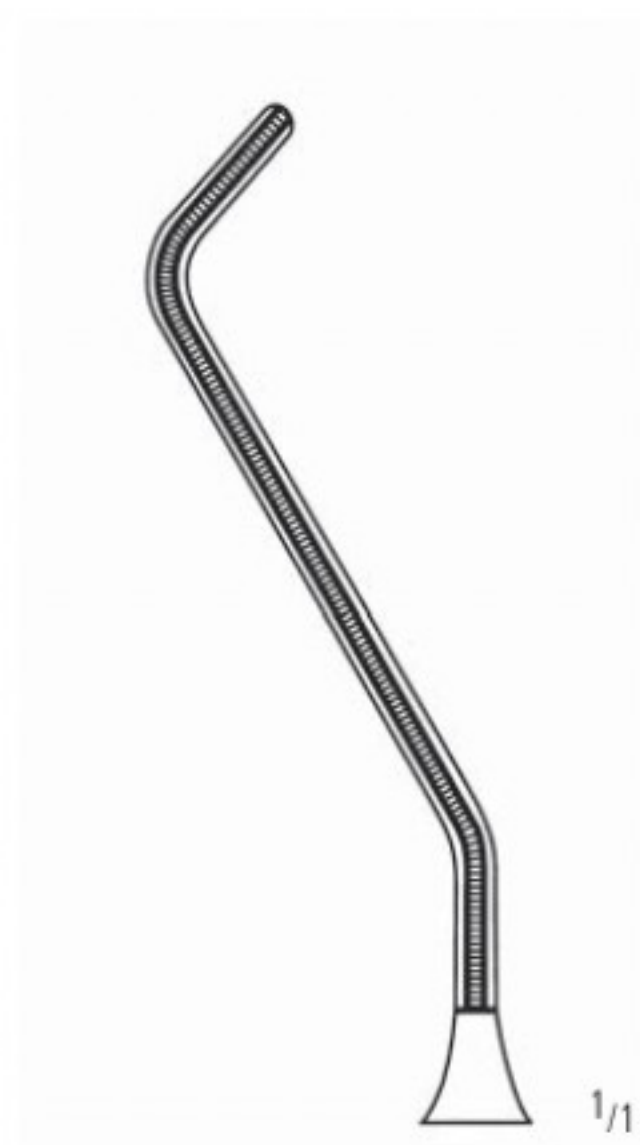

KK 375/03
 11,0 cm/4 1/2"

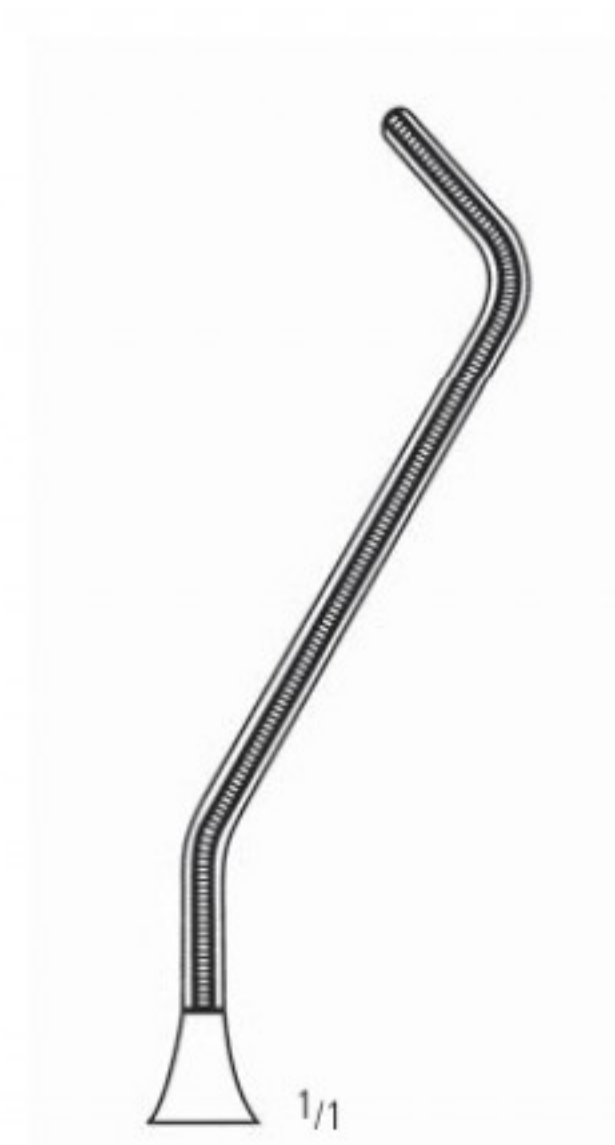

KK 375/04
 11,0 cm/4 1/2"

AA
 AB
 AC
 AD
 AE
 AF
 AK
 AL
 AO
 KA
 X

KK

Atrauma-Klemmen
 Atrauma Forceps
 Pinzas Atrauma
 Pincès atraumatiques
 Pinze Atrauma



DE BAKEY

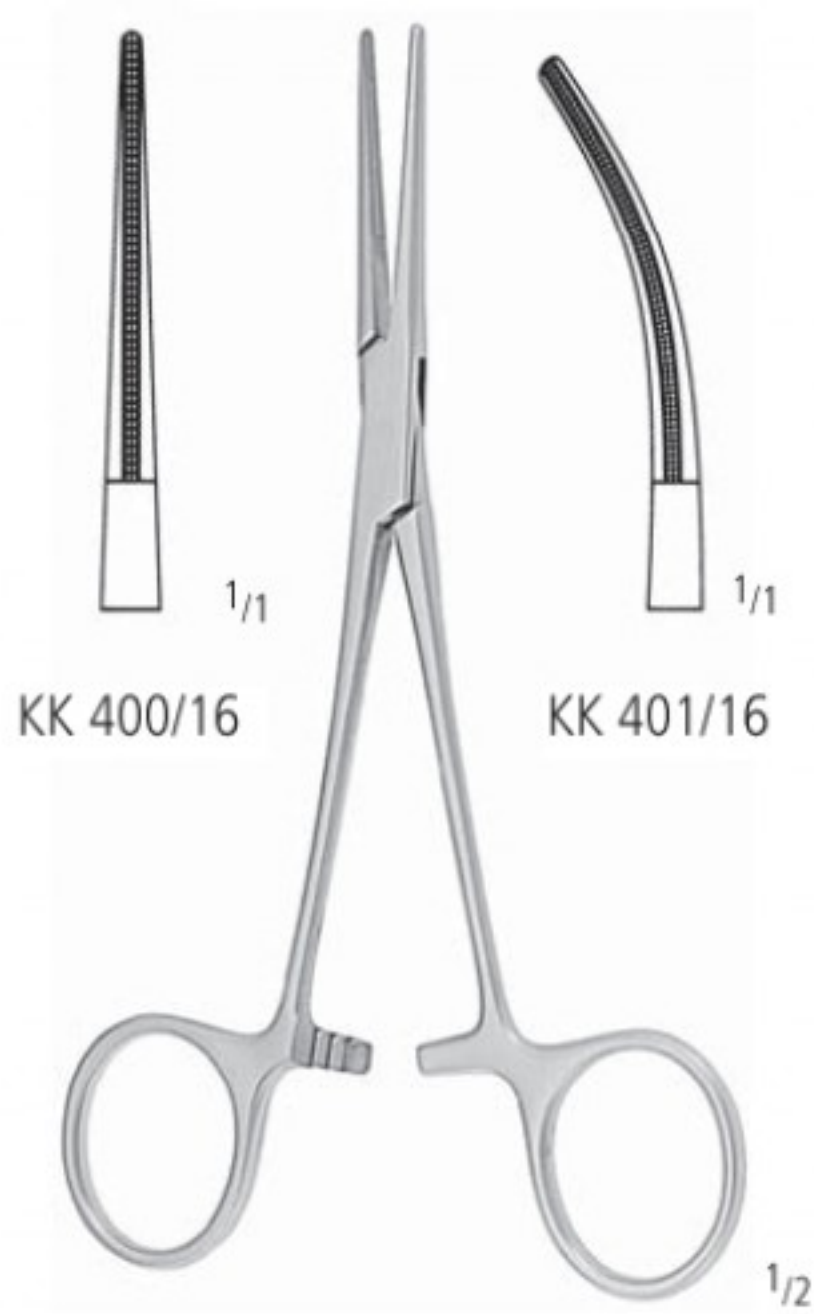

DE BAKEY-RANKIN
 16,0 cm/6¹/₄"

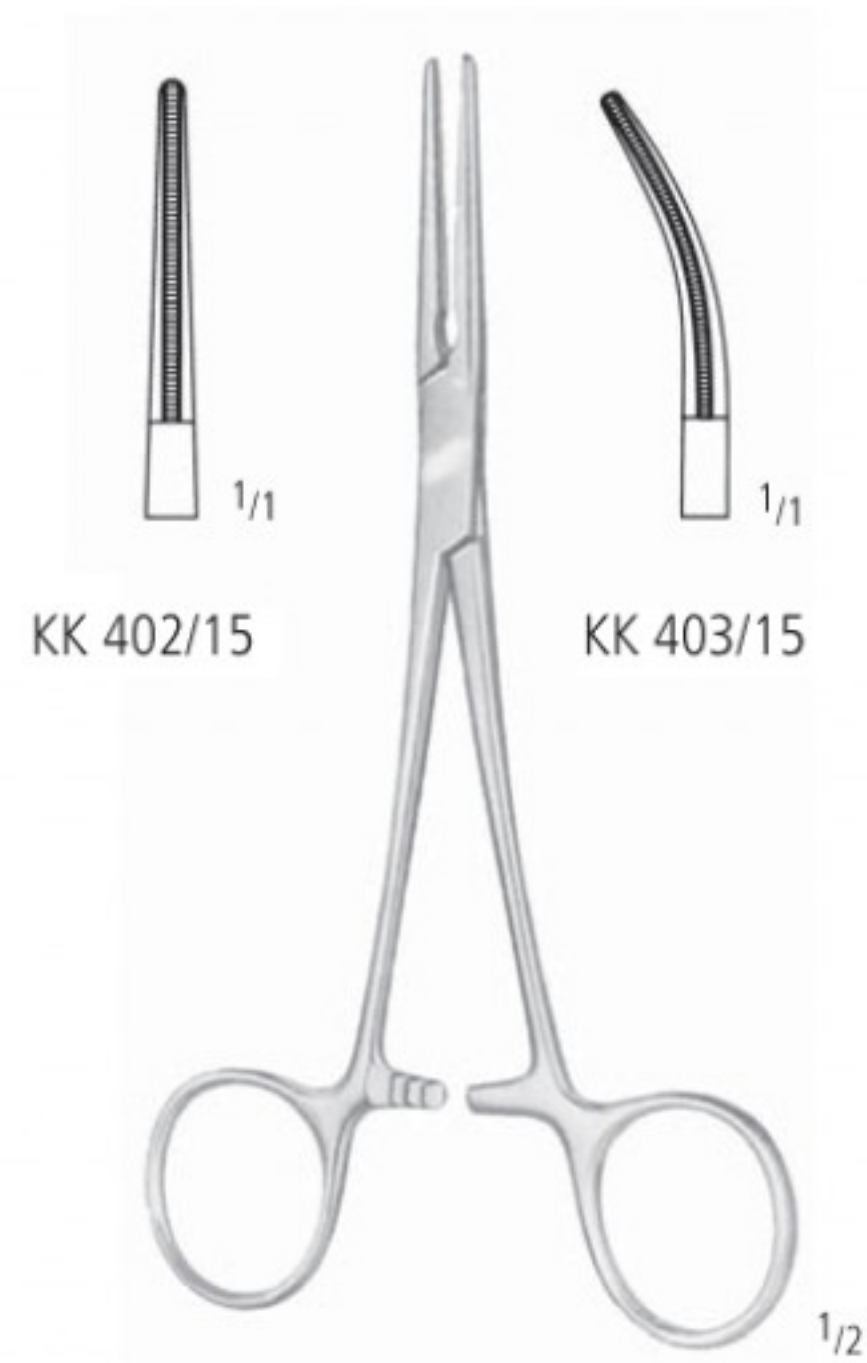

DE BAKEY-MOSQUITO
 15,0 cm/6"

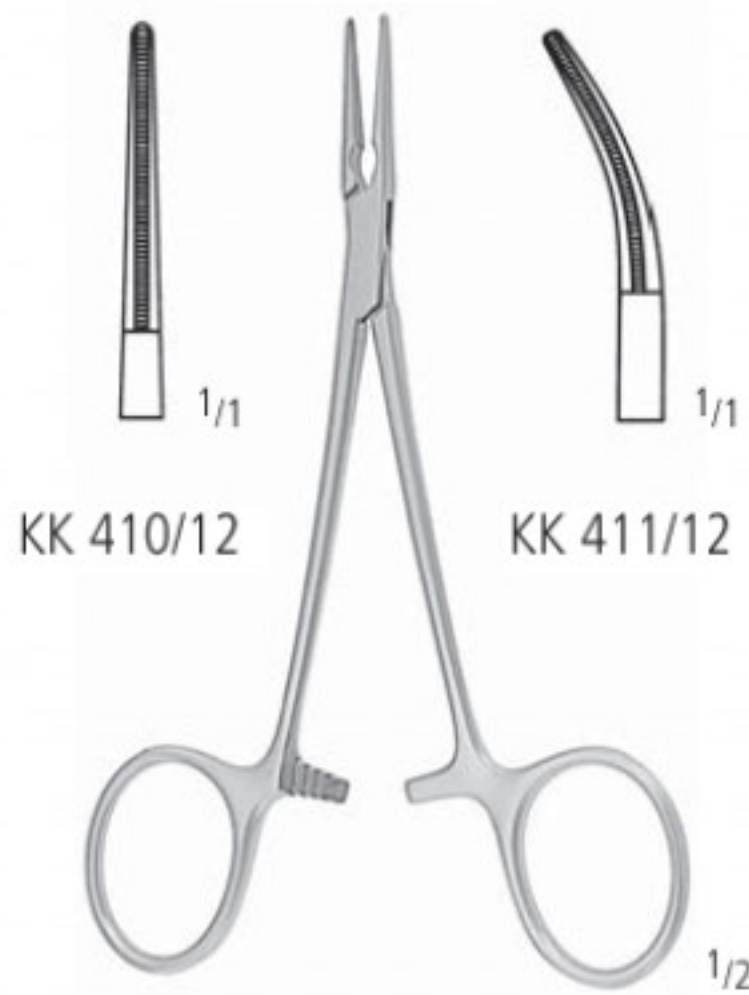

DE BAKEY-MOSQUITO
 12,0 cm/4³/₄"

Atrauma-Klemmen
 Atrauma Forceps
 Pinzas Atrauma
 Pincas atraumatiques
 Pinze Atrauma



DE BAKEY



DE BAKEY-PEAN

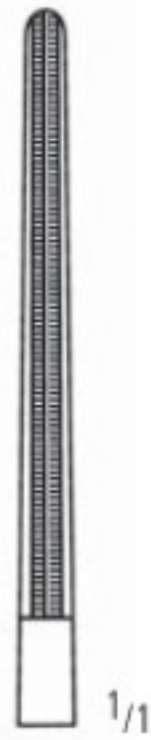

KK 414/14
 14,0 cm/5 1/2"

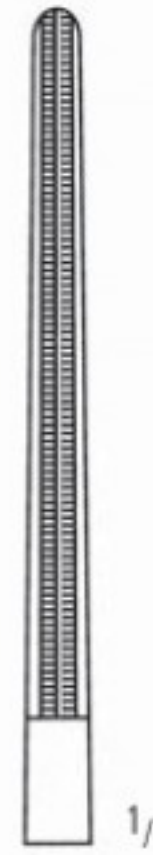

KK 414/16
 16,0 cm/6 1/4"

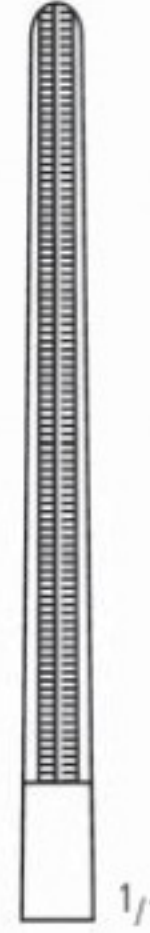

KK 414/18
 18,0 cm/7"

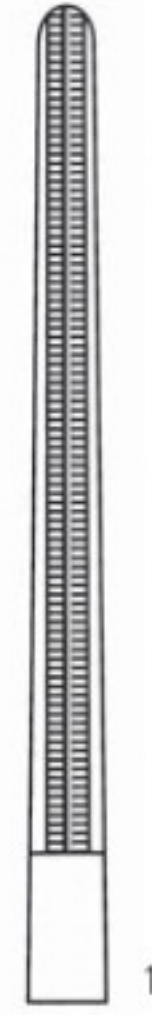

KK 414/20
 20,0 cm/8"



KK 415/14
 14,0 cm/5 1/2"

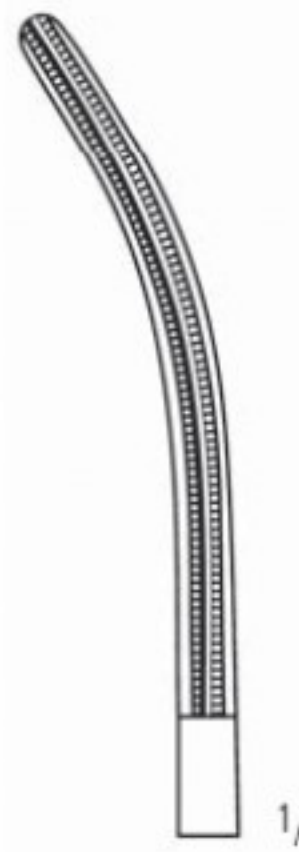

KK 415/16
 16,0 cm/6 1/4"

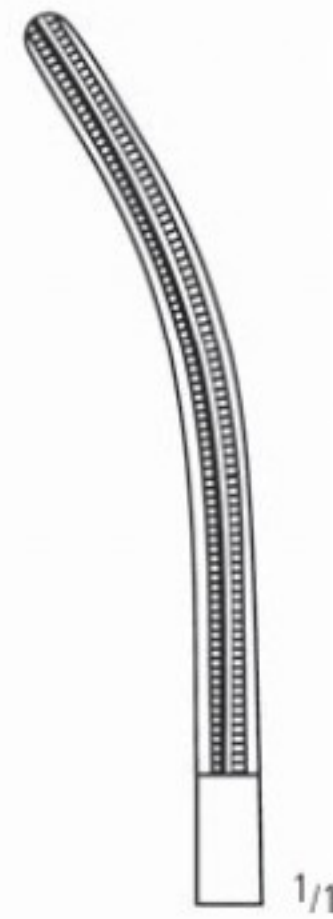

KK 415/18
 18,0 cm/7"

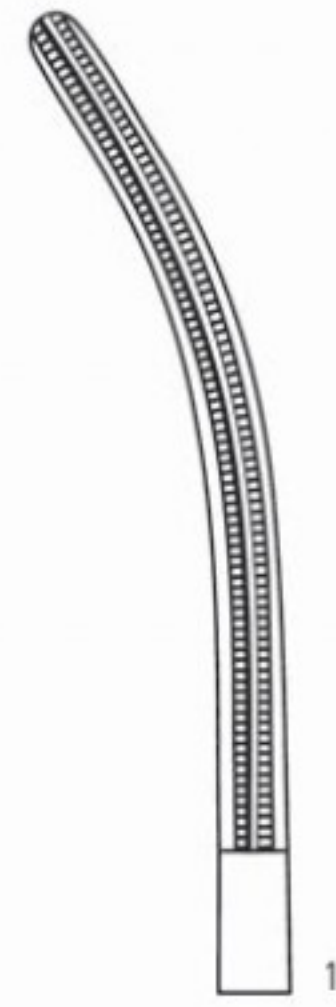

KK 415/20
 20,0 cm/8"

AA
 AB
 AC
 AD
 AE
 AF
 AK
 AL
 AO
 KA
 KK
 X

KK

Atrauma-Klemmen
 Atrauma Forceps
 Pinzas Atrauma
 Pincès atraumatiques
 Pinze Atrauma



DE BAKEY

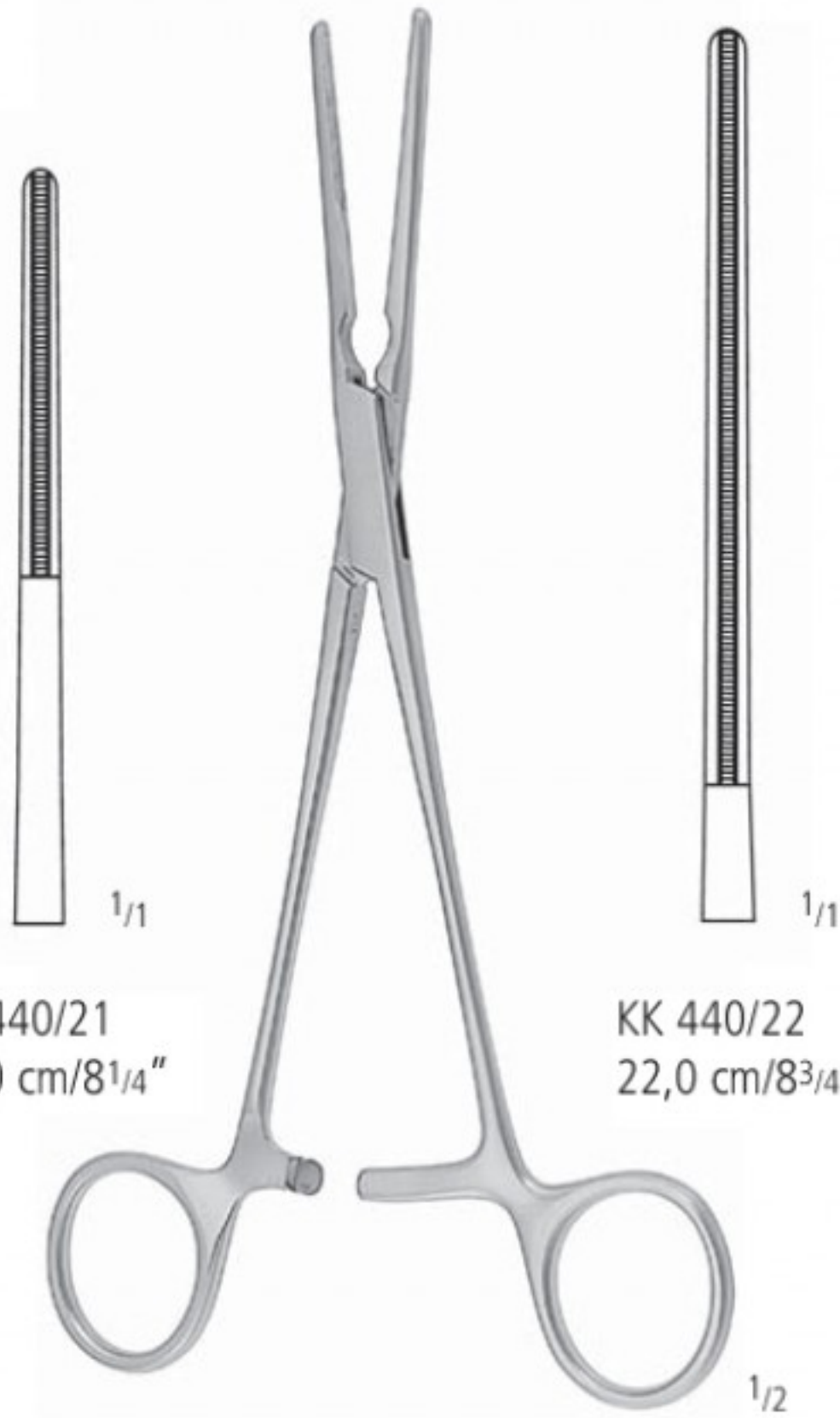

KK 440/21
 21,0 cm/8¹/₄"

KK 440/22
 22,0 cm/8³/₄"

POTTS

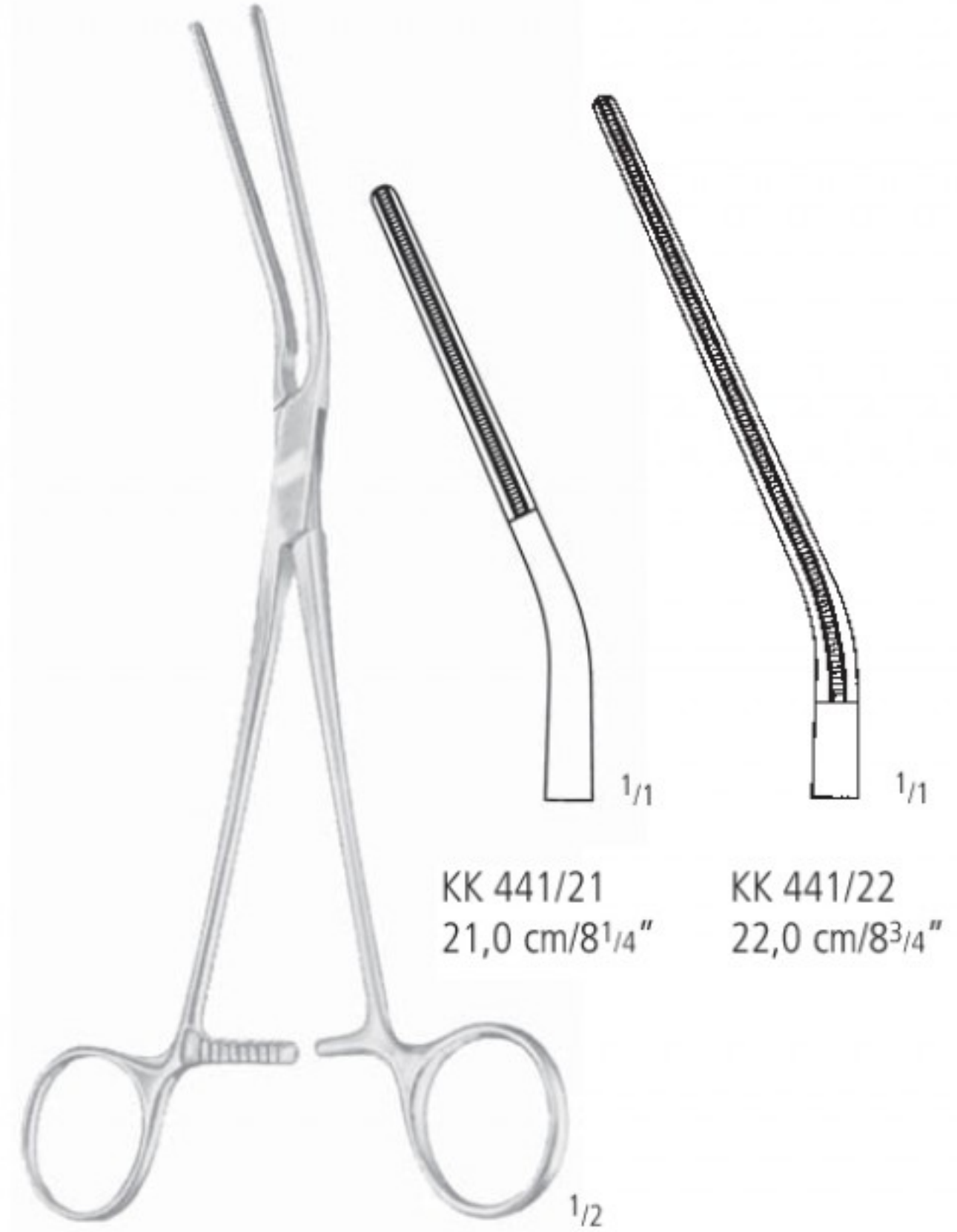

KK 441/21
 21,0 cm/8¹/₄"

KK 441/22
 22,0 cm/8³/₄"

POTTS

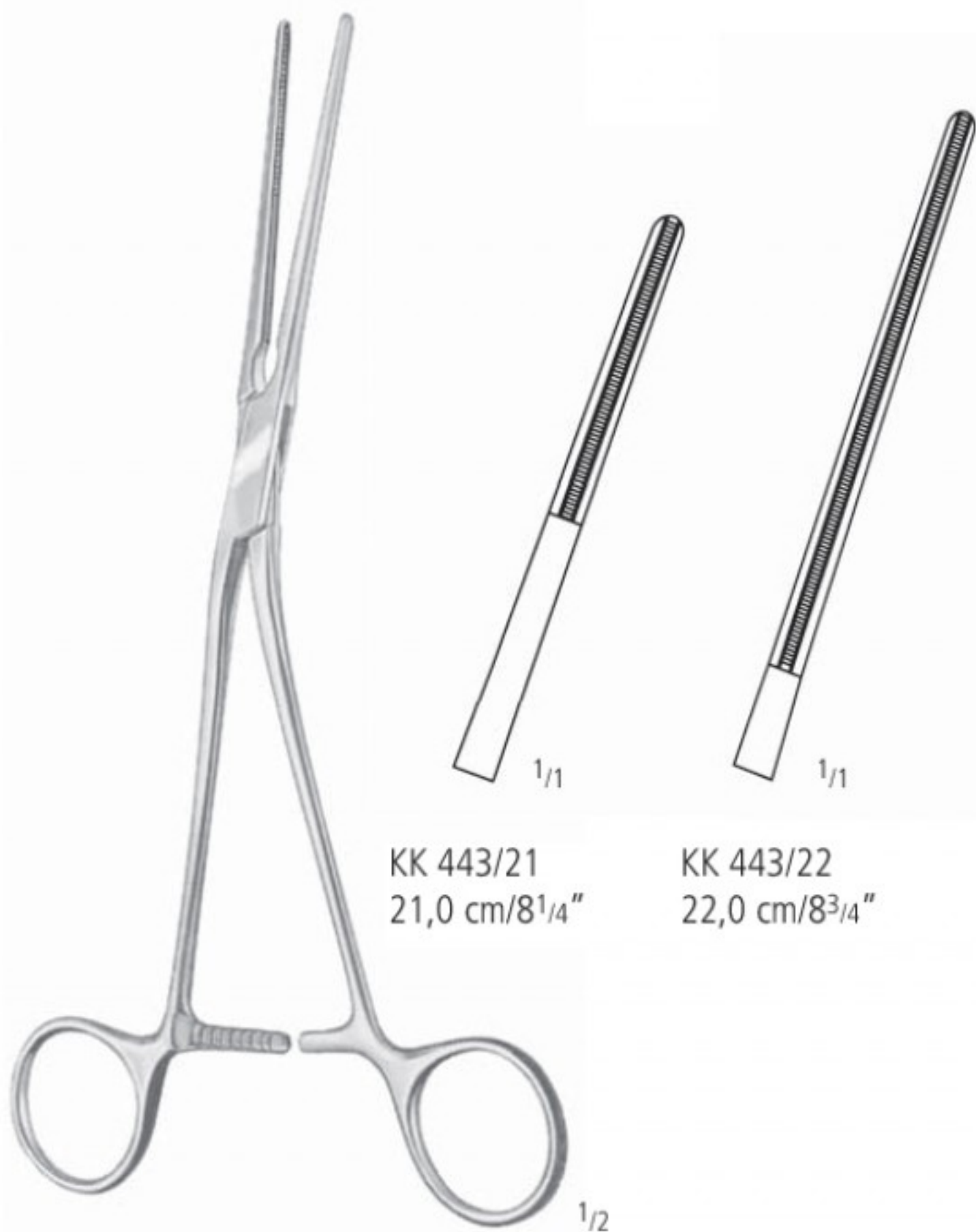

KK 443/21
 21,0 cm/8¹/₄"

KK 443/22
 22,0 cm/8³/₄"

POTTS



KK 445/22

KK 447/22

POTTS
 22,0 cm/8³/₄"

Atrauma-Klemmen
 Atrauma Forceps
 Pinzas Atrauma
 Pincés atraumáticos
 Pinze Atrauma



DE BAKEY



DE BAKEY



KK 449/19
 19,0 cm/7 1/2"

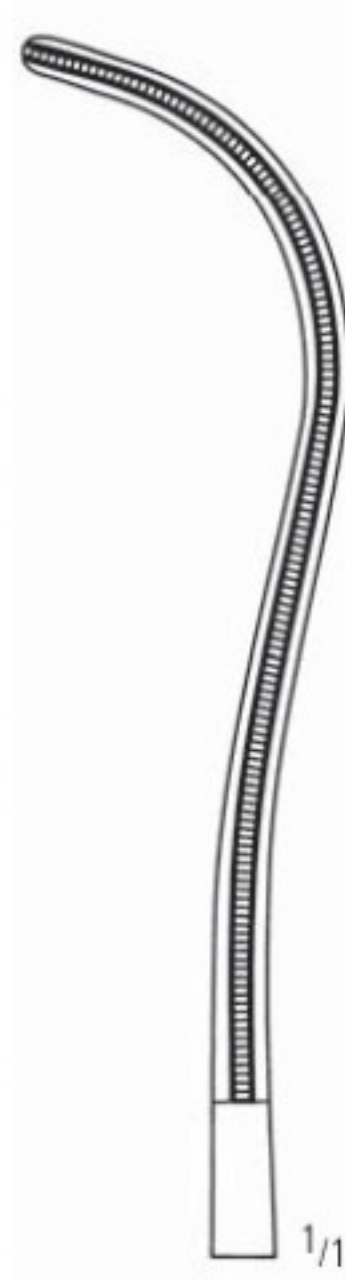

KK 449/23
 23,0 cm/9"



DE BAKEY
 KK 451/16
 16,0 cm/6 1/4"



DE BAKEY

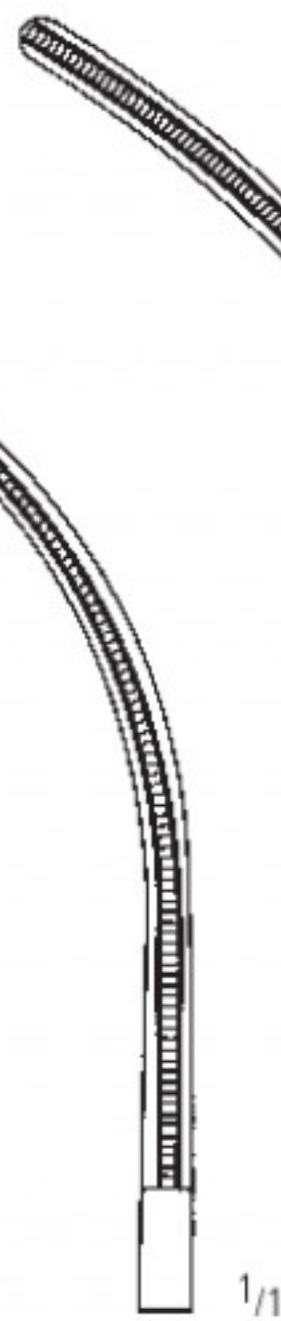

KK 453/19
 19,0 cm/7 1/2"

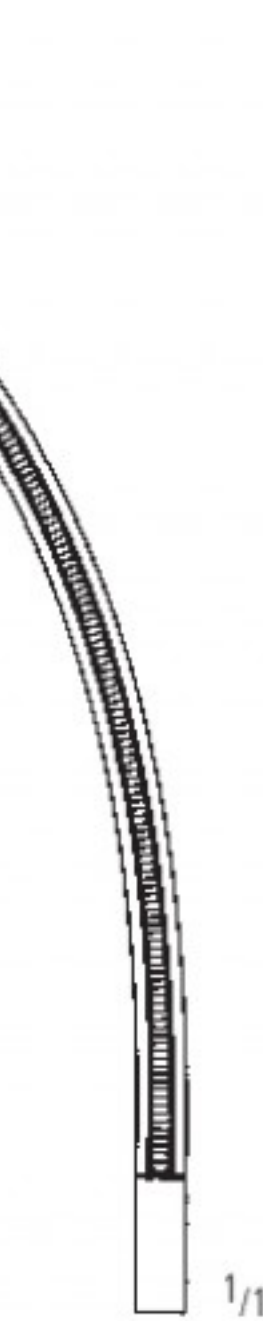

KK 453/20
 20,0 cm/8"



DE BAKEY
 KK 455/20
 20,0 cm/8"



AA
 AB
 AC
 AD
 AE
 AF
 AK
 AL
 AO
 KA
 KK
 X



Atrauma-Klemmen
 Atrauma Forceps
 Pinzas Atrauma
 Pincès atraumatiques
 Pinze Atrauma



DE BAKEY



1/2



KK 457/18
 18,0 cm/7"

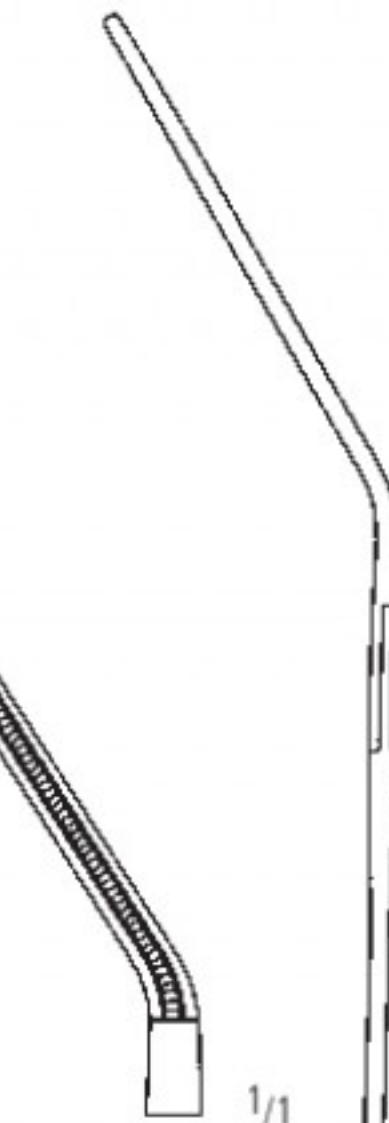

KK 457/19
 19,0 cm/7 1/2"

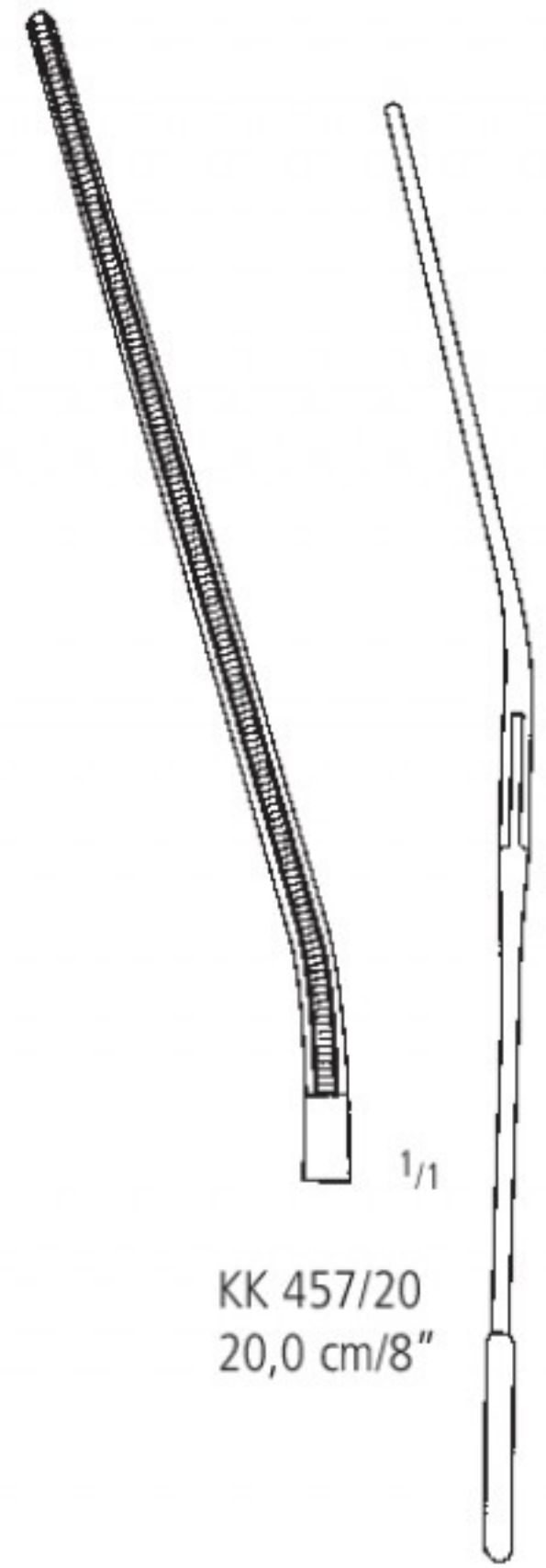

KK 457/20
 20,0 cm/8"

LELAND-JONES



1/2

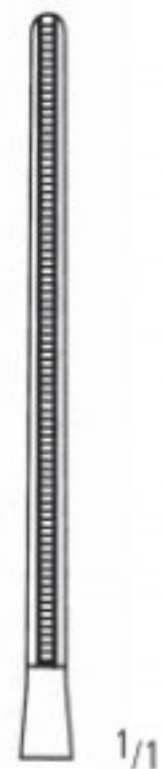

KK 460/15
 15,0 cm/6"

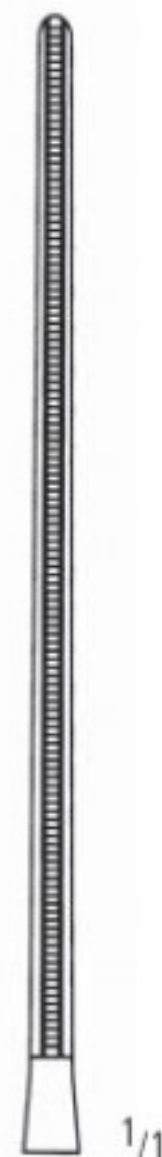

KK 460/18
 18,0 cm/7"



KK 461/15
 15,0 cm/6"



KK 461/18
 18,0 cm/7"

BAINBRIDGE

Atrauma-Klemmen
 Atrauma Forceps
 Pinzas Atrauma
 Pincas atraumatiques
 Pinze Atrauma



DE BAKEY



DE BAKEY

1/2 KK 469/26
 26,0 cm/10¹/₄"

1/1 KK 469/27
 27,0 cm/10¹/₂"

1/1 KK 469/31
 31,0 cm/12¹/₄"

1/1 KK 469/33
 33,0 cm/13"

AA
 AB
 AC
 AD
 AE
 AF
 AK
 AL
 AO
 KA
 KK
 X



Atrauma-Klemmen
 Atrauma Forceps
 Pinzas Atrauma
 Pincès atraumatiques
 Pinze Atrauma



DE BAKEY



DE BAKEY

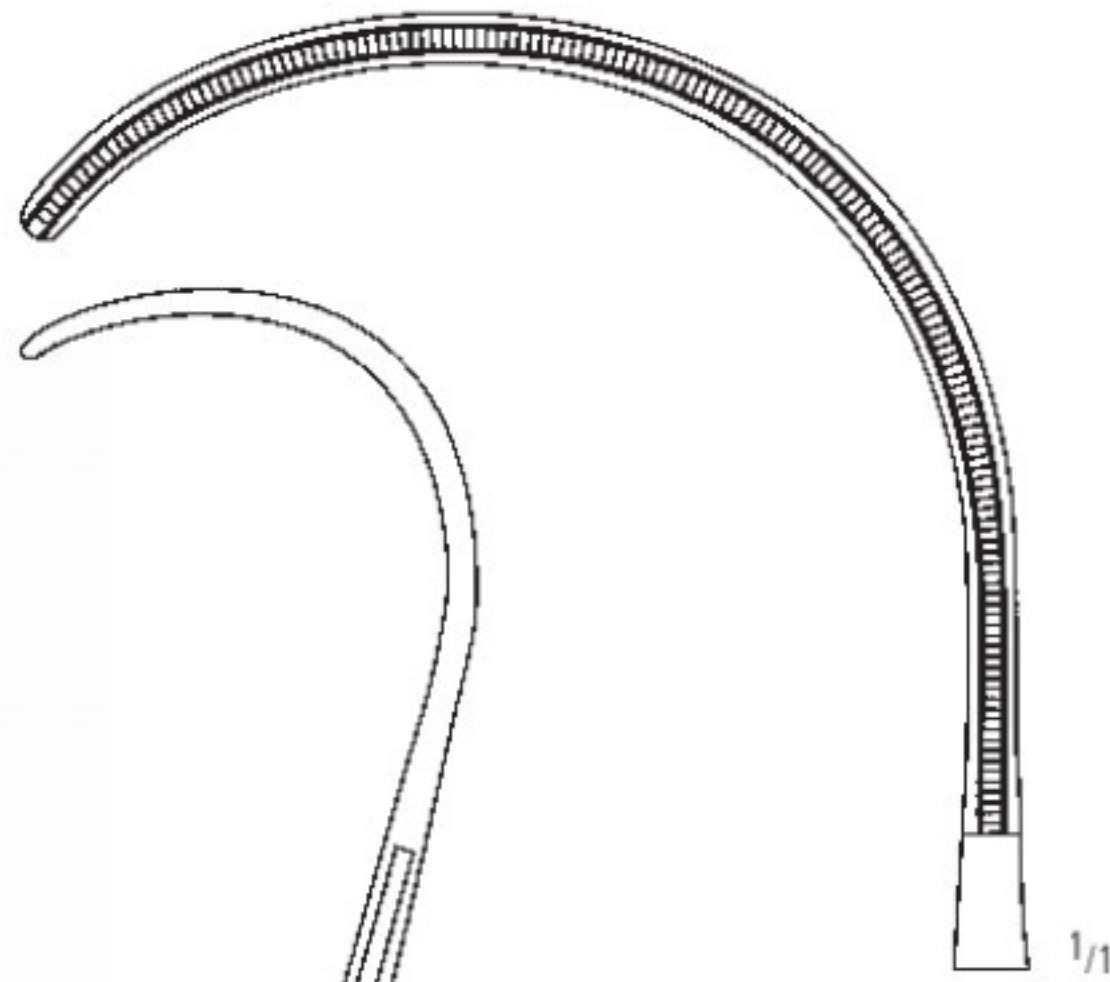

KK 473/25
 25,0 cm/10"

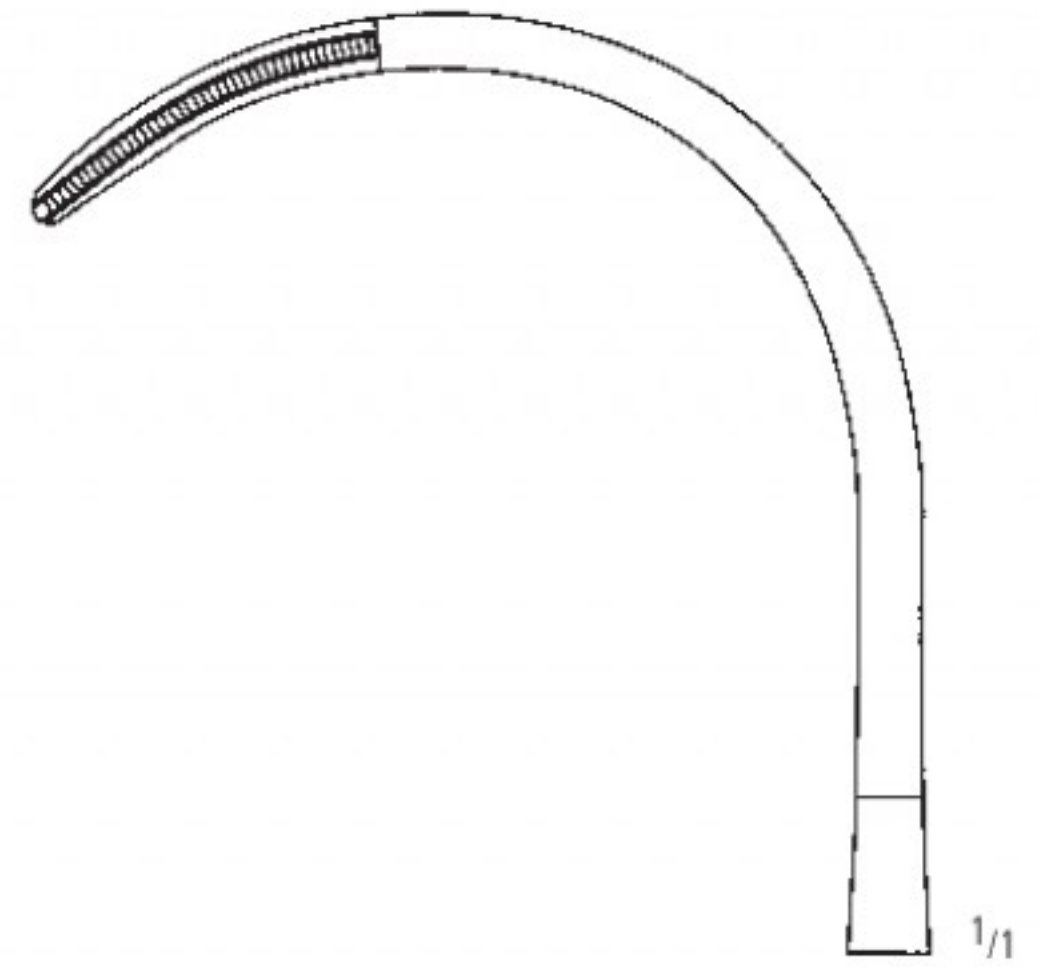

KK 475/26
 26,0 cm/10¹/₂"



DE BAKEY

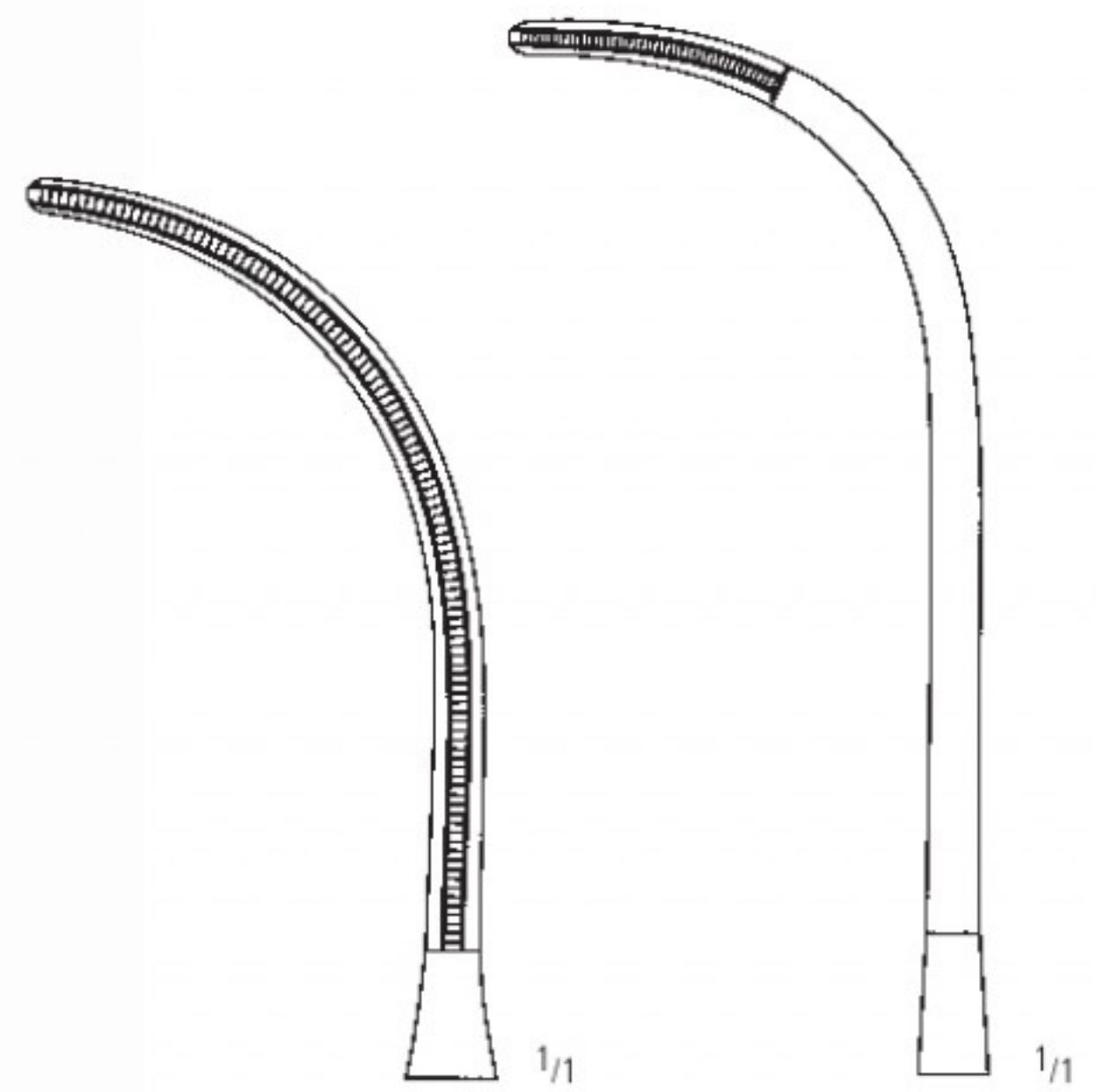

KK 477/24
 24,0 cm/9¹/₂"

KK 479/24
 24,0 cm/9¹/₂"

Atrauma-Klemmen
 Atrauma Forceps
 Pinzas Atrauma
 Pincas atraumatiques
 Pinze Atrauma



DE BAKEY

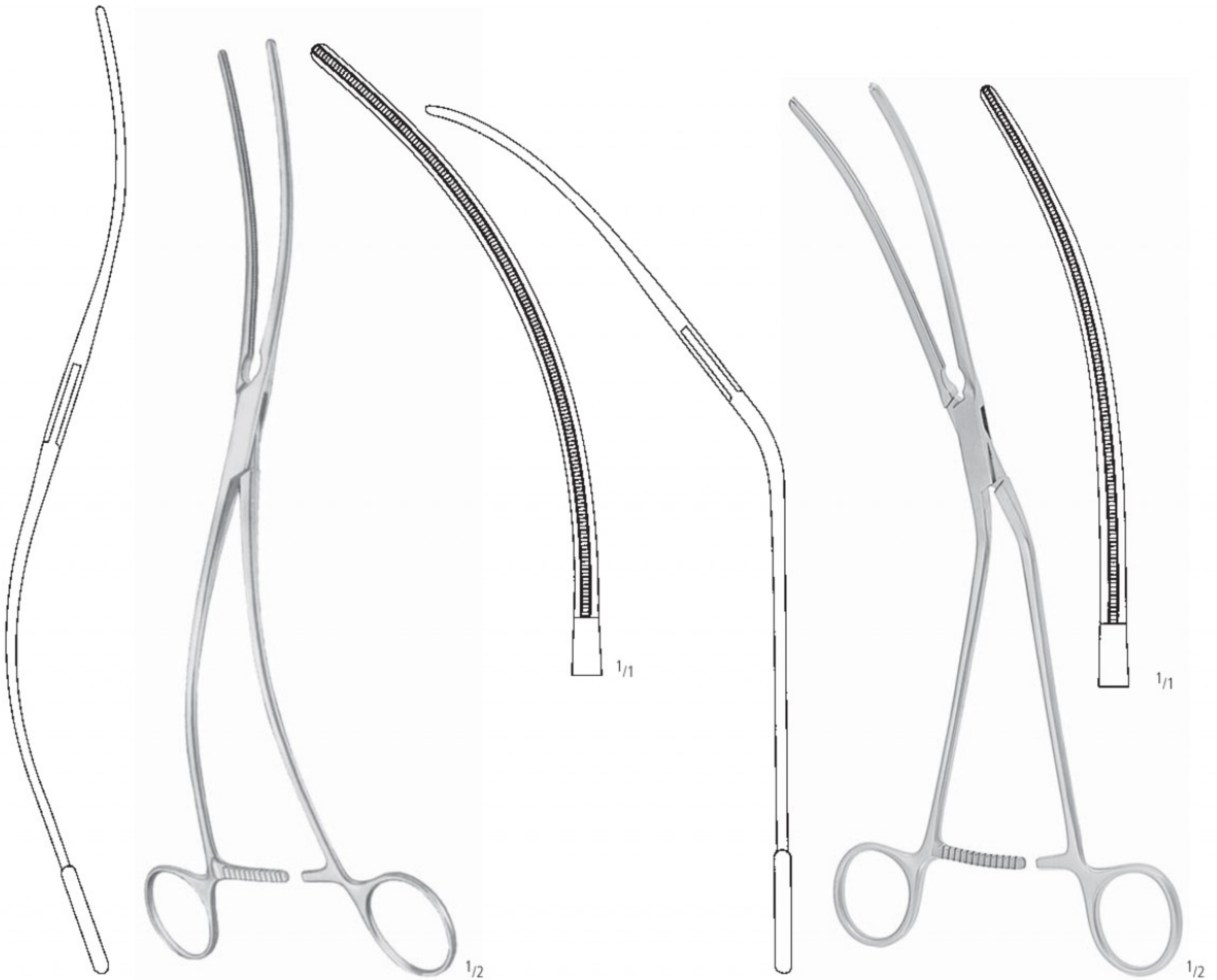

DE BAKEY
 KK 481/30
 30,0 cm/11³/₄"

DE BAKEY
 KK 483/28
 28,0 cm/11"

AA
 AB
 AC
 AD
 AE
 AF
 AK
 AL
 AO
 KA
 X

KK

Atrauma-Klemmen
 Atrauma Forceps
 Pinzas Atrauma
 Pincès atraumatiques
 Pinze Atrauma



DE BAKEY



DE BAKEY

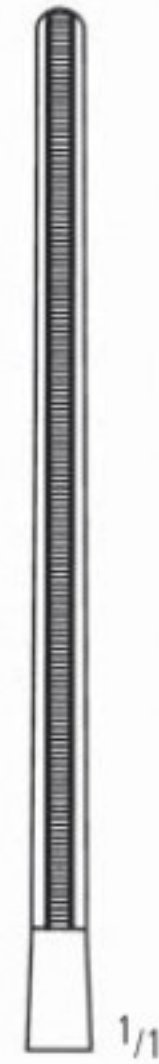

KK 486/21
 21,0 cm/8¹/₂"

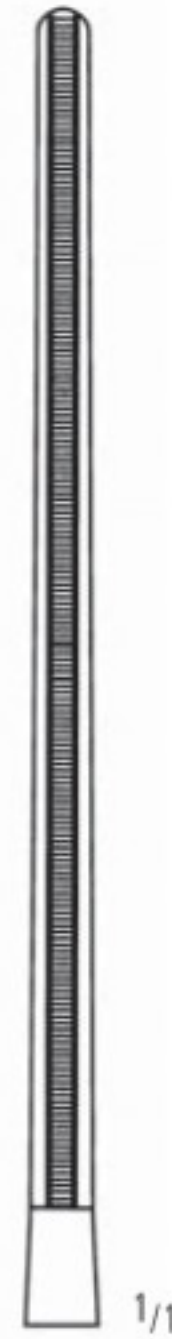

KK 486/23
 23,0 cm/9"

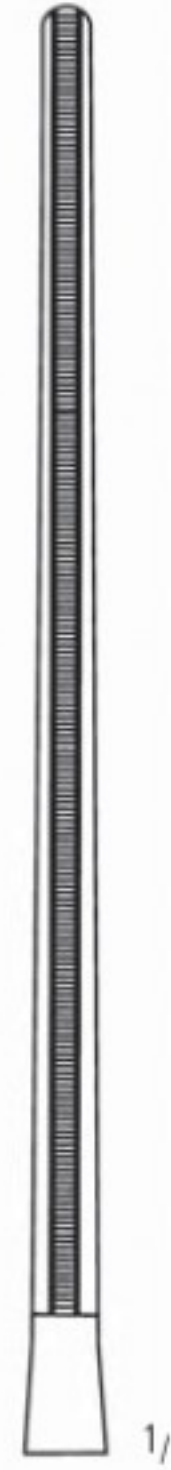

KK 486/27
 27,0 cm/10¹/₂"

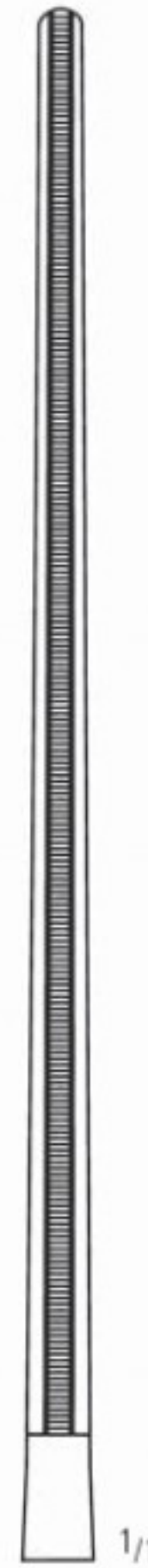

KK 486/31
 31,0 cm/12¹/₂"

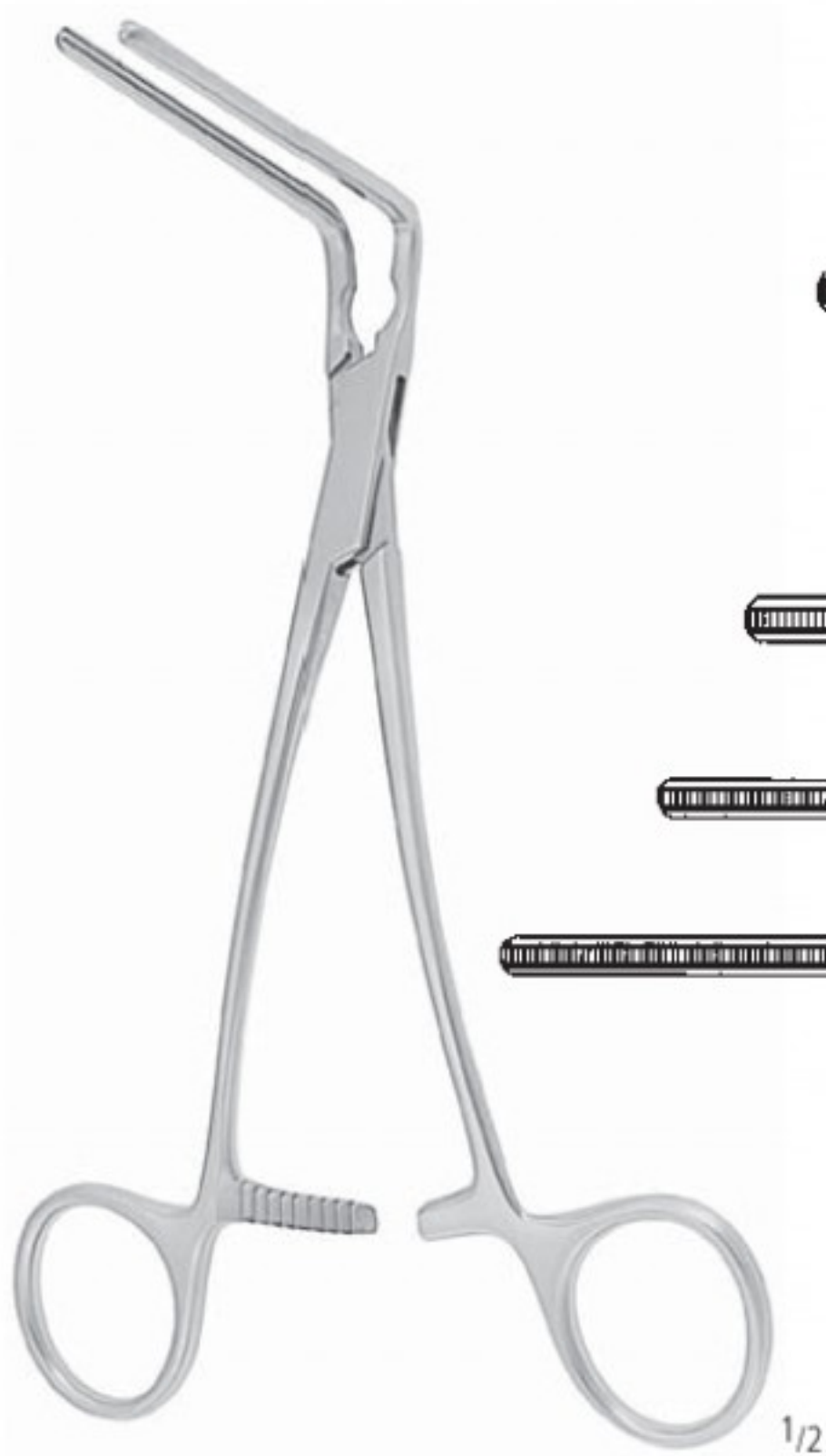

DE BAKEY



KK 487/18
 18,0 cm/7"

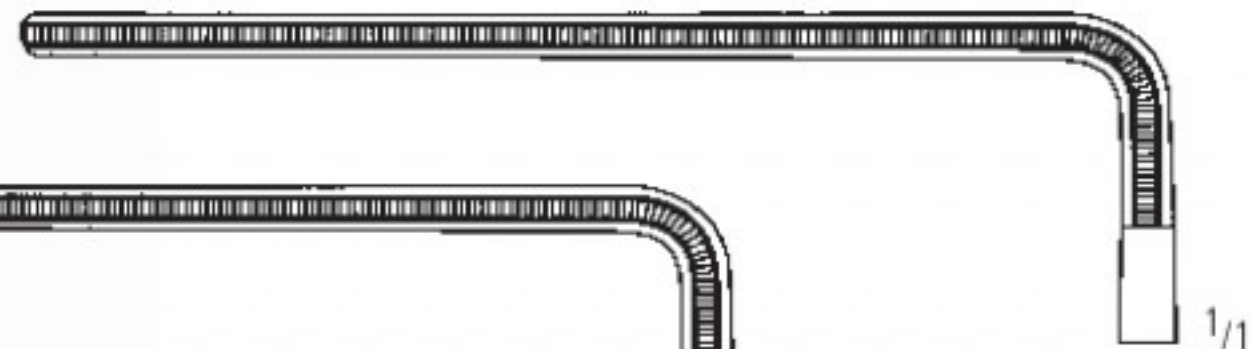

KK 487/19
 19,0 cm/7¹/₂"

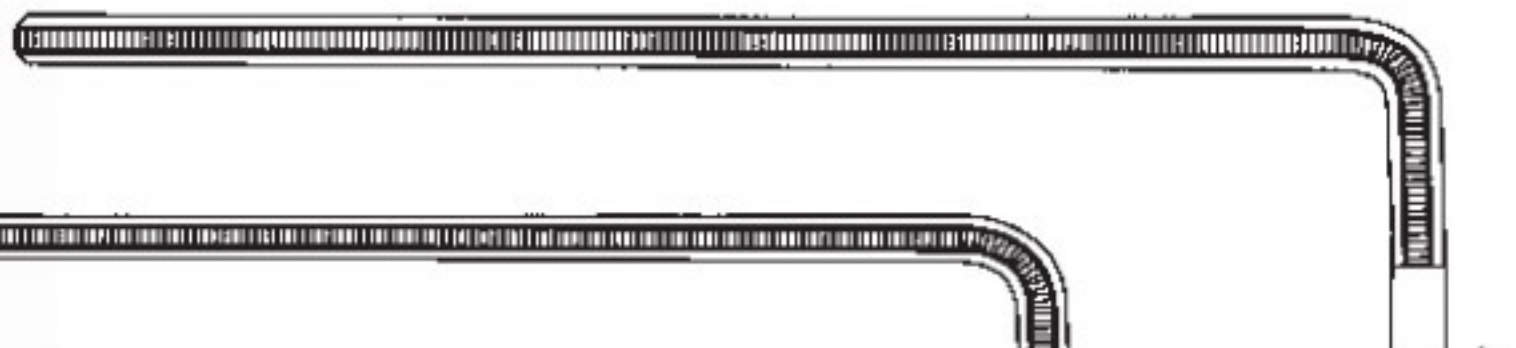

KK 487/23
 23,0 cm/9"

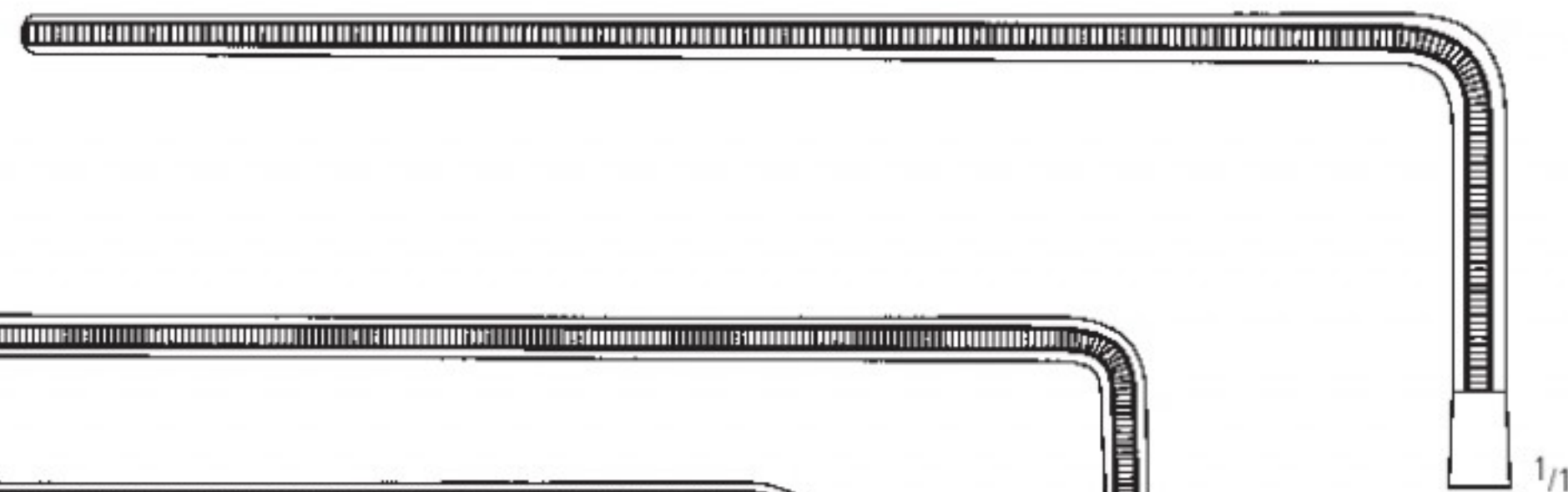

KK 487/27
 27,0 cm/10¹/₂"

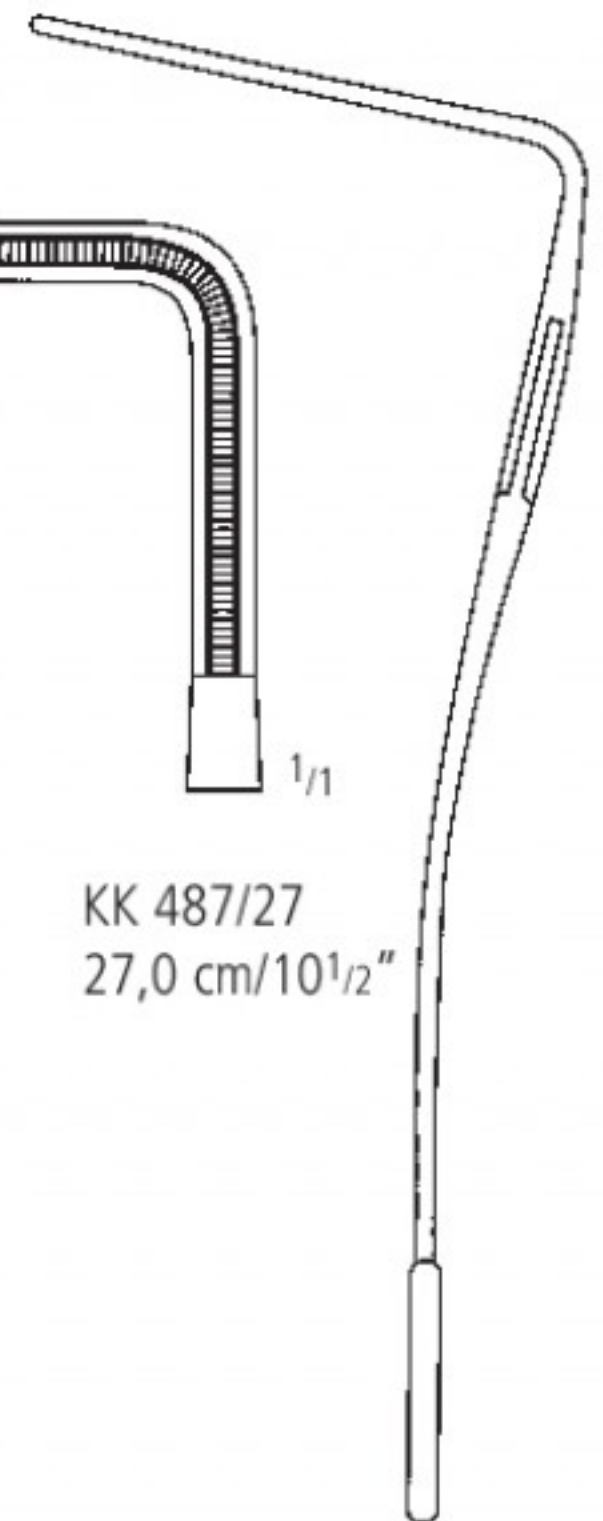

Atrauma-Klemmen
 Atrauma Forceps
 Pinzas Atrauma
 Pincès atraumatiques
 Pinze Atrauma



DE BAKEY



DE BAKEY



KK 489/20
 20,0 cm/8"

KK 489/21
 21,0 cm/8¹/₄"

KK 489/25
 25,0 cm/10"

KK 489/29
 29,0 cm/11³/₄"



DE BAKEY

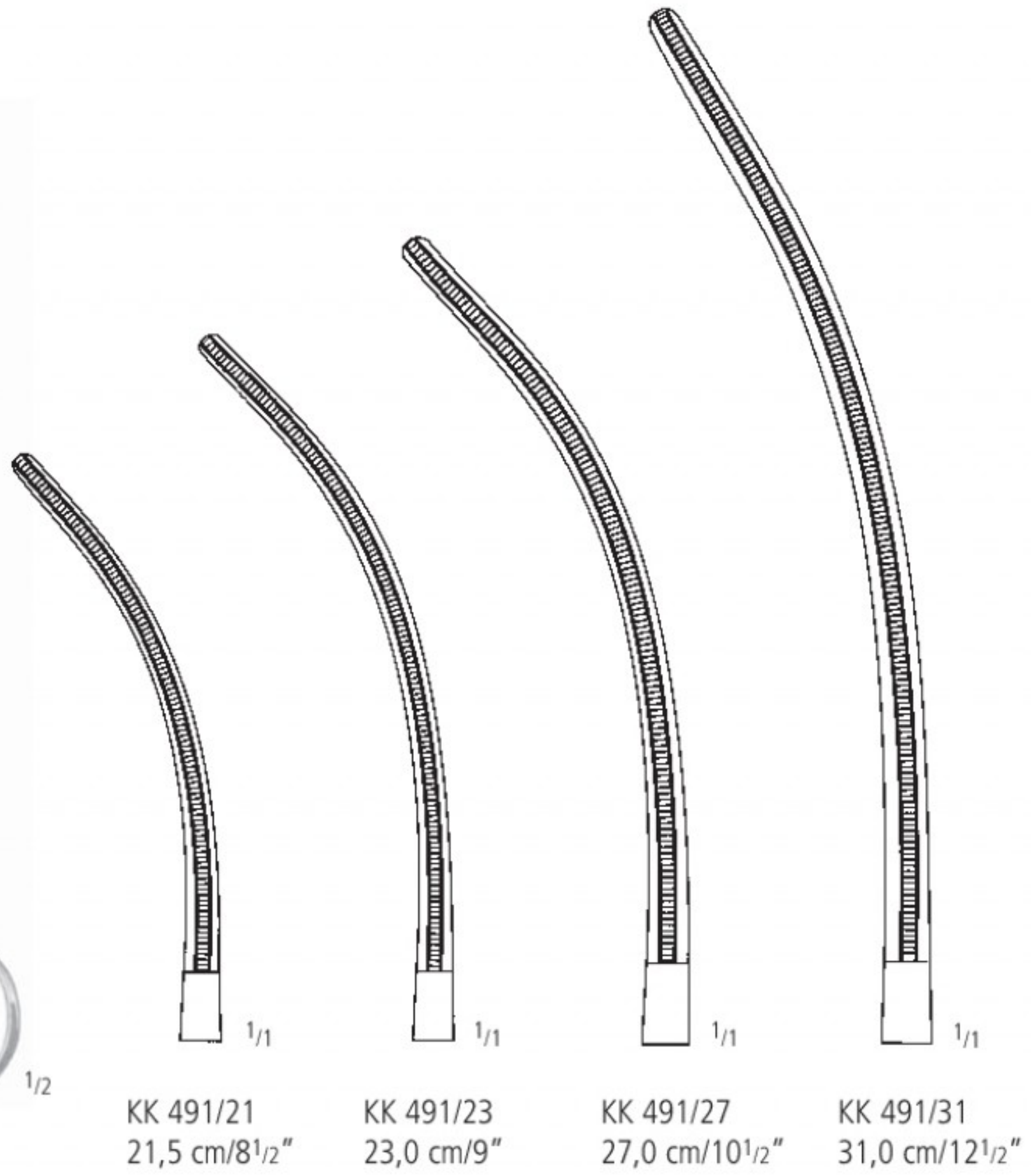

KK 491/21
 21,5 cm/8¹/₂"

KK 491/23
 23,0 cm/9"

KK 491/27
 27,0 cm/10¹/₂"

KK 491/31
 31,0 cm/12¹/₂"

AA
 AB
 AC
 AD
 AE
 AF
 AK
 AL
 AO
 KA
 KK
 X

KK

Atrauma-Klemmen
 Atrauma Forceps
 Pinzas Atrauma
 Pincès atraumatiques
 Pinze Atrauma



DE BAKKEY

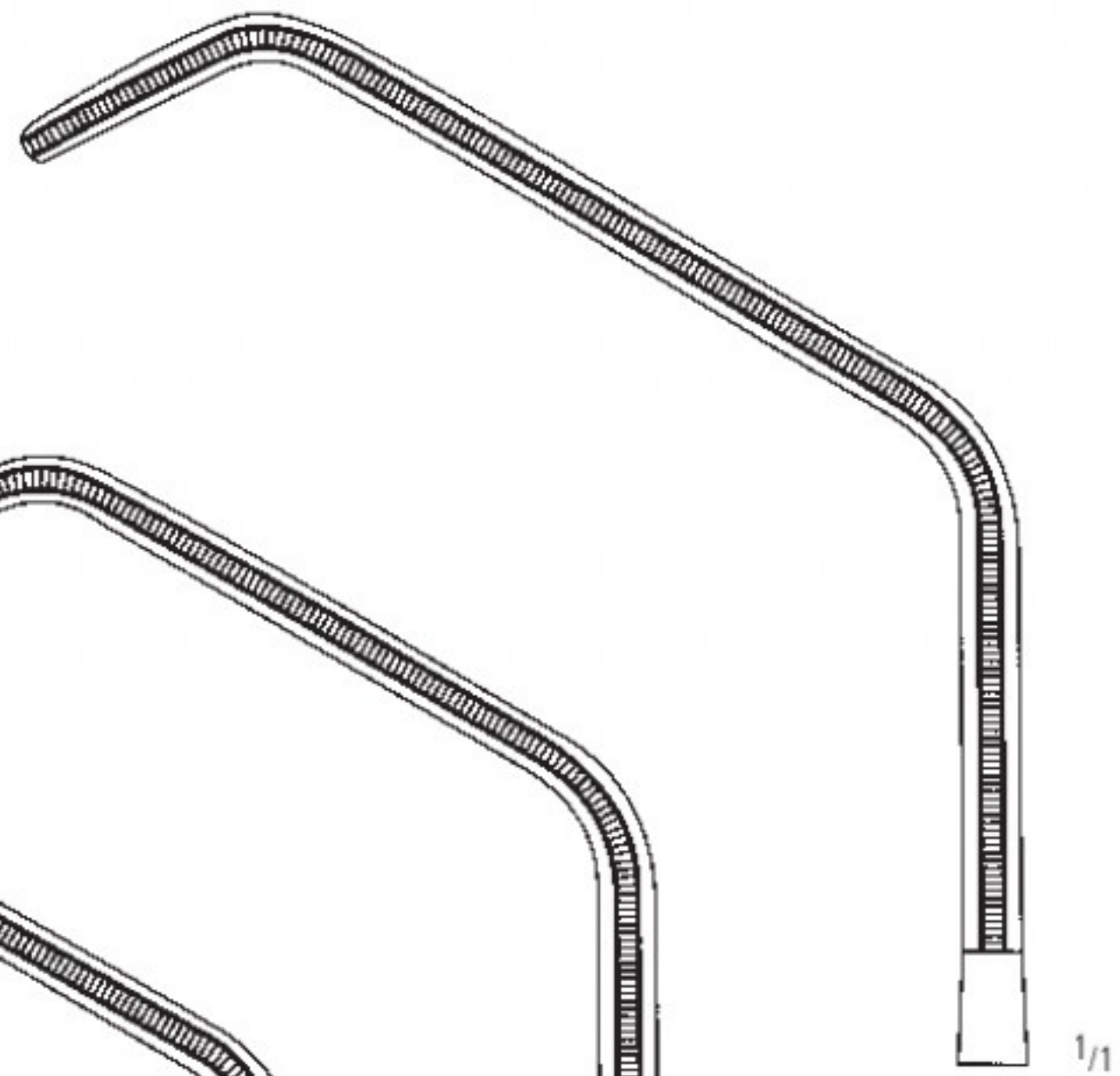

KK 493/27
 27,5 cm/10³/₄"

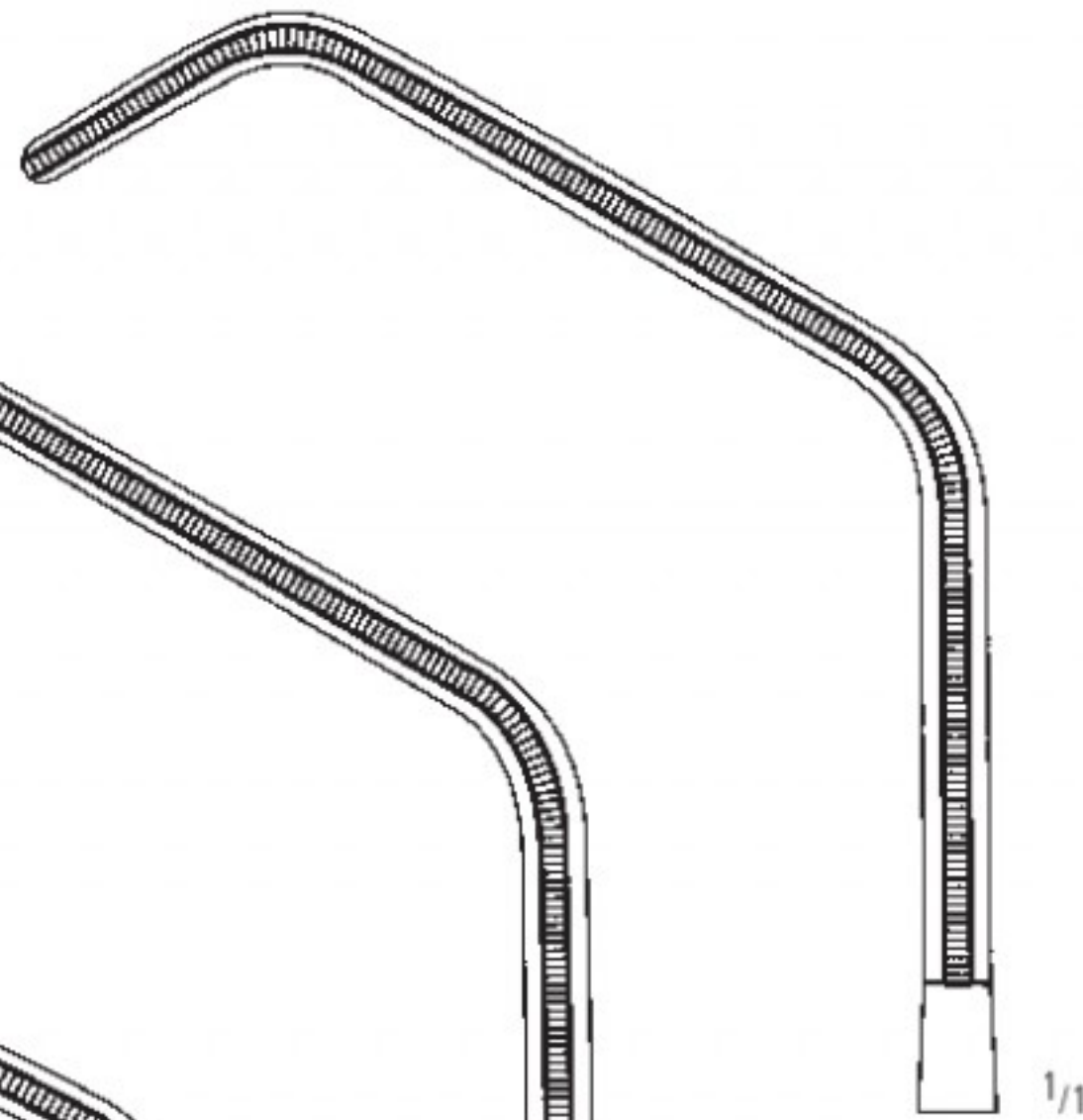

KK 493/26
 26,5 cm/10¹/₂"

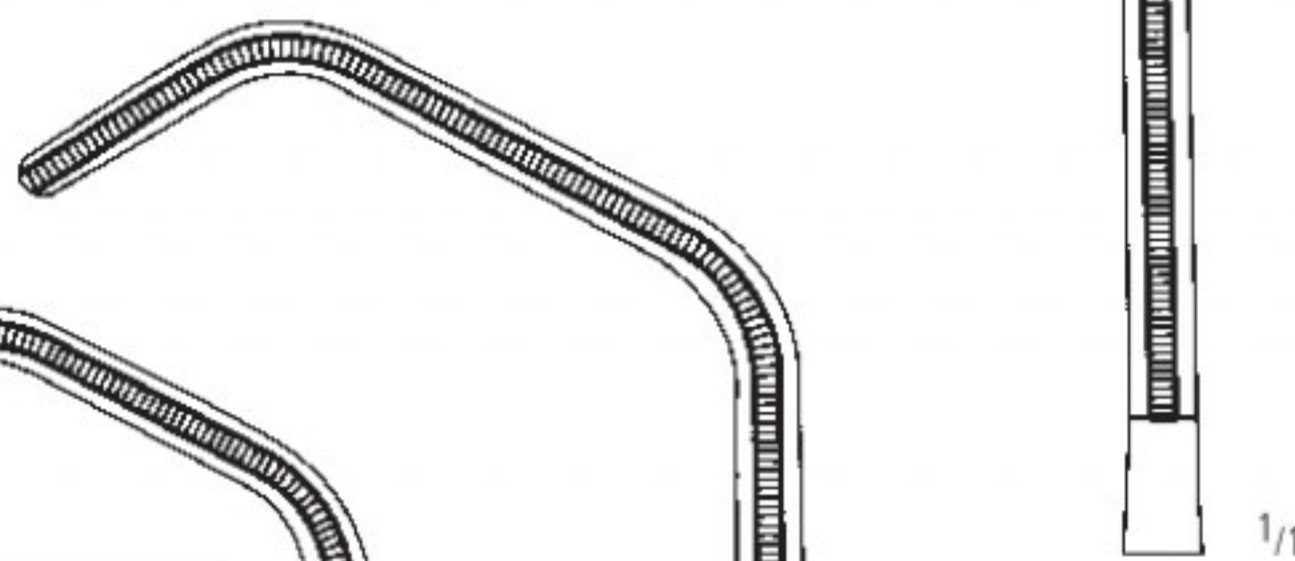

KK 493/25
 25,0 cm/10"

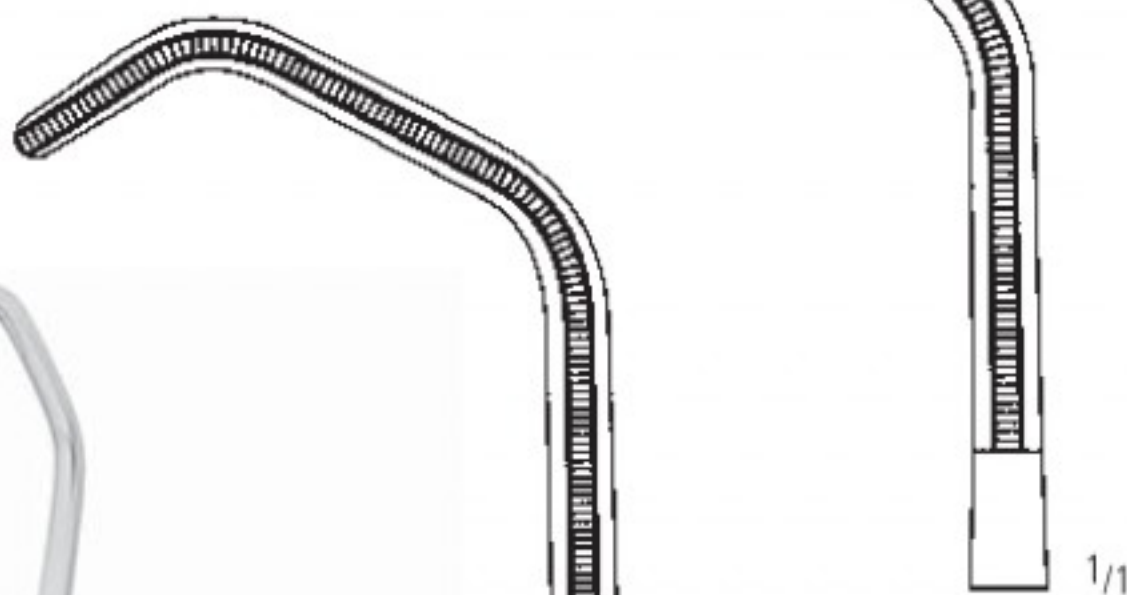

KK 493/24
 24,0 cm/9³/₄"

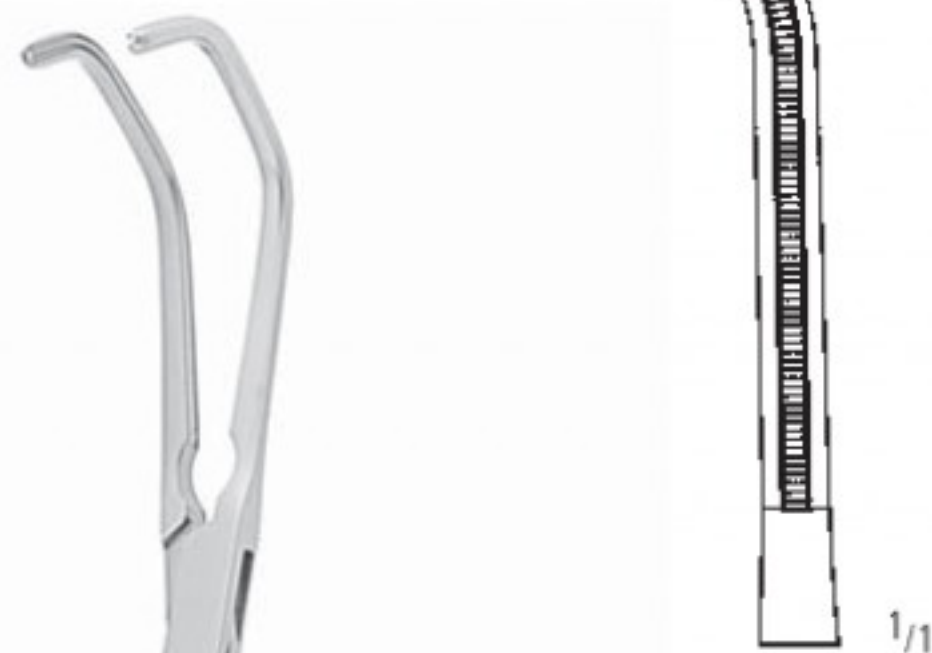

KK 493/20
 20,5 cm/8"



SATINSKY



Atrauma-Klemmen
 Atrauma Forceps
 Pinzas Atrauma
 Pincès atraumatiques
 Pinze Atrauma



DE BAKY



LAMBERT-KAY

1/2

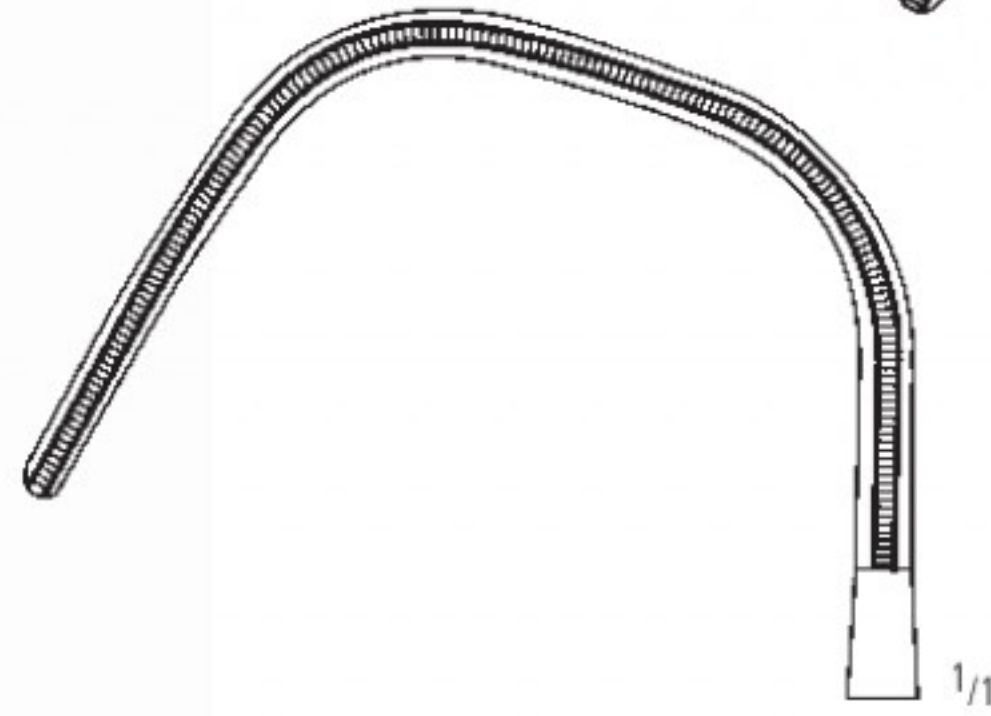

KK 495/01
 21,0 cm/8 1/2"

1/1

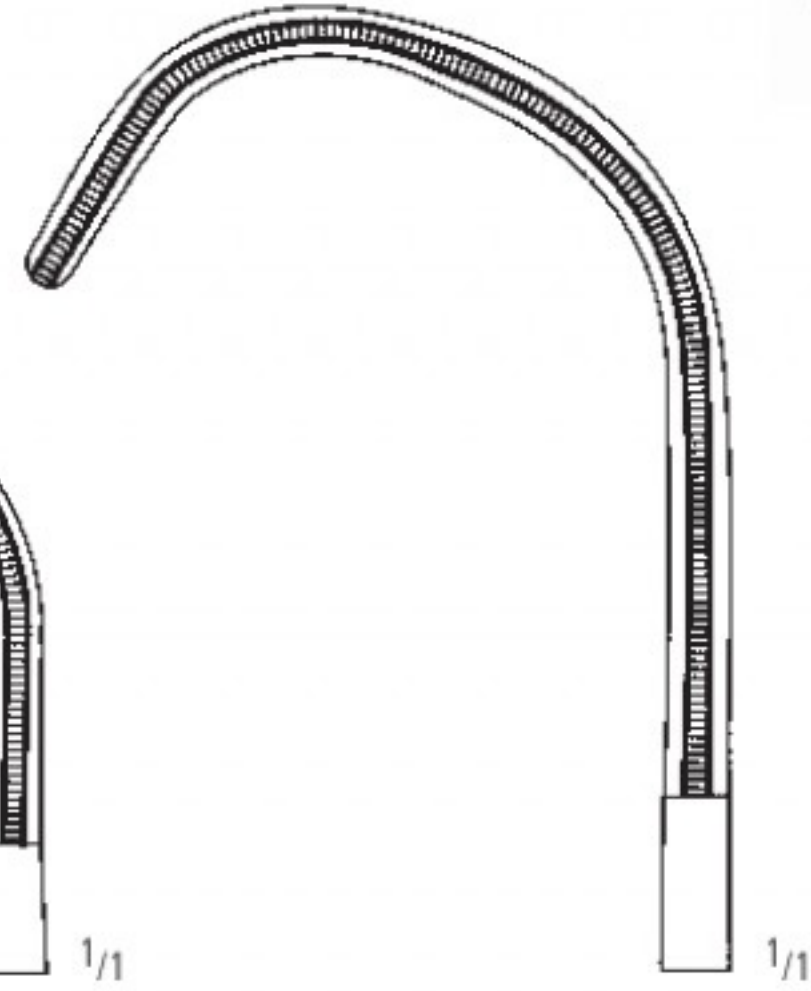

KK 495/02
 21,0 cm/8 1/2"

1/1

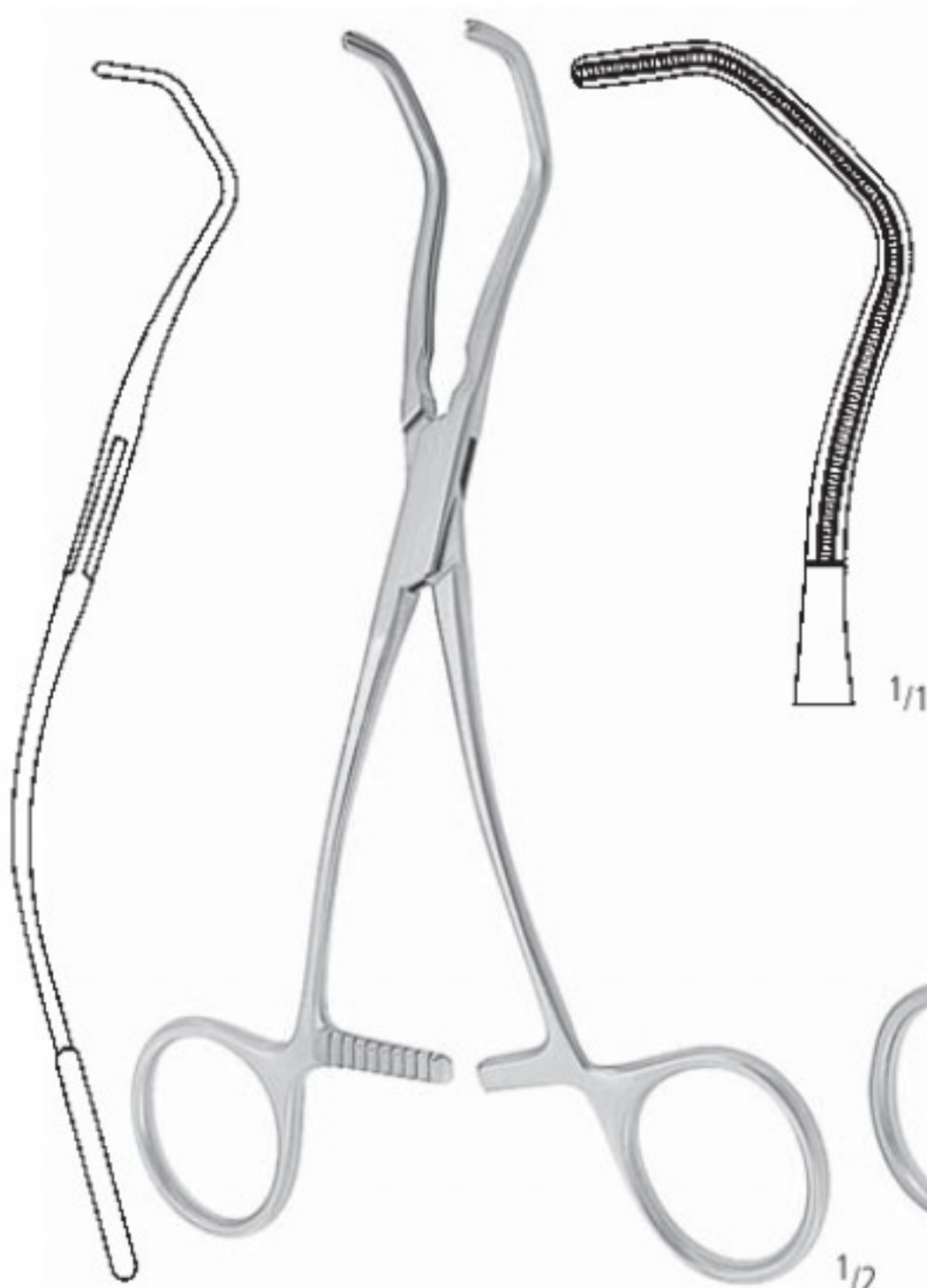

DE BAKY
 KK 501/17
 17,0 cm/6 3/4"

1/2

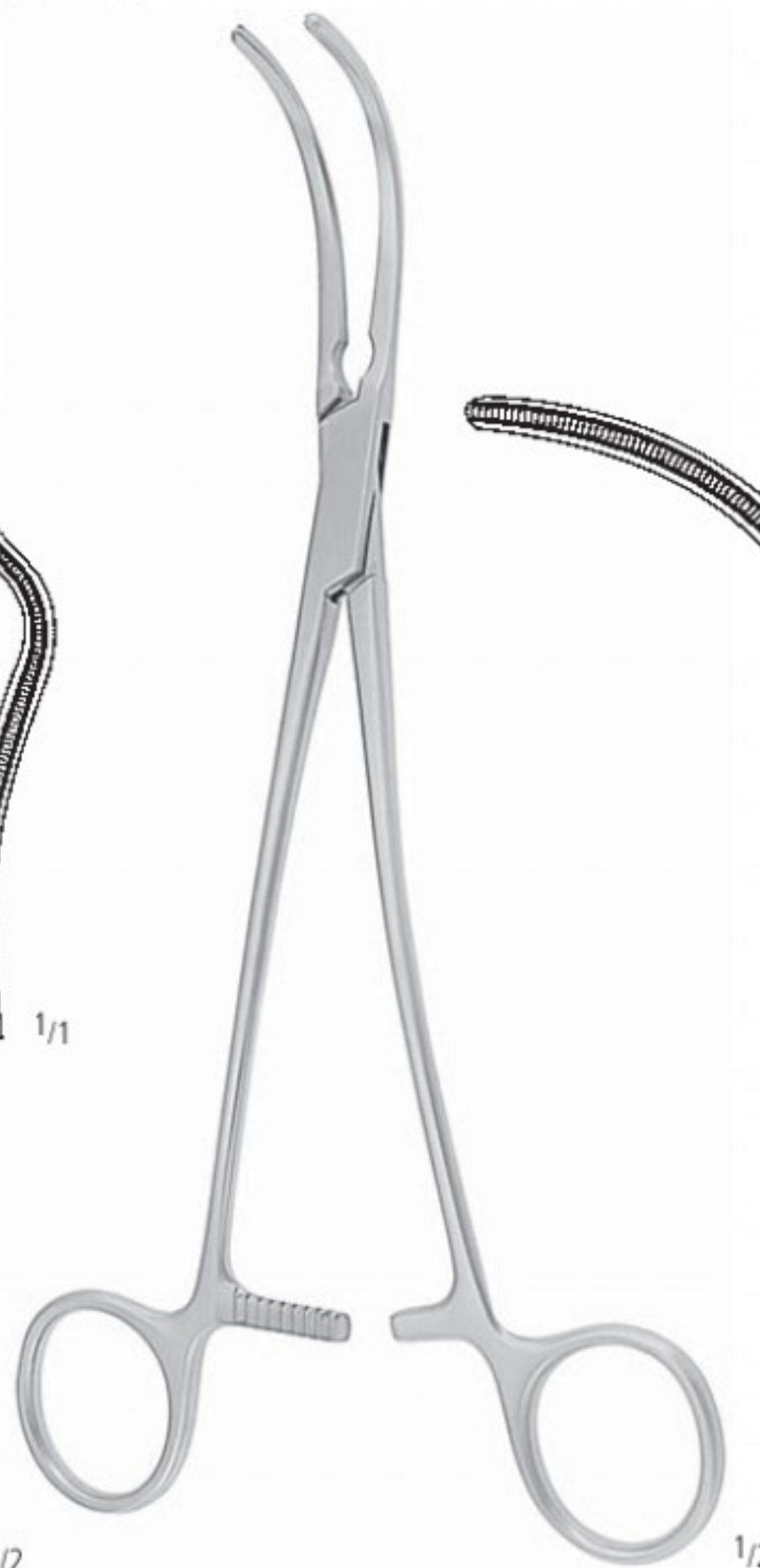

DE BAKY-BAHNSON

1/2

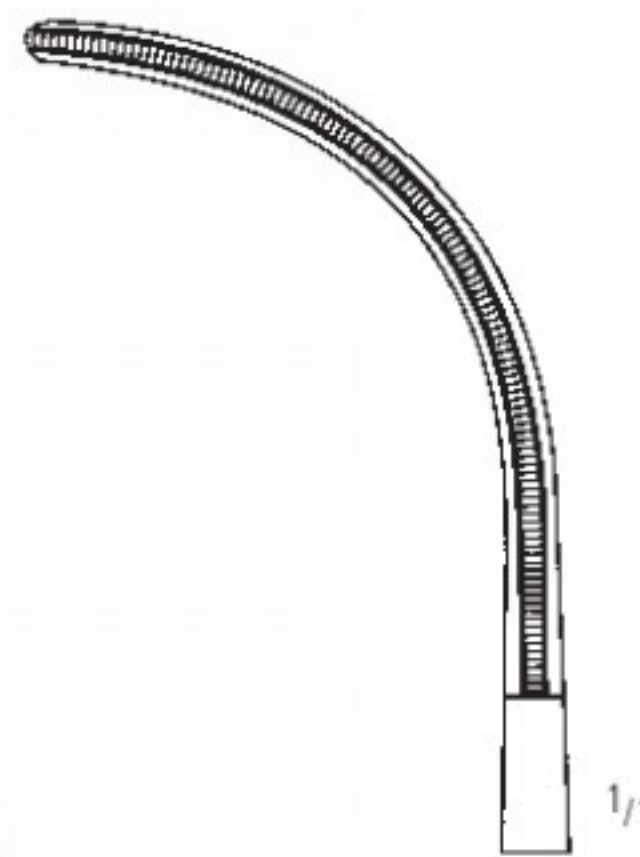

KK 503/23
 23,0 cm/9"

1/1

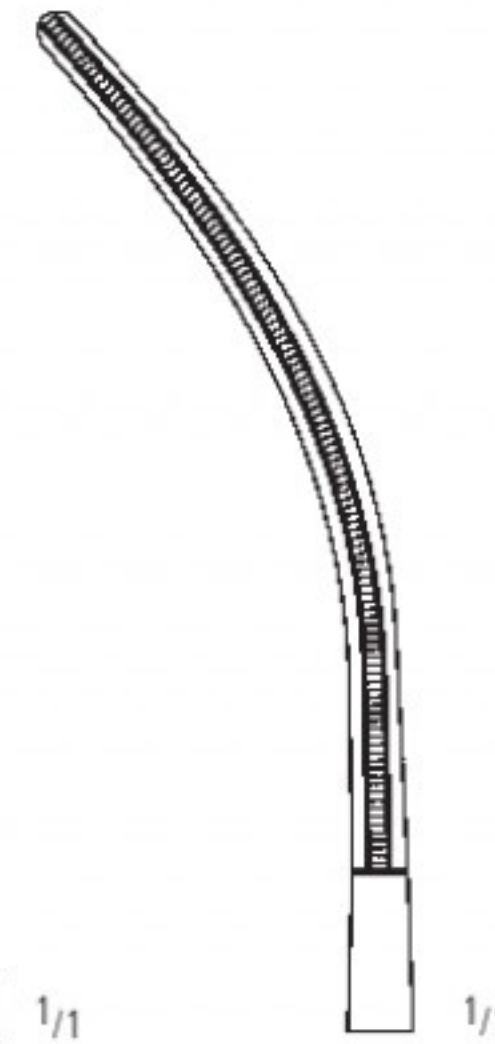

KK 503/24
 24,0 cm/9 1/2"

1/1

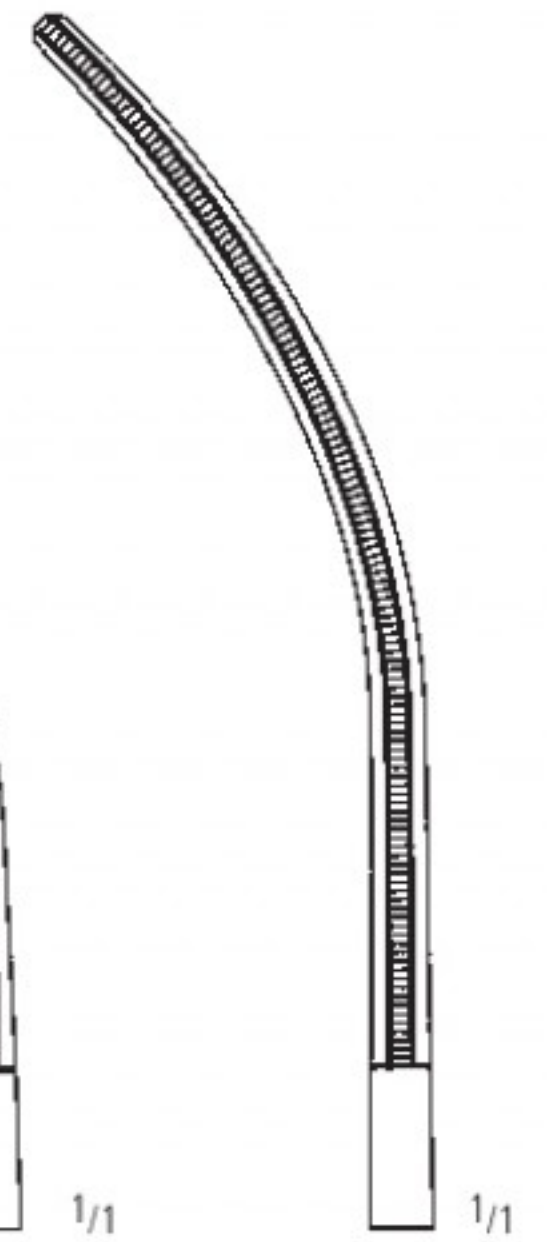

KK 503/25
 25,0 cm/10"

1/1

AA
 AB
 AC
 AD
 AE
 AF
 AK
 AL
 AO
 KA
 KK
 X

KK

Atrauma-Klemmen
 Atrauma Forceps
 Pinzas Atrauma
 Pincès atraumatiques
 Pinze Atrauma



DE BAKEY



HARKEN

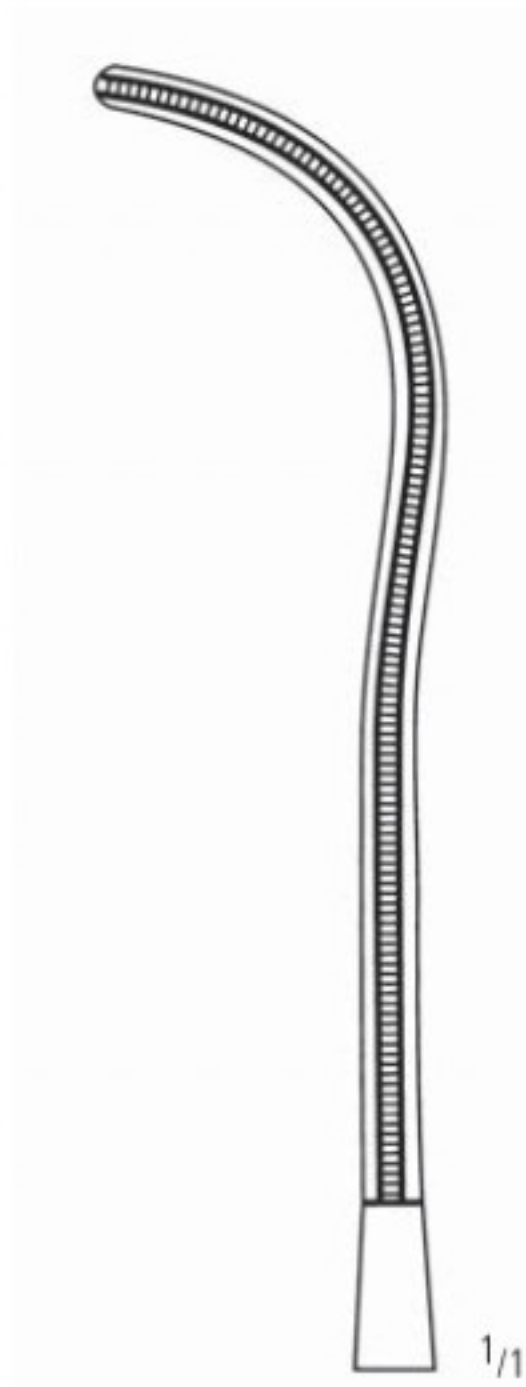

KK 505/01
 24,0 cm/9¹/₂"

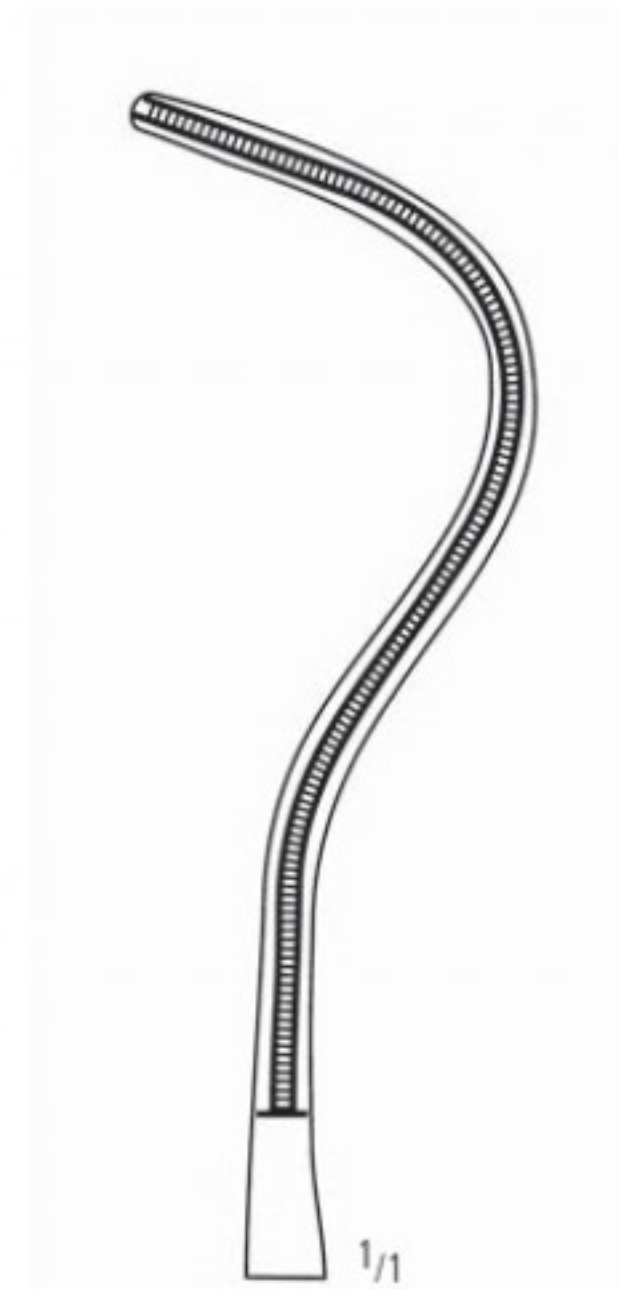

KK 505/02
 24,0 cm/9¹/₂"

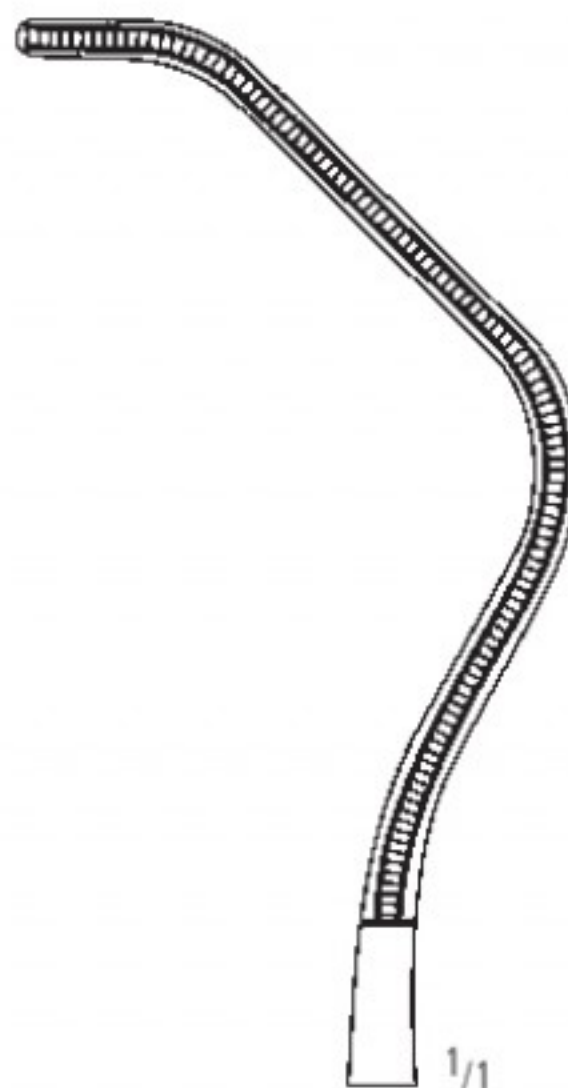

KK 505/03
 24,0 cm/9¹/₂"

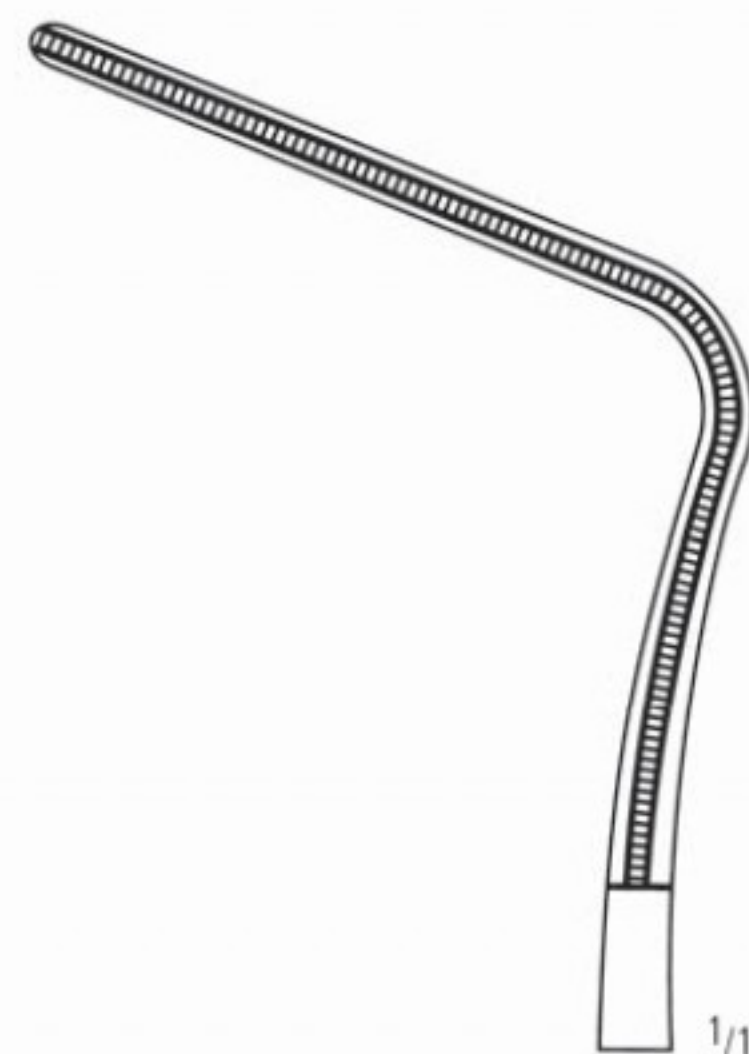

KK 505/04
 24,0 cm/9¹/₂"

Atrauma-Klemmen
 Atrauma Forceps
 Pinzas Atrauma
 Pincés atraumatiques
 Pinze Atrauma



DE BAKEY

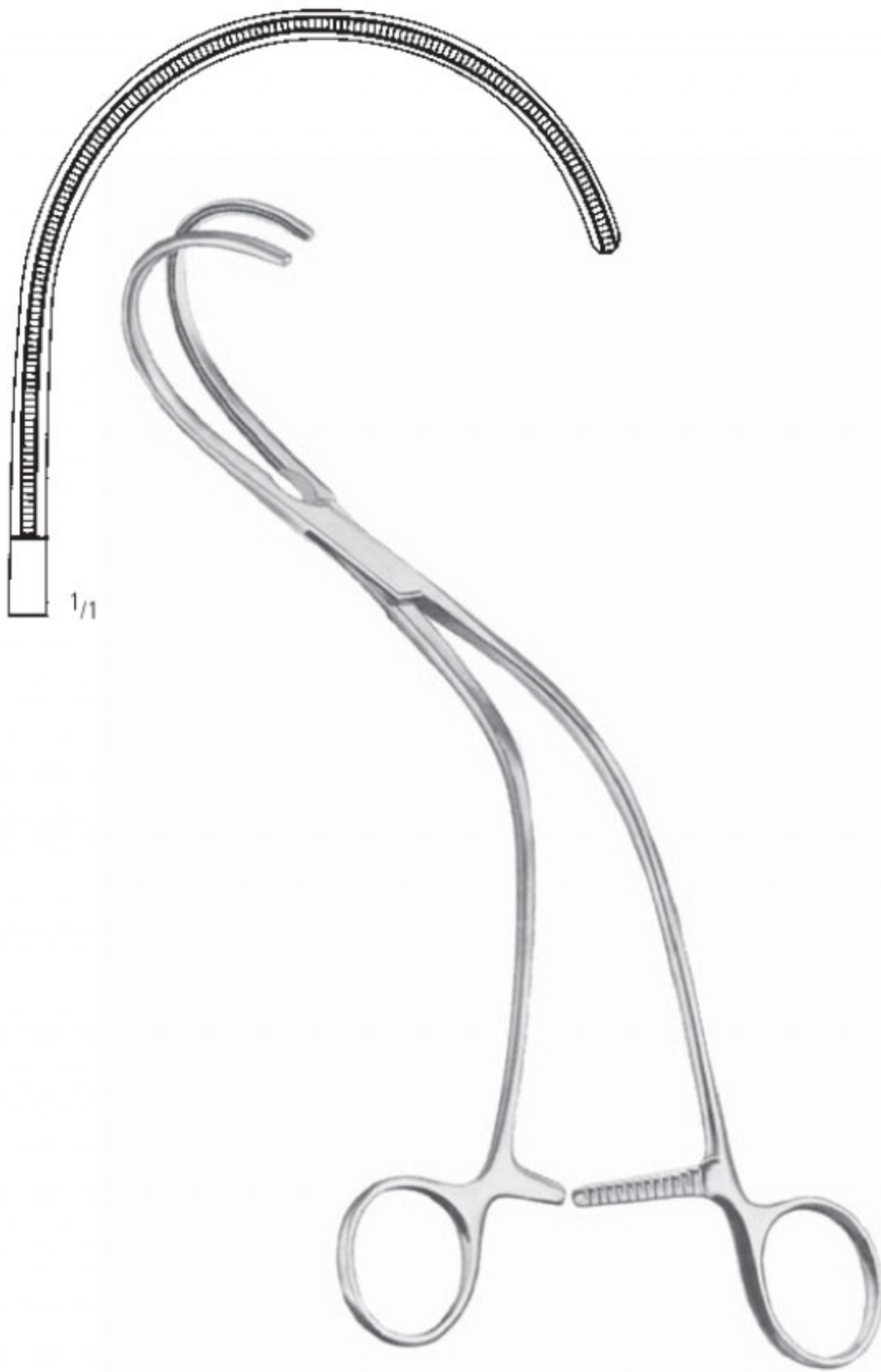

WEBER
 KK 509/01
 26,0 cm/10¹/₄"

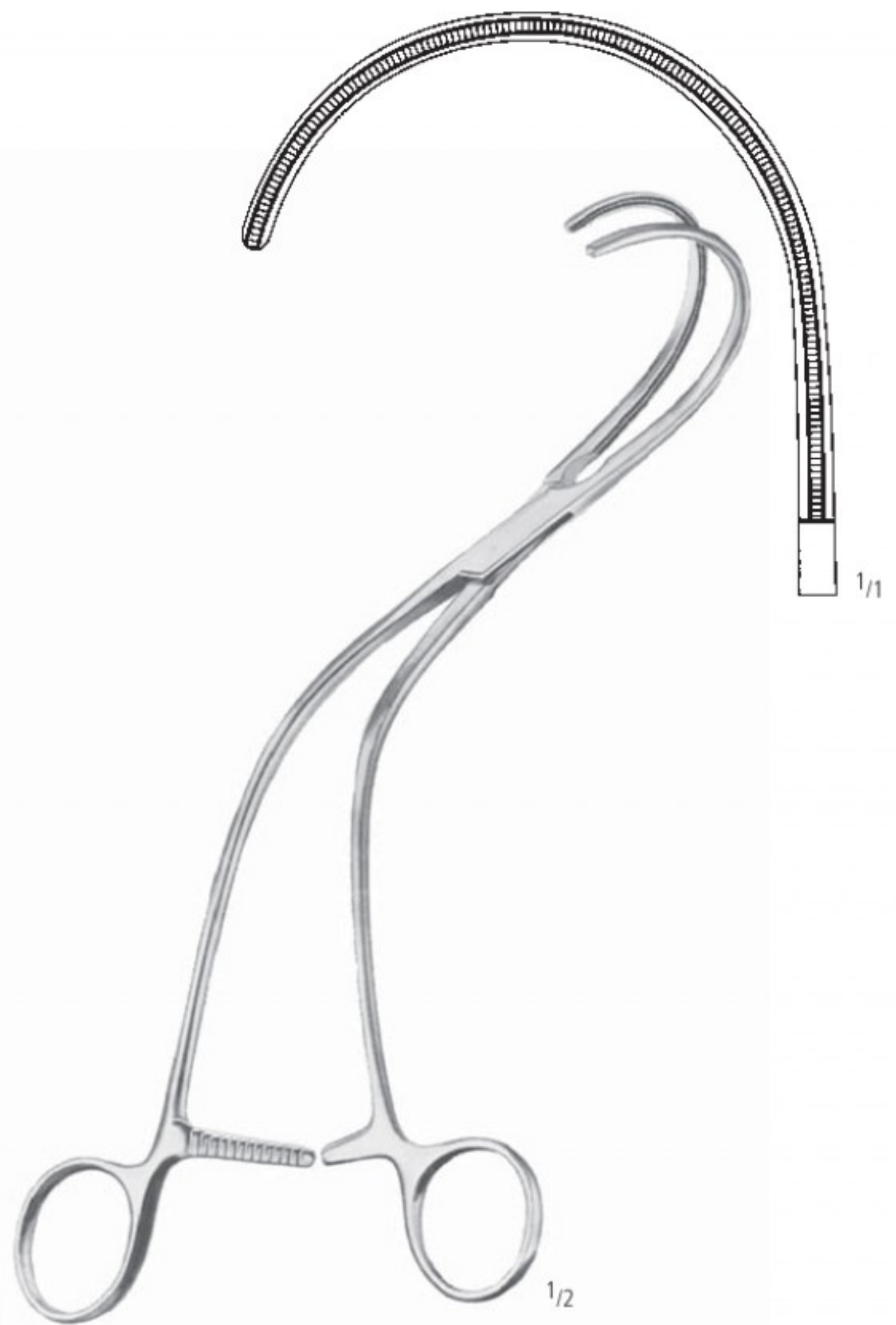

WEBER
 KK 509/02
 26,0 cm/10¹/₄"

AA
 AB
 AC
 AD
 AE
 AF
 AK
 AL
 AO
 KA
 X
KK

Atrauma-Klemmen
 Atrauma Forceps
 Pinzas Atrauma
 Pincès atraumatiques
 Pinze Atrauma



DE BAKEY

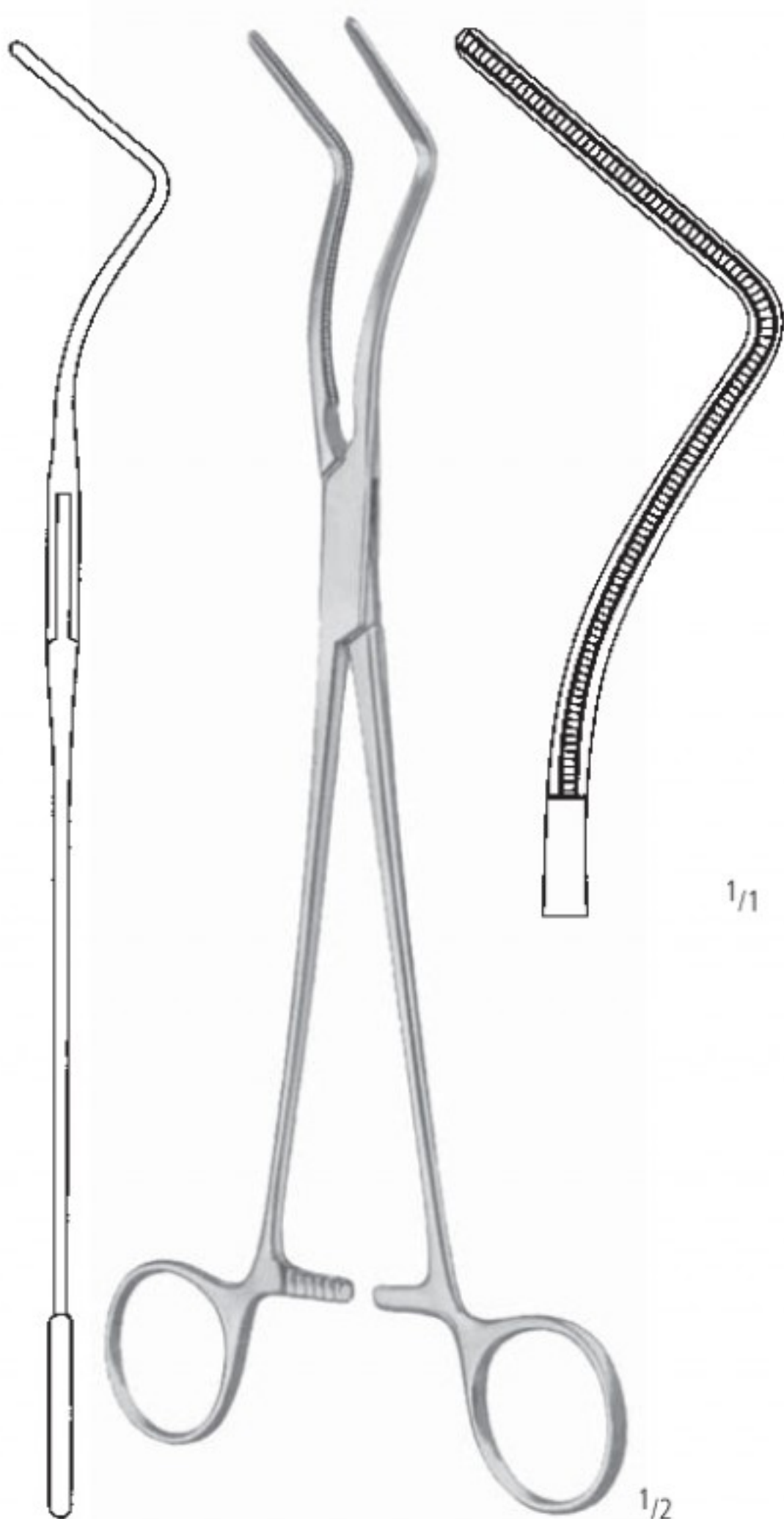

LEES
 KK 511/25
 25,0 cm/10"



LEES

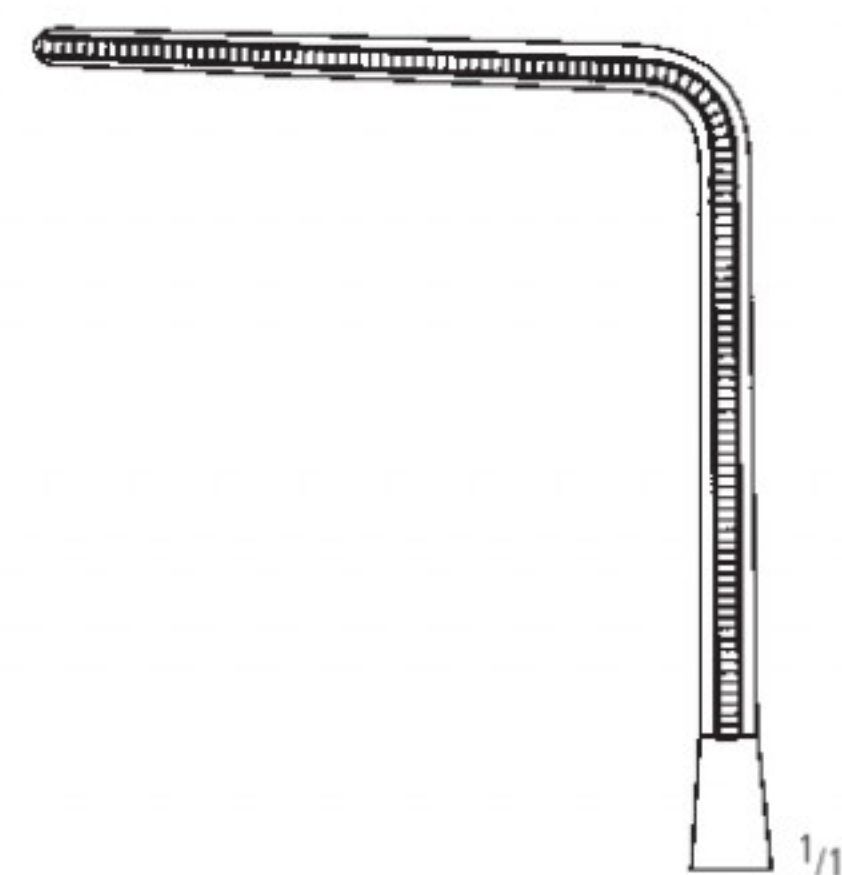

KK 512/23
 23,0 cm/9"

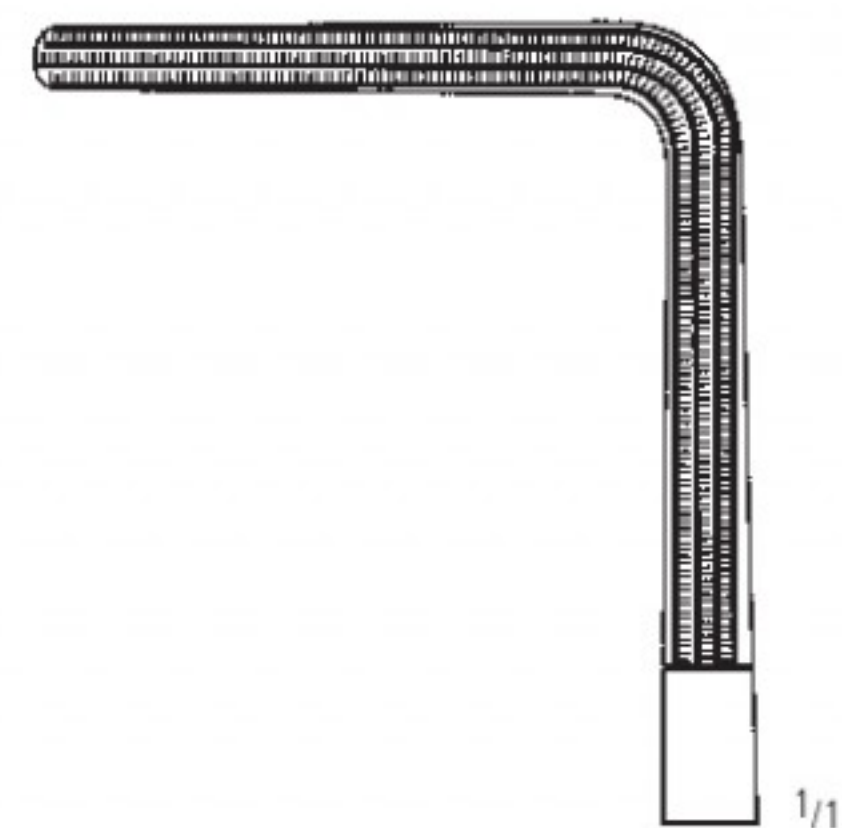

KK 512/25
 25,0 cm/10"

Atrauma-Klemmen
 Atrauma Forceps
 Pinzas Atrauma
 Pincas atraumatiques
 Pinze Atrauma



DE BAKEY

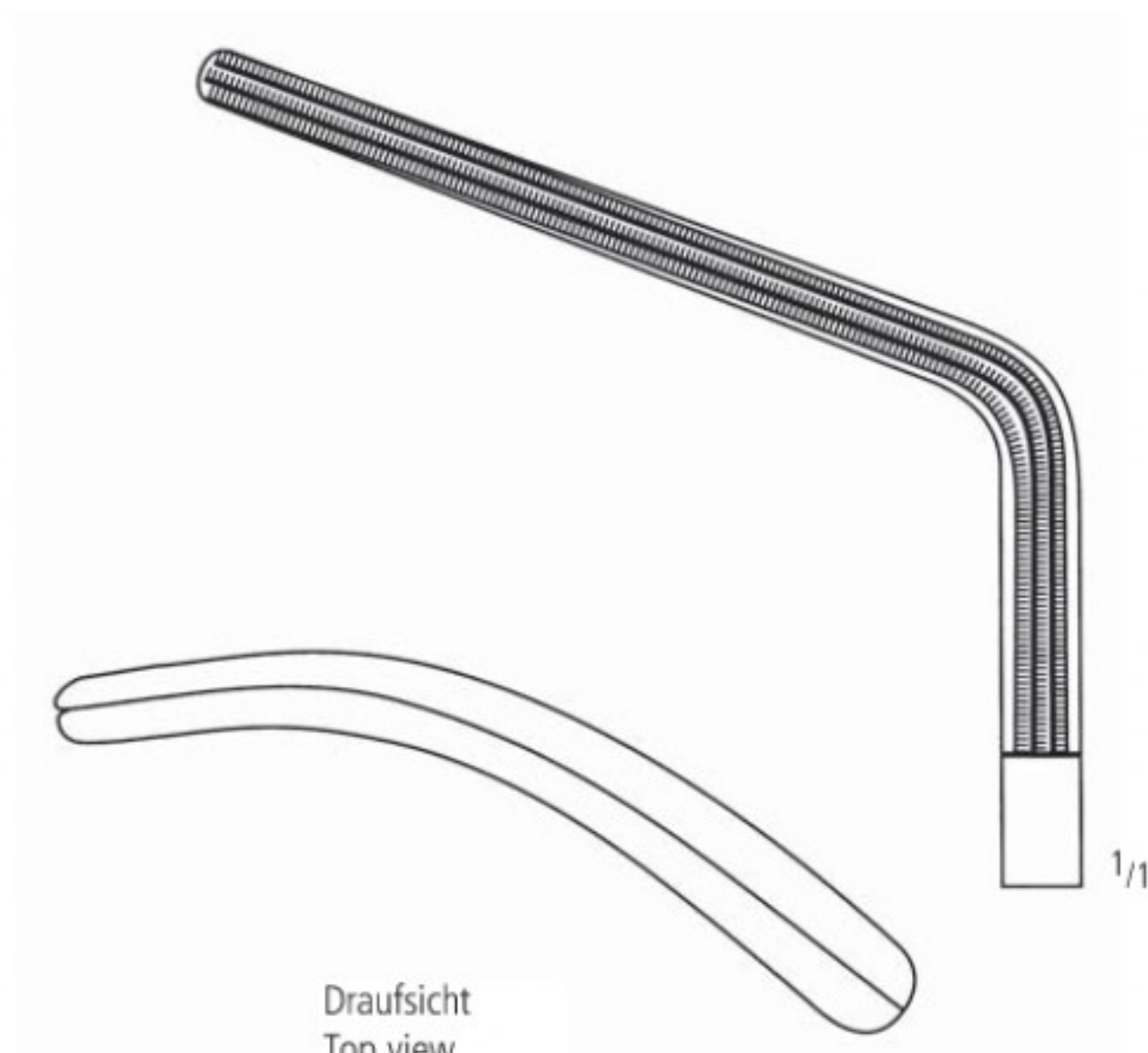
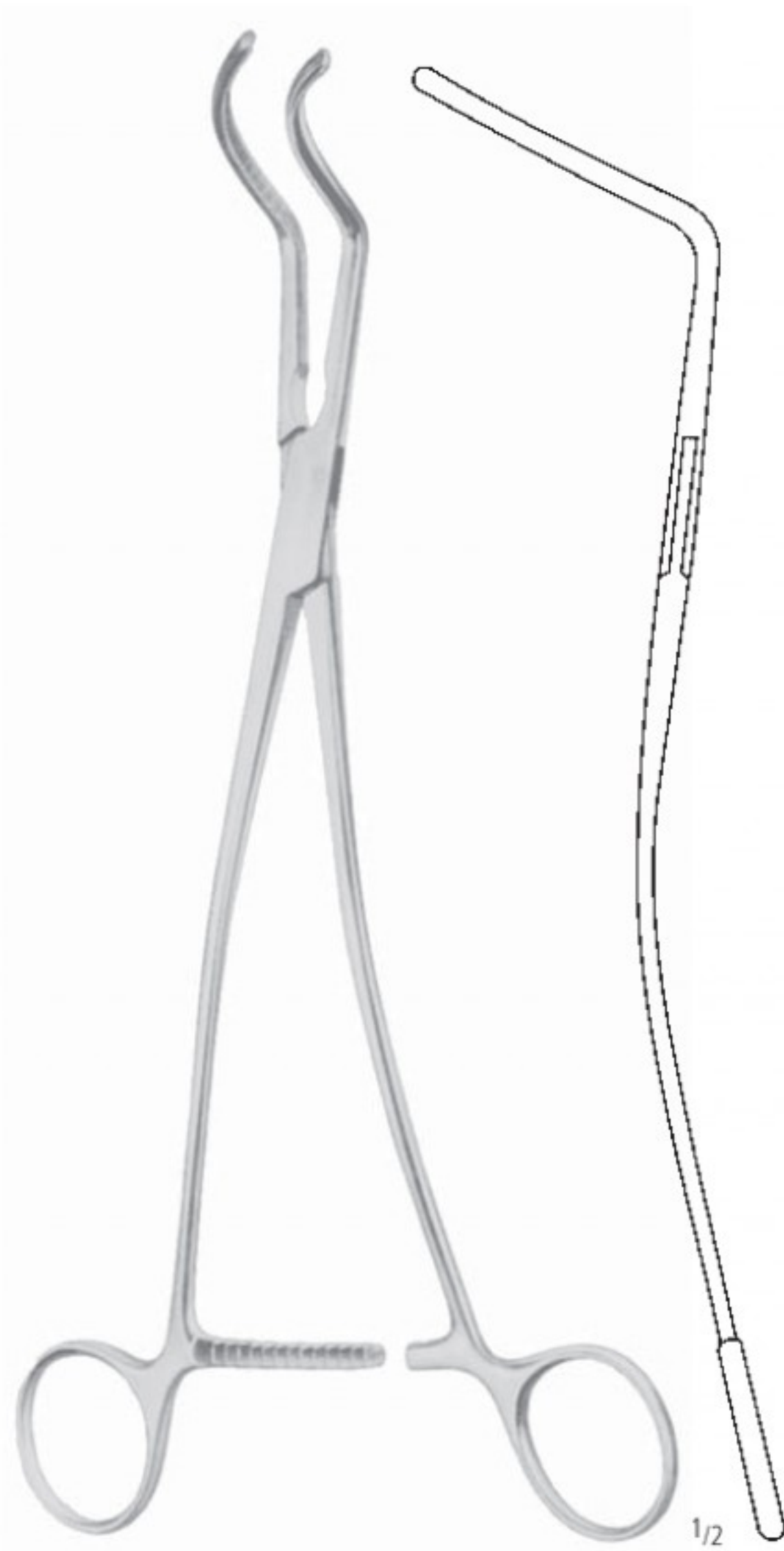

Draufsicht
 Top view
 Vista de arriba
 Vue en plan
 Vista da sopra

DE BAKEY
 KK 513/27
 27,0 cm/10¹/₂"

AA

AB

AC

AD

AE

AF

AK

AL

AO

KA

KK

X

Atrauma-Klemmen
 Atrauma Forceps
 Pinzas Atrauma
 Pincès atraumatiques
 Pinze Atrauma



DE BAKY

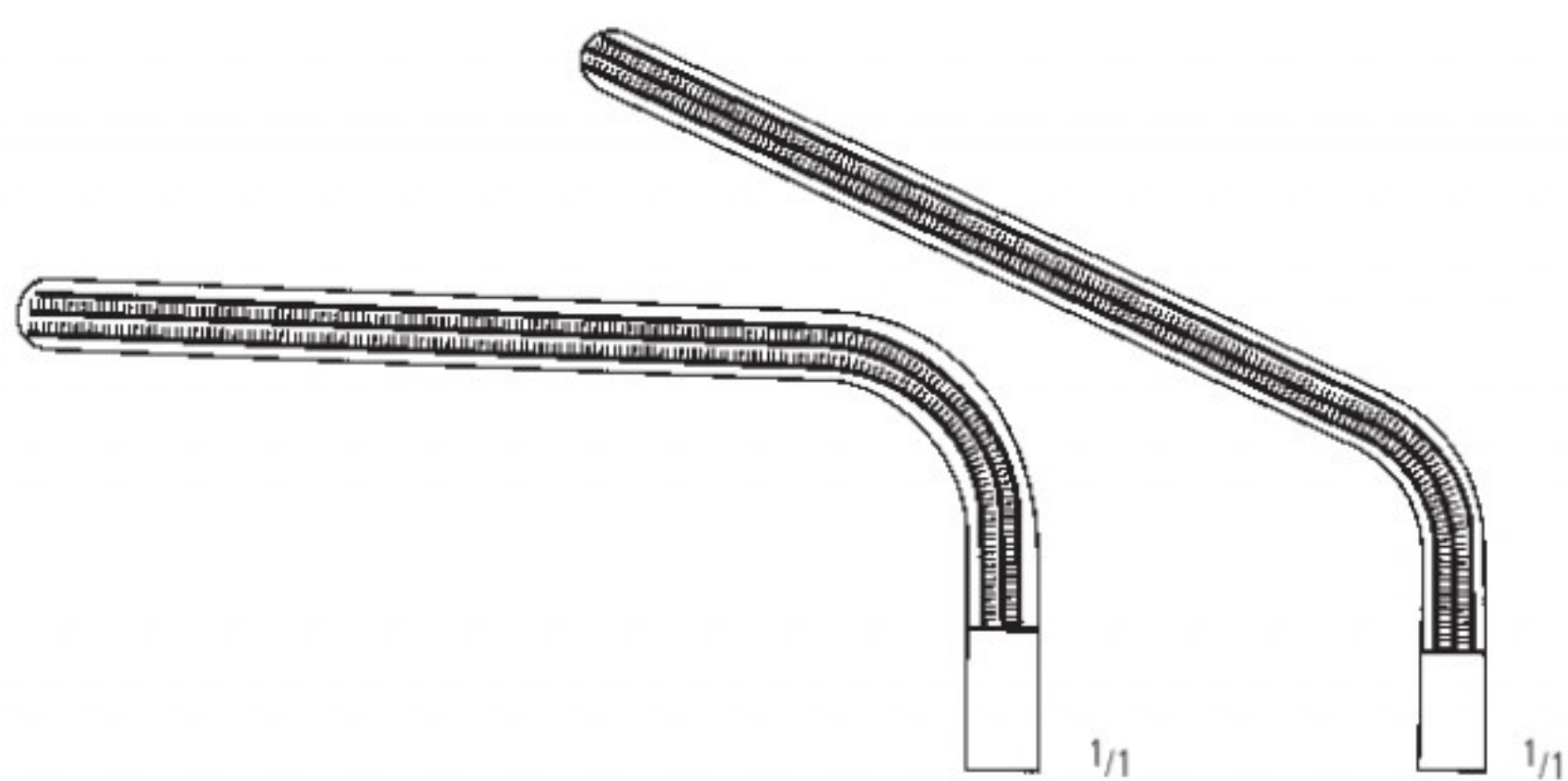

KK 515/18
 18,0 cm/7"

KK 515/20
 20,0 cm/8"

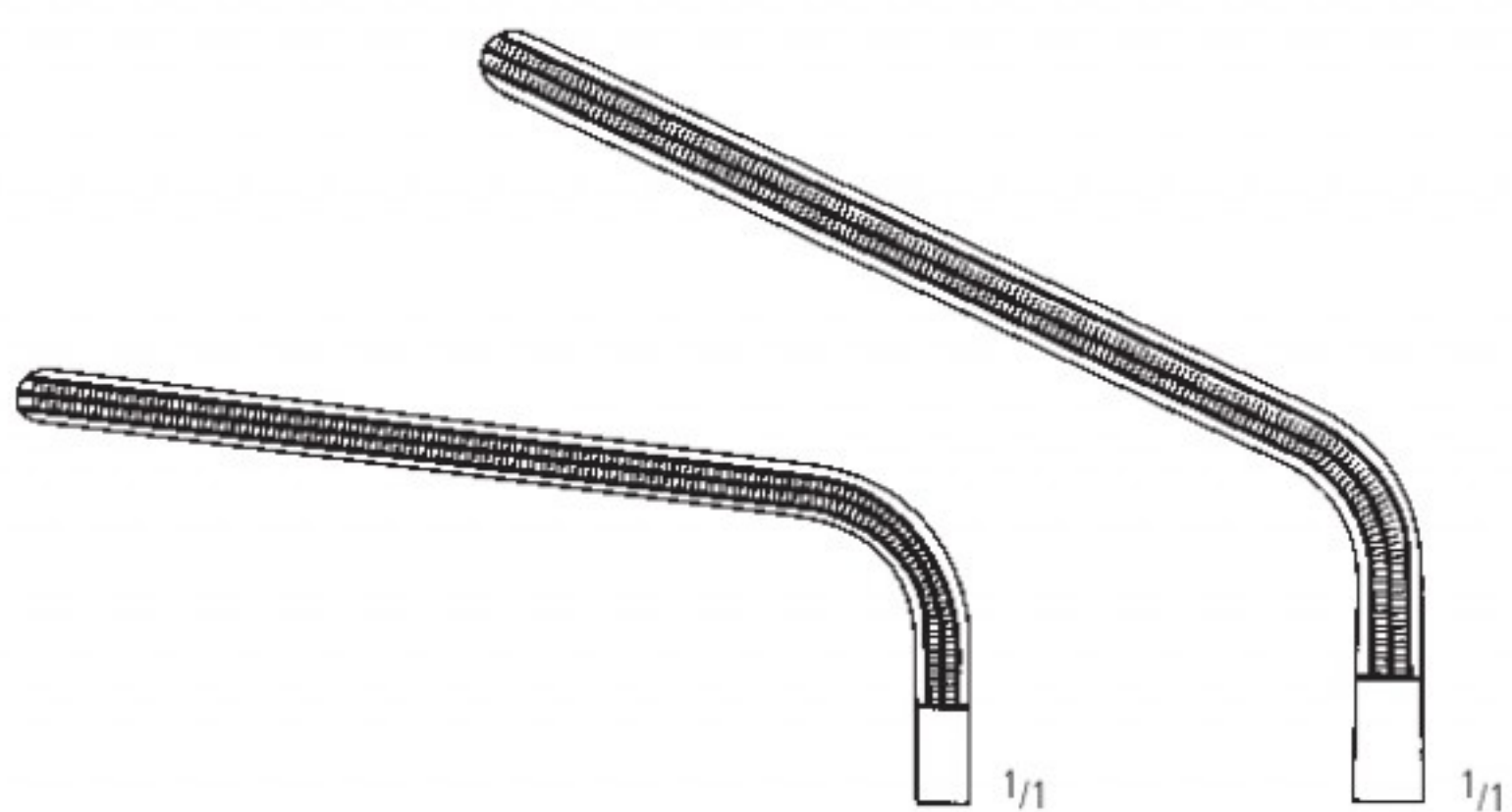

KK 515/23
 23,0 cm/9"

KK 515/25
 25,0 cm/10"



MORRIS-DE BAKY

Atrauma-Klemmen
 Atrauma Forceps
 Pinzas Atrauma
 Pincès atraumatiques
 Pinze Atrauma



DE BAKEY



OCHSNER
 KK 517/23
 23,5 cm/9¹/₄"



1/1



DIETRICH
 KK 519/21
 21,0 cm/8¹/₄"

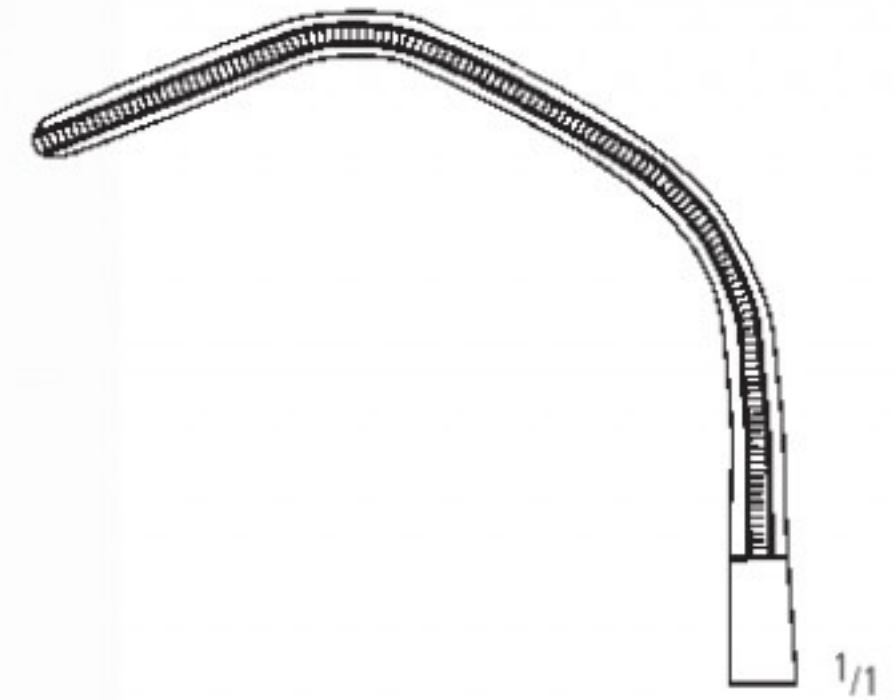

1/1



GREGORY



1/1



1/1

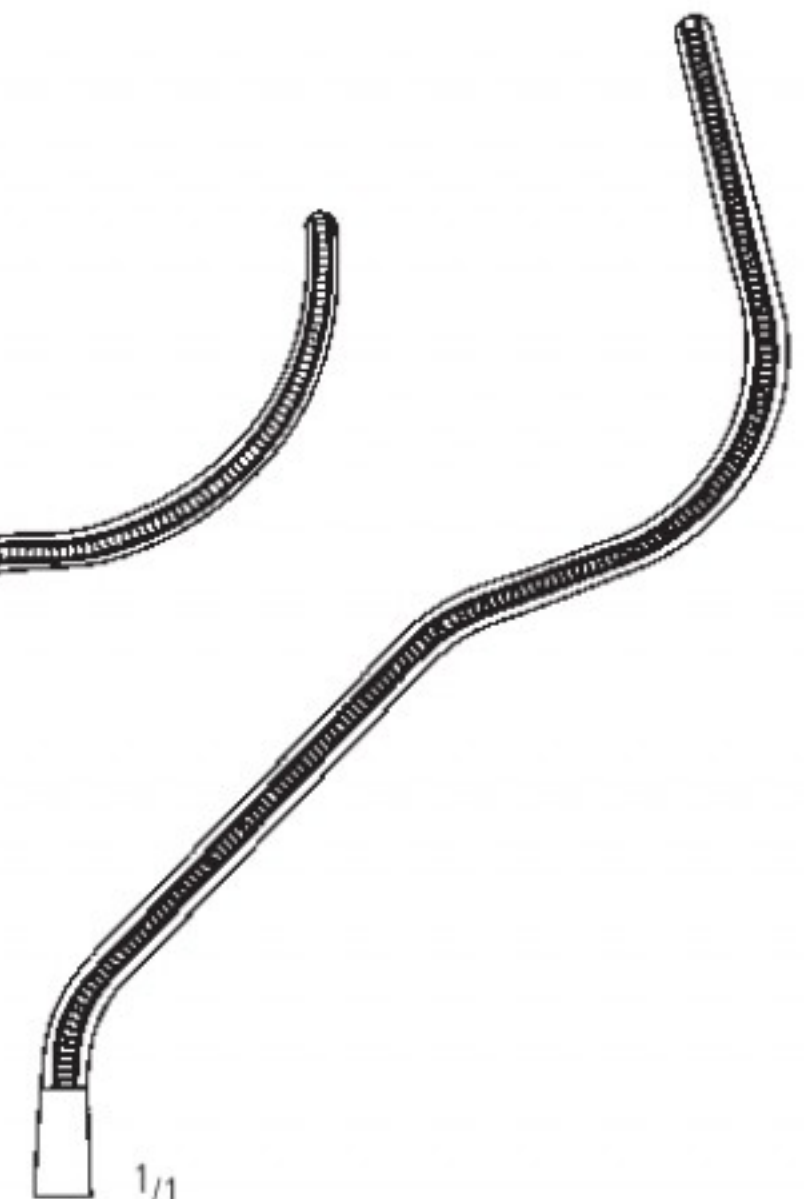

1/1

KK 521/14
 14,0 cm/5¹/₂"

KK 521/16
 16,0 cm/6¹/₄"

KK 521/18
 18,0 cm/7"

AA
 AB
 AC
 AD
 AE
 AF
 AK
 AL
 AO
 KA
 KK
 X

Atrauma-Klemmen
 Atrauma Forceps
 Pinzas Atrauma
 Pincès atraumatiques
 Pinze Atrauma



DE BAKEY



1/2



1/1

KK 523/17
 17,0 cm/6 1/2"

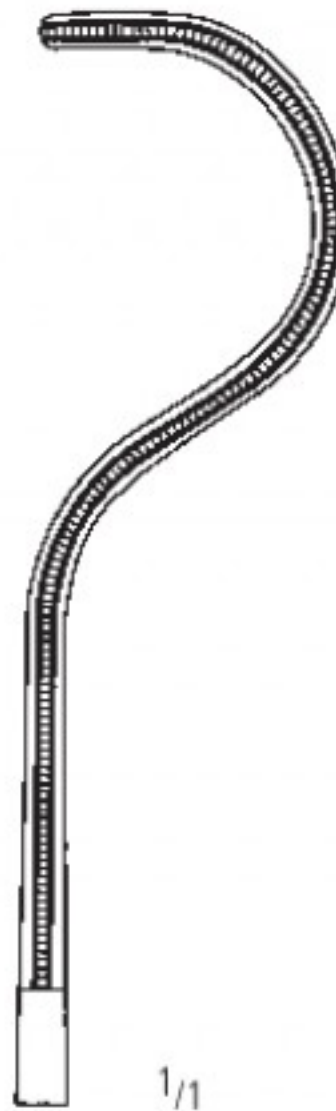

1/1

KK 523/18
 18,0 cm/7"

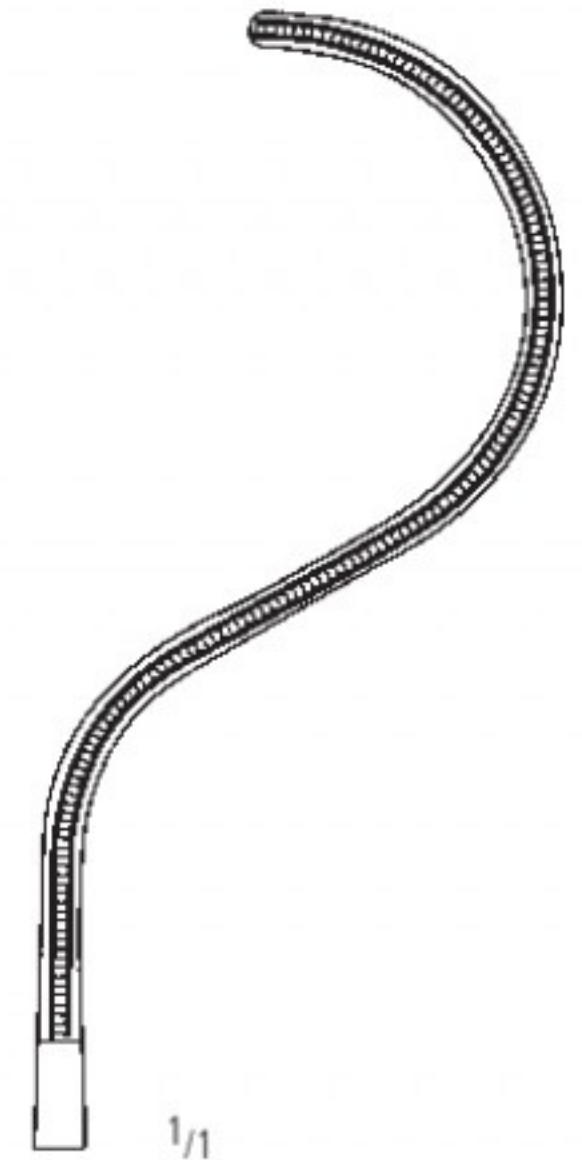

1/1

KK 523/19
 18,5 cm/7 1/4"

DALE

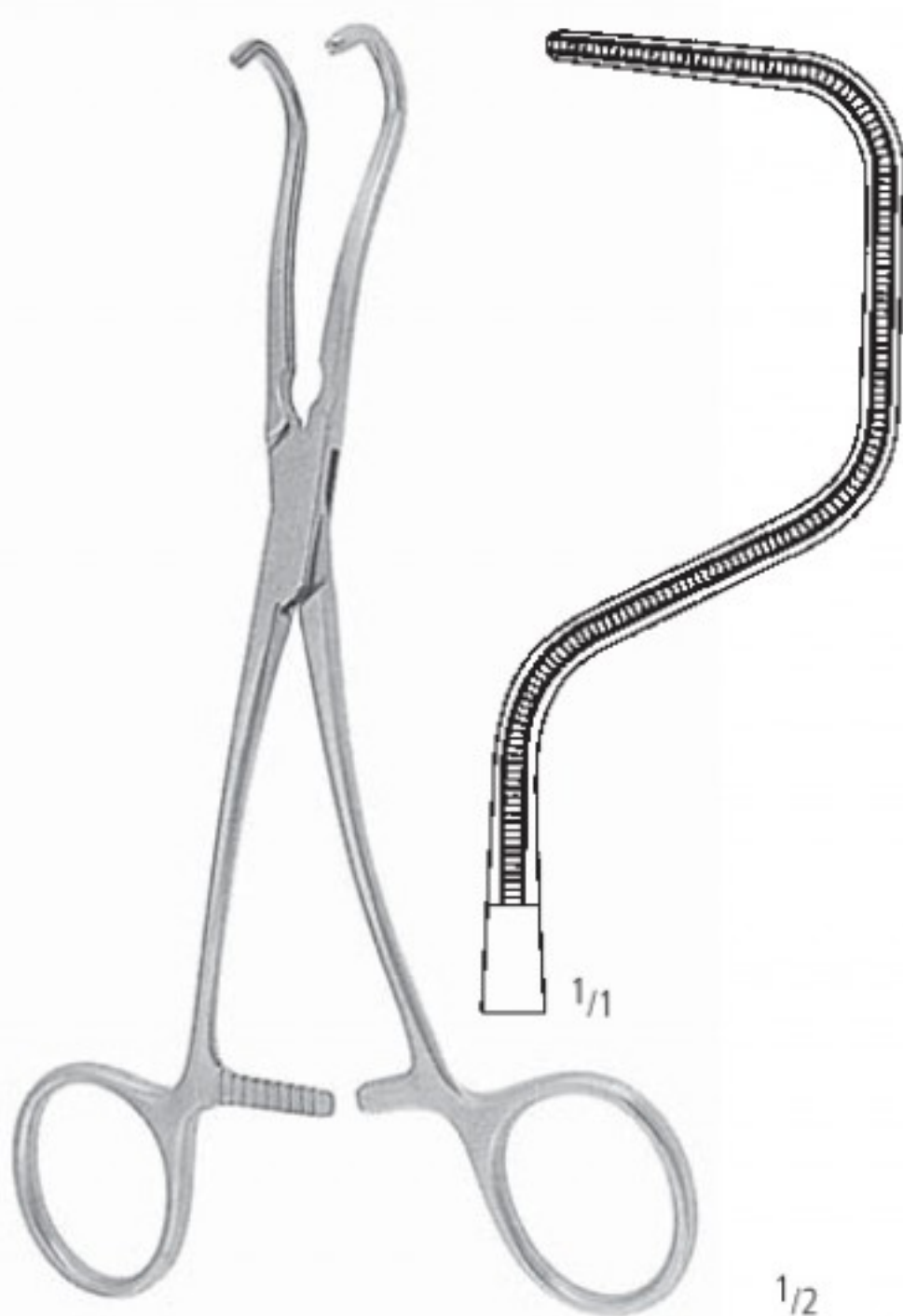

1/2

DALE
 KK 525/18
 18,5 cm/7"



1/2

DERRA



1/1

KK 527/16
 16,0 cm/6 1/4"



1/1

KK 527/17
 17,0 cm/6 3/4"



1/1

KK 527/18
 18,0 cm/7"

Atrauma-Klemmen
 Atrauma Forceps
 Pinzas Atrauma
 Pincès atraumatiques
 Pinze Atrauma



DE BAKEY

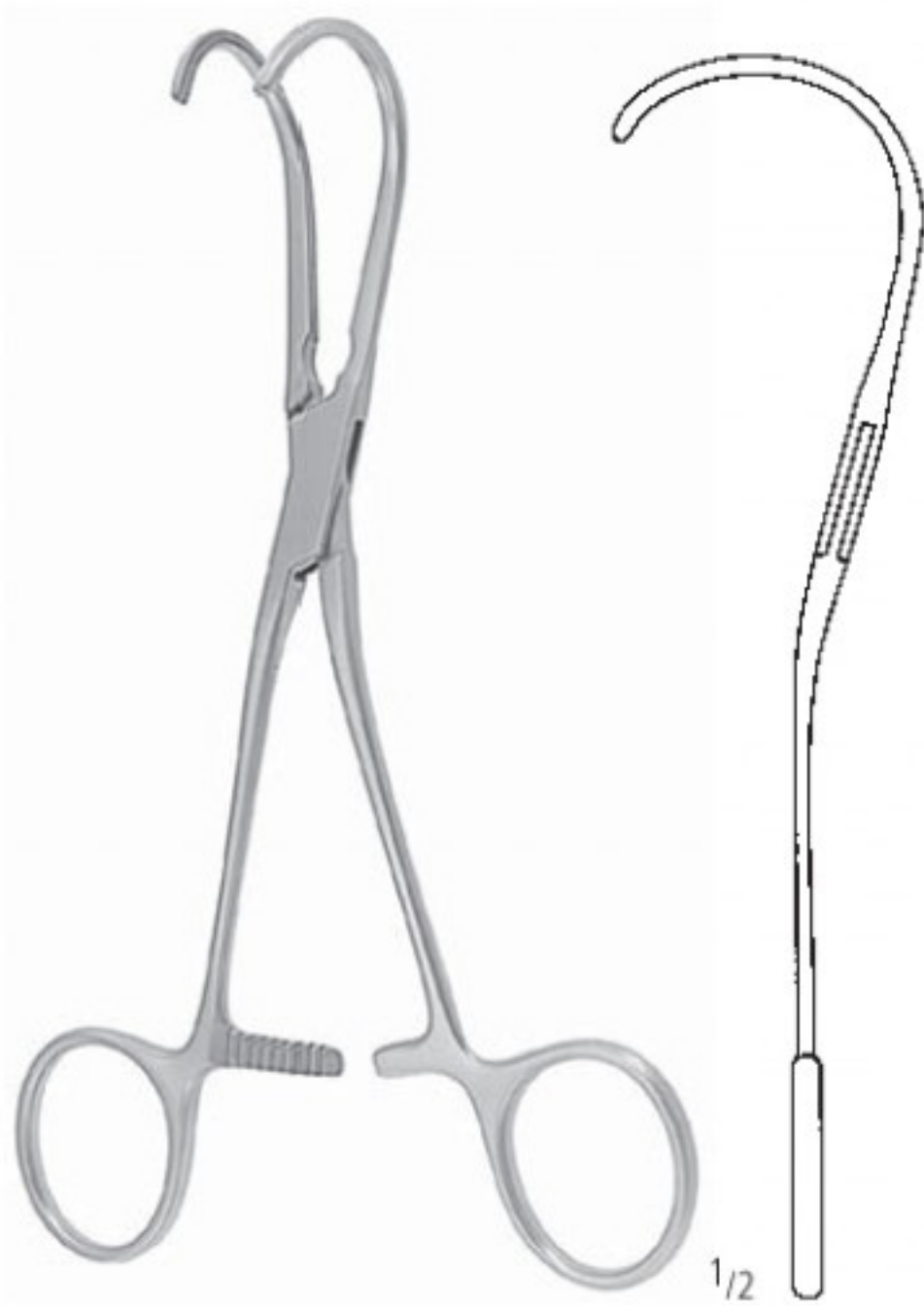

BECK
 KK 535/17
 17,0 cm/6³/₄"

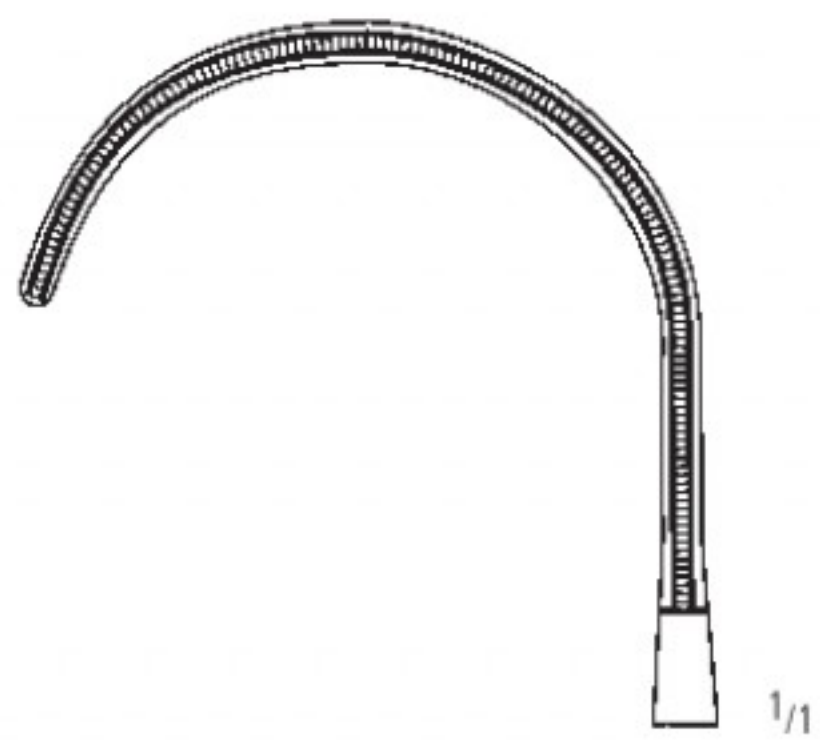

KK 531/16
 16,0 cm/6¹/₄"



KK 531/17
 17,0 cm/6³/₄"

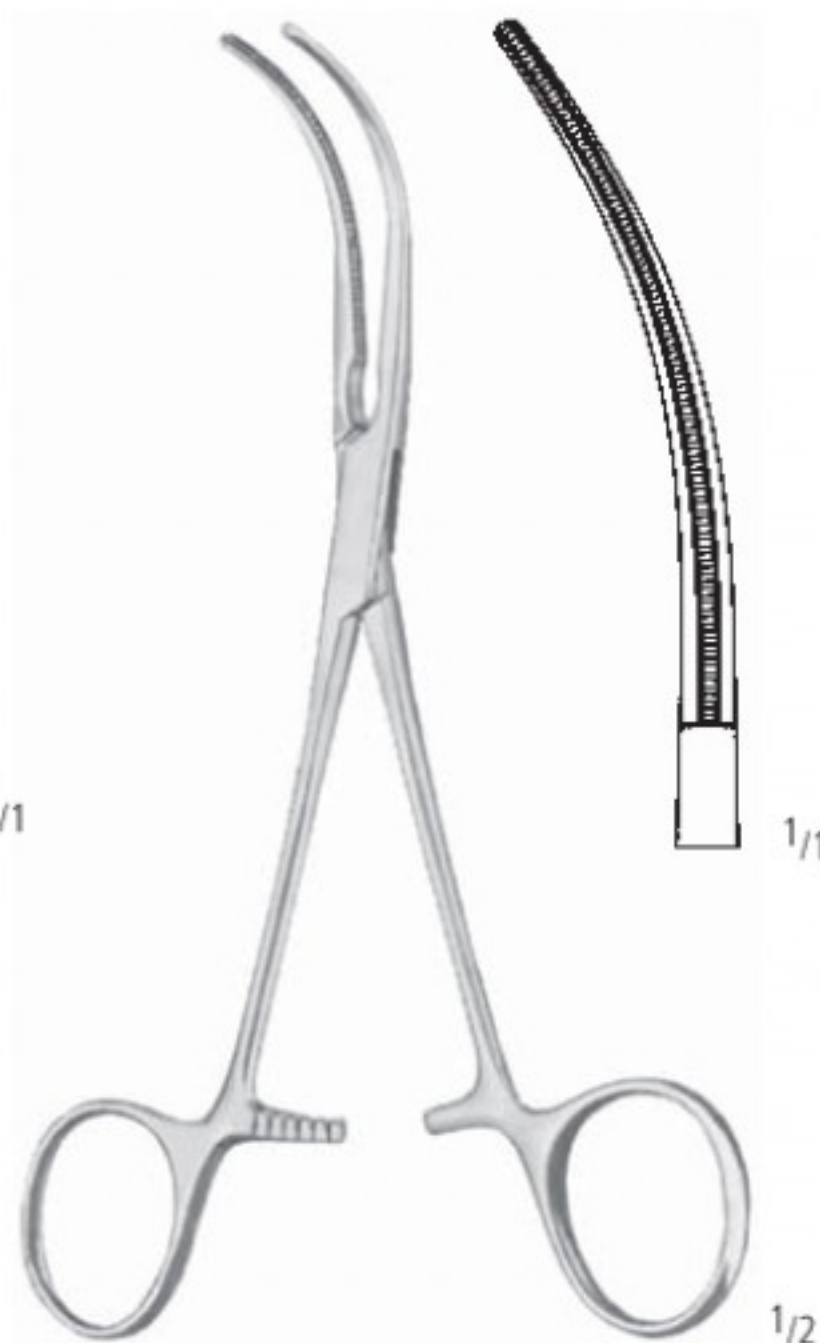

GLOVER
 KK 537/17
 17,0 cm/6³/₄"

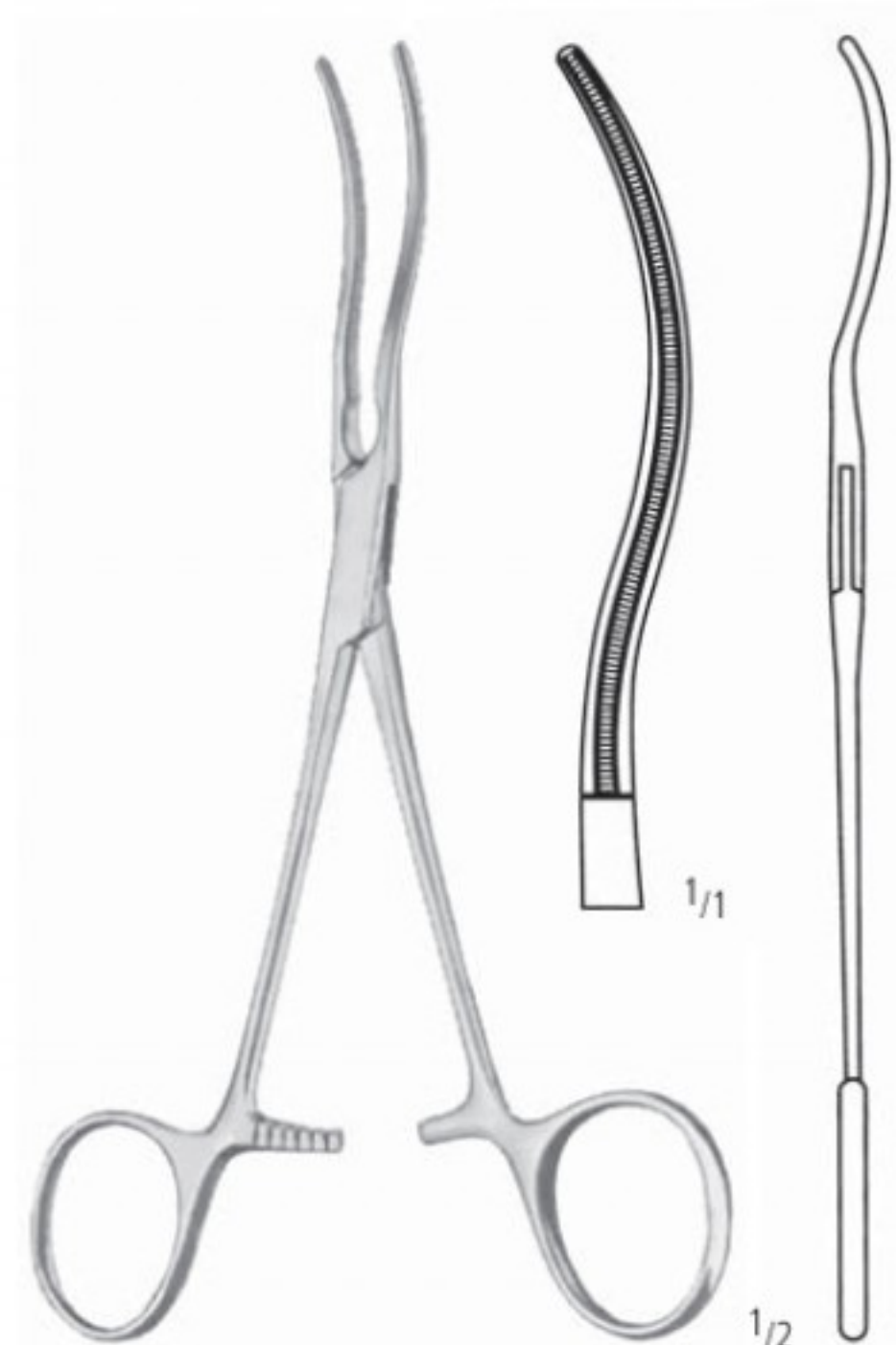

KK 539/17
 17,0 cm/6³/₄"

AA

AB

AC

AD

AE

AF

AK

AL

AO

KA

KK

X

Atrauma-Klemmen
 Atrauma Forceps
 Pinzas Atrauma
 Pincès atraumatiques
 Pinze Atrauma



DE BAKEY

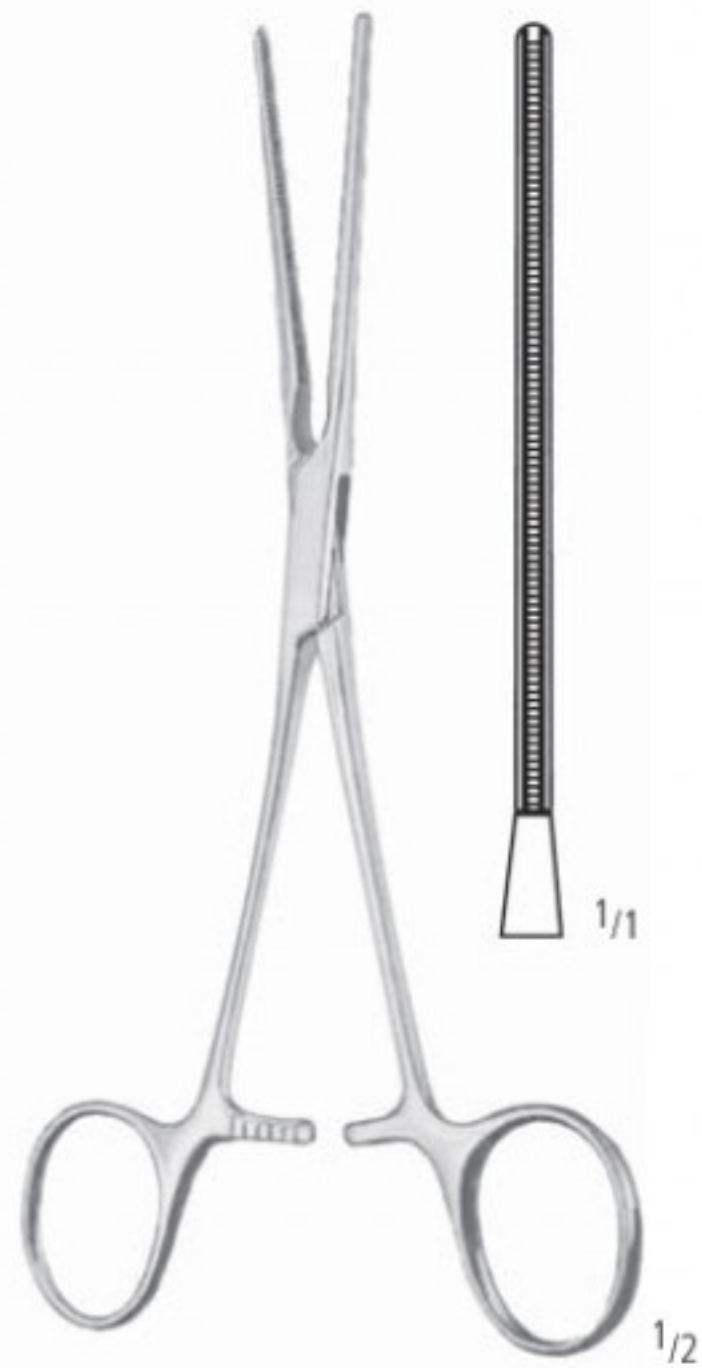

DE BAKEY
 KK 540/17
 17,0 cm/6³/₄"

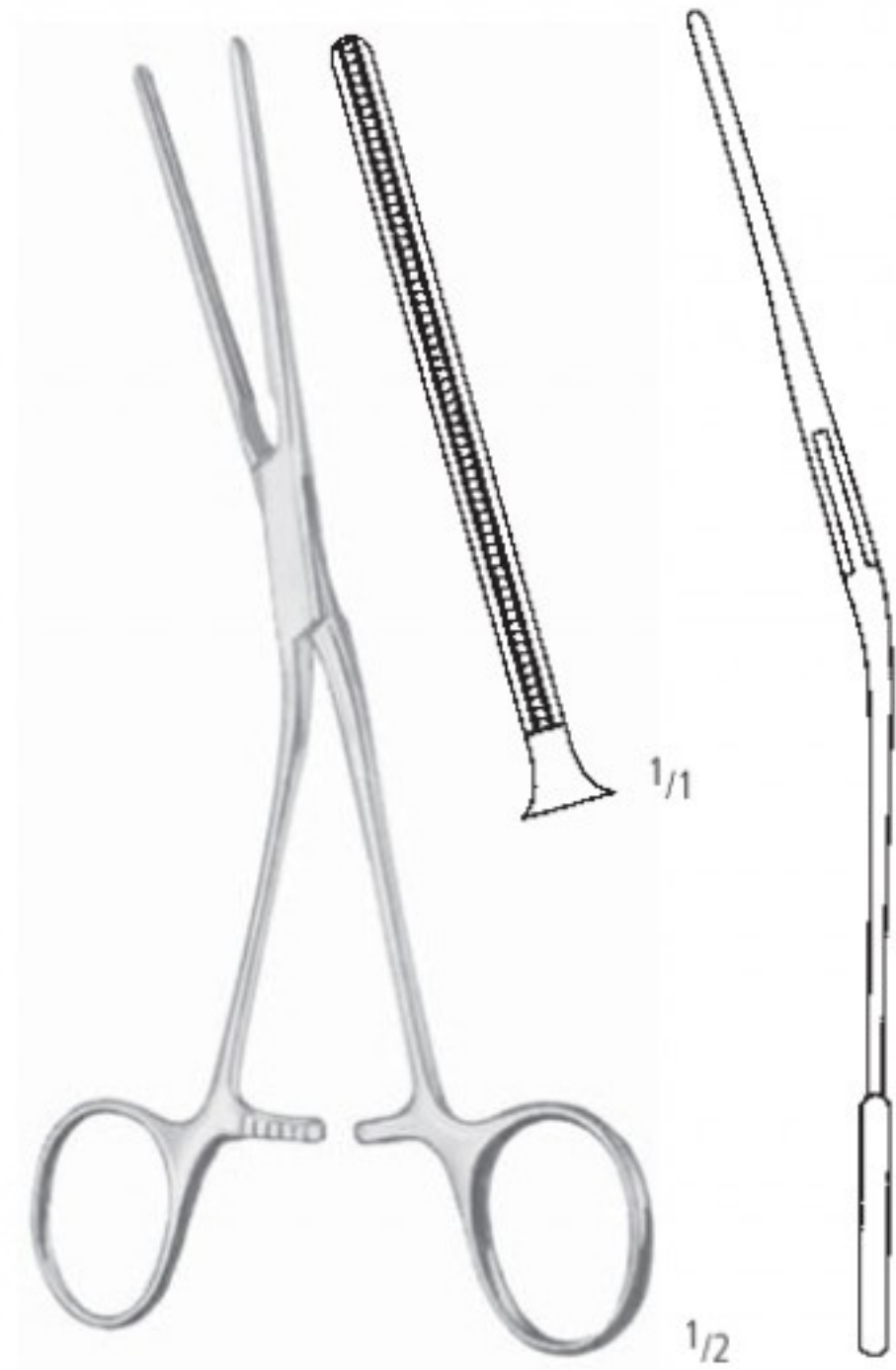

DE BAKEY
 KK 541/17
 17,0 cm/6³/₄"

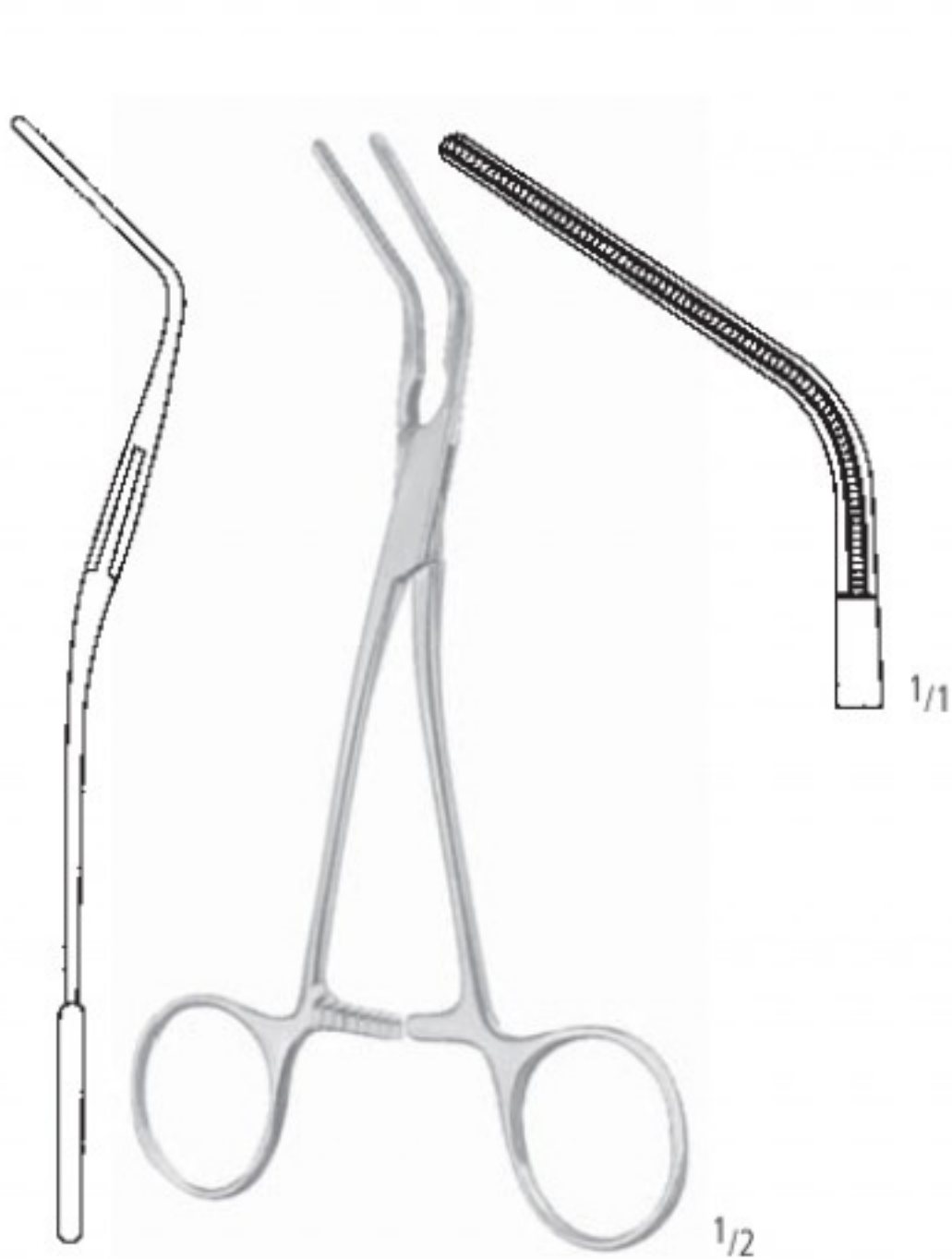

DE BAKEY
 KK 543/15
 15,0 cm/6"

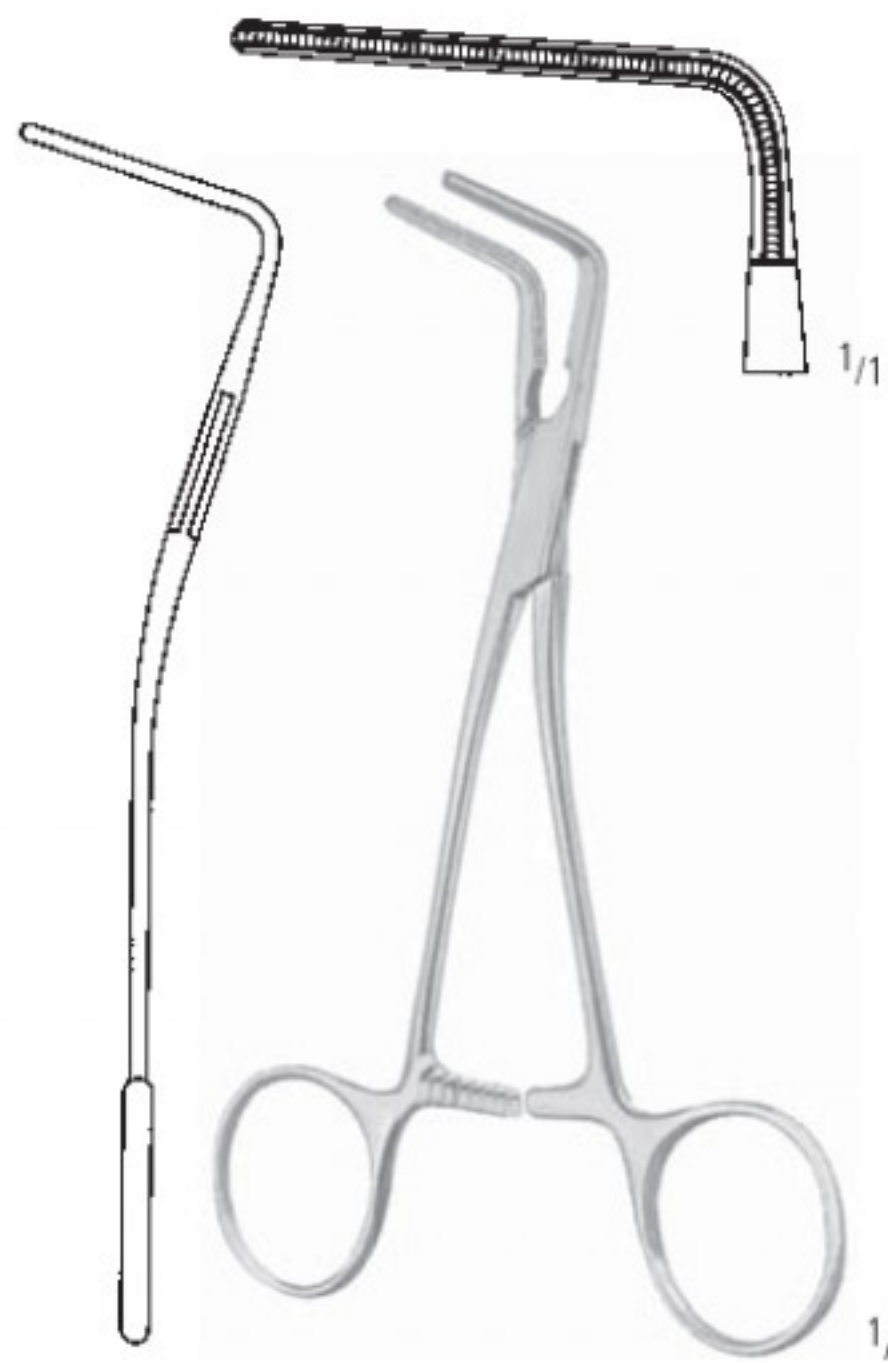

DE BAKEY
 KK 545/15
 15,0 cm/6"

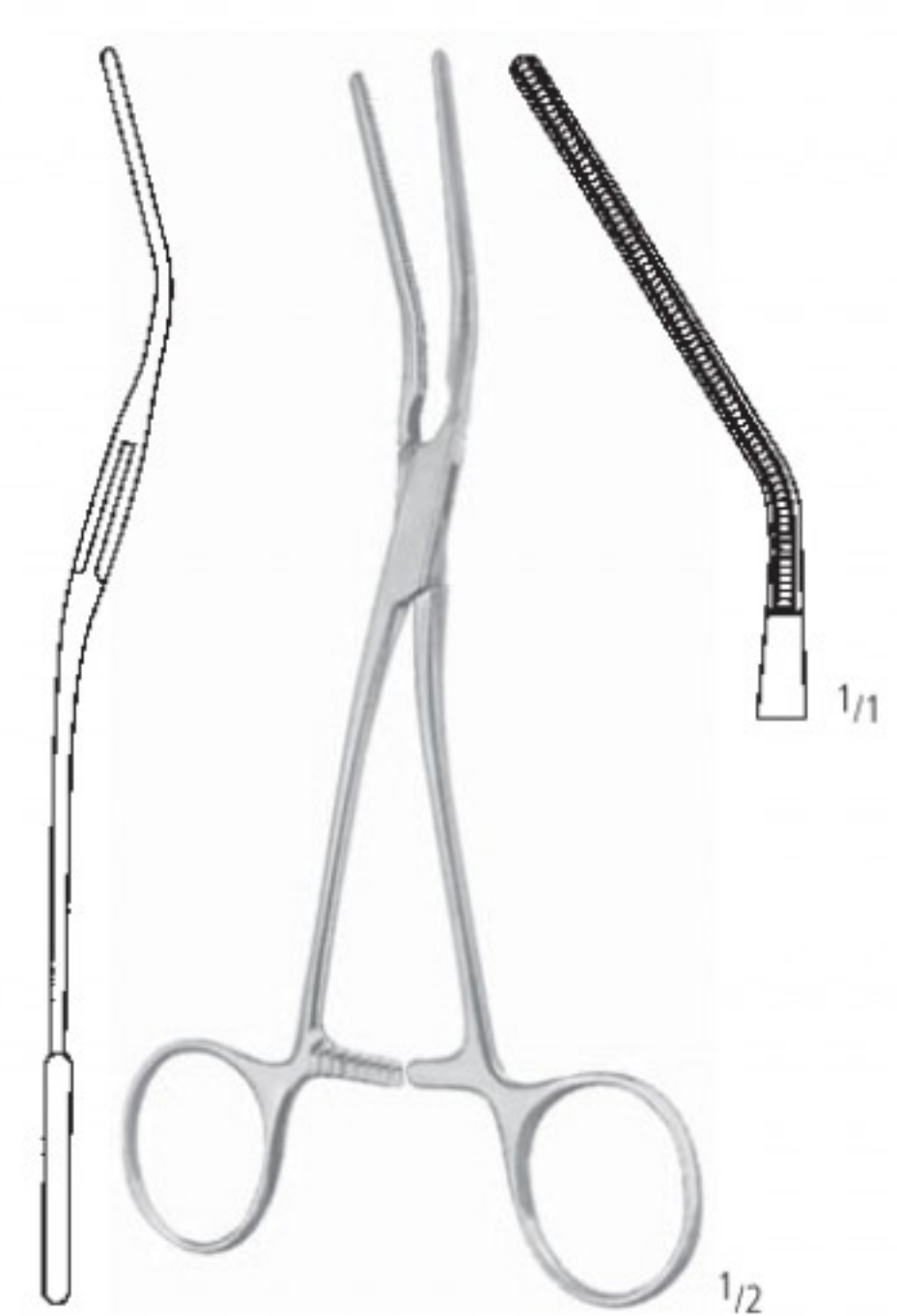

DE BAKEY
 KK 547/16
 16,0 cm/6¹/₄"

Atrauma-Klemmen
 Atrauma Forceps
 Pinzas Atrauma
 Pincès atraumatiques
 Pinze Atrauma

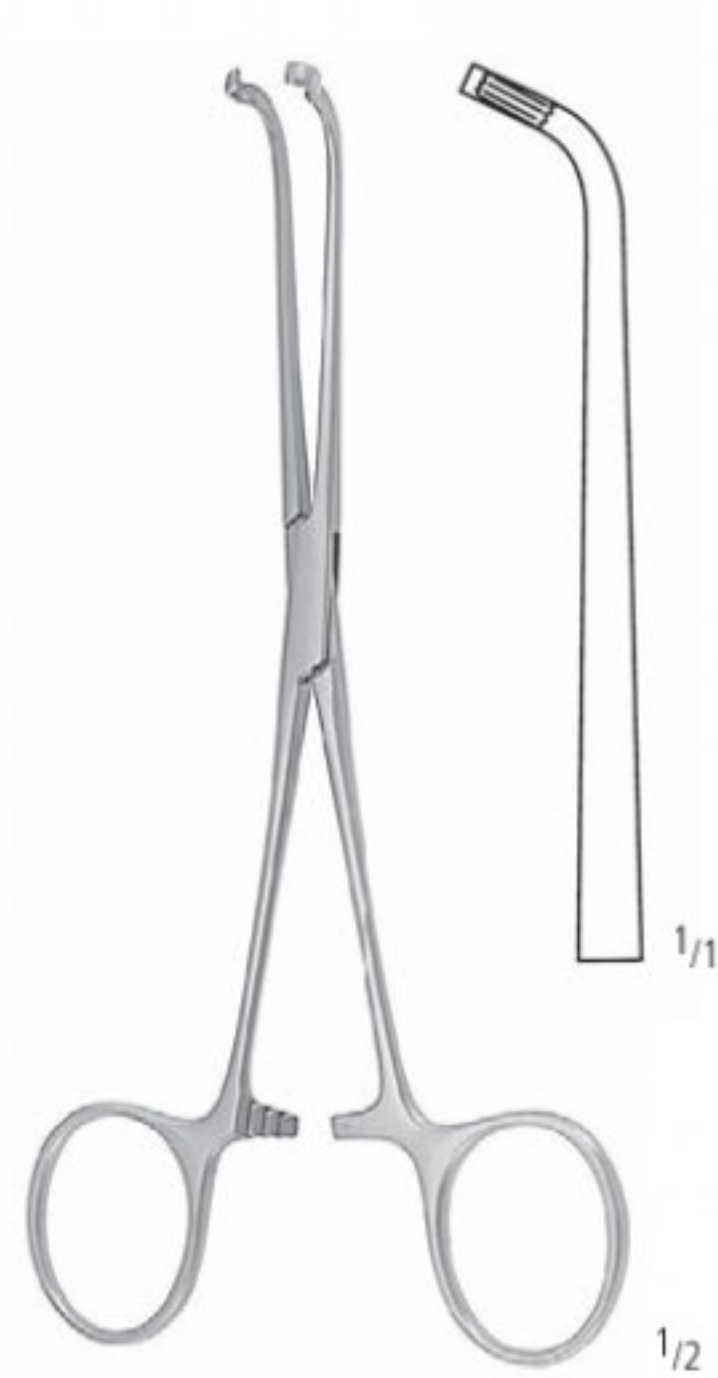

JAVID
 KK 561/18
 18,0 cm/7"

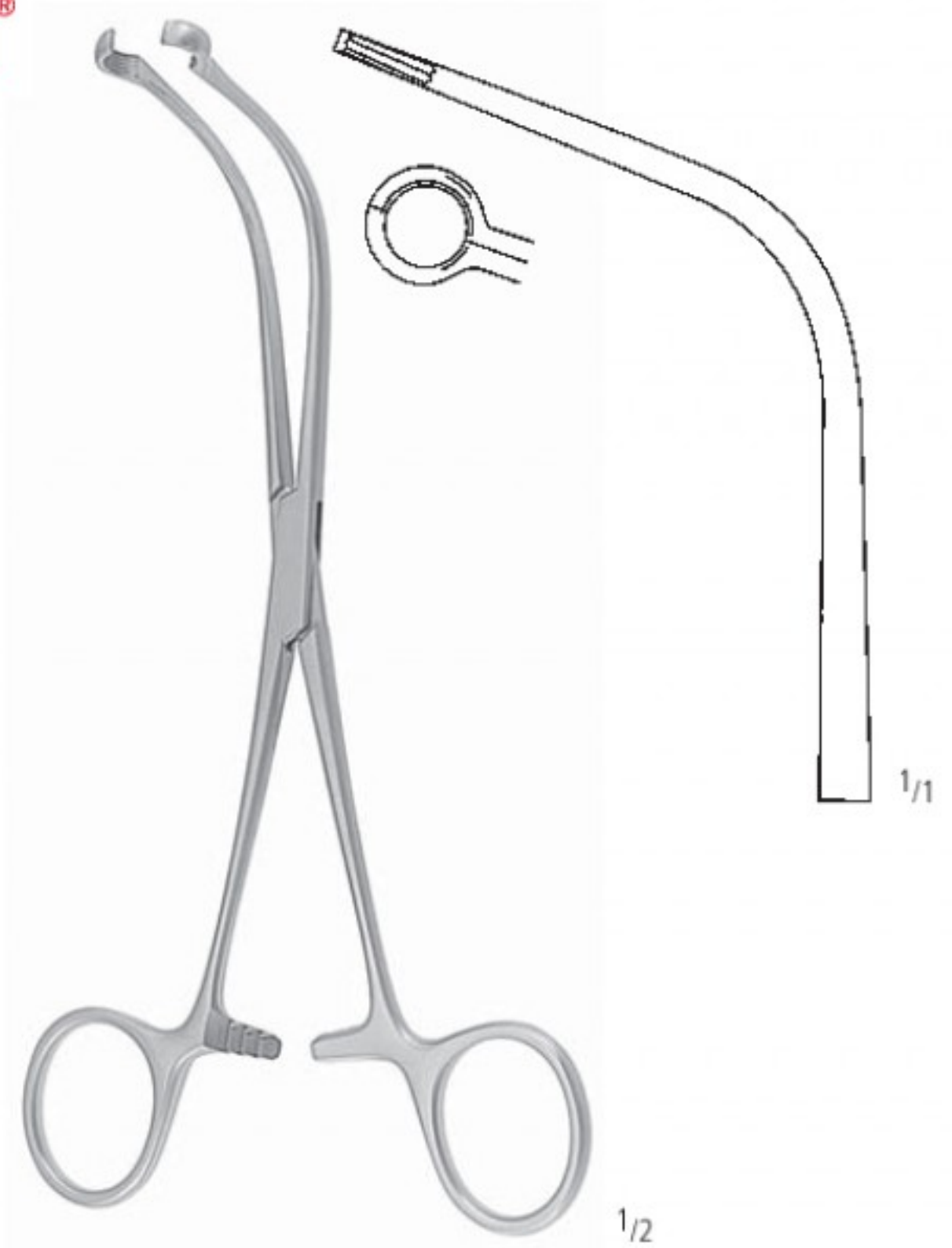

JAVID
 KK 561/19
 19,0 cm/7 1/2"

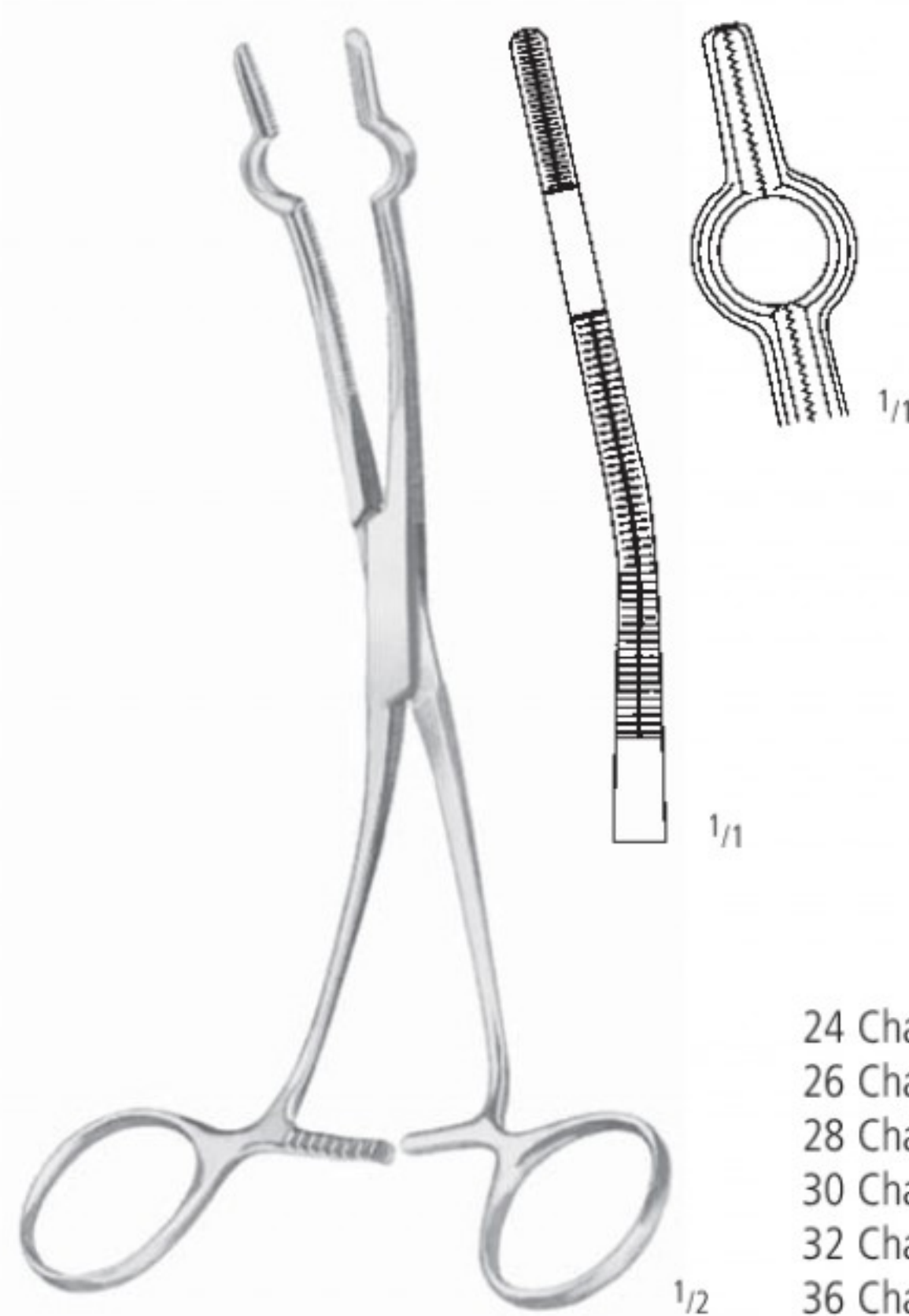

COOLEY

24 Charr.	16,0 cm/6 1/4"	KK 565/24
26 Charr.	16,0 cm/6 1/4"	KK 565/26
28 Charr.	20,0 cm/8"	KK 565/28
30 Charr.	20,0 cm/8"	KK 565/30
32 Charr.	20,0 cm/8"	KK 565/32
36 Charr.	20,0 cm/8"	KK 565/36

AA
 AB
 AC
 AD
 AE
 AF
 AG
 AH
 AI
 AJ
 AK
 AL
 AM
 AN
 AO
 AP
 AQ
 AR
 AS
 AT
 AU
 AV
 AW
 AX
 AY
 AZ
 BA
 BB
 BC
 BD
 BE
 BF
 BG
 BH
 BI
 BJ
 BK
 BL
 BM
 BN
 BO
 BP
 BQ
 BR
 BS
 BT
 BU
 BV
 BW
 BX
 BY
 BZ
 CA
 CB
 CC
 CD
 CE
 CF
 CG
 CH
 CI
 CJ
 CK
 CL
 CM
 CN
 CO
 CP
 CQ
 CR
 CS
 CT
 CU
 CV
 CW
 CX
 CY
 CZ
 DA
 DB
 DC
 DD
 DE
 DF
 DG
 DH
 DI
 DJ
 DK
 DL
 DM
 DN
 DO
 DP
 DQ
 DR
 DS
 DT
 DU
 DV
 DW
 DX
 DY
 DZ
 EA
 EB
 EC
 ED
 EE
 EF
 EG
 EH
 EI
 EJ
 EK
 EL
 EM
 EN
 EO
 EP
 EQ
 ER
 ES
 ET
 EU
 EV
 EW
 EX
 EY
 EZ
 FA
 FB
 FC
 FD
 FE
 FF
 FG
 FH
 FI
 FJ
 FK
 FL
 FM
 FN
 FO
 FP
 FQ
 FR
 FS
 FT
 FU
 FV
 FW
 FX
 FY
 FZ
 GA
 GB
 GC
 GD
 GE
 GF
 GG
 GH
 GI
 GJ
 GK
 GL
 GM
 GN
 GO
 GP
 GQ
 GR
 GS
 GT
 GU
 GV
 GW
 GX
 GY
 GZ
 HA
 HB
 HC
 HD
 HE
 HF
 HG
 HH
 HI
 HJ
 HK
 HL
 HM
 HN
 HO
 HP
 HQ
 HR
 HS
 HT
 HU
 HV
 HW
 HX
 HY
 HZ
 IA
 IB
 IC
 ID
 IE
 IF
 IG
 IH
 II
 IJ
 IK
 IL
 IM
 IN
 IO
 IP
 IQ
 IR
 IS
 IT
 IU
 IV
 IW
 IX
 IY
 IZ
 JA
 JB
 JC
 JD
 JE
 JF
 JG
 JH
 JI
 JJ
 JK
 JL
 JM
 JN
 JO
 JP
 JQ
 JR
 JS
 JT
 JU
 JV
 JW
 JX
 JY
 JZ
 KA
 KB
 KC
 KD
 KE
 KF
 KG
 KH
 KI
 KJ
 KK
 KL
 KM
 KN
 KO
 KP
 KQ
 KR
 KS
 KT
 KU
 KV
 KW
 KX
 KY
 KZ
 LA
 LB
 LC
 LD
 LE
 LF
 LG
 LH
 LI
 LJ
 LK
 LL
 LM
 LN
 LO
 LP
 LQ
 LR
 LS
 LT
 LU
 LV
 LW
 LX
 LY
 LZ
 MA
 MB
 MC
 MD
 ME
 MF
 MG
 MH
 MI
 MJ
 MK
 ML
 MM
 MN
 MO
 MP
 MQ
 MR
 MS
 MT
 MU
 MV
 MW
 MX
 MY
 MZ
 NA
 NB
 NC
 ND
 NE
 NF
 NG
 NH
 NI
 NJ
 NK
 NL
 NM
 NN
 NO
 NP
 NQ
 NR
 NS
 NT
 NU
 NV
 NW
 NX
 NY
 NZ
 OA
 OB
 OC
 OD
 OE
 OF
 OG
 OH
 OI
 OJ
 OK
 OL
 OM
 ON
 OO
 OP
 OQ
 OR
 OS
 OT
 OU
 OV
 OW
 OX
 OY
 OZ
 PA
 PB
 PC
 PD
 PE
 PF
 PG
 PH
 PI
 PJ
 PK
 PL
 PM
 PN
 PO
 PP
 PQ
 PR
 PS
 PT
 PU
 PV
 PW
 PX
 PY
 PZ
 QA
 QB
 QC
 QD
 QE
 QF
 QG
 QH
 QI
 QJ
 QK
 QL
 QM
 QN
 QO
 QP
 QQ
 QR
 QS
 QT
 QU
 QV
 QW
 QX
 QY
 QZ
 RA
 RB
 RC
 RD
 RE
 RF
 RG
 RH
 RI
 RJ
 RK
 RL
 RM
 RN
 RO
 RP
 RQ
 RR
 RS
 RT
 RU
 RV
 RW
 RX
 RY
 RZ
 SA
 SB
 SC
 SD
 SE
 SF
 SG
 SH
 SI
 SJ
 SK
 SL
 SM
 SN
 SO
 SP
 SQ
 SR
 SS
 ST
 SU
 SV
 SW
 SX
 SY
 SZ
 TA
 TB
 TC
 TD
 TE
 TF
 TG
 TH
 TI
 TJ
 TK
 TL
 TM
 TN
 TO
 TP
 TQ
 TR
 TS
 TU
 TV
 TW
 TX
 TY
 TZ
 UA
 UB
 UC
 UD
 UE
 UF
 UG
 UH
 UI
 UJ
 UK
 UL
 UM
 UN
 UO
 UP
 UQ
 UR
 US
 UT
 UY
 UZ
 VA
 VB
 VC
 VD
 VE
 VF
 VG
 VH
 VI
 VJ
 VK
 VL
 VM
 VN
 VO
 VP
 VQ
 VR
 VS
 VT
 VY
 VZ
 WA
 WB
 WC
 WD
 WE
 WF
 WG
 WH
 WI
 WJ
 WK
 WL
 WM
 WN
 WO
 WP
 WQ
 WR
 WS
 WT
 WY
 WZ
 XA
 XB
 XC
 XD
 XE
 XF
 XG
 XH
 XI
 XJ
 XK
 XL
 XM
 XN
 XO
 XP
 XQ
 XR
 XS
 XT
 XY
 XZ
 YA
 YB
 YC
 YD
 YE
 YF
 YG
 YH
 YI
 YJ
 YK
 YL
 YM
 YN
 YO
 YP
 YQ
 YR
 YS
 YT
 YZ
 ZA
 ZB
 ZC
 ZD
 ZE
 ZF
 ZG
 ZH
 ZI
 ZJ
 ZK
 ZL
 ZM
 ZN
 ZO
 ZP
 ZQ
 ZR
 ZS
 ZT
 ZY
 ZZ

KK

X

Atrauma-Klemmen
 Atrauma Forceps
 Pinzas Atrauma
 Pincès atraumatiques
 Pinze Atrauma



COOLEY

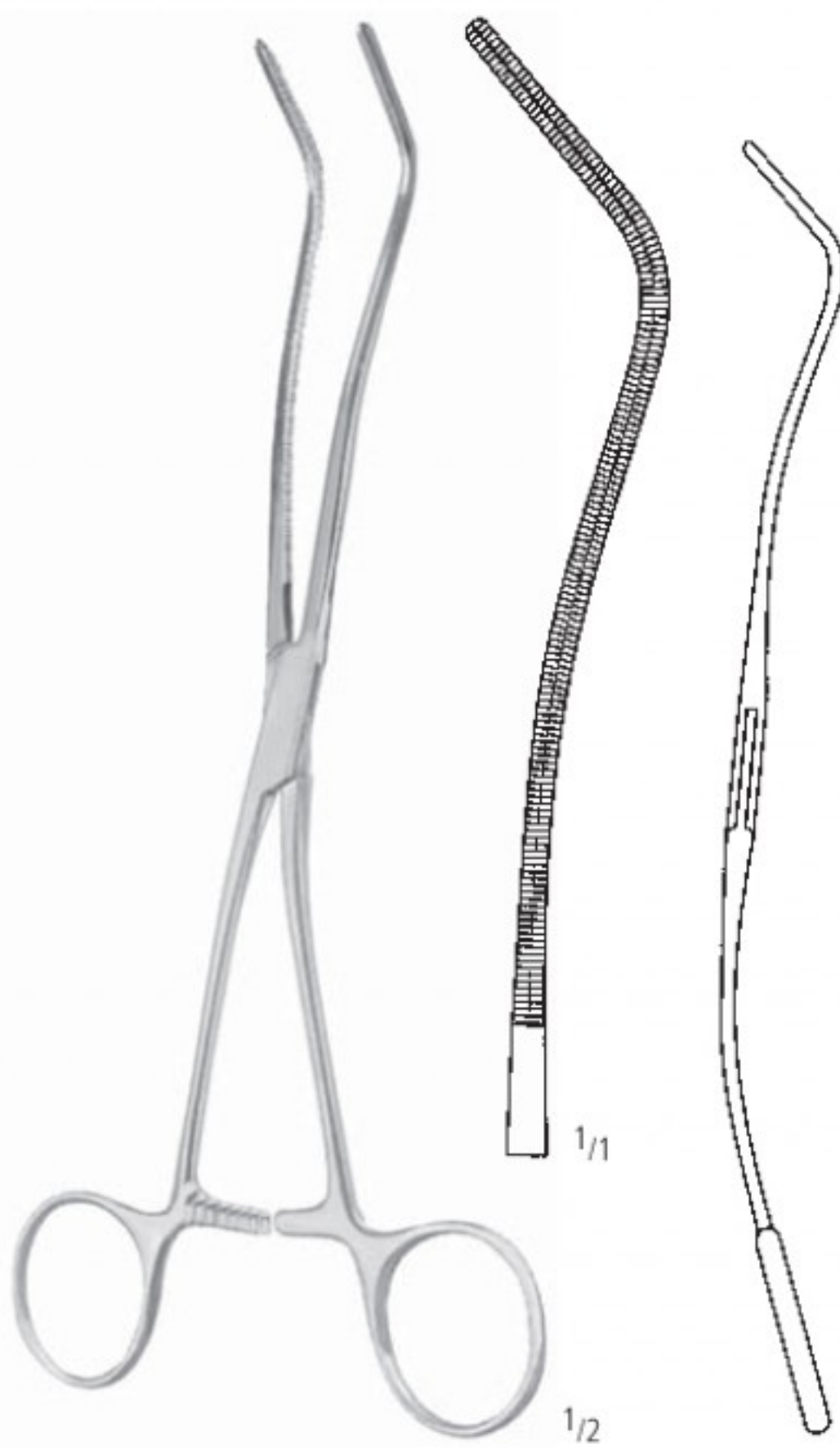

COOLEY
 KK 571/20
 20,0 cm/8"

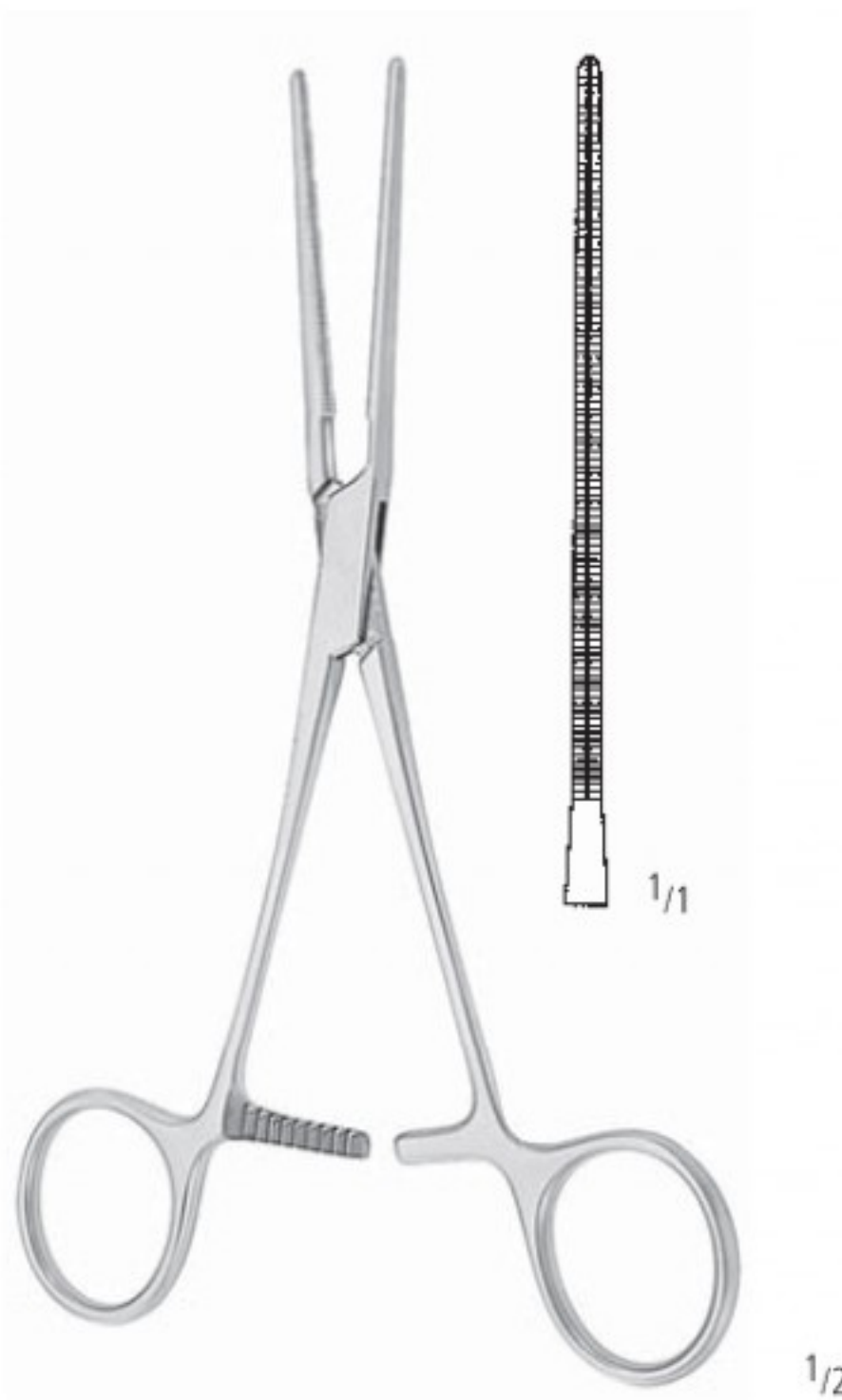

COOLEY
 KK 574/17
 17,0 cm/6³/₄"

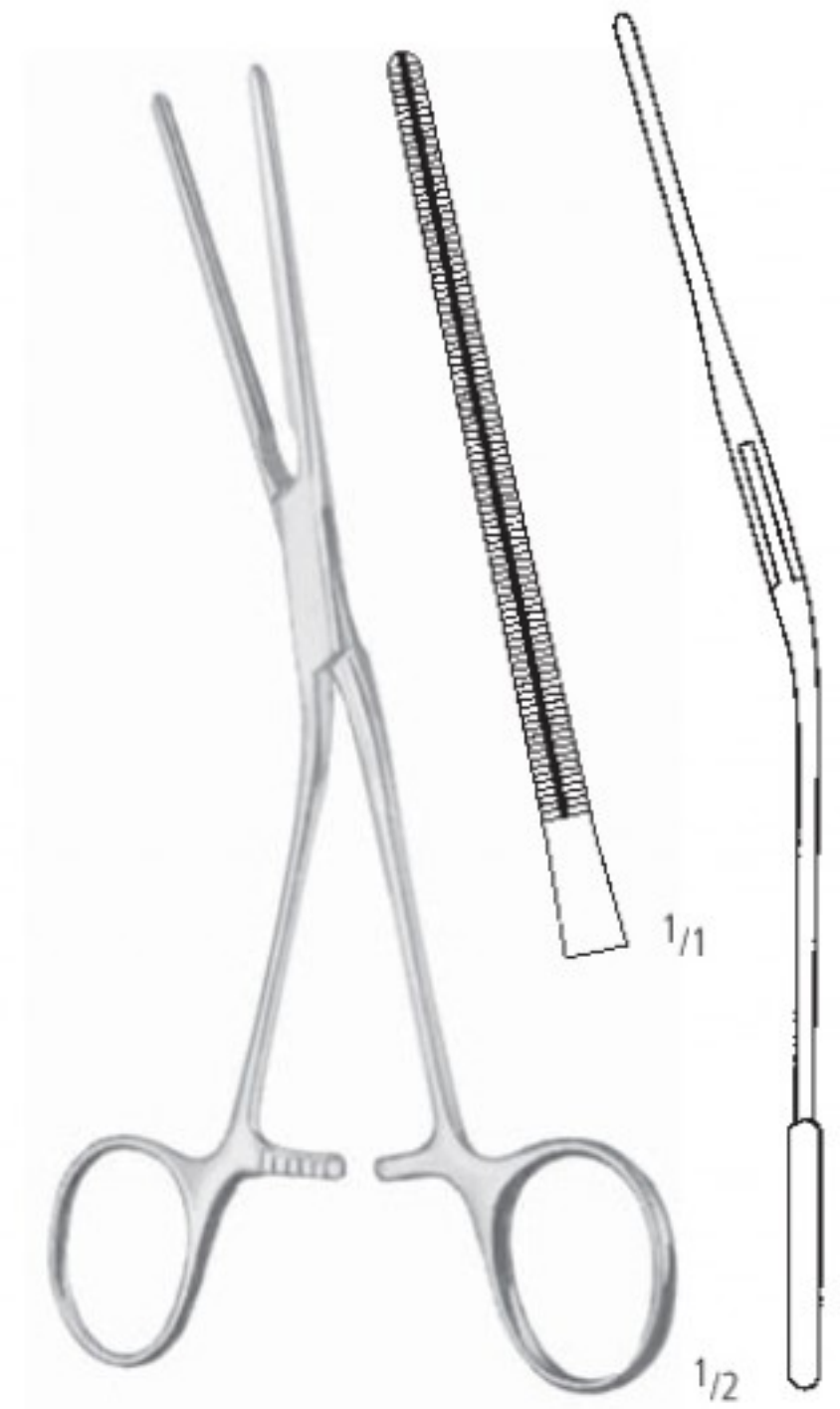

COOLEY
 KK 575/17
 17,0 cm/6³/₄"

graduirt - graduated

Atrauma-Klemmen
 Atrauma Forceps
 Pinzas Atrauma
 Pincès atraumatiques
 Pinze Atrauma



COOLEY

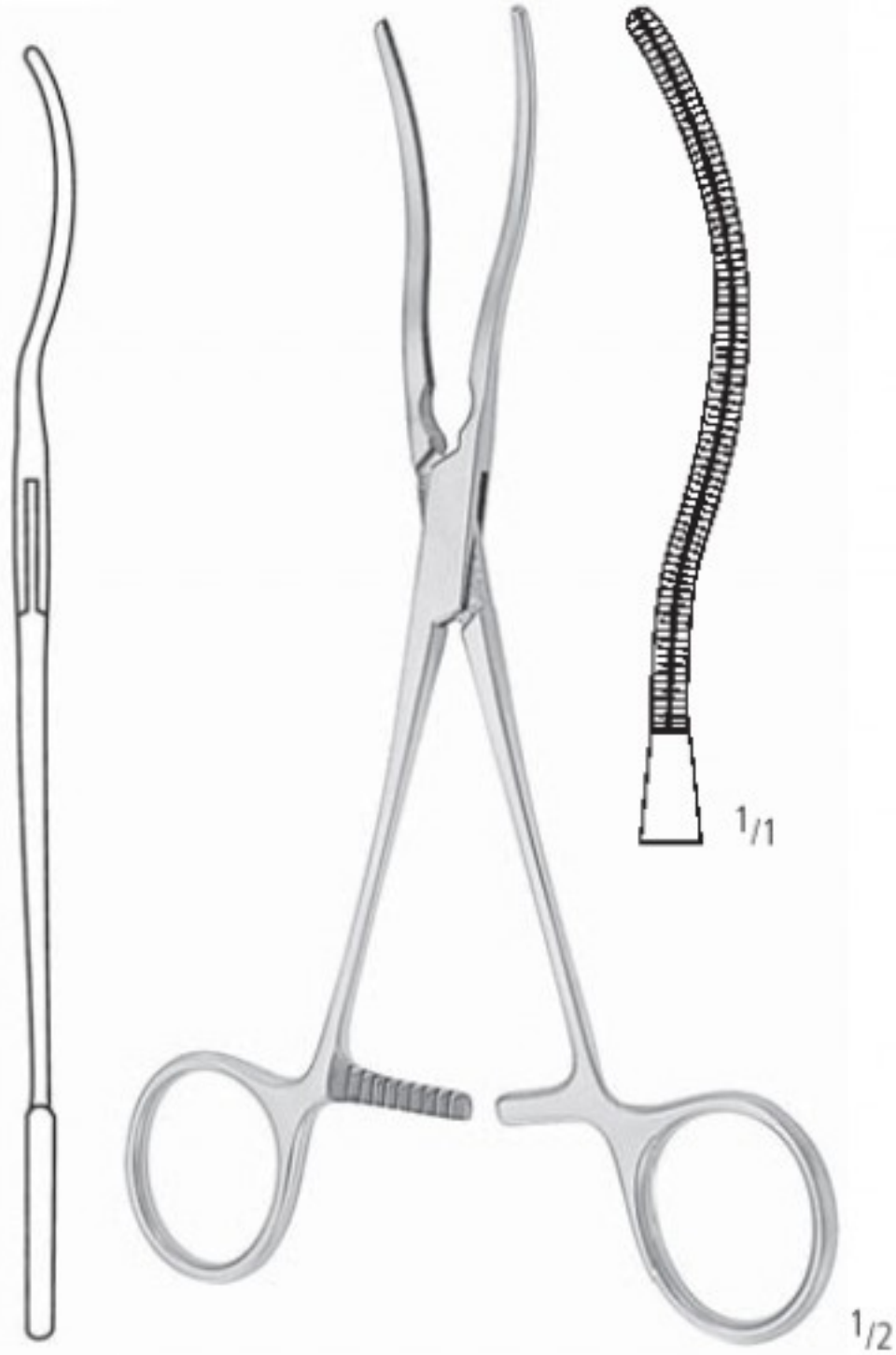

COOLEY
 KK 577/17
 17,0 cm/6³/₄"

graduirt - graduated

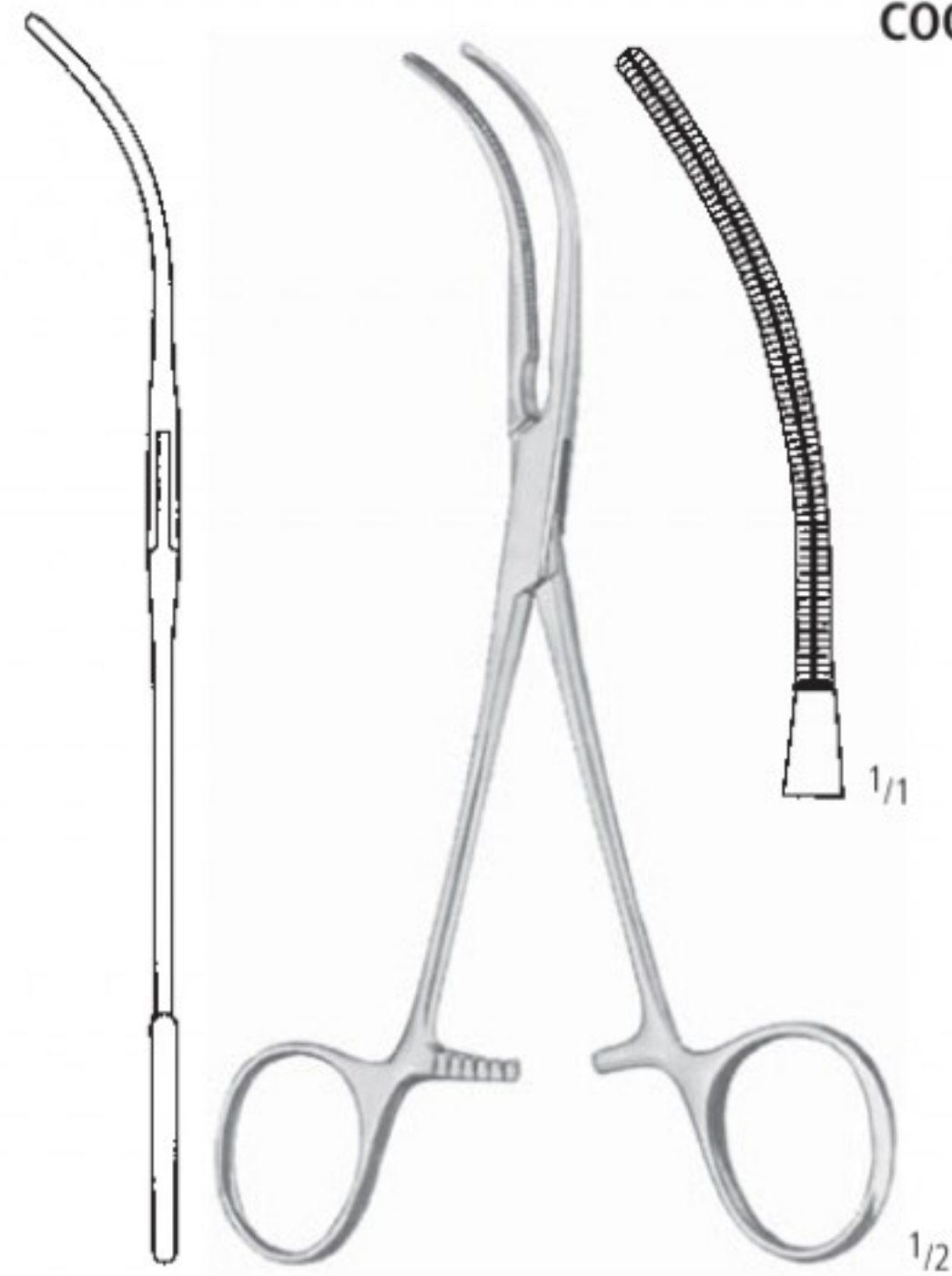

COOLEY
 KK 579/17
 17,0 cm/6³/₄"

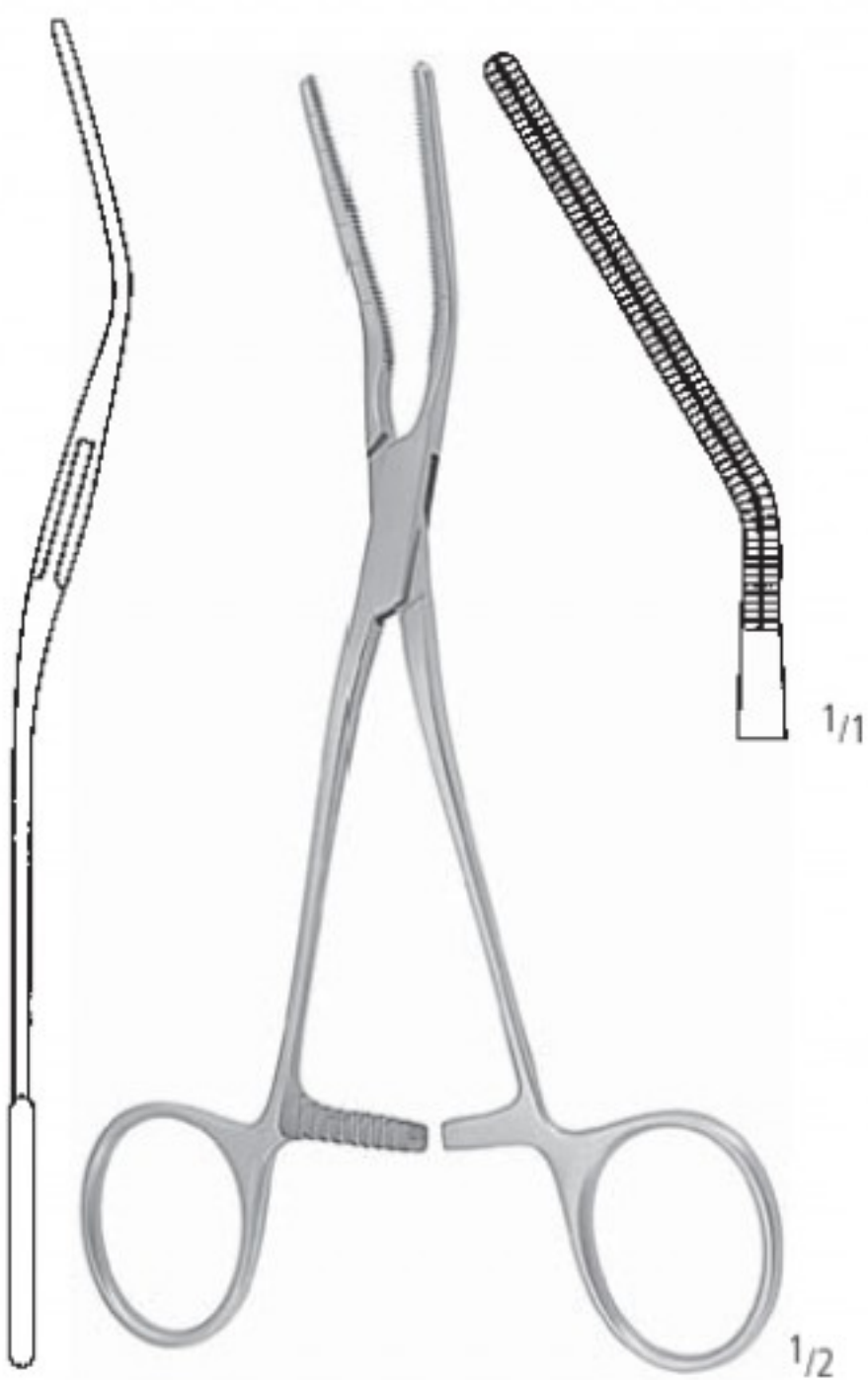

COOLEY
 KK 581/17
 17,0 cm/6³/₄"

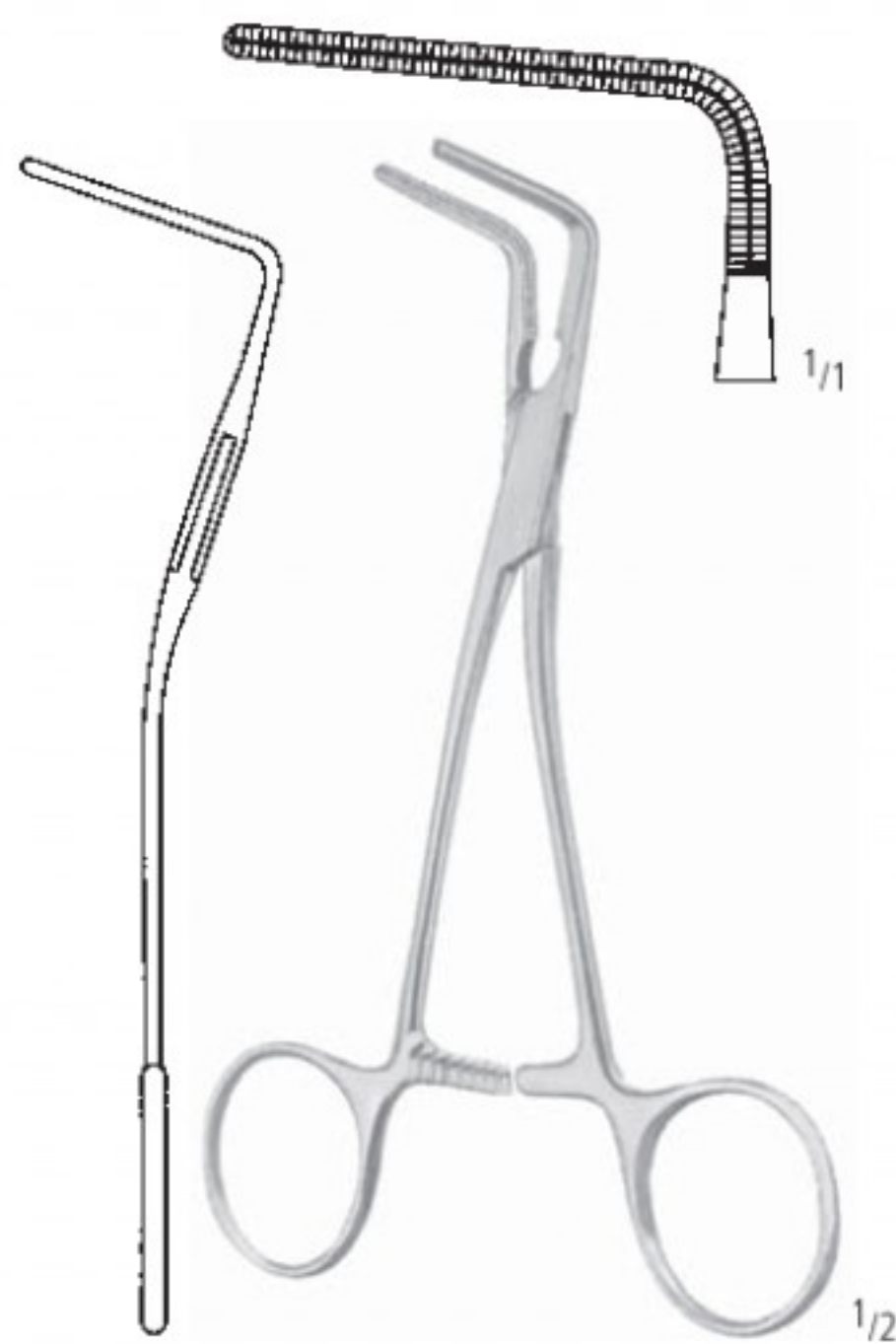

COOLEY
 KK 583/15
 15,0 cm/6"

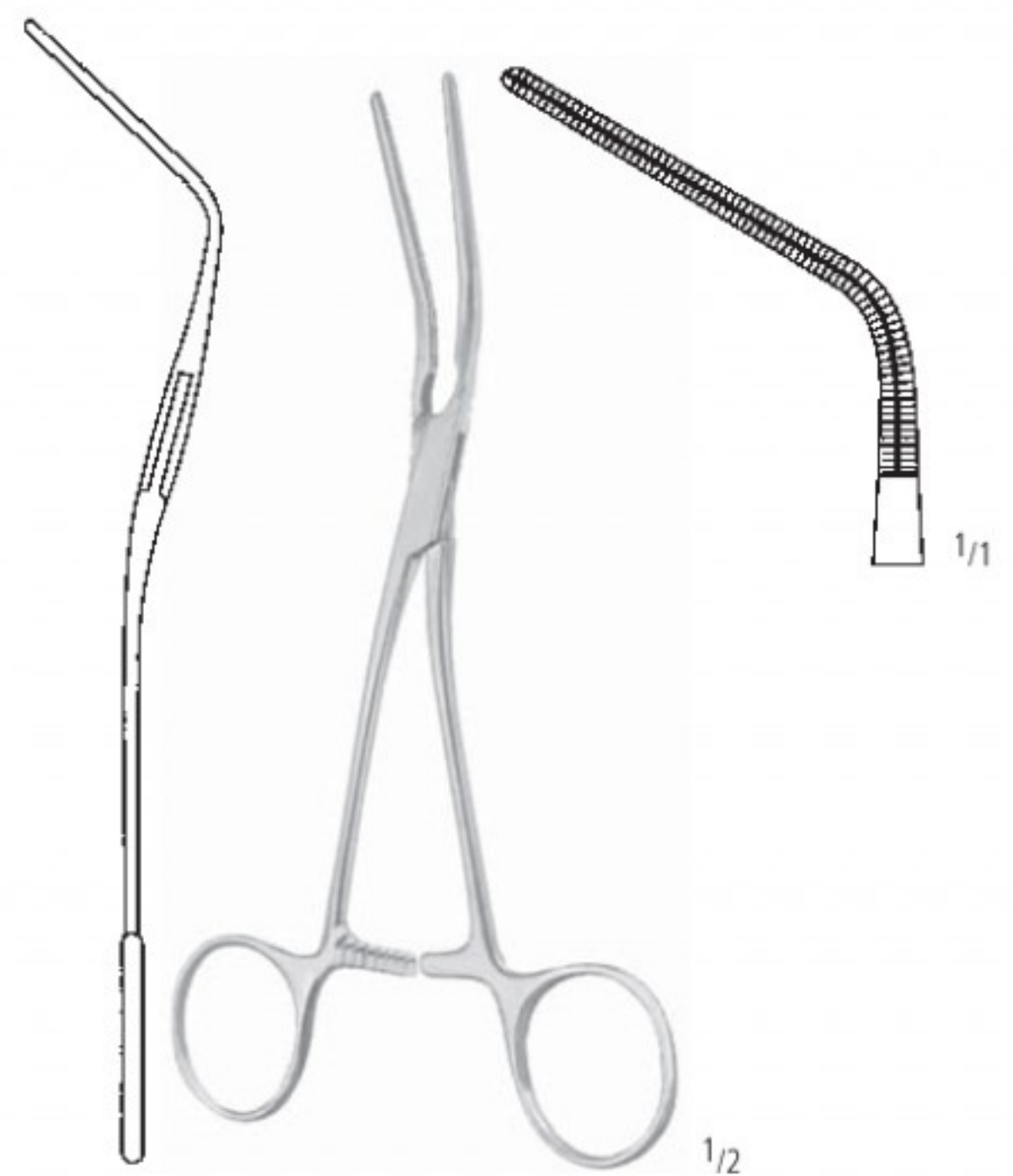

COOLEY
 KK 585/16
 15,5 cm/6¹/₈"

AA
 AB
 AC
 AD
 AE
 AF
 AK
 AL
 AO
 KA
 KK
 X

Atrauma-Klemmen
 Atrauma Forceps
 Pinzas Atrauma
 Pincès atraumatiques
 Pinze Atrauma



COOLEY

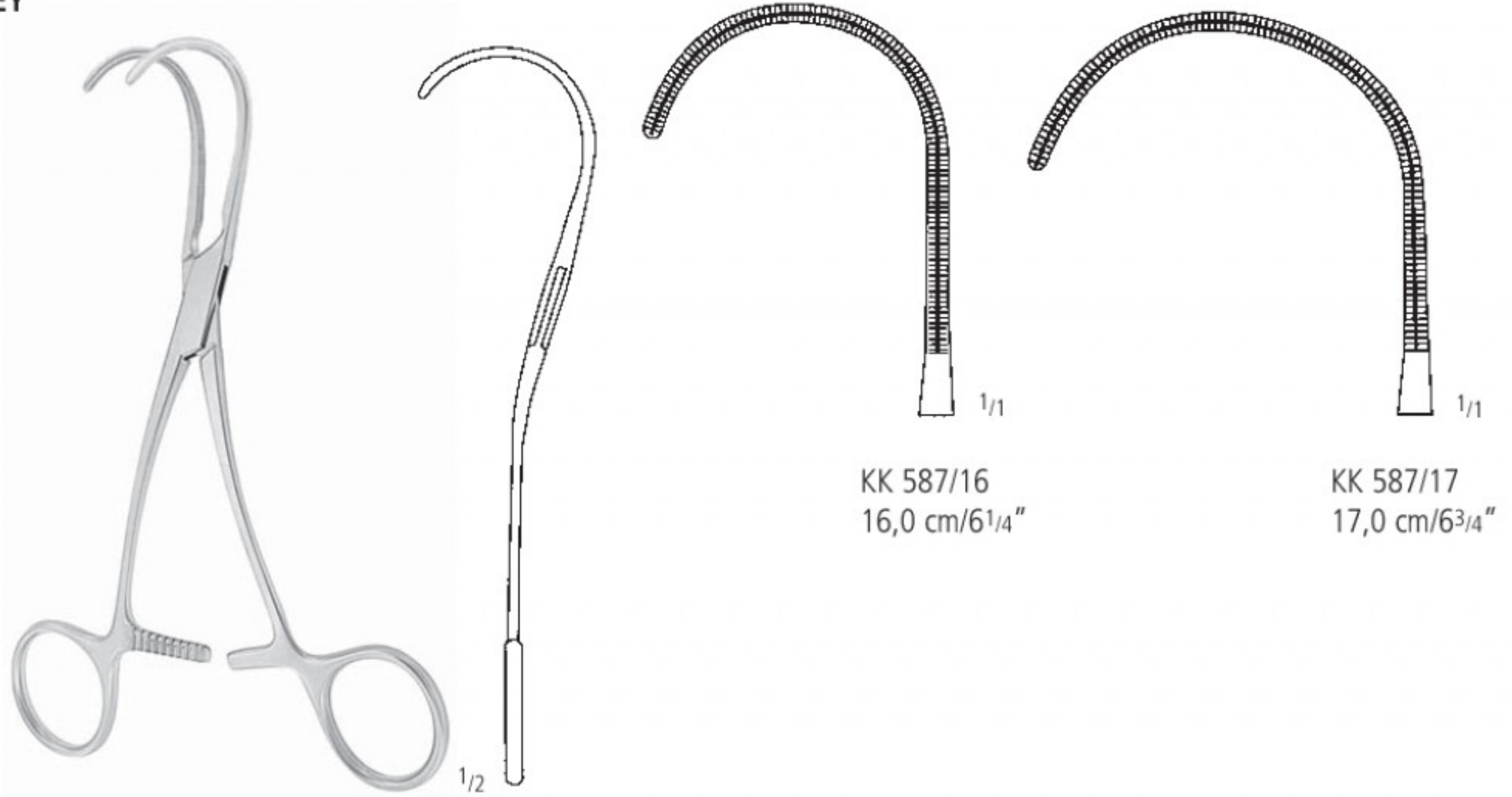

KK 587/16
 16,0 cm/6¹/₄"

KK 587/17
 17,0 cm/6³/₄"

COOLEY

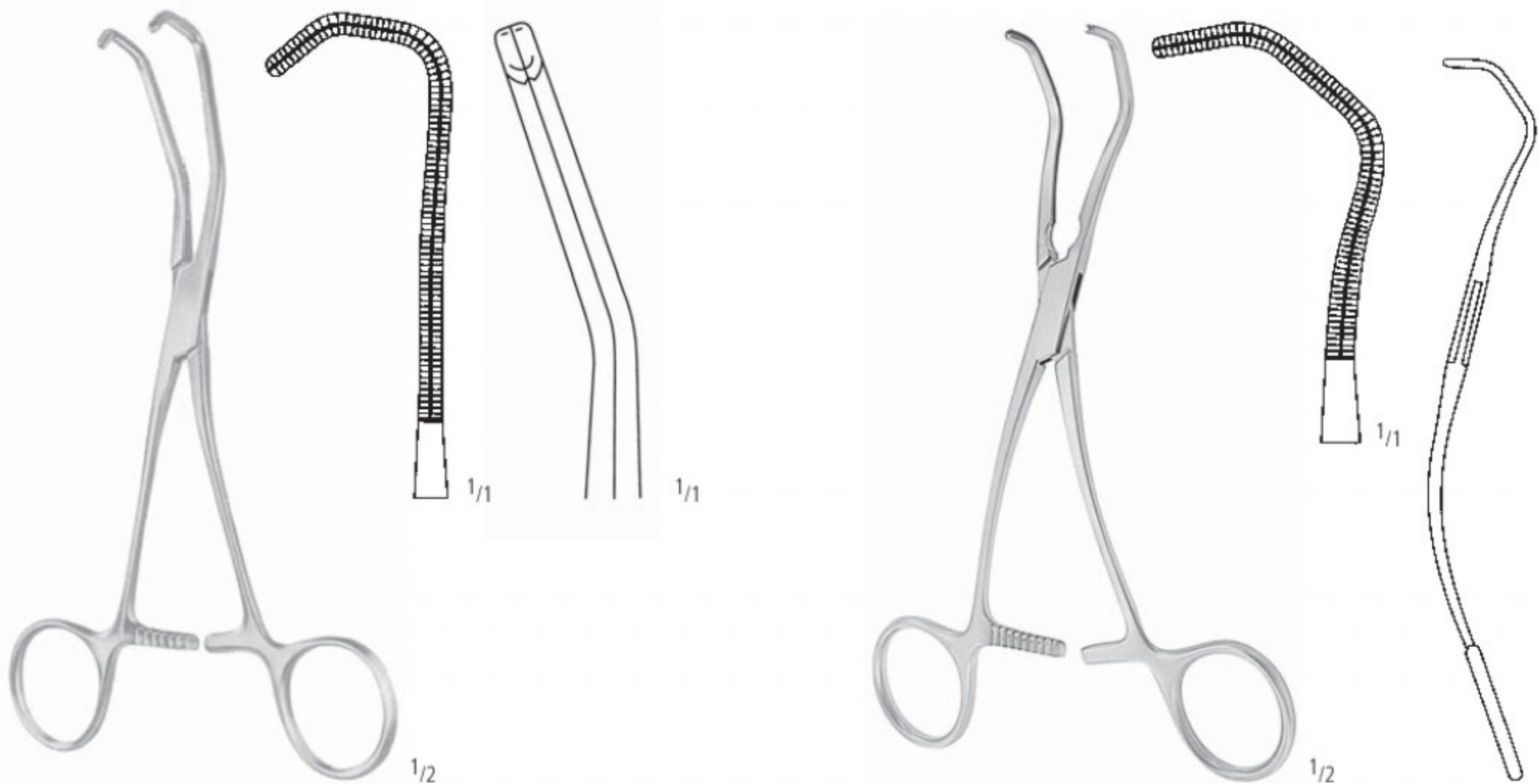

COOLEY
 KK 589/17
 17,0 cm/6³/₄"

graduiert - graduated

COOLEY
 KK 591/16
 16,0 cm/6¹/₄"

Atrauma-Klemmen
 Atrauma Forceps
 Pinzas Atrauma
 Pincas atraumatiques
 Pinze Atrauma



COOLEY



COOLEY-DERRA

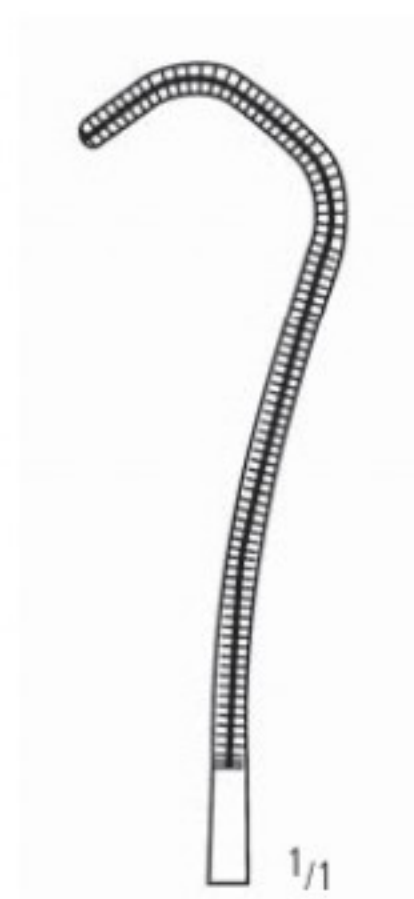

KK 593/16
 16,0 cm/6¹/₄"



KK 593/17
 17,0 cm/6³/₄"

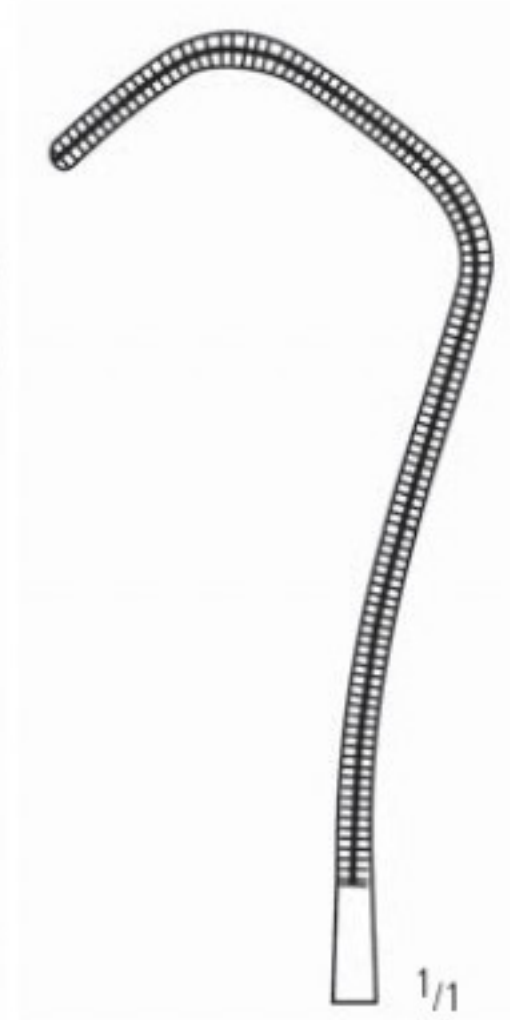

KK 593/18
 18,0 cm/7"

graduirt - graduated



BECK
 KK 595/17
 17,0 cm/6³/₄"

AA
 AB
 AC
 AD
 AE
 AF
 AK
 AL
 AO
 KA
 KK
 X

KK

Atrauma-Klemmen
 Atrauma Forceps
 Pinzas Atrauma
 Pincès atraumatiques
 Pinze Atrauma



DARDIK

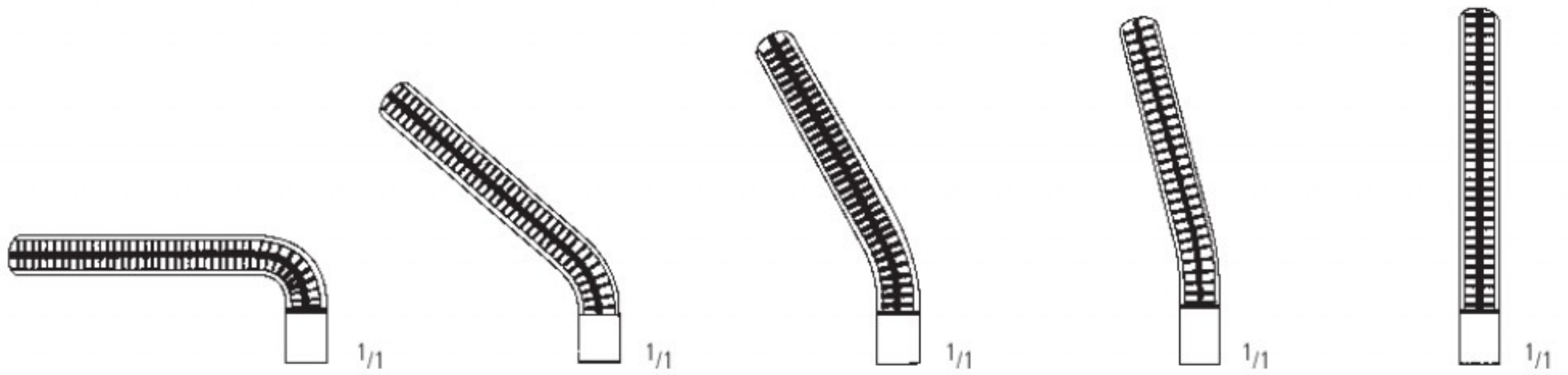

KK 597/01
 13,0 cm/5¹/₄"

KK 597/02
 14,5 cm/5³/₄"

KK 597/03
 15,0 cm/6"

KK 597/04
 15,0 cm/6"

KK 597/05
 15,0 cm/6"



DARDIK

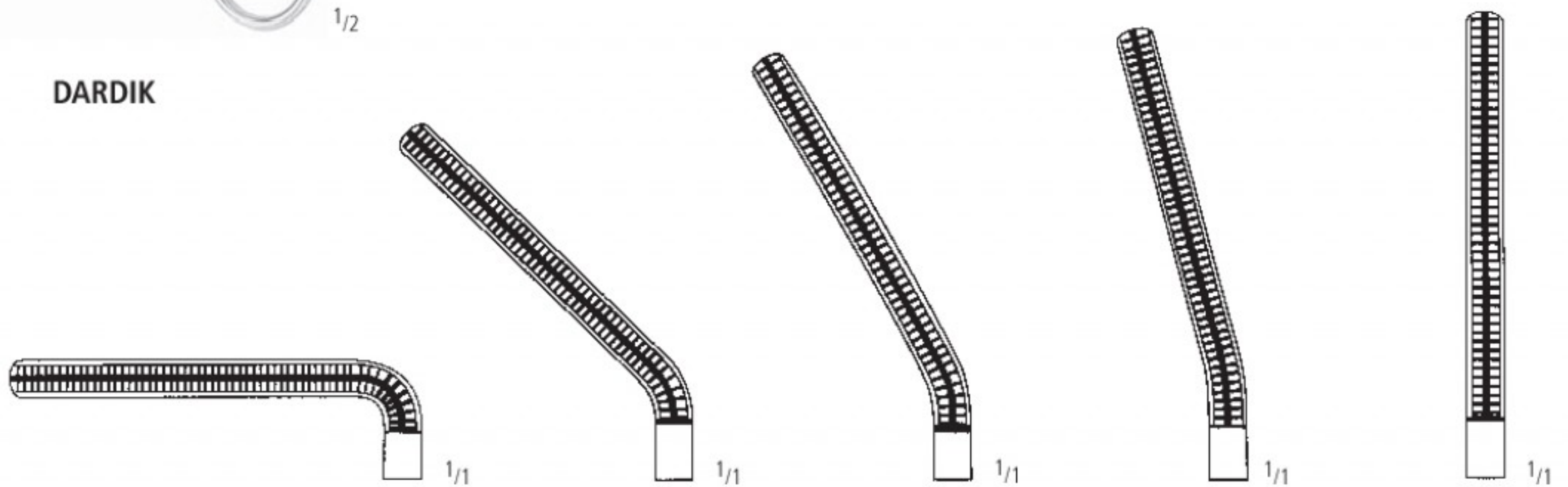

KK 599/01
 13,5 cm/5¹/₂"

KK 599/02
 16,0 cm/6¹/₄"

KK 599/03
 17,0 cm/6³/₄"

KK 599/04
 17,0 cm/6³/₄"

KK 599/05
 17,0 cm/6³/₄"

Atrauma-Klemmen
 Atrauma Forceps
 Pinzas Atrauma
 Pincas atraumatiques
 Pinze Atrauma

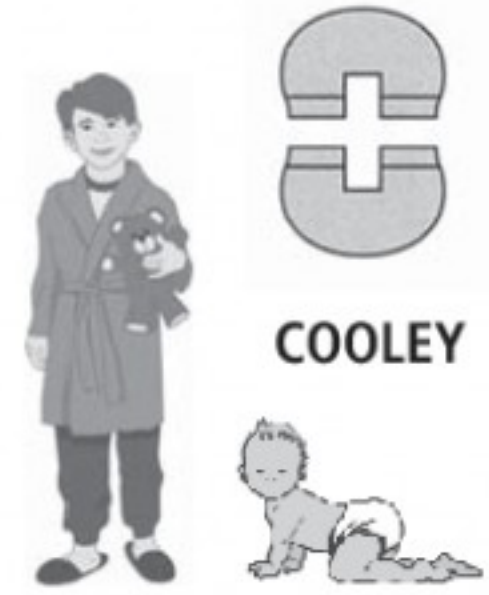

COOLEY

graduirt - graduated



COOLEY
 KK 603/14
 14,0 cm/5 1/2"



COOLEY
 KK 605/14
 14,0 cm/5 1/2"

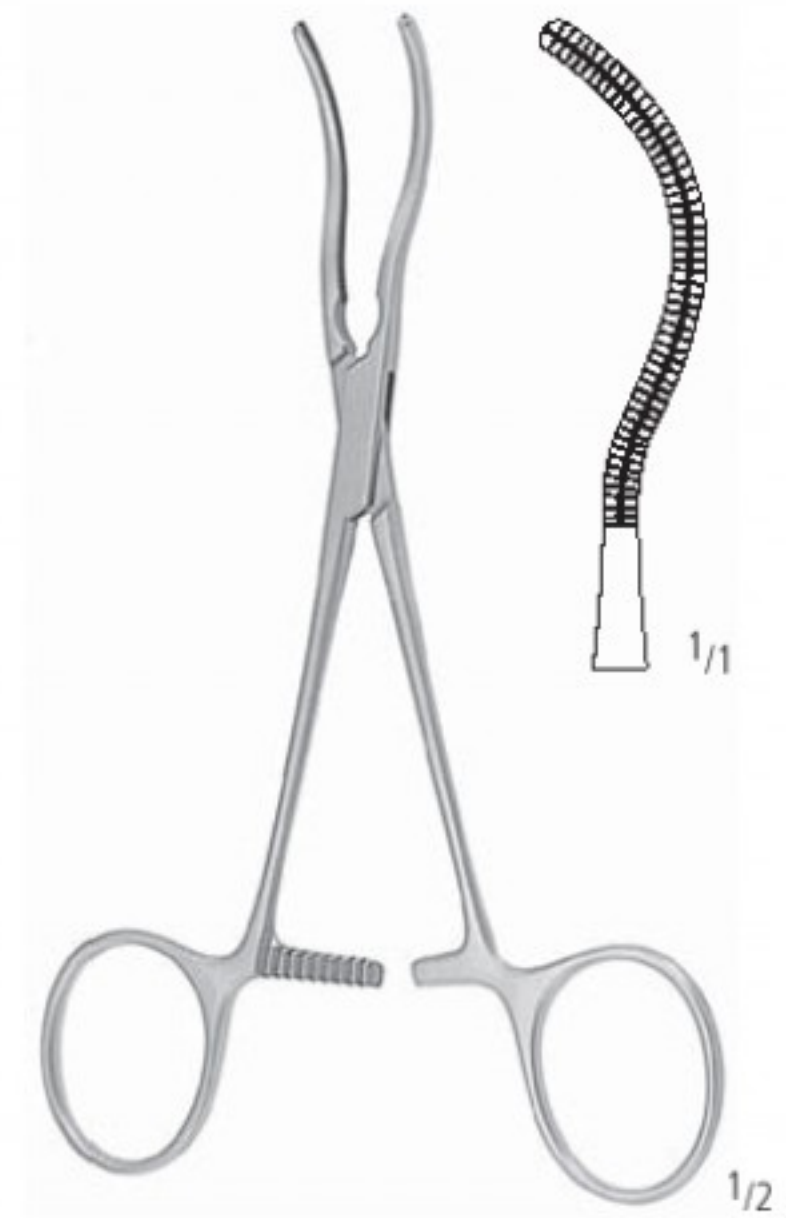

COOLEY
 KK 607/14
 14,0 cm/5 1/2"

AA
 AB
 AC
 AD
 AE
 AF
 AG
 AH
 AI
 AJ
 AK
 AL
 AM
 AN
 AO
 AP
 AQ
 AR
 AS
 AT
 AU
 AV
 AW
 AX
 AY
 AZ

KK

Atrauma-Klemmen
 Atrauma Forceps
 Pinzas Atrauma
 Pincès atraumatiques
 Pinze Atrauma



KK 611/01
 14,0 cm/5 1/2"



KK 611/02
 14,0 cm/5 1/2"



KK 611/03
 14,0 cm/5 1/2"



KK 611/04
 13,0 cm/5"



KK 611/05
 14,0 cm/5 1/2"

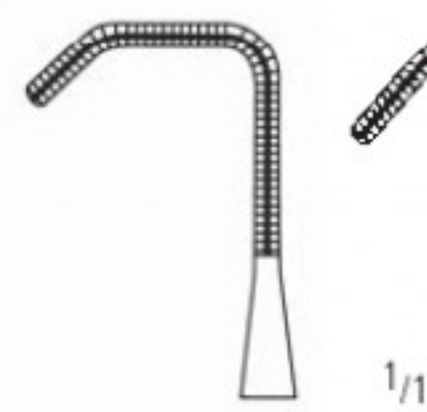
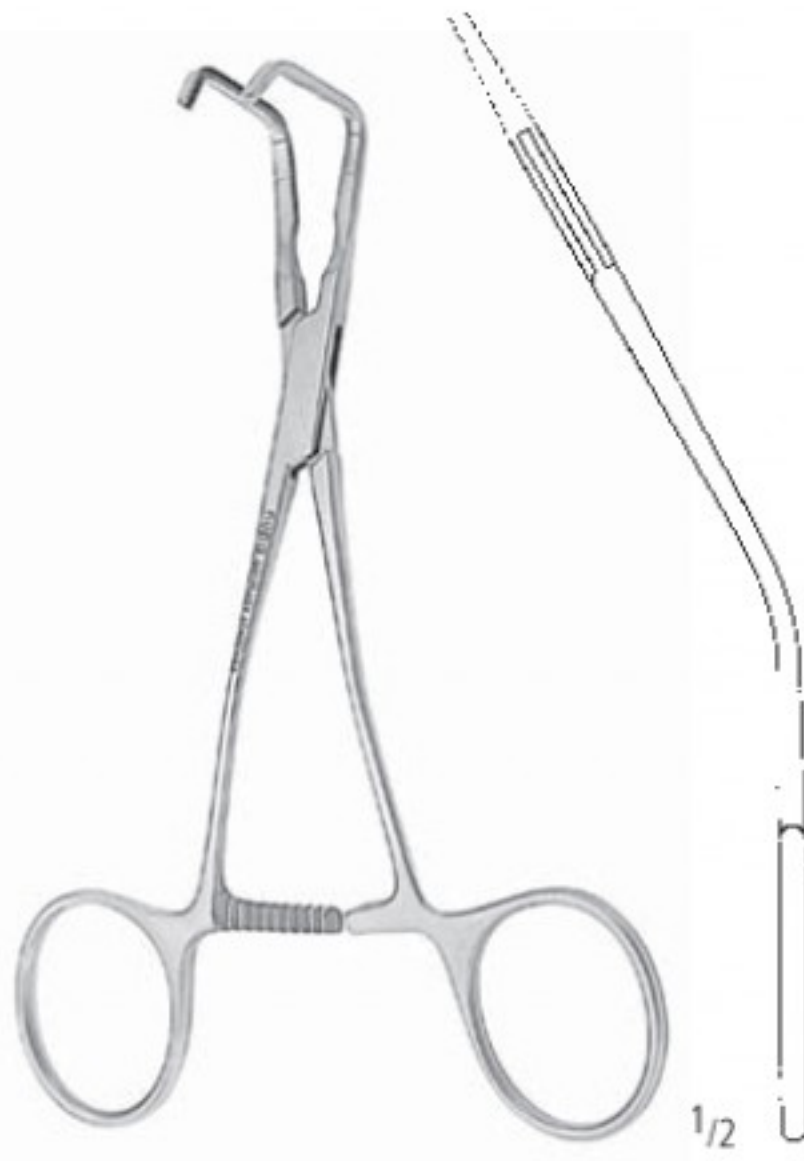

KK 611/06
 13,0 cm/5"

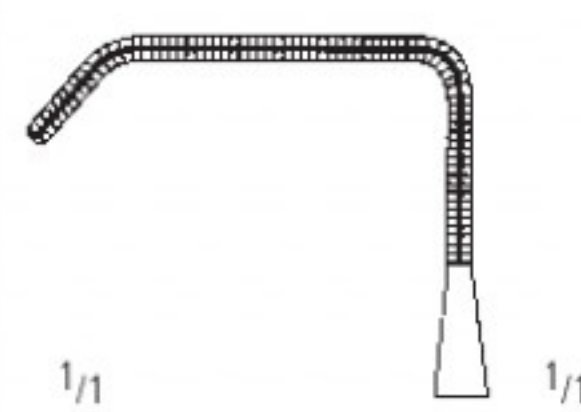

KK 611/07
 13,0 cm/5"



KK 611/08
 14,0 cm/5 1/2"



KK 611/09
 13,5 cm/5 1/4"

Atrauma-Klemmen
 Atrauma Forceps
 Pinzas Atrauma
 Pincas atraumatiques
 Pinze Atrauma

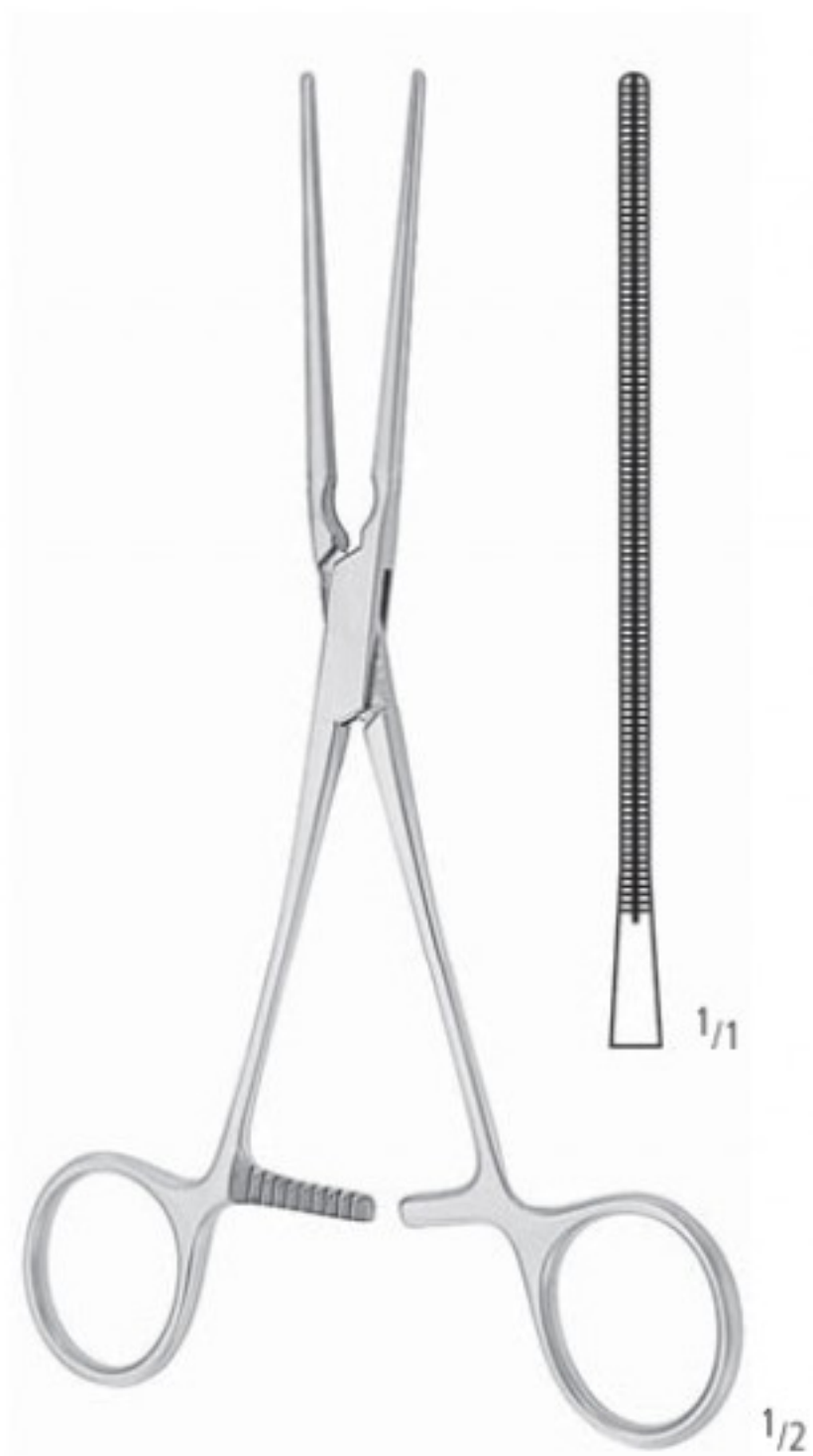

KK 620/16
 16,5 cm/6 1/2"



KK 621/16
 16,0 cm/6 1/4"

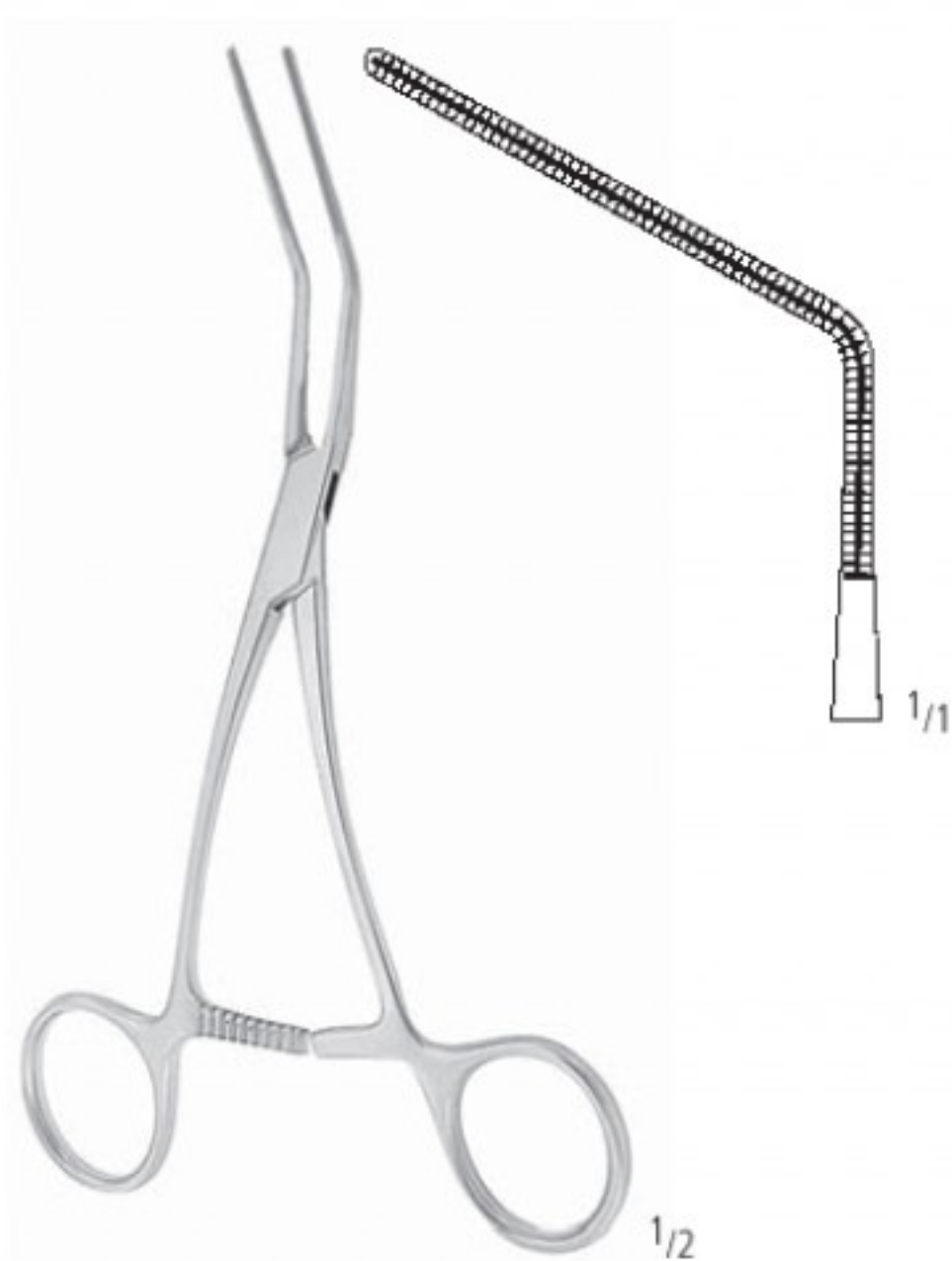

KK 623/15
 15,0 cm/6"

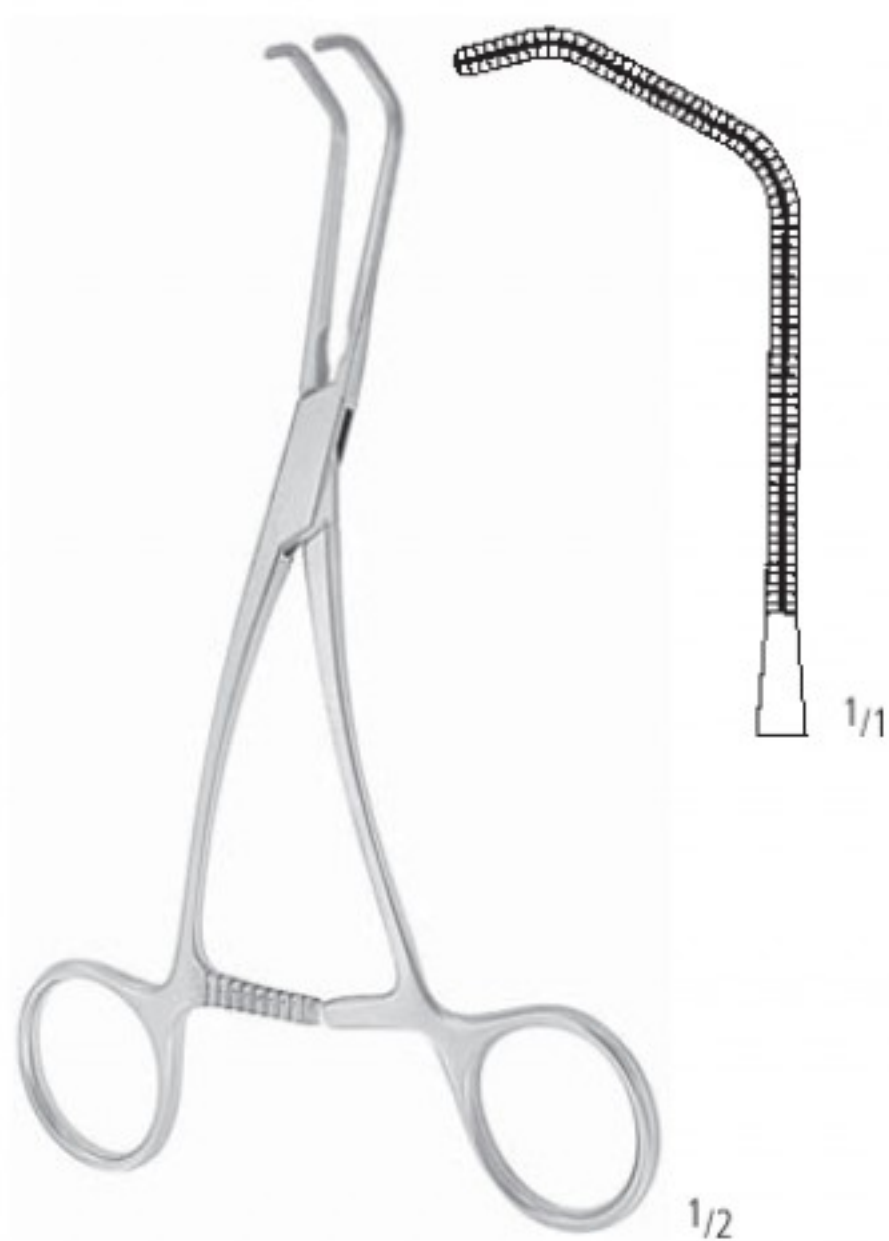

KK 625/15
 15,0 cm/6"

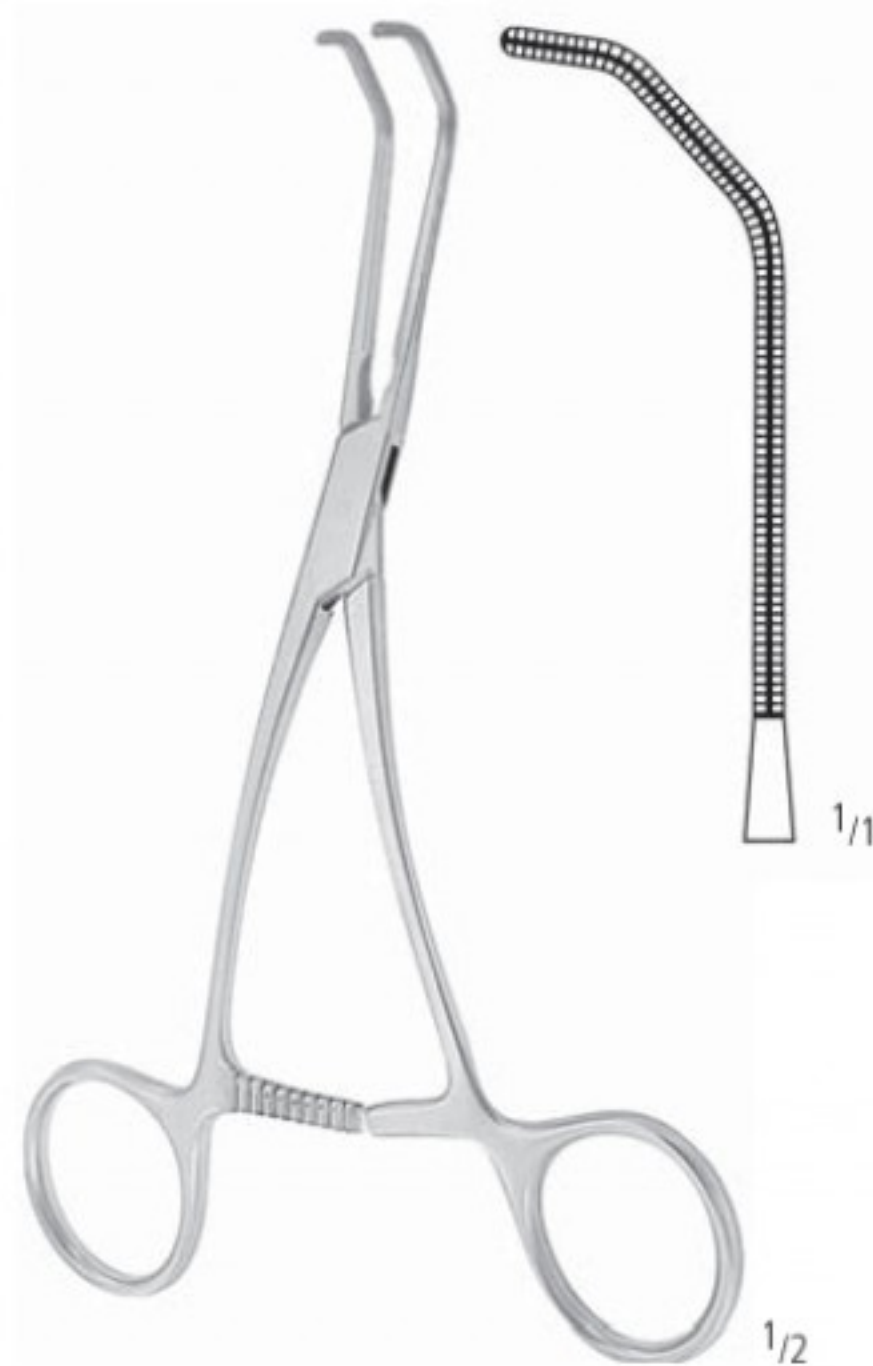

KK 627/15
 15,5 cm/6 1/8"

AA

AB

AC

AD

AE

AF

AK

AL

AO

KA

KK

X

Atrauma-Klemmen
 Atrauma Forceps
 Pinzas Atrauma
 Pincès atraumatiques
 Pinze Atrauma

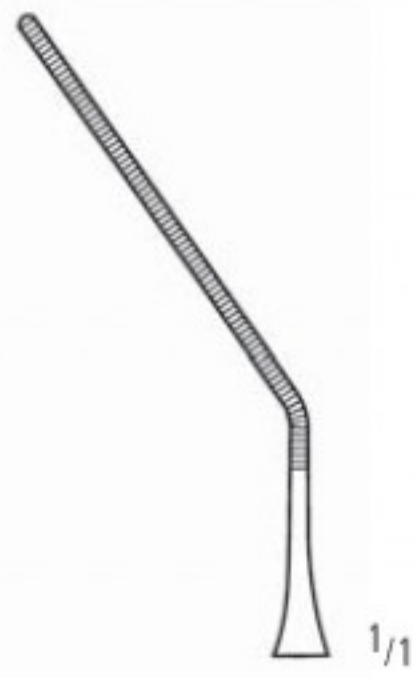

KK 635/01
 13,0 cm/5"

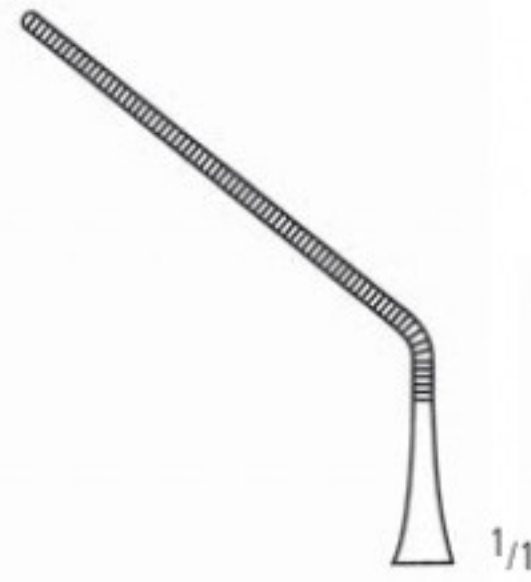

KK 635/02
 13,0 cm/5"



KK 635/03
 11,0 cm/4¹/₂"



CASTANEDA

1/2



KK 635/04
 12,0 cm/4³/₄"

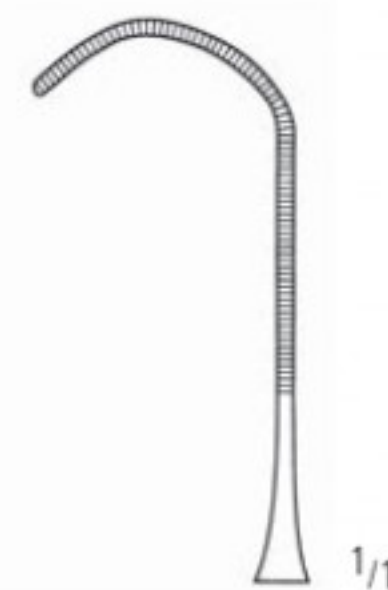

KK 635/05
 12,0 cm/4³/₄"

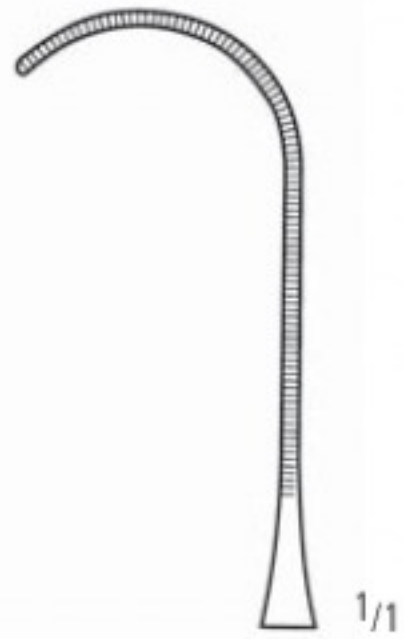

KK 635/06
 12,0 cm/4³/₄"

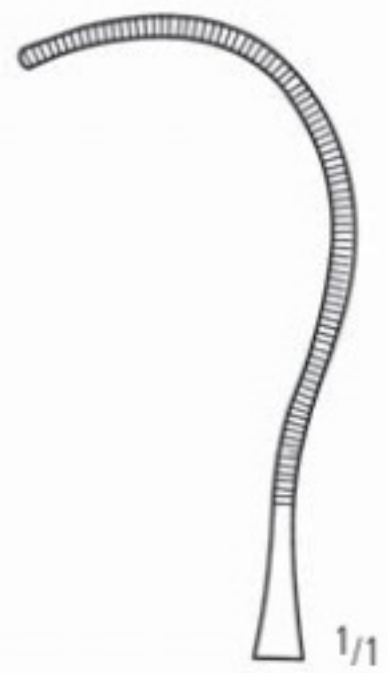

KK 635/07
 14,0 cm/4³/₄"

graduiert - graduated

Atrauma-Klemmen
 Atrauma Forceps
 Pinzas Atrauma
 Pincès atraumatiques
 Pinze Atrauma

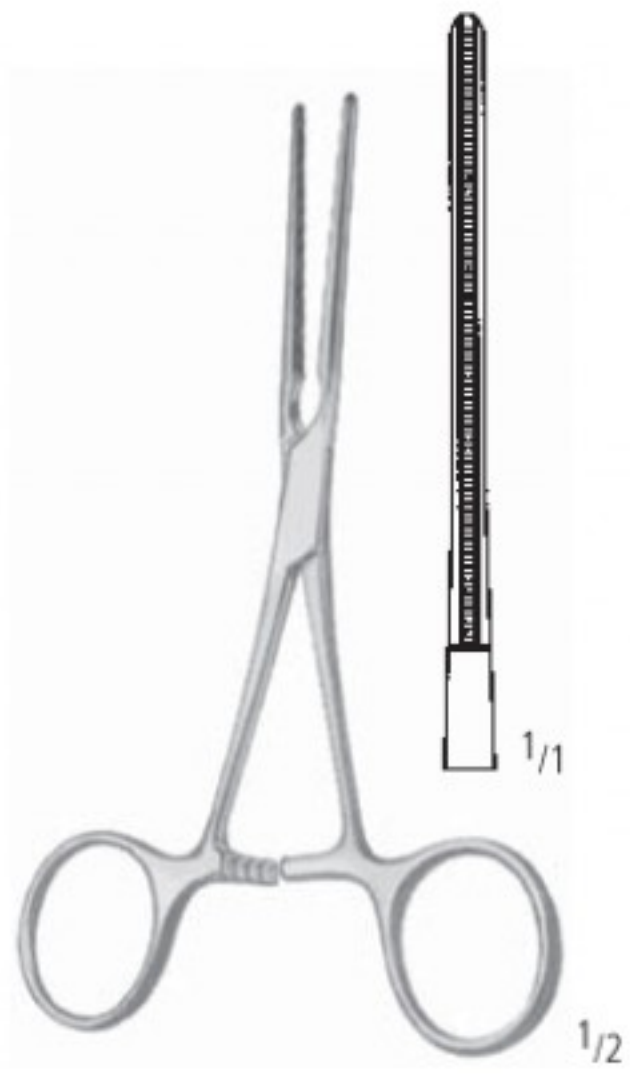

DE BAKEY
 KK 637/12
 12,0 cm/4³/₄"

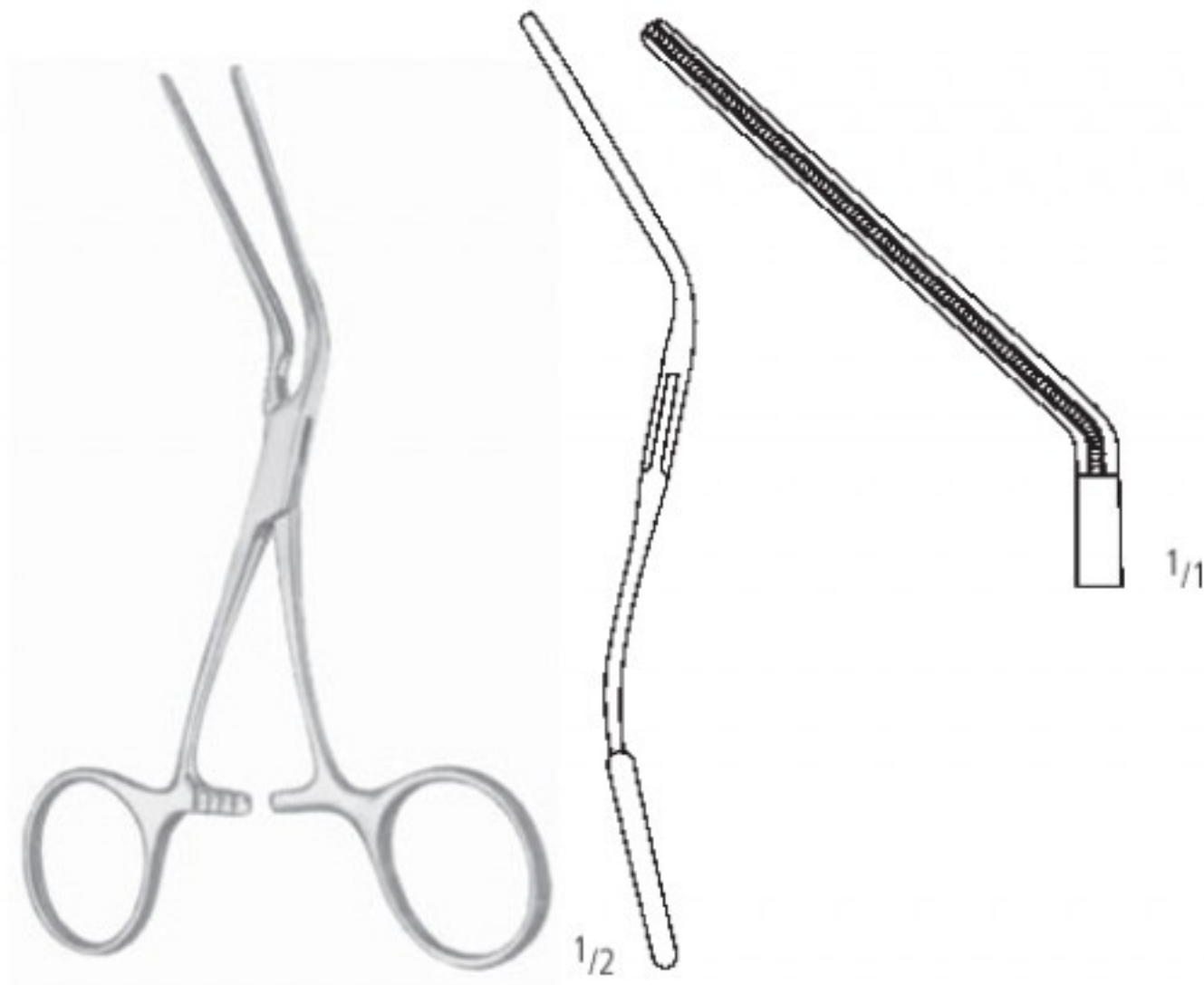

DE BAKEY
 KK 639/13
 13,0 cm/5¹/₄"

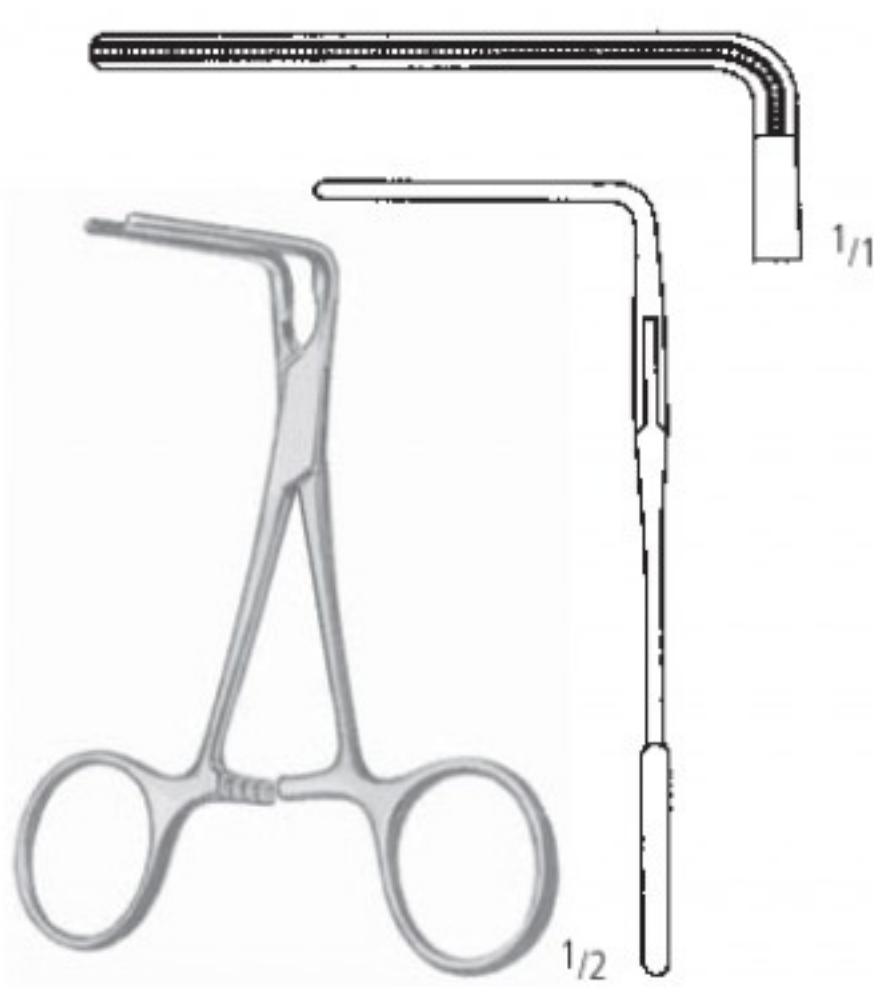

DE BAKEY
 KK 641/10
 10,0 cm/4"



DE BAKEY
 KK 643/11
 11,0 cm/4¹/₄"



DE BAKEY
 KK 645/12
 12,0 cm/4³/₄"

AA
 AB
 AC
 AD
 AE
 AF
 AG
 AH
 AI
 AJ
 AK
 AL
 AM
 AN
 AO
 AP
 AQ
 AR
 AS
 AT
 AU
 AV
 AW
 AX
 AY
 AZ

KK

Atrauma-Klemmen
 Atrauma Forceps
 Pinzas Atrauma
 Pincès atraumatiques
 Pinze Atrauma



DE BAKEY

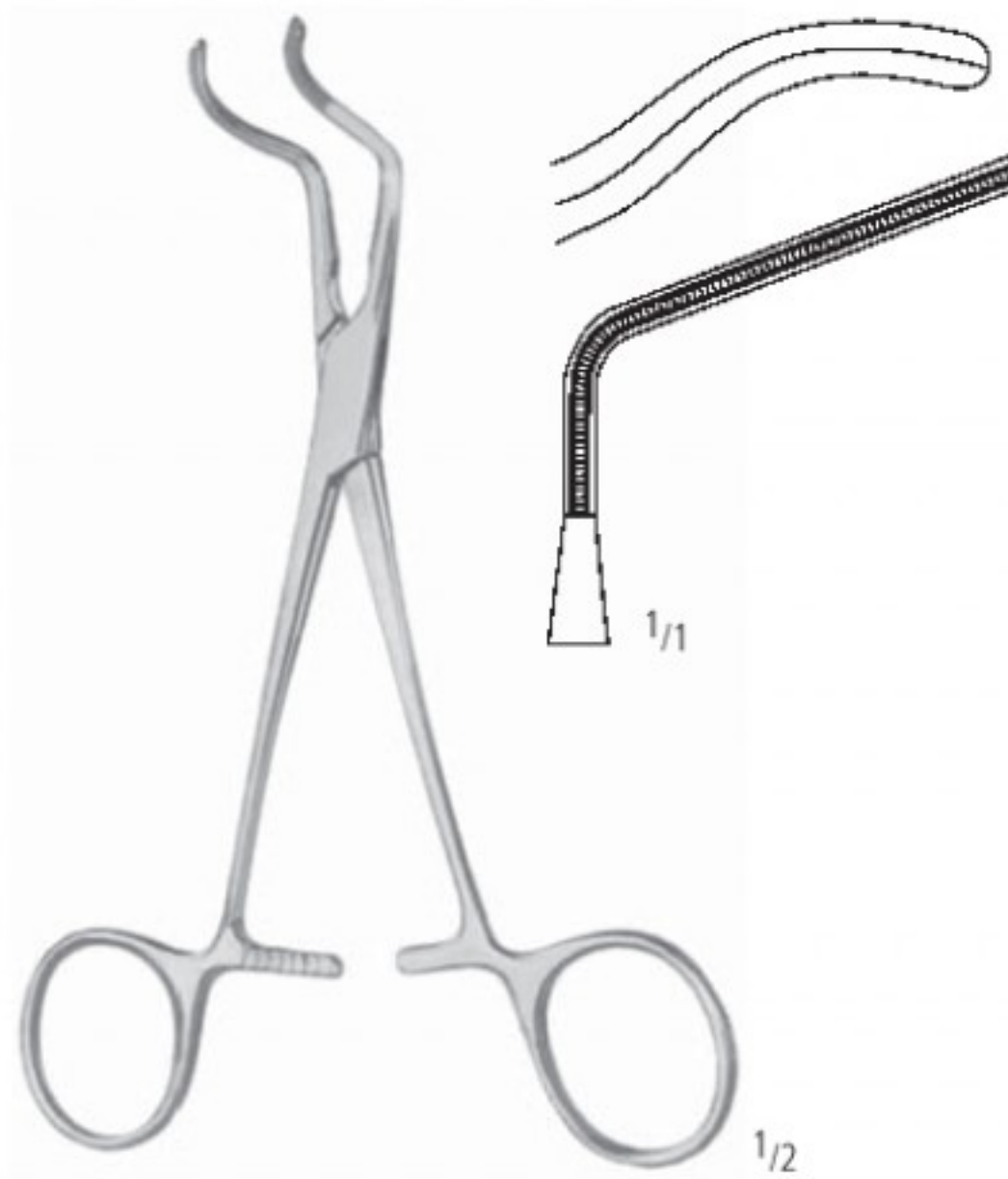

SUBRAMANIAN-MINIATURE
 KK 651/15
 15,5 cm/6"

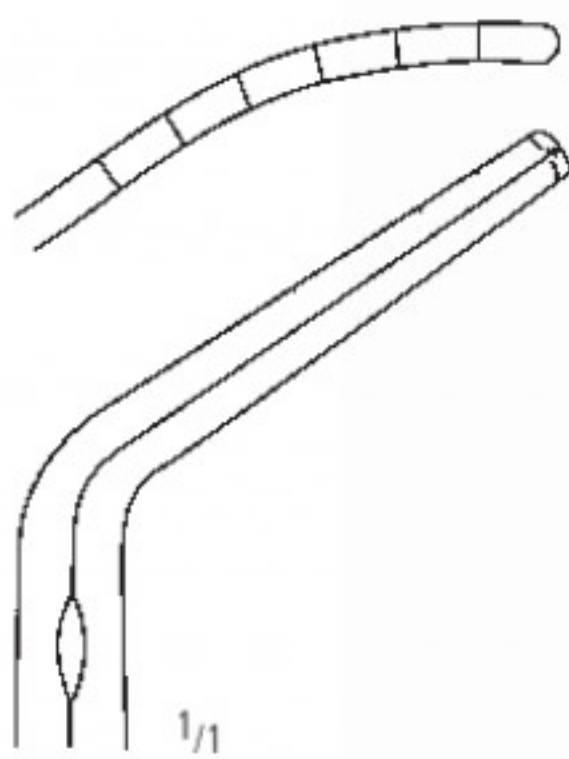

SUBRAMANIAN
 KK 653/01
 16,0 cm/6¹/₄"

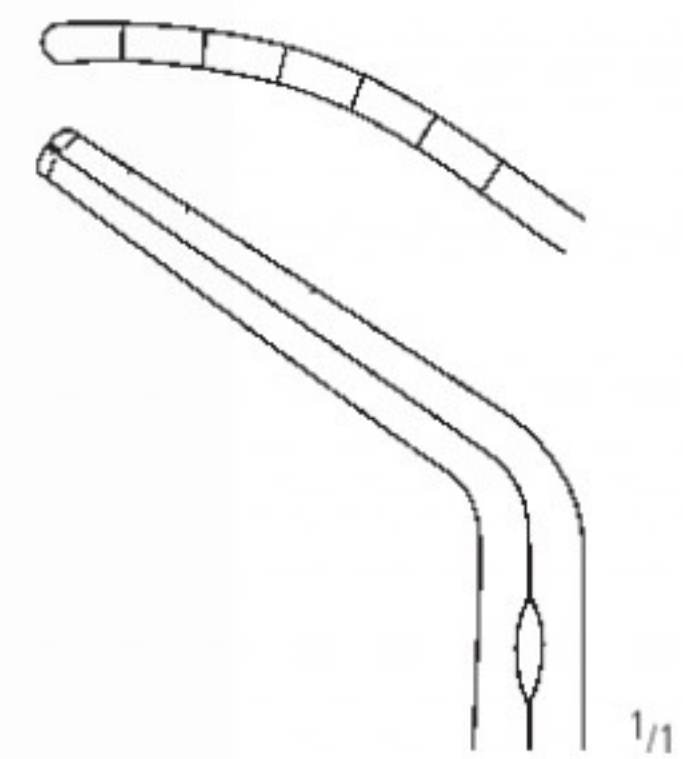

SUBRAMANIAN
 KK 653/02
 16,0 cm/6¹/₄"

HERZ/THORAX CARDIOVASCULAR CARDIOVASCULAR CARDIOVASCULAIRE CARDIOVASCOLARE

Bronchusklemmen, Lungenfasszangen
 Bronchus clamps, Lung grasping forceps
 Pinzas clamps bronquiales y para pulmon
 Pincers-clamps à bronches et à poumons
 Pinze per bronchi, Pinze per polmoni



PRICE-THOMAS
 KK 701/22
 22,0 cm/8³/₄"



KK 702/01

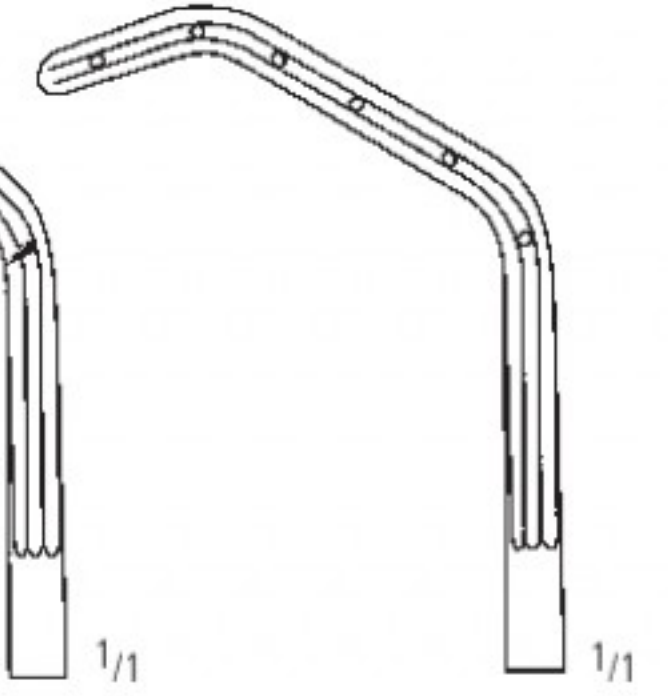

KK 702/02

PRICE-THOMAS
 22,0 cm/8³/₄"



SEMB
 24,0 cm/9¹/₂"



KK 703/01

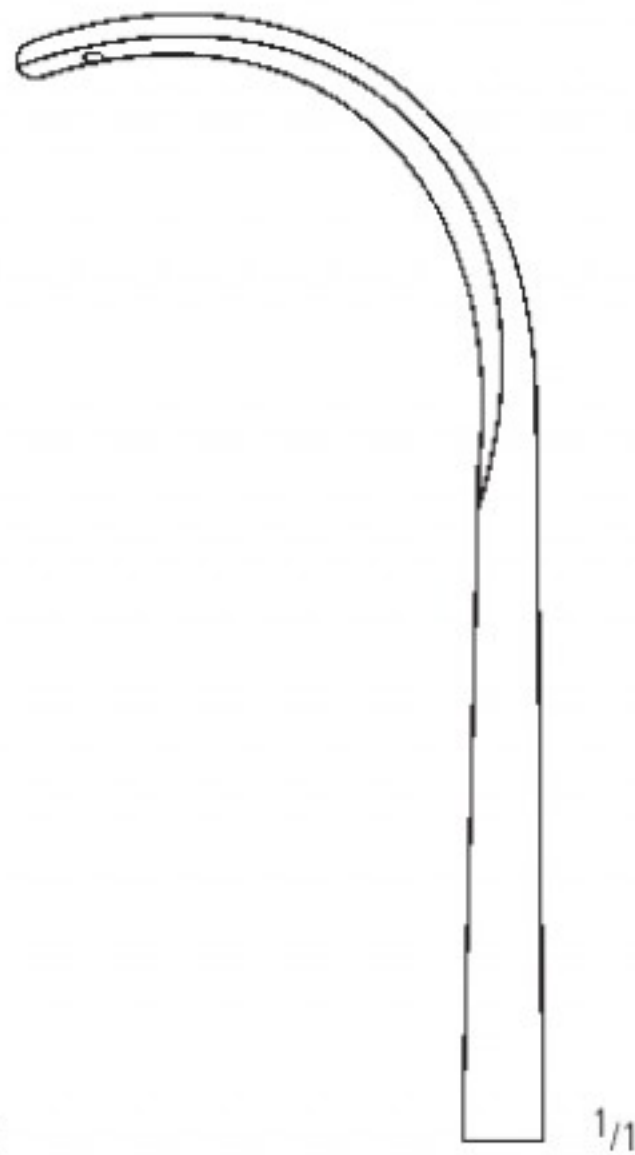

KK 703/02



LOVELACE
 KK 704/20
 20,0 cm/8"



1/1

AA
AB
AC
AD
AE
AF
AK
AL
AO
KA
X

KK

Vena-Cava Klemmen
 Vena-Cava Forceps
 Clamps Vena Cava
 Pincers Vena Cava
 Pinze Vena Cava



1/3

SATINSKY
 26,0 cm/10¹/₂"

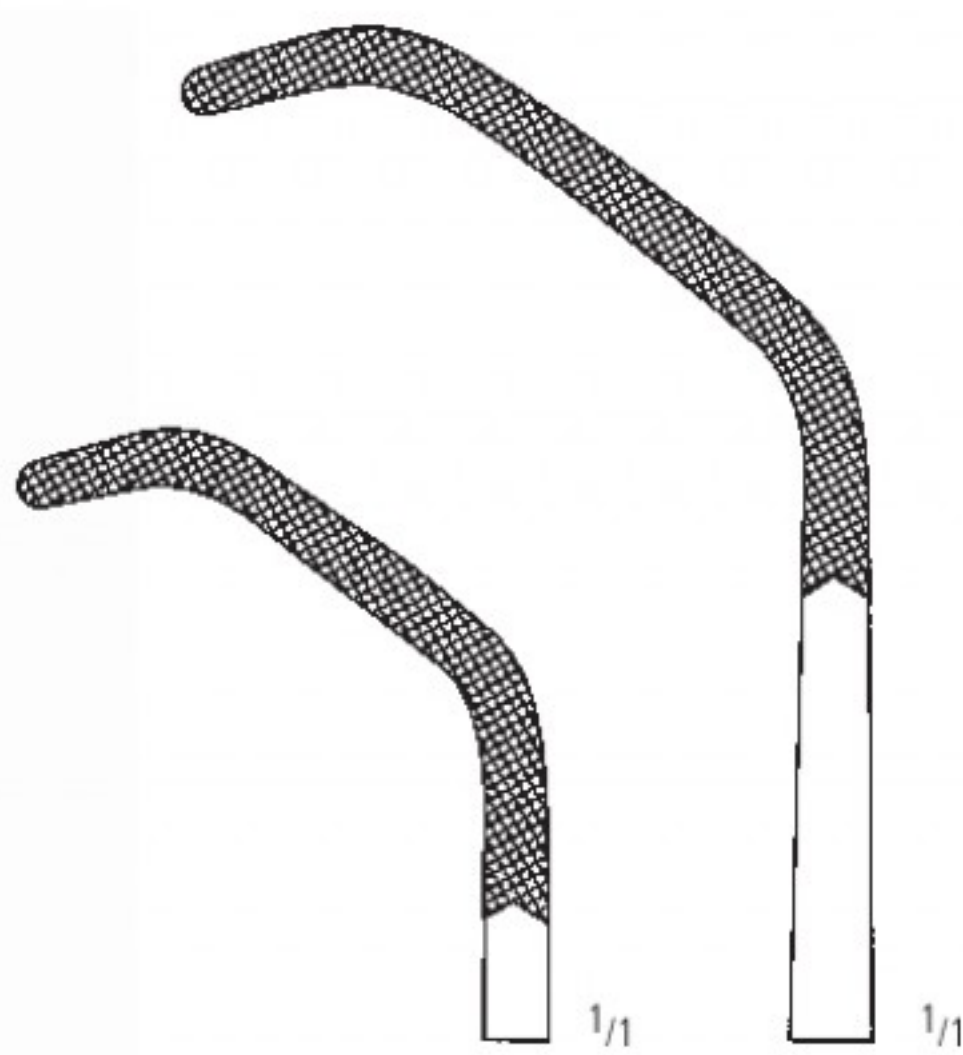

1/1

1/1

KK 707/01

KK 707/02



1/2

BABY-SATINSKY
 KK 708/15
 15,0 cm/6"

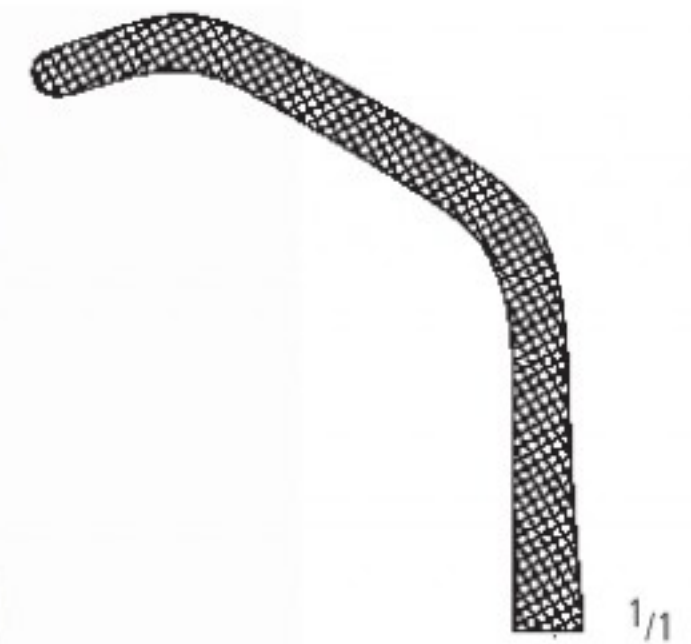

1/1



1/3

HARKEN
 24,0 cm/9¹/₂"



1/1

KK 709/01
 24,0 cm/9¹/₂"



1/1

KK 709/02
 24,0 cm/9¹/₂"

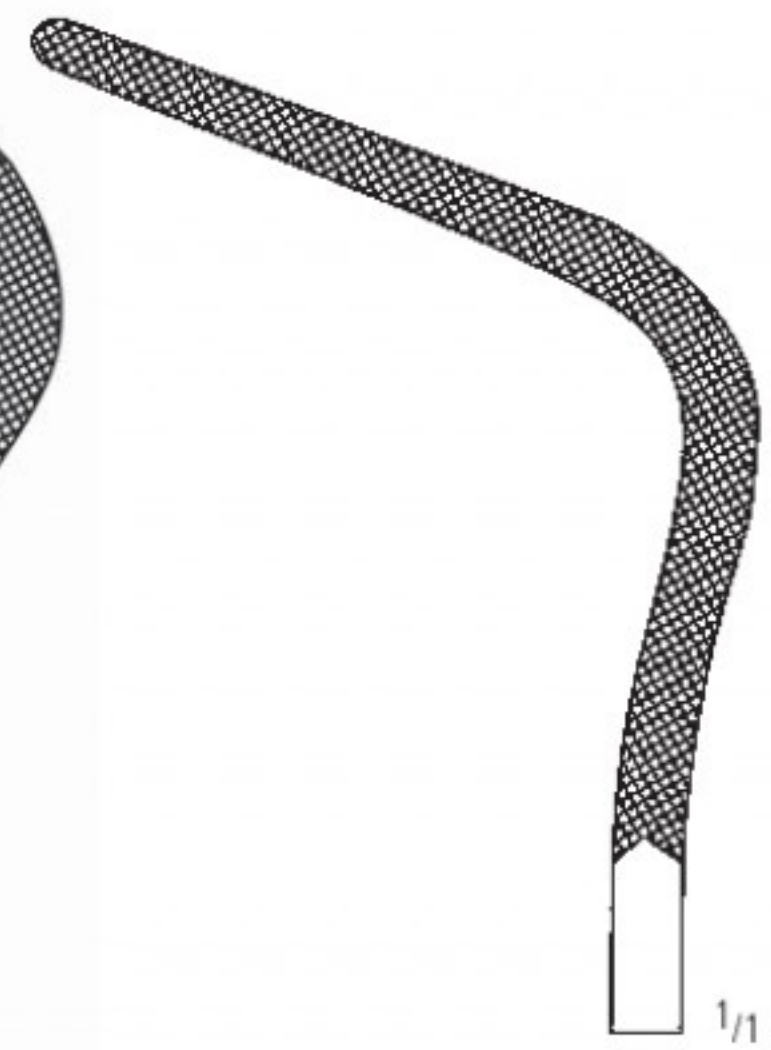

1/1

KK 709/03
 24,0 cm/9¹/₂"

Dilatatoren, Tourniquet
 Dilators, Tourniquets
 Diladores, Torniquetes
 Dilateurs, Tourniquets
 Dilatori, Tornichetti

AA
 AB
 AC
 AD
 AE
 AF
 AK
 AL
 AO
 KA
KK
 X



TUBBS
 KK 720/42



RUMEL-BELMONT
 Ø 3,2 mm KK 730/32
 Ø 6,4 mm KK 730/64

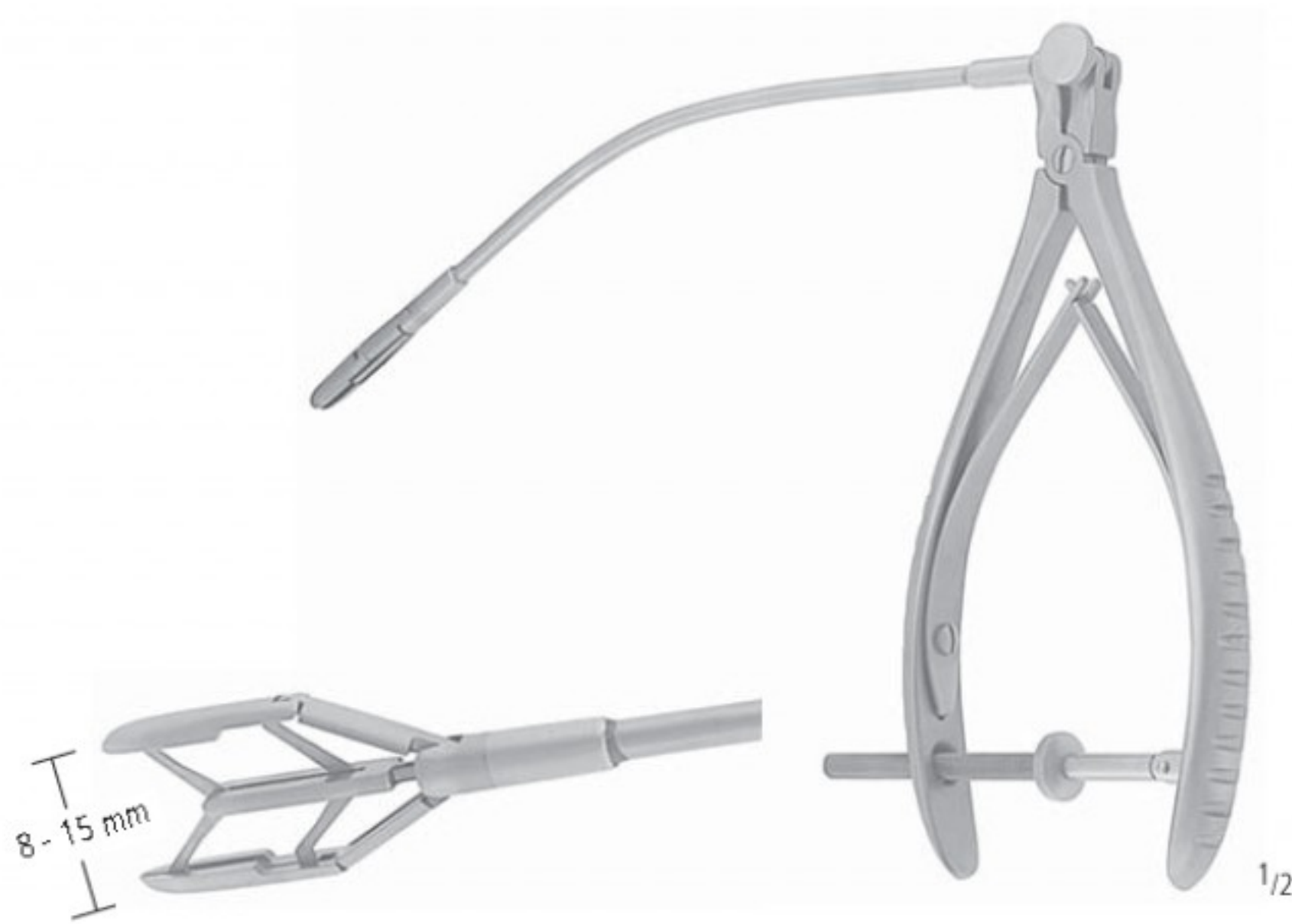

COOLEY
 KK 722/15

THORAKOSKOPIE
THORACOSCOPY
TORACOSCOPIA
TORACOSCOPIE
TORACOSCOPIA

X

nopa[®] instruments

Weitere Endoskopie-Instrumente finden Sie in unserem Katalog "Endoskopie".

For further endoscopic instruments kindly refer to our catalogue "Endoscopy".

Para instrumental de endoscopia adicional, por favor consulte nuestro catálogo de "Endoscopia".

Pour des instruments d'endoscopie supplémentaires, consultez notre catalogue "Endoscopie".

Per gli altri strumenti endoscopia, consultare il nostro catalogo "Endoscopia".



>> Optiken • Telescopes • Ópticas • Optiques • Ottiche

304–305

1

>> Instrumente für Laparoskopie / Thorax • Instruments for Laparoscopy / Thorax
Instrumentos para Laparoscopia / Tórax • Instruments pour Laparoscopie / Thorax
Strumenti per Laparoscopia / Torace

306–313

3

>> Elektroden / Saugen / Spülen / Kanülen / Trokare • Electrodes / Suction / Irrigation / Cannulae /
Trocars • Electrodo / Succión / Irrigación / Agujas / Trócares • Electrodes / Aspiration / Irrigation /
Canules / Trocarts • Elettrodi / Aspirazione / Irrigazione / Aghi speciali / Tre quarti

314–325

5

>> HF-Zubehör • HF-accessories • AF-accesorios • HF-accessoires • AF-accessori

326–331

7

>> Kaltlichtquellen, Kameras • Cold light sources, cameras • Fuentes de luz fría, cámaras
Sources à lumière froide, cámaras • Sorgente luce fredda, macchine fotografiche

332–341

18

>> Verschiedenes • Various items • Artículos diversos • Articles divers • Articoli diversi

342–343

22

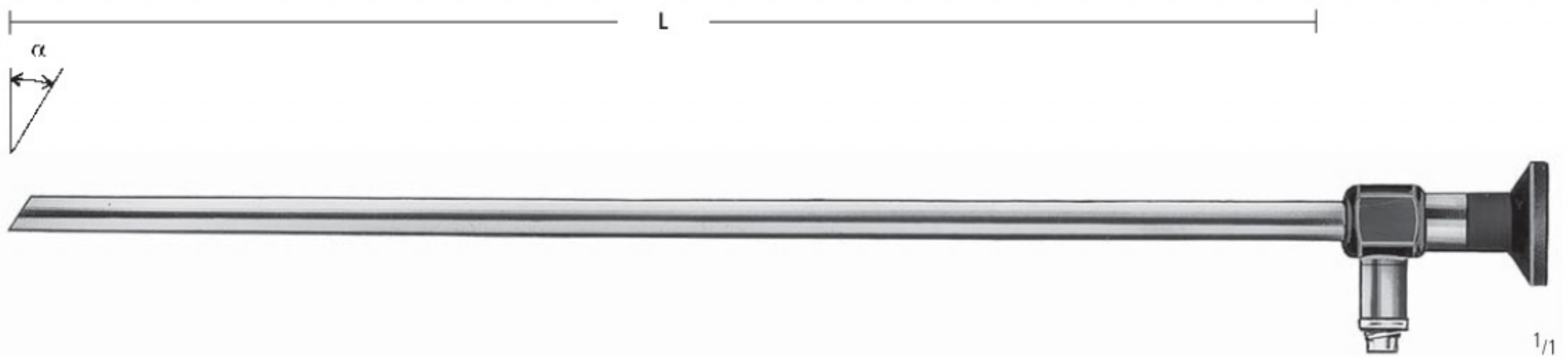

Ø mm	$\alpha = 0^\circ$	$\alpha = 30^\circ$	L
5,0	XP 720/50	XP 720/53	336 mm
6,5	XP 720/60	XP 720/63	336 mm
8,0	XP 721/80	XP 721/83	340 mm
10,0	XP 722/90	XP 722/93	344 mm

>> autoklavierbar
autoclavable

>> mit Anschluss für
with adaptors for

Storz
Wolf
ACMI

Thorakoskopie - Bronchoskopie
 Thoracoscopy - Bronchoscopy
 Torascoscopia - Bronquioscopia
 Thorascoscopia - Bronchoscopy
 Torascoscopia - Broncoscopia

1
3
5
7
18
22

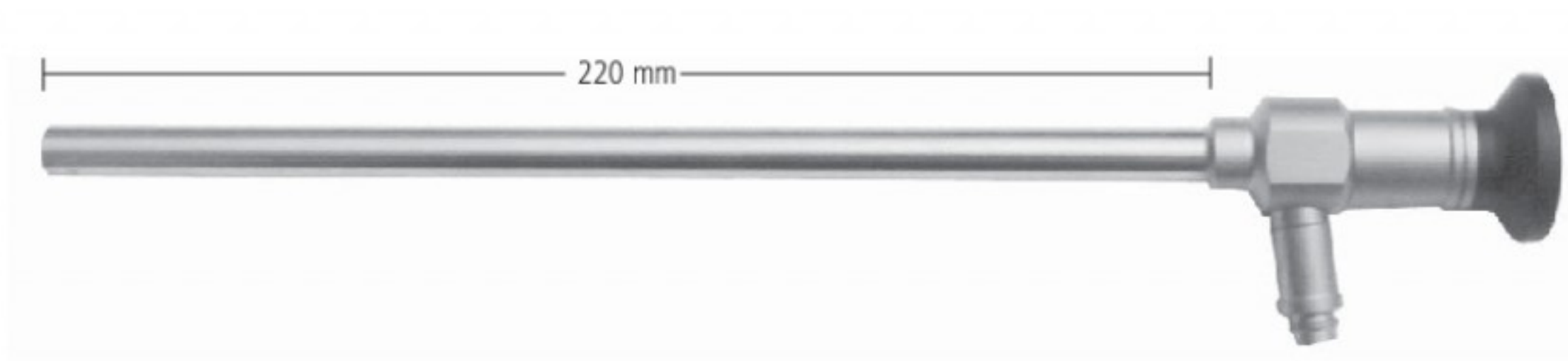

Ø mm	$\alpha = 0^\circ$	$\alpha = 30^\circ$
10,0	XP 728/10	XP 728/13

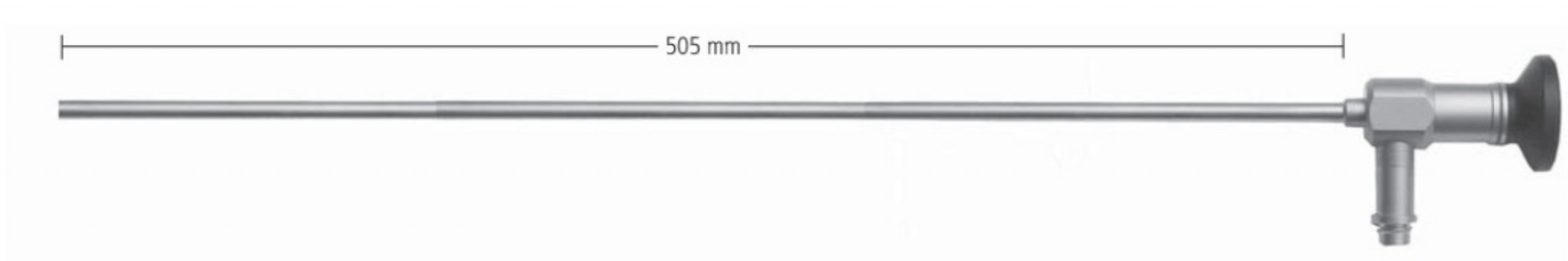

Ø mm	$\alpha = 0^\circ$	$\alpha = 30^\circ$
5,5	XP 729/50	XP 729/53

>> autoklavierbar
autoclavable

>> mit Anschluss für
with adaptors for

Storz
Wolf
ACMI

easyClean[®]

Ø 5,0 mm, 10,0 mm, 2-teilig / 2-piece

THORAX



XM 010/00



XM 014/00



XM 016/00

Bestellinformation: Bestellen Sie bitte Griff und Arbeitseinsatz
 Ordering information: Please order handle and working tip

Scharfe Präparation, Fasszangen
 Sharp Dissection, Grasping Forceps
 Disección punta, Pinzas de aprehensión
 Dissection tranchant, Pincés à Préhension
 Dissezione tagliente, Pinze da presa

easyClean[®]

Ø 5,0 mm, 10,0 mm, 2-teilig / 2-piece

THORAX

1
3

Bestellinformation: Bestellen Sie bitte Griff und Arbeitseinsatz
 Ordering information: Please order handle and working tip

5
7
18
22

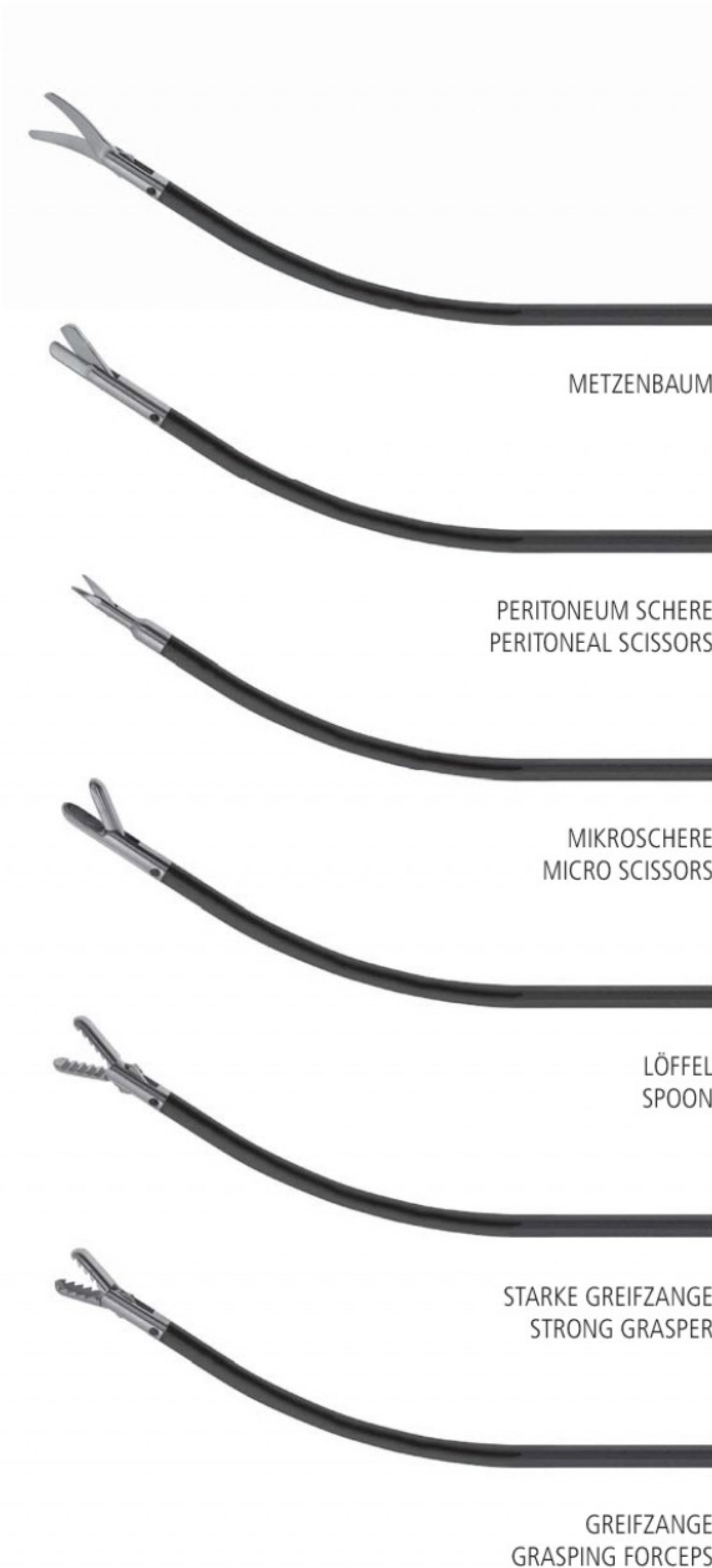

36,0 cm/14"
 Ø 5,0 mm XM 300/01

Ø 5,0 mm XM 300/02

Ø 5,0 mm XM 300/03

Ø 5,0 mm XM 300/04

Ø 5,0 mm XM 300/10

Ø 5,0 mm XM 300/11





Fasszangen
Grasping Forceps
Pinzas de aprehensión
Pincas à préhension
Pinze da presa

easyClean[®]

Ø 5,0 mm, 10,0 mm, 2-teilig / 2-piece

THORAX

Bestellinformation: Bestellen Sie bitte Griff und Arbeitseinsatz
Ordering information: Please order handle and working tip

			36,0 cm/14"
		Ø 5,0 mm	XM 300/12
McKERNAN			
			
		Ø 5,0 mm	XM 300/13
GEZAHNTER GREIFER KOBRA TOOTHED GRASPER COBRA			
			
		Ø 5,0 mm	XM 300/14
FASSZANGE GEFENSTERT GRASPING FORCEPS FENSTERED			
			
		Ø 5,0 mm	XM 300/15
BABCOCK - ALLIS			
			
		Ø 10,0 mm	XM 300/16
DUVAL			

Fasszangen
Grasping Forceps
Pinzas de aprehensión
Pincas à préhension
Pinze da presa

easyClean[®]

Ø 5,0 mm, 10,0 mm, 2-teilig / 2-piece

THORAX

1

3

5

7

18

22

Bestellinformation: Bestellen Sie bitte Griff und Arbeitseinsatz
Ordering information: Please order handle and working tip



KOCHER KLAMMERZANGE
KOCHER CLAMPING FORCEPS

Ø 10,0 mm

36,0 cm/14"

XM 300/17



ATRAUMATISCHER GREIFER
ATRAUMATIC GRASPER

Ø 5,0 mm

XM 300/18



MARYLAND

Ø 5,0 mm

XM 300/19

Scharfe Präparation, Faszangen
 Sharp Dissection, Grasping Forceps
 Disección punta, Pinzas de aprehensión
 Dissection tranchant, Pinces à Préhension
 Dissezione tagliente, Pinze da presa

Ø 5,0 mm, 10,0 mm, 1-teilig / 1-piece

THORAX

		36,0 cm/14"	
		Ø 5,0 mm	XM 301/01
	METZENBAUM		
		Ø 5,0 mm	XM 301/02
	PERITONEUM SCHERE PERITONEAL SCISSORS		
		Ø 5,0 mm	XM 301/03
	MIKROSCHERE MICRO SCISSORS		
		Ø 5,0 mm	XM 301/04
	LÖFFEL SPOON		
		Ø 5,0 mm	XM 301/10
	STARKE GREIFZANGE STRONG GRASPER		
		Ø 5,0 mm	XM 301/11
	GREIFZANGE GRASPING FORCEPS		

Fasszangen
Grasping Forceps
Pinzas de aprehensión
Pincas à préhension
Pinze da presa

Ø 5,0 mm, 10,0 mm, 1-teilig / 1-piece

THORAX



MCKERNAN

Ø 5,0 mm

36,0 cm/14"

XM 301/12



Ø 5,0 mm

XM 301/13

GEZAHNTER GREIFER KOBRA
TOOTHED GRASPER COBRA



Ø 5,0 mm

XM 301/14

FASSZANGE GEFENSTERT
GRASPING FORCEPS FENESTRATED



Ø 5,0 mm

XM 301/15

BABCOCK - ALLIS



Ø 10,0 mm

XM 301/16

DUVAL

1

3

5

7

18

22

Fasszangen
Grasping Forceps
Pinzas de aprehensión
Pincas à préhension
Pinze da presa

Ø 5,0 mm, 10,0 mm, 1-teilig / 1-piece

THORAX

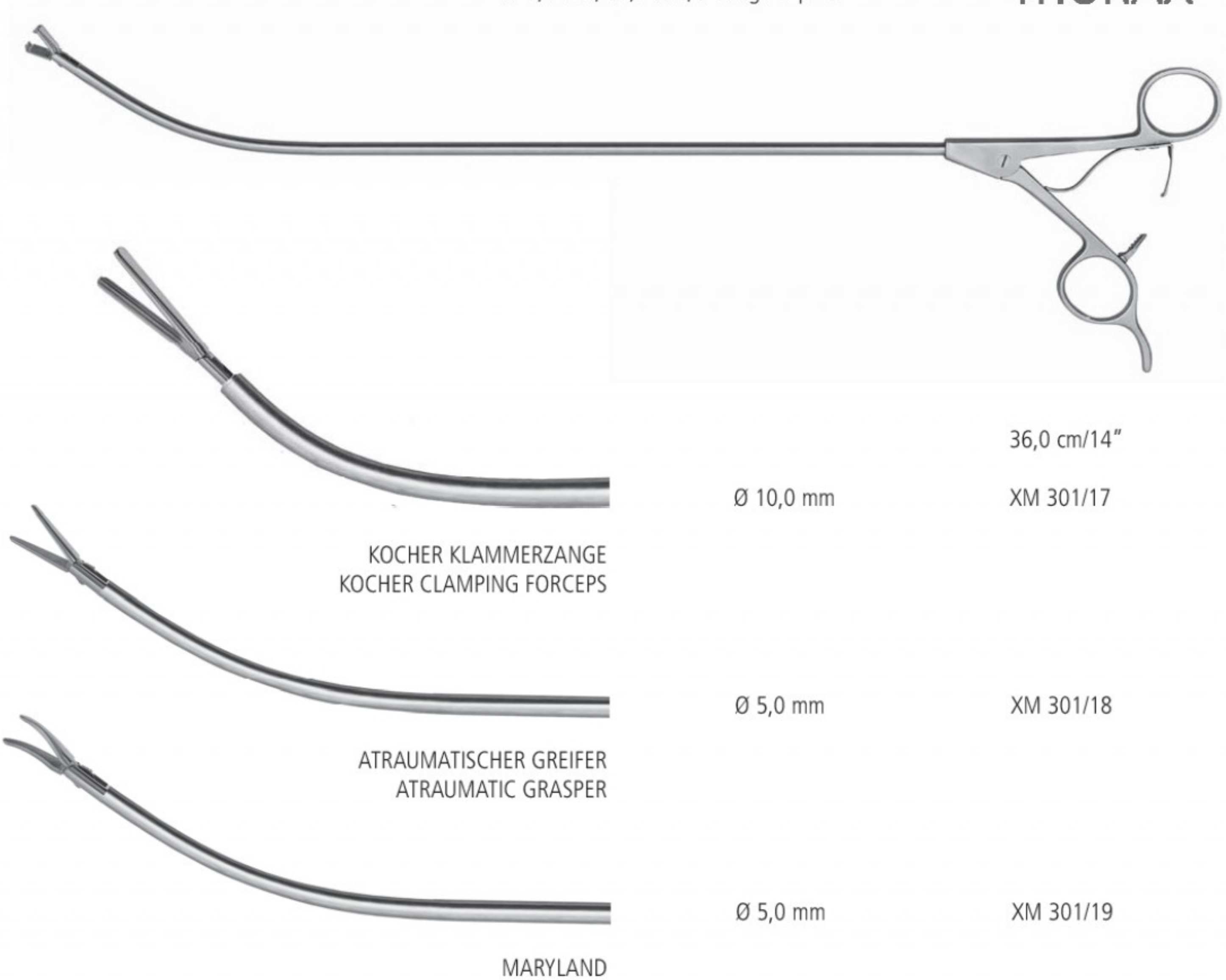

36,0 cm/14"

Ø 10,0 mm

XM 301/17

KOCHER KLAMMERZANGE
KOCHER CLAMPING FORCEPS

Ø 5,0 mm

XM 301/18

ATRAUMATISCHER GREIFER
ATRAUMATIC GRASPER

Ø 5,0 mm

XM 301/19

MARYLAND

ENDOSKOPIE ENDOSCOPY ENDOSCOPIA ENDOSCOPIE ENDOSCOPIA

Retraktoren
Retractors
Separadores
Ecarteurs
Divaricatori

1

3

5

7

18

22



1/2

Ø 10,0 mm

XM 570/00



1/2

L = 50,0 mm

XM 570/50

L = 75,0 mm

XM 570/75

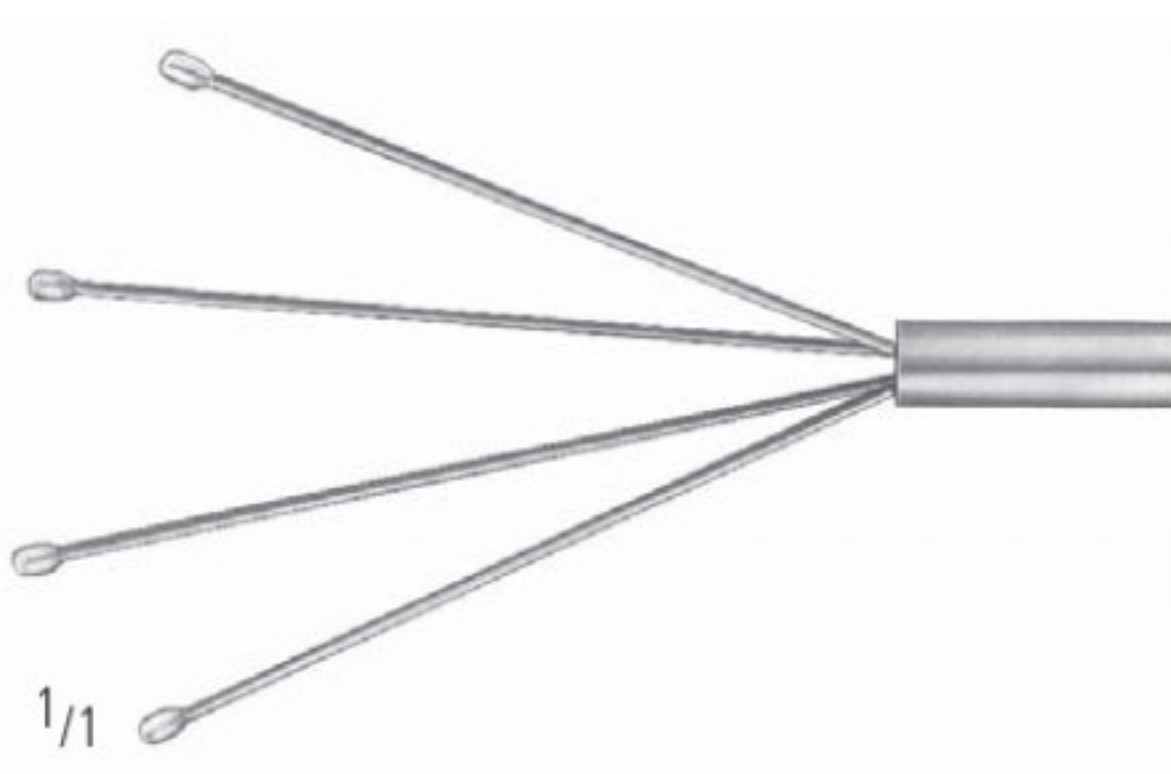

1/1

Ø 5,0 mm

XM 571/05

Elektroden mit Absaugung
 Electrodes with suction tube
 Electrodo con tubo de succión
 Electrodes avec canule d'aspiration
 Elettrodi con tubo d'aspirazione

nopa econom

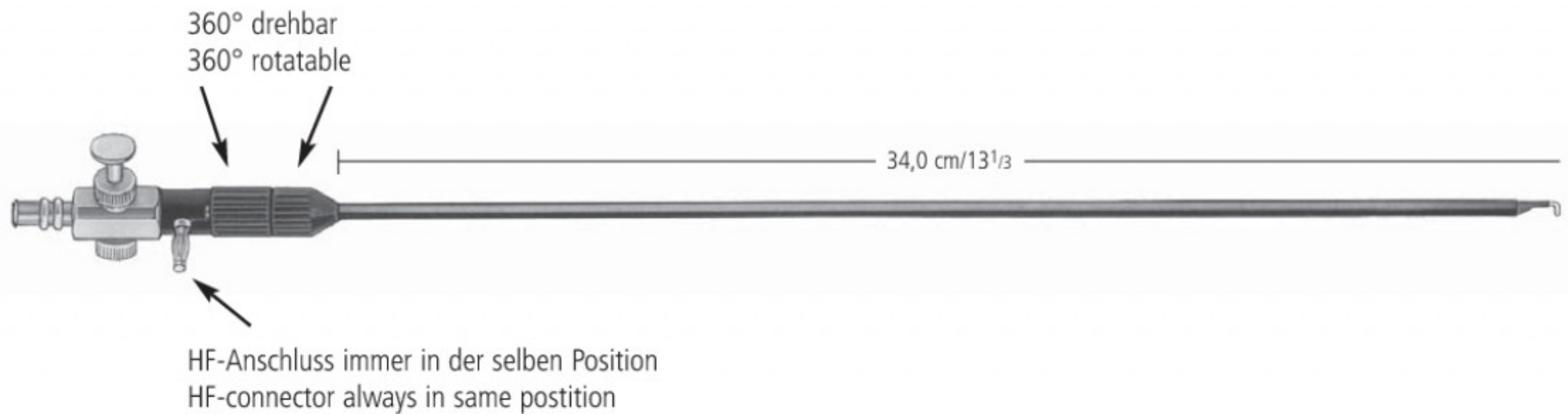

XK 546/00

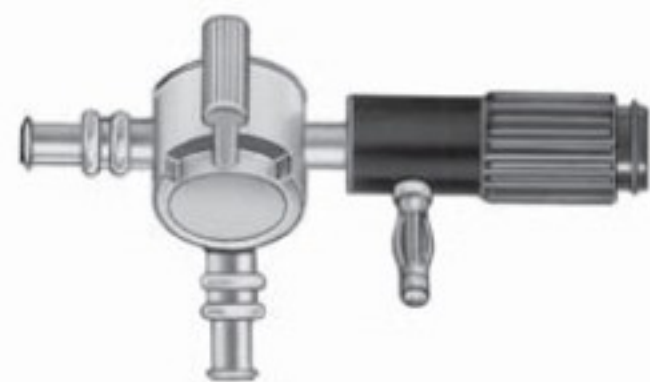

XK 547/00



XK 548/00

perfekte Reinigung
 perfect cleaning



Ø 5,0 mm
 XK 549/01



Ø 5,0 mm
 XK 549/02



Ø 5,0 mm
 XK 549/03



Ø 5,0 mm
 XK 549/04



nopa-econom Elektroden sind durch LUER-LOCK Kupplung leicht auseinandernehmbar. Trotz Verwendung von hochwertigstem Isoliermaterial werden Elektrodenschäfte immer wieder durch unsachgemäße Handhabung oder Reinigung beschädigt. Das nopa System garantiert schnelles und enorm kostengünstiges Auswechseln. Durch unsere Kombinationsmöglichkeiten ergeben sich bereits bei der Grundausstattung erhebliche wirtschaftliche Vorteile.

nopa-econom electrodes are easy to take apart by means of a LUER-LOCK coupling (connection). Although our electrode shafts are coated with superb insulation material, the insulation is very often damaged due to improper handling or cleaning procedures. The nopa system guarantees a fast, reliable and inexpensive exchange of shafts. The combination possibilities offer enormous cost advantages even for a basic instrument set.

ENDOSKOPIE ENDOSCOPY ENDOSCOPIA ENDOSCOPIE ENDOSCOPIA

Elektroden mit Absaugung
 Electrodes with suction tube
 Electrodo con tubo de succión
 Electrodes avec canule d'aspiration
 Elettrodi con tubo d'aspirazione



2/1

Ø 5,0 mm XK 550/01



2/1

Ø 5,0 mm XK 550/02



2/1

Ø 5,0 mm XK 550/03



2/1

Ø 5,0 mm XK 550/04



2/1

Ø 5,0 mm XK 550/05

1

3

5

7

18

22

5 ENDOSKOPIE ENDOSCOPY ENDOSCOPIA ENDOSCOPIE ENDOSCOPIA

Elektroden mit Absaugung
 Electrodes with suction tube
 Electrodo con tubo de succión
 Electrodes avec canule d'aspiration
 Elettrodi con tubo d'aspirazione

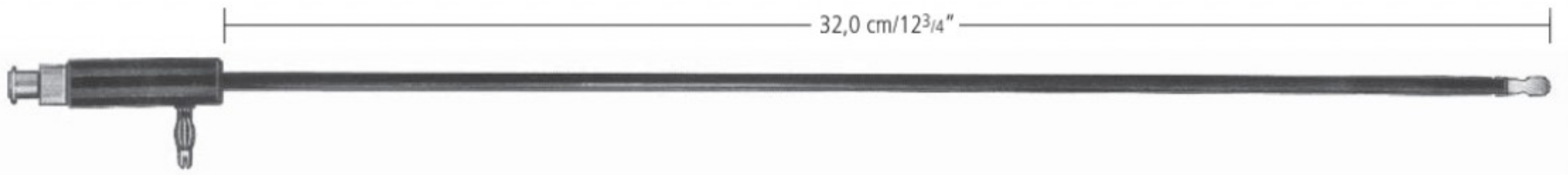

Ø 5,0 mm XK 554/01



Ø 5,0 mm XK 554/02



Ø 5,0 mm XK 554/03



Ø 5,0 mm XK 554/04



Ø 5,0 mm XK 554/05

ENDOSKOPIE ENDOSCOPY ENDOSCOPIA ENDOSCOPIE ENDOSCOPIA

Elektroden ohne Absaugung
 Electrodes without suction tube
 Electrodo sin tubo de succión
 Electrodes sans canule d'aspiration
 Elettrodi senza tubo d'aspirazione

1

3

5

7

18

22



Ø 5,0 mm XK 556/01

2/1



Ø 5,0 mm XK 556/02

2/1



Ø 5,0 mm XK 556/03

2/1



Ø 5,0 mm XK 556/04

2/1



Ø 5,0 mm XK 556/05

2/1

5 ENDOSKOPIE ENDOSCOPY ENDOSCOPIA ENDOSCOPIE ENDOSCOPIA

Saug- und Spülrohre, Punktionskanülen
 Suction and irrigation tubes, Puncture needles
 Cánulas de aspiración, Agujas para punción
 Canules d'aspiration, Aiguilles pour ponction
 Cannule per aspirazione, Aghi per puntura

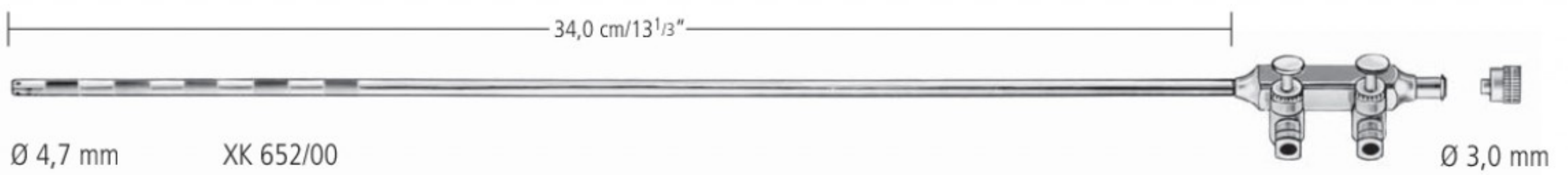
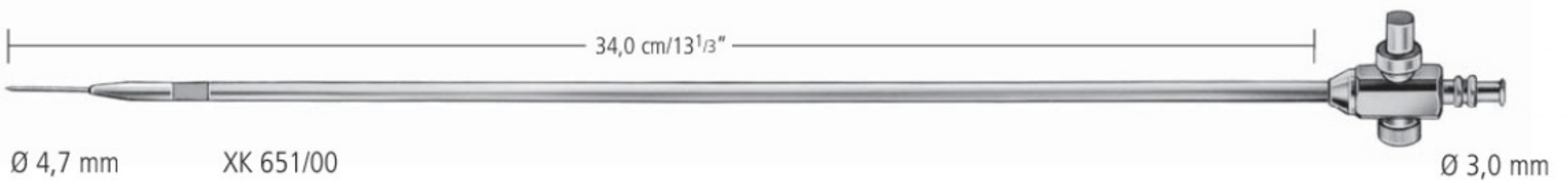

Saug- und Spülrohre
Suction and irrigation tubes
Cánulas de aspiración
Canules d'aspiration
Cannule per aspirazione



Saug und Spül Pistolenhandgriff
Suction and irrigation handle

XK 663/01

1
3
5
7
18
22



Ø 3,0 mm

XK 663/03



Ø 5,0 mm

XK 663/05



Ø 10,0 mm

XK 663/10

XK 663/00 = XK 663/01
XK 663/03
XK 663/05
XK 663/10

Elektroden mit Absaugung
 Electrodes with suction tube
 Electrodo con tubo de succión
 Electrodes avec canule d'aspiration
 Elettrodi con tubo d'aspirazione



Saug und Spül Pistolenhandgriff
 Suction and irrigation handle

XK 663/01

Adapter für Elektroden
 Adaptor for electrodes



XK 663/20



Ø 5,0 mm XK 549/01



Ø 5,0 mm XK 549/02



Ø 5,0 mm XK 549/03



Ø 5,0 mm XK 549/04

nopa-econom Elektroden sind durch LUER-LOCK Kupplung leicht auseinandernehmbar. Trotz Verwendung von hochwertigstem Isoliermaterial werden Elektrodenschäfte immer wieder durch unsachgemäße Handhabung oder Reinigung beschädigt. Das nopa System garantiert schnelles und enorm kostengünstiges Auswechseln. Durch unsere Kombinationsmöglichkeiten ergeben sich bereits bei der Grundausstattung erhebliche wirtschaftliche Vorteile.

nopa-econom electrodes are easy to take apart by means of a LUER-LOCK coupling (connection). Although our electrode shafts are coated with superb insulation material, the insulation is very often damaged due to improper handling or cleaning procedures. The nopa system guarantees a fast, reliable and inexpensive exchange of shafts. The combination possibilities offer enormous cost advantages even for a basic instrument set.

Trokarhülsen und Trokare
Trocar sleeves and trocars
Camisa para trocares y trocares
Trocards à manche et trocards
Manicotti trequarti e trequarti

THORAX

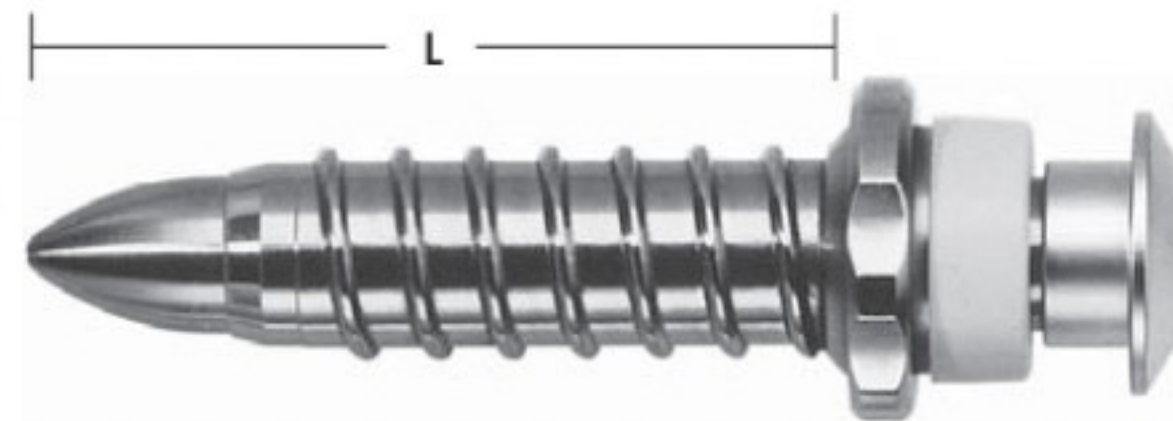

Satz			
Set			
Ø 6,0 mm	L=5,0 cm/2"		XK 645/06
Ø 11,0 mm	L=5,0 cm/2"		XK 645/11
Ø 13,0 mm	L=5,0 cm/2"		XK 645/13

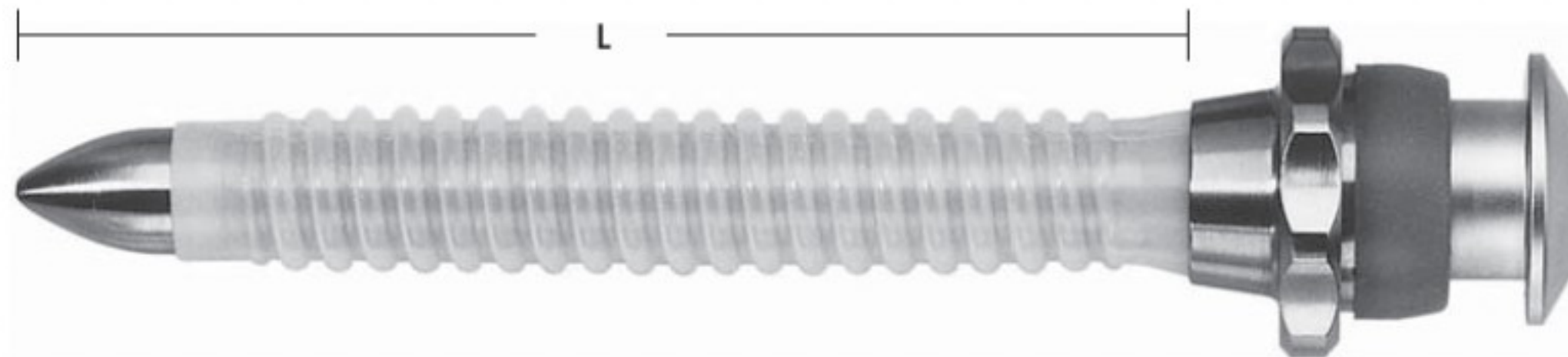

Satz			
Set			
Ø 6,0 mm	L=7,0 cm/2 ³ / ₄ "		XK 647/06
Ø 6,0 mm	L=10,0 cm/4"		XK 647/16
Ø 11,0 mm	L=7,0 cm/2 ³ / ₄ "		XK 648/11
Ø 11,0 mm	L=10,0 cm/4"		XK 648/21

Flexible Kunststoffrohre, Verpackungseinheit 5 Stück

Flexible plastic tubes, packing unit 5 pieces

Ø 6,0 mm	L=7,0 cm/2 ³ / ₄ "		XK 647/26
Ø 6,0 mm	L=10,0 cm/4"		XK 647/36
Ø 11,0 mm	L=7,0 cm/2 ³ / ₄ "		XK 648/31
Ø 11,0 mm	L=10,0 cm/4"		XK 648/41

1

3

5

7

18

22

5 ENDOSKOPIE ENDOSCOPY ENDOSCOPIA ENDOSCOPIE ENDOSCOPIA

Trokarhülsen und Trokare
 Trocar sleeves and trocars
 Camisa para trocares y trocares
 Trocards à manche et trocards
 Manicotti trequarti e trequarti

Manuelle Ventilöffnung
 Manual valve opening

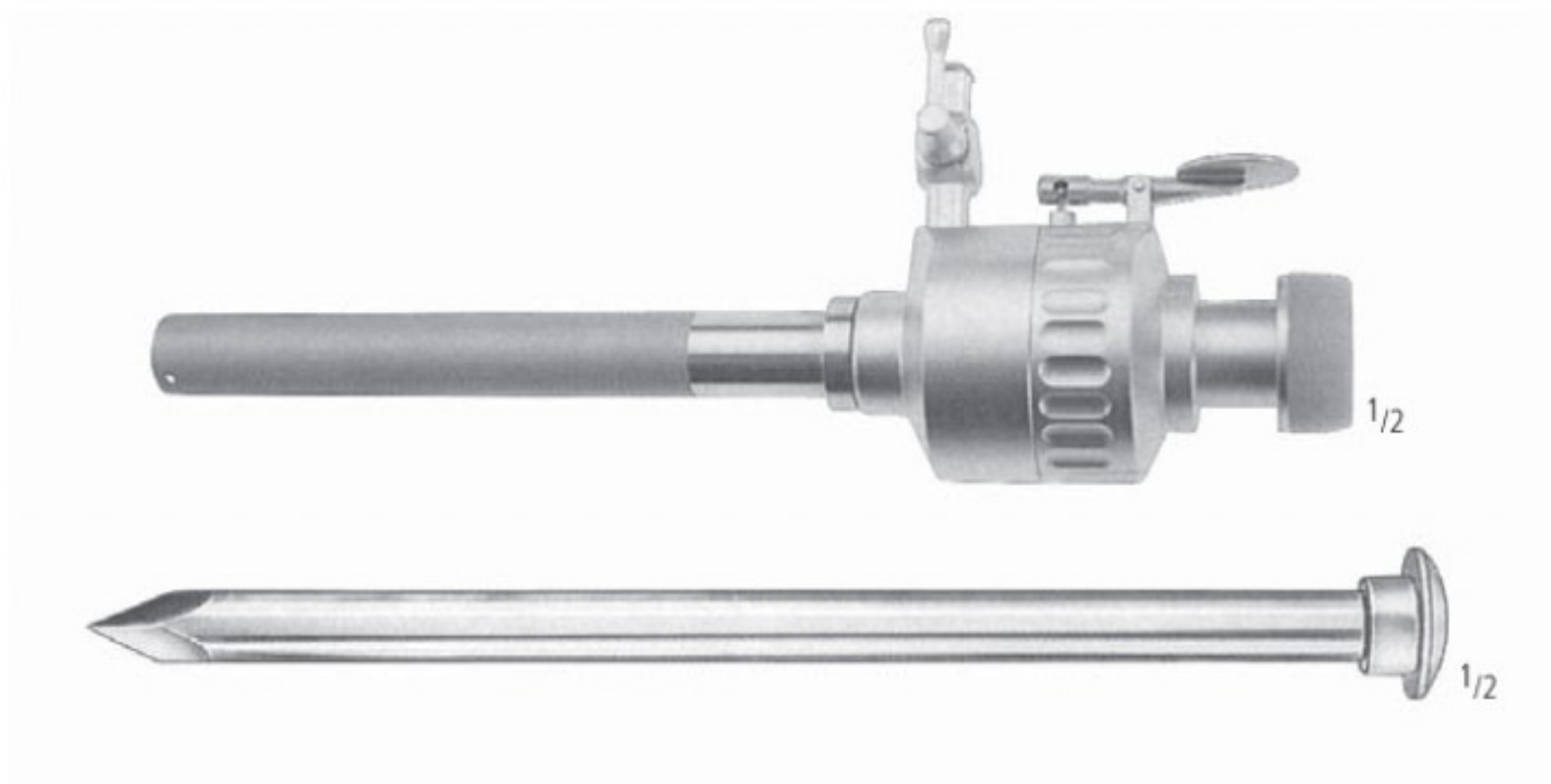

Satz		
Set		
Ø	3,5 mm	XK 650/03
Ø	5,0 mm	XK 650/05
Ø	5,5 mm	XK 650/06
Ø	10,0 mm	XK 650/10
Ø	11,0 mm	XK 650/11
Ø	12,5 mm	XK 650/12

Trokarhülsen und Trokare
 Trocar sleeves and trocars
 Camisa para trocares y trocares
 Trocards à manche et trocards
 Manicotti trequarti e trequarti

1

3

5

7

18

22

Klappenventil
 Flap valve

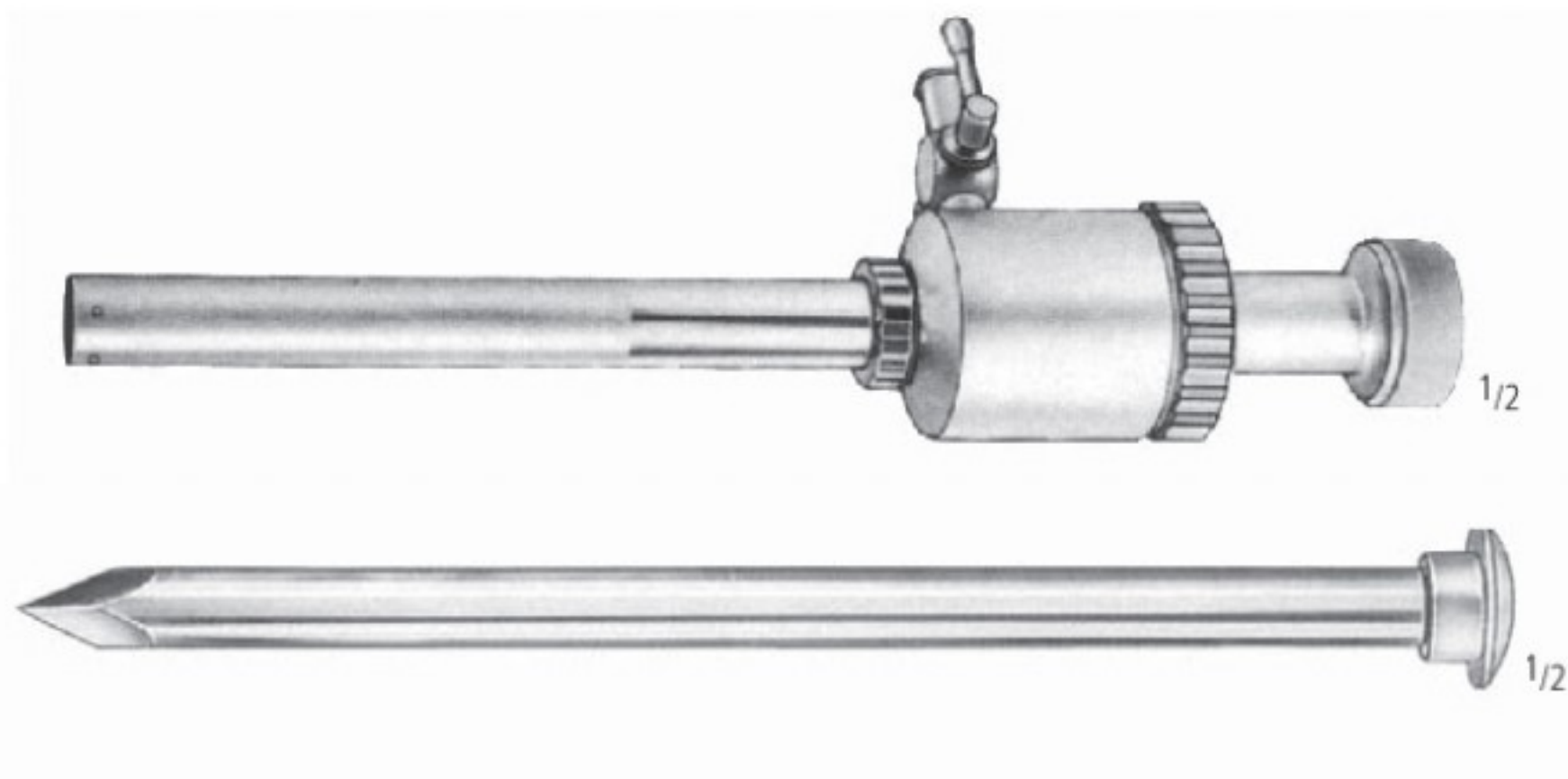

Satz		
Set		
Ø	3,5 mm	XK 652/03
Ø	5,0 mm	XK 652/05
Ø	5,5 mm	XK 652/06
Ø	10,0 mm	XK 652/10
Ø	11,0 mm	XK 652/11
Ø	12,5 mm	XK 652/12

5 ENDOSKOPIE ENDOSCOPY ENDOSCOPIA ENDOSCOPIE ENDOSCOPIA

Trokaraufsätze, Reduzierstücke
 Trocar stop with thread, Reducers
 Tope de trocar con cuerda, Reductores
 Stop trocards, Reducteurs
 Inserto per trequarti, Riduttore



Ø 5,5 mm	XK 700/05
Ø 11,0 mm	XK 700/11



Ø 5,0 mm	XK 702/05
Ø 5,5 mm	XK 702/06
Ø 10,0 mm	XK 702/10
Ø 11,0 mm	XK 702/11
Ø 12,0 mm	XK 702/12



Ø 10,0 mm	→	5,5 mm	XK 706/01
Ø 11,0 mm	→	5,5 mm	XK 706/02
Ø 12,5 mm	→	5,5 mm	XK 706/03
Ø 12,5 mm	→	10,0 mm	XK 706/04

ENDOSKOPIE ENDOSCOPY ENDOSCOPIA ENDOSCOPIE ENDOSCOPIA

Trokarhülsen und Trokare
Trocar sleeves and trocars
Camisa para trocares y trocares
Trocards à manche et trocards
Manicotti tre quarti e tre quarti

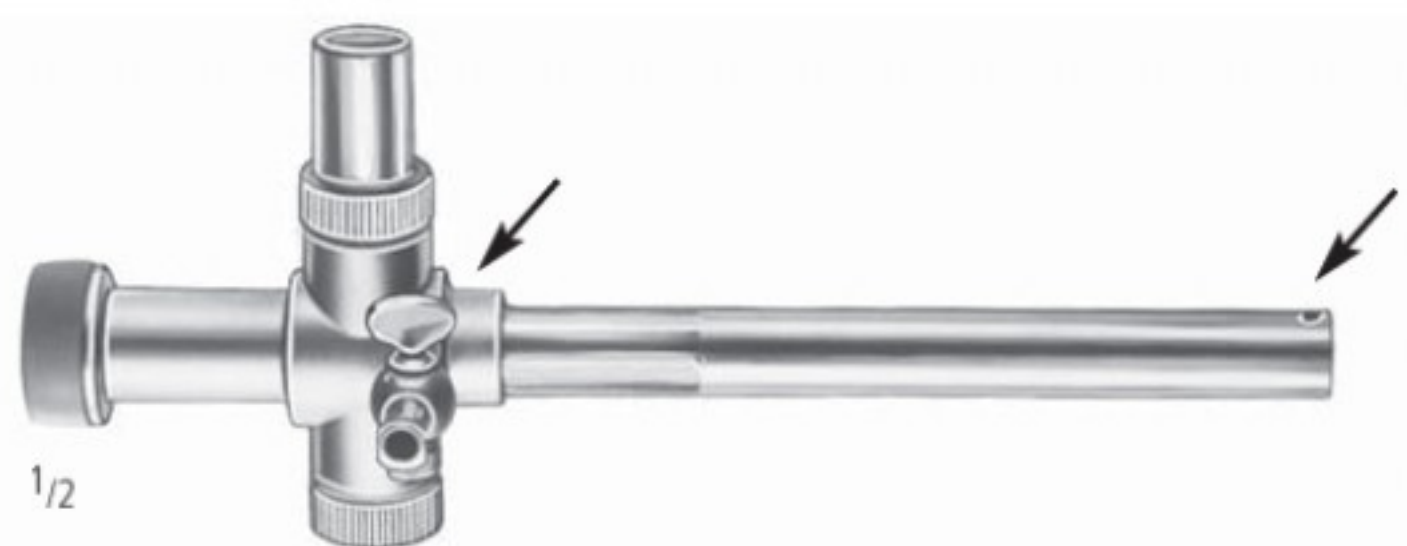

- Ø 5,0 mm XK 750/05
- Ø 8,0 mm XK 750/08
- Ø 10,0 mm XK 750/10
- Ø 11,0 mm XK 750/11
- Ø 12,5 mm XK 750/12



- Ø 5,0 mm XK 751/05
- Ø 12,5 mm XK 751/12
- Ø 15,0 mm XK 751/15
- Ø 20,0 mm XK 751/20



- | | | | |
|-----------|-----------|-----------|-----------|
| | | | |
| Ø 3,5 mm | XK 760/03 | XK 761/03 | XK 762/03 |
| Ø 5,0 mm | XK 760/05 | XK 761/05 | XK 762/05 |
| Ø 5,5 mm | XK 760/06 | XK 761/06 | XK 762/06 |
| Ø 8,0 mm | XK 760/08 | XK 761/08 | XK 762/08 |
| Ø 10,0 mm | XK 760/10 | XK 761/10 | XK 762/10 |
| Ø 11,0 mm | XK 760/11 | XK 761/11 | XK 762/11 |
| Ø 12,5 mm | XK 760/12 | XK 761/12 | XK 762/12 |
| Ø 15,0 mm | XK 760/15 | XK 761/15 | XK 762/15 |
| Ø 20,0 mm | XK 760/20 | XK 761/20 | XK 762/20 |

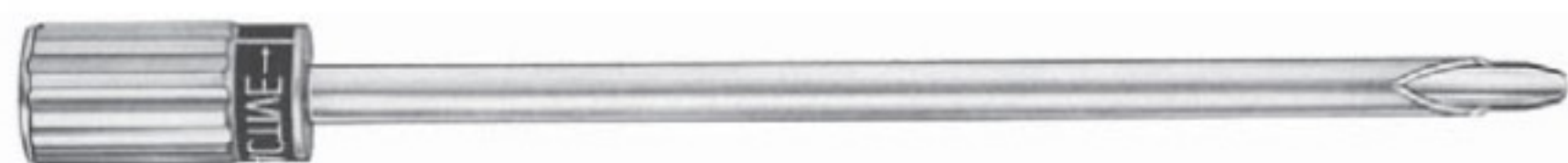

- Ø 5,0 mm XK 763/05
- Ø 5,5 mm XK 763/06
- Ø 10,0 mm XK 763/10
- Ø 11,0 mm XK 763/11
- Ø 12,5 mm XK 763/12



- Ø 5,0 mm XK 765/05
- Ø 8,0 mm XK 765/08
- Ø 10,0 mm XK 765/10
- Ø 11,0 mm XK 765/11
- Ø 12,5 mm
- Ø 15,0 mm
- Ø 20,0 mm



- XK 766/05
- XK 766/08
- XK 766/10
- XK 766/11
- XK 766/12



- XK 766/15
- XK 766/20



- XK 767/05
- XK 767/08
- XK 767/10
- XK 767/11
- XK 767/12
- XK 767/15
- XK 767/20

1
3
5
7
18
22

Anschlusskabel
 Connection cords
 Cables de conexión
 Câbles de raccordement
 Cavi da connessione

monopolar

bipolar



MARTIN / BERCHTOLD

300 cm XR 827/03
 500 cm XR 827/05

XR 828/03
 XR 828/05

XR 830/03
 XR 830/05

monopolar

bipolar

monopolar

bipolar



ERBE
 300 cm XR 831/03
 500 cm XR 831/05
 (ACC/ICC)

ERBE
 XR 831/13
 XR 831/15
 (T-Serie)

ERBE/SELECT
 XR 832/03
 XR 832/05

ERBE
 XR 833/03
 XR 833/05

VALLEYLAB
 XR 834/03
 XR 834/05
 (in D nicht zulässig
 nach MedGV)

Elektroden
Electrodes
Electrodos
Electrodes
Elettrodi

universal



XR 841/01



XR 841/02



XR 841/03



XR 841/04



XR 841/05



XR 841/06



XR 841/07



XR 841/08



XR 841/09



XR 841/10



XR 841/11



XR 841/12

1
3
5
7
18
22

Elektroden
Electrodes
Electrodos
Electrodes
Elettrodi

universal



XR 843/01



XR 843/02



XR 843/03



XR 843/04



XR 843/05



XR 843/06



XR 843/07



XR 843/08



XR 843/09

ENDOSKOPIE ENDOSCOPY ENDOSCOPIA ENDOSCOPIE ENDOSCOPIA

Pinzetten monopolar
 Forceps monopolar
 Pinzas monopolares
 Pincas monopolaires
 Pinze monopolari



14,5 cm/5 ³ / ₄ "			XR 882/15
16,0 cm/6 ¹ / ₄ "			XR 882/16
18,0 cm/7"	XR 880/18		XR 881/18
20,0 cm/8"			XR 882/20
21,0 cm/8 ¹ / ₄ "	XR 880/21		XR 881/21
25,0 cm/10"	XR 880/25		XR 881/25



mit Stecker
 with plug
 con clavija
 avec fiche
 con spina

mit Buchse
 with jack
 con enchufe
 avec douille
 con presa

14,5 cm/5 ³ / ₄ "			XR 885/15			XR 888/15
16,0 cm/6 ¹ / ₄ "			XR 885/16			XR 888/16
18,0 cm/7"	XR 883/18	XR 884/18		XR 886/18		XR 887/18
20,0 cm/8"			XR 885/20			XR 888/20
21,0 cm/8 ¹ / ₄ "	XR 883/21	XR 884/21		XR 886/21		XR 887/21
25,0 cm/10"	XR 883/25	XR 884/25		XR 886/25		XR 887/25

1
3
5
7
18
22

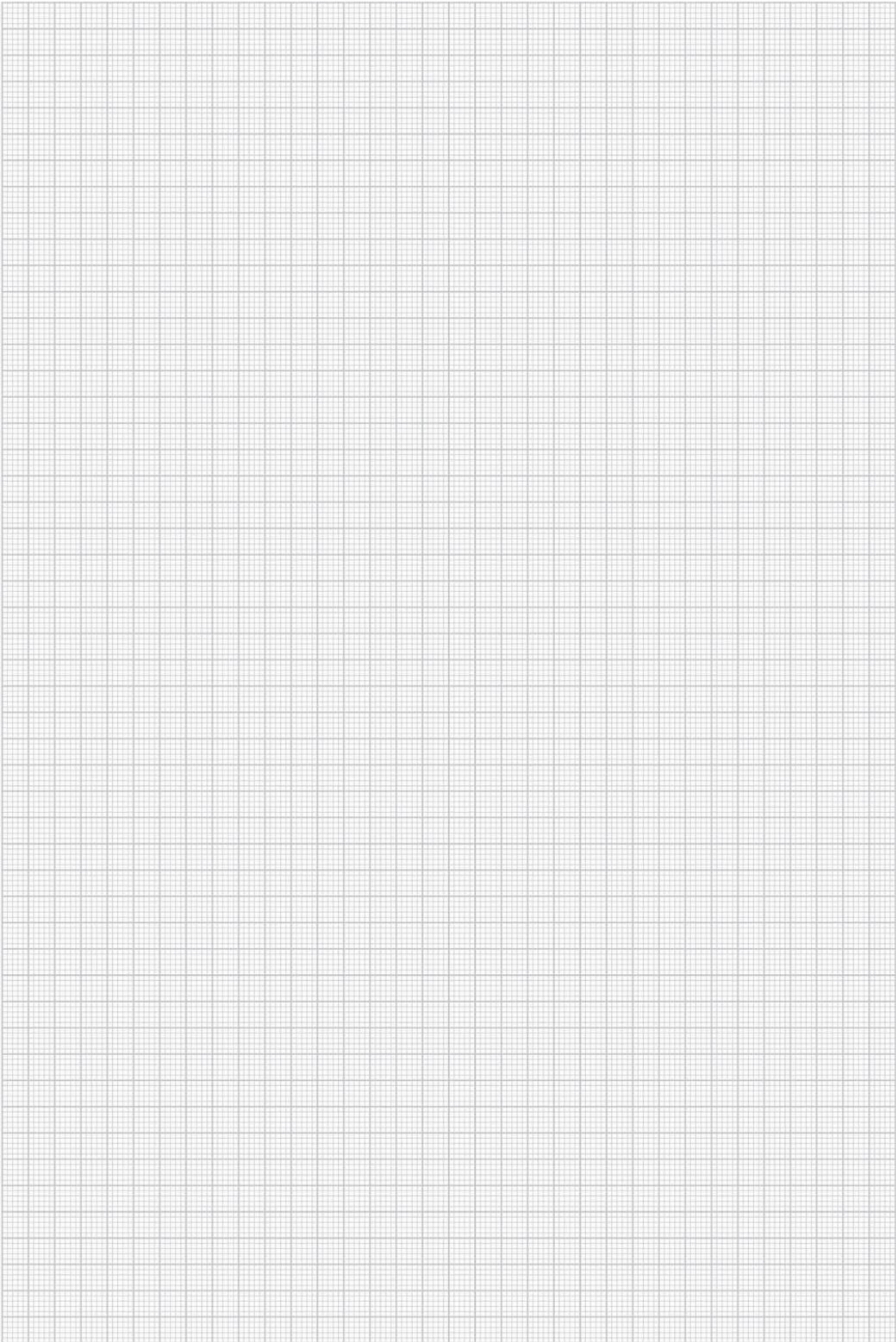

ENDOSKOPIE ENDOSCOPY ENDOSCOPIA ENDOSCOPIE ENDOSCOPIA

Bi-Koagulations-Pinzetten
 Bi-Coagulation-Forceps
 Pinzas para la Bi-Coagulación
 Pince pour la Bi-Coagulation
 Pinze per la Bi-Coagulazione



16,0 cm/6 ¹ / ₄ "	XR 890/16 A	XR 891/16 C	XR 894/16 C		
16,0 cm/6 ¹ / ₄ "	XR 890/16 C	XR 891/16 D	XR 894/16 D		
16,0 cm/6 ¹ / ₄ "	XR 890/16 E	XR 891/16 E	XR 894/16 E		
20,0 cm/8"	XR 890/20 A	XR 891/20 A	XR 894/20 A		
20,0 cm/8"	XR 890/20 C	XR 891/20 C	XR 894/20 C	XR 895/20 C	XR 896/20 C
20,0 cm/8"	XR 890/20 E	XR 891/20 F	XR 894/20 E		
20,0 cm/8"			XR 894/20 F		
22,0 cm/8 ³ / ₄ "	XR 890/22 A	XR 891/22 C	XR 894/22 D		
22,0 cm/8 ³ / ₄ "	XR 890/22 C		XR 894/22 E	XR 895/22 C	XR 896/22 C

A=2,0 mm

C=1,0 mm



D=0,5 mm

E=Nadel

F=Profil



11,0 cm/4 ¹ / ₃ "	XR 898/11 D	XR 899/11 D
11,0 cm/4 ¹ / ₃ "	XR 898/11 E	XR 899/11 E

Kaltlichtkabel
 Fibre optic cable
 Cable fibra óptica
 Câble fibre optique
 Cavo fibra ottica



XT 035/18	Ø 3,5 mm, 180 cm
XT 035/23	Ø 3,5 mm, 230 cm
XT 035/30	Ø 3,5 mm, 300 cm
XT 045/18	Ø 4,5 mm, 180 cm
XT 045/23	Ø 4,5 mm, 230 cm
XT 045/30	Ø 4,5 mm, 300 cm
XT 060/18	Ø 6,0 mm, 180 cm
XT 060/23	Ø 6,0 mm, 230 cm
XT 060/30	Ø 6,0 mm, 300 cm

Kaltlicht-Grundkabel Basic fibre optic cable

- >> Zusätzliche Isolierung
- >> Metallspirale
- >> Silikonmantel
- >> Sterilisierbar
- >> 48-Stunden Reparatur-Service

- >> Additionally insulated
- >> Metal spiral
- >> Silicon tube
- >> Autoclavable
- >> 48-hour repair-service

Adapter
Adapter
Adaptador
Adaptateur
Adattatore

Projektor-Seite
Projector side

Endoskop-Seite
Endoscope side

XT 100/01



STORZ



STORZ/WINTER + IBE
OPLYMPUS/STRYKER

XT 100/11

XT 100/02



WOLF/HENKE-SASS



WOLF/HENKE-SASS

XT 100/12

XT 100/03



ACM/HEINE



ACM/HEINE

XT 100/13

XT 100/04



WINTER + IBE

XT 100/05



OPLYMPUS

Bestellinformation / Ordering information

>> **Bitte bestellen Sie Kaltlichtgrundkabel mit 2 Adaptern**

>> **Please order the basic fibre optic cable and two adapters**

Kaltlichtquellen
Cold light sources
Fuente de luz fria
Source à lumière froide
Sorgente luce fredda

nopa[®] light halogen 2 x 250W future 100



XT 170/00 = 110 - 230 VAC

XT 169/00 = Ersatzlampe
Spare bulb
Bombilla de recambio
Lampe de rechange
Lampadina di ricambio

nopa light halogen 2 x 250W

Beschreibung XT 170/00

Die nopalight halogen 2 x 250 W Lichtquelle kann bei allen Einsätzen angewendet werden, besonders dann, wenn eine starke Ausleuchtung oder eine Videoaufzeichnung notwendig ist.

Alle modernen Autoshutter-Videokameras werden mit ausreichender Lichtzufuhr versorgt. Die zweite Lampe wird als Reserve bei Lampendefekten oder Lampenausfall durch sofortiges Umschalten während den Einsätzen aktiviert.

Spezielle Wärmeschutzfilter sorgen für eine Schonung der Lichtleiter und eine optimale Lichtfiltrierung. Das Gerät ist MedGV-geprüft.

Technische Daten

Elektr. Versorgung:	100-240 VAC/50-60Hz Weltnetzteil
Farbtemperatur:	über 3500° K
Lichtregelung:	automatisch, stufenlos
Maße (B x H x T):	355 x 110 x 320 mm
Gewicht:	ca. 8,5 kg

Zubehör

Lampe XT 169/00: 250 Watt Halogen

nopa light halogen 2 x 250W

Description XT 170/00

The nopalight halogen 2 x 250 W lightsource can be utilized in all procedures, especially if a strong illumination or video-monitoring is required.

All modern autoshutter-videocameras will be supplied with sufficient light-intensity, the second lamp serves as stand-by. Simply switch-over.

Special temperature-filters guarantee long life of light cables and optimal light output. The nopalight halogen 2 x 250 W lightsource is approved by MedGV.

Technical data

Power supply:	100-240 VAC/50-60Hz world power supply
Color temperature:	more than 3500° K
Light control:	automatic
Measurements (W x H x D):	355 x 110 x 320 mm
Weight:	approx. 8,5 kg

Accessories

Bulb XT 169/00: 250 Watt Halogen

Kaltlichtquellen
Cold light sources
Fuente de luz fria
Source à lumière froide
Sorgente luce fredda

nopa[®] light halogen 2 x 250W future 100 duo

XT 171/00	=	110 - 230 VAC
XT 169/00	=	Ersatzlampe Spare bulb Bombilla de recambio Lampe de rechange Lampadina di ricambio



nopa light halogen 2 x 250W

Beschreibung XT 171/00

Die nopalight halogen 2 x 250 W Lichtquelle kann bei allen Einsätzen angewendet werden, besonders dann, wenn eine starke Ausleuchtung oder eine Videoaufzeichnung notwendig ist.

Alle modernen Autoshutter-Videokameras werden mit ausreichender Lichtzufuhr versorgt. Zwei Lampen - zwei umschaltbare Ausgänge.

Spezielle Wärmeschutzfilter sorgen für eine Schonung der Lichtleiter und eine optimale Lichtfiltrierung. Das Gerät ist MedGV-geprüft.

Technische Daten

Elektr. Versorgung:	100-240VAC/50-60Hz Weltnetzteil
Farbtemperatur:	über 3500° K
Lichtregelung:	automatisch, stufenlos
Maße (B x H x T):	355 x 110 x 320 mm
Gewicht:	ca. 8,5 kg

Zubehör

Lampe XT 169/00:	250 Watt Halogen
------------------	------------------

nopa light halogen 2 x 250W

Description XT 171/00

The nopalight halogen 2 x 250 W lightsource, can be utilized in all procedures, especially if a strong illumination or video-monitoring is required.

All modern autoshutter-videocameras will be supplied with sufficient light-intensity, the second lamp serves as stand-by.
Two bulbs - two outlets switchable.

Special temperature-filters guarantee long life of light cables and optimal light output. The nopalight halogen 2 x 250 W lightsource is approved by MedGV.

Technical data

Power supply:	100-240VAC/50-60Hz world power supply
Color temperature:	more than 3500° K
Light control:	automatic
Measurements (W x H x D):	355 x 110 x 320 mm
Weight:	approx. 8,5 kg

Accessories

Bulb XT 169/00:	250 Watt Halogen
-----------------	------------------

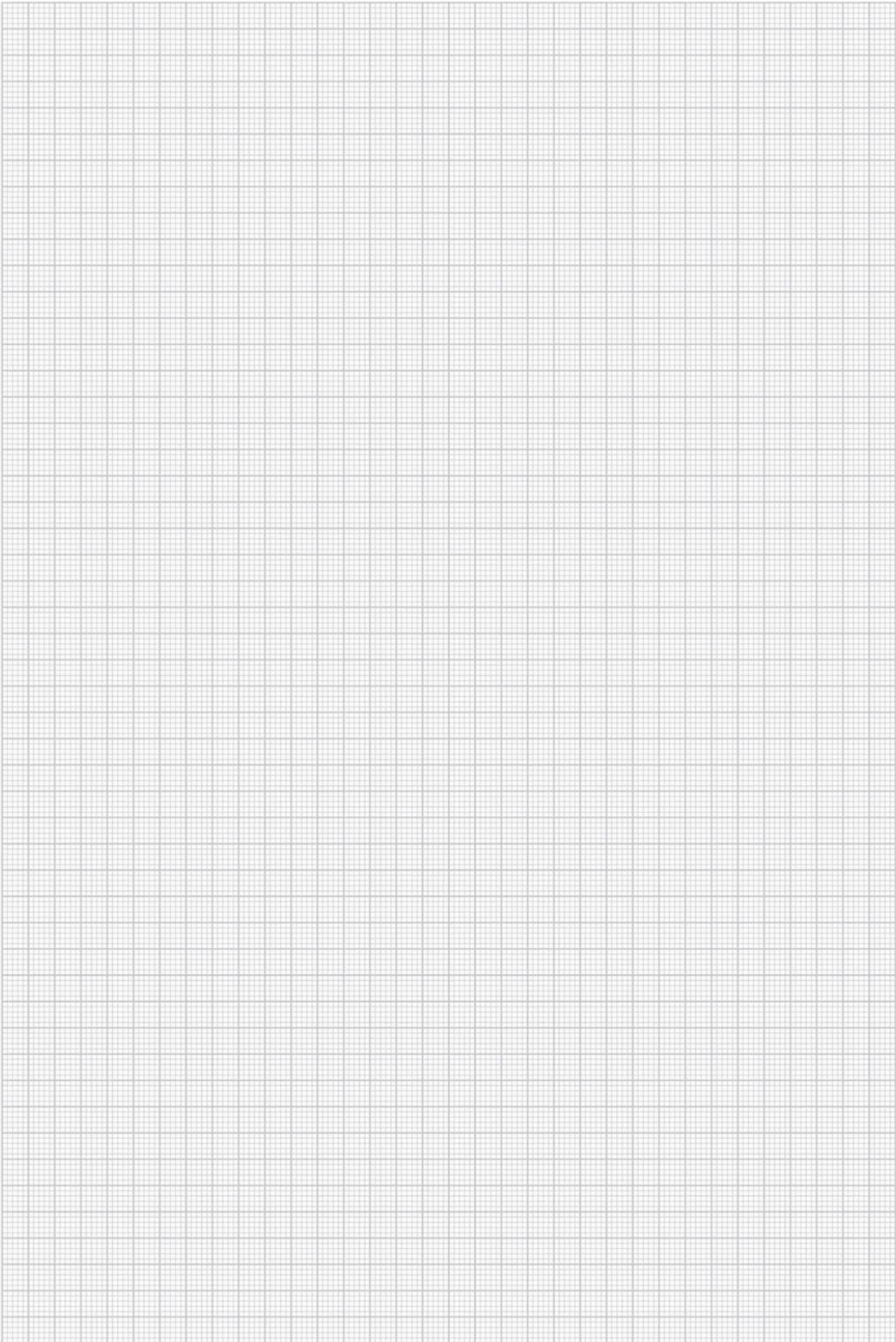

Kaltlichtquellen
Cold light sources
Fuente de luz fria
Source à lumière froide
Sorgente luce fredda

nopa[®] light xenon

future 200

180W

XT 205/00 = 110-230 VAC/50-60 Hz

XT 204/00 = Ersatzlampe
Spare bulb
Bombilla de recambio
Lampe de rechange
Lampadina di ricambio



nopa light xenon 180W

Beschreibung XT 205/00

Die nopalight xenon 180 Watt Lichtquelle kann bei allen Einsätzen angewendet werden, besonders dann, wenn eine starke Ausleuchtung oder eine Videoaufzeichnung notwendig ist.

Alle modernen Autoshutter-Videokameras werden mit ausreichender Lichtzufuhr versorgt. Die hohe Lichtausgangsleistung sorgt für absolut weißes Licht >5600°K und somit für detailgetreue Farbwiedergabe.

Unsere spezielle Lampenkonstruktion mit geringster Wärmeentwicklung führt zu absolut kaltem Licht und verhindert eine thermische Beschädigung der Lichtleiter.

Weitere Vorteile: Geringe Luftverwirbelungen, geringe Geräuschentwicklung, umweltfreundliche Lampe, einfachster Lampenwechsel.

Technische Daten

Elektr. Versorgung: 110-230 VAC/50-60Hz
Weltnetzteil

Farbtemperatur: > 5600° K

Maße
(B x H x T): 355 x 110 x 320 mm

Gewicht: ca. 9,5 kg

Zubehör

Lampe XT 204/00: 180 Watt Xenon

nopa light xenon 180W

Description XT 205/00

The nopalight xenon 180 watt light source can be used for all occasions particularly where strong illumination or a video recording is necessary.

All modern autoshutter videocameras are supplied with sufficient light. The high light output ensures absolute white light >5600° K and thus detail fidelity in colour reproduction.

Our special lamp construction which has the lowest of heat generation leads to absolute cold light and prevents thermal damage to the light conductor.

Further advantages are low air turbulence, low noise level, environmentally friendly lamp and very easy bulb replacement.

Technical data

Power supply: 110-230 VAC/50-60Hz
world power supply

Colour temperature: > 5600° K

Measurements
(W x H x D): 355 x 110 x 320 mm

Weight: approx. 9,5 kg

Accessories

Bulb XT 204/00: 180 Watt Xenon

Kaltlichtquellen
Cold light sources
Fuente de luz fria
Source à lumière froide
Sorgente luce fredda

nopa[®] light xenon future 300 300W



XT 210/00 = 110-230 VAC/50-60 Hz

XT 209/00
Ersatzlampe
Spare bulb
Bombilla de recambio
Lampe de rechange
Lampadina di ricambio

nopa light xenon 300 W

Beschreibung XT 210/00

Die nopalight xenon 300 Watt Lichtquelle kann bei allen Einsätzen angewendet werden, besonders dann, wenn eine starke Ausleuchtung oder eine Videoaufzeichnung notwendig ist.

Alle modernen Autoshutter-Videokameras werden mit ausreichender Lichtzufuhr versorgt. Die hohe Lichtausgangsleistung sorgt für absolut weißes Licht >5600°K und somit für detailgetreue Farbwiedergabe.

Unsere spezielle Lampenkonstruktion mit geringster Wärmeentwicklung führt zu absolut kaltem Licht und verhindert eine thermische Beschädigung der Lichtleiter.

Weitere Vorteile: Geringe Luftverwirbelungen, geringe Geräuschentwicklung, umweltfreundliche Lampe, einfachster Lampenwechsel.

Technische Daten

Elektr. Versorgung: 110-230VAC/50-60Hz
Weltnetzteil

Farbtemperatur: > 5600° K

Maße
(B x H x T): 355 x 110 x 320 mm

Gewicht: ca. 11,5 kg

Zubehör

Lampe XT 209/00: 300 Watt Xenon

nopa light xenon 300 W

Description XT 210/00

The nopalight xenon 300 watt light source can be used for all occasions particularly where strong illumination or a video recording is necessary.

All modern video camera automatic shutters are supplied with sufficient light. The high light output ensures absolute white light > 5600° K and thus detail fidelity in colour reproduction.

Our special lamp construction which has the lowest of heat generation leads to absolute cold light and prevents thermal damage to the light conductor.

Further advantages are low air turbulence, low noise level, environmentally friendly lamp and very easy bulb replacement.

Technical data

Power supply: 110-230VAC/50-60Hz
world power supply

Colour temperature: > 5600° K

Measurements
(W x H x D): 355 x 110 x 320 mm

Weight: approx. 11,5 kg

Accessories

Bulb XT 209/00: 300 Watt Xenon

nopa[®] cam digital camera system

immersible soakable

PAL/SECAM		
XT 301/00	=	XT 310/00 Netzka- bel/mains cord
		XT 320/01 Kamerakopf inkl. Kabel 3,8 m, einlegbar camera head incl. cable 3,8 m, immersible
		XT 320/02 Kameraprozessor / camera control unit
		XT 344/02 Kabel/cable S-VHS
		XT 346/00 Kabel/cable BNC
NTSC		
XT 301/01	=	XT 310/00 Netzka- bel/mains cord
		XT 320/03 Kamerakopf inkl. Kabel 3,8 m, einlegbar camera head incl. cable 3,8 m, immersible
		XT 320/04 Kameraprozessor/camera control unit
		XT 344/00 Kabel/cable S-VHS
		XT 346/00 Kabel/cable BNC



Beschreibung XT 301/00 / XT 301/01

nopa cam m ist die konsequente Weiterentwicklung unseres Kamerasystems. Neben allen früheren Funktionen wurden weitere Spezialfunktionen realisiert. Eine integrierte Steuerung externer Geräte (Videorecorder, Drucker) sowie die Lichtverstärkung können mittels zwei Funktionstasten direkt am Kamerakopf aktiviert werden.

Die Kamera ist mit digitaler Kontrast- und Farbsteuerung ausgestattet. Ebenfalls verfügt sie über einen digitalen anti-moiré Filter für den Gebrauch mit flexiblen Endoskopen.

Die Kamera arbeitet optimal mit starren wie auch flexiblen Endoskopen. Selbstverständlich ist der Kamerakopf einlegbar.

Technische Daten

XT 301/00 PAL - XT 301/01 NTSC

CCD Sensor:	1/3" Chip
Video-Auflösung:	750 horizontale Bildlinien
Minimale Beleuchtung:	0,9 Lux
Video-Ausgang:	FBAS oder Y/C (S-VHS)
Elektr. Versorgung:	100/115VAC und 230/240VAC
Gewicht:	2 kg

Weiteres Zubehör

XT 301/02 Kamera mit C-Mount Gewinde PAL
 XT 301/03 Kamera mit C-Mount Gewinde NTSC
 XT 306/00 Bildteiler

XT 361/40 Zoom Adapter 15 - 25 mm
 XT 361/50 Zoom Adapter 25 - 40 mm
 verwendbar mit XT 301/02 und XT 301/03

Description XT 301/00 / XT 301/01

nopa cam m is the consequent improvement of our camera system. Besides all the previous functions further special functions have been realized. An integrated control of peripheral devices (VCR, printer), as well as the Gain Control can be operated with the help of two buttons directly from the camera head.

Our camera is equipped with digital contrast and colour control and a digital anti-moiré filter for use with flexible endoscopes.

The camera serves both rigid and flexible endoscopes optimally. Of course the camera head is fully immersible.

Technical data

XT 301/00 PAL - XT 301/01 NTSC

CCD sensor:	1/3" Chip
Video resolution:	750 horizontal lines
Minimal illumination:	0,9 Lux
Video output:	FBAS or Y/C (S-VHS)
Power supply:	100/115VAC and 230/240VAC
Weight:	2kg

Optional accessories

XT 301/02 camera with C-mount adapter PAL
 XT 301/03 camera with C-mount adapter NTSC
 XT 306/00 beam splitter

XT 361/40 Zoom adapter 15 - 25 mm
 XT 361/50 Zoom adapter 25 - 40 mm
 to use with XT 301/02 and XT 301/03

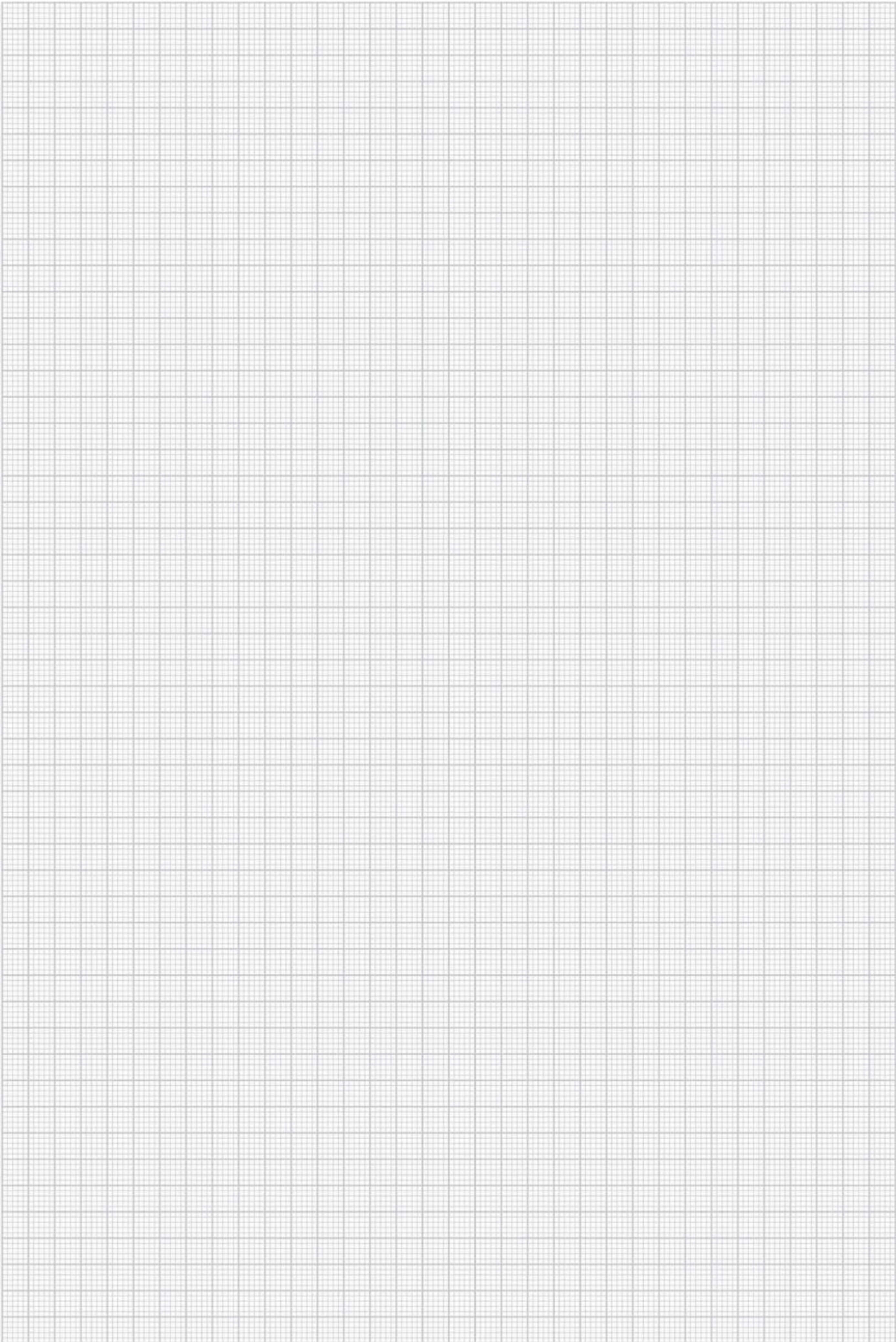

nopa[®] cam digital camera system

immersible soakable 3 - chip

PAL/SECAM

XT 305/00	=	XT 310/00	Netzkabel/mains cord
		XT 320/05	Kamerakopf inkl. Kabel 4,0 m, einlegbar/ camera head incl. cable 4,0 m, immersible
		XT 330/05	Kameraprozessor/camera control unit
		XT 340/05	Objektiv/Objective lens
		XT 344/05	Kabel/cable S-VHS
		XT 365/25	Adapter, Optomech. Microfocus 28 mm (C-Mount)

NTSC

XT 305/01	=	XT 310/00	Netzkabel/mains cord
		XT 325/05	Kamerakopf inkl. Kabel 4,0 m, einlegbar/ camera head incl. cable 4,0 m, immersible
		XT 335/05	Kameraprozessor/camera control unit
		XT 340/05	Objektiv/Objective lens
		XT 344/05	Kabel/cable S-VHS
		XT 365/28	Adapter, Optomech. Microfocus 28 mm (C-Mount)



Beschreibung XT 305/00 / XT 305/01

Das nopa cam camera system future 500 ist ein hochentwickeltes 3-Chip Kamerasystem und für alle endoskopischen Eingriffe einsetzbar.

Ausgezeichnete Bildqualität, scharfe Bildzeichnung und Klarheit werden durch die drei 1/3" CCD-Chips gewährleistet.

Die optimale Bilddarstellung aufgrund eines hochempfindlichen Mikro-Linsen-Chip sowie einer äußerst schnellen Blende wird auch unter schwierigsten Beleuchtungsbedingungen sichergestellt. Der leichte, kompakte Kamerakopf ist äußerst ergonomisch und einlegbar. Alle Adapter und Coupler mit einem C-Mount-Gewinde können angeschlossen werden. Der automatische Weißabgleich wird durch Schalterdruck aktiviert und ist im Memory gespeichert.

Zusätzlich bietet das System eine "window"-Funktion um unter extremen Lichtverhältnissen eine gute Bilddarstellung zu garantieren. Größe und Einstellung dieses Spezial-Focus werden über den Druckschalter aktiviert und auf dem Monitor angezeigt.

Aufgrund des hohen Automatisierungsstandards der nopa cam future 500 ist das Kamerasystem sehr bedienerfreundlich. Kamerakopf und Kabel sind einlegbar.

Technische Daten

XT 305/00 PAL - XT 305/01 NTSC

CCD Sensor:	3 x 1/3" Chip (3 x 440000 pixel)
Video-Auflösung:	über 750 Linien
Elektronische Blende:	max. 1/2000000 sec.
Minimale Beleuchtung:	3 Lux F1.4
Video Ausgang:	FBAS, Y/C (S-VHS), RGB
Elektr. Versorgung:	110/115VAC - und 230/240VAC
Gewicht:	3,5 kg

Weiteres Zubehör

- XT 365/15 Adapter optomechanisch microfocus 15 mm
- XT 365/21 Adapter optomechanisch microfocus 21 mm
- XT 365/35 Adapter optomechanisch microfocus 35 mm
- XT 364/10 Microfocus-Adapter, flexibel Pentax
- XT 366/10 Microfocus-Adapter, flexibel Olympus
- XT 368/10 Microfocus-Adapter, flexibel Fujinon

Bei Bestellung bitte Netzspannung angeben.

Description XT 305/00 / XT 305/01

The nopa cam camera system future 500 is a highly developed three chip camera system which can be used for all operations performed with endoscopes. Excellent picture quality, sharp picture delineation and clarity are guaranteed by the three 1/3" CCD chips.

Optimal picture presentation is ensured by a highly sensitive micro-lens chip with an extremely rapid diaphragm even under difficult lighting conditions. The light, compact camera head is ergonomic and immersible. All adapters and couplings with a C-mount thread can be connected. The automatic white compensation is activated by press button and is stored in the memory.

The system additionally offers a "window" function to ensure a good picture representation under extreme lighting conditions. The magnitude and setting of this special focus are activated by press button and displayed on the monitor screen.

The nopa cam future 500's high standard of automatic operation makes this camera system extremely easy to operate. The camera head and cable can be immersed.

Technical data

XT 305/00 PAL - XT 305/01 NTSC

CCD sensor:	3 x 1/3" chip (3x 440000 pixel)
Video resolution:	more than 750 lines
Electronic shutter:	max. 1/2000000 sec.
Minimal illumination:	3 Lux F1.4
Video output:	FBAS, Y/C (S-VHS), RGB
Power supply:	110/115VAC - and 230/240VAC
Weight:	3,5 kg

Optional accessories

- XT 365/15 Adapter optomechanical microfocus 15 mm
- XT 365/21 Adapter optomechanical microfocus 21 mm
- XT 365/35 Adapter optomechanical microfocus 35 mm
- XT 364/10 Microfocus-adapter, flexible Pentax
- XT 366/10 Microfocus-adapter, flexible Olympus
- XT 368/10 Microfocus-adapter, flexible Fujinon

Please indicate the voltage when placing the order.

Gelenkarmsystem mit zentraler Schnellfixierung
 Articulated arm with quick central fixation
 Sistema de brazo articulado con fijación rápida central
 Système de bras articulé avec fixage rapide central
 Sistema a braccio articolato con fissaggio rapido centrale

Halterungen
 Holding fixtures

Gelenkarm
 Articulated arm

Säulen
 Columns

Klemmsockel
 Clamping socket



Komplett kurz / short complete

XU 650/01 = XU 650/13
 XU 650/40
 XU 651/01
 XU 651/12

Komplett lang / long complete

XU 650/02 = XU 650/13
 XU 650/55
 XU 651/02
 XU 651/12

Zubehör auf der Rückseite
 Accessories reverse side

Gelenkarmsystem mit zentraler Schnellfixierung
 Articulated arm with quick central fixation
 Sistema de brazo articulado con fijación rápida central
 Système de bras articulé avec fixation rapide central
 Sistema a braccio articolato con fissaggio rapido centrale

**Halterungen
 Holders**



XU 650/11
 Kombi Instrumentenhalter
 Combined Instrument holder



XU 650/12
 Ø 4 mm Optikhalter
 Ø 4 mm Optic holder



XU 650/13
 Ø 5 mm/10 mm Optikhalter
 Ø 5 mm/10 mm Optic holder



XU 650/14
 Ø 8 mm Optikhalter
 Ø 8 mm Optic holder

**Gelenkarme
 Articulated arms**

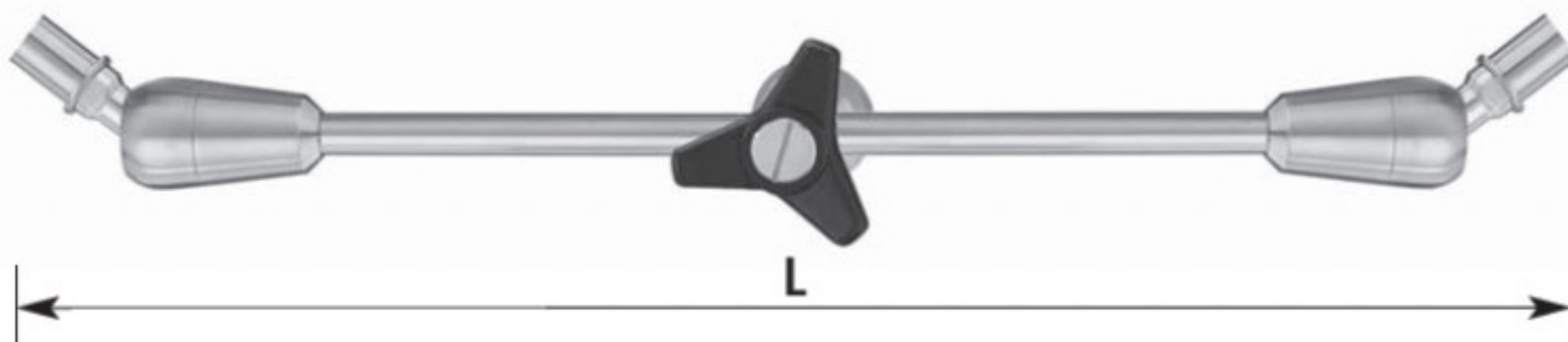

XU 650/40
 L = 400 mm M8/M12x1 Ø 16 mm

XU 650/55
 L = 550 mm M8/M12x1 Ø 16 mm

**Säulen
 Columns**



XU 651/01 Ø 16 mm 300 mm
 XU 651/02 Ø 16 mm 400 mm



XU 651/03
 Ø 16 mm 450 mm x 100 mm



XU 651/04
 Ø 16 mm 266 x 300 x 116 mm

**Klemmsockel
 Clamping socket**



XU 651/11
 Universalsockel
 Universal clamp



XU 651/12
 Schienensockel
 Rails clamping socket



XU 651/13
 Isolierter Schienensockel
 Insulated rails clamping socket

1
3
5
7
18