

nopa[®] instruments

neurochirurgie

neurosurgery

neurocirugía

neurochirurgie

neurochirurgia



INDEX

>> Klemmen >> Hemostats >> Pinzas hemostáticas >> Pincas hémostatiques >> Pinze emostatiche	11–14	AA
>> Pinzetten >> Forceps >> Pinzas >> Pincas >> Pinze	15–24	AB
>> Scheren >> Scissors >> Tijeras >> Ciseaux >> Forbici	24–38	AC
>> Naht >> Suture >> Sutura >> Suture >> Sutura	39–46	AE
>> Wundhaken >> Retractors >> Separadores >> Ecarteurs >> Divaricatori	47–58	AK
>> Punktion/Kanülen >> Puncture/Special Needles >> Punción/Agujas especiales >> Punction/Aiguilles spéciales >> Puntura/Aghi speciali	59–60	AO
>> Diagnostik >> Diagnostics >> Diagnóstico >> Diagnostic >> Diagnostica	61–64	AR
>> Orthopädie >> Orhtopaedics >> Ortopedia >> Orthopédie >> Ortopedia	65–84	KA
>> Neurochirurgie >> Neurosurgery >> Neurocirugía >> Neurochirurgie >> Neurochirurgia	85–170	KS
>> Endoskopie >> Endoscopy >> Endoscopia >> Endoscopie >> Endoscopia	171–174	XR
>> Endoskopie >> Endoscopy >> Endoscopia >> Endoscopie >> Endoscopia	175–180	XT

KLEMMEN
HEMOSTATS
PINZAS HEMOSTATICAS
PINCES HEMOSTATIQUES
PINZE EMOSTATICHE

AA

nopa[®] instruments



Kopfhautklemmen
 Scalp Flap Forceps
 Pinzas hemostáticas para pericráneo
 Pincés hémostatiques pour le cuir chevelu
 Pinze emostatiche per il cuoio capelluto

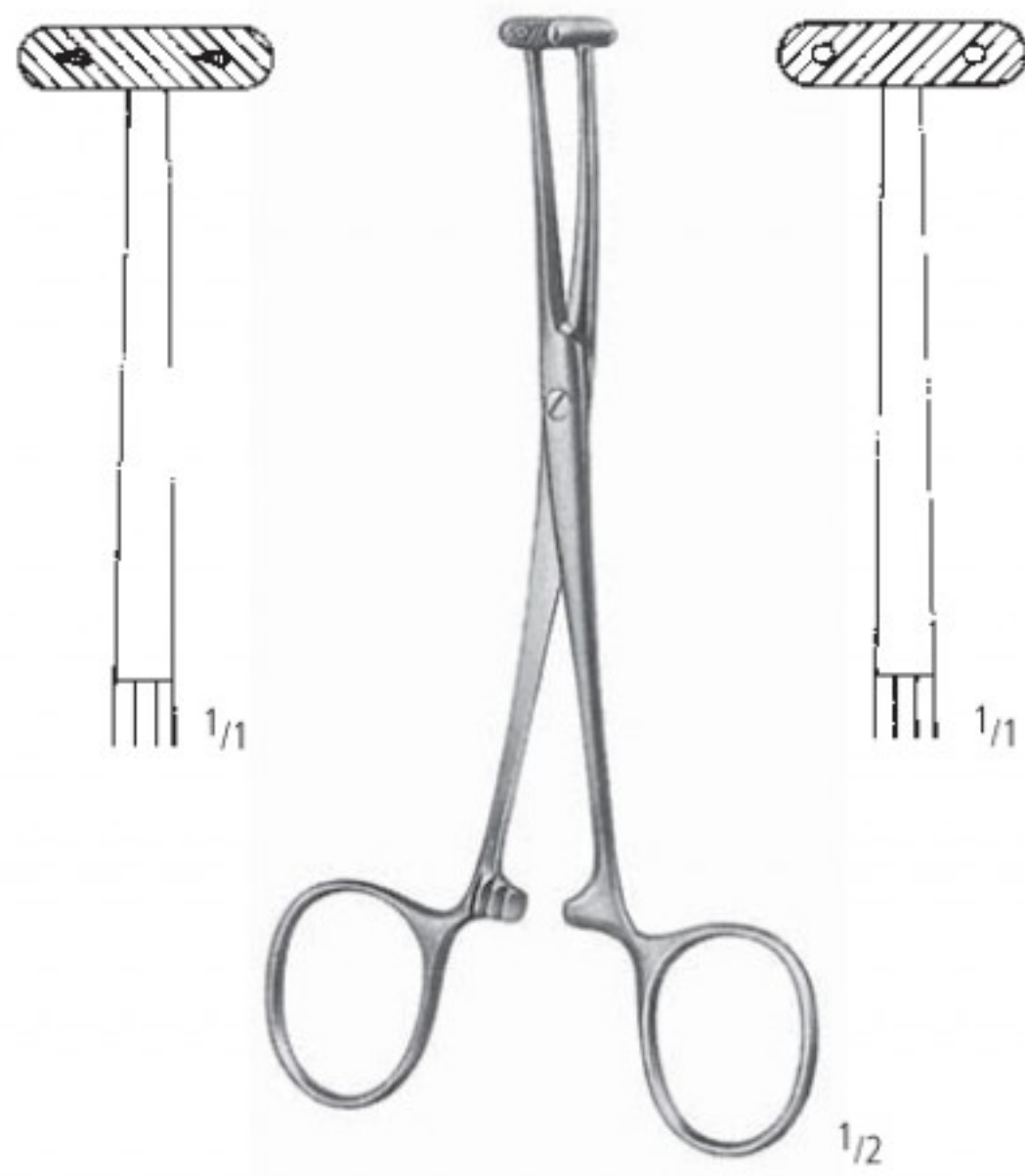

MARTEL
 AA 078/14
 14,0 cm/5¹/₂"

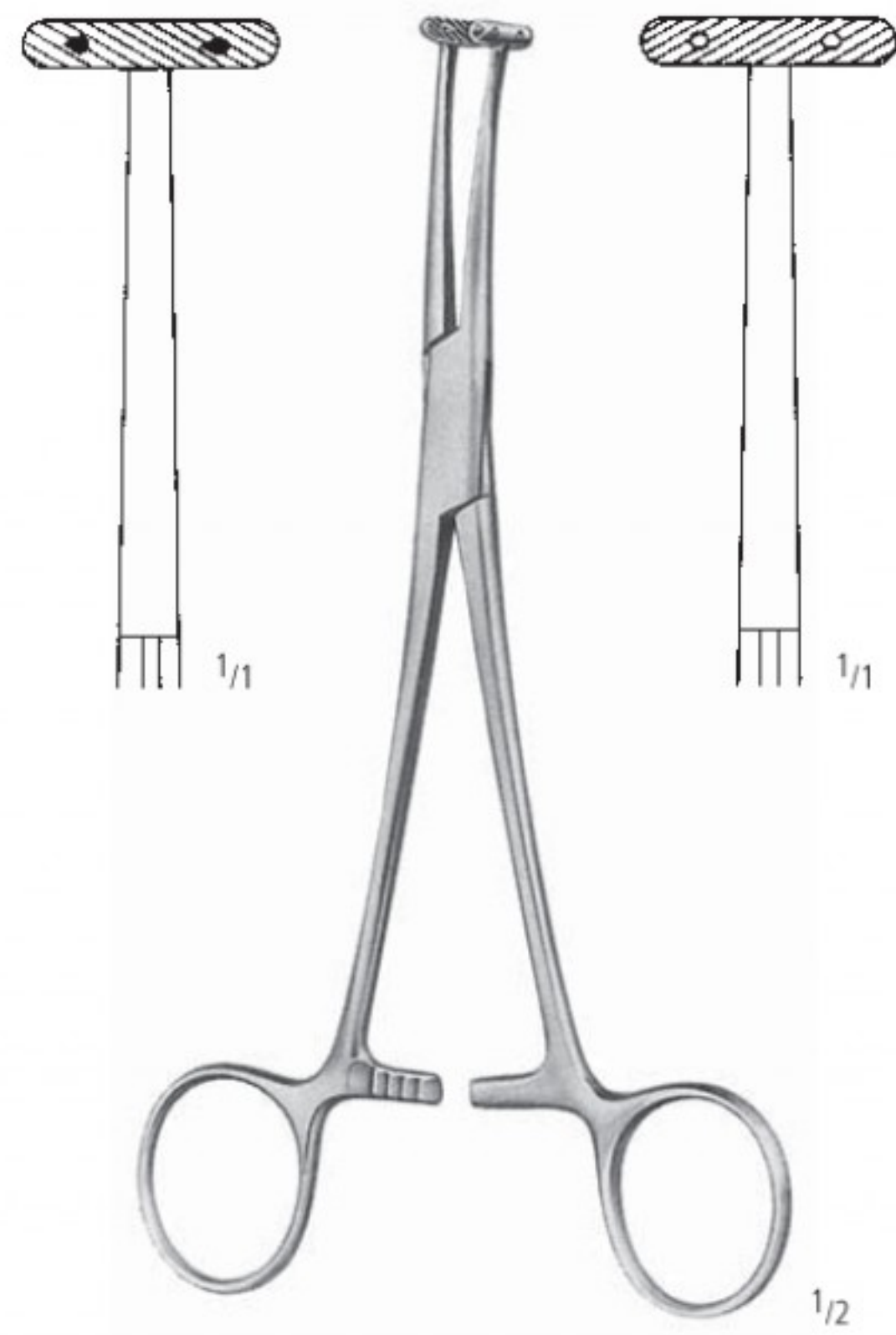

WILLET-MARTEL
 AA 078/19
 19,0 cm/7¹/₂"

Feine Arterienklemmen
 Fine Artery Forceps
 Pinzas hemostáticas finas
 Pincas hémostatiques fines
 Pinze emostatiche fine

AA

AB

AC

AE

AK

AO

AR

KA

KS

XR

XT

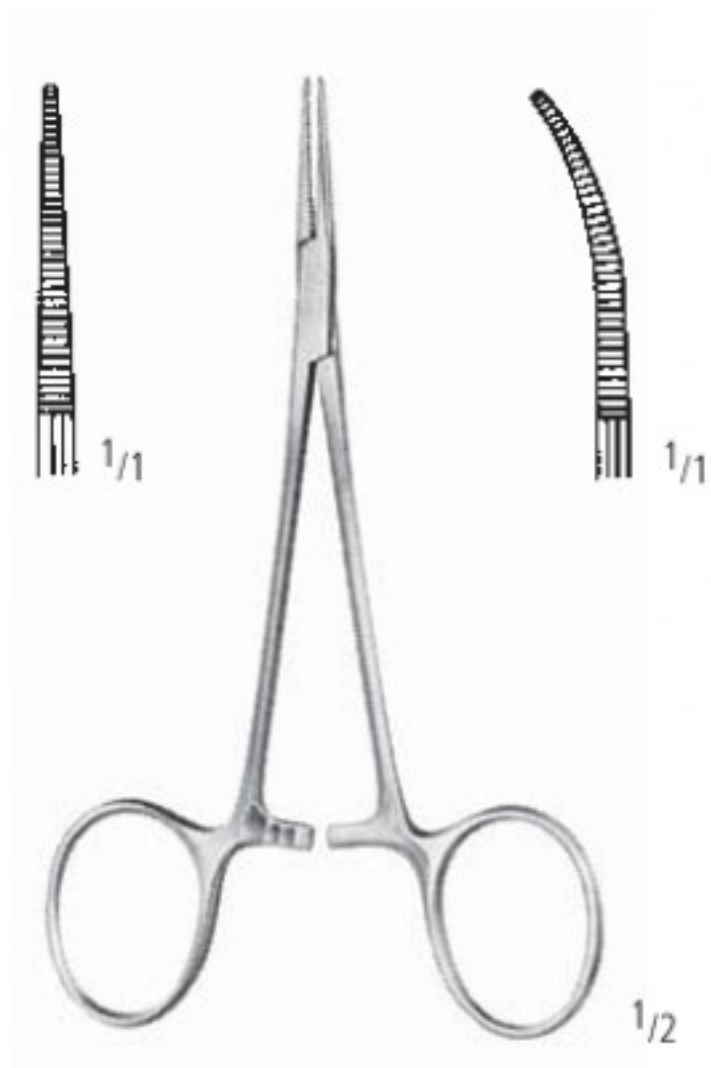

MICRO-MOSQUITO

AA 130/10 AA 131/10
 AA 130/12 AA 131/12

10,0 cm/4"
 12,0 cm/4³/₄"

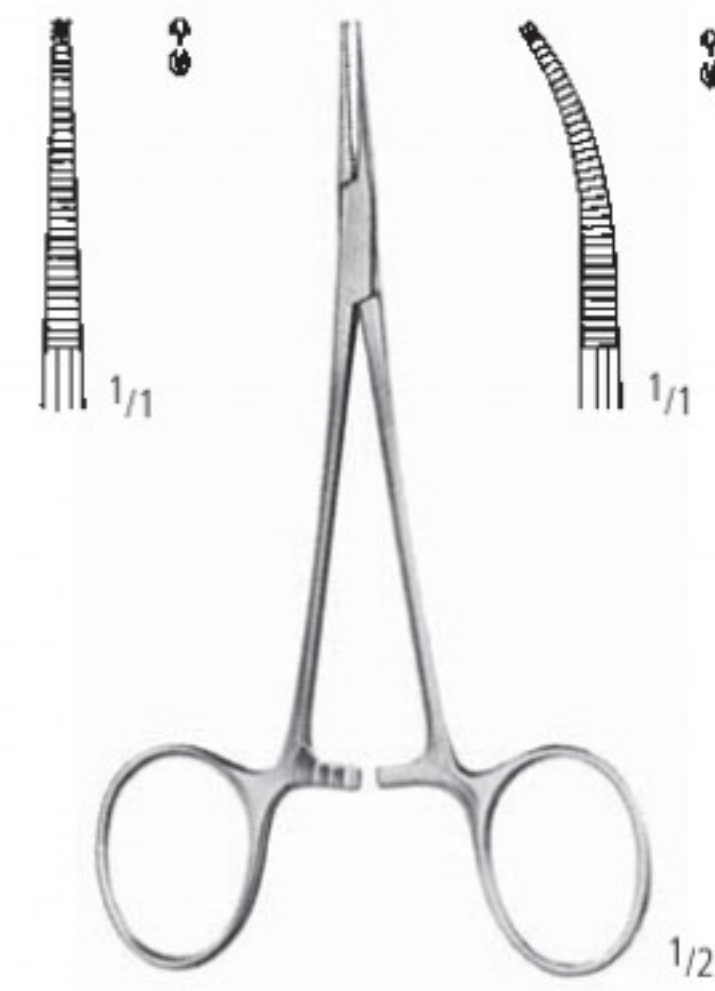

MICRO-MOSQUITO 1:2

AA 132/10 AA 133/10
 AA 132/12 AA 133/12



BABY-OVERHOLT

AA 225/13
 13,5 cm/5¹/₄"



BABY-ADSON

AA 235/14
 14,0 cm/5¹/₂"

Präparierklemmen
Dissecting Forceps
Pinzas para preparaciones
Pinces à dissection
Pinze per preparazione

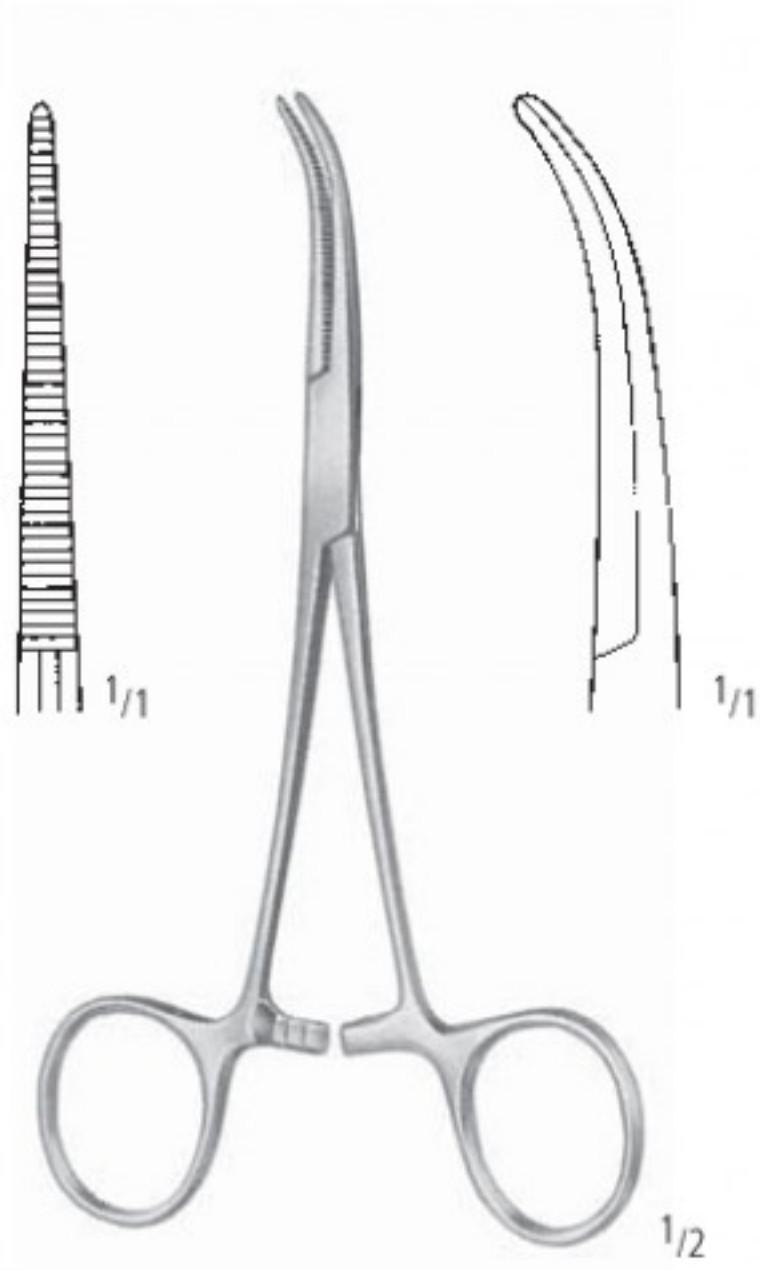

DANDY
AA 291/14
14,0 cm/5 1/2"

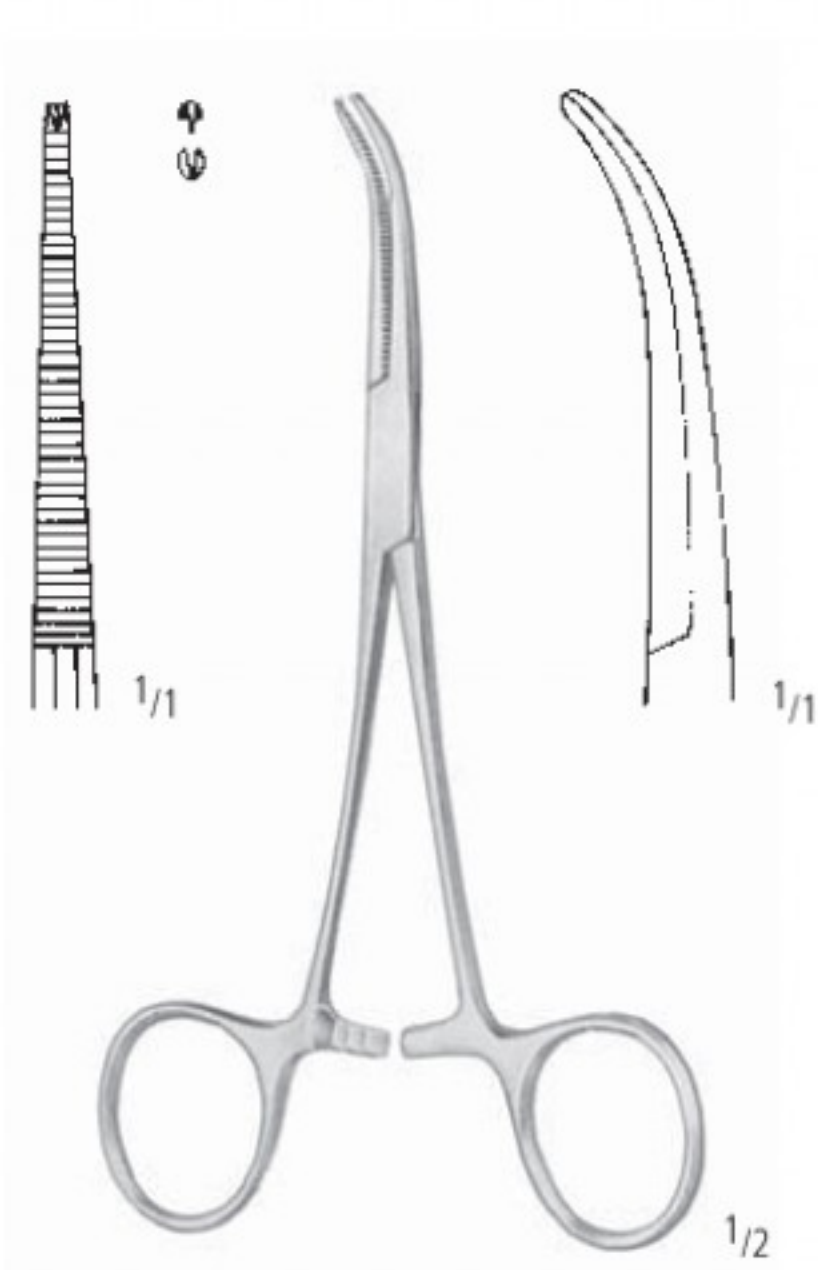

DANDY 1:2
AA 293/14
14,0 cm/5 1/2"



BABY-MIXTER
14,0 cm/5 1/2"



GEMINI

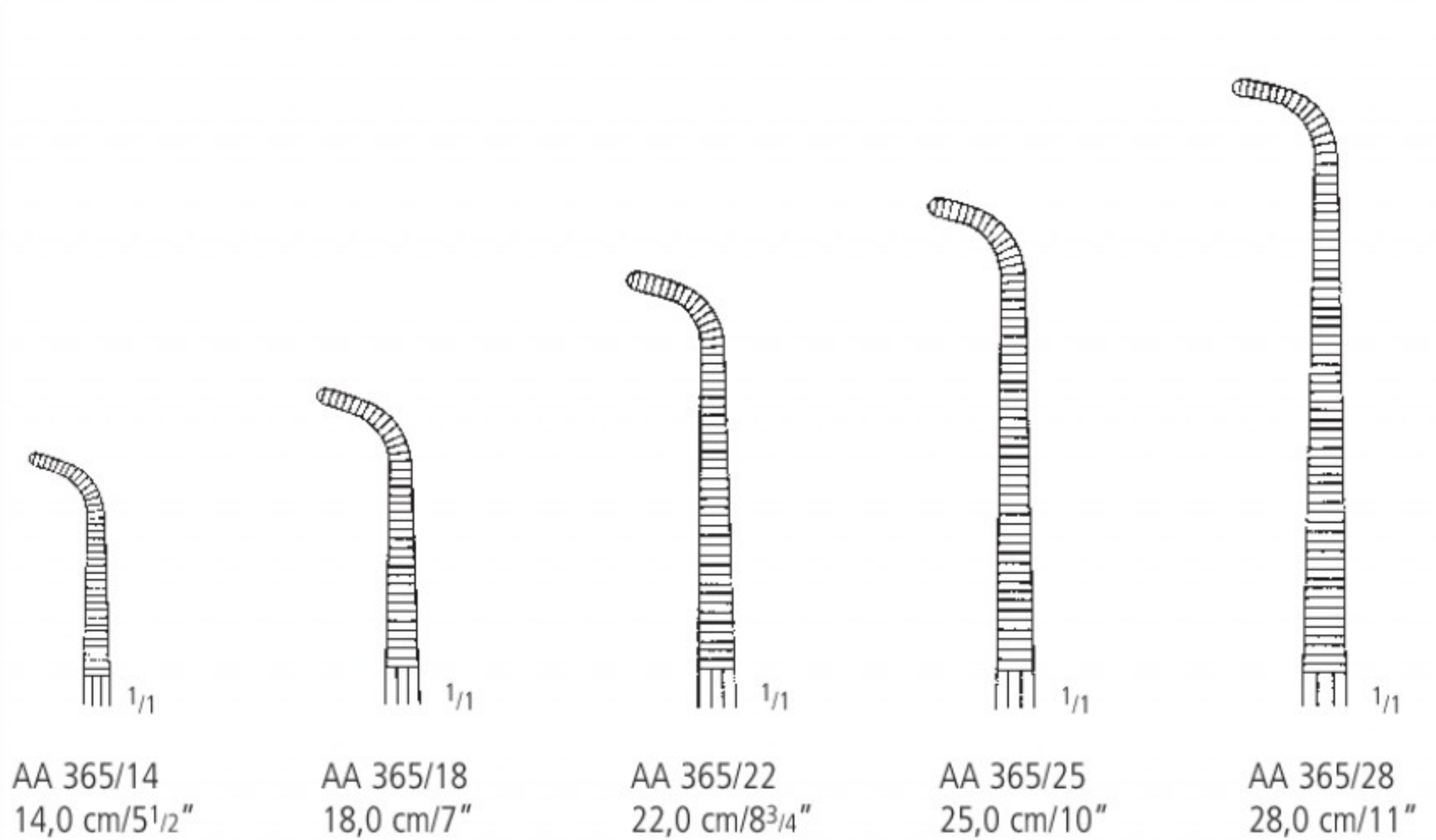

AA 365/14
14,0 cm/5 1/2"

AA 365/18
18,0 cm/7"

AA 365/22
22,0 cm/8 3/4"

AA 365/25
25,0 cm/10"

AA 365/28
28,0 cm/11"

Weitere Klemmen siehe Katalog A 7-51 und Gruppe KS.
For further hemostats see catalogue A 7-51 and section KS.
Para otras pinzas hemostáticas ver catálogo A 7-51 y sección KS.
D'autres pinces hémostatiques voir notre catalogue A 7-51 et groupe KS.
Per altre pinze emostatiche consultare il nostro catalogo A 7-51 e gruppo KS.

PINZETTEN
FORCEPS
PINZAS
PINCES
PINZE

AB

nopa[®] instruments



AB PINZETTEN FORCEPS PINZAS PINCES PINZE

Anatomische Pinzetten, Chirurgische Pinzetten
 Dressing Forceps, Tissue Forceps
 Pinzas de disección, Pinzas de disección con dientes
 Pincés à dissection, Pincés à griffes
 Pinze anatomiche per dissezione, Pinze chirurgiche a denti di topo

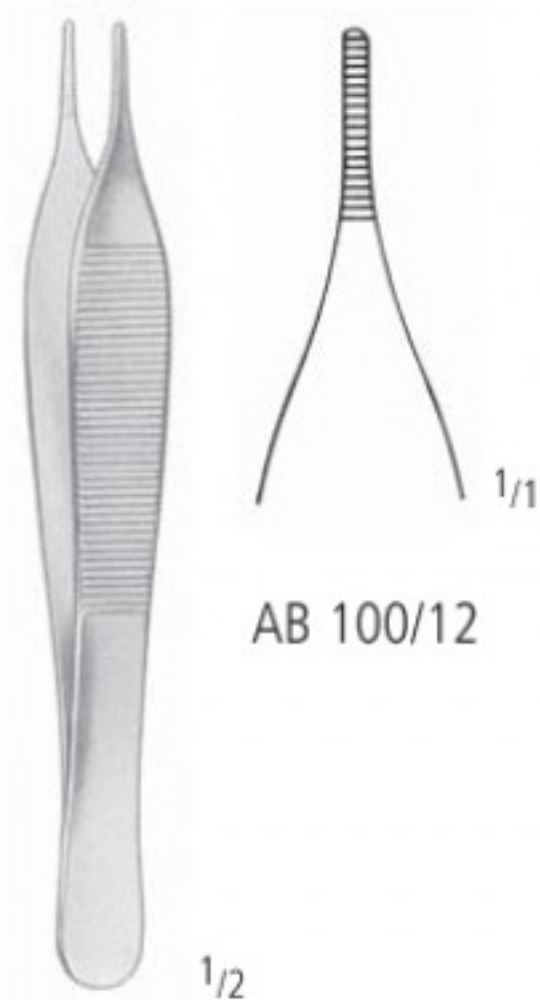

AB 100/12



AB 102/12

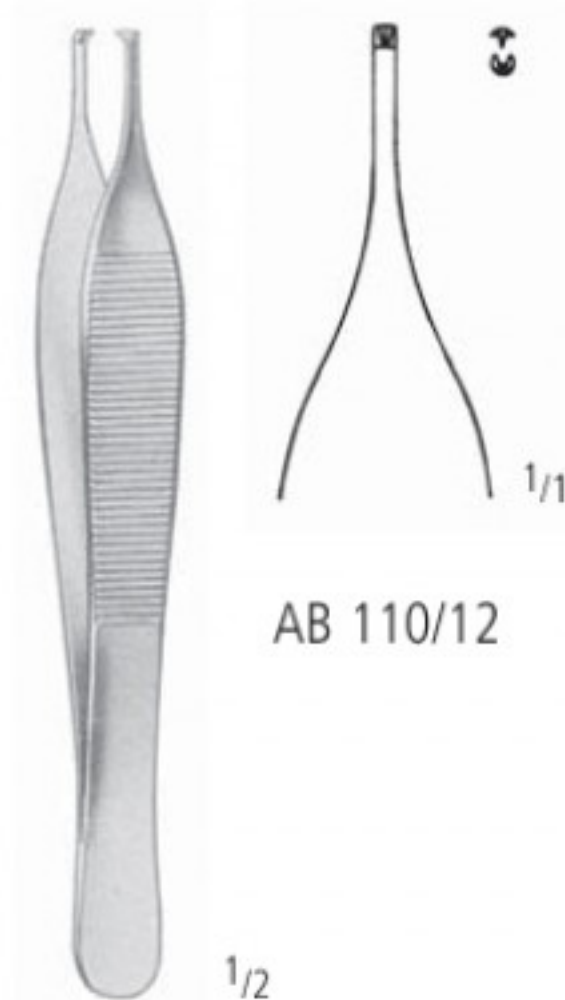

AB 110/12

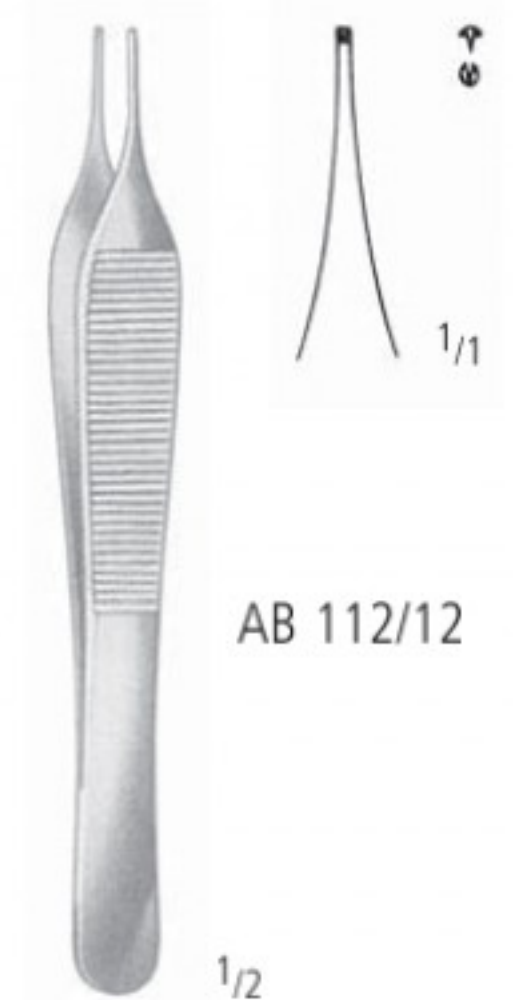

AB 112/12

12,0 cm/4³/₄"
 15,0 cm/6"

ADSON
 AB 100/12
 AB 100/15

MICRO-ADSON
 AB 102/12
 AB 102/15

ADSON 1:2
 AB 110/12
 AB 110/15

MICRO-ADSON 1:2
 AB 112/12
 AB 112/15

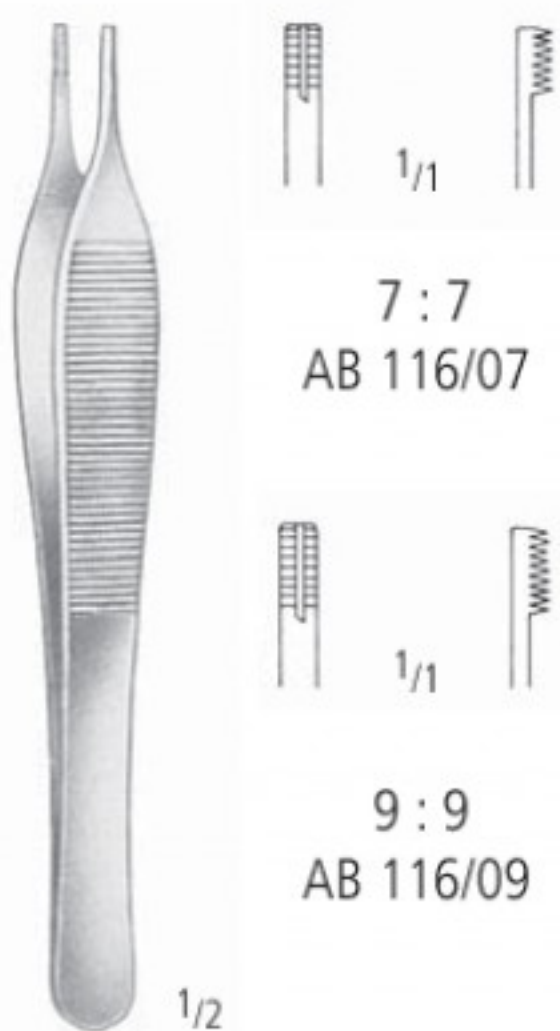

7 : 7
 AB 116/07

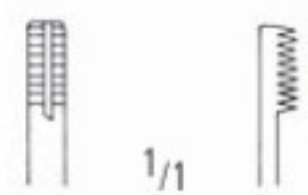

9 : 9
 AB 116/09

ADSON-BROWN

12,0 cm/4³/₄"



9 : 9

ADSON-BROWN

AB 117/09
 12,0 cm/4³/₄"

PINZETTEN FORCEPS PINZAS PINCES PINZE

Anatomische Pinzetten, Chirurgische Pinzetten
 Dressing Forceps, Tissue Forceps
 Pinzas de disección, Pinzas de disección con dientes
 Pincés à dissection, Pincés à griffes
 Pinze anatomiche per dissezione, Pinze chirurgiche a denti di topo

AA

AB

AC

AE

AK

AO

AR

KA

KS

XR

XT



CUSHING
AB 180/17

17,5 cm/7"



CUSHING
AB 181/17



CUSHING 1:2
AB 190/17

17,5 cm/7"



CUSHING 1:2
AB 191/17

AB PINZETTEN FORCEPS PINZAS PINCES PINZE

Uhrmacherpinzetten
 Jeweler's Forceps
 Pinzas de relojero
 Pincés d'horloger
 Pinze da orologiaio



No. 1 AB 501/01
 12,0 cm/4³/₄"



No. 2 AB 501/02
 12,0 cm/4³/₄"



No. 3 AB 501/03
 12,0 cm/4³/₄"



No. 4 AB 501/04
 11,0 cm/4¹/₂"



No. 5 AB 501/05
 11,0 cm/4¹/₂"



No. 5a AB 501/15
 11,0 cm/4¹/₂"



No. 5/45° AB 501/45
 10,5 cm/4"



No. 5/90° AB 501/90
 10,5 cm/4"



No. 7 AB 502/07
 11,5 cm/4¹/₂"

PINZETTEN FORCEPS PINZAS PINCES PINZE

Fasspinzetten
Grasping Forceps
Pinzas para coger
Pinces pour saisir les tissus
Pinze per afferrare tessuti



AB 506/01
Ø 3,0 mm

AB 506/02
Ø 3,0 mm

SAMII
24,0 cm/9¹/₄"



AB 507/01
Ø 3,0 mm

AB 507/02
Ø 5,0 mm

Löffel
spoon
cucharilla
cuiller
cucchiaio

AB 508/01
Ø 3,0 mm

AB 508/02
Ø 5,0 mm

flach
flat
plano
plat
piatto

22,0 cm/8³/₄"

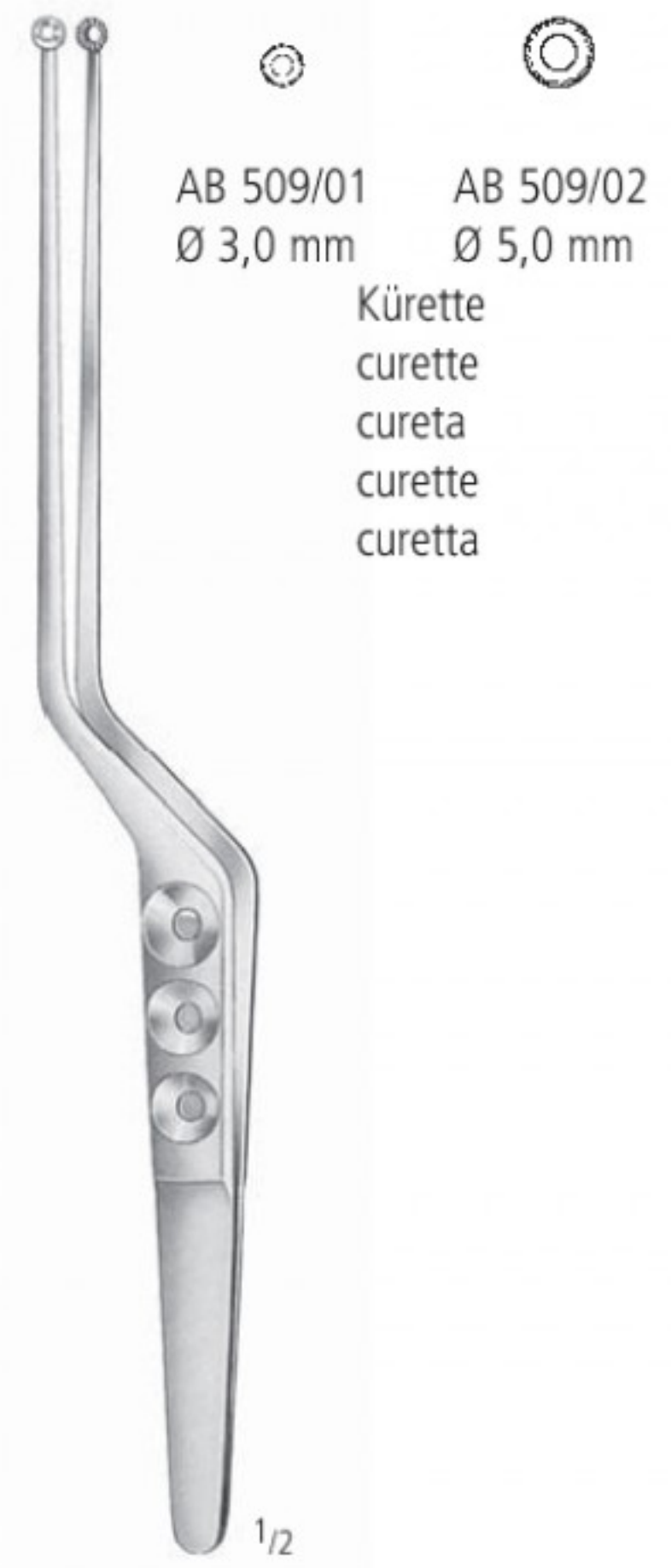

AB 509/01
Ø 3,0 mm

AB 509/02
Ø 5,0 mm

Kürette
curette
cureta
curette
curetta

HEIFETZ
22,0 cm/8³/₄"



HUNT
AB 510/20
20,0 cm/8"

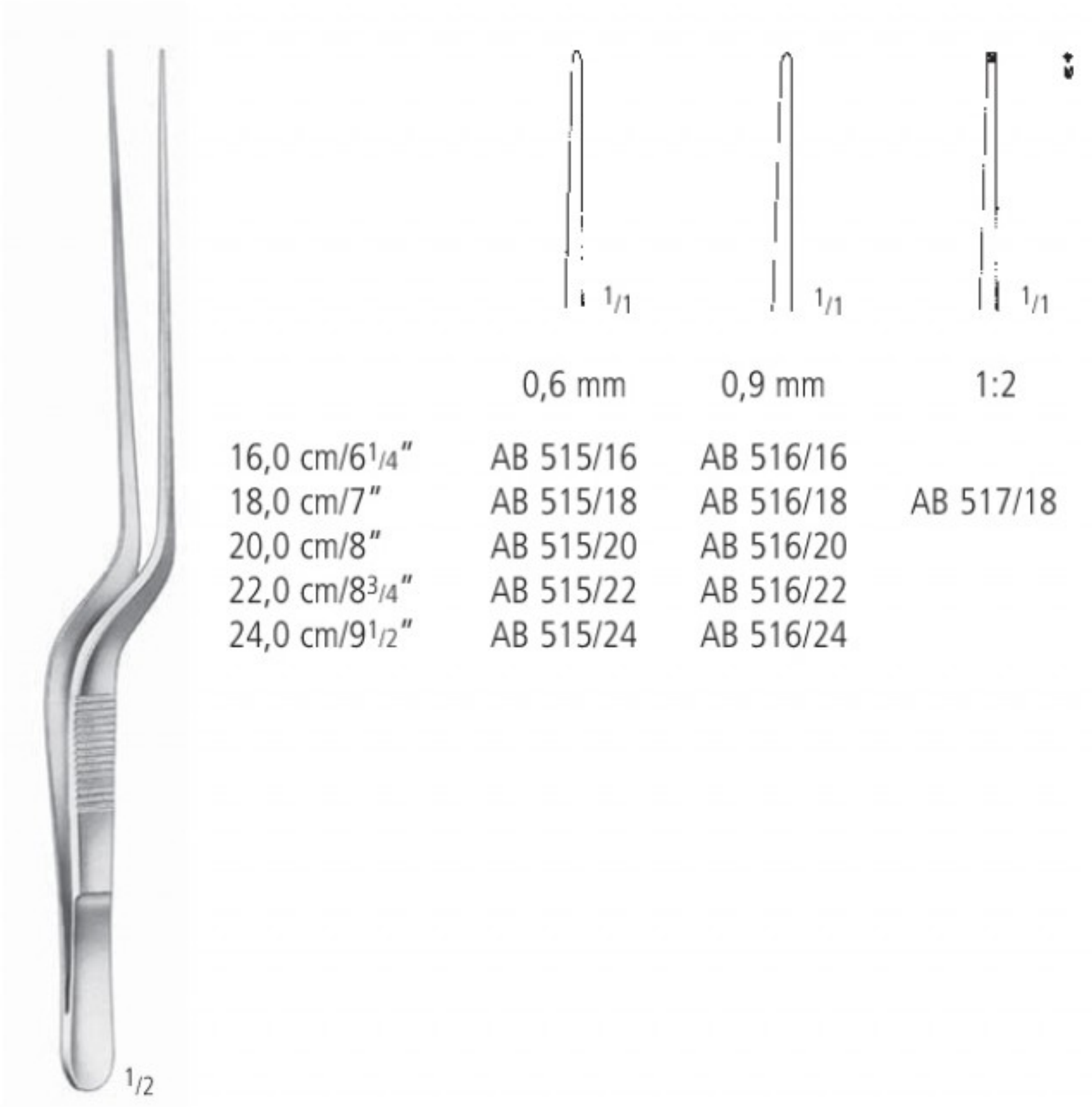

16,0 cm/6¹/₄"

18,0 cm/7"

20,0 cm/8"

22,0 cm/8³/₄"

24,0 cm/9¹/₂"

0,6 mm

0,9 mm

1:2

AB 515/16

AB 515/18

AB 515/20

AB 515/22

AB 515/24

AB 516/16

AB 516/18

AB 516/20

AB 516/22

AB 516/24

AB 517/18

AA
AB
AC
AE
AK
AO
AR
KA
KS
XR
XT

AB PINZETTEN FORCEPS PINZAS PINCES PINZE

Mikro-Pinzetten, Knüpfpinzetten mit Plateau
 Micro Forceps, Suture Tying Forceps with platform
 Micro-Pinzas, Pinzas de ligadura con plataforma
 Micro-Pinces, Pinces à ligature avec plate-forme
 Micro-Pinze, Pinze per ligature con piattaforma

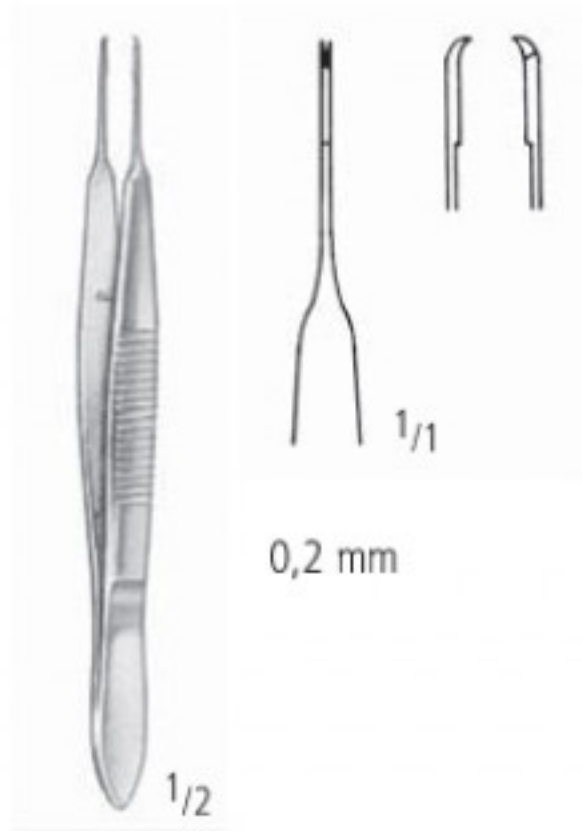

AB 530/09 1:2
 9,5 cm/3³/₄"

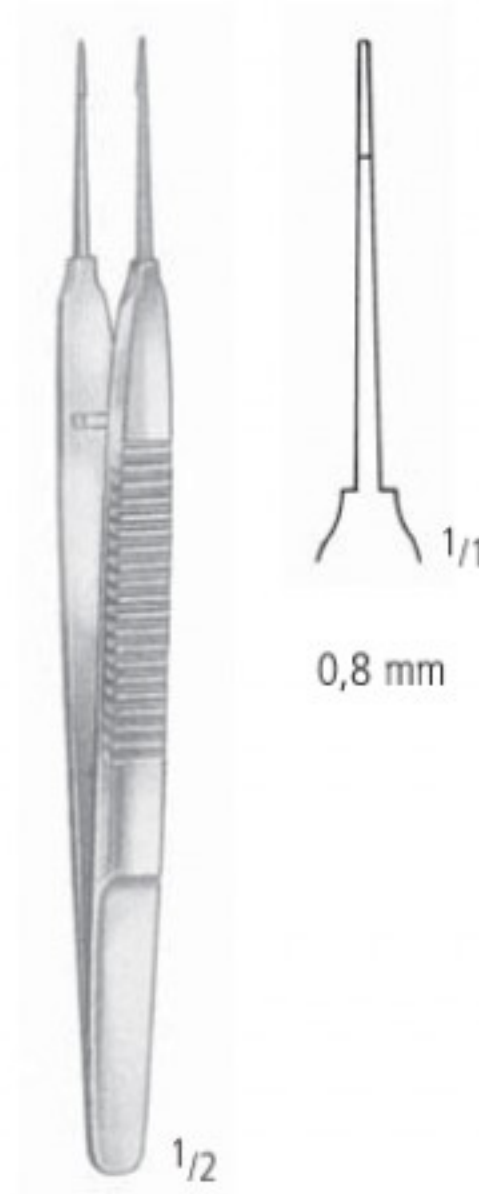

AUSTIN
 AB 532/14
 14,0 cm/5¹/₂"

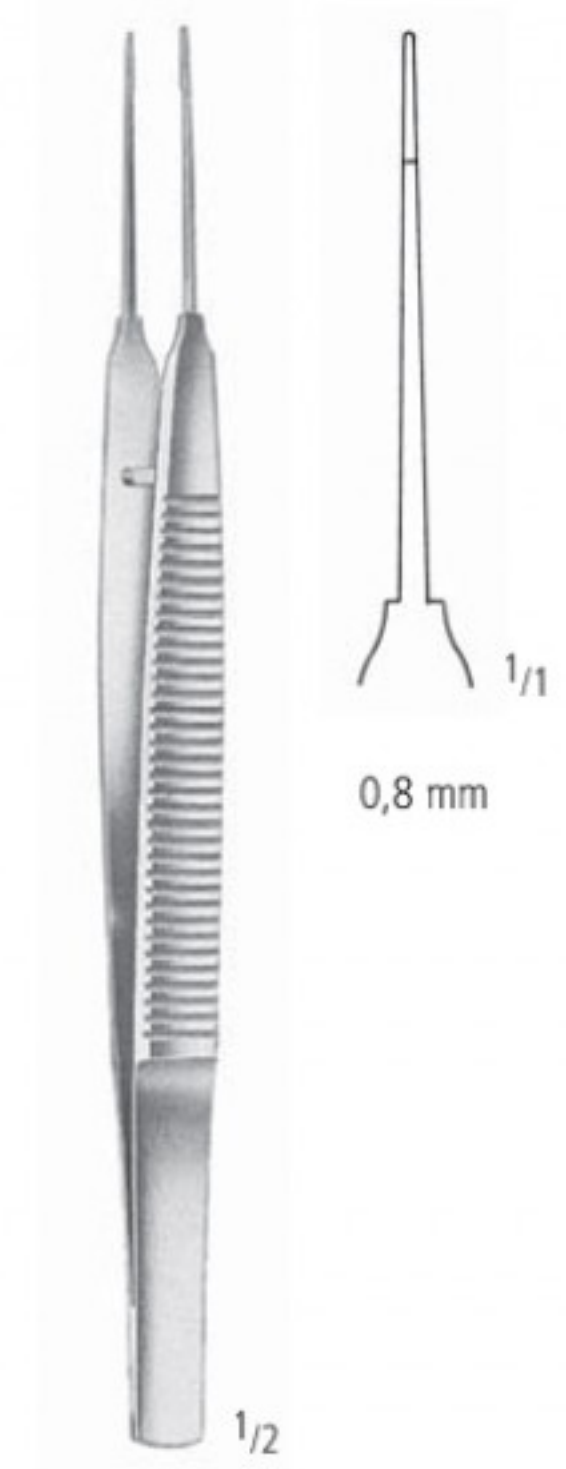

AUSTIN
 AB 532/18
 18,0 cm/7"

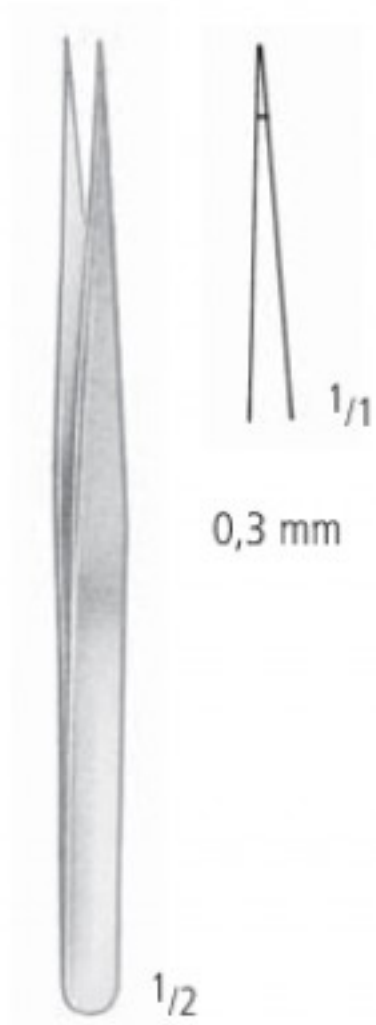

AB 534/12
 12,0 cm/4³/₄"



VISE
 AB 534/13
 13,5 cm/5¹/₄"

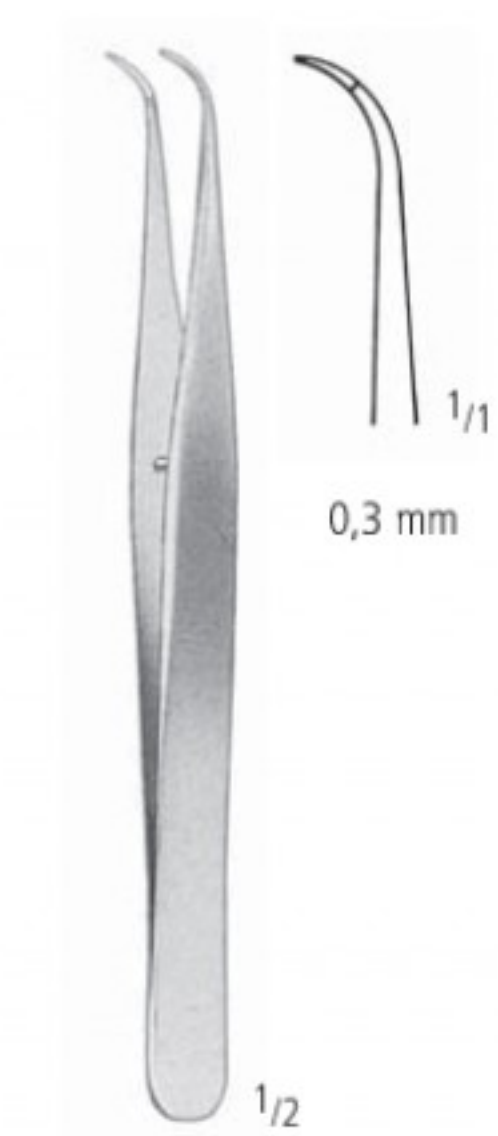

VISE
 AB 535/13
 13,5 cm/5¹/₄"

PINZETTEN FORCEPS PINZAS PINCES PINZE

Mikro-Pinzetten, Knüpfpinzetten mit Plateau
 Micro Forceps, Suture Tying Forceps with platform
 Mircro-Pinzas, Pinzas de ligadura con plataforma
 Micro-Pinces, Pinces à ligature avec plate-forme
 Micro-Pinze, Pinze per ligature con piattaforma

AA

AB

AC

AE

AK

AO

AR

KA

KS

XR

XT



AB 536/14
 14,0 cm/5 1/2"



AB 538/14 **1:2**
 14,0 cm/5 1/2"



AB 540/14 **1:2**
 14,0 cm/5 1/2"

AB PINZETTEN FORCEPS PINZAS PINCES PINZE

Mikro-Pinzetten
 Micro Forceps
 Micro-Pinzas
 Micro-Pinces
 Micro-Pinze



12,0 cm/4³/₄"
 15,0 cm/6"



AB 542/12
 AB 542/15



AB 543/12
 AB 543/15



18,0 cm/7"



AB 544/18

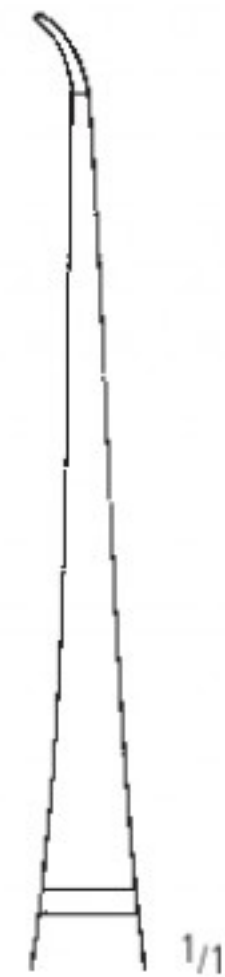

AB 545/18

Weitere Mikro-Pinzetten siehe Gruppe KS.
 For further micro forceps see section KS.
 Para otras micro-pinzas ver sección KS.
 D'autres micro-pinces voir groupe KS.
 Altre micro-pinze vedi gruppo KS.

PINZETTEN FORCEPS PINZAS PINCES PINZE

Atraumatische Pinzetten
 Non-traumatic Vascular Tissue Forceps
 Pinzas Atrauma
 Pincas Atrauma
 Pinze Atrauma

AA

AB

AC

AE

AK

AO

AR

KA

KS

XR

XT

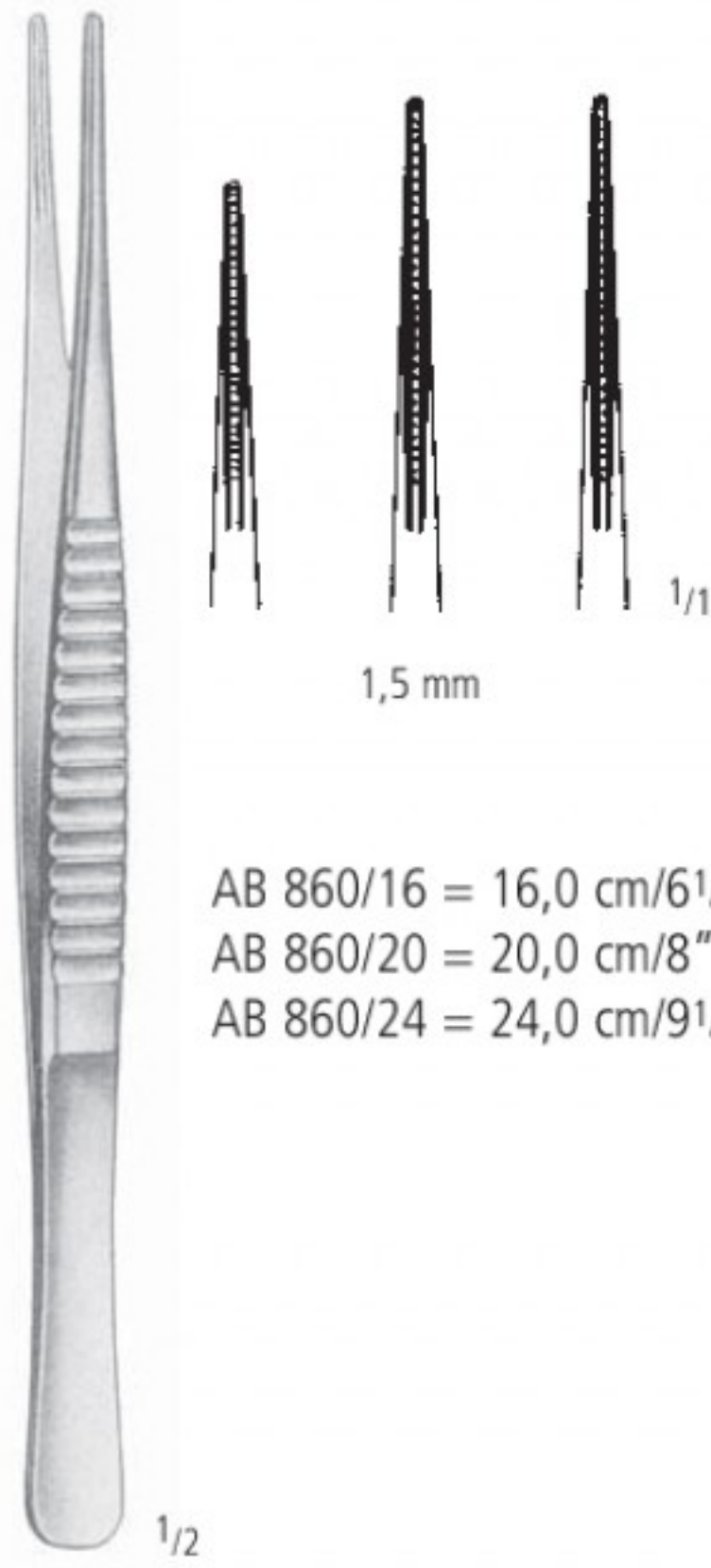

1,5 mm

AB 860/16 = 16,0 cm/6¹/₄"
 AB 860/20 = 20,0 cm/8"
 AB 860/24 = 24,0 cm/9¹/₄"

1/2

DE BAKEY

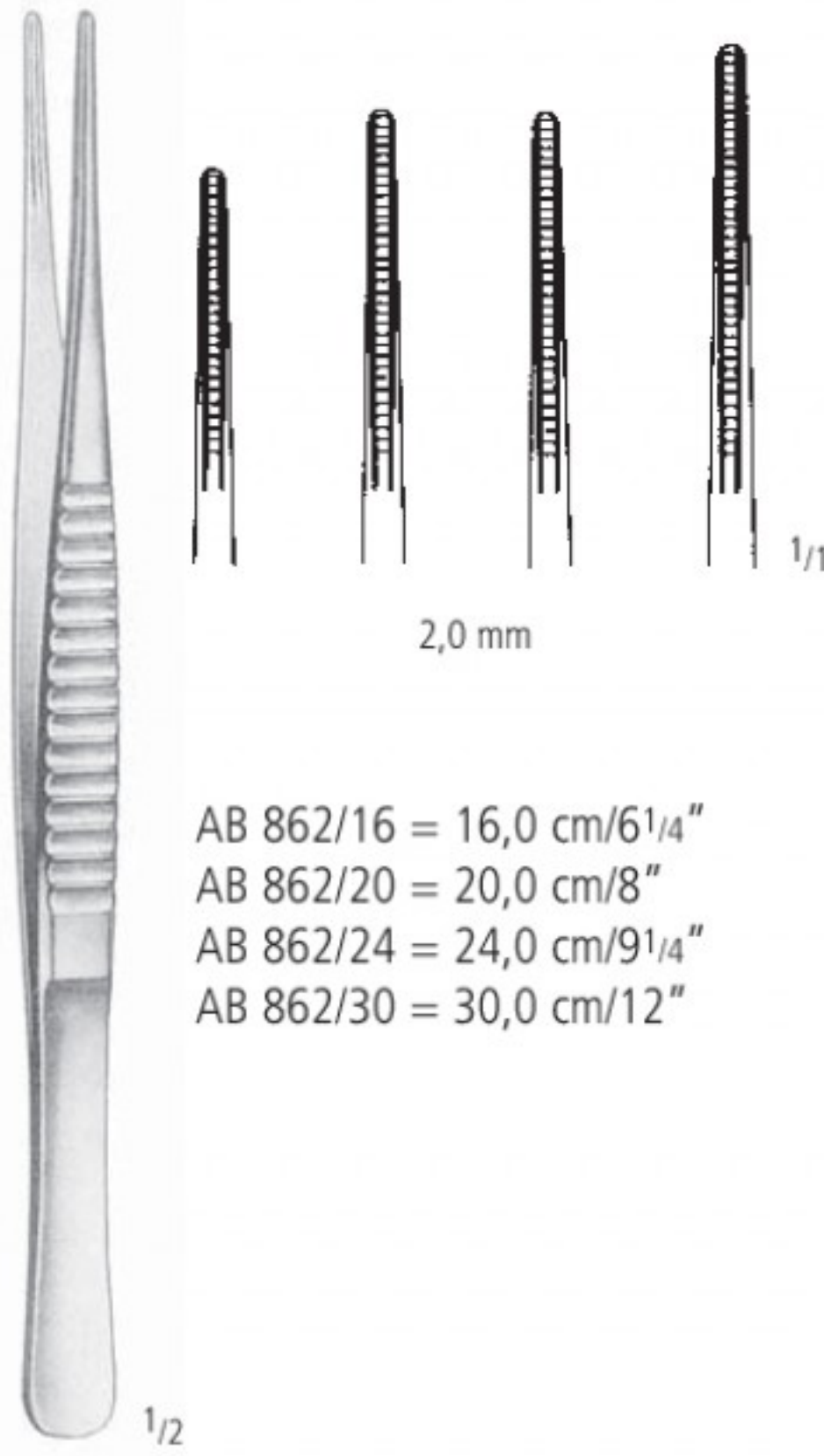

2,0 mm

AB 862/16 = 16,0 cm/6¹/₄"
 AB 862/20 = 20,0 cm/8"
 AB 862/24 = 24,0 cm/9¹/₄"
 AB 862/30 = 30,0 cm/12"

1/2

DE BAKEY

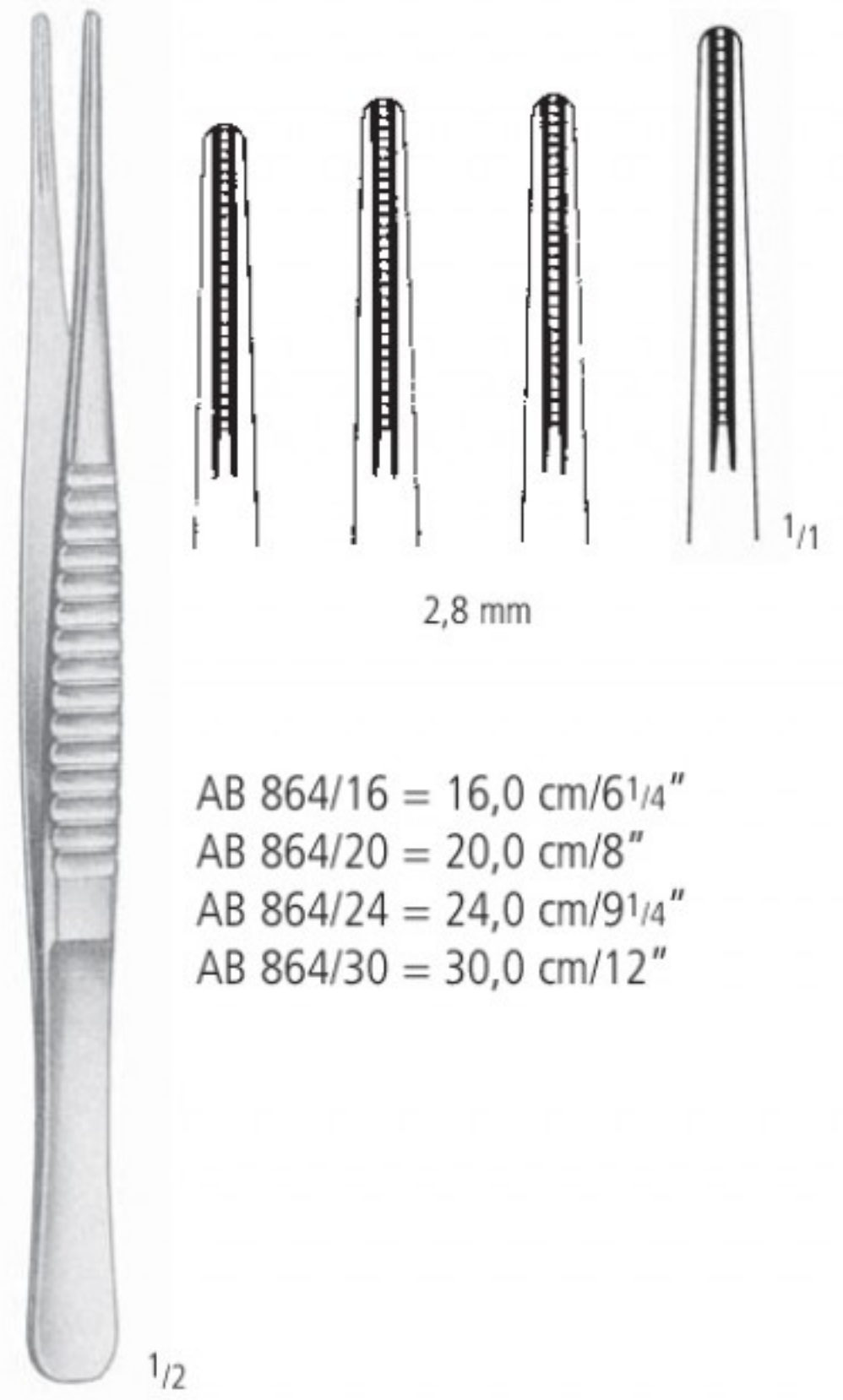

2,8 mm

AB 864/16 = 16,0 cm/6¹/₄"
 AB 864/20 = 20,0 cm/8"
 AB 864/24 = 24,0 cm/9¹/₄"
 AB 864/30 = 30,0 cm/12"

1/2

DE BAKEY

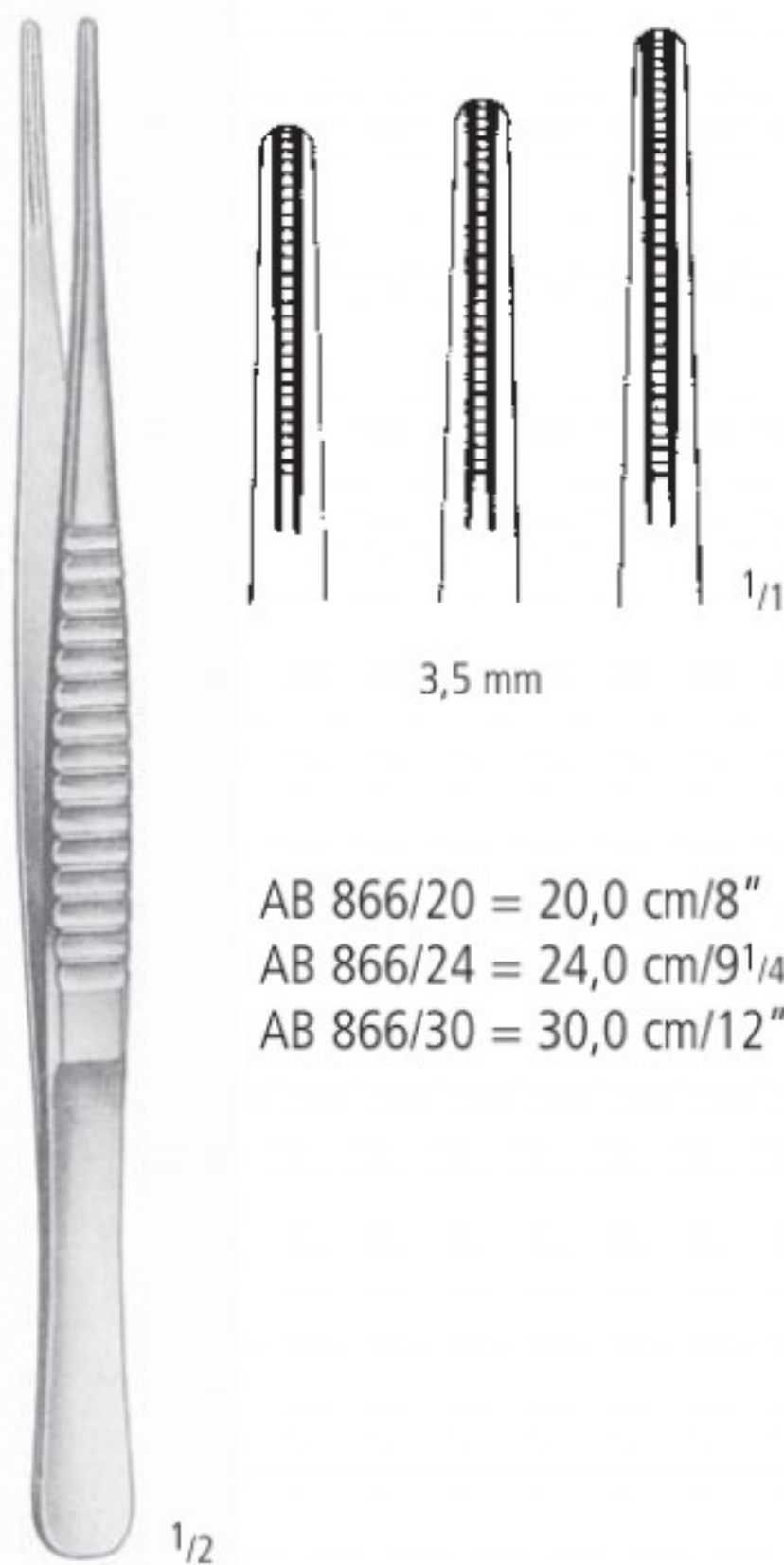

3,5 mm

AB 866/20 = 20,0 cm/8"
 AB 866/24 = 24,0 cm/9¹/₄"
 AB 866/30 = 30,0 cm/12"

1/2

DE BAKEY

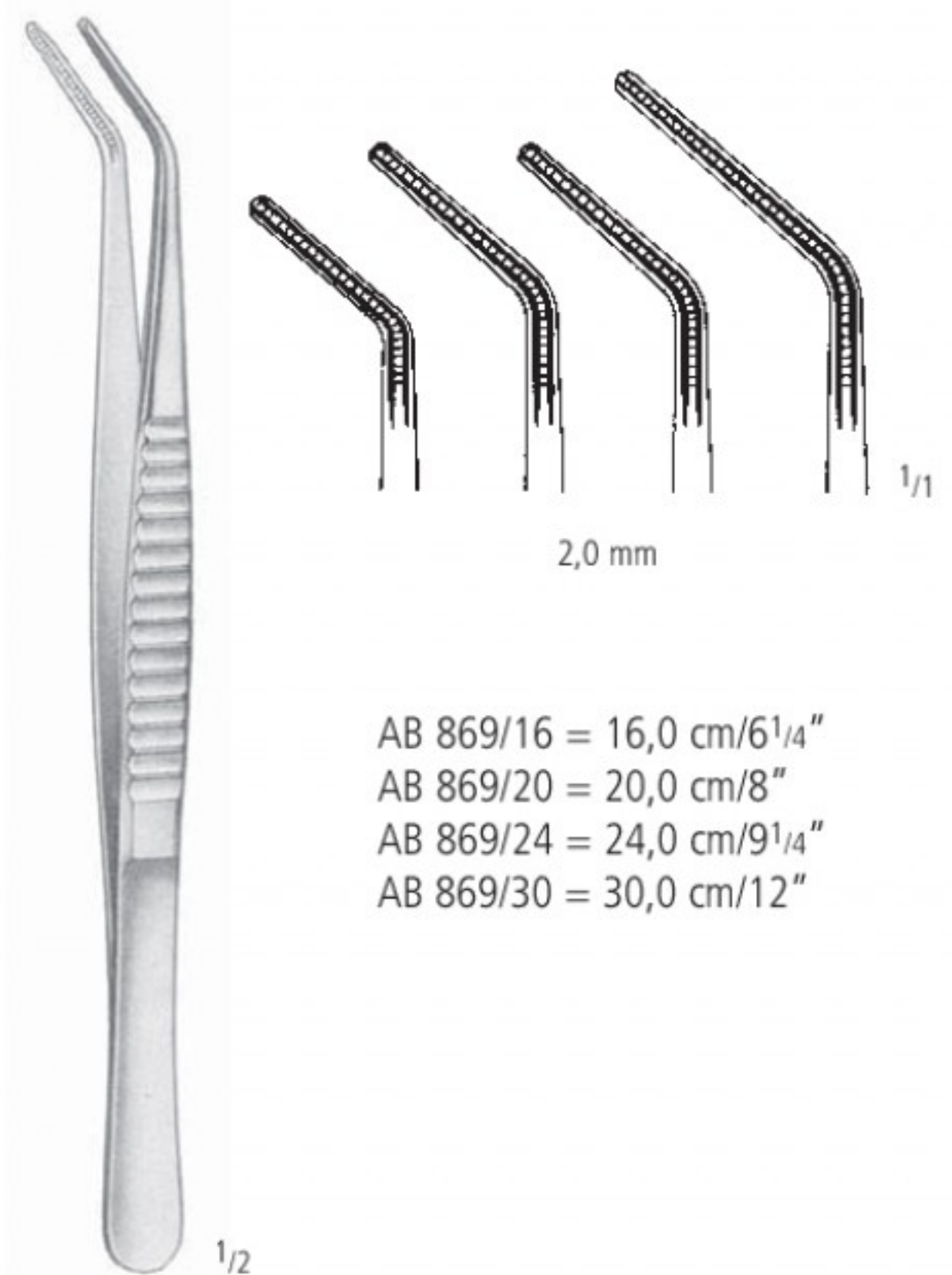

2,0 mm

AB 869/16 = 16,0 cm/6¹/₄"
 AB 869/20 = 20,0 cm/8"
 AB 869/24 = 24,0 cm/9¹/₄"
 AB 869/30 = 30,0 cm/12"

1/2

DE BAKEY

AB PINZETTEN FORCEPS PINZAS PINCES PINZE

Pinzetten mit Hartmetalleinsätzen
 Dissecting Forceps with Tungsten Carbide Inserts
 Pinzas de disección con bocas de carburo de tungsteno
 Pincés à dissection avec mors en carbure de tungstène
 Pinze per dissezione con punte di carburo di tungsteno

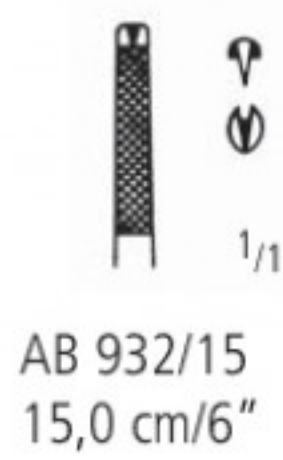
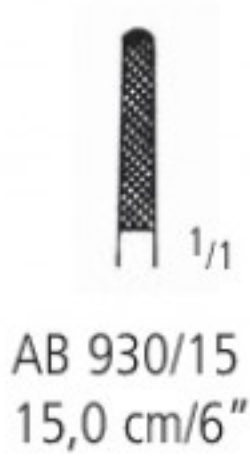
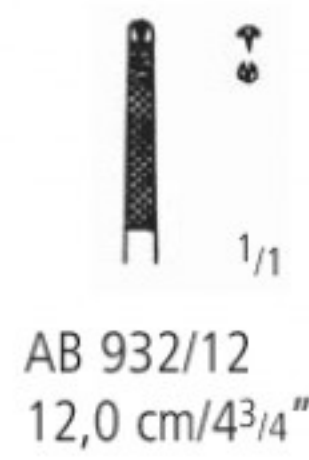
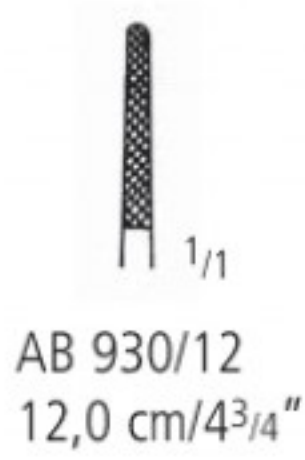

ADSON



CUSHING
17,5 cm/7"

mit Dissektor-Ende
 with dissector end
 con cabo disecador
 avec bout dissecteur
 con dissetore



CUSHING-TAYLOR
AB 943/18
18,0 cm/7"

SCHEREN
SCISSORS
TIJERAS
CISEAUX
FORBICI

AC

nopa[®] instruments



AC SCHEREN SCISSORS TIJERAS CISEAUX FORBICI

Scheren für Neurochirurgie
 Scissors for Neuro Surgery
 Tijeras para neurocirugía
 Ciseaux pour neurochirurgie
 Forbici per neurochirurgia

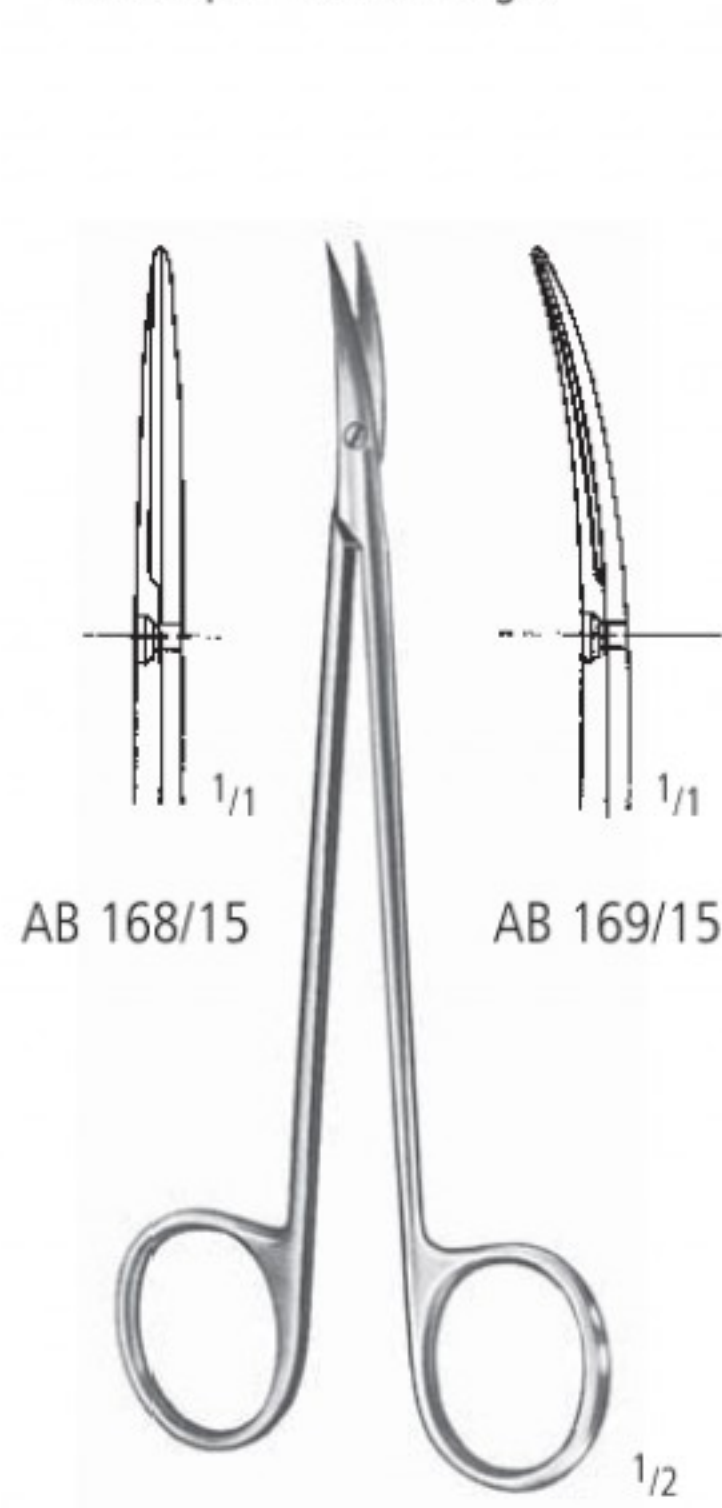

AB 168/15

AB 169/15

15,0 cm/6"

Nerv-Präparierschere
 Nerve dissecting scissors
 Tijeras para nervios
 Ciseaux pour nerfs
 Forbici per nervi



geknöpft
 probe pointed
 con botón
 boutoné
 bottenuto

AC 231/22
 22,0 cm/8³/₄"

STRULLY



AC 232/22
 22,0 cm/8³/₄"

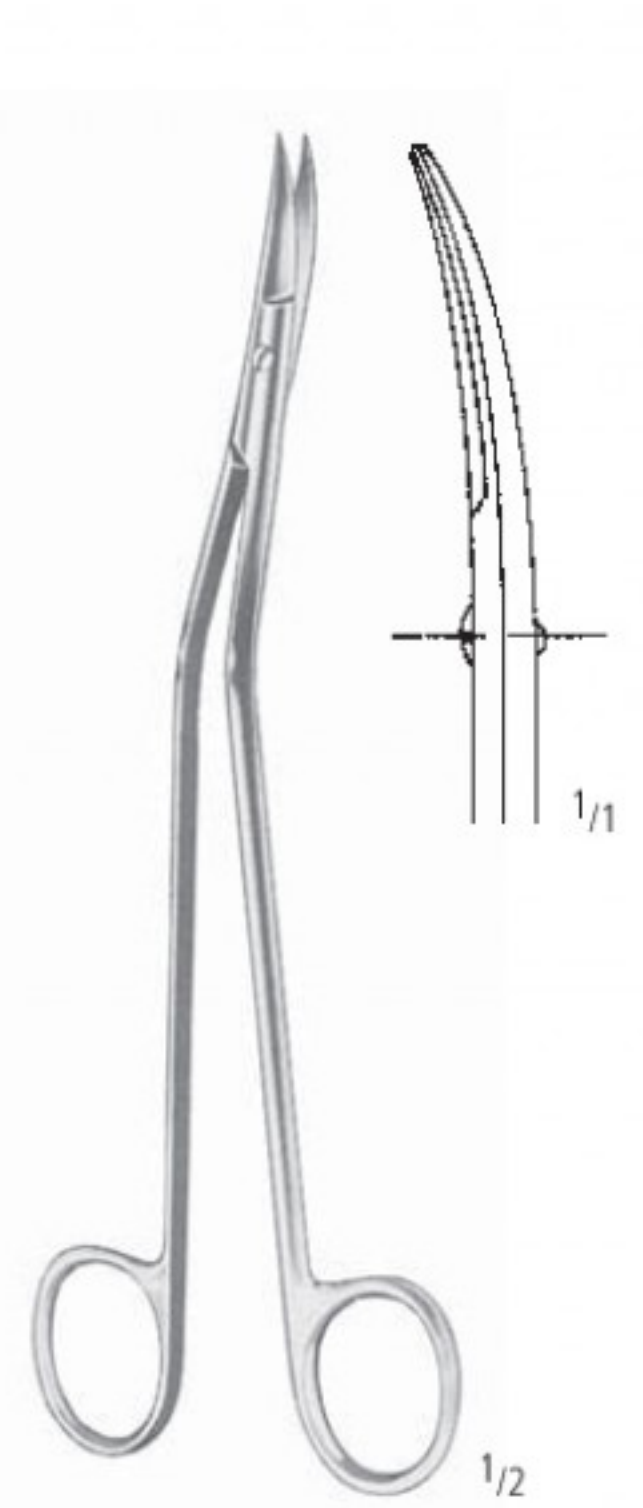

DANDY
 AC 233/17
 17,0 cm/6³/₄"



SCHMIEDEN-TAYLOR

14,5 cm/5¹/₂" AC 241/15
 17,0 cm/6³/₄" AC 241/17

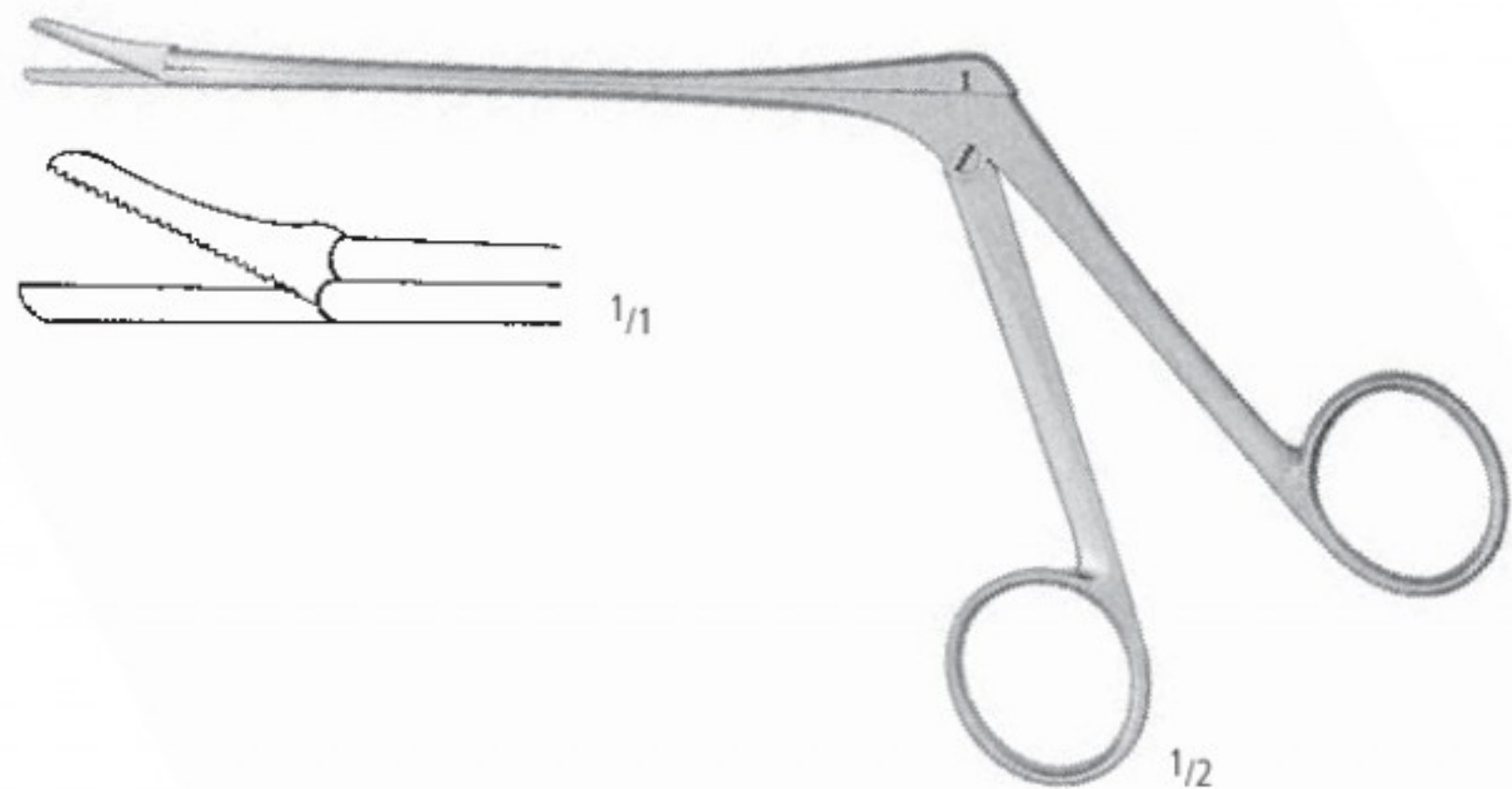

OLIVECRONA

AC 259/23
 23,0 cm/9"

SCHEREN SCISSORS TIJERAS CISEAUX FORBICI

Mikroscheren
Micro Scissors
Micro Tijeras
Micro Ciseaux
Micro Forbici

- >> Alle unsere Mikroscheren werden von Fachkräften mit jahrelanger Erfahrung hergestellt. Die Endkontrolle findet unter dem Mikroskop statt. Um Ihnen ein ermüdungsfreies Arbeiten zu ermöglichen, wird dem Federdruck größte Aufmerksamkeit gewidmet.
- >> Bitte wählen Sie unter Rund- oder Flachgriffscheren.

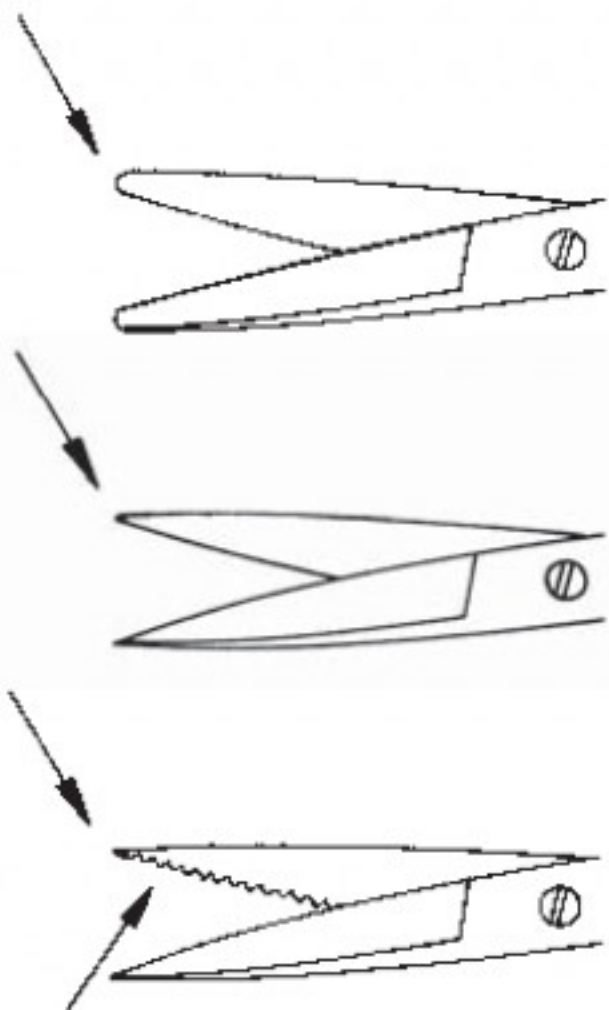

Dissection: **Gebogene Blätter, abgerundete Spitzen** ermöglichen eine gute und sichere Dissektion, ohne Nerven und Blutgefäße zu beschädigen.

Adventitia: **Gerade Blätter, sehr scharfe Spitzen** gewährleisten präzises Anfrischen von Gefäßenden.

Nerve: Ein Blatt ist **fein gezahnt**, um ein Herausgleiten des Nervs zu vermeiden.

- >> All our Micro Scissors are manufactured by skilled craftsmen with many years of experience. Final inspection is carried out under a microscope. Careful attention is paid to the closing pressure of the spring handle, to ensure precise work during surgeries, without fatigue.
- >> Round or flat handle scissors according to your preference.

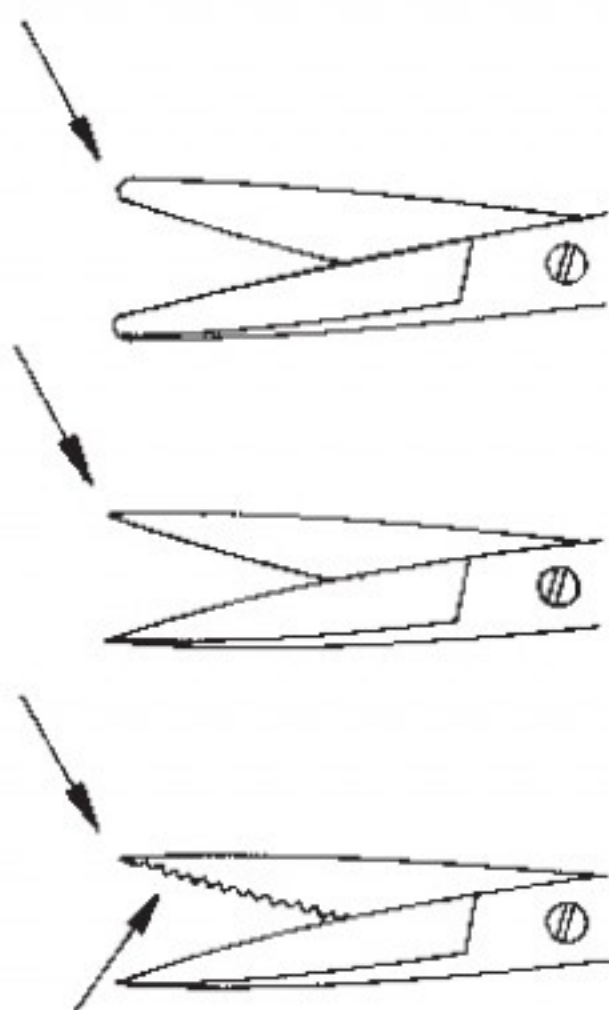

Dissection: **Curved blades, slightly rounded tips** ensure safe dissection without damage to nerves and vessels.

Adventitia: **Straight blades, very sharp tips** for finest trimming of vessel ends.

Nerve: One blade is **fine-toothed** to avoid slipping of the nerve.

AA

AB

AC

AE

AK

AO

AR

KA

KS

XR

XT

AC SCHEREN SCISSORS TIJERAS CISEAUX FORBICI

Mikroscheren
Micro Scissors
Micro Tijeras
Micro Ciseaux
Micro Forbici

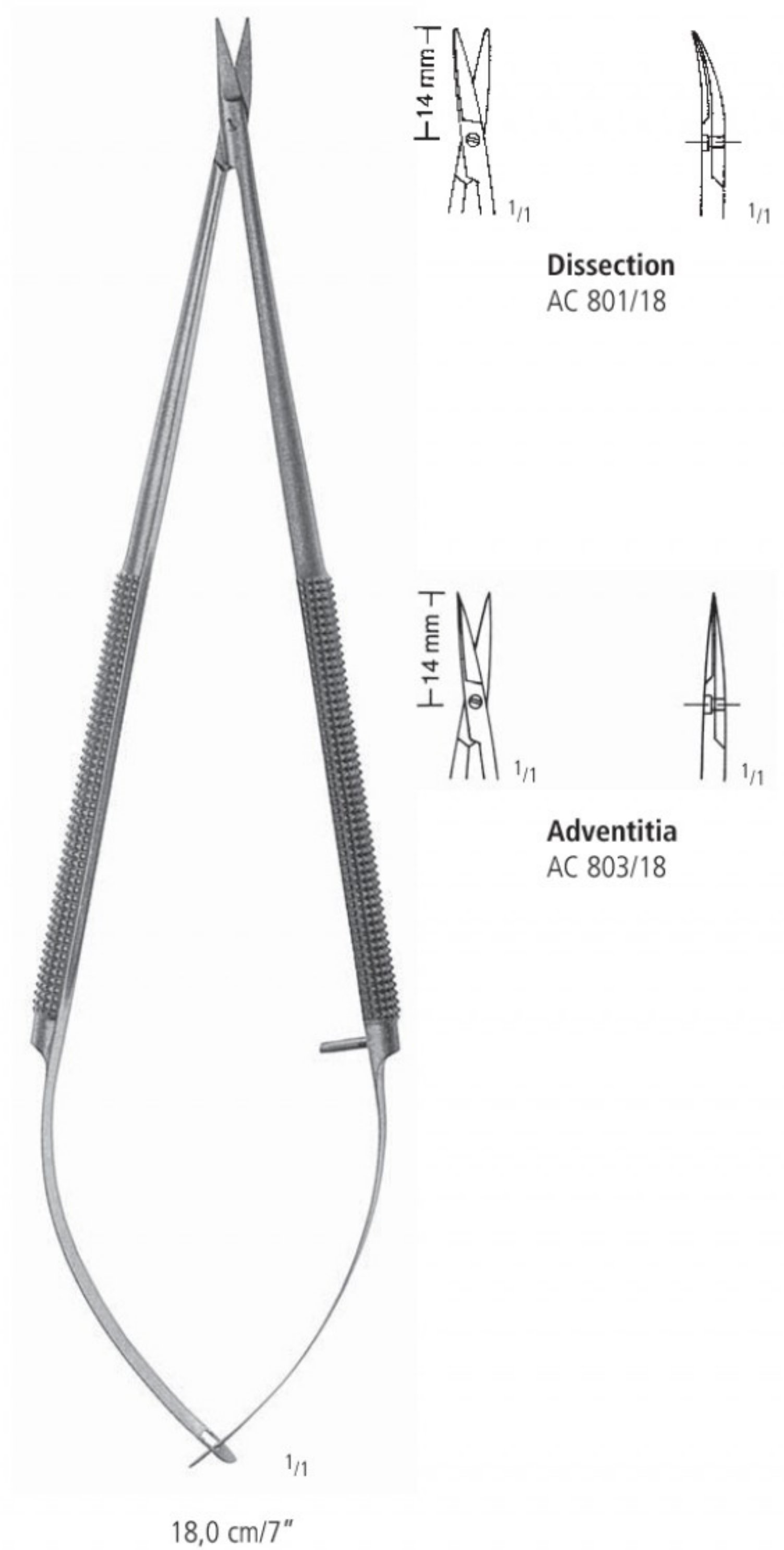
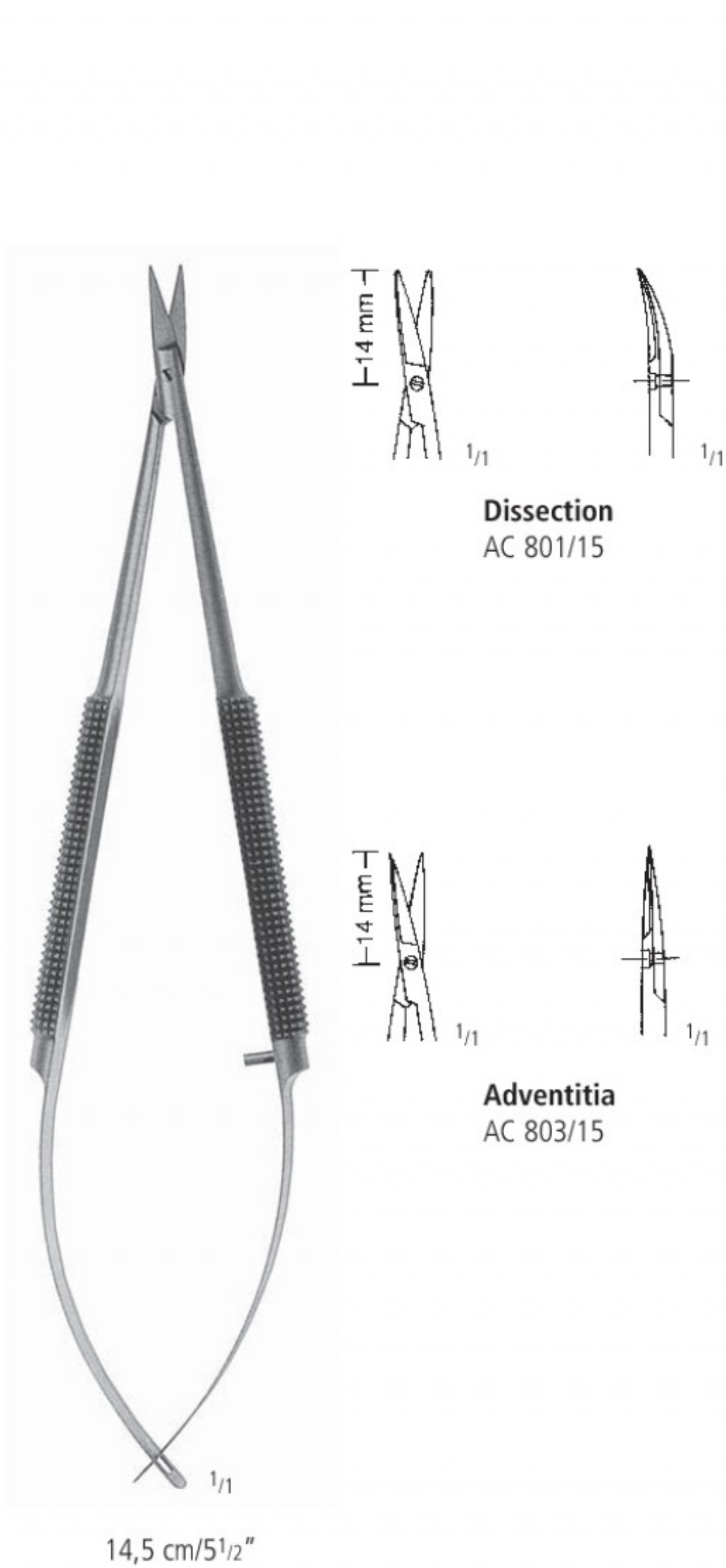

SCHEREN SCISSORS TIJERAS CISEAUX FORBICI

Mikroscheren
Mikro Scissors
Micro Tijeras
Micro Ciseaux
Micro Forbici

AA

AB

AC

AE

AK

AO

AR

KA

KS

XR

XT



AC 807/14
14,5 cm/5 1/2"



AC 812/18
18,0 cm/7"



AC 817/18
18,0 cm/7"

Mikroscheren
Micro Scissors
Micro Tijeras
Micro Ciseaux
Micro Forbici



11,0 cm/4 1/2"

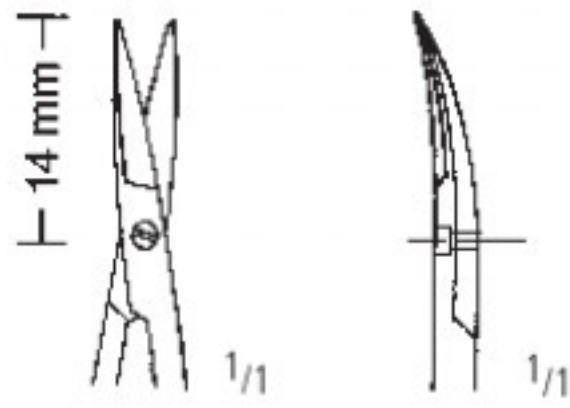

Dissection
AC 821/11

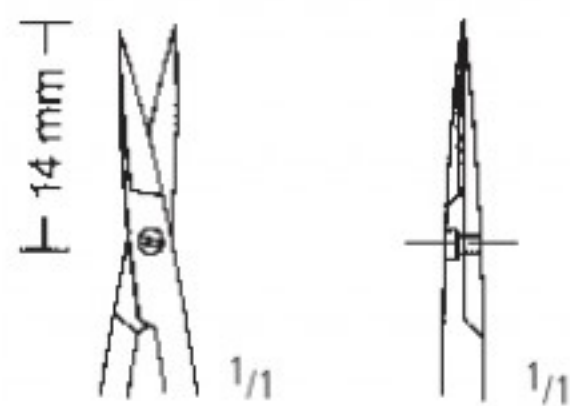

Adventitia
AC 830/11



15,0 cm/6"

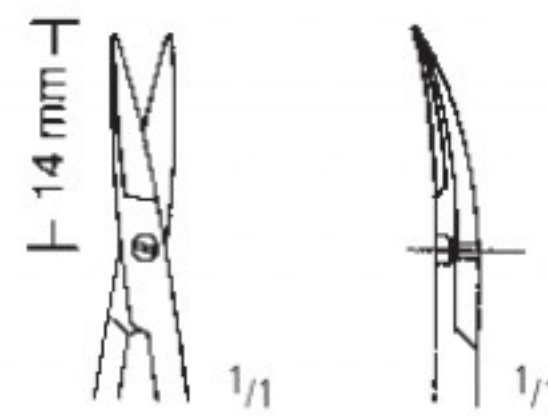

Dissection
AC 823/15

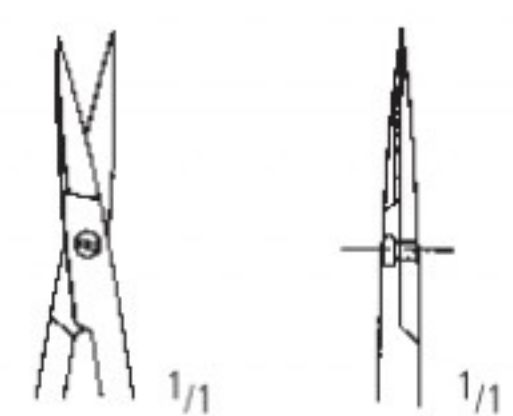

Adventitia
AC 832/15

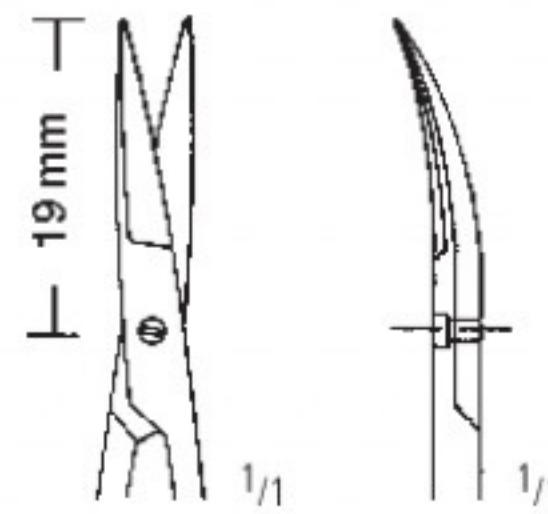

Dissection
AC 825/15

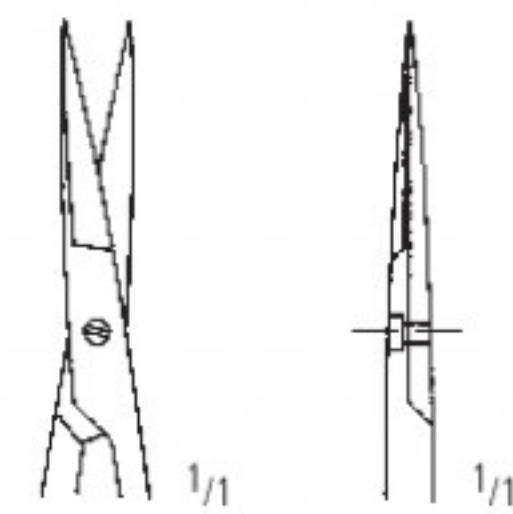

Adventitia
AC 834/15

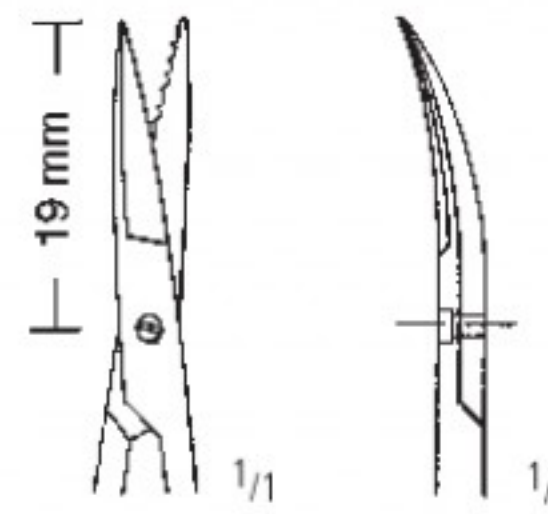

Dissection
AC 827/15

>> Nerve >> Adventitia
AC 836/15

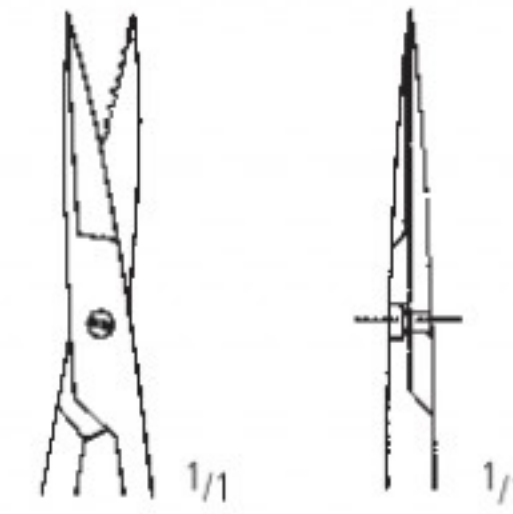

SCHEREN SCISSORS TIJERAS CISEAUX FORBICI

Mikroscheren
Micro Scissors
Micro Tijeras
Micro Ciseaux
Micro Forbici

AA

AB

AC

AE

AK

AO

AR

KA

KS

XR

XT

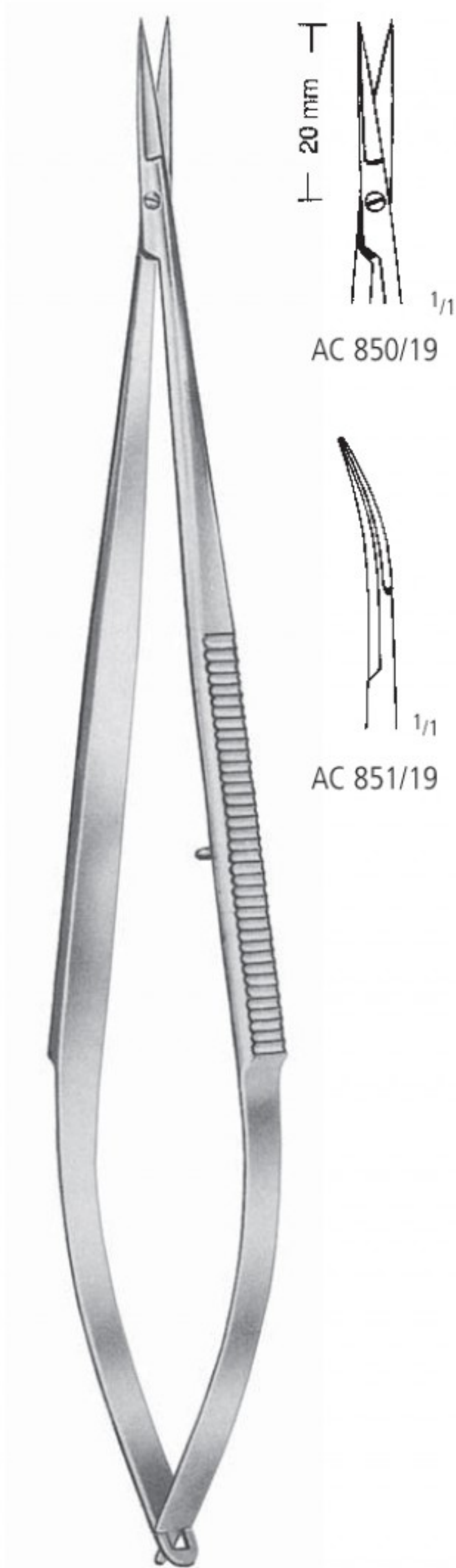

20 mm
1/1
AC 850/19

1/1
AC 851/19

18,5 cm/7 1/4"

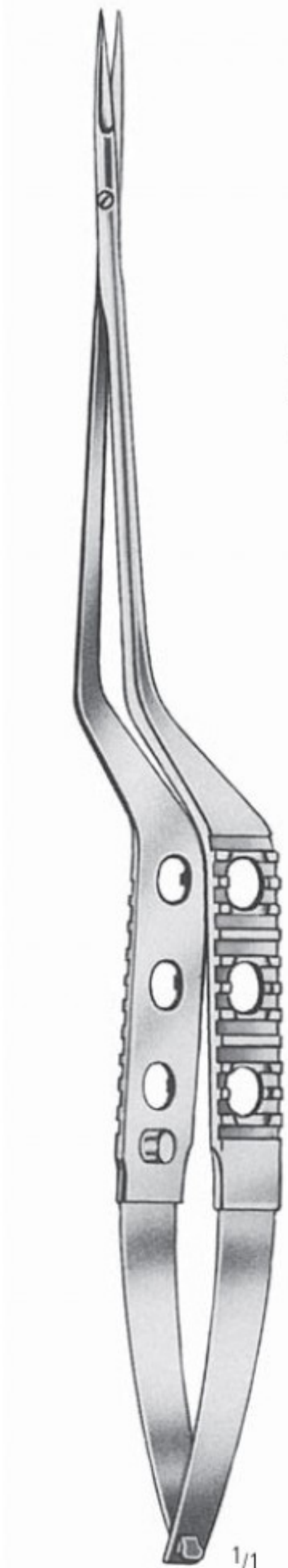

1/1
AC 860/16
AC 860/20
AC 860/22

1/1
AC 861/16
AC 861/20
AC 861/22

1/1
AC 862/16
AC 862/20
AC 862/22

1/1
AC 863/16
AC 863/20
AC 863/22

1/1
AC 864/16
AC 864/20
AC 864/22

1/1
AC 865/16
AC 865/20
AC 865/22

16,0 cm/6 1/4"
20,0 cm/8"
22,5 cm/9"

AC SCHEREN SCISSORS TIJERAS CISEAUX FORBICI

Mikroscheren
Micro Scissors
Micro Tijeras
Micro Ciseaux
Micro Forbici



18,0 cm/7"
1/2

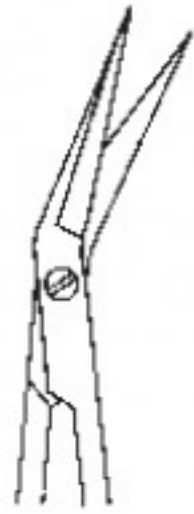

AC 870/01
25°

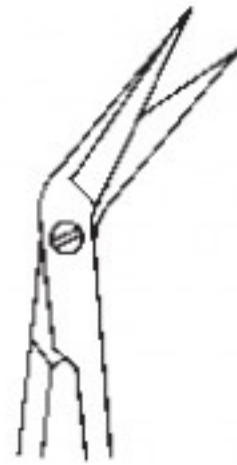

AC 870/02
45°

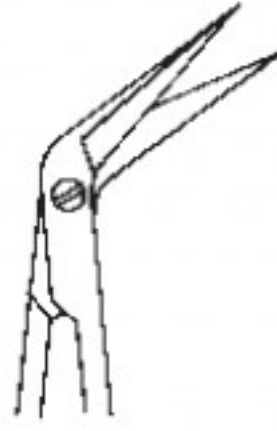

AC 870/03
60°



AC 870/04
90°

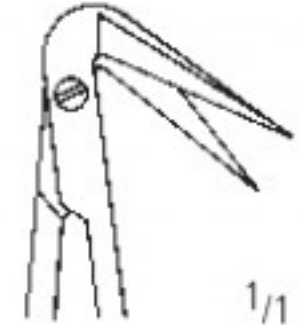

AC 870/05
125°
1/1



18,0 cm/7"
1/2



AC 871/01
25°



AC 871/02
45°



AC 871/03
60°



AC 871/04
90°



AC 871/05
125°
1/1

SCHEREN SCISSORS TIJERAS CISEAUX FORBICI

Scheren mit Hartmetalleinlagen
 Scissors with Tungsten Carbide Inserts
 Tijeras con filos de carburo de tungsteno
 Ciseaux avec plaquettes en carbure de tungstène
 Forbici con taglio al carburo di tungsteno

AA

AB

AC

AE

AK

AO

AR

KA

KS

XR

XT

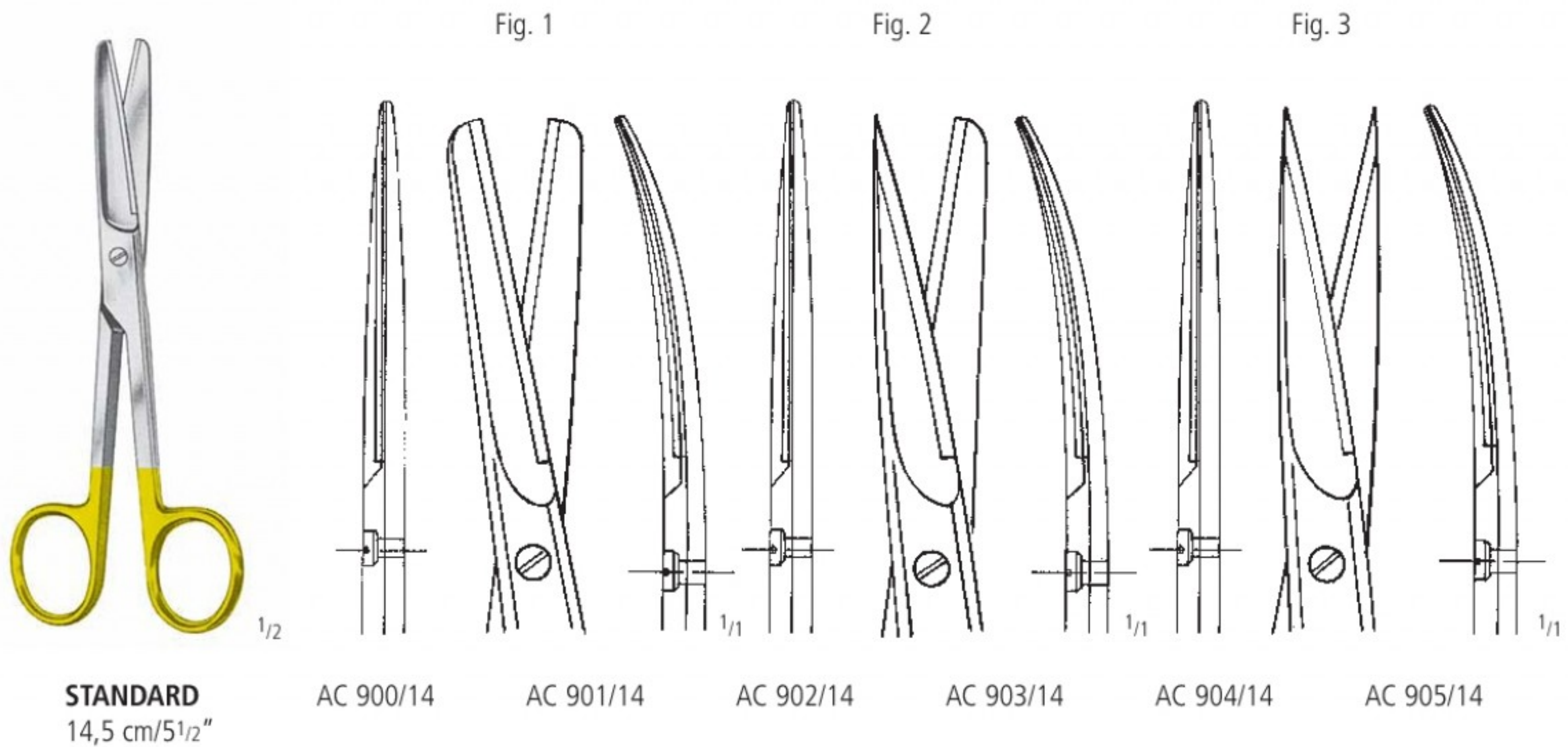

STANDARD
14,5 cm/5 1/2"

AC 900/14

AC 901/14

AC 902/14

AC 903/14

AC 904/14

AC 905/14



MAYO
 AC 910/14 14,5 cm/5 1/2"
 AC 910/17 17,0 cm/6 3/4"
 AC 910/23 23,0 cm/9"

MAYO
 AC 911/14
 AC 911/17
 AC 911/23

METZENBAUM
 AC 930/14
 14,5 cm/5 1/2"

METZENBAUM
 AC 931/14
 14,5 cm/5 1/2"

AC SCHEREN SCISSORS TIJERAS CISEAUX FORBICI

Scheren mit Hartmetalleinlagen
 Scissors with Tungsten Carbide Inserts
 Tijeras con filos de carburo de tungsteno
 Ciseaux avec plaquettes en carbure de tungstène
 Forbici con taglio al carburo di tungsteno

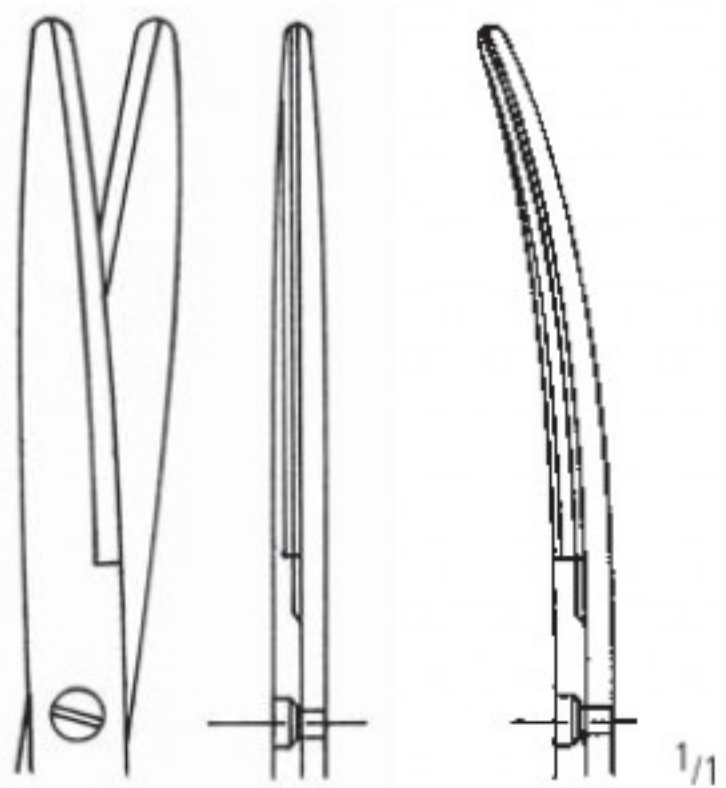

Original 18,0 cm

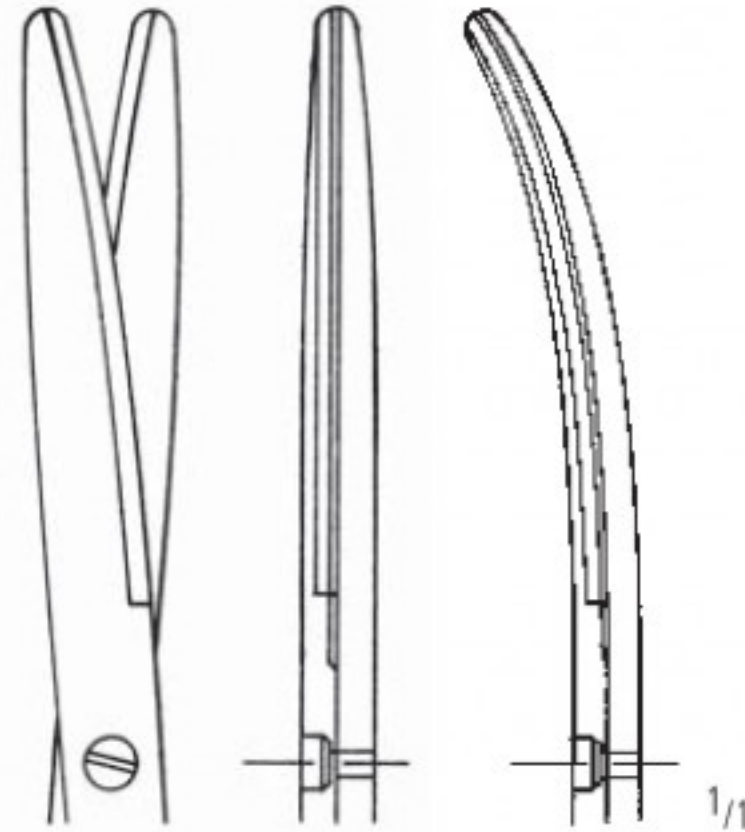

Original 20,0 cm

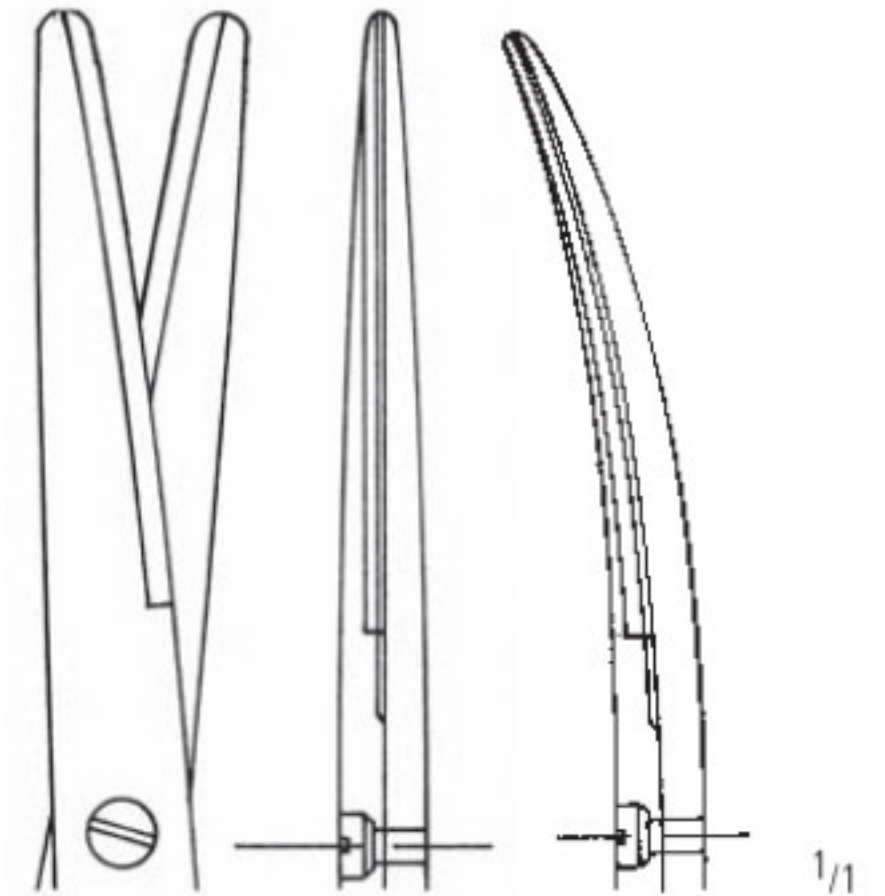

Original 23,0 cm



METZENBAUM



nopa
TUC[®]

gerade
 straight
 rectas
 droits
 retta

gebogen
 curved
 curvas
 courbes
 curva

AC 940/18	18,0 cm/7"	AC 941/18
AC 940/20	20,0 cm/8"	AC 941/20
AC 940/23	23,0 cm/9"	AC 941/23
AC 940/25	25,0 cm/10"	AC 941/25
AC 940/28	28,0 cm/11"	AC 941/28
AC 940/30	30,0 cm/12"	AC 941/30

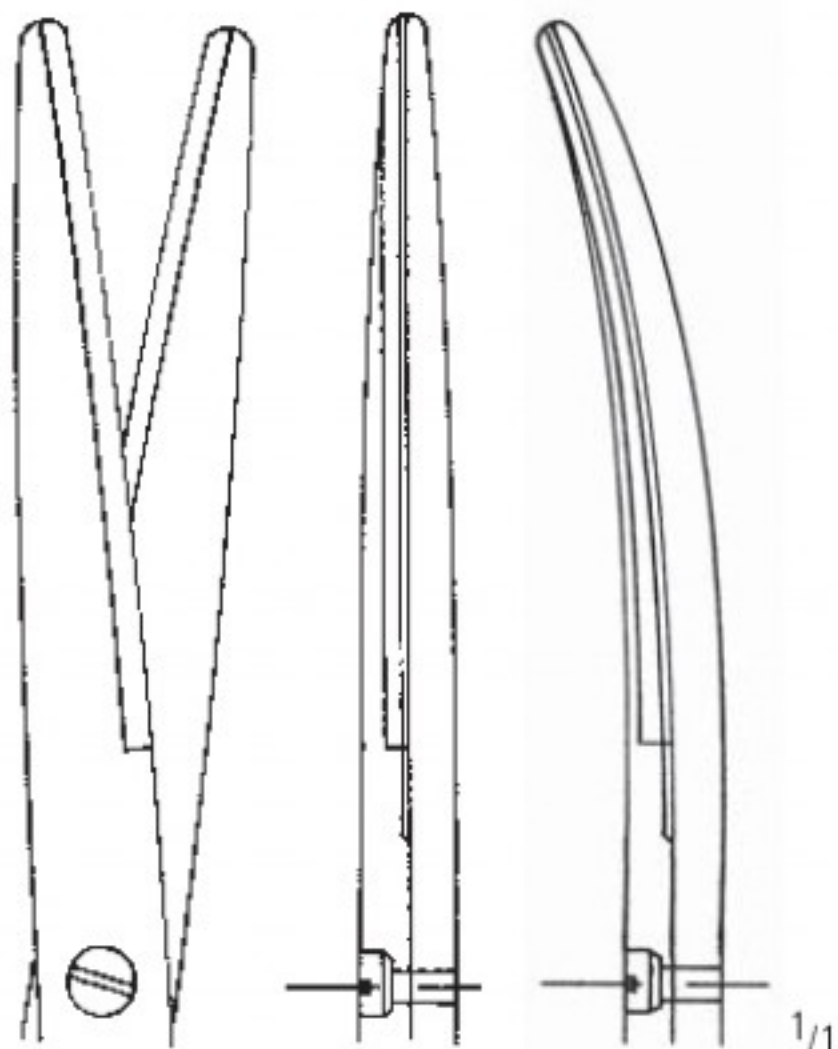

Original 25,0 cm

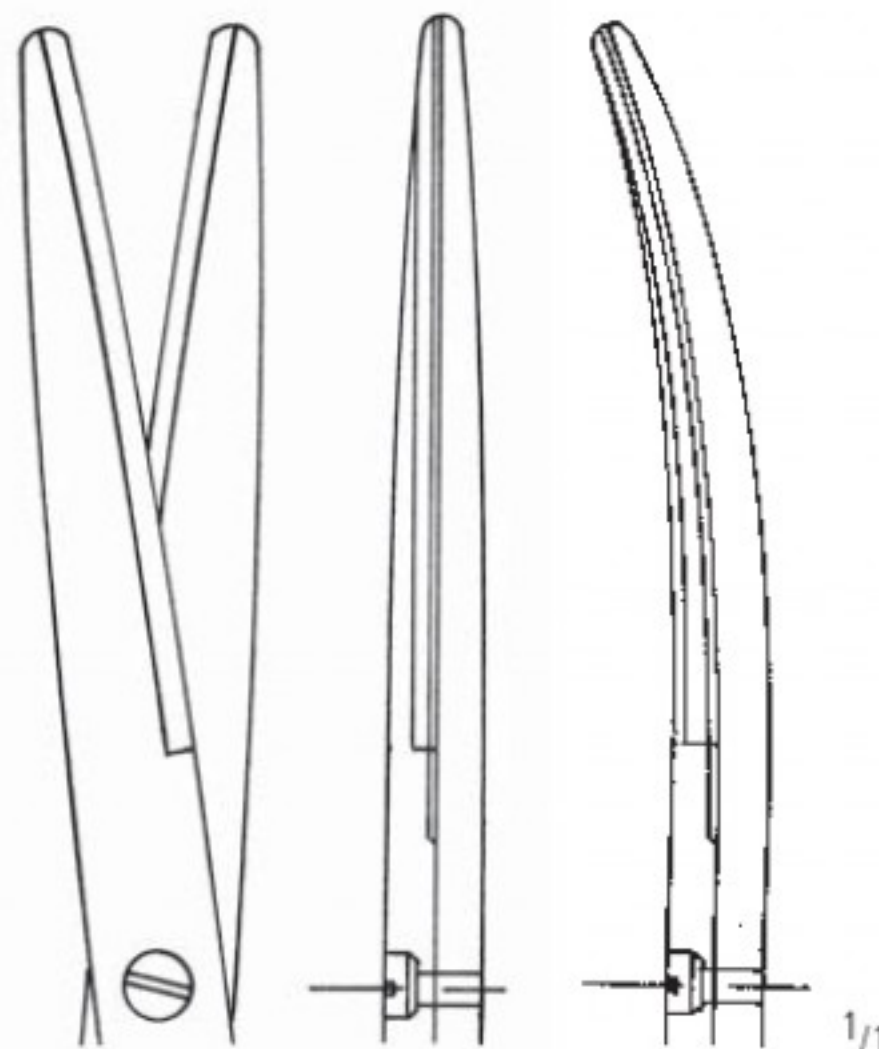

Original 28,0 cm

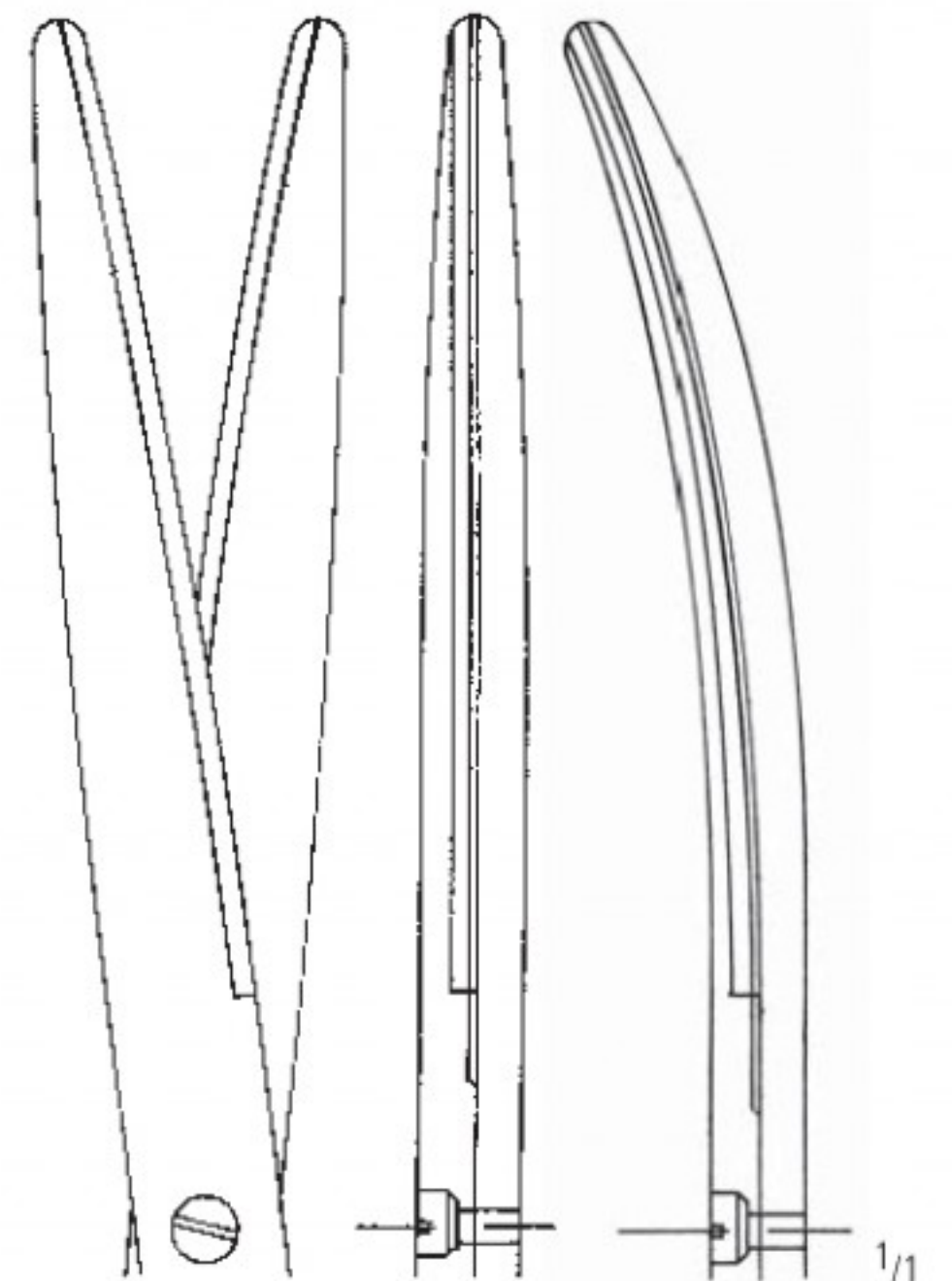

Original 30,0 cm

SCHEREN SCISSORS TIJERAS CISEAUX FORBICI

Scheren mit Hartmetalleinlagen
 Scissors with Tungsten Carbide Inserts
 Tijeras con filos de carburo de tungsteno
 Ciseaux avec plaquettes en carbure de tungstène
 Forbici con taglio al carburo di tungsteno

AA
 AB
AC
 AE
 AK
 AO
 AR
 KA
 KS
 XR
 XT



LEXER
 AC 952/16
 16,0 cm/6¹/₄"



LEXER
 AC 953/16
 16,0 cm/6¹/₄"



AC 960/14
 14,5 cm/5¹/₂"



AC 961/14
 14,5 cm/5¹/₂"



AC 962/14
 14,5 cm/5¹/₂"

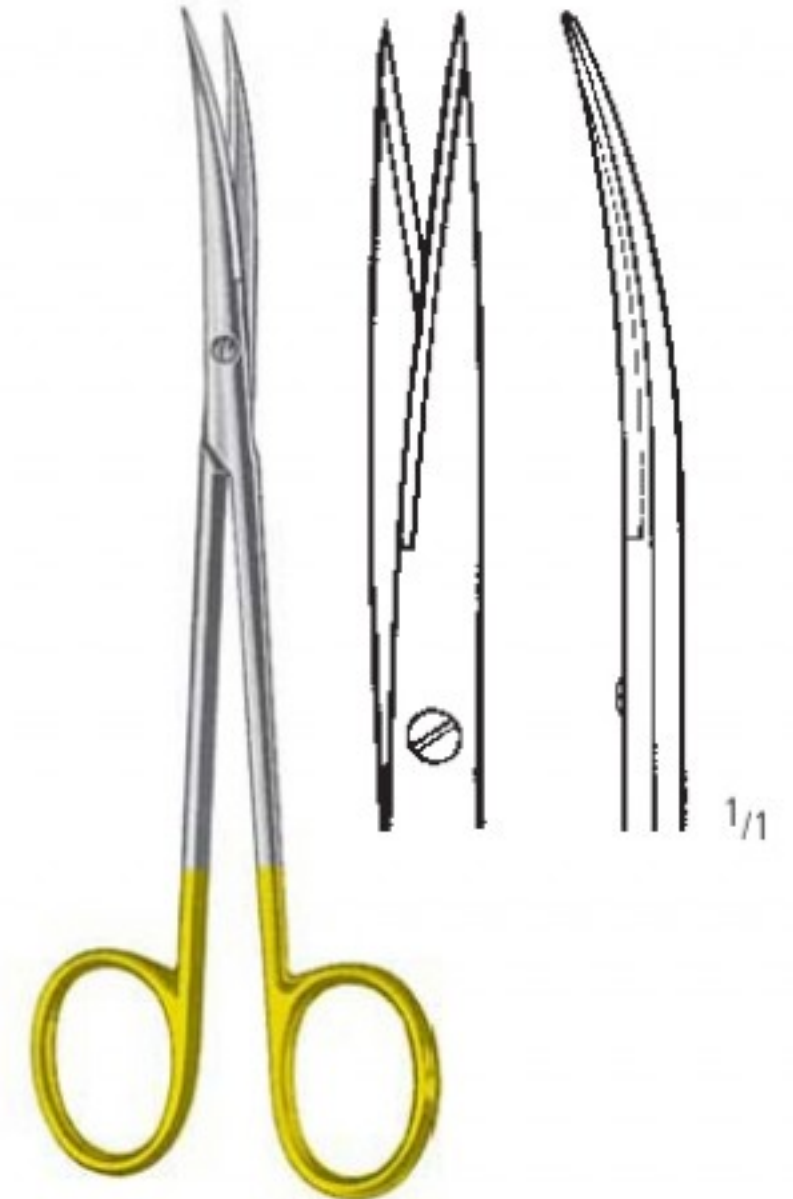

AC 963/14
 14,5 cm /5¹/₂"

METZENBAUM-DELICATE

AC SCHEREN SCISSORS TIJERAS CISEAUX FORBICI

Scheren mit Hartmetalleinlagen
 Scissors with Tungsten Carbide Inserts
 Tijeras con filos de carburo de tungsteno
 Ciseaux avec plaquettes en carbure de tungstène
 Forbici con taglio al carburo di tungsteno

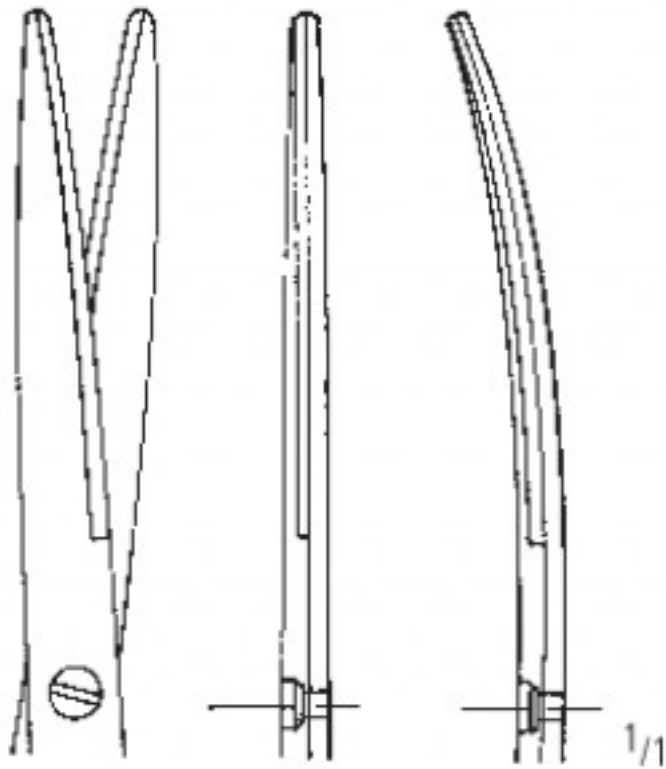

Original 18,0 cm

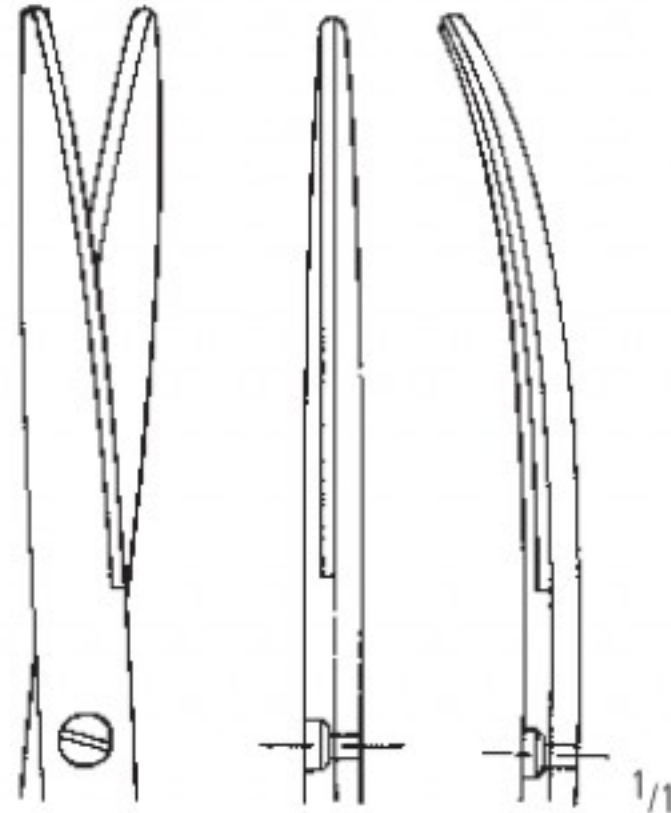

Original 20,0 cm

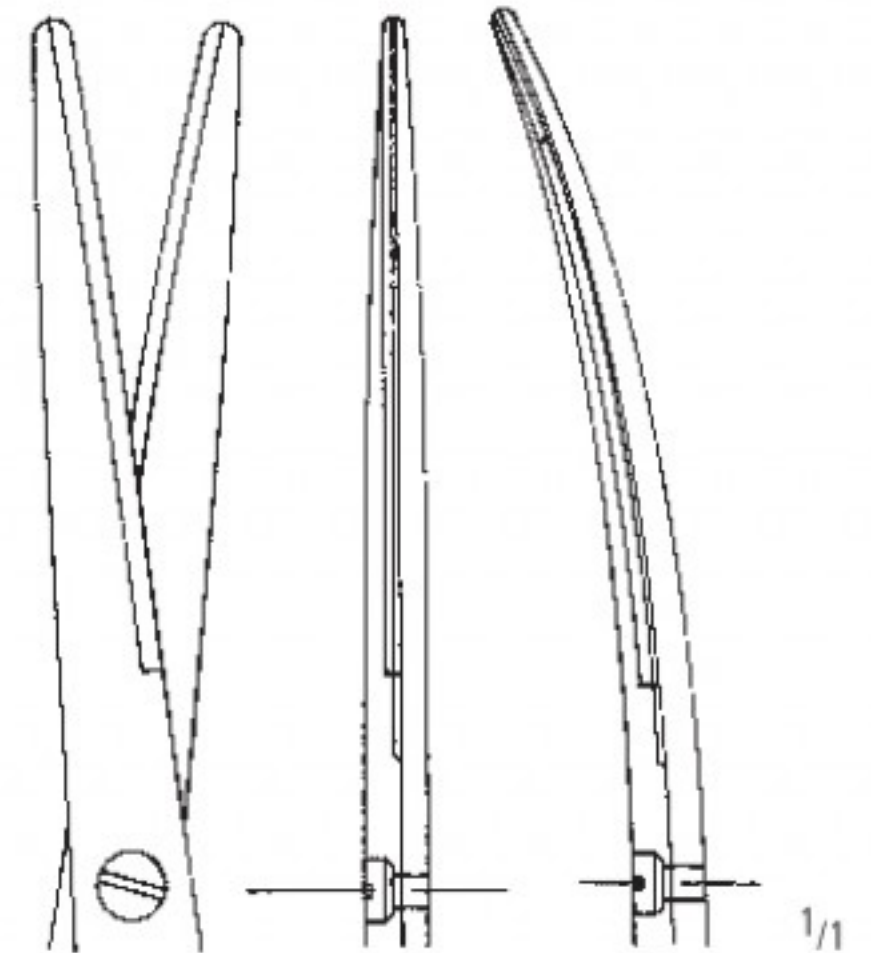

Original 23,0 cm



METZENBAUM-DELICATE



nopa
TUC[®]

gerade
 straight
 rectas
 droits
 retta

gebogen
 curved
 curvas
 courbes
 curva

AC 970/18	18,0 cm/7"	AC 971/18
AC 970/20	20,0 cm/8"	AC 971/20
AC 970/23	23,0 cm/9"	AC 971/23
AC 970/25	25,0 cm/10"	AC 971/25
AC 970/28	28,0 cm/11"	AC 971/28

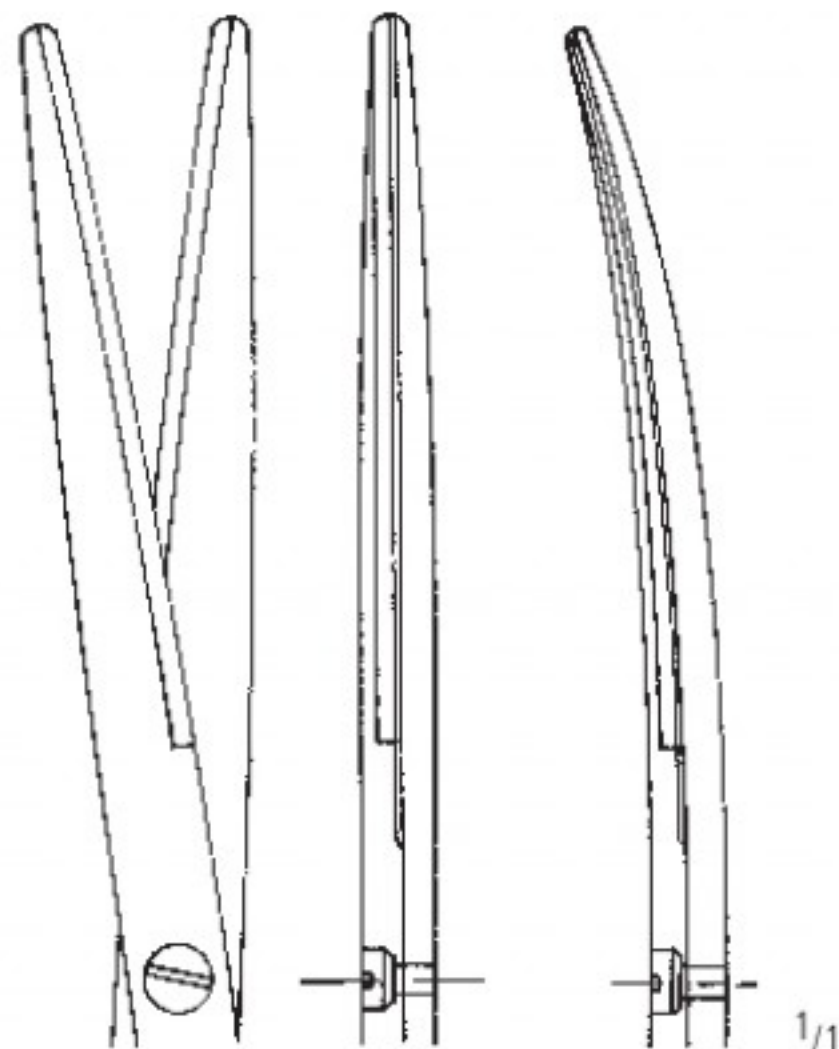

Original 25,0 cm

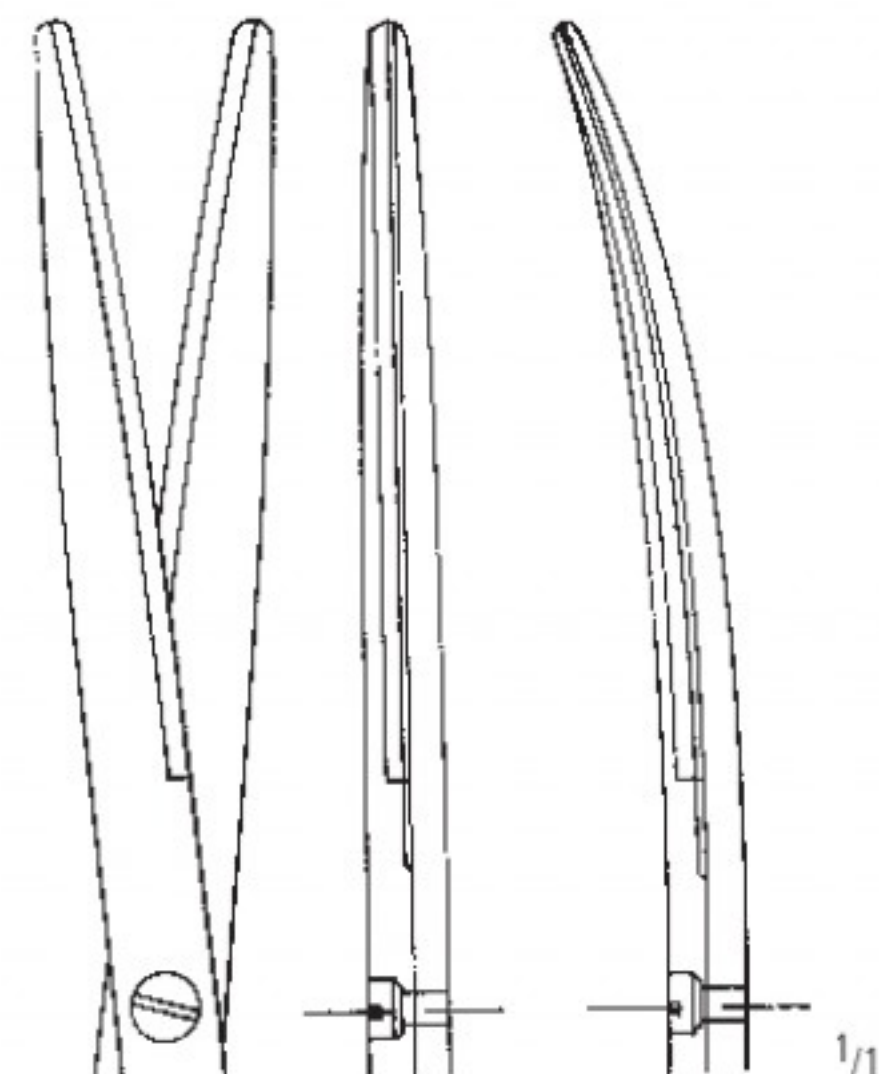

Original 28,0 cm

SCHEREN SCISSORS TIJERAS CISEAUX FORBICI

Scheren mit Hartmetalleinlagen
 Scissors with Tungsten Carbide Inserts
 Tijeras con filos de carburo de tungsteno
 Ciseaux avec plaquettes en carbure de tungstène
 Forbici con taglio al carburo di tungsteno

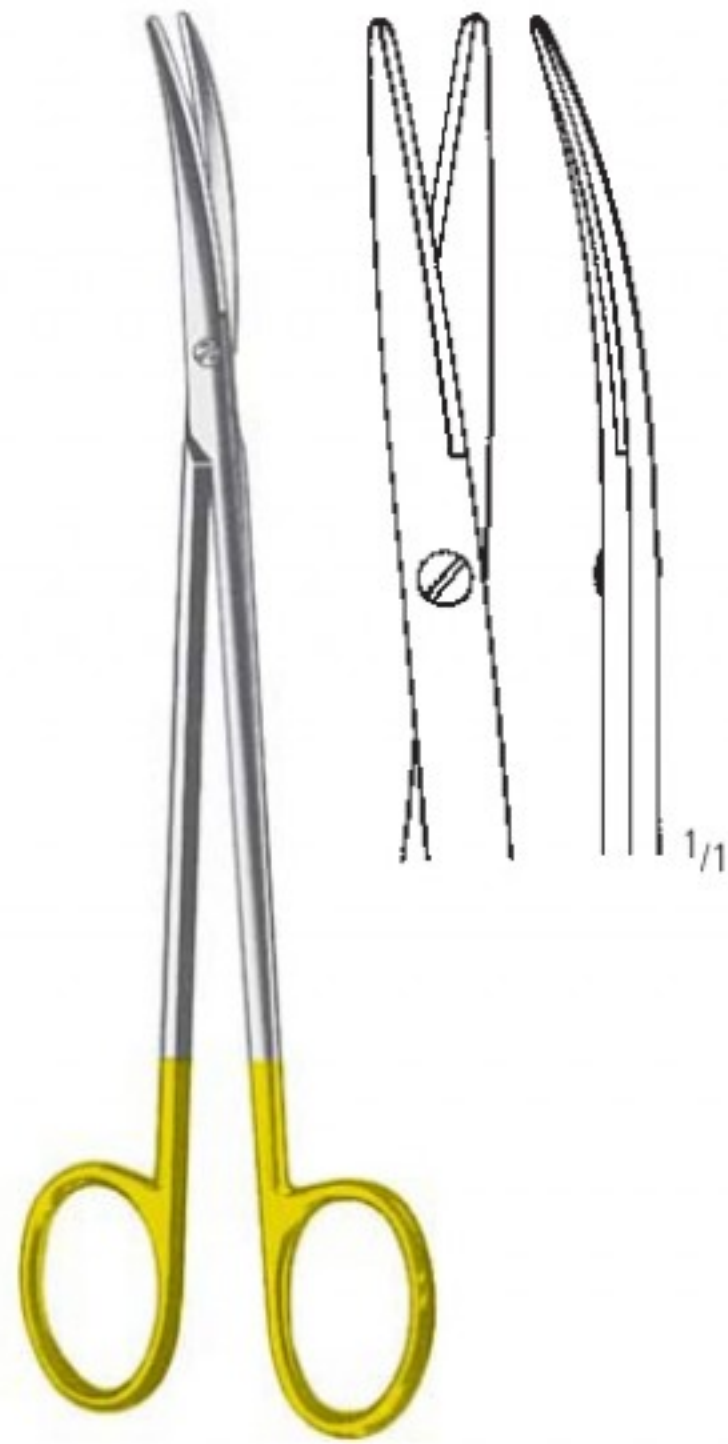

TOENNIS-ADSON-DELICATE
 AC 977/17
 17,5 cm/7"

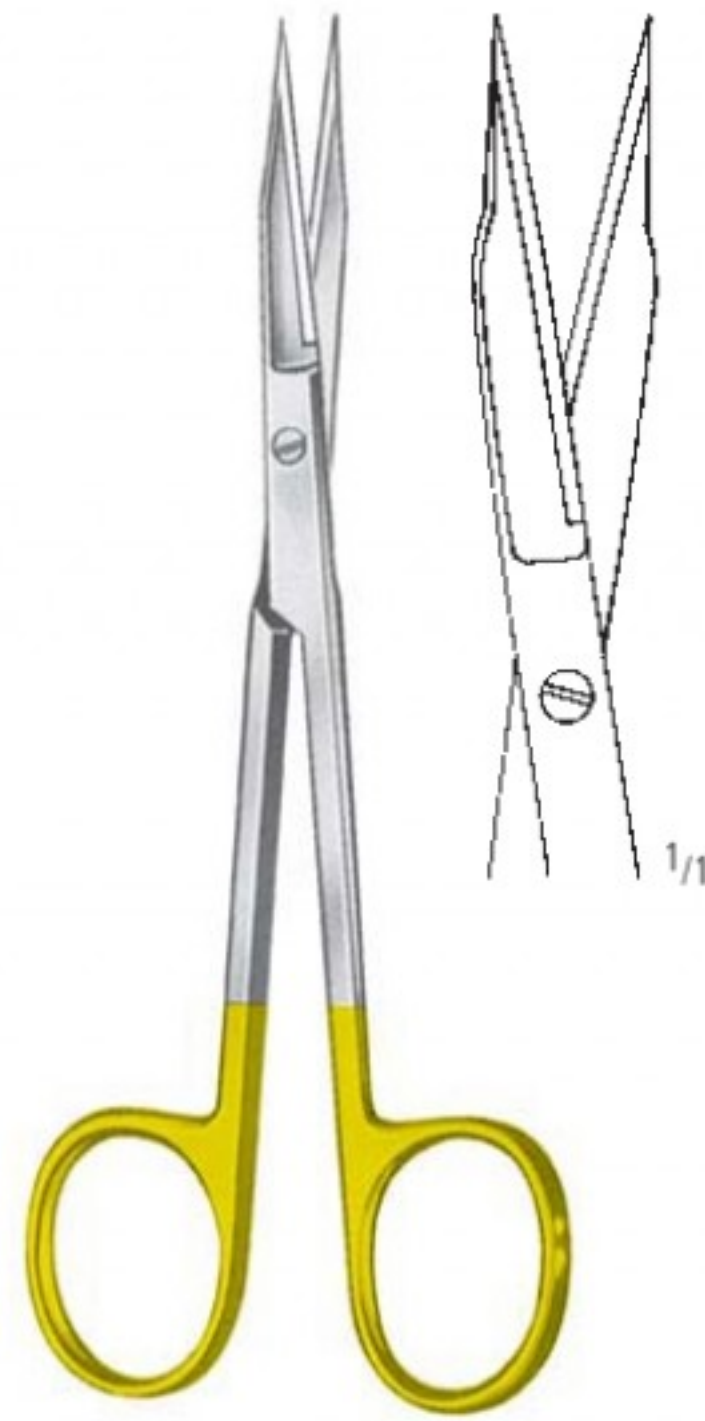

AC 980/13
 13,0 cm/5"

GOLDMAN-FOX



AC 981/13
 13,0 cm/5"



Weitere Scheren siehe Katalog A 98-157.
 For further scissors see catalogue A 98-157.
 Para otras tijeras ver catálogo A 98-157.
 D'autres ciseaux voir notre catalogue A 98-157.
 Altre forbici consultare il nostro catalogo A 98-157.



AC 984/11
 11,5 cm/4 1/2"



AC 985/11
 11,5 cm/4 1/2"

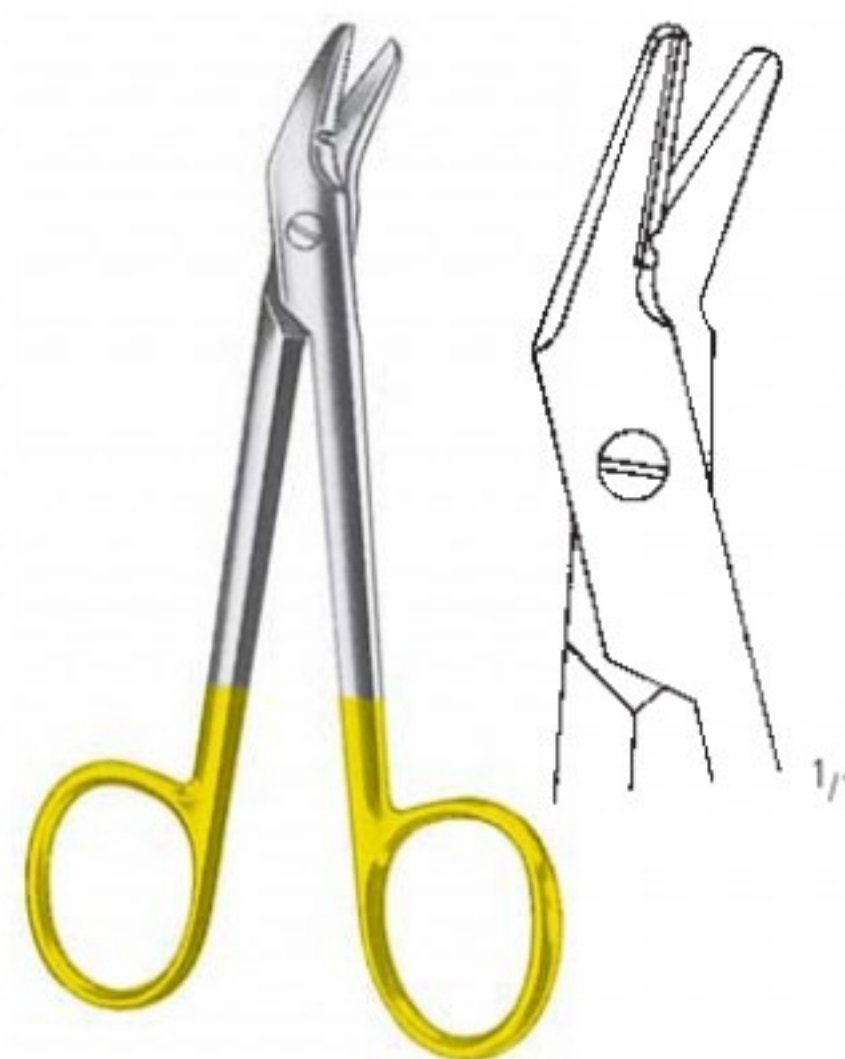

UNIVERSAL
 AC 987/12
 12,0 cm/4 3/4"



LISTER
 AC 999/18
 18,0 cm/7"

AA
 AB
 AC
 AE
 AK
 AO
 AR
 KA
 KS
 XR
 XT

NAHT
SUTURE
SUTURA
SUTURE
SUTURA

AE

nopa[®] instruments



AE NAHT SUTURE SUTURA SUTURE SUTURA

Nadelhalter mit Hartmetalleinsätzen
 Needle Holders with Tungsten Carbide Inserts
 Porta-agujas con bocas de carburo de tungsteno
 Porte-aiguilles à mors en carbure de tungstène
 Portaghi con placche di carburo di tungsteno



1/2

MAYO-HEGAR



AE 400/14
14,0 cm/5 1/2"



AE 400/16
16,0 cm/6 1/4"



AE 400/18
18,0 cm/7"



AE 400/20
20,0 cm/8"



AE 400/24
24,0 cm/9 1/2"

1/1



AE 400/26
26,0 cm/10 1/4"



AE 400/30
30,0 cm/12"

1/1



1/2

**DE BAKEY
 (MAYO-HEGAR-DELICATE)**



AE 420/18
18,0 cm/7"



AE 420/20
20,0 cm/8"



AE 420/23
23,0 cm/9"



AE 420/26
26,0 cm/10 1/4"



AE 420/31
31,0 cm/12 1/4"

1/1

NAHT SUTURE SUTURA SUTURE SUTURA

Nadelhalter mit Hartmetalleinsätzen
 Needle Holders with Tungsten Carbide Inserts
 Porta-agujas con bocas de carburo de tungsteno
 Porte-aiguilles à mors en carbure de tungstène
 Portaghi con placche di carburo di tungsteno

AA
AB
AC
AE
AK
AO
AR
KA
KS
XR
XT



MICRO RYDER

AE 434/13
13,0 cm/5"

AE 434/15
15,0 cm/6"

AE 434/18
18,0 cm/7"

AE 434/20
20,0 cm/8"

AE 434/23
23,0 cm/9"

AE 434/26
26,0 cm/10^{1/4}"

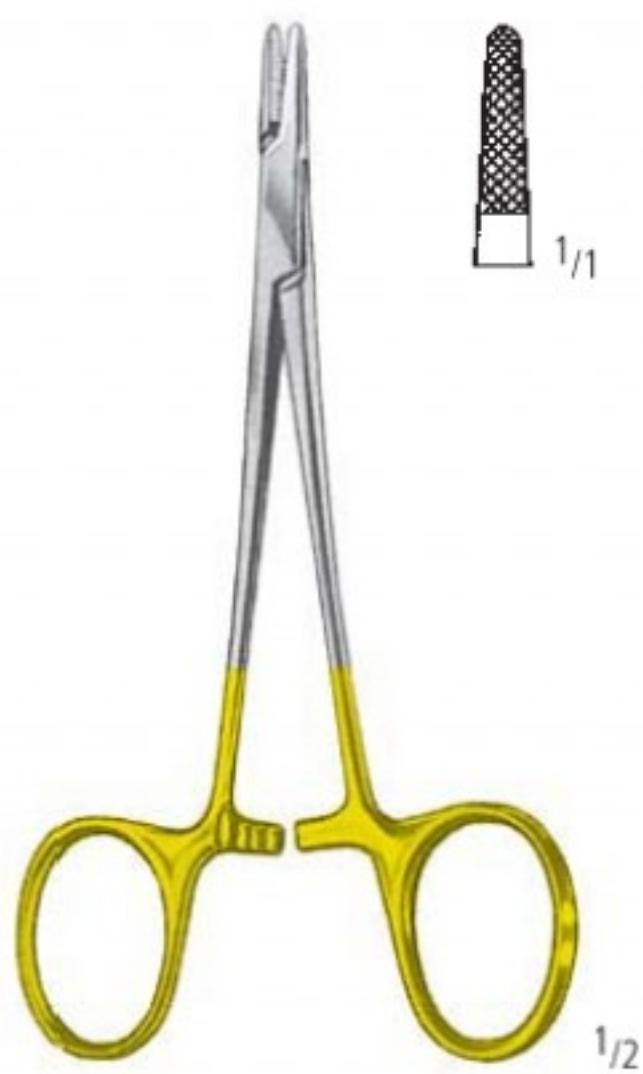

CONVERSE
AE 452/12
12,5 cm/5"

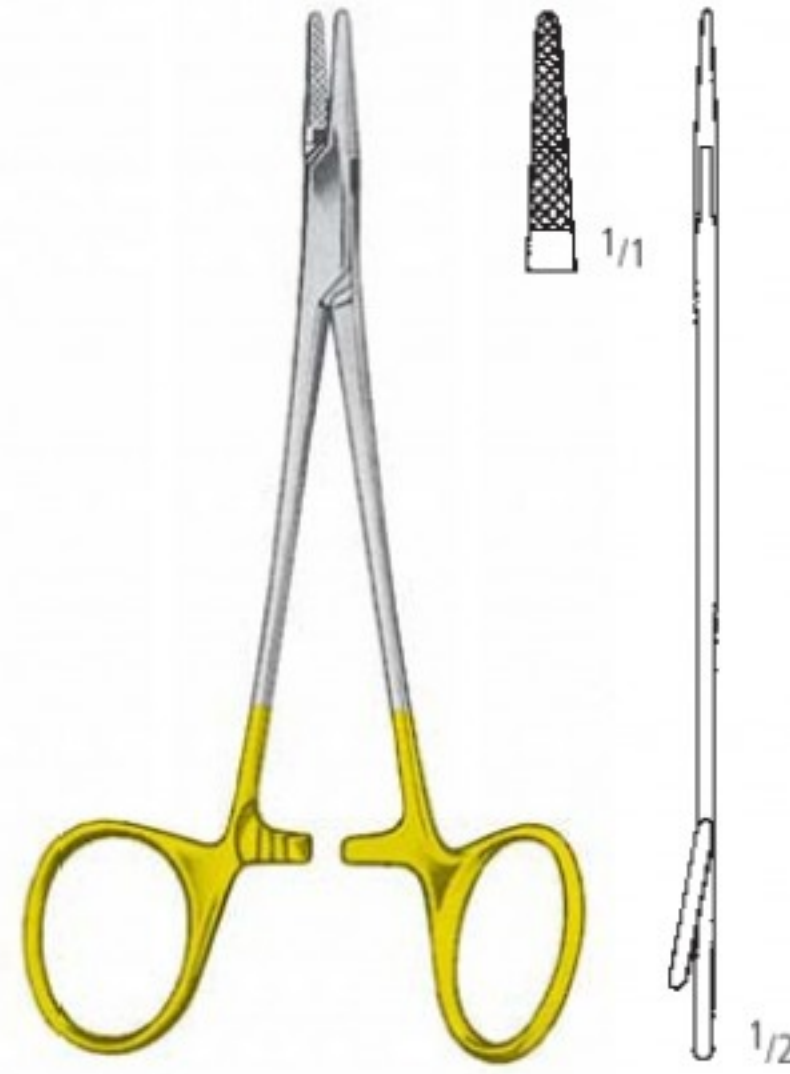

NEIVERT
AE 456/13
13,0 cm/5"

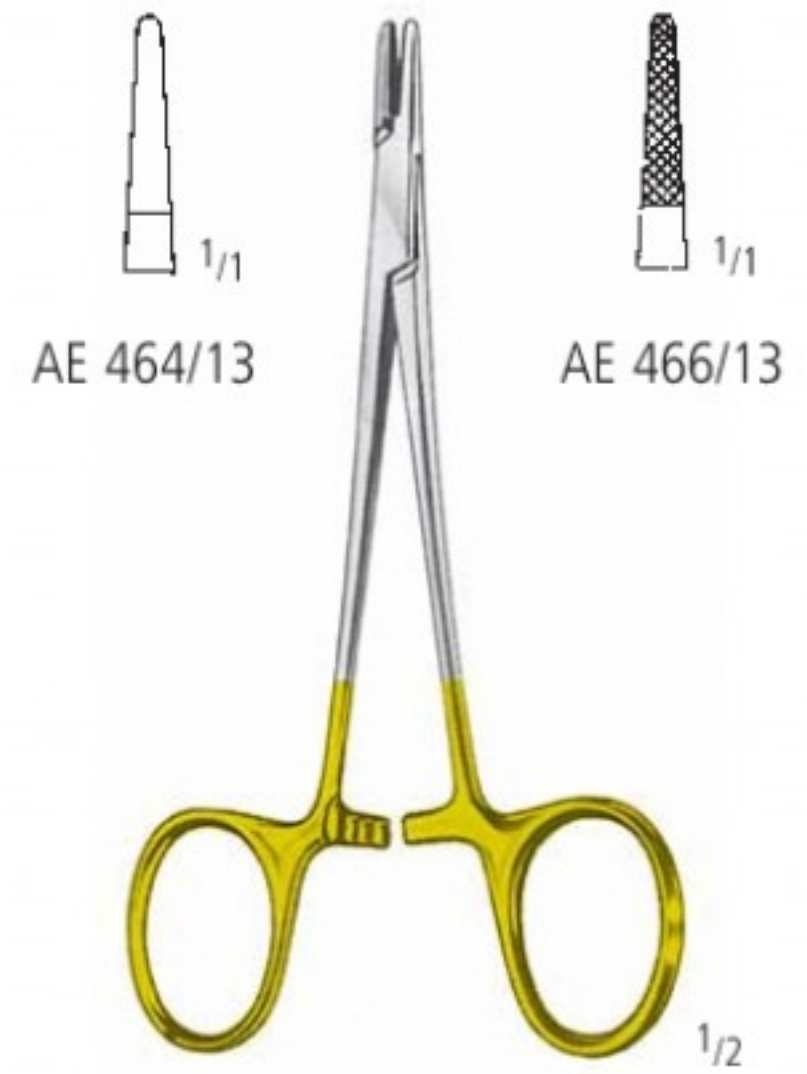

HALSEY
13,0 cm/5"

AE NAHT SUTURE SUTURA SUTURE SUTURA

Nadelhalter mit Hartmetalleinsätzen
 Needle Holders with Tungsten Carbide Inserts
 Porta-agujas con bocas de carburo de tungsteno
 Porte-aiguilles à mors en carbure de tungstène
 Portaghi con placche di carburo di tungsteno



BABY-CRILE-WOOD
 AE 468/15
 15,0 cm/6"



CRILE-WOOD
 AE 469/15
 15,0 cm/6"



CRILE-WOOD
 AE 470/15
 15,0 cm/6"



CRILE-WOOD



AE 470/18
 18,0 cm/7"



AE 470/20
 20,0 cm/8"



AE 470/23
 23,0 cm/9"



AE 471/18
 18,0 cm/7"



AE 471/23
 23,0 cm/9"





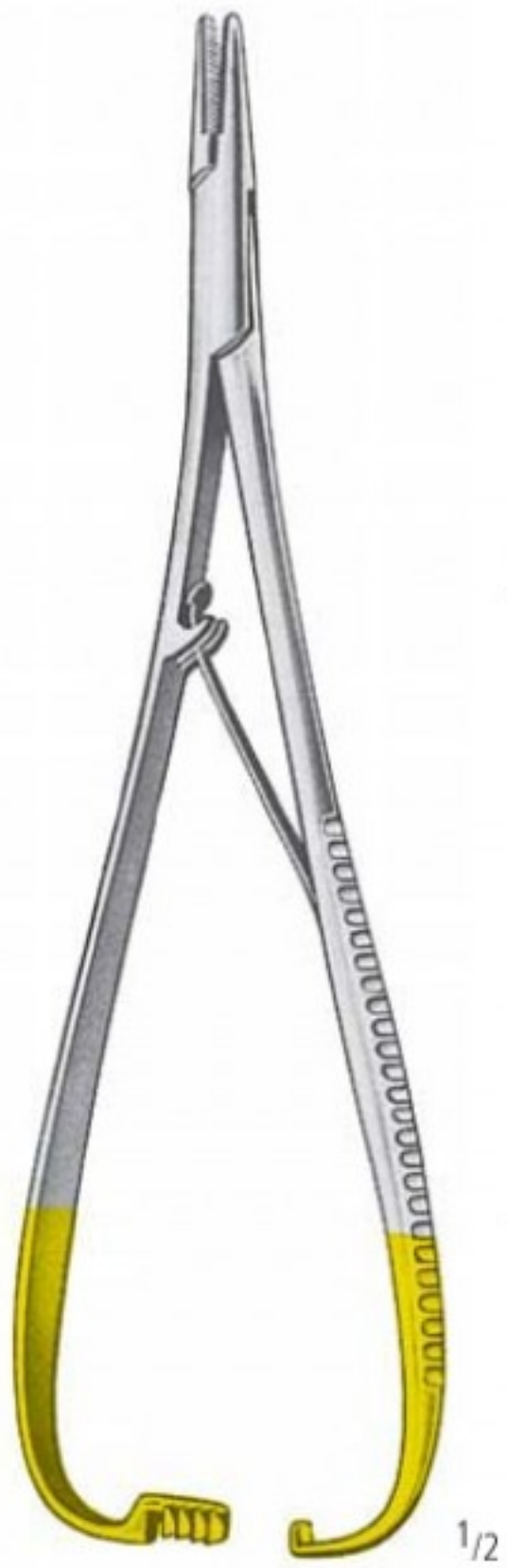

NAHT SUTURE SUTURA SUTURE SUTURA

Nadelhalter mit Hartmetalleinsätzen
 Needle Holders with Tungsten Carbide Inserts
 Porta-agujas con bocas de carburo de tungsteno
 Porte-aiguilles à mors en carbure de tungstène
 Portaghi con placche di carburo di tungsteno





MATHIEU

- | | |
|---|--|
|  1/1 |  1/1 |
| AE 500/14
14,0 cm/5 1/2" | AE 500/17
17,0 cm/6 3/4" |
|  1/1 |  1/1 |
| AE 500/20
20,0 cm/8" | AE 500/24
24,0 cm/9 1/2" |





MATHIEU-DELICATE

- | | |
|---|---|
|  1/1 |  1/1 |
| AE 504/14
14,0 cm/5 1/2" | AE 504/17
17,0 cm/6 3/4" |
| |  1/1 |
| | AE 504/20
20,0 cm/8" |





MATHIEU-RYDER MICRO

- | | |
|---|---|
|  1/1 |  1/1 |
| AE 512/17
17,0 cm/6 3/4" | AE 512/20
20,0 cm/8" |
| |  1/1 |
| | AE 512/24
24,0 cm/9 1/2" |



LANGENBECK

- | | |
|---|---|
|  1/1 |  1/1 |
| AE 540/16
16,0 cm/6 1/4" | AE 540/18
18,0 cm/7" |
| |  1/1 |
| | AE 540/20
20,0 cm/8" |

AA
AB
AC
AE
AK
AO
AR
KA
KS
XR
XT

AE NAHT SUTURE SUTURA SUTURE SUTURA

Nadelhalter mit Hartmetalleinsätzen
 Needle Holders with Tungsten Carbide Inserts
 Porta-agujas con bocas de carburo de tungsteno
 Porte-aiguilles à mors en carbure de tungstène
 Portaghi con placche di carburo di tungsteno



CASTROVIEJO
 14,0 cm/5 1/2"



CASTROVIEJO
 14,0 cm/5 1/2"

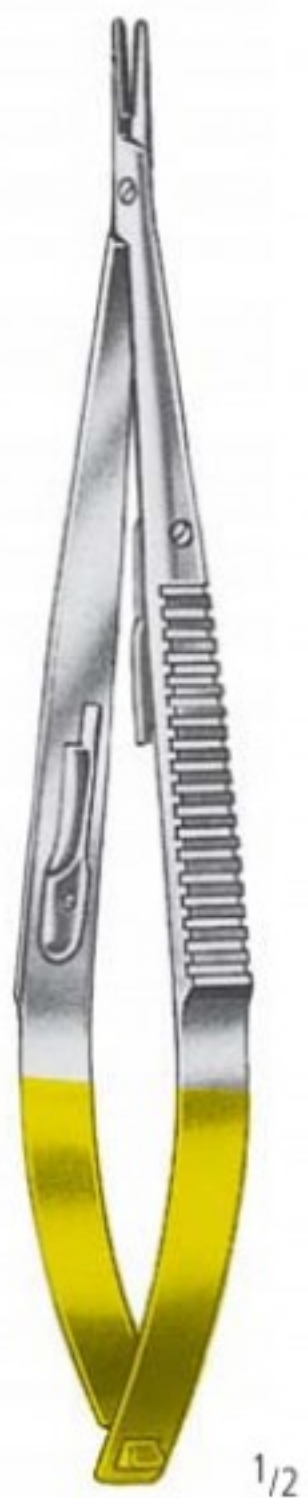

18,0 cm/7"

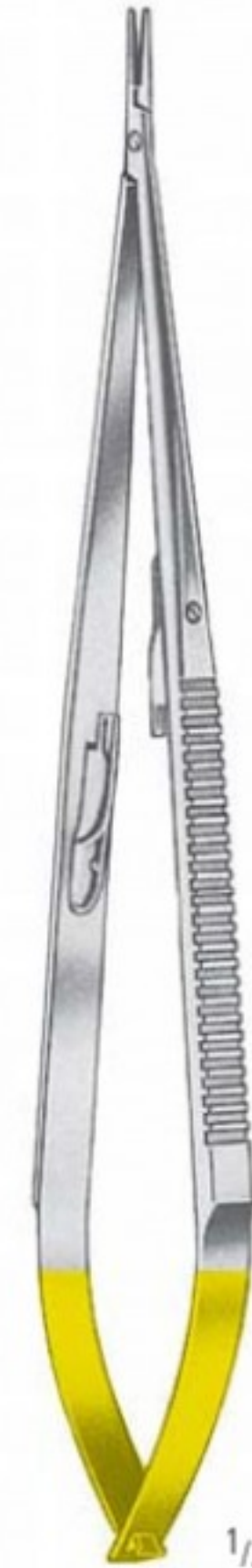
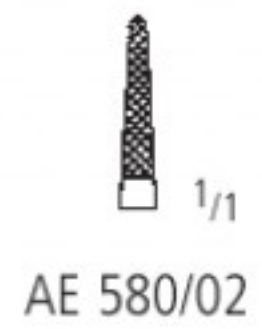
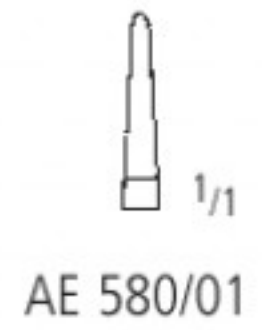

JACOBSON
 21,0 cm/8 1/4"

NAHT SUTURE SUTURA SUTURE SUTURA

Mikro-Nadelhalter mit Rundgriff
 Micro-Needle Holders with pen-type handle
 Micro-porta-agujas con mango redondo
 Micro-porte-aiguilles à manches rondes
 Micro-portaghi con manici rotondi



AE 630/18
 18,0 cm/7¹/₄"



AE 631/18
 18,0 cm/7¹/₄"



AE 632/18
 18,0 cm/7¹/₄"



AE 633/18
 18,0 cm/7¹/₄"

AA
 AB
 AC
AE
 AK
 AO
 AR
 KA
 KS
 XR
 XT

Mikro-Nadelhalter
 Micro-Needle-Holders
 Micro-porta-agujas
 Micro-porte-aiguilles
 Micro-portaghi

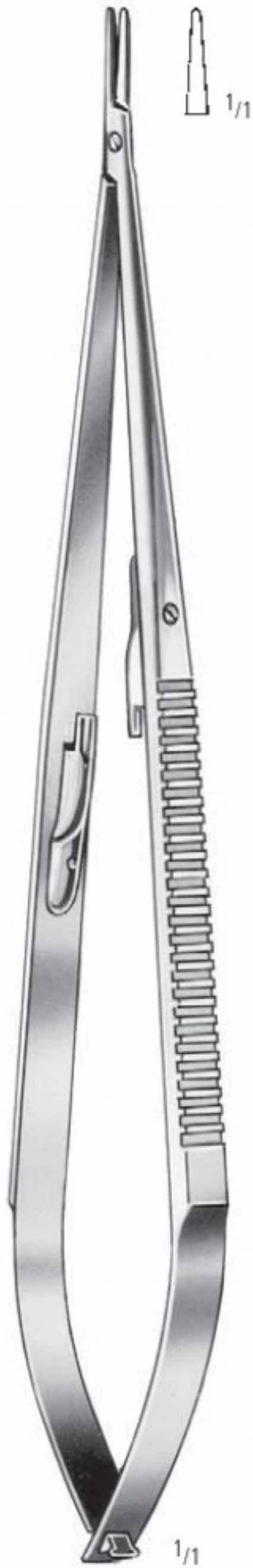

JACOBSON
 AE 678/18
 18,0 cm/7"



AE 680/16
 AE 680/18
 AE 680/20
 AE 680/22

16,0 cm/6 1/2"
 18,0 cm/7"
 20,0 cm/8"
 22,0 cm/9"

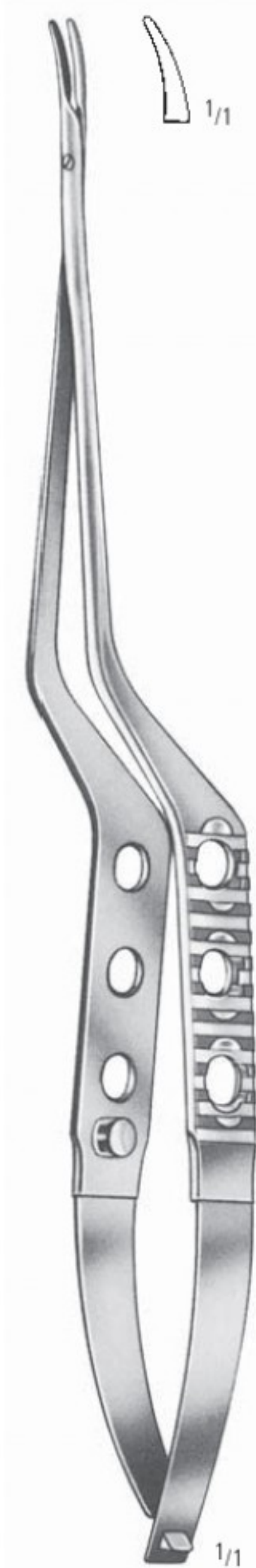

AE 681/16
 AE 681/18
 AE 681/20
 AE 681/22

Weitere Nadelhalter siehe Katalog A 176-209 und Gruppe KS.
 For further needle holders see catalogue A 176-209 and section KS.
 Para otras porta-agujas ver catálogo A 176-209 y sección KS.
 D'autres porte-aiguilles voir notre catalogue A 176-209 et groupe KS.
 Per altri portaghi consultare il nostro catalogo A 176-209 e gruppo KS.

WUNDHAKEN
RETRACTORS
SEPARADORES
ECARTEURS
DIVARICATORI

AK

nopa[®] instruments



AK WUNDHAKEN RETRACTORS SEPARADORES ECARTEURS DIVARICATORI

Feine Wundhaken
 Delicate Hooks
 Ganchos
 Crochets très fins
 Divaricatori sottili



GILLIES
 AK 020/01
 18,0 cm/7"



GILLIES
 AK 020/02
 18,0 cm/7"



KILNER
 AK 022/15
 15,0 cm/6"



FRAZIER
 AK 024/13
 13,0 cm/5"



AK 026/01



KLEINERT-KUTZ
 AK 026/02
 16,0 cm/6¹/₄"



AK 026/03

WUNDHAKEN RETRACTORS SEPARADORES ECARTEURS DIVARICATORI

Feine Wundhaken
Delicate Hooks
Ganchos
Crochets très fins
Divaricatori sottili

AA

AB

AC

AE

AK

AO

AR

KA

KS

XR

XT



CUSHING
28,0 cm/11"



AK 034/01



AK 034/02



CUSHING
19,0 cm/7¹/₄"



AK 036/01



AK 036/02

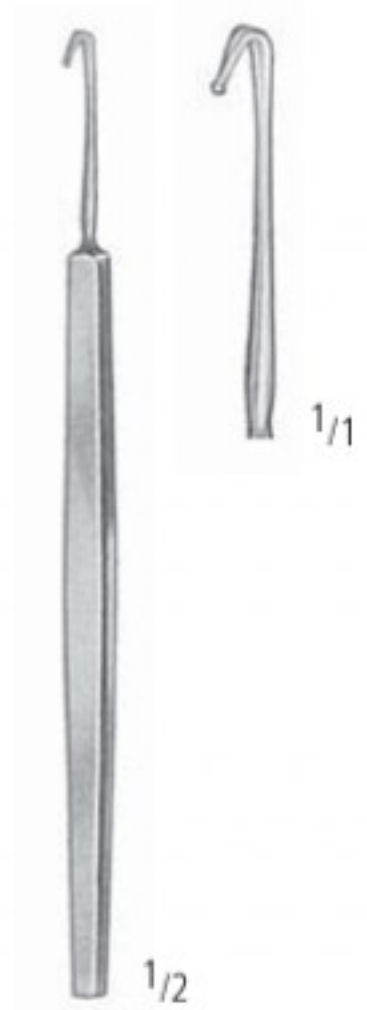

MOLDESTAD
AK 038/13
13,0 cm/5"



17,0 cm/6³/₄"



AK 040/05
5 mm

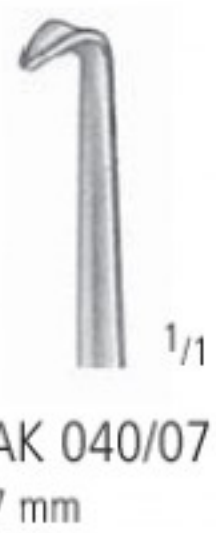

AK 040/07
7 mm



18,5 cm/7¹/₄"

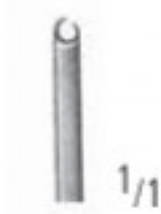

AK 042/10
Ø 1,0 mm



AK 042/12
Ø 1,2 mm

Weitere feine Wundhaken siehe Gruppe KS.
For further delicate hooks see section KS.
Para otros ganchos ver sección KS.
D'autres crochets très fins voir groupe KS.
Per altri divaricatori sottili vedi gruppo KS.



AK 044/11
11,0 cm/4¹/₄"

Spinalhaken
 Spinal Retractors
 Separadores espinales
 Ecarteurs spinals
 Divaricatori spinali



CUSHING
 AK 130/20
 20,0 cm/8"



TAYLOR
 16,5 cm/6 1/2"

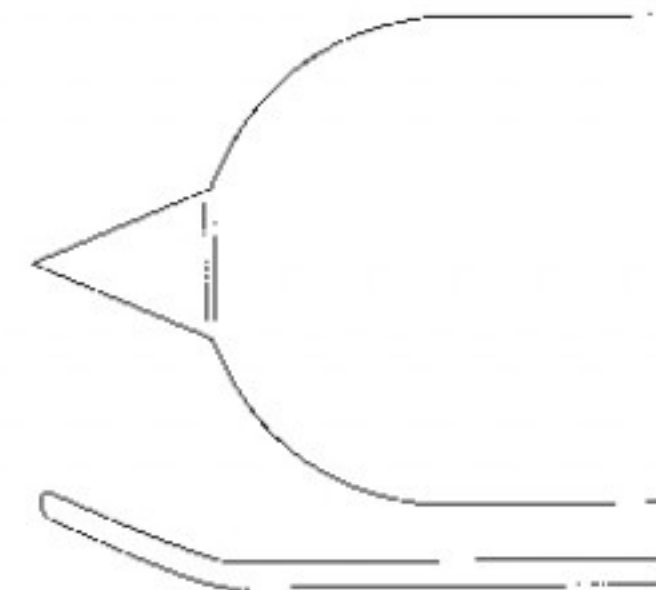

AK 132/07
 75 x 30 mm

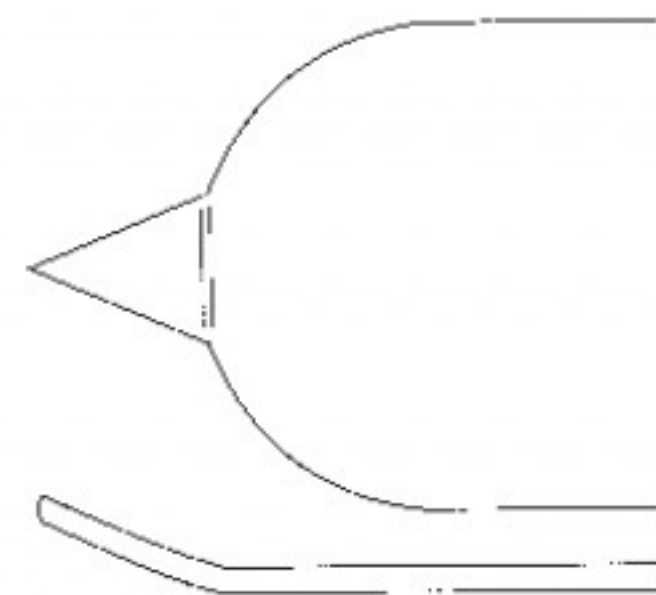

AK 132/10
 100 x 30 mm



AK 320/16
50 x 16 mm



AK 320/25
75 x 25 mm



AK 320/50
90 x 50 mm

MEYERDING
22,5 cm/9"

AK WUNDHAKEN RETRACTORS SEPARADORES ECARTEURS DIVARICATORI

Selbthaltende Wundsperrer
 Selfretaining Retractors
 Separadores autoestaticos
 Ecarteurs autostatiques
 Divaricatori autostatici

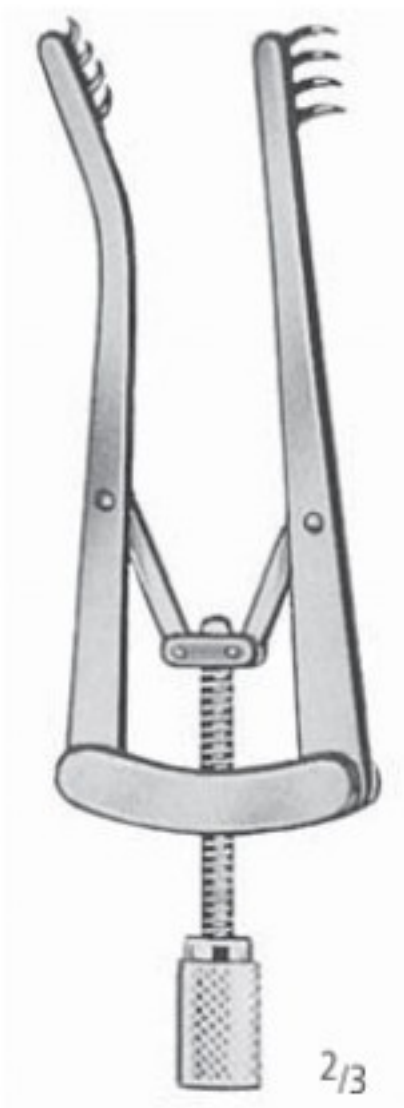

ALM

- | | | |
|---|--|------------|
| ∧ | 7,0 cm/2 ³ / ₄ " | 10,0 cm/4" |
| ∩ | AK 506/07 | AK 506/10 |
| ∩ | AK 507/07 | AK 507/10 |



JANSEN

- | | | | |
|------------|-----------|---|-----------|
| ∧ | AK 510/10 | ∩ | AK 511/10 |
| 10,0 cm/4" | | | |



JANSEN

- | | | | |
|------------|-----------|---|-----------|
| ∧ | AK 512/10 | ∩ | AK 513/10 |
| 10,0 cm/4" | | | |



SNITMAN

- | | | | |
|---|-----------|---|-----------|
| ∧ | AK 514/10 | ∩ | AK 515/10 |
| 10,5 cm/4 ¹ / ₄ " | | | |

WUNDHAKEN RETRACTORS SEPARADORES ECARTEURS DIVARICATORI

Selbsthaltende Wundsperrer
Selfretaining Retractors
Separadores autoestaticos
Ecarteurs autostatiques
Divaricatori autostatici

AA
AB
AC
AE
AK
AO
AR
KA
KS
XR
XT



WEITLANER

10,5 cm/4¹/₄"
13,0 cm/5"
16,5 cm/6¹/₂"
20,0 cm/8"
25,0 cm/10"
26,0 cm/10¹/₂"

2 x 3
3 x 4
3 x 4
3 x 4
3 x 4
5 x 6

^
AK 522/10
AK 524/13
AK 526/16
AK 528/20
AK 530/25
AK 532/26

∩
AK 523/10
AK 525/13
AK 527/16
AK 529/20
AK 531/25
AK 533/26



ANDERSON-ADSON

^ ∩
AK 556/20 AK 557/20
20,0 cm/8"

Selbsthaltende Wundsperrer
 Selfretaining Retractors
 Separadores autoestaticos
 Ecarteurs autostatiques
 Divaricatori autostatici



ADSON
 AK 560/27
 27,0 cm/10¹/₂"



ADSON - R
 AK 561/01
 27,0 cm/10¹/₂"



ADSON - L
 AK 561/02
 27,0 cm/10¹/₂"

WUNDHAKEN RETRACTORS SEPARADORES ECARTEURS DIVARICATORI

Selbsthaltende Wundsperrer
Selfretaining Retractors
Separadores autoestaticos
Ecarteurs autostatiques
Divaricatori autostatici



CONE

13,0 cm/5"	3 x 4
16,5 cm/6 ¹ / ₂ "	3 x 4
20,0 cm/8"	3 x 4
25,0 cm/10"	3 x 4

^
AK 564/13
AK 564/16
AK 564/20
AK 564/25

∩
AK 565/13
AK 565/16
AK 565/20
AK 565/25

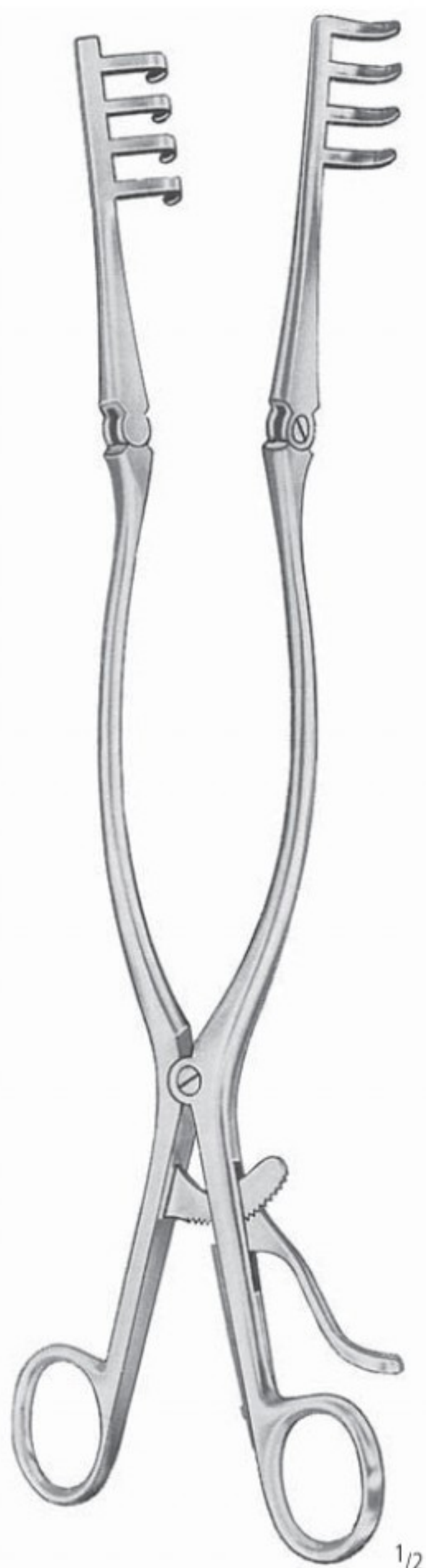

BECKMANN

31,0 cm/12"	4 x 4
33,0 cm/13"	4 x 5

^
AK 566/31
AK 568/33

∩
AK 567/31
AK 569/33

AA

AB

AC

AE

AK

AO

AR

KA

KS

XR

XT

Selbsthaltende Wundsperrer
 Selfretaining Retractors
 Separadores autoestaticos
 Ecarteurs autostatiques
 Divaricatori autostatici



25 x 25 mm
 25 x 31 mm
 25 x 40 mm
 25 x 45 mm

^
 AK 570/01
 AK 570/02
 AK 570/03
 AK 570/04

∩
 AK 571/01
 AK 571/02
 AK 571/03
 AK 571/04

BECKMANN-ADSON
 31,0 cm/12"



BECKMANN-EATON
 ^ ∩
 AK 572/33 AK 573/33
 33,0 cm/13"

Selbsthaltende Wundsperrer
Selfretaining Retractors
Separadores autoestaticos
Ecarteurs autostatiques
Divaricatori autostatici



SCALP-CONTOUR
 AK 574/14 AK 575/14
 14,0 cm/5 1/2"

Weitere Wundhaken siehe Katalog A 239-294 und Gruppe KS.
For further retractors see catalogue A 239-294 and section KS.
Para otros separadores ver catálogo A 239-294 y sección KS.
D'autres écarteurs voir notre catalogue A 239-294 et groupe KS.
Per altri divaricatori consultare il nostro catalogo A 239-294 e gruppo KS.

AA

AB

AC

AE

AK

AO

AR

KA

KS

XR

XT

PUNKTION/KANÜLEN
PUNCTURE/SPECIAL NEEDLES
PUNCION/AGUJAS ESPECIALES
PUNCTION/AIGUILLES SPECIALES
PUNTURA/AGHI SPECIALI

A0

nopa[®] instruments



Saugrohre
Suction Tubes
Tubos de aspiración
Canules d'aspiration
Cannule di aspirazione

complete with suction tube
+ cannula 0,4 mm
+ cannula 0,6 mm
+ cannula 0,8 mm



FRAZIER

6 Charr.	AO 430/06
8 Charr.	AO 430/08
10 Charr.	AO 430/10
12 Charr.	AO 430/12

PLESTER

1,5 mm	AO 432/15
2,0 mm	AO 432/20
2,5 mm	AO 432/25
3,0 mm	AO 432/30

FERGUSSON

5 Charr.	AO 434/05
6 Charr.	AO 434/06
7 Charr.	AO 434/07
8 Charr.	AO 434/08
9 Charr.	AO 434/09
10 Charr.	AO 434/10
12 Charr.	AO 434/12

**WULLSTEIN
MICRO**
AO 438/00

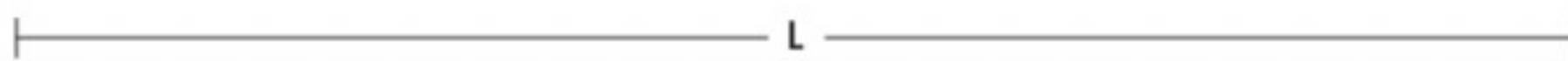

	L	L	L	L
	130 mm	150 mm	180 mm	220 mm
Ø 1,5 mm	AO 440/13	AO 440/15	AO 440/18	AO 440/22
Ø 2,0 mm	AO 441/13	AO 441/15	AO 441/18	AO 441/22
Ø 2,5 mm	AO 442/13	AO 442/15	AO 442/18	AO 442/22
Ø 3,5 mm	AO 443/13	AO 443/15	AO 443/18	AO 443/22



ADSON
AO 450/04
21,0 cm/8 1/4"
4,0 mm

DIAGNOSTIK
DIAGNOSTICS
DIAGNOSTICO
DIAGNOSTIC
DIAGNOSTICA

AR

nopa[®] instruments



Perkussionshämmer
 Percussion Hammers
 Martillos de percusión
 Marteaux-percuteurs
 Martelli percussori



BUCK
 AR 200/18
 18,0 cm/7"

BABINSKY
 AR 205/22
 22,0 cm/8³/₄"
 Ø 40 mm

RABINER
 AR 208/23
 23,0 cm/9"
 Ø 40 mm

TAYLOR
 18,0 cm/7" AR 215/18
 20,0 cm/8" AR 215/20

Perkussionshämmer
 Percussion Hammers
 Martillos de percusión
 Marteaux-percuteurs
 Martelli percussori

AA

AB

AC

AE

AK

AO

AR

KA

KS

XR

XT

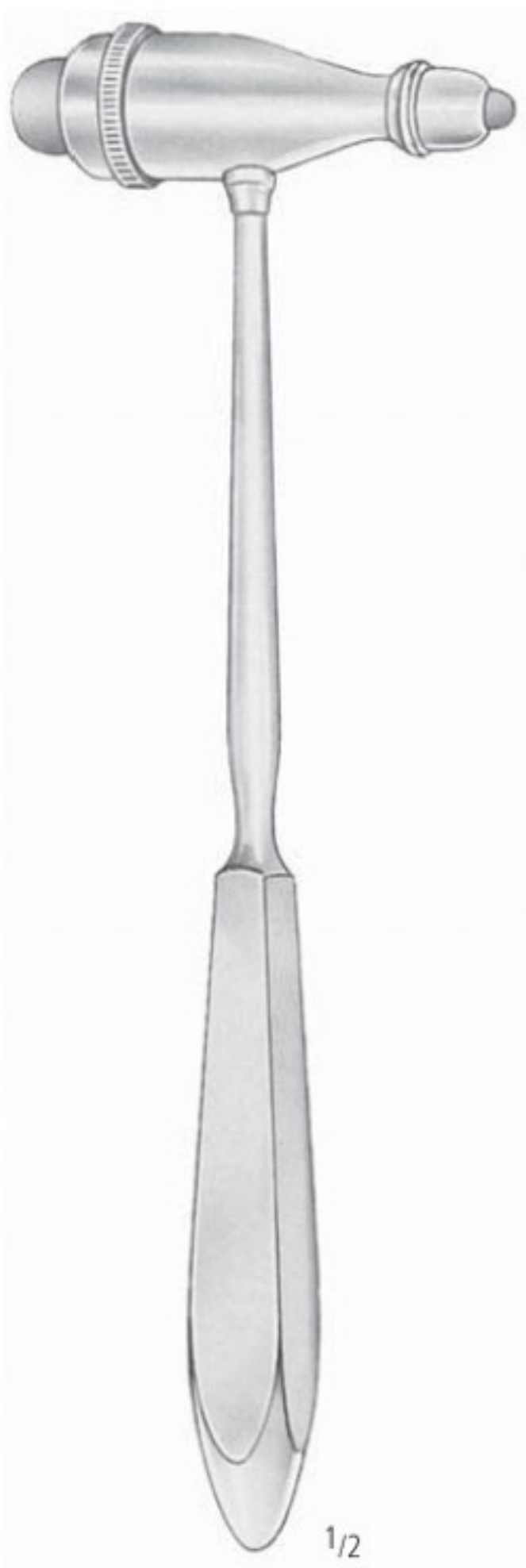

TROEMNER
 AR 216/24
 24,0 cm/9¹/₂"



DÉJERINE
 AR 217/20
 20,0 cm/8"



DÉJERINE
 AR 218/20
 20,0 cm/8"

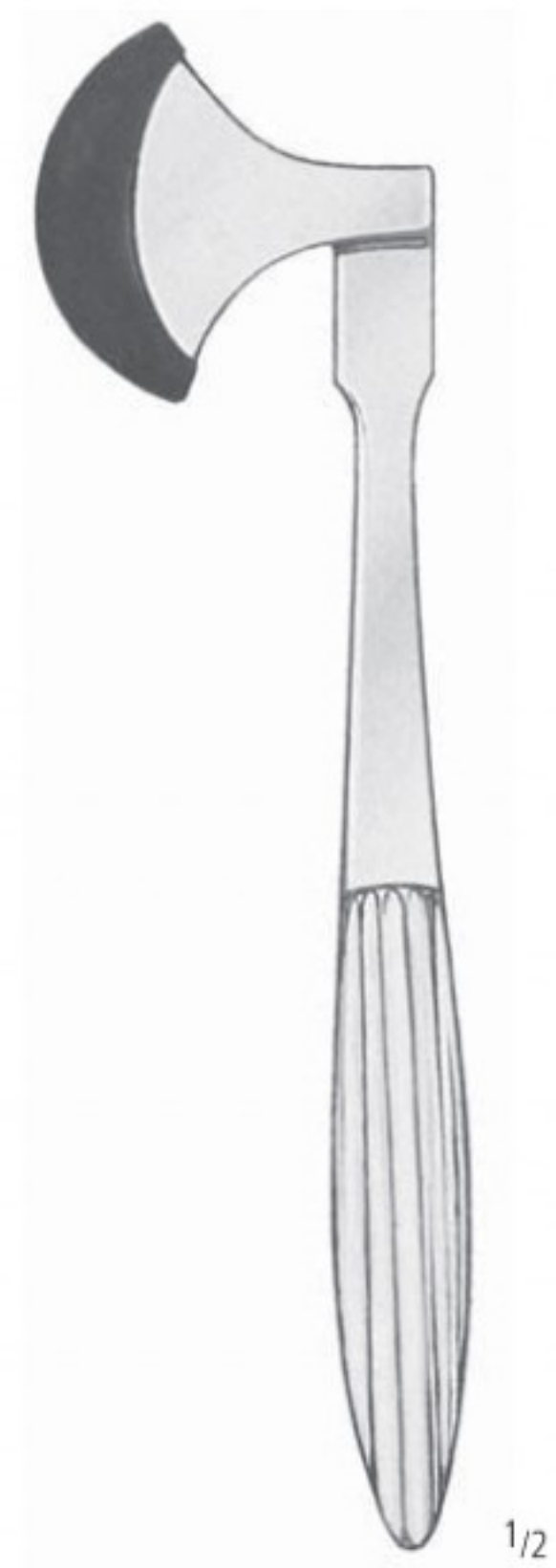

BERLINER
 AR 220/20
 20,0 cm/8"

Sensibilitäts-Instrumente
 Sensibility Instruments
 Instrumentos sensibilidad
 Instruments sensibilités
 Strumenti per sensibilità



ALY
 AR 300/00
 19,0 cm/7¹/₂"



WARTENBERG
 AR 301/00
 18,0 cm/8"

ORTHOPÄDIE
ORTHOPAEDICS
ORTOPEDIA
ORTHOPEDIE
ORTOPEDIA

KA

nopa[®] instruments



Handbohrapparate
 Hand Drills
 Perforadores de mano
 Perforateurs à main
 Perforatori a mano



← KA 060/90

STILLE
 KA 060//00
 20,0 cm/8"

komplett mit
 complete with
 completo con
 complet avec
 completo con

Fig. 1-9
 Fig. 1-9
 Fig. 1-9
 Fig. 1-9
 Fig. 1-9



Fig. 1
 KA 060/01
 Ø 2,5 mm



Fig. 2
 KA 060/02
 Ø 3,0 mm



Fig. 3
 KA 060/03
 Ø 3,5 mm



Fig. 4
 KA 060/04
 Ø 4,0 mm



Fig. 5
 KA 060/05
 Ø 10,0 mm



Fig. 6
 KA 060/06
 Ø 5,0 mm



Fig. 7
 KA 060/07
 Ø 8,0 mm



Fig. 8
 KA 060/08
 Ø 12,0 mm



Fig. 9
 KA 060/09
 Ø 16,0 mm



Fig. 10
 KA 060/10
 Ø 1,0 mm



Fig. 11
 KA 060/11
 Ø 1,5 mm



Fig. 12
 KA 060/12
 Ø 2,0 mm

Handbohrapparate
 Hand Drills
 Perforadores de mano
 Perforateurs à main
 Perforatore a mano

AA

AB

AC

AE

AK

AO

AR

KA

KS

XR

XT



RALK
 KA 100/00



1/2

Ø 1,0 mm	KA 102/10
Ø 1,5 mm	KA 102/15
Ø 2,0 mm	KA 102/20
Ø 2,7 mm	KA 102/27
Ø 3,0 mm	KA 102/30
Ø 3,2 mm	KA 102/32
Ø 3,5 mm	KA 102/35
Ø 4,0 mm	KA 102/40
Ø 4,5 mm	KA 102/45
Ø 5,0 mm	KA 102/50
Ø 6,0 mm	KA 102/60
Ø 7,0 mm	KA 102/70
Ø 8,0 mm	KA 102/80
Ø 9,0 mm	KA 102/90
Ø 10,0 mm	KA 102/99

ORTHOPÄDIE ORTHOPAEDICS ORTOPEDIA ORTHOPEDIE ORTOPEDIA

Maßtabelle
 Scale
 Tabla de medida
 Tableau de la mesure
 Scala

AA

AB

AC

AE

AK

AO

AR

KA

KS

XR

XT



2,0 mm



3,0 mm



4,0 mm



5,0 mm



6,0 mm



8,0 mm



10,0 mm



12,0 mm



14,0 mm



16,0 mm



18,0 mm

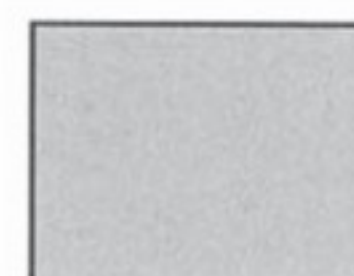

20,0 mm

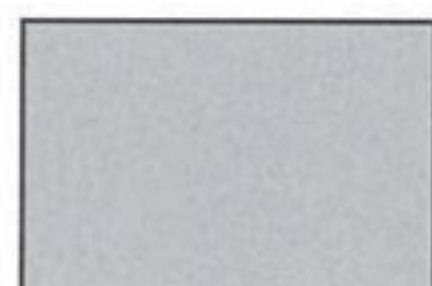

25,0 mm

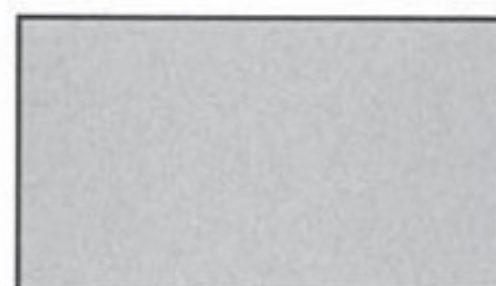

30,0 mm

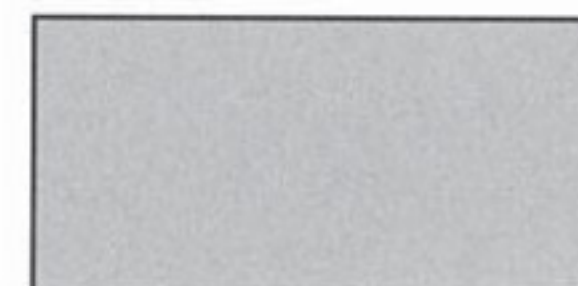

35,0 mm

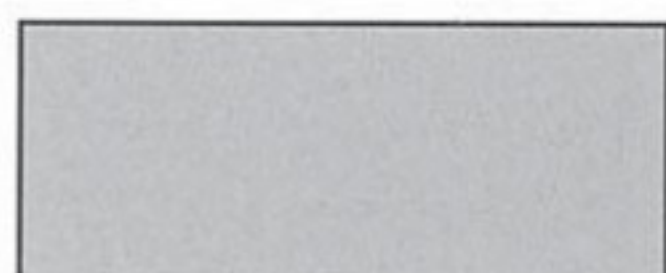

40,0 mm

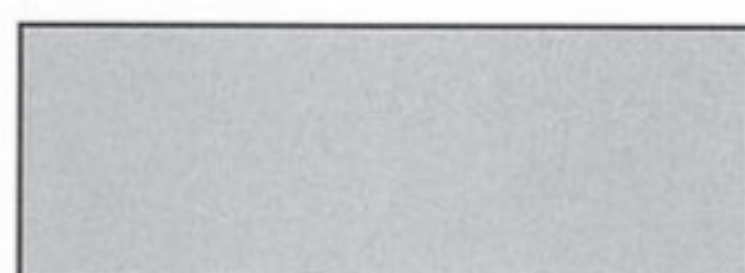

45,0 mm

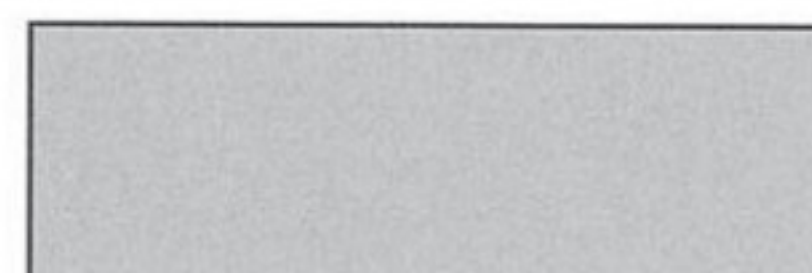

50,0 mm

Meißel und Osteotome
 Chisels, Gouges and Osteotomes
 Cinceles y Gubias
 Ciseaux-Burins et Ostéotomes
 Scalpelli, Osteotomi, Sgorbie



MINI-LEXER
 18,0 cm/7"

MINI-LEXER
 18,0 cm/7"

LEXER
 22,0 cm/8³/₄"

LEXER
 22,0 cm/8³/₄"

mm	KA 470/04	KA 471/04		
4	KA 470/06	KA 471/06		
6			KA 472/07	KA 473/07
7				
8	KA 470/08	KA 471/08		
10	KA 470/10	KA 471/10	KA 472/10	KA 473/10
12	KA 470/12	KA 471/12		
15	KA 470/15	KA 471/15	KA 472/15	KA 473/15
20	KA 470/20	KA 471/20	KA 472/20	KA 473/20
25			KA 472/25	KA 473/25
30			KA 472/30	KA 473/30

Ferrozellgriff
 Hartpress-Handle
 Mango en "Ferrozell"
 Manche en "Ferrozell"
 Manico in "Ferrozell"

ORTHOPÄDIE ORTHOPAEDICS ORTOPEDIA ORTHOPEDIE ORTOPEDIA

Meißel und Osteotome
 Chisels, Gouges and Osteotomes
 Cinceles y Gubias
 Ciseaux-Burins et Ostéotomes
 Scalpelli, Osteotomi, Sgorbie

AA

AB

AC

AE

AK

AO

AR

KA

KS

XR

XT



LEXER
 27,5 cm/10³/₄"

mm
 5
 10
 15

KA 474/10
 KA 474/15



LEXER
 27,5 cm/10³/₄"

KA 475/10
 KA 475/15



LEXER
 25,0 cm/10"

KA 476/05
 KA 476/10
 KA 476/15



LEXER
 25,0 cm/10"

KA 477/05
 KA 477/10
 KA 477/15

Ferrozellgriff
 Hartpress-Handle
 Mango en "Ferrozell"
 Manche en "Ferrozell"
 Manico in "Ferrozell"

Meißel und Osteotome
 Chisels, Gouges and Osteotomes
 Cinceles y Gubias
 Ciseaux-Burins et Ostéotomes
 Scalpelli, Osteotomi, Sgorbie

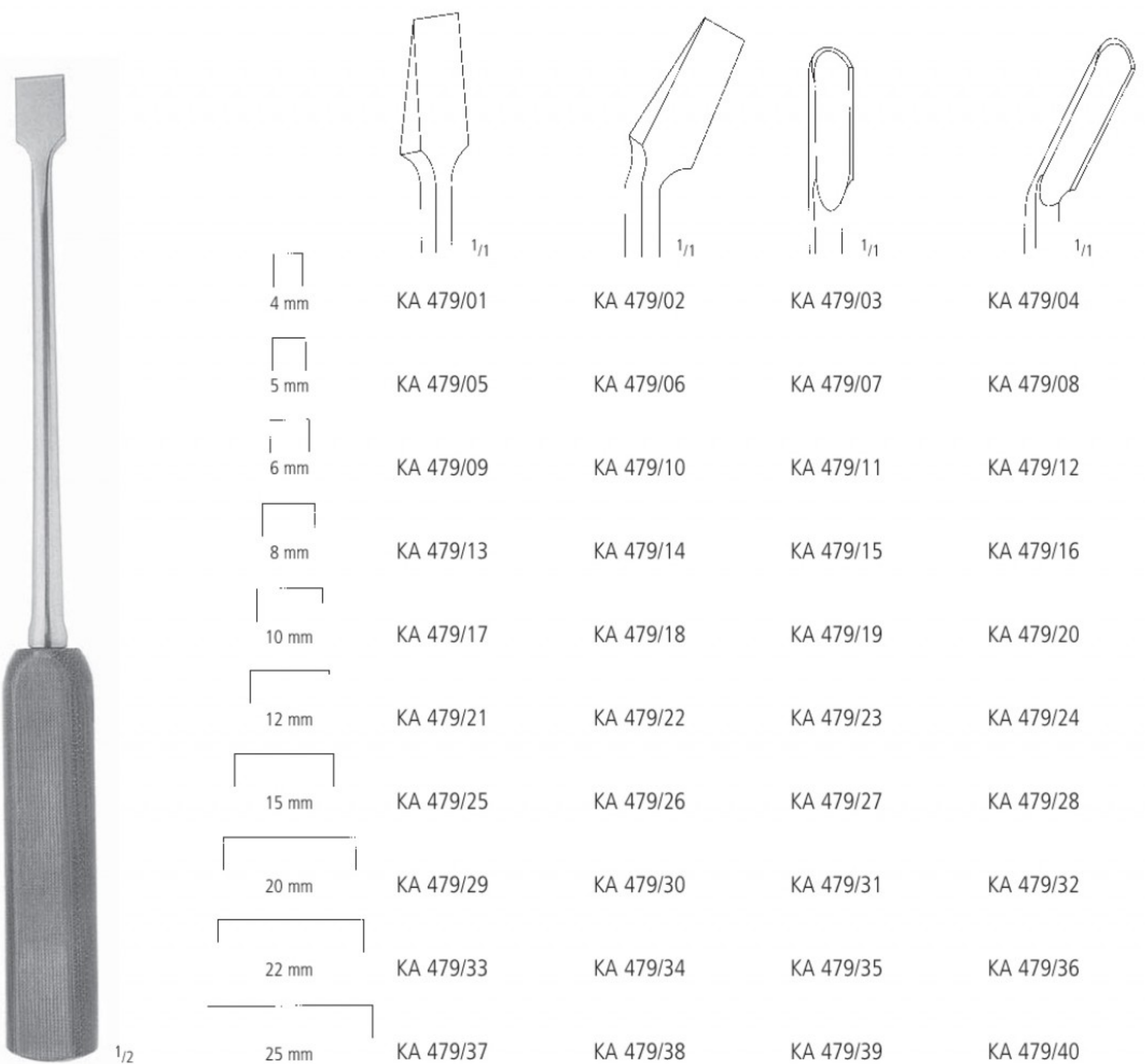

DAHMEN
 30,0 cm/12"

Ferrozellgriff
 Hartpress-Handle
 Mango en "Ferrozell"
 Manche en "Ferrozell"
 Manico in "Ferrozell"

Hämmer
Mallets
Martillos
Marteaux
Martelli

AA

AB

AC

AE

AK

AO

AR

KA

KS

XR

XT



550 g
(19 1/2 oz.)

1/2

OMBREDANNE

KA 519/55
24,0 cm/9 1/2"

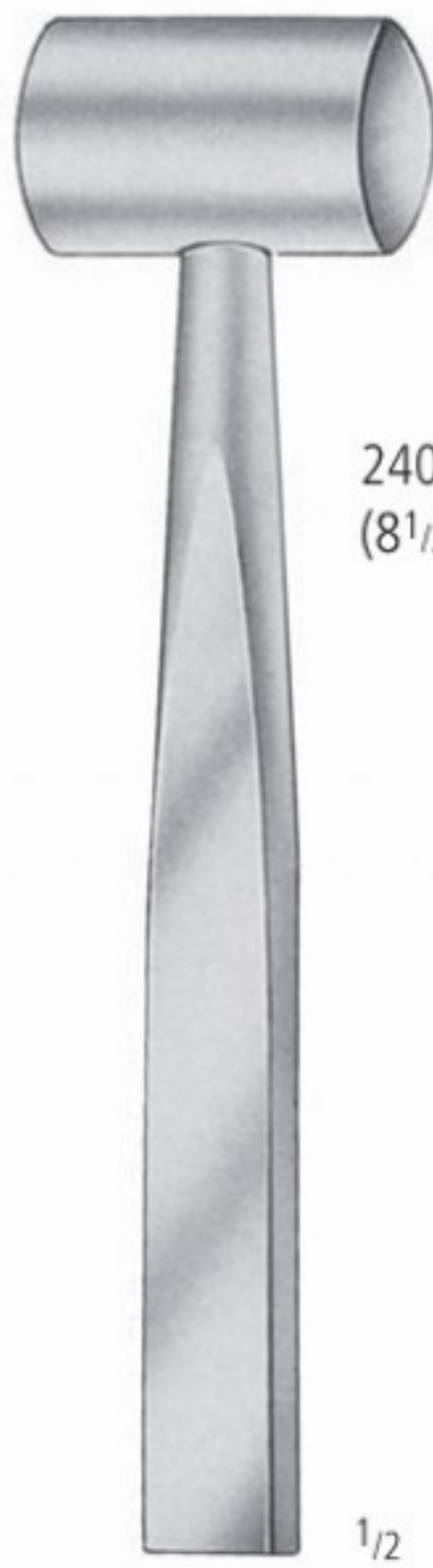

240 g
(8 1/2 oz.)

1/2

COTTLE

KA 531/24
19,0 cm/7 1/2"

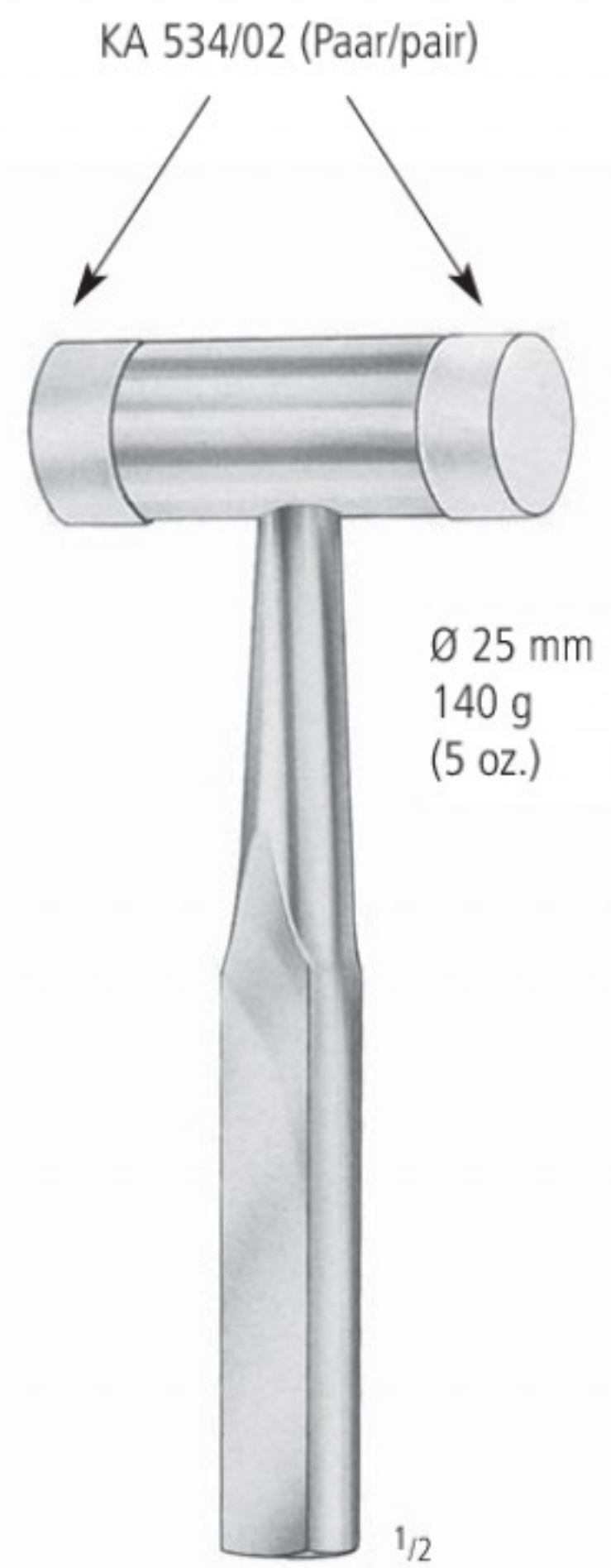

KA 534/02 (Paar/pair)

Ø 25 mm
140 g
(5 oz.)

1/2

KA 534/14
18,0 cm/7"

Hämmer
Mallets
Martillos
Marteaux
Martelli

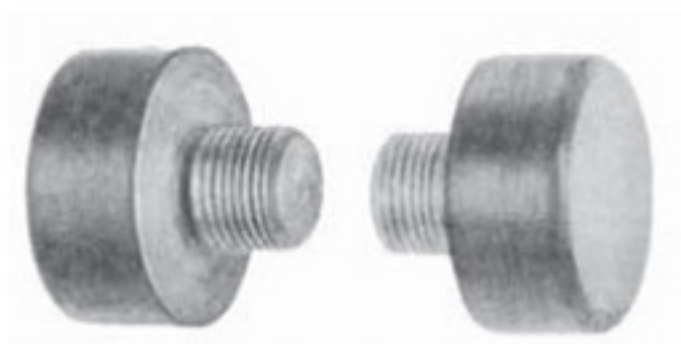

KA 554/90

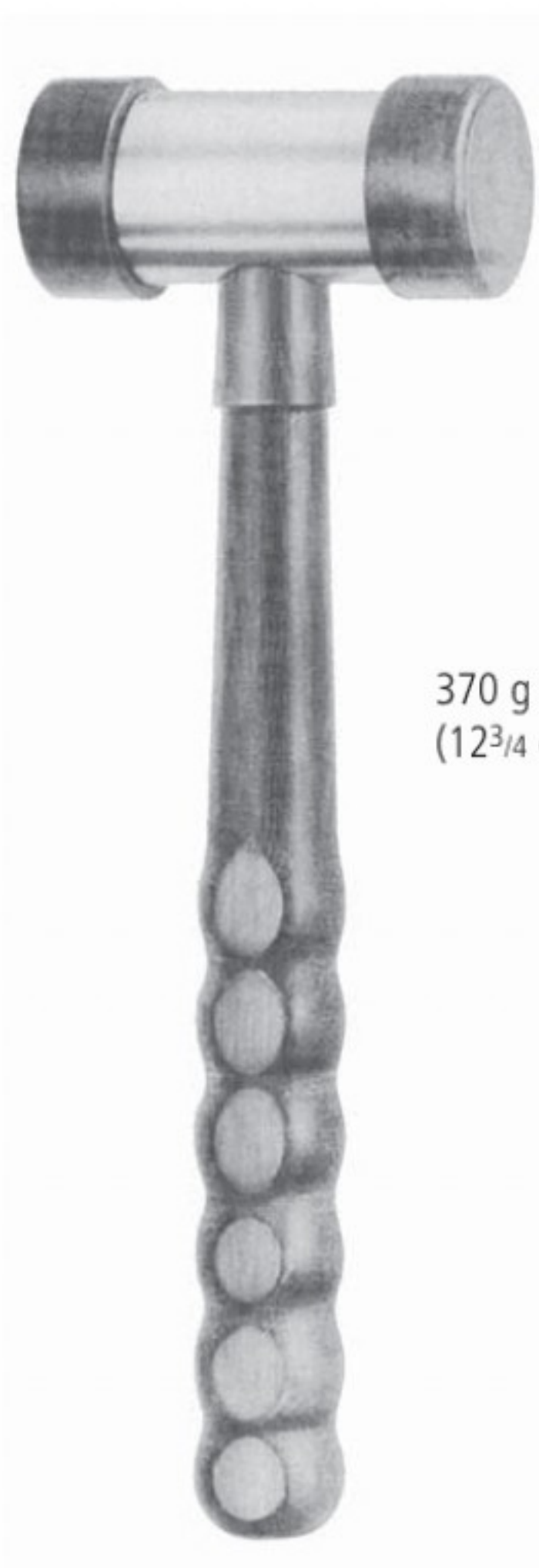

370 g
(12³/₄ oz.)

KA 554/37
Ferozell



125 g
(4¹/₄ oz.)

KA 555/13
Ferozell

Scharfe Löffel
 Bone Curettes
 Cucharillas cortantes
 Curettes tranchantes
 Curette taglienti

AA

AB

AC

AE

AK

AO

AR

KA

KS

XR

XT

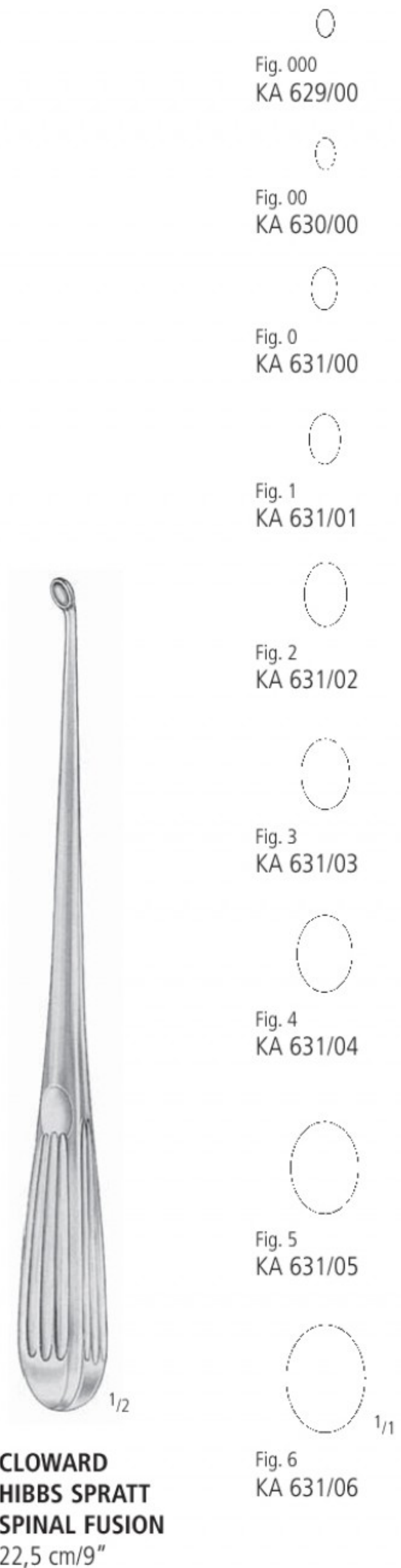
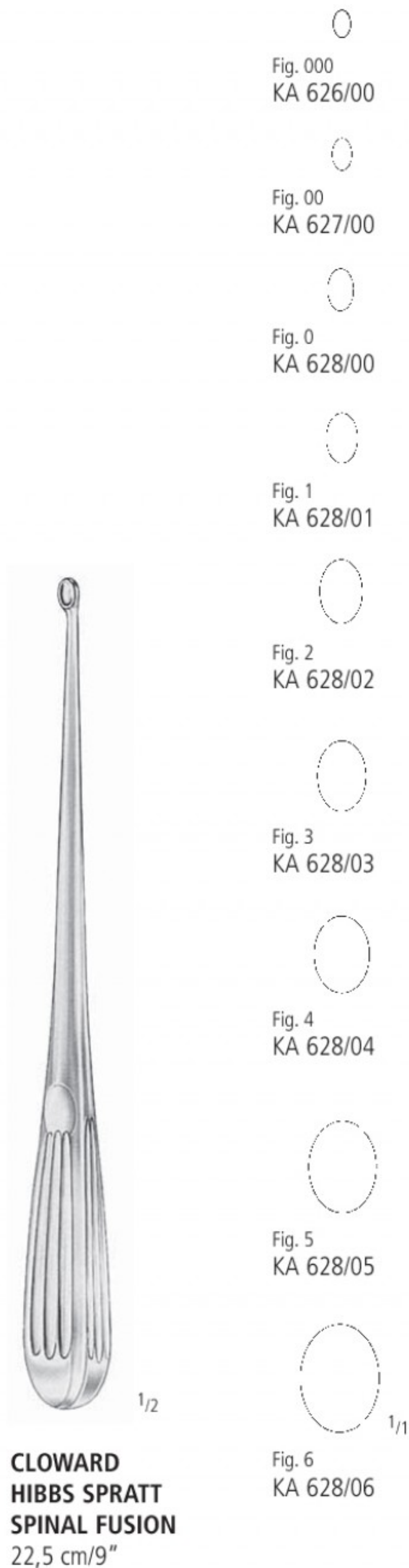

Elevatoren
Elevators
Elevadores
Elévateurs
Elevatori

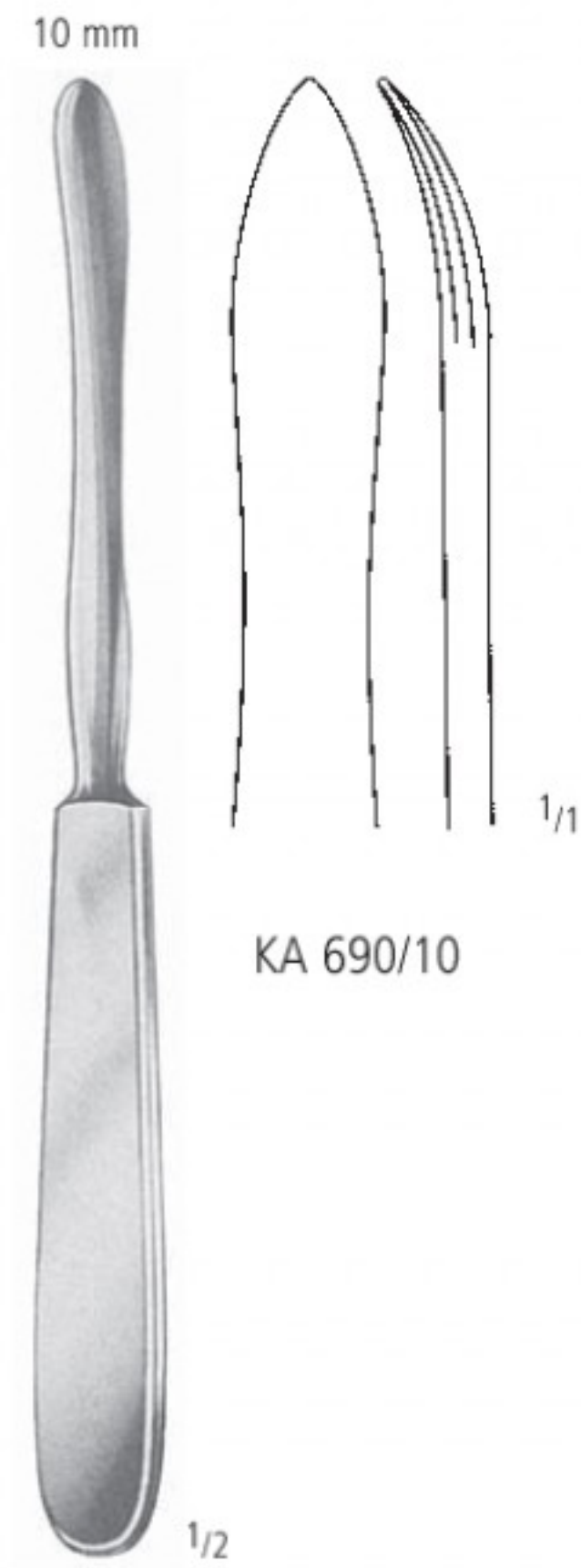

LANGENBECK
19,5 cm/7³/₄"



FREER
19,0 cm/7¹/₂"



FREER
KA 703/18
18,0 cm/7"

Elevatori
Elevators
Elevadores
Elévateurs
Elevatori

AA

AB

AC

AE

AK

AO

AR

KA

KS

XR

XT



1/2

HOEN

7 mm



1/1

KA 704/07
16,0 cm/6 1/4"

15 mm

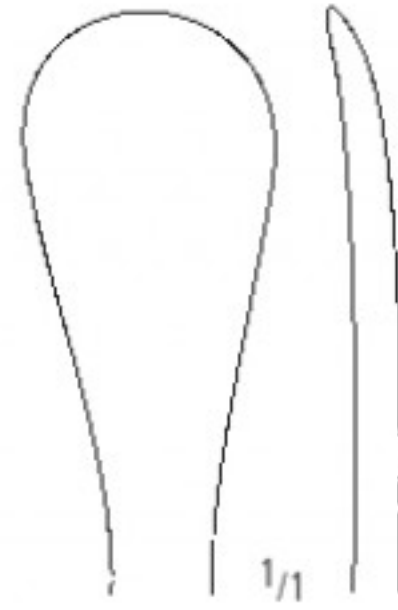

1/1

KA 704/15
19,0 cm/7 1/2"

20 mm

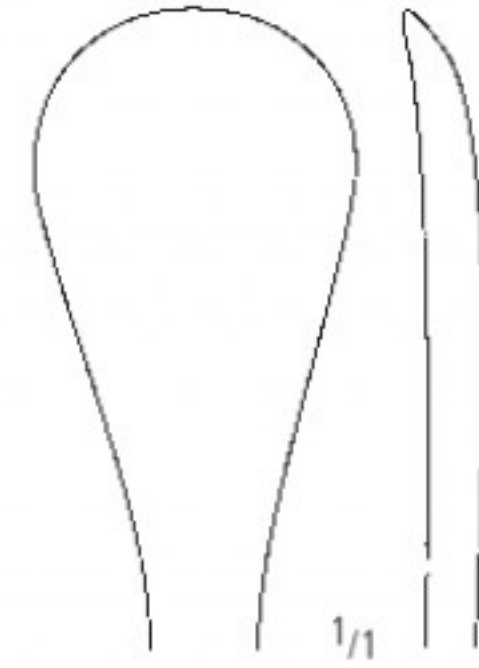

1/1

KA 704/20
19,0 cm/7 1/2"



1/2

ADSON

17,0 cm/6 3/4"



1/1

KA 705/01



1/1

KA 705/02



1/1

KA 705/03



1/1

KA 705/04

Hohlmeisselzangen
 Bone Rongeurs
 Pinzas-gubias
 Pincès-gouges
 Pinze-sgorbie

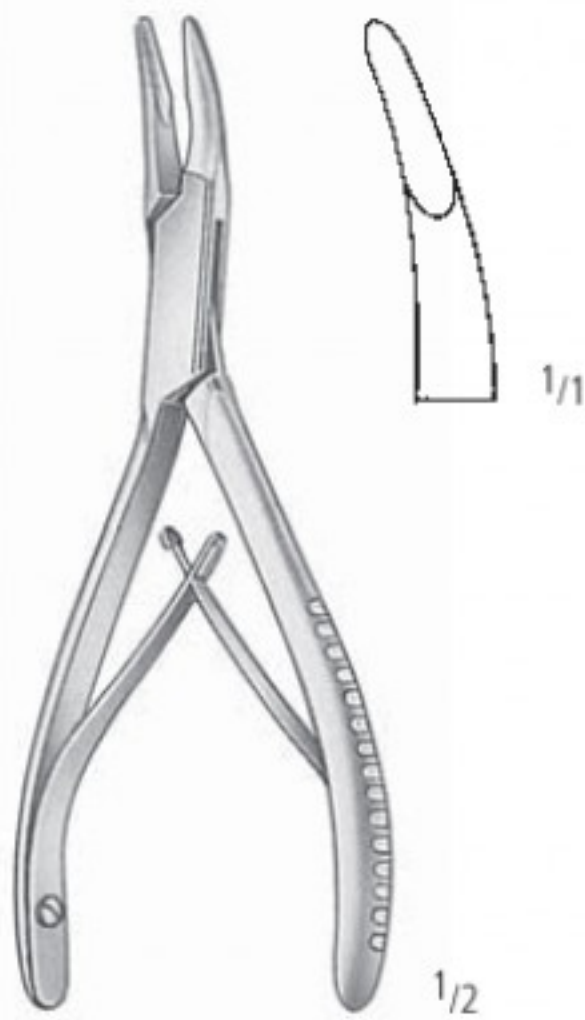

MINI-FRIEDMAN
 KA 800/12
 12,0 cm/5"

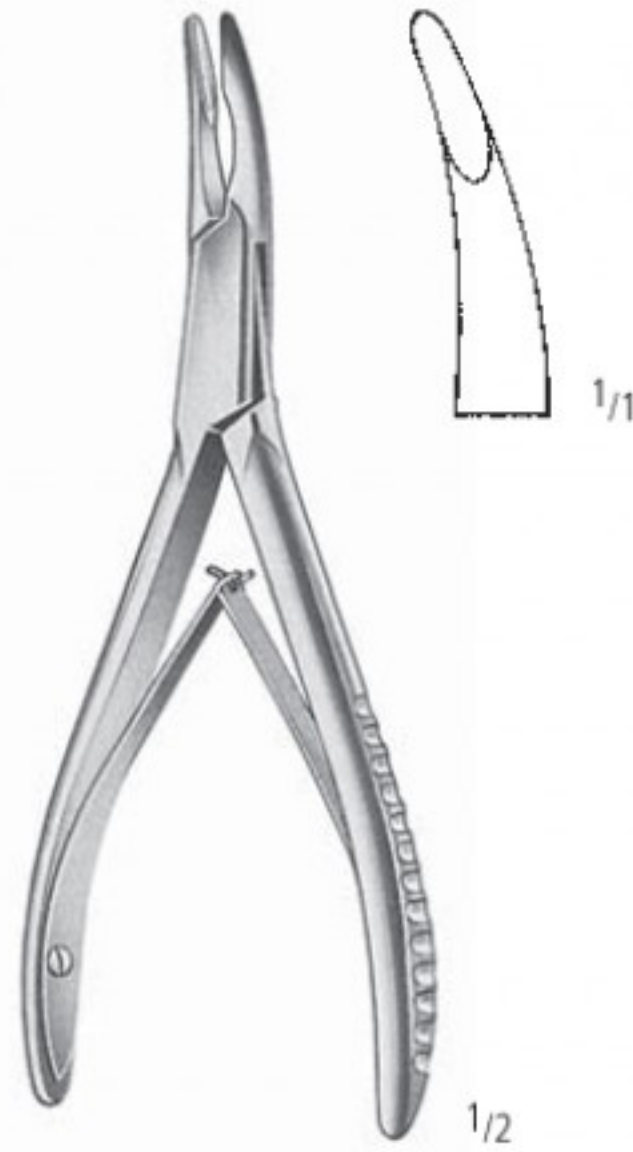

FRIEDMAN
 KA 800/14
 14,0 cm/5 1/2"

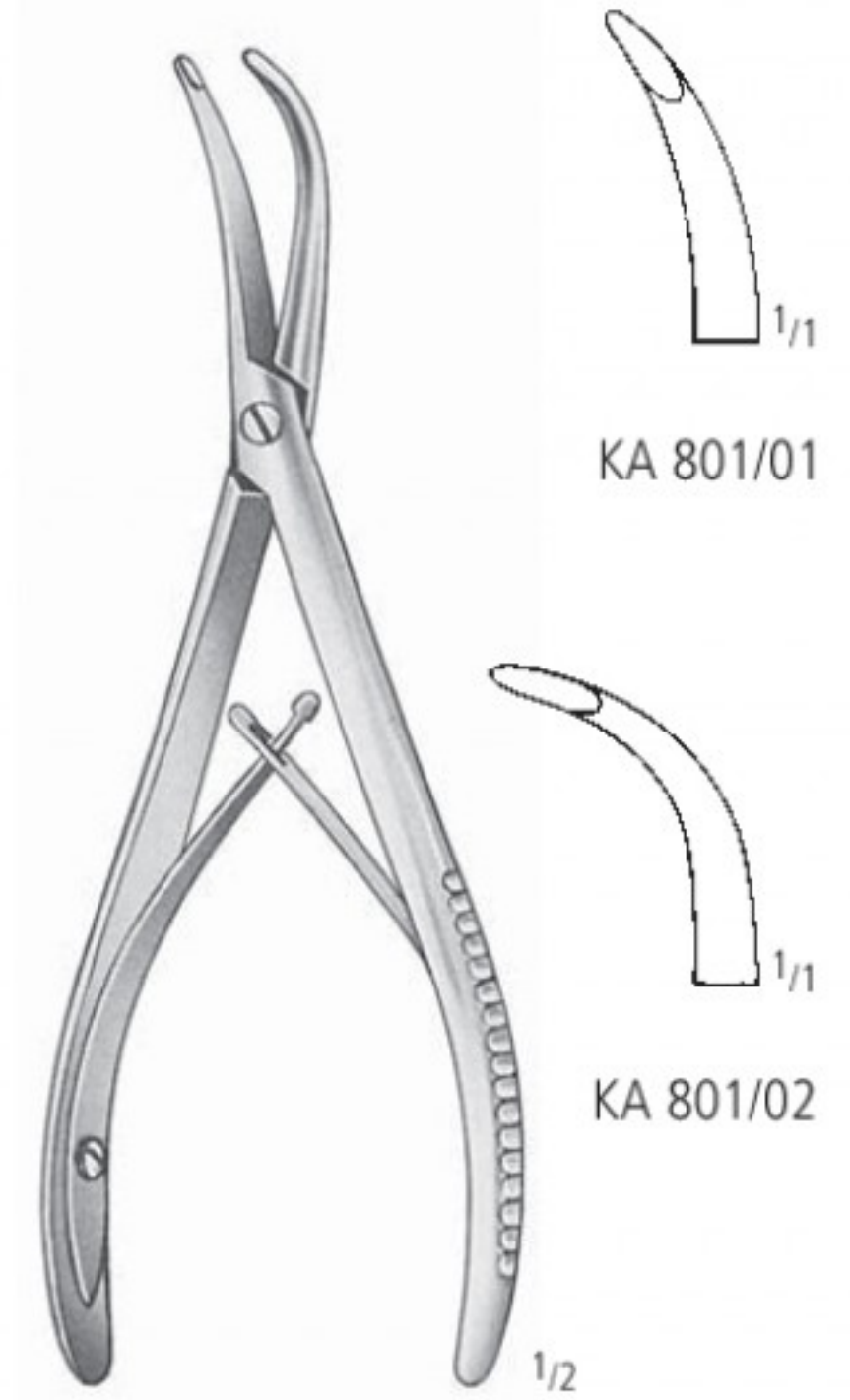

STELLBRINK
 17,0 cm/6 3/4"

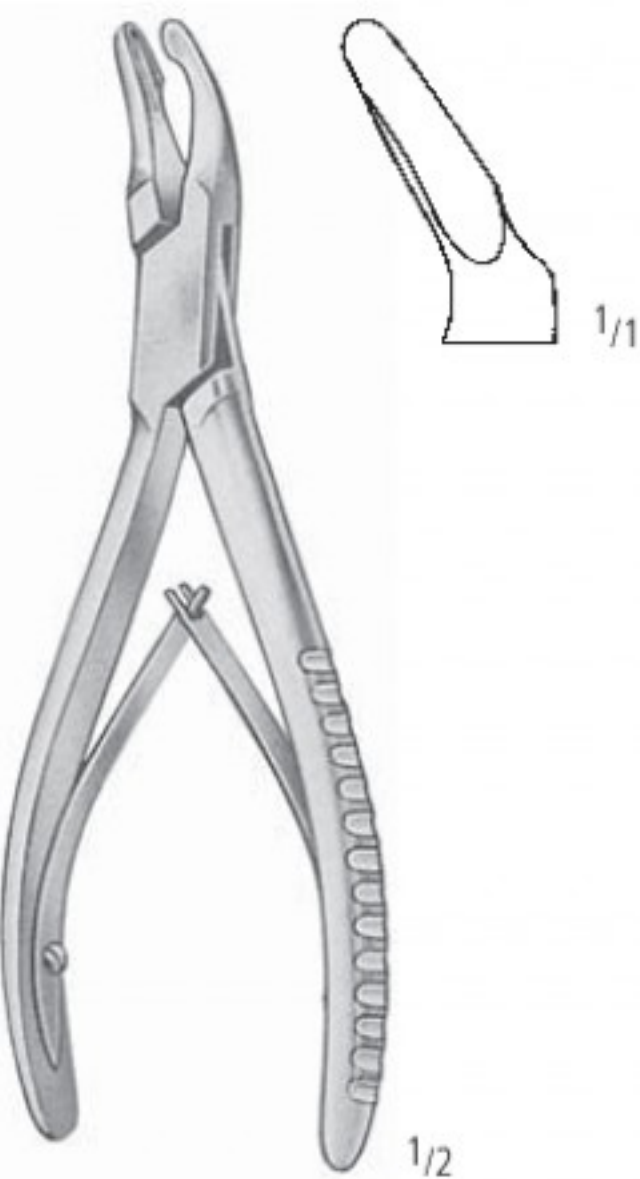

CLEVELAND
 KA 802/14
 14,0 cm/5 1/2"

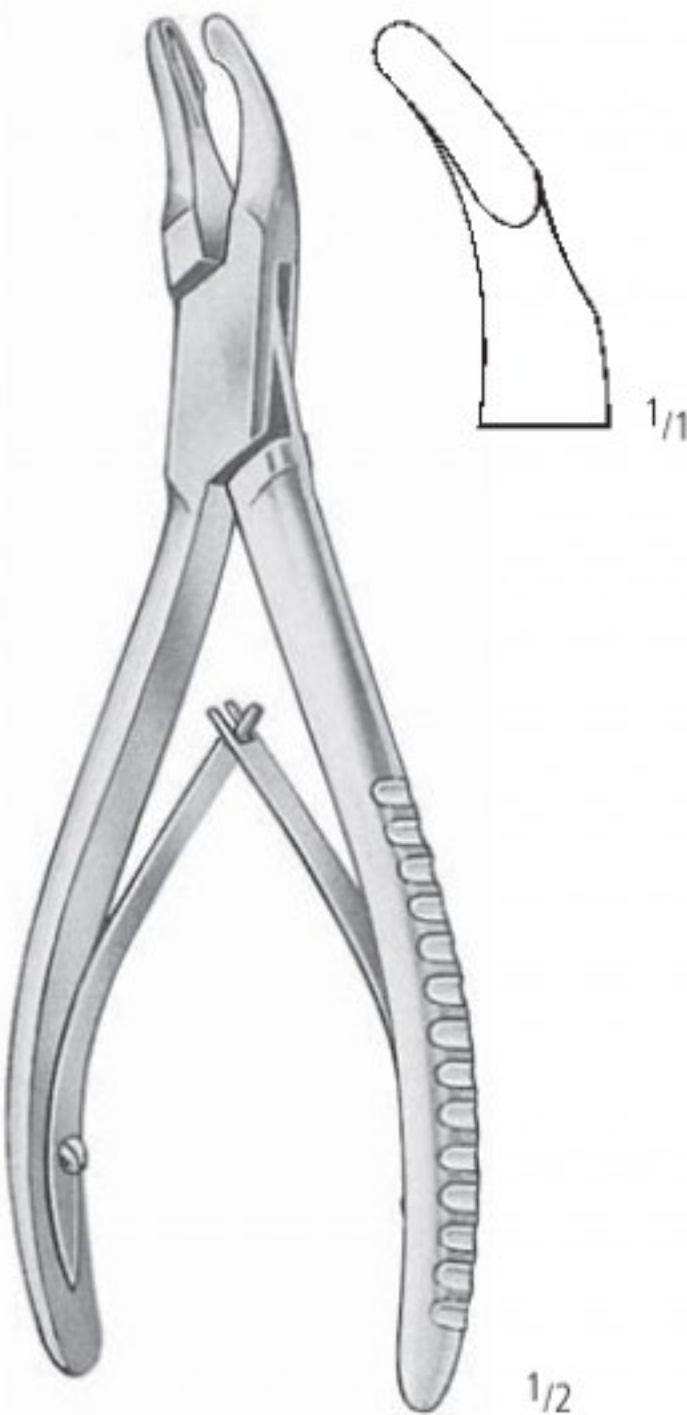

CLEVELAND
 KA 802/17
 17,0 cm/6 3/4"

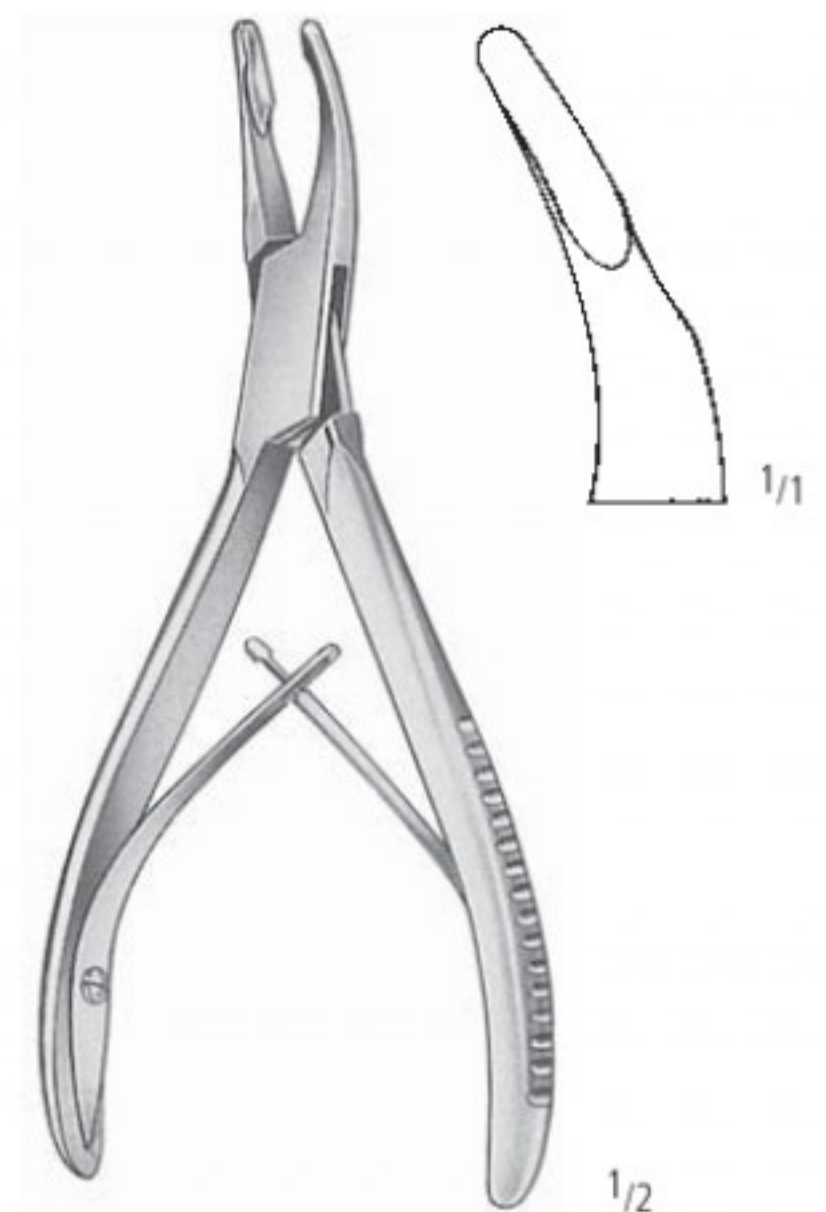

UNIVERSAL
 KA 803/13
 13,5 cm/5 1/4"

Hohlmeisselzangen
 Bone Rongeurs
 Pinzas-gubias
 Pincis-gouges
 Pinze-sgorbie

AA

AB

AC

AE

AK

AO

AR

KA

KS

XR

XT



MEAD
 16,5 cm/6¹/₂"



HARTMANN
 KA 807/18
 18,5 cm/7¹/₄"

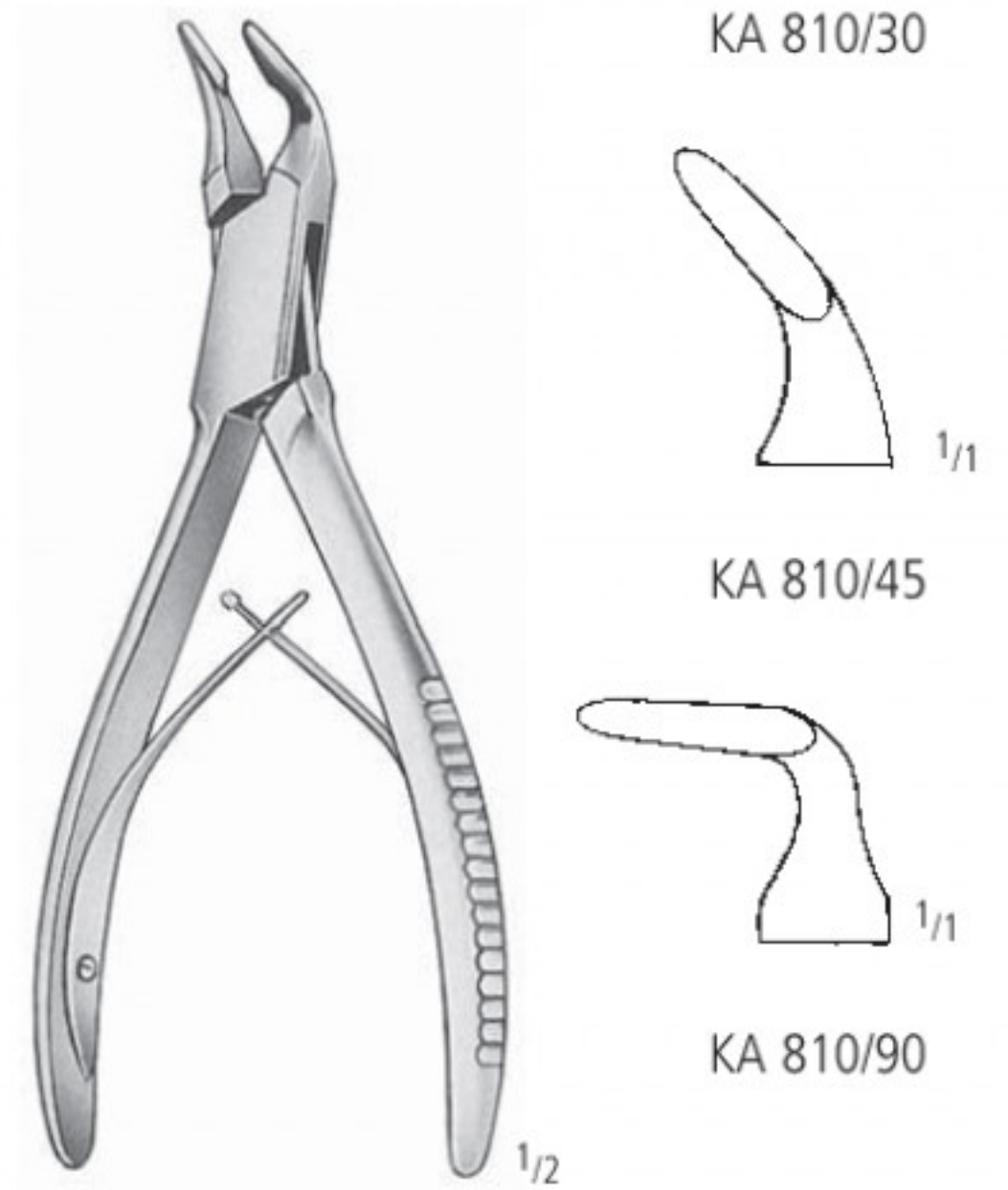

BLUMENTHAL
 15,5 cm/6"

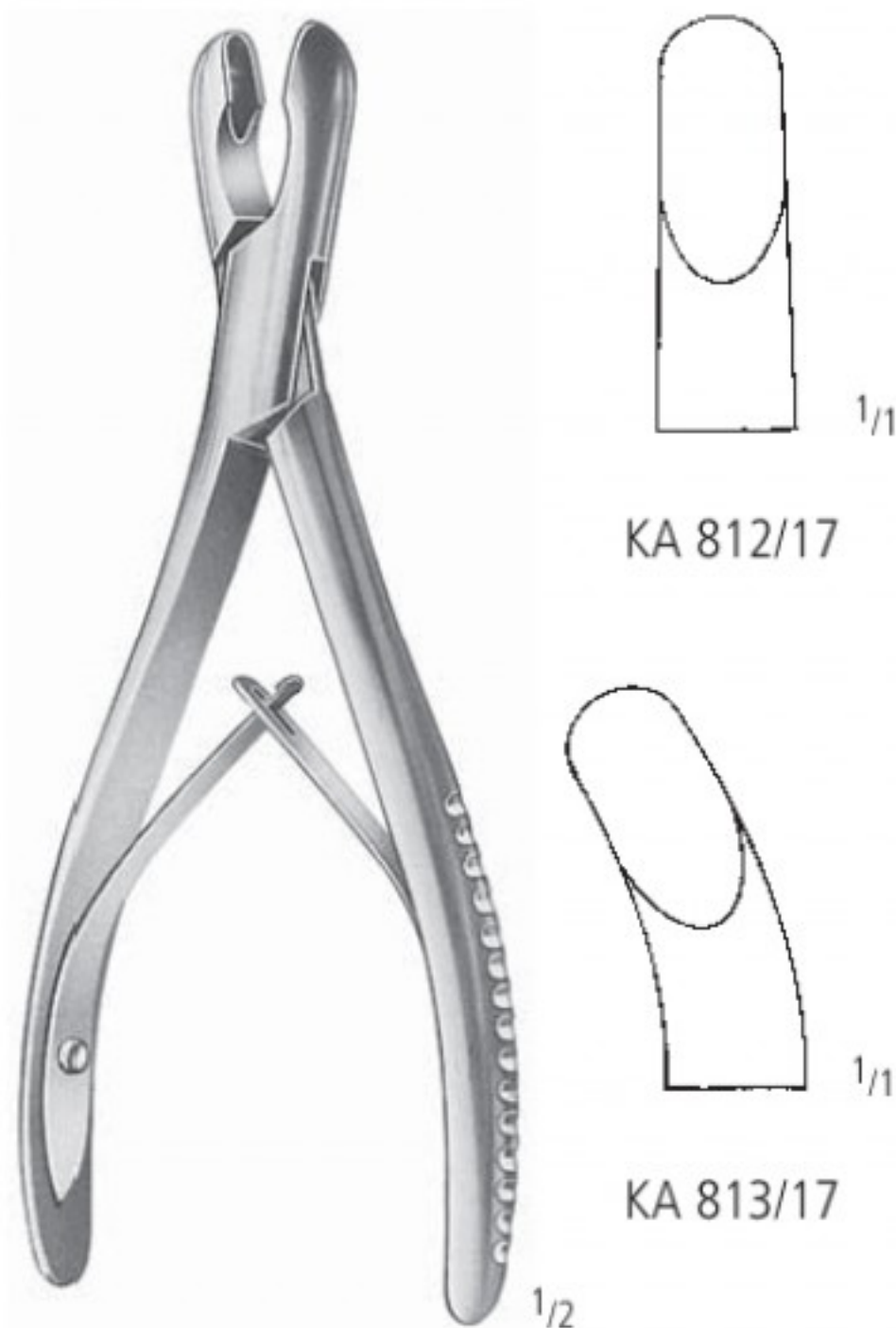

LUER
 17,0 cm/6³/₄"

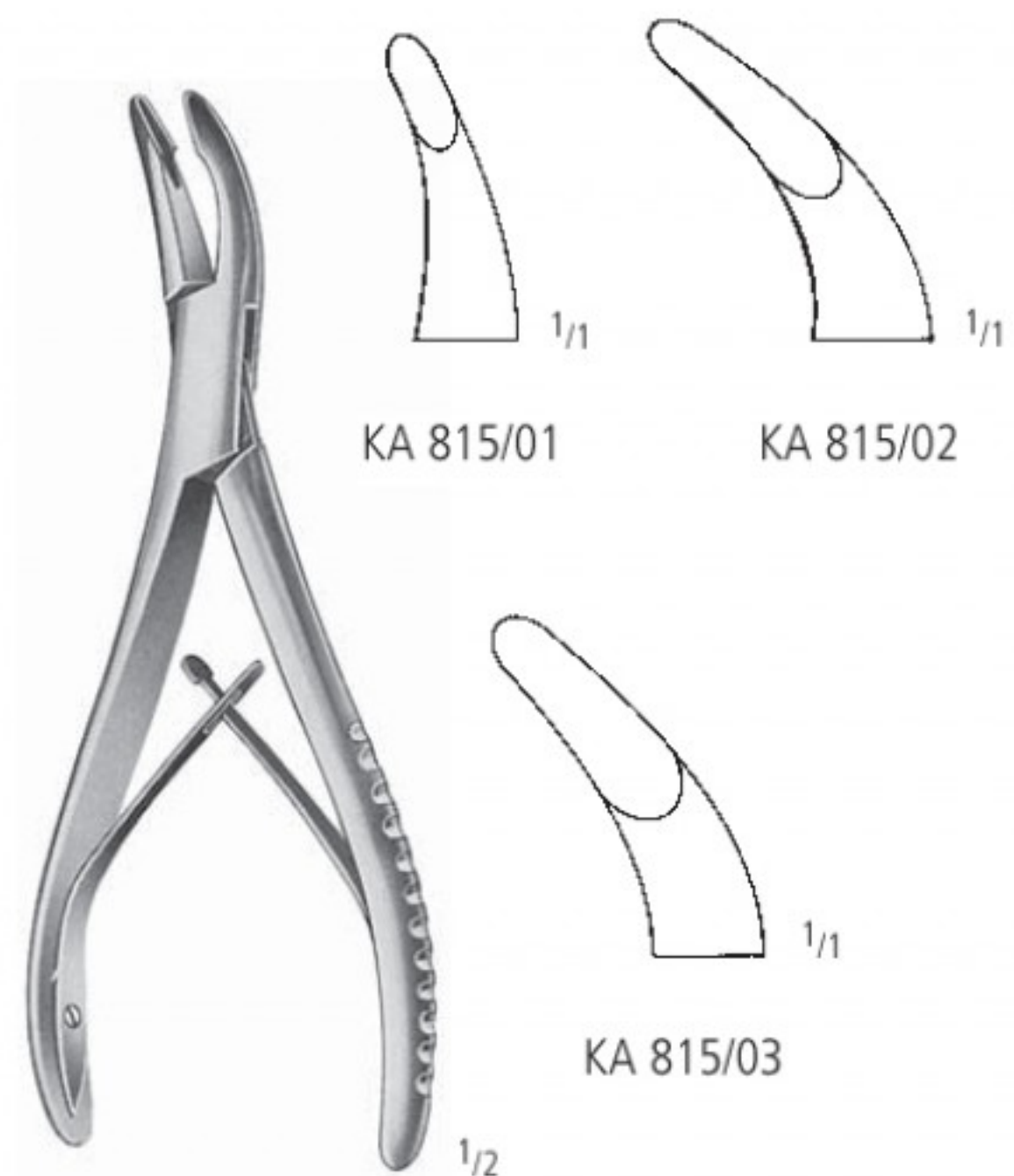

LUER
 15,0 cm/6"

Hohlmeisselzangen
 Bone Rongeurs
 Pinzas-gubias
 Pincis-gouges
 Pinze-sgorbie



LEMPERT
 KA 816/19
 19,0 cm/7 1/2"



BACON
 KA 819/20
 20,0 cm/8"



MARQUARDT
 KA 821/20
 20,0 cm/8"

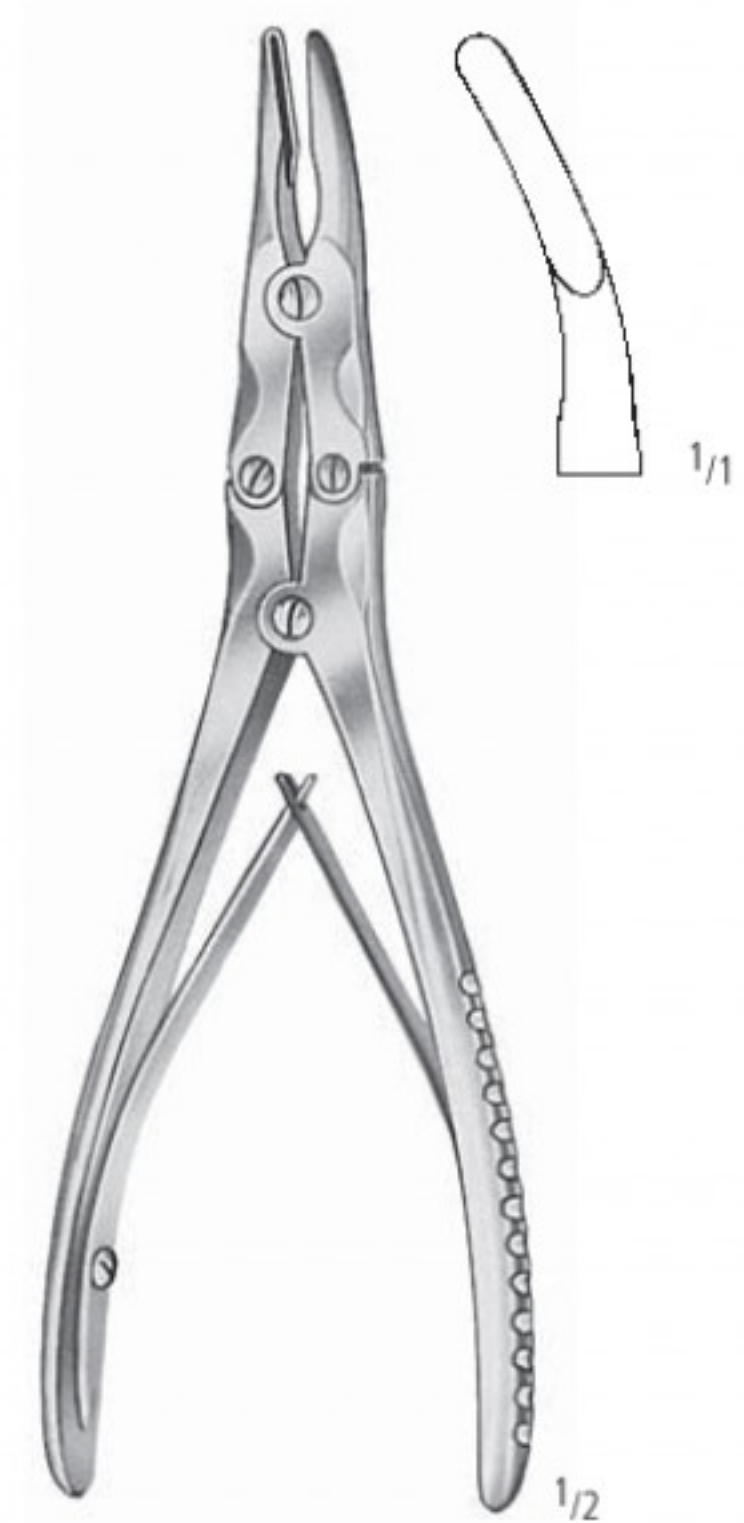

MAYFIELD
 KA 823/17
 17,0 cm/6 3/4"

Hohlmeisselzangen
 Bone Rongeurs
 Pinzas-gubias
 Pincas-gouges
 Pinze-sgorbie

AA

AB

AC

AE

AK

AO

AR

KA

KS

XR

XT

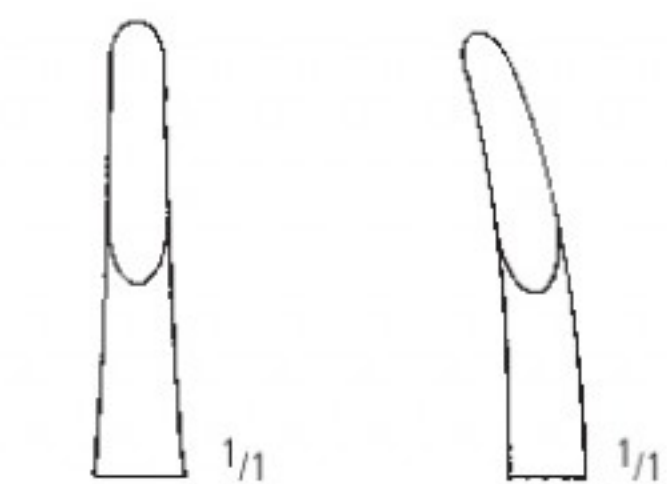

KA 825/01 KA 825/02

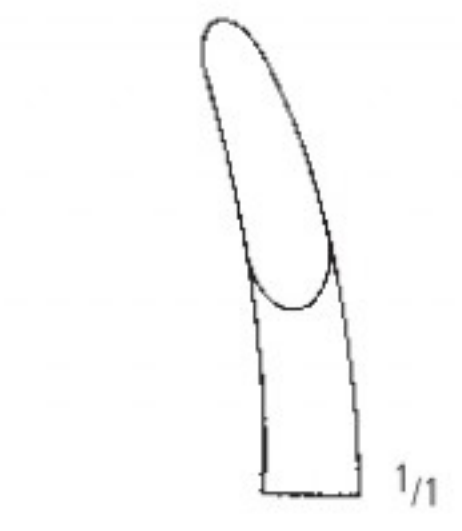

KA 825/03

BÖHLER
 15,0 cm/6"

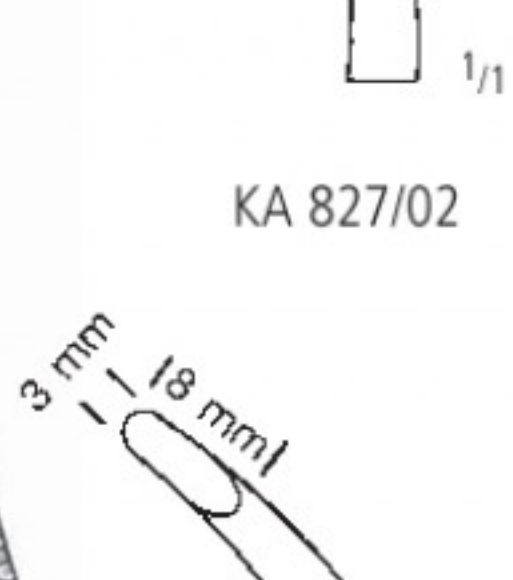
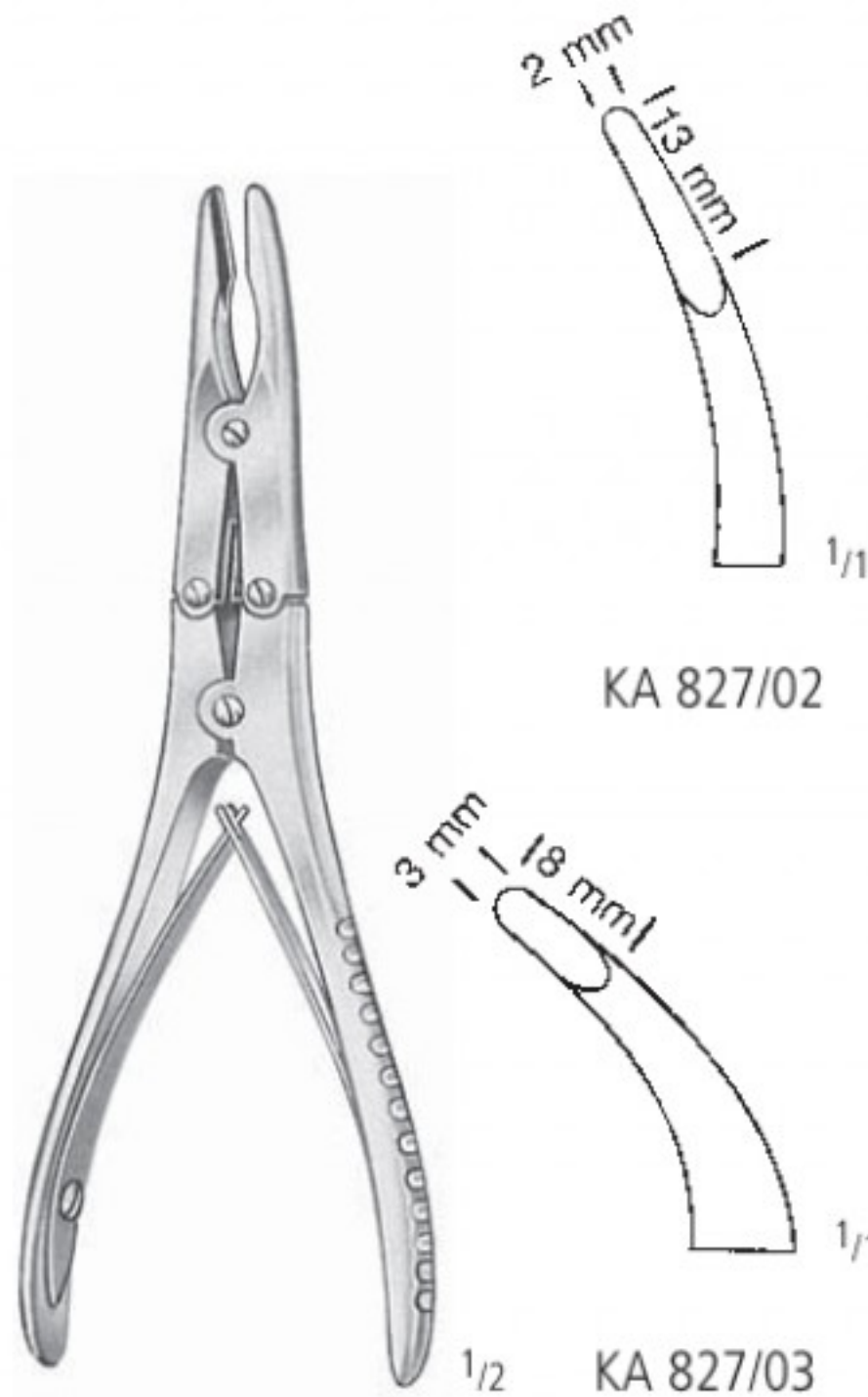

KA 827/02 KA 827/03

KLEINERT-KUTZ
 15,0 cm/6"

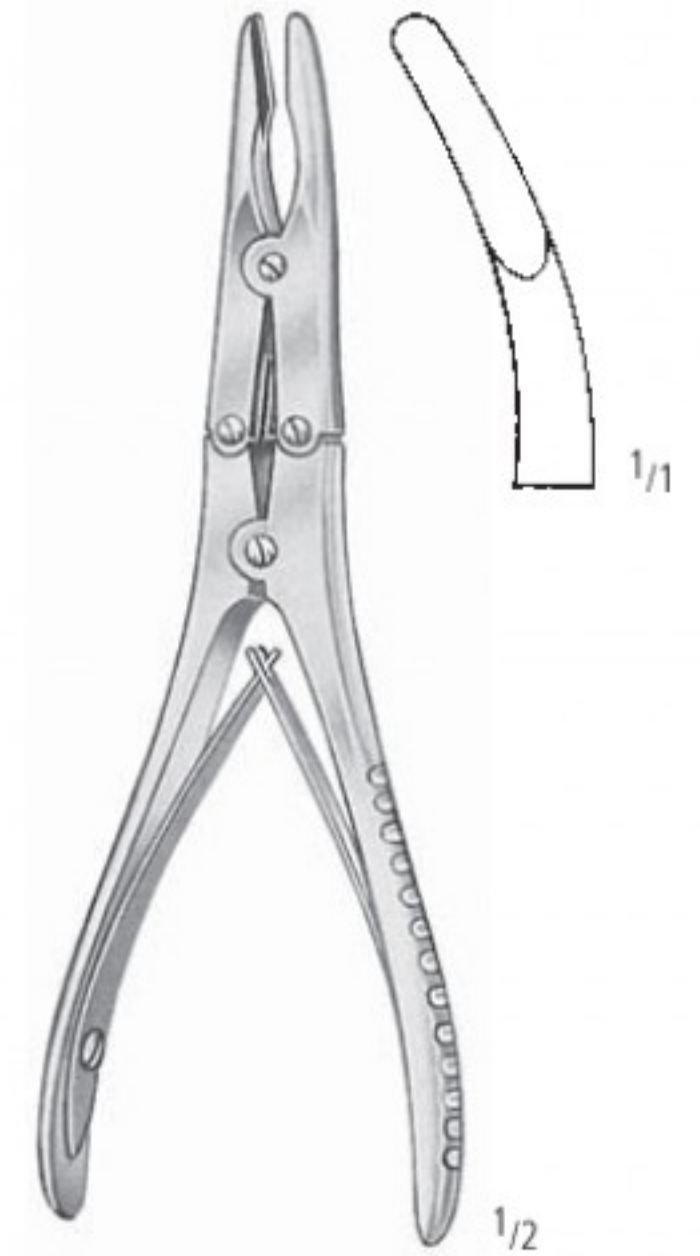

RUSKIN-MINI
 KA 829/15
 15,0 cm/6"

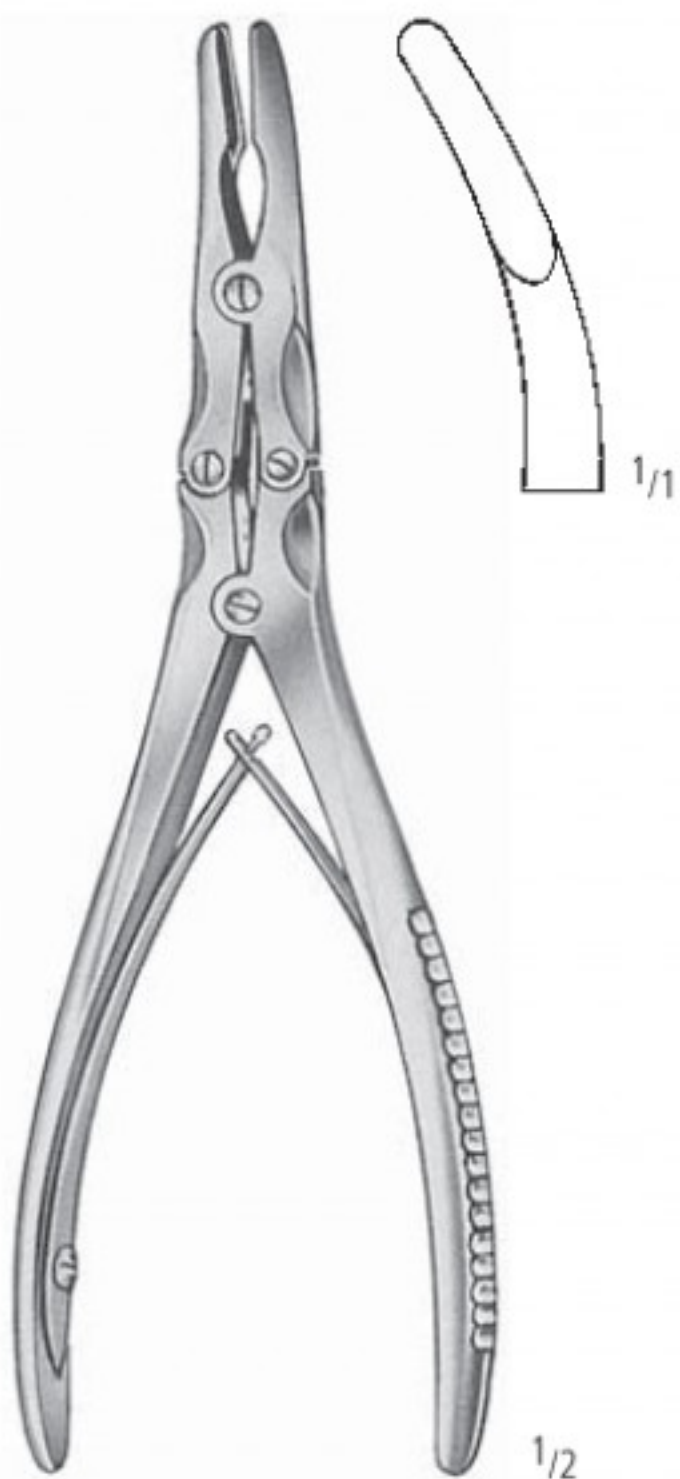

BEYER
 KA 830/18
 18,0 cm/7"



ZAUFAL-JANSEN
 KA 835/18
 18,0 cm/7"

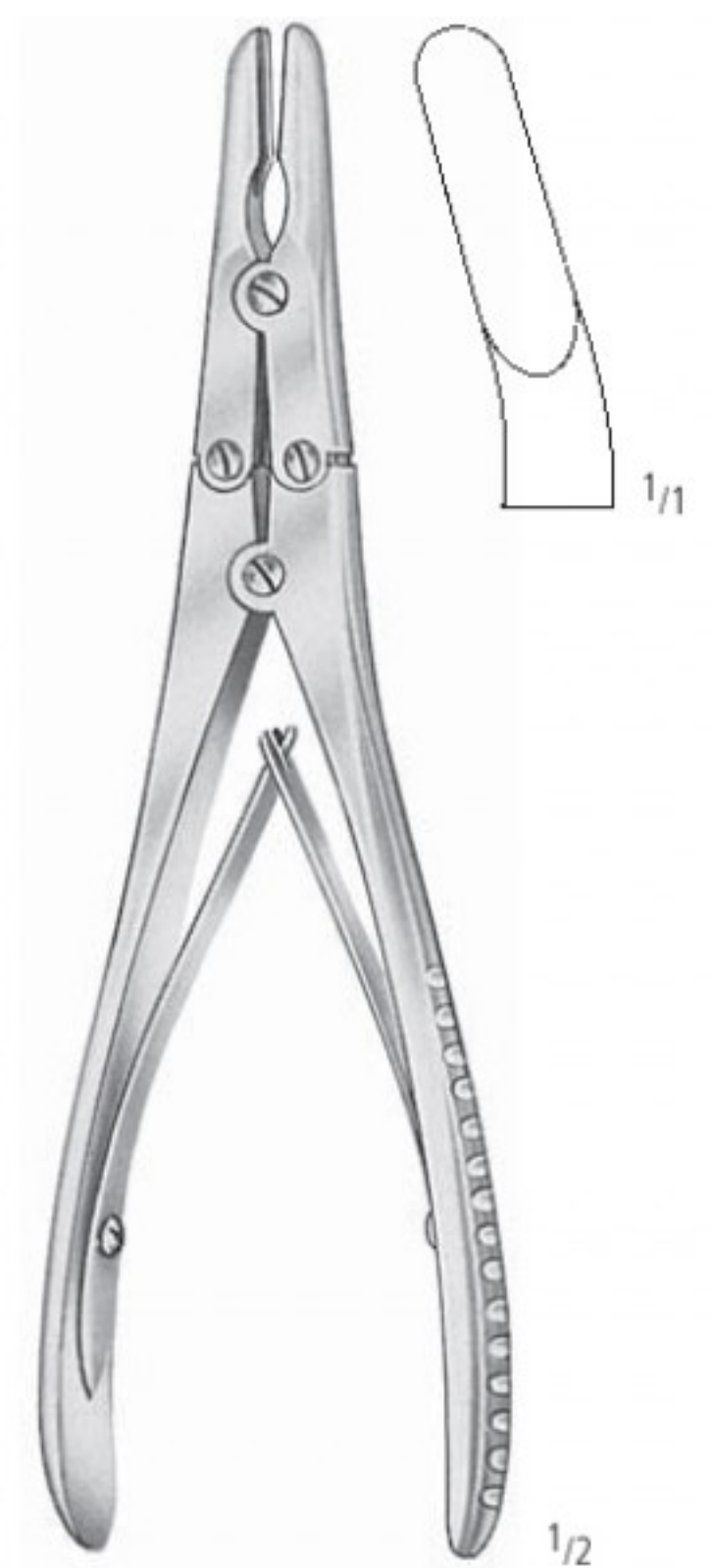

RUSKIN
 KA 836/18
 18,0 cm/7"

Hohlmeisselzangen
 Bone Rongeurs
 Pinzas-gubias
 Pincés-gouges
 Pinze-sgorbie

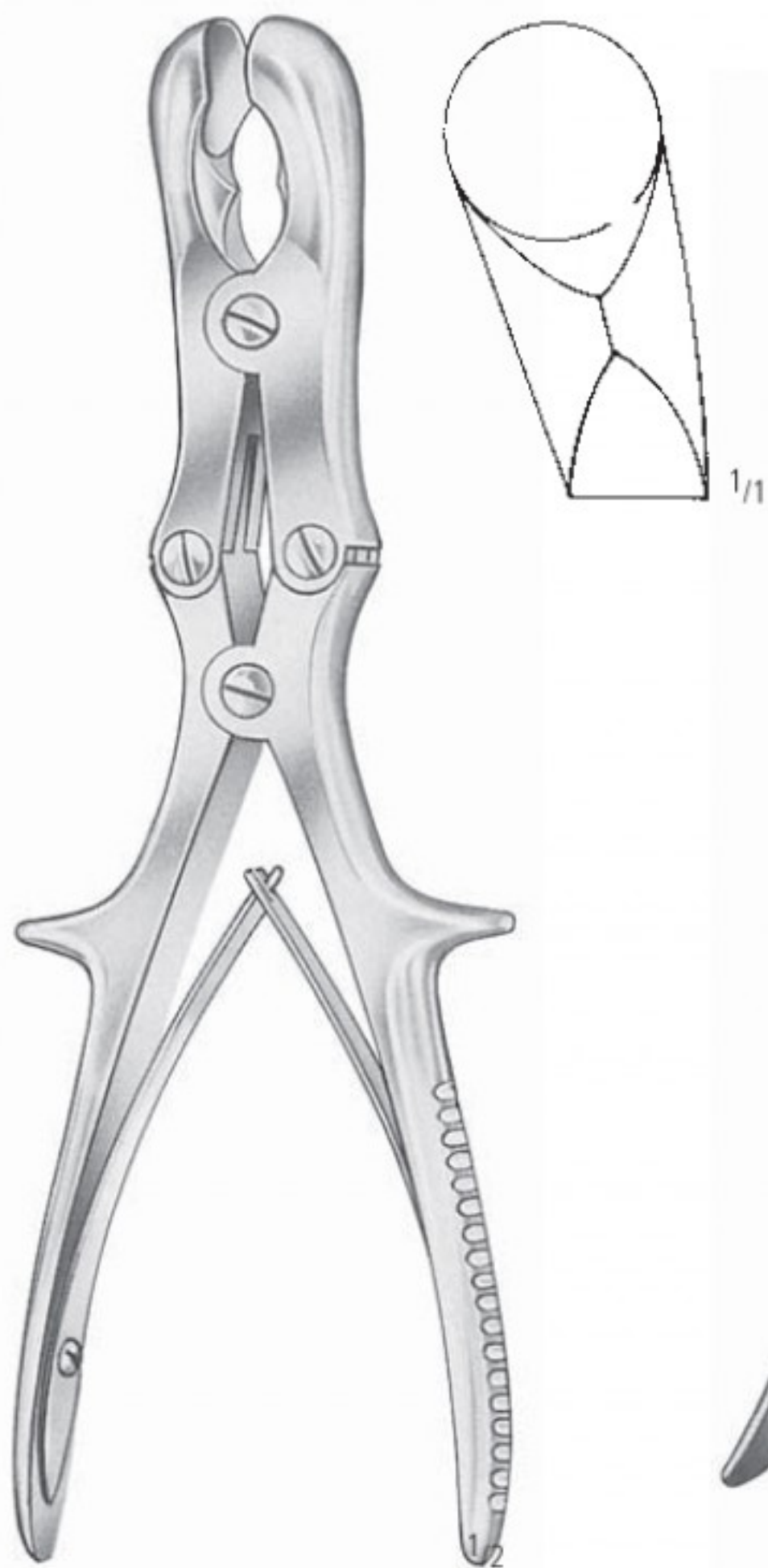

SEMB
 KA 838/22
 22,5 cm/9"

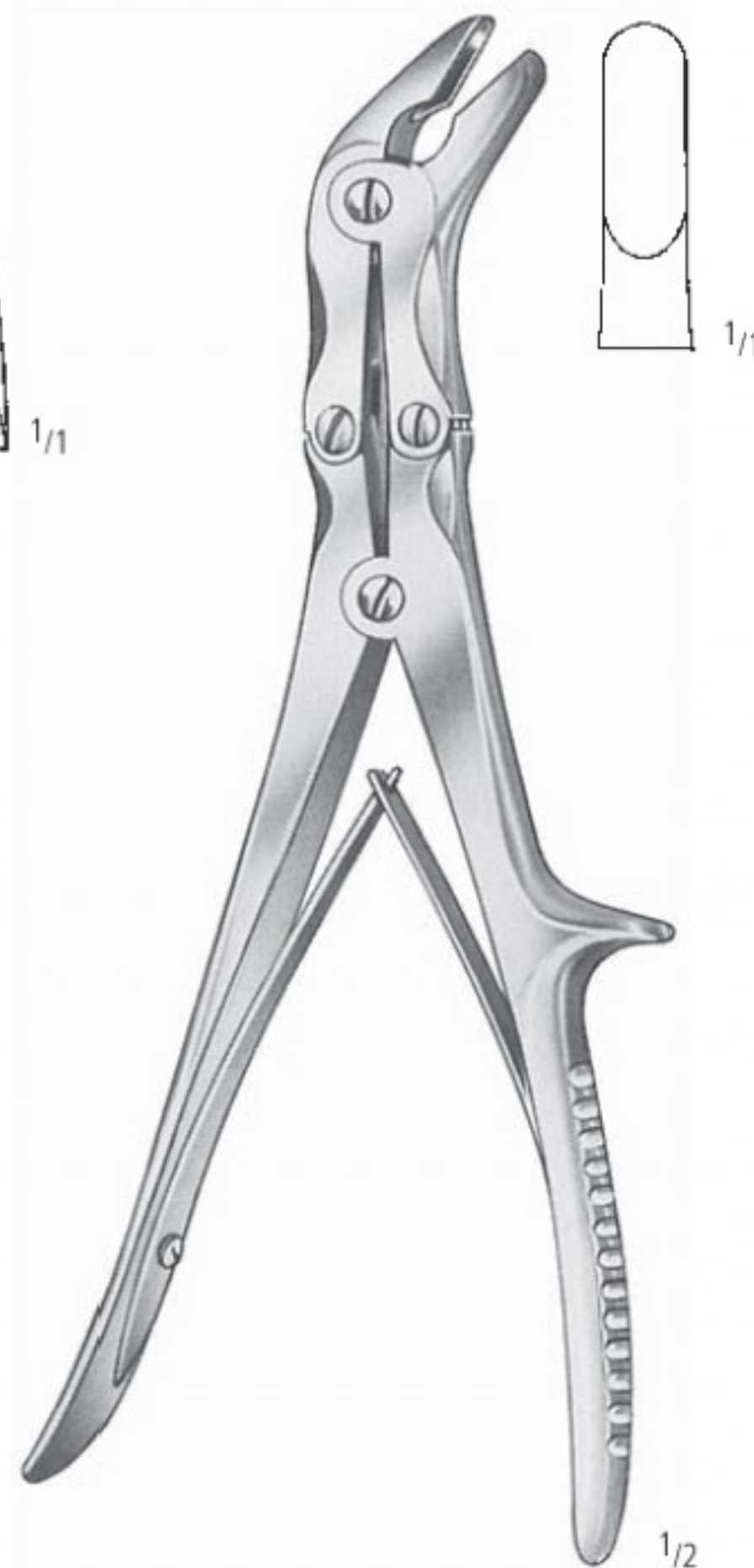

STILLE
 KA 840/23
 23,0 cm/9"



STILLE-RUSKIN
 KA 841/23
 23,0 cm/9"

Hohlmeisselzangen
 Bone Rongeurs
 Pinzas-gubias
 Pincis-gouges
 Pinze-sgorbie

AA

AB

AC

AE

AK

AO

AR

KA

KS

XR

XT

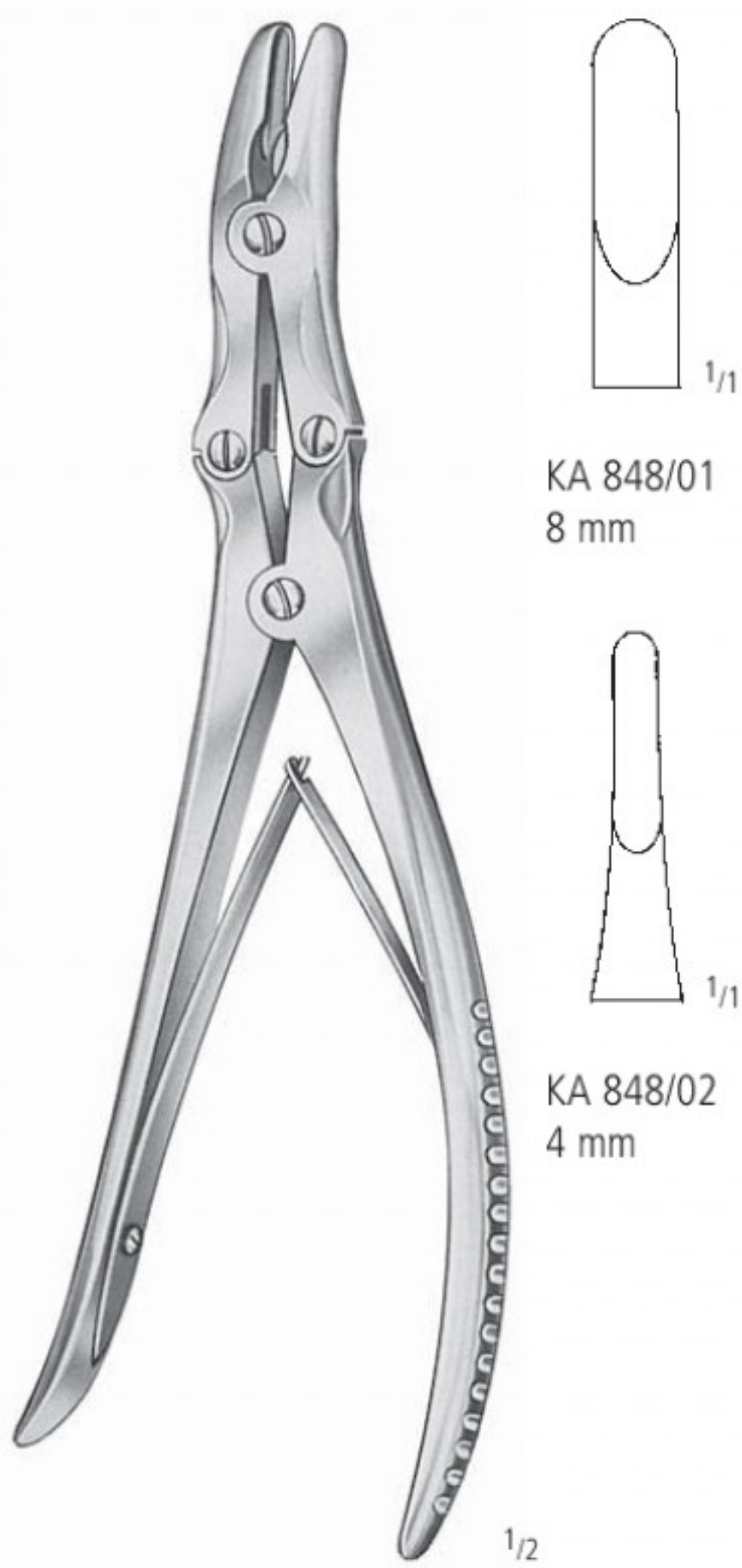

LEKSELL-STILLE
 24,0 cm/9 1/2"



FRYKHOLM
 KA 859/23
 23,0 cm/9"

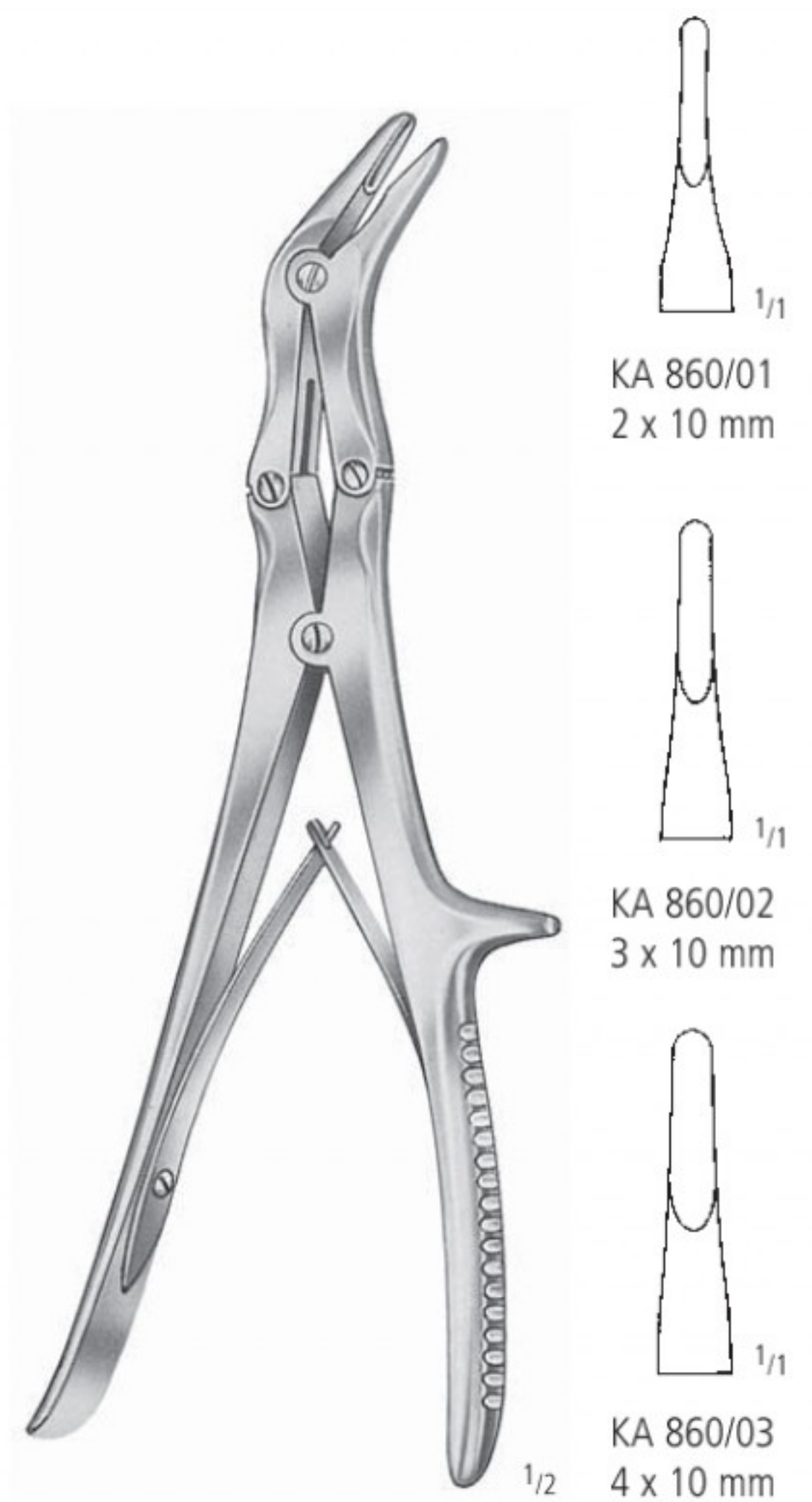

ECHLIN
 23,0 cm/9"

Hohlmeisselzangen
 Bone Rongeurs
 Pinzas-gubias
 Pincés-gouges
 Pinze-sgorbie



RUSKIN
 KA 862/23
 23,0 cm/9"



SMITH-PETERSON
 24,0 cm/9 1/2"

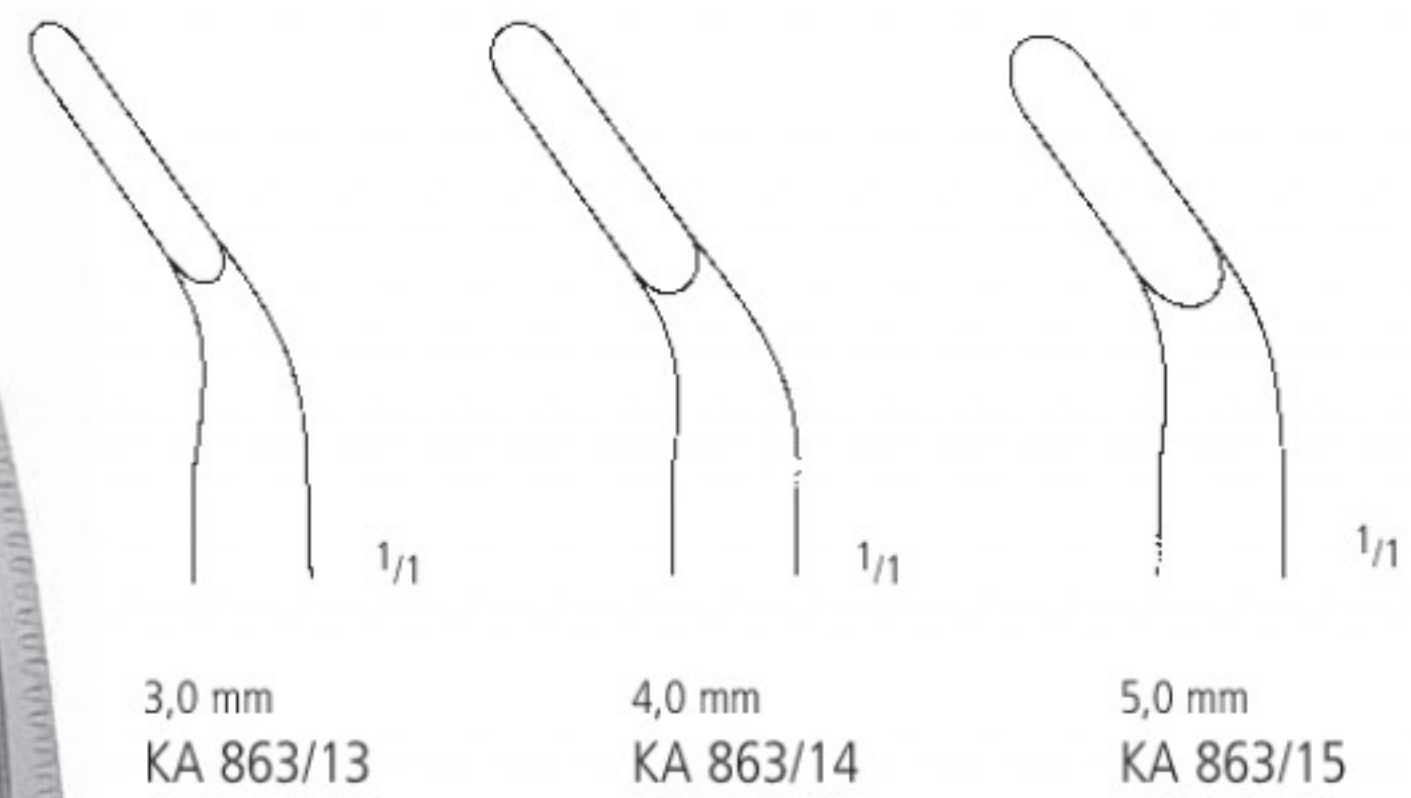
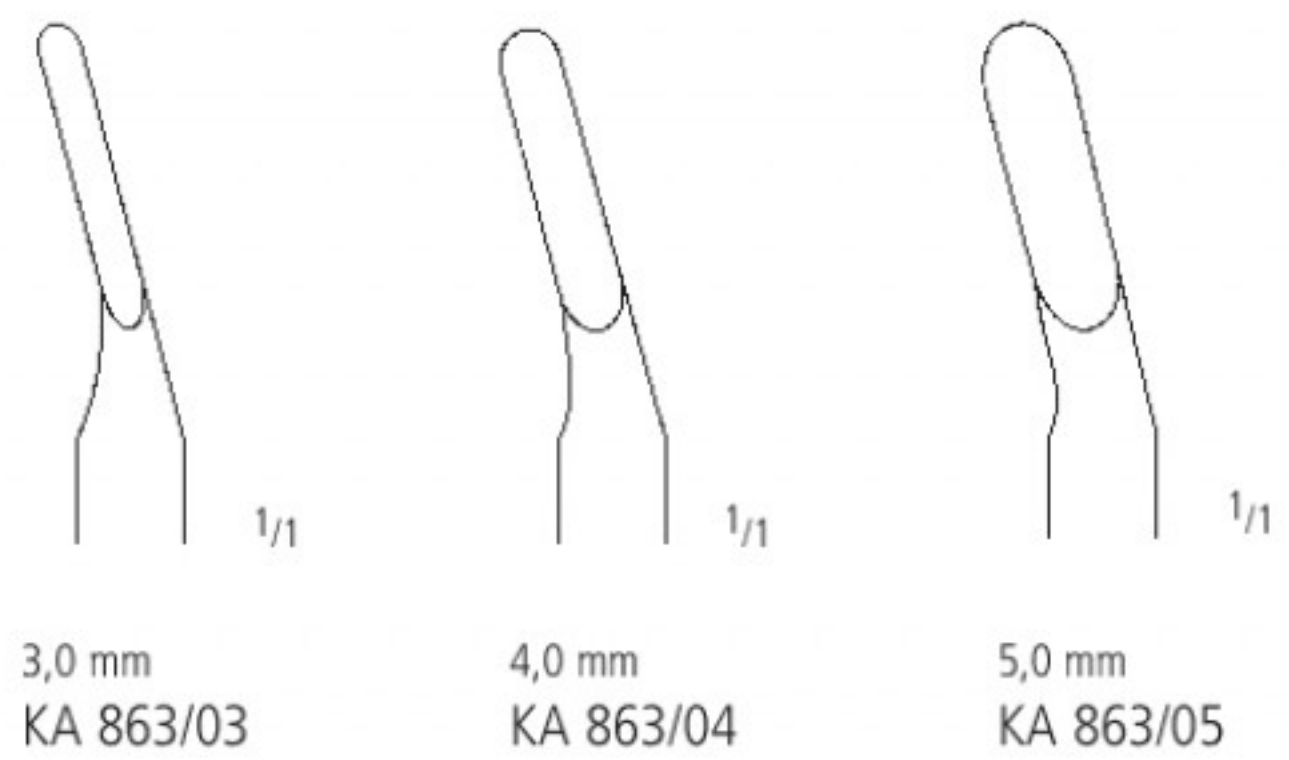

NEUROCHIRURGIE
NEUROSURGERY
NEUROCIRUGIA
NEUROCHIRURGIE
NEUROCHIRURGIA

KS

nopa[®] instruments



Feine Arterienklemmen
 Fine Artery Forceps
 Pinzas hemostáticas finas
 Pincas hémostatiques fines
 Pinze emostatiche fine

AA

AB

AC

AE

AK

AO

AR

KA

KS

XR

XT



HOEN
 KS 001/13
 13,5 cm/5¹/₄"

¹/₂



RAIMONDI
 KS 003/13
 12,5 cm/5"

¹/₂

Präparierklemmen
 Dissecting Forceps
 Pinzas para preparaciones
 Pincers à dissection
 Pinze per preparazione



KS 011/01
 19,5 cm/8"



KS 011/02
 19,5 cm/8"

Mikro-Instrumente
 Micro Instruments
 Instrumentos para microcirugía
 Instruments pour la chirurgie micro
 Strumenti per la chirurgia micro

AA

AB

AC

AE

AK

AO

AR

KA

KS

XR

XT



18,5 cm/7¹/₄"

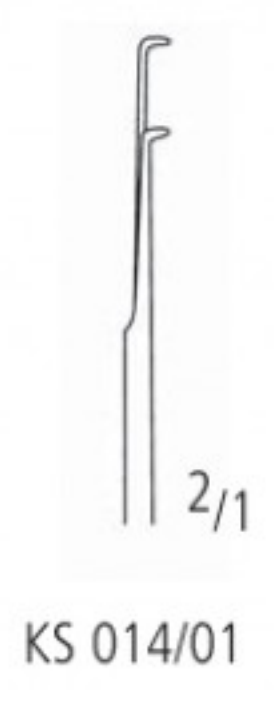

KS 014/01

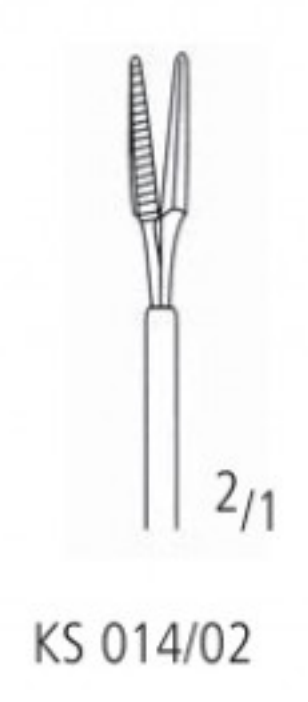

KS 014/02

Mikro-Pinzetten
 Micro Forceps
 Micro-Pinzas
 Micro-Pinces
 Micro-Pinze

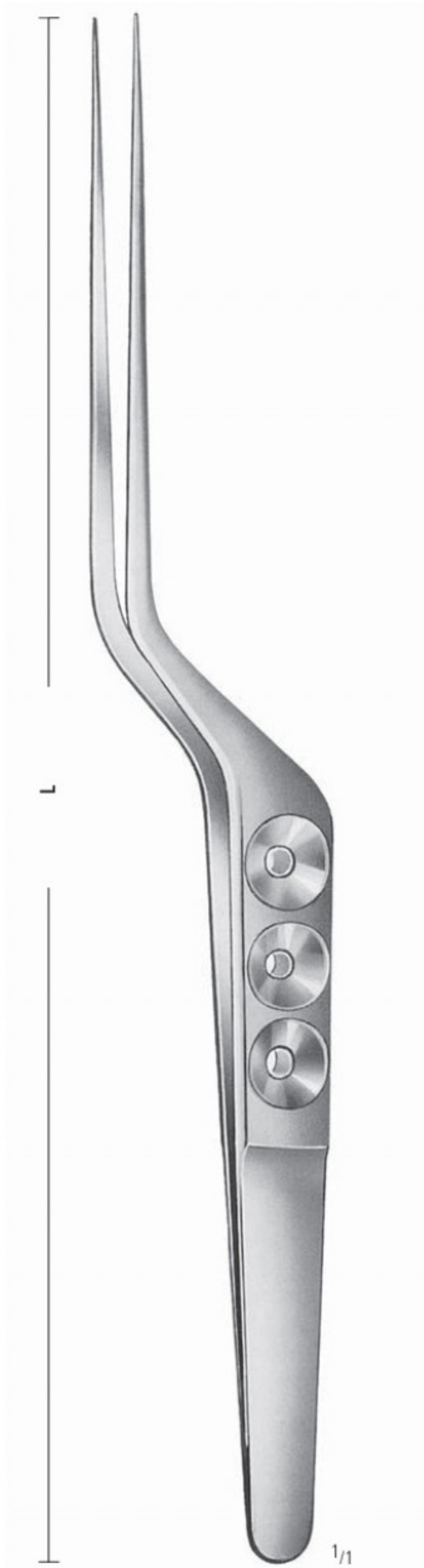

L	TIP	
18,0 cm/7"	0,6 mm	KS 020/06
18,0 cm/7"	0,9 mm	KS 020/09
18,0 cm/7"	1 : 2	KS 020/20
20,0 cm/8"	0,6 mm	KS 022/06
20,0 cm/8"	0,9 mm	KS 022/09
22,0 cm/8 ³ / ₄ "	0,6 mm	KS 024/06
22,0 cm/8 ³ / ₄ "	0,9 mm	KS 024/09
24,0 cm/9 ¹ / ₂ "	0,6 mm	KS 026/06
24,0 cm/9 ¹ / ₂ "	0,9 mm	KS 026/09

Mikro-Pinzetten, Nahtpinzetten
 Micro Forceps, Suture Forceps
 Micro-Pinzas, Pinzas para sutura
 Micro-Pinces, Pinces pour sutures
 Micro-Pinze, Pinze per sutura

AA

AB

AC

AE

AK

AO

AR

KA

KS

XR

XT

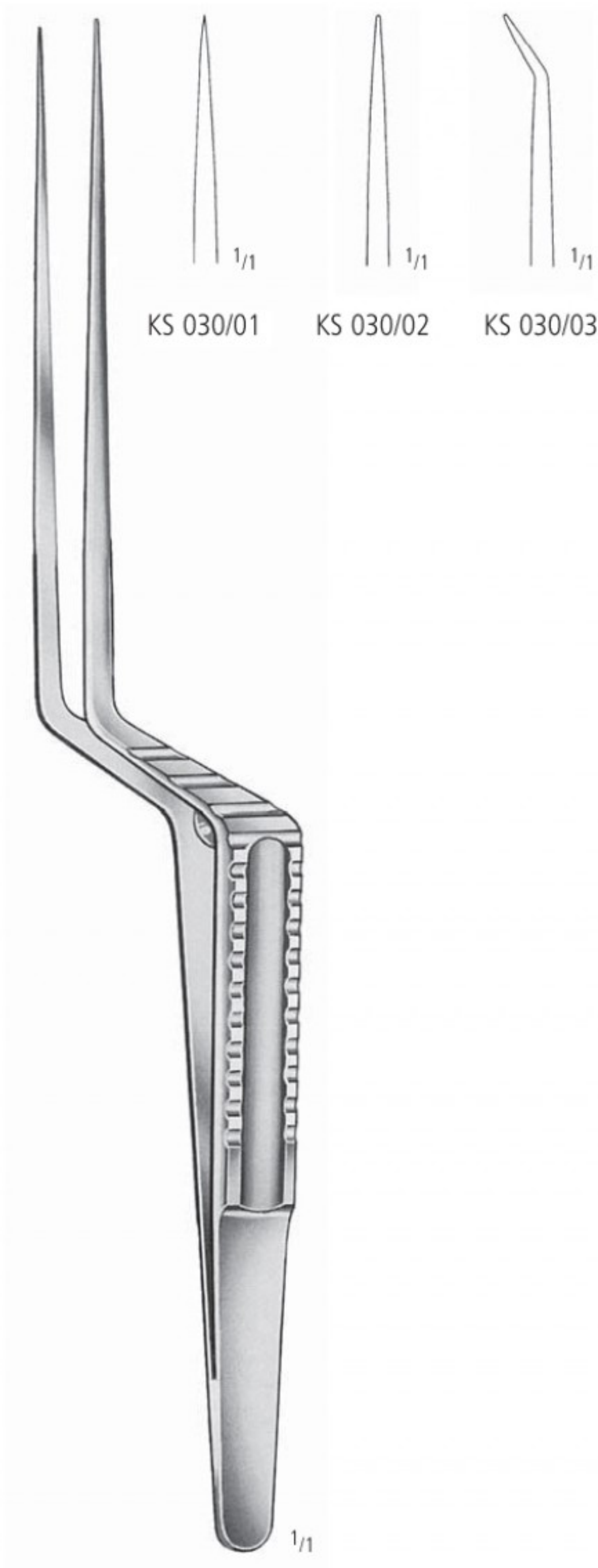

KS 030/01 KS 030/02 KS 030/03

18,5 cm/7¹/₄"



KS 032/22
 22,0 cm/8³/₄"



KS 036/18
 18,5 cm/7¹/₄"

Mikro-Pinzetten
 Micro Forceps
 Micro-Pinzas
 Micro-Pinces
 Micro-Pinze

TITANIUM

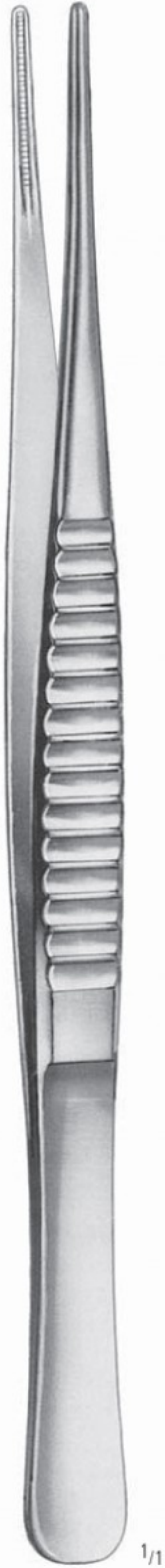

DIETHRICH

1,5 mm

2,0 mm

2,8 mm



15,0 cm/6"

KS 040/15

KS 040/20

KS 040/28

20,0 cm/8"

KS 041/15

KS 041/20

KS 041/28

24,0 cm/9³/₄"

KS 042/15

KS 042/20

KS 042/28

Mikroscheren
 Micro Scissors
 Micro Tijeras
 Micro Ciseaux
 Micro Forbici



20,0 cm/8"

45°

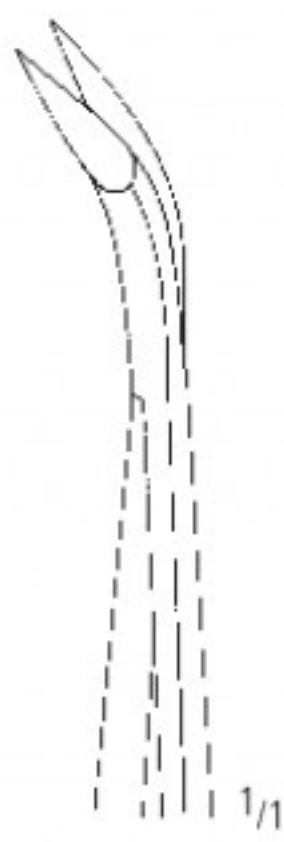

NAGEL
 KS 050/20

45°

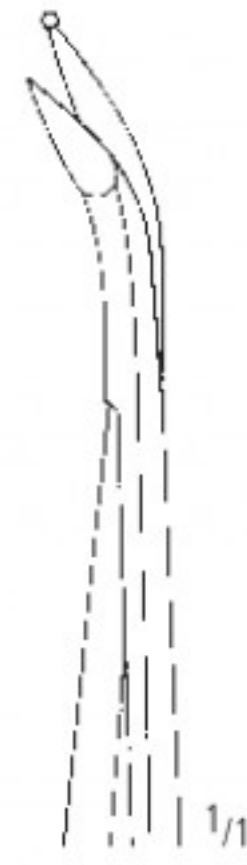

KS 051/20

125°

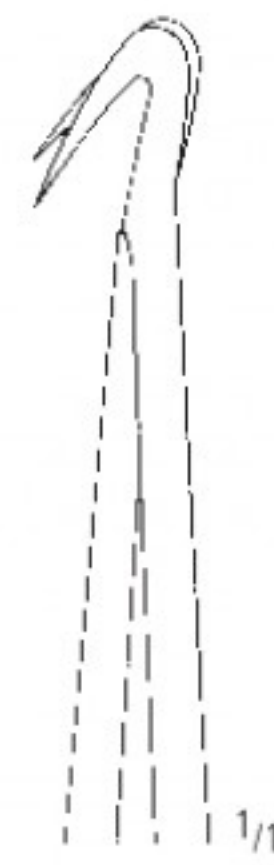

KS 052/20

AA

AB

AC

AE

AK

AO

AR

KA

KS

XR

XT

Mikroscheren
Micro Scissors
Micro Tijeras
Micro Ciseaux
Micro Forbici

gezahnt
saw edge
dentadas
dentelés
dentata



VANNAS

16,0 cm/6¹/₄"

KS 060/16

gerade
straight
rectas
droits
retta

KS 061/16

gebogen
curved
curvas
courbes
curva

KS 062/16

gerade
straight
rectas
droits
retta

KS 063/16

gebogen
curved
curvas
courbes
curva

MILLES

16,0 cm/6¹/₄"

KS 064/16

gerade
straight
rectas
droits
retta

KS 065/16

gebogen
curved
curvas
courbes
curva

Mikroscheren
 Micro Scissors
 Micro Tijeras
 Micro Ciseaux
 Micro Forbici

AA

AB

AC

AE

AK

AO

AR

KA

KS

XR

XT

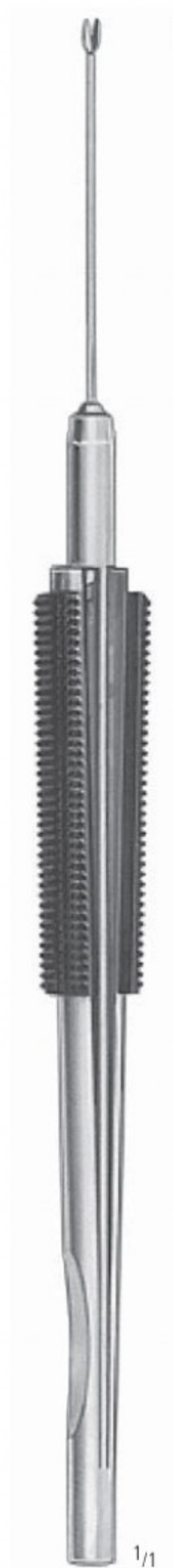

1/1

1/1

KS 068/00
 18,5 cm/7¹/₄"



1/1

1/1

KS 069/19
 19,0 cm/7¹/₂"

Mikro-Nadelhalter mit Rundgriff
 Micro-Needle Holders with pen-type handle
 Micro-porta-agujas con mango redondo
 Micro-porte-aiguilles à manches rondes
 Micro-portaghi con manici rotondi

 1/1	Tip 0,3 mm 14,0 cm/5 1/2" 18,0 cm/7"	 Tip 0,3 mm KS 070/14 KS 070/18	 Tip 0,3 mm KS 071/14 KS 071/18	 1/1	Tip 0,3 mm 14,0 cm/5 1/2" 18,0 cm/7"	 Tip 0,3 mm KS 074/14 KS 074/18	 Tip 0,3 mm KS 075/14 KS 075/18
		Tip 0,8 mm 14,0 cm/5 1/2" 18,0 cm/7"	Tip 0,8 mm KS 072/14 KS 072/18			Tip 0,8 mm KS 073/14 KS 073/18	Tip 0,8 mm 14,0 cm/5 1/2" 18,0 cm/7"
	BARRAQUER		BARRAQUER				

Nadelhalter
Needle Holders
Porta-agujas
Porte-aiguilles
Portaghi

nopa[®] DIAMOND



14,0 cm/5 1/2" KS 080/14

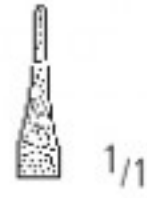

18,0 cm/7" KS 080/18
23,0 cm/9" KS 080/23

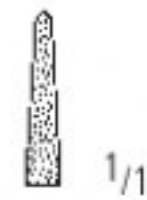

14,0 cm/5 1/2" KS 081/14

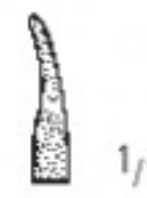

18,0 cm/7" KS 081/18
23,0 cm/9" KS 081/23

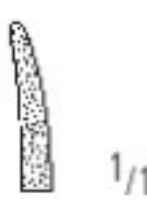

AA
AB
AC
AE
AK
AO
AR
KA
KS
XR
XT

KS

Nadelhalter
Needle Holders
Porta-agujas
Porte-aiguilles
Portaghi

nopa[®] DIAMOND



21,0 cm/8¹/₄"

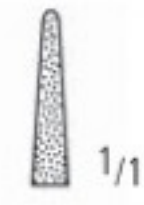

KS 082/21

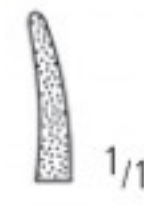

KS 083/21

Nadelhalter
Needle Holders
Porta-agujas
Porte-aiguilles
Portaghi

AA

AB

AC

AE

AK

AO

AR

KA

KS

XR

XT

nopa[®] DIAMOND



15,0 cm/6"
18,0 cm/7"
23,0 cm/9"

KS 084/15
KS 084/18
KS 084/23

Instrumente zur Schädelöffnung
 Instruments for Cranial Opening
 Instrumentos para abertura craneana
 Instruments pour l'ouverture du crâne
 Strumenti per l'apertura del cranio

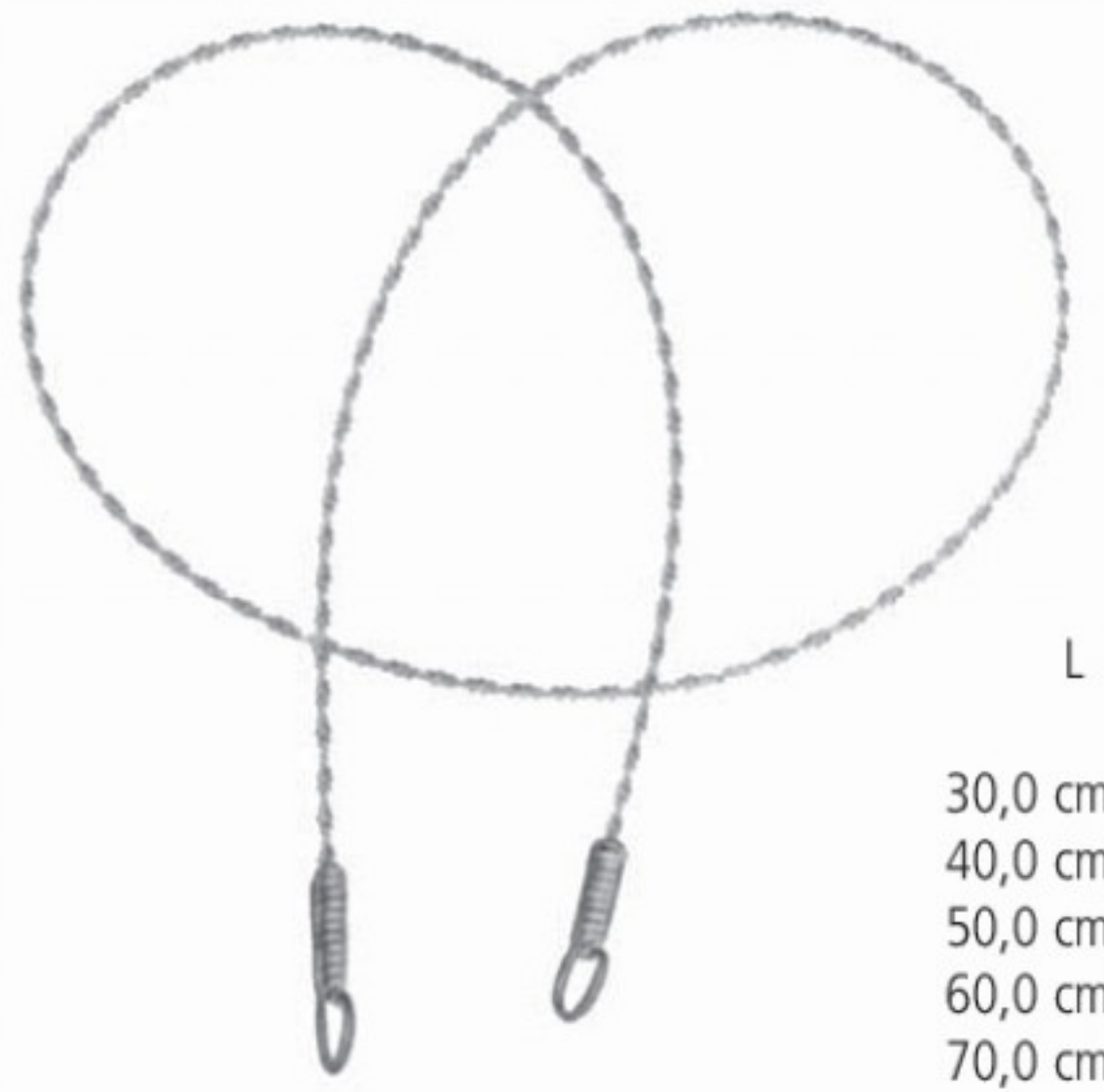

L	2x	3x
30,0 cm/12"	KS 102/30	KS 103/30
40,0 cm/16"	KS 102/40	KS 103/40
50,0 cm/20"	KS 102/50	KS 103/50
60,0 cm/24"	KS 102/60	KS 103/60
70,0 cm/28"	KS 102/70	KS 103/70

OLIVECRONA-GIGLI



KS 120/00
 Paar / pair / pareja / paire / paio

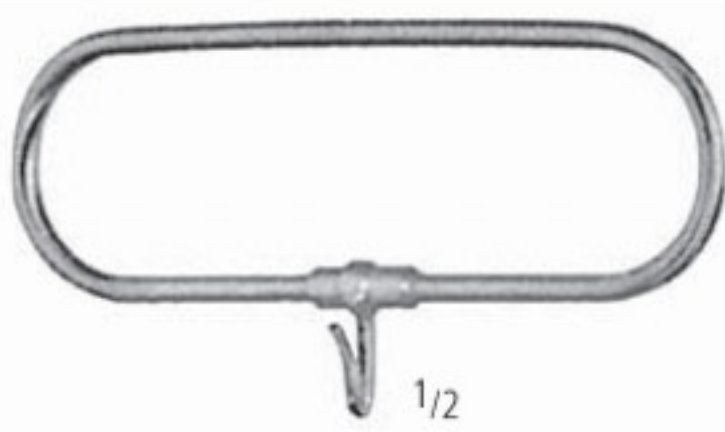

KS 122/00
 Paar / pair / pareja / paire / paio



MARTEL
 KS 130/33
 33,0 cm/13"

Instrumente zur Schädelöffnung
 Instruments for Cranial Opening
 Instrumentos para abertura craneana
 Instruments pour l'ouverture du crâne
 Strumenti per l'apertura del cranio

AA

AB

AC

AE

AK

AO

AR

KA

KS

XR

XT



DE VILBISS
 KS 160/21
 21,0 cm/8¹/₄"



DAHLGREEN
 KS 162/20
 20,0 cm/8"

Schädelhalter
 Cervical Traction Tongs
 Pinzas de tracción craneal
 Pinces de traction crânienne
 Pinze per trazione craniale



CRUTCHFIELD
 KS 200/01



CRUTCHFIELD
 KS 200/02



KS 201/04
 Ø 3,5 mm



KS 201/05
 Ø 5,0 mm



KS 210/00



KS 210/01

Ersatzdorn
 Spare Pin
 Punta de repuesto
 Pointe de rechange
 Punta da scorta

Hirnretraktor
Brain Retractor
Separadores cerebrales
Ecarteurs cérébrales
Divaricatori cerebrali

AA

AB

AC

AE

AK

AO

AR

KA

KS

XR

XT

LEYLA

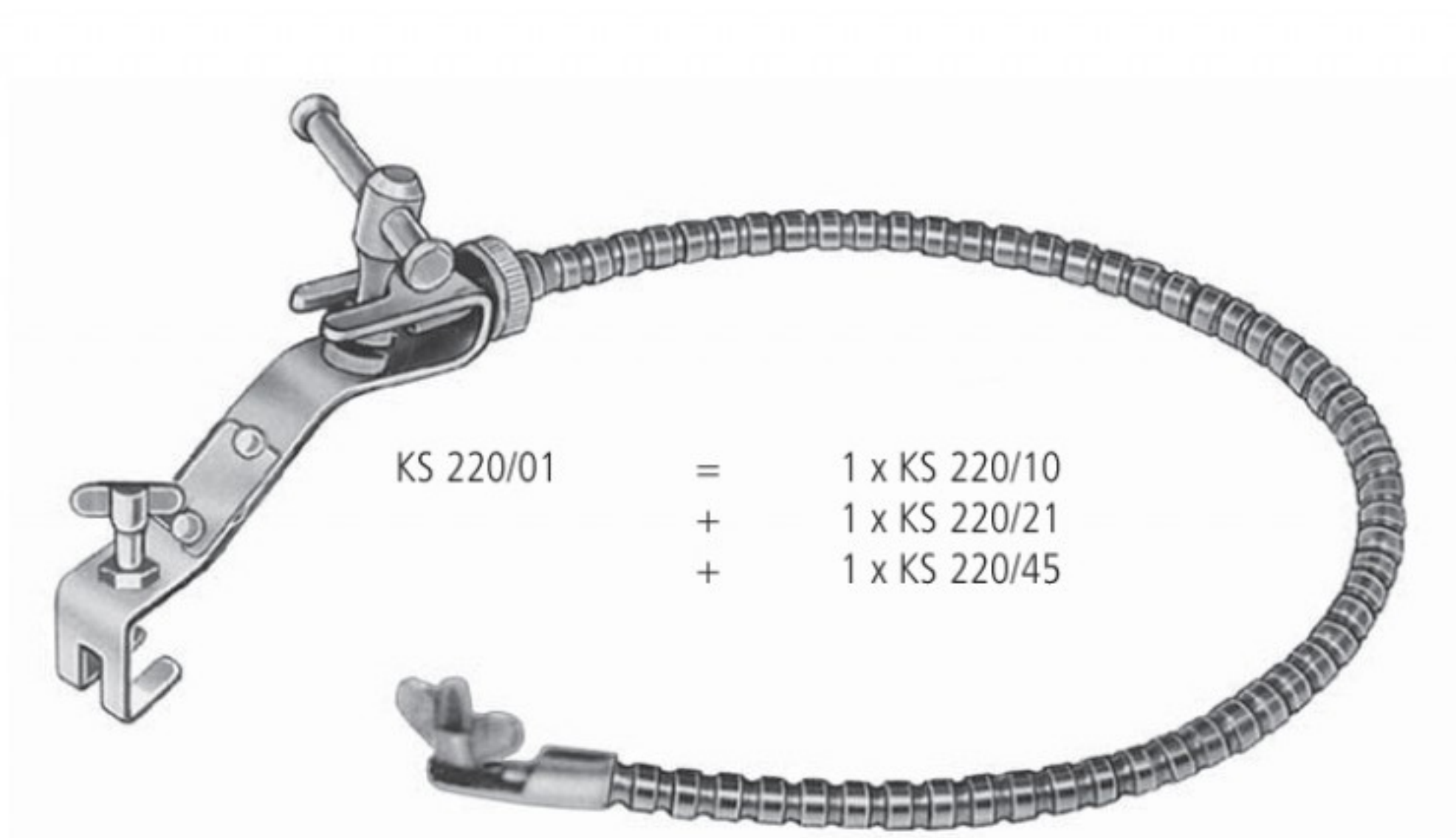

KS 220/01 = 1 x KS 220/10
+ 1 x KS 220/21
+ 1 x KS 220/45

LEYLA - 1
KS 220/01

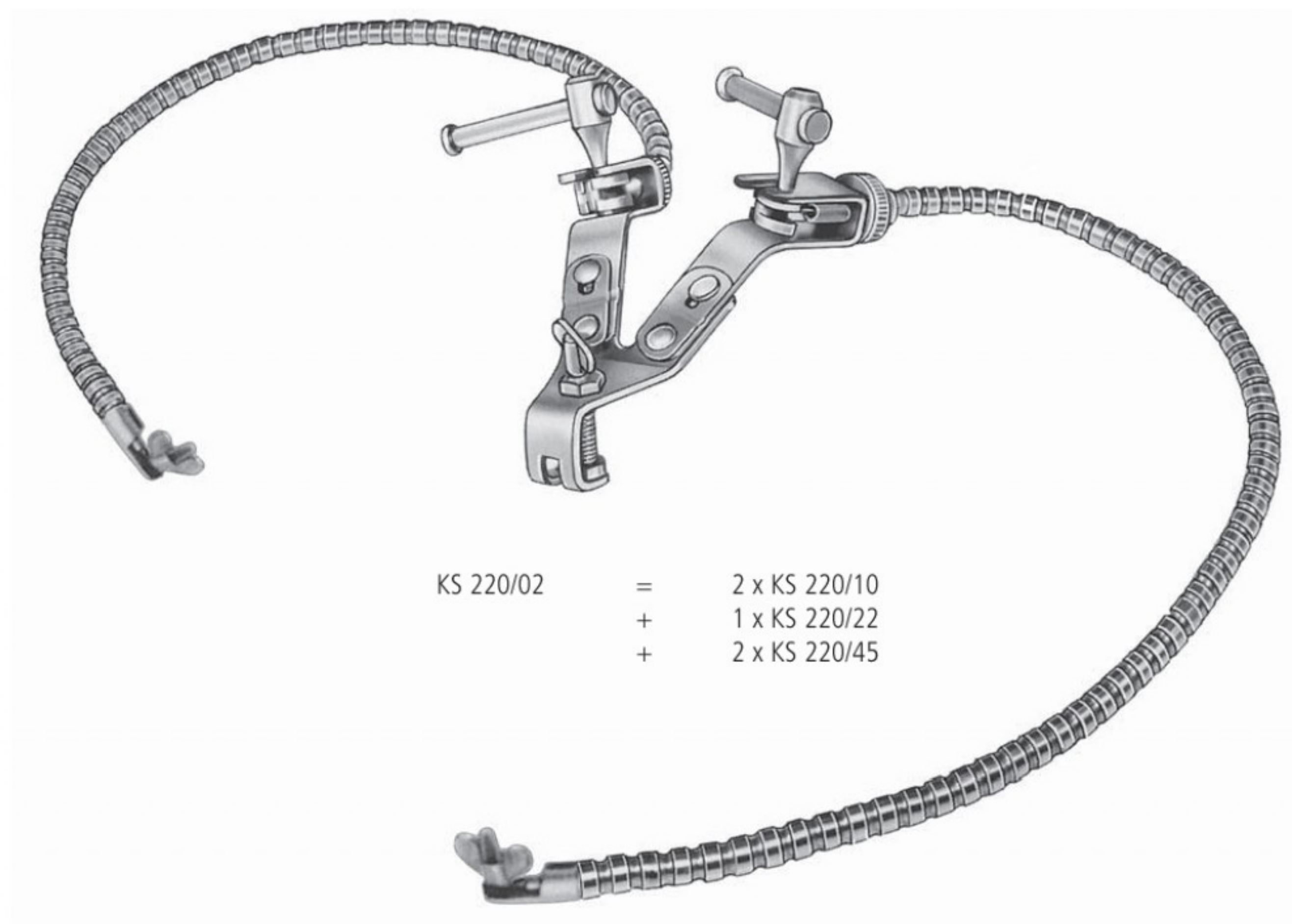

KS 220/02 = 2 x KS 220/10
+ 1 x KS 220/22
+ 2 x KS 220/45

LEYLA - 2
KS 220/02

Hirnretraktor
Brain Retractor
Separadores cerebrales
Ecarteurs cérébrales
Divaricatori cerebrali

LEYLA



KS 220/10

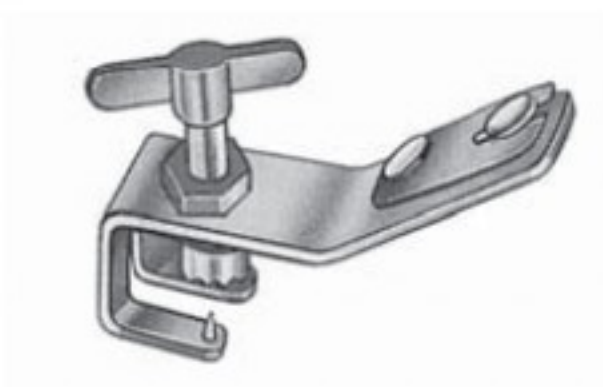

KS 220/21



KS 220/22

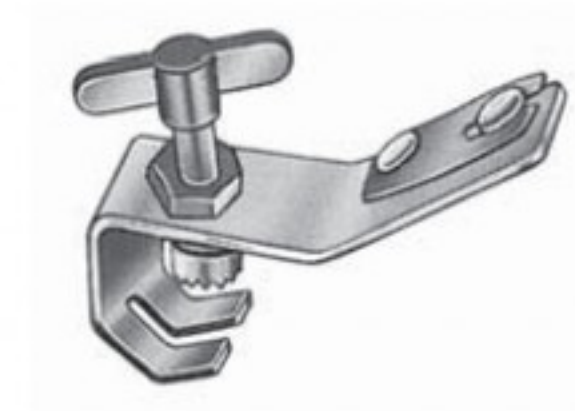

KS 220/30



KS 220/40



KS 220/45

Hirnretraktor
Brain Retractor
Separadores cerebrales
Ecarteurs cérébrales
Divaricatori cerebrali

LEYLA

Satz
Set
KS 222/00 = 1 x KS 222/10
+ 1 x KS 222/20
+ 1 x KS 222/25

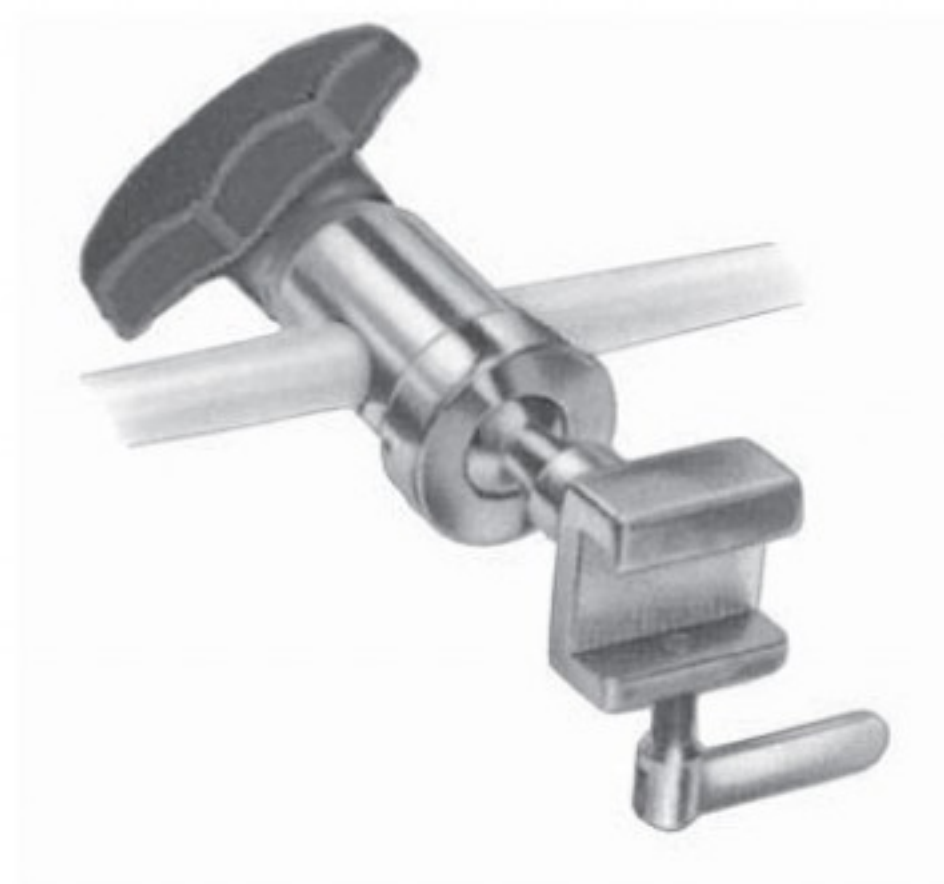

9 x 32 mm KS 222/09
10 x 25 mm KS 222/10



KS 222/20



KS 222/25



KS 222/40

AA

AB

AC

AE

AK

AO

AR

KA

KS

XR

XT

Hirnspatel
Brain Spatulas
Espátulas cerebrales
Spatules cérébrales
Spatoli cerebrali



biegsam
malleable
maleables
malléables
malleabile

8 mm	KS 230/08
11 mm	KS 230/11
14 mm	KS 230/14
17 mm	KS 230/17
20 mm	KS 230/20

HEIFETZ
20,0 cm/8"

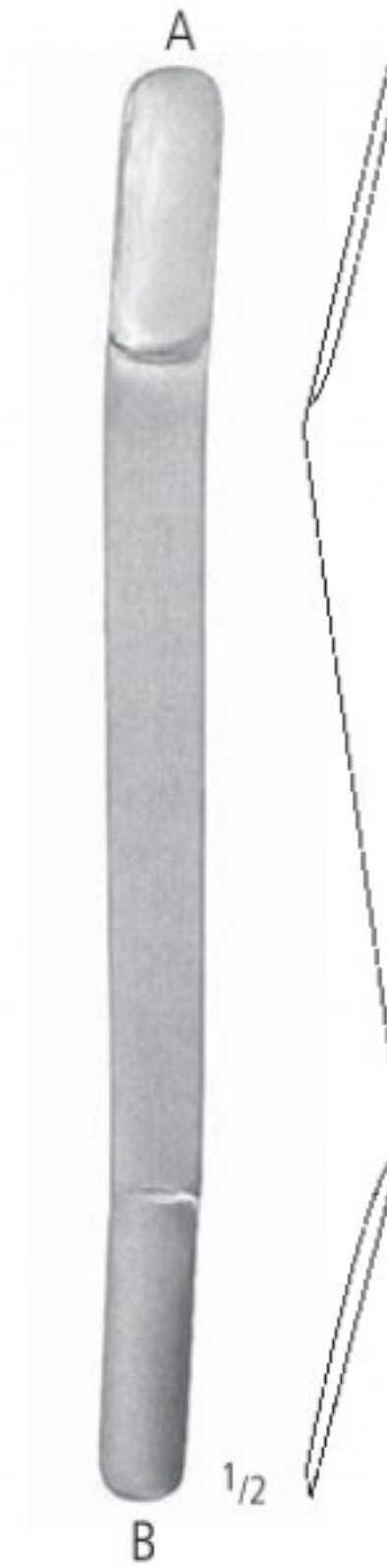
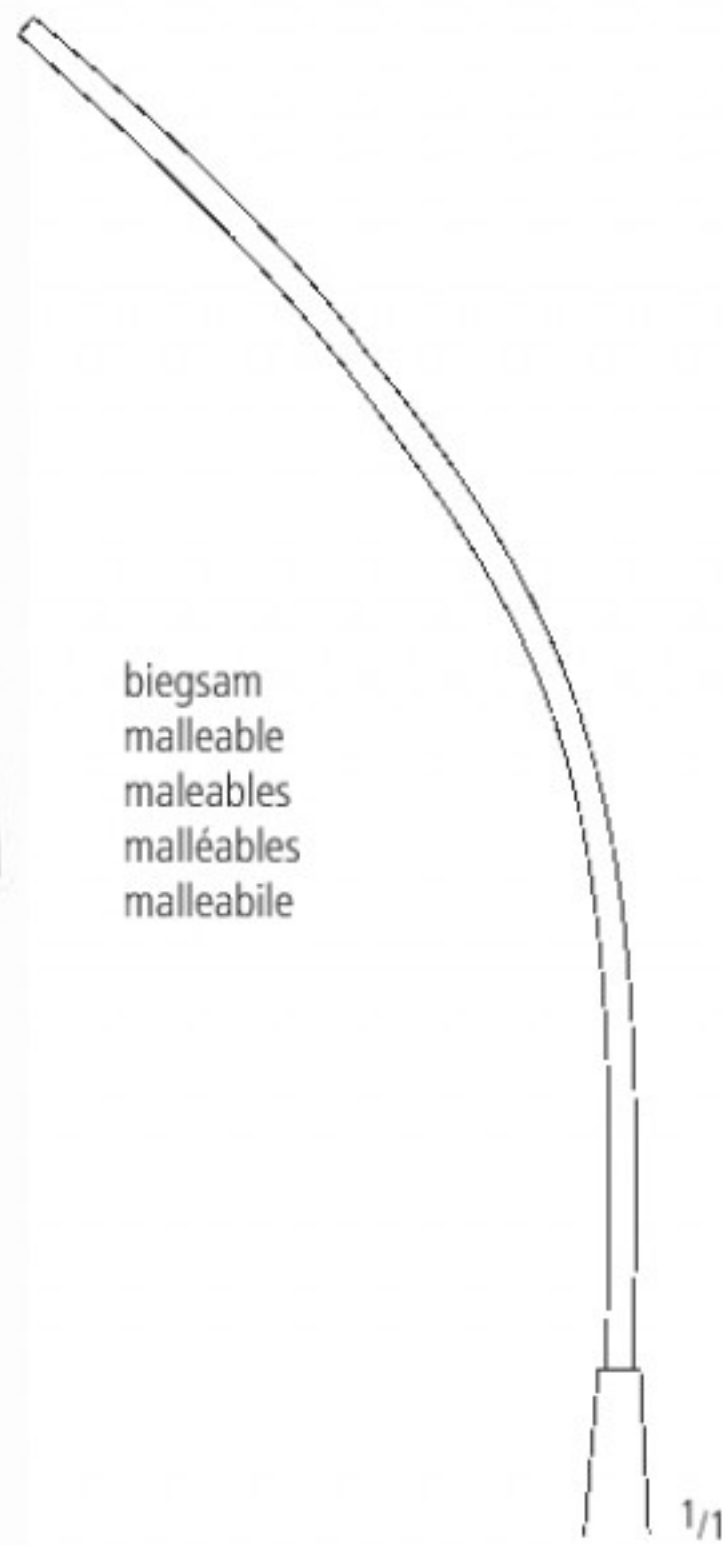

konkav
concave
cóncavas
concaves
concave

konvex
convex
convexas
convexes
convesse

	A mm	B mm	
KS 232/01	7	9	KS 233/01
KS 232/02	11	13	KS 233/02
KS 232/03	15	18	KS 233/03
KS 232/04	18	22	KS 233/04

OLIVECRONA
18,0 cm/7"



biegsam
malleable
maleables
malléables
malleabile

A mm	B mm	
7	9	KS 236/01
11	13	KS 236/02
15	18	KS 236/03
18	22	KS 236/04

B
18,0 cm/7"





biegsam
malleable
maleables
malléables
malleabile

12 mm	KS 237/12
17 mm	KS 237/17

20,0 cm/8"

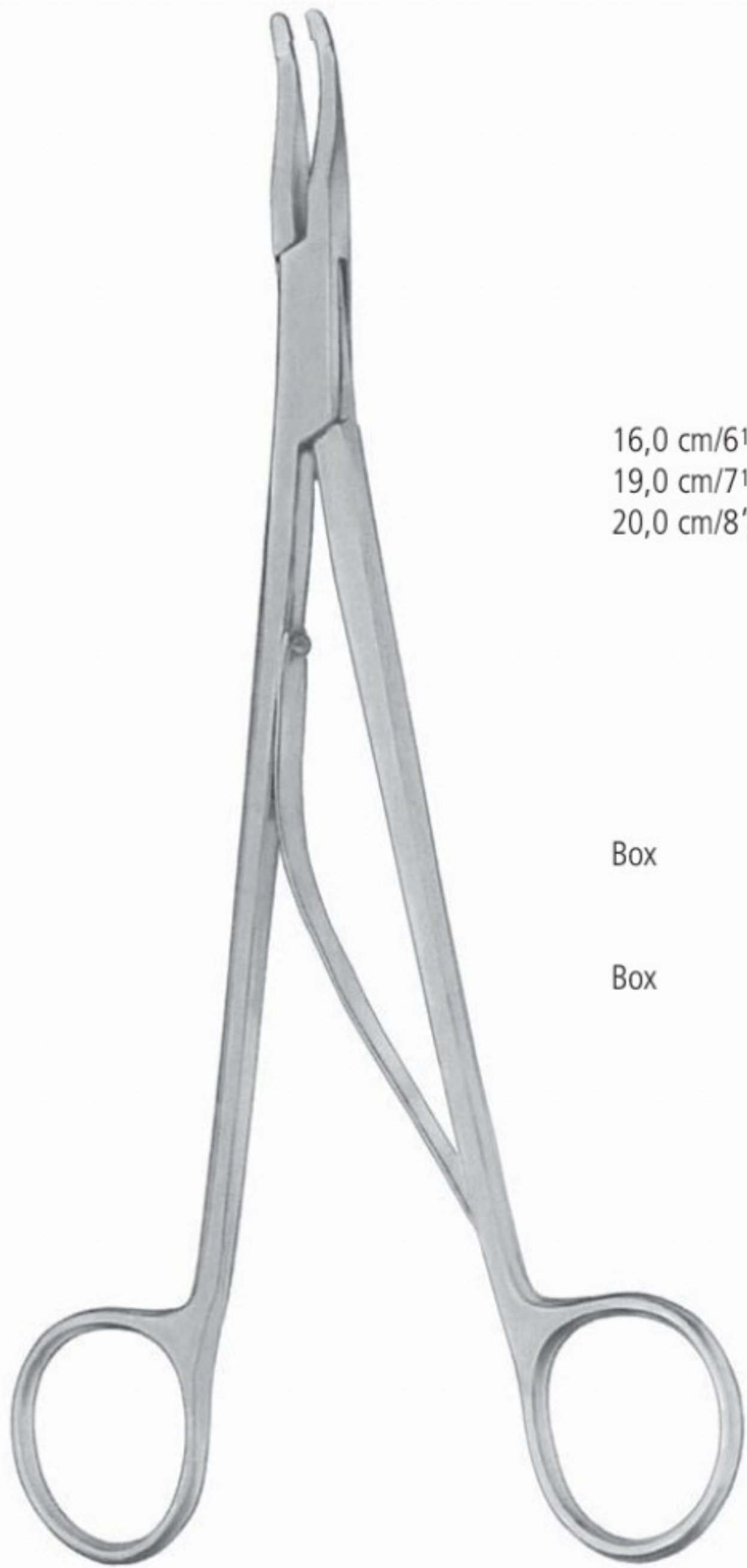
Anlegezangen, Clips
 Applying Forceps, Clips
 Pinzas aplicadoras, Clips
 Pincas pour le cuir chevelu, Clips
 Pinze al cuoio capelluto, Clips

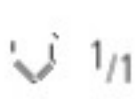
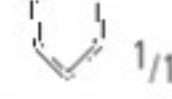

	klein small	mittel medium	mittel-groß medium-large	groß large
	16,0 cm/6 ¹ / ₄ " 19,0 cm/7 ¹ / ₂ " 20,0 cm/8"	KS 240/01 KS 242/01	KS 240/02 KS 242/02	KS 241/01 KS 242/03
	 1/1	 1/1	 1/1	 1/1
Box	12 x 25 clips KS 244/01	10 x 25 clips KS 245/01	16 x 10 clips KS 246/01	10 x 15 clips KS 247/01
Box	24 x 10 clips KS 244/02	20 x 10 clips KS 245/02		12 X 10 clips KS 247/02

AA
AB
AC
AE
AK
AO
AR
KA
KS
XR
XT

Anlegezangen
 Applying Forceps
 Pinzas aplicadoras
 Pincas pour le cuir chevelu
 Pinze al cuoio capelluto

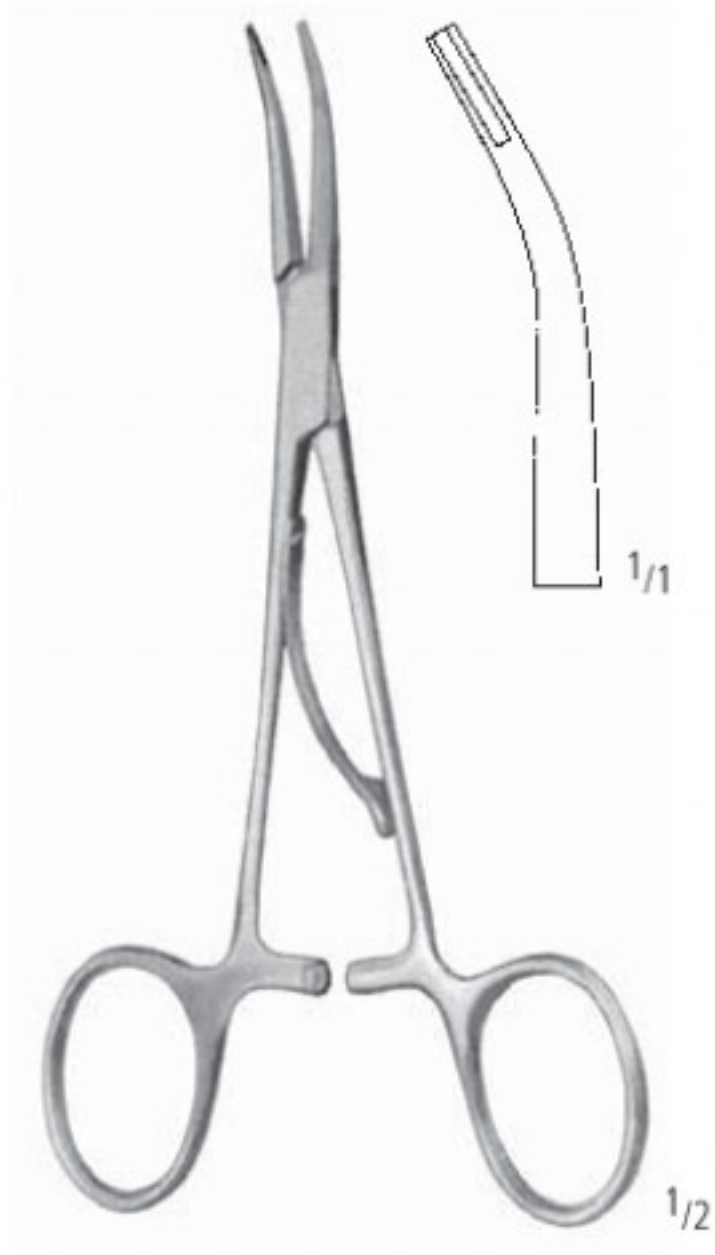

MC KENZIE
 15,0 cm/6" KS 250/15
 19,0 cm/7¹/₂" KS 250/19

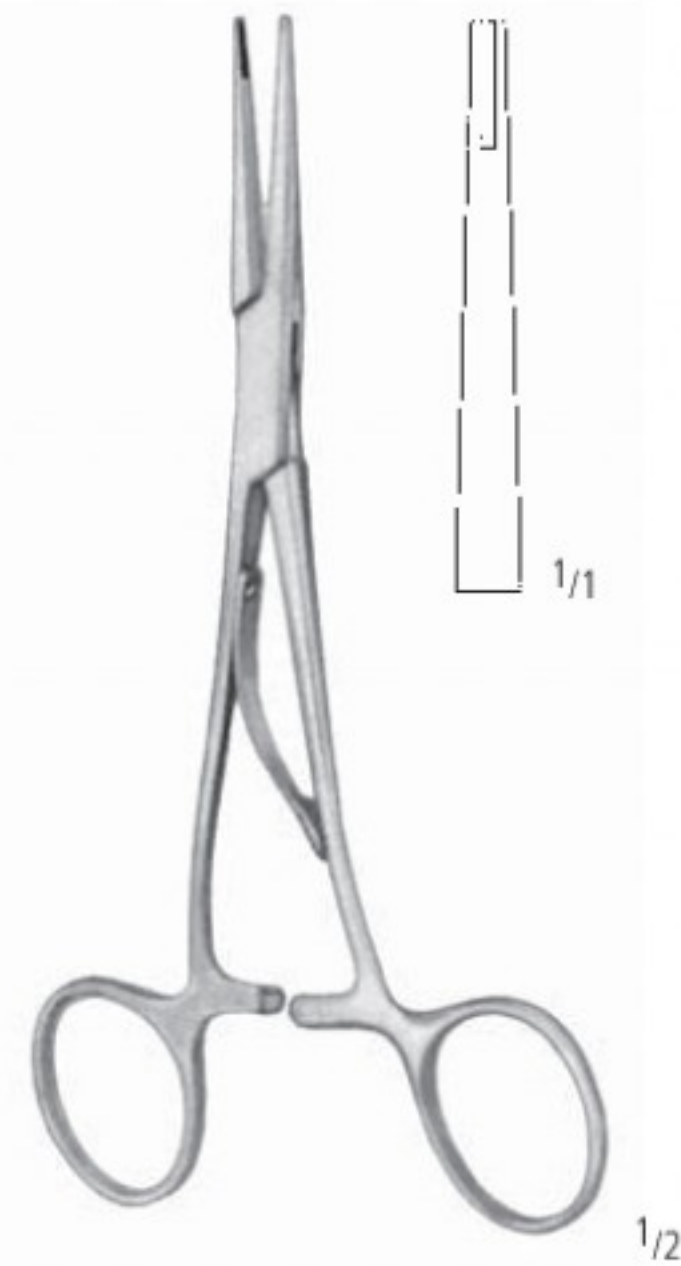

MC KENZIE
 15,0 cm/6" KS 255/15
 19,0 cm/7¹/₂" KS 255/19

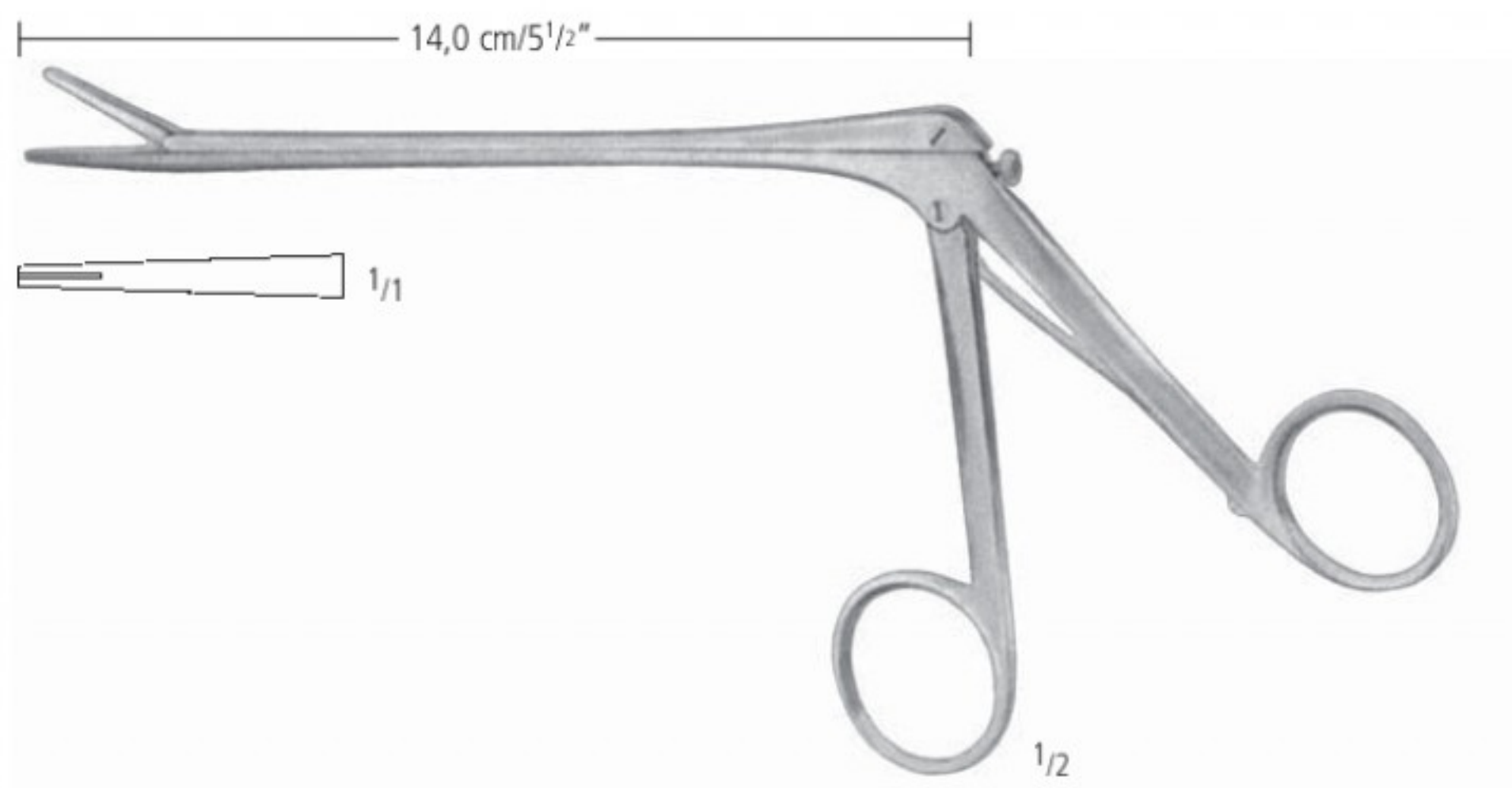

**OLIVECRONA-TOENNIS
 (SCOVILLE)**
 KS 258/00

Klammern und Anlegezangen
 Clips and Applying Forceps
 Grapas y pinzas aplicadoras
 Clips et pinces pour le cuir chevelu
 Agrafes e pinze al cuoio capelluto

AA

AB

AC

AE

AK

AO

AR

KA

KS

XR

XT



MC KENZIE
 148 x 40 x 6 mm
 KS 275/01



MC KENZIE
 190 x 48 x 13 mm
 KS 275/02

Verkaufseinheit: 100 Stück
 Unit for Sale: 100 pieces
 Unidad de venta: 100 piezas
 Unité de vente: 100 pièces
 Unità di vendita: 100 pezzi



KS 277/00

Verkaufseinheit: 10 Stück
 Unit for Sale: 10 pieces
 Unidad de venta: 10 piezas
 Unité de vente: 10 pièces
 Unità di vendita: 10 pezzi



KÖLNER
 KS 282/00



RANEY
 KS 286/00
 16,0 cm/6 1/4"



RANEY
 KS 288/00

Galeahaken
 Galea Hooks
 Gancho para Galea
 Crochets à Galea
 Uncini per Galea

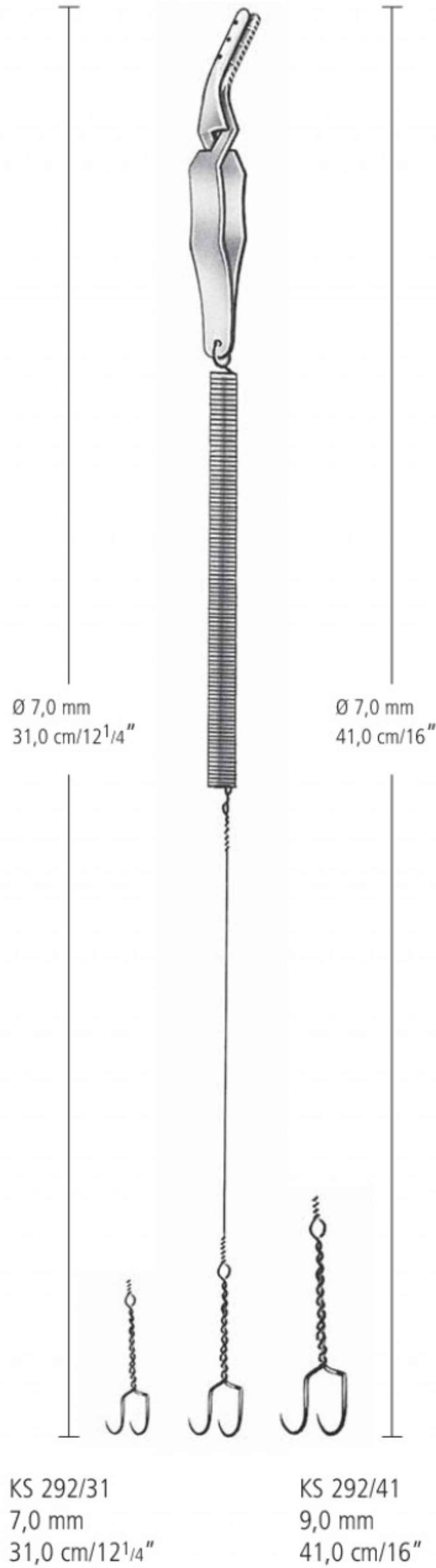

NEUROCHIRURGIE NEUROSURGERY NEUROCIRUGIA NEUROCHIRURGIE NEUROCHIRURGIA

Aneurysmen- und Gefäßclipe
 Aneurysm- and Vessel Clips
 Clips de Aneurisma
 Clips pour Aneurisme
 Clips per Aneurismi

Also available in
TITANIUM

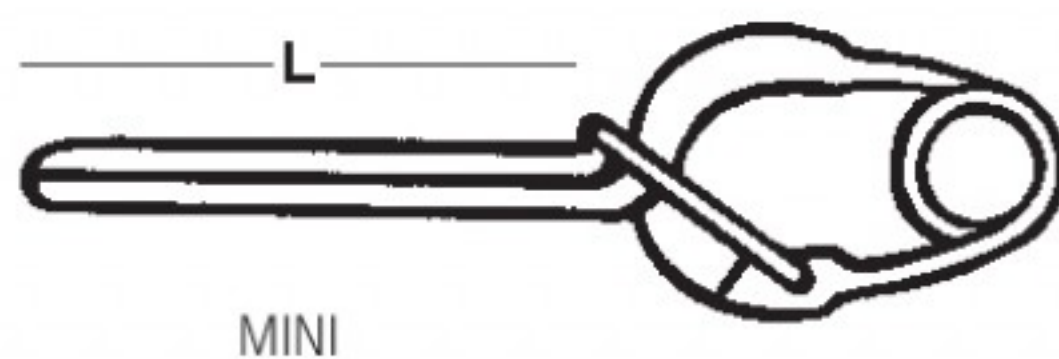

B
 Maulöffnung
 Opening
 Abertura
 Overture
 Apertura

F
 Schließkraft
 Closing Force
 Presión
 Pression
 Pressione

Permanent	KS 300/01	KS 302/01	KS 304/01	KS 306/01	KS 308/01
Temporary	KS 300/02	KS 302/02			KS 308/02

Permanent	KS 301/01	KS 303/01	KS 305/01	KS 307/01	KS 309/01
Temporary		KS 303/02		KS 307/02	

Permanent	KS 311/01	KS 313/01	KS 315/01	KS 317/01	KS 319/01
Temporary		KS 313/02			

	L (mm)	B (mm)	F (g)
KS 300/01	3,0	3,3	110
KS 300/02	3,0	3,3	50
KS 301/01	3,0	3,2	110
KS 302/01	5,0	4,0	110
KS 302/02	5,0	4,0	50
KS 303/01	5,0	3,8	110
KS 303/02	5,0	3,8	50
KS 304/01	3,0	3,3	110
KS 305/01	5,0	3,8	110
KS 306/01	5,0	4,0	110
KS 307/01	7,0	4,4	110

Also available in
TITANIUM

	L (mm)	B (mm)	F (g)
KS 307/02	7,0	4,4	70
KS 308/01	7,0	4,6	110
KS 308/02	7,0	4,6	70
KS 309/01	5,0	3,6	110
KS 311/01	5,0	3,5	110
KS 313/01	7,0	4,0	110
KS 313/02	7,0	4,0	70
KS 315/01	5,0	3,5	130
KS 317/01	7,0	5,7	130
KS 319/01	7,0	4,5	130

KS NEUROCHIRURGIE NEUROSURGERY NEUROCIRUGIA NEUROCHIRURGIE NEUROCHIRURGIA

Aneurysmen- und Gefäßclips
 Aneurysm- and Vessel Clips
 Clips de Aneurisma
 Clips pour Aneurisme
 Clips per Aneurismi

Also available in
TITANIUM

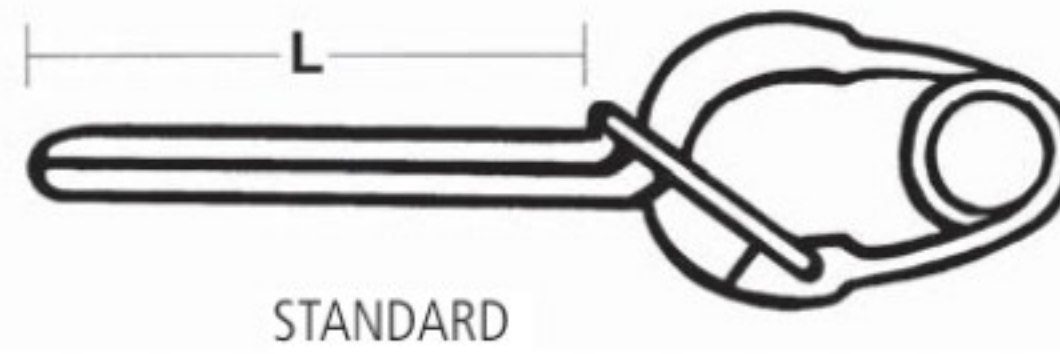

STANDARD

B
 Maulöffnung
 Opening
 Abertura
 Overture
 Apertura

F
 Schließkraft
 Closing Force
 Presión
 Pression
 Pressione

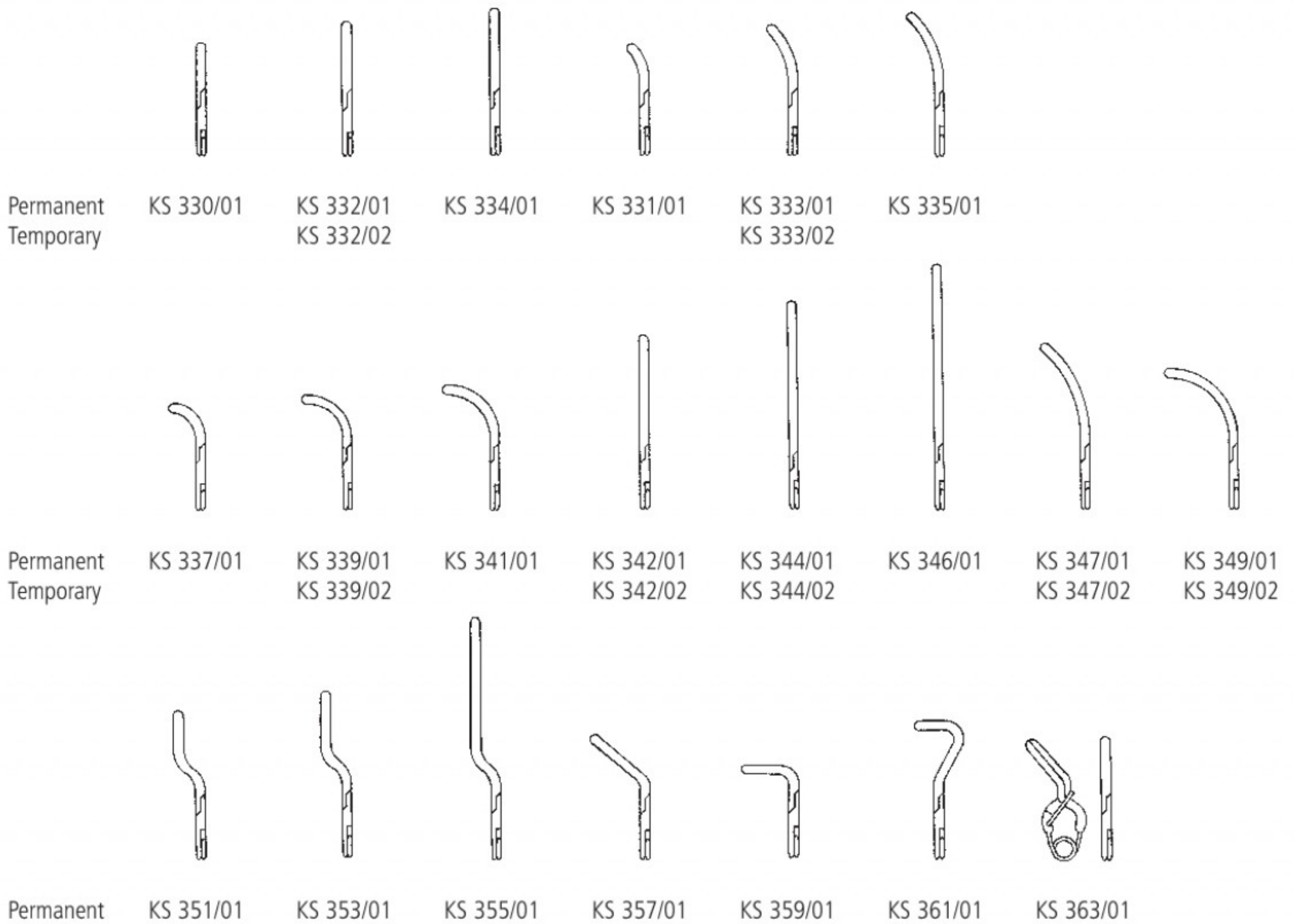

Permanent
 Temporary

Permanent
 Temporary

Permanent

	L (mm)	B (mm)	F (g)		L (mm)	B (mm)	F (g)
KS 330/01	7,0	6,2	150	KS 344/01	20,0	11,4	200
KS 331/01	7,0	6,0	150	KS 344/02	20,0	11,4	90
KS 332/01	9,0	7,0	180	KS 346/01	25,0	13,3	180
KS 332/02	9,0	7,0	70	KS 347/01	15,0	8,7	200
KS 333/01	9,0	6,8	180	KS 347/02	15,0	8,7	70
KS 333/02	9,0	6,8	70	KS 349/01	15,0	7,4	200
KS 334/01	11,0	7,8	180	KS 349/02	15,0	7,4	70
KS 335/01	11,0	7,5	180	KS 351/01	7,0	7,9	200
KS 337/01	7,0	5,5	150	KS 353/01	9,0	8,7	200
KS 339/01	9,0	6,1	180	KS 355/01	20,0	13,0	180
KS 339/02	9,0	6,1	70	KS 357/01	9,0	6,5	200
KS 341/01	11,0	6,5	180	KS 359/01	7,0	4,5	200
KS 342/01	15,0	9,2	200	KS 361/01	7,0	7,2	200
KS 342/02	15,0	9,2	70	KS 363/01	7,0	5,7	200

Also available in
TITANIUM

NEUROCHIRURGIE NEUROSURGERY NEUROCIRUGIA NEUROCHIRURGIE NEUROCHIRURGIA

Aneurysmen- und Gefäßclips
Aneurysm- and Vessel Clips
Clips de Aneurisma
Clips pour Aneurisme
Clips per Aneurismi

Also available in
TITANIUM

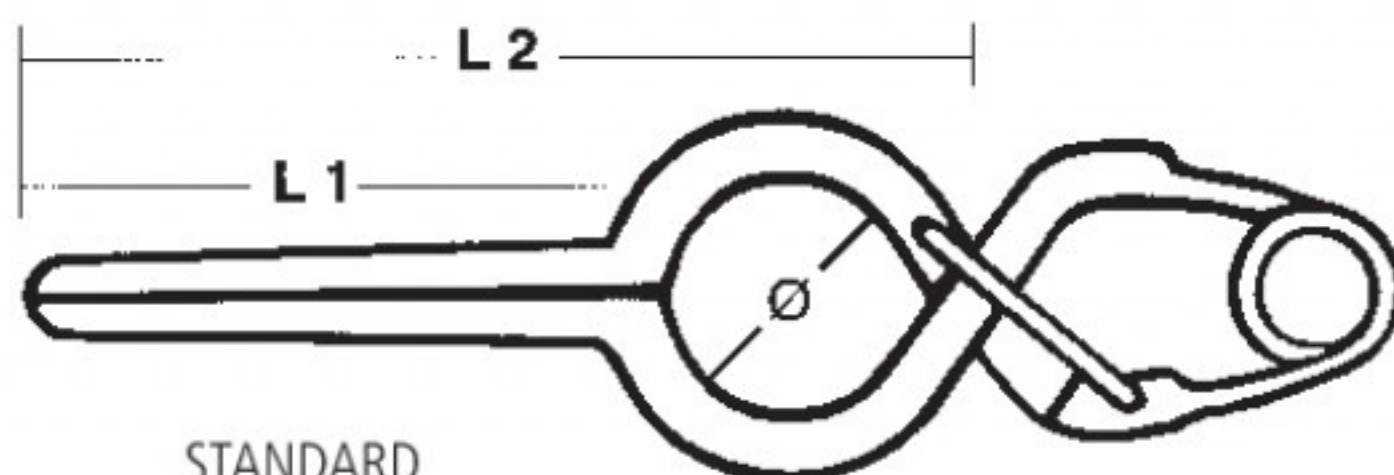

STANDARD
PERMANENT

B
Maulöffnung
Opening
Abertura
Overture
Apertura

F
Schließkraft
Closing Force
Presión
Pression
Pressione

Ø 3,5 mm

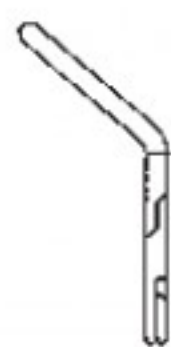
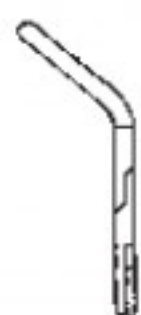

KS 370/01

KS 370/02

KS 370/03

KS 371/01

KS 371/02

KS 371/03

KS 372/01

KS 372/02

KS 372/03

Ø 5,0 mm

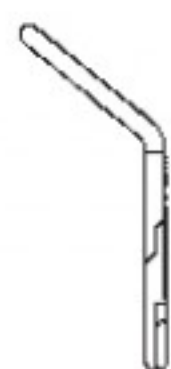
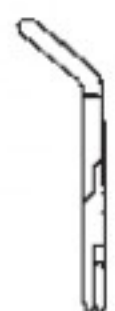

KS 374/01

KS 374/02

KS 374/03

KS 375/01

KS 375/02

KS 375/03

Also available in
TITANIUM

Ø 5,0 mm

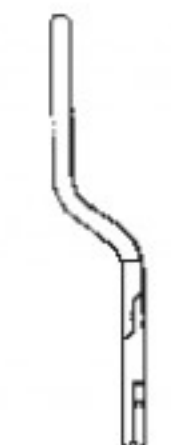
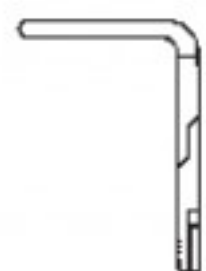

KS 376/01

KS 376/02

KS 376/03

KS 377/01

KS 377/02

KS 377/03

	L1/L2 (mm)	B (mm)	F (g)
KS 370/01	6,0/11,0	7,4	150
KS 370/02	9,0/14,0	8,4	150
KS 370/03	12,0/17,0	9,6	180
KS 371/01	5,0/ 9,0	5,8	150
KS 371/02	7,5/11,5	6,5	150
KS 371/03	10,0/14,0	7,2	180
KS 372/01	5,0/ 9,6	4,9	150
KS 372/02	7,5/12,1	4,9	150
KS 372/03	10,0/14,6	4,9	180
KS 374/01	6,0/12,7	7,9	150
KS 374/02	9,0/15,7	9,1	150
KS 374/03	12,0/18,7	10,3	180

Also available in
TITANIUM

	L1/L2 (mm)	B (mm)	F (g)
KS 375/01	5,0/10,5	6,5	150
KS 375/02	7,5/13,0	7,2	150
KS 375/03	10,0/15,5	7,8	180
KS 376/01	5,0/11,0	5,5	150
KS 376/02	7,5/13,5	5,5	150
KS 376/03	10,0/16,0	5,5	180
KS 377/01	5,0/14,8	7,9	150
KS 377/02	7,5/17,3	8,8	150
KS 377/03	10,0/19,8	10,0	180

AA

AB

AC

AE

AK

AO

AR

KA

KS

XR

XT

Anlegezangen für Aneurysmen-Clips
 Applying Forceps for Aneurysm Clips
 Pinza para juntar clips de Aneurisma
 Pince pour poser les clips de Aneurisme
 Pinze per applicare clips Aneurismi

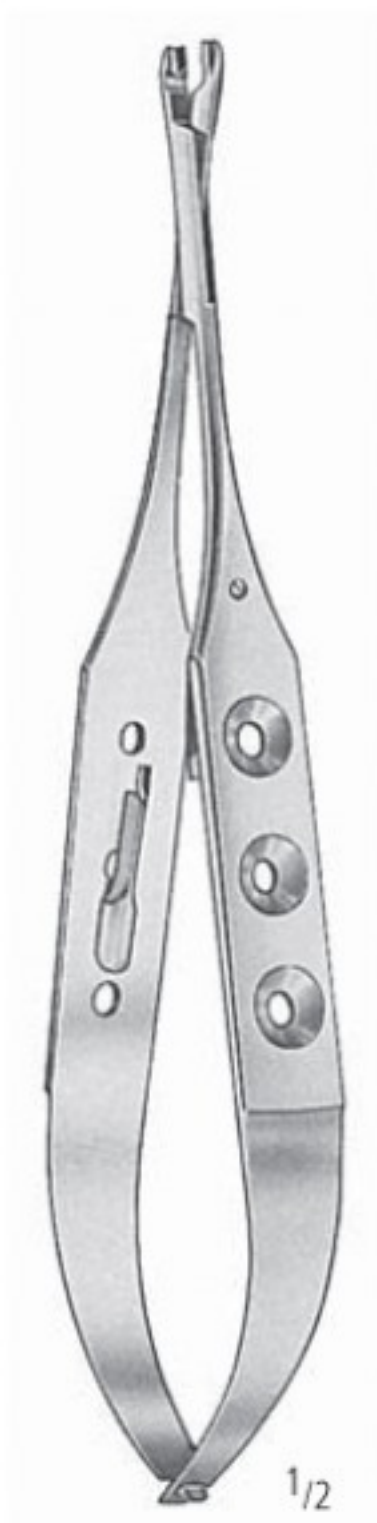

18,0 cm/7"

MINI KS 390/01
 STANDARD KS 390/02



17,0 cm/6³/₄"

KS 391/01
 KS 391/02



20,5 cm/8"

KS 392/01
 KS 392/02

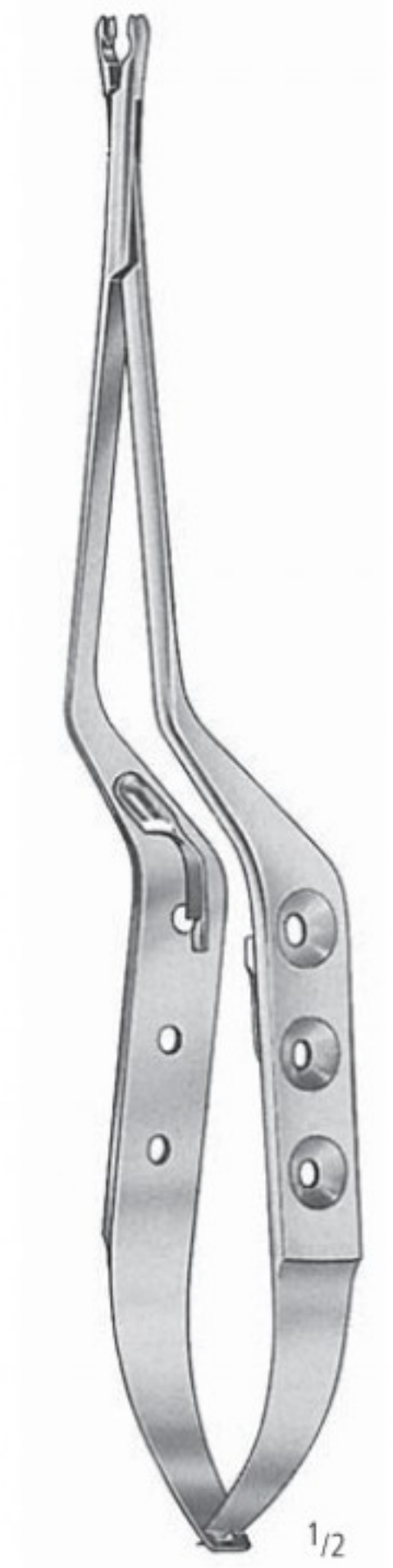

22,5 cm/9"

KS 393/01
 KS 393/02

Anlegezangen für Aneurysmen-Clips
 Applying Forceps for Aneurysm Clips
 Pinza para juntar clips de Aneurisma
 Pince pour poser les clips de Aneurisme
 Pinze per applicare clips Aneurismi

AA

AB

AC

AE

AK

AO

AR

KA

KS

XR

XT

FLEXIBLE

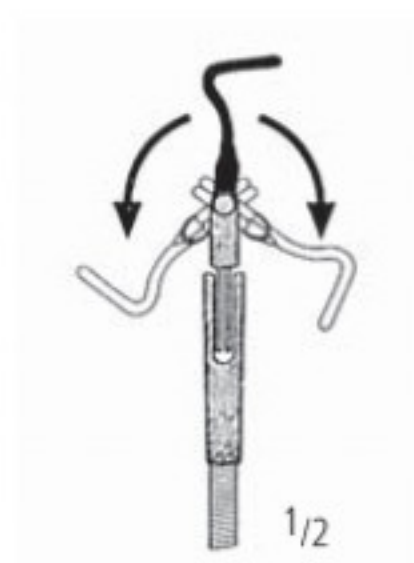

Beispiel für Drehmechanismus
 Example for rotation
 Ejemplo para la rotación
 Exemple pour la rotation
 Esempio per la rotazione

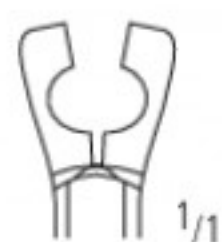
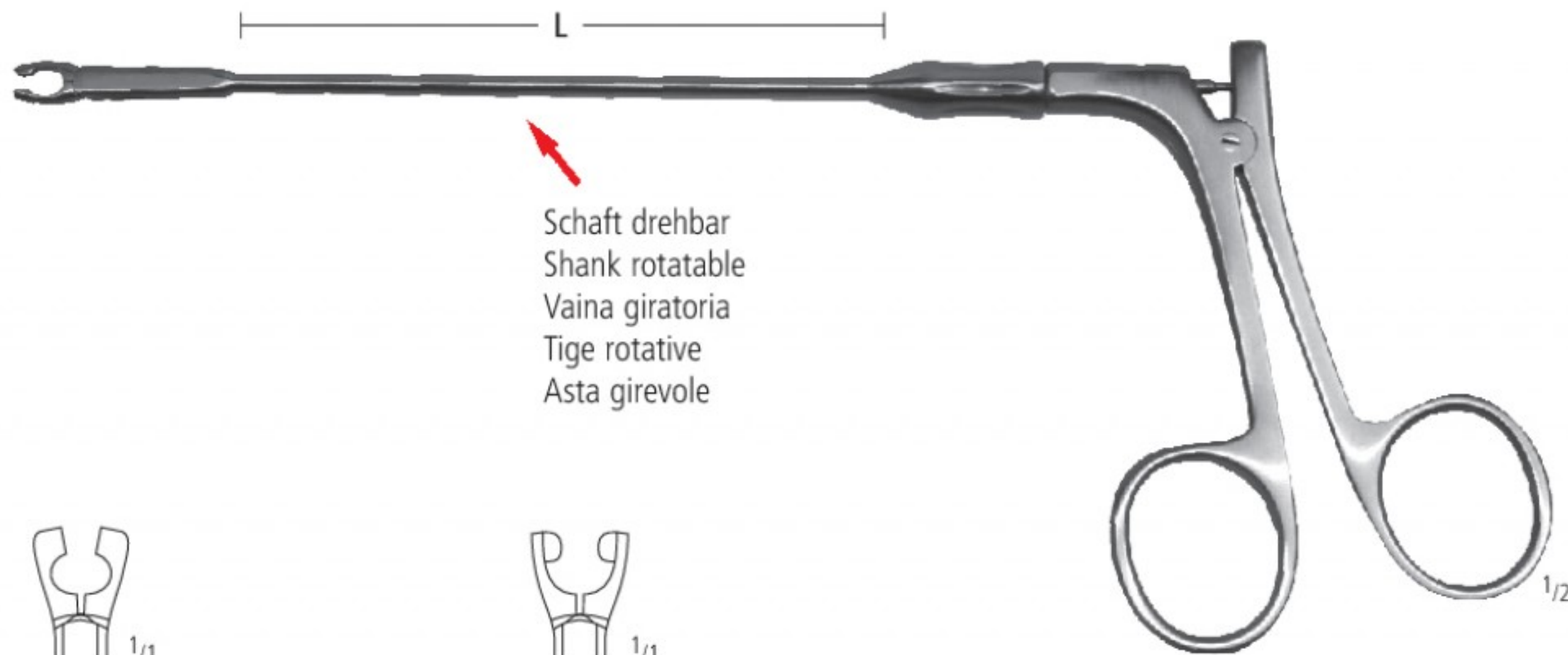

MINI

70mm/2³/₄"
 90mm/3¹/₂"
 110mm/4¹/₄"
 130mm/5"

KS 396/11
 KS 396/12
 KS 396/13
 KS 396/14

nicht drehbar
 non rotating
 non rotatif
 non rotativo
 non rotatorio

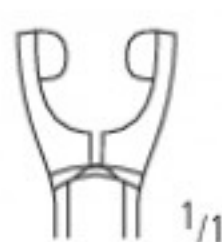

STANDARD

KS 396/21
 KS 396/22
 KS 396/23
 KS 396/24

MINI

KS 397/11
 KS 397/12
 KS 397/13
 KS 397/14

drehbar
 rotating
 rotatif
 rotativo
 rotatorio

STANDARD

KS 397/21
 KS 397/22
 KS 397/23
 KS 397/24

Muskelspreizer
 Discectomy Retractors
 Separadores para músculos
 Ecarteurs musculaire
 Divaricatori muscolari



KS 520/01



1/11

20 x 50 mm

20 x 60 mm

20 x 70 mm

∧ KS 520/50

KS 520/60

KS 520/70

∩ KS 520/51

KS 520/61

KS 520/71

- HEY**
 KS 520/00 = 1 x KS 520/01
 + 1 x KS 520/50
 + 1 x KS 520/60
 + 1 x KS 520/70
 + 1 x KS 520/37
 + 1 x KS 520/53
 + 1 x KS 520/62



1/11

KS 520/37
 37 mm

KS 520/53
 53 mm

KS 520/62
 62 mm

Muskelspreizer
 Discectomy Retractors
 Separadores para músculos
 Ecarteurs musculaire
 Divaricatori muscolari

AA

AB

AC

AE

AK

AO

AR

KA

KS

XR

XT



KS 521/51 - KS 521/72
 17,0 cm/6³/₄"



KS 522/51 - KS 522/72
 17,0 cm/6³/₄"

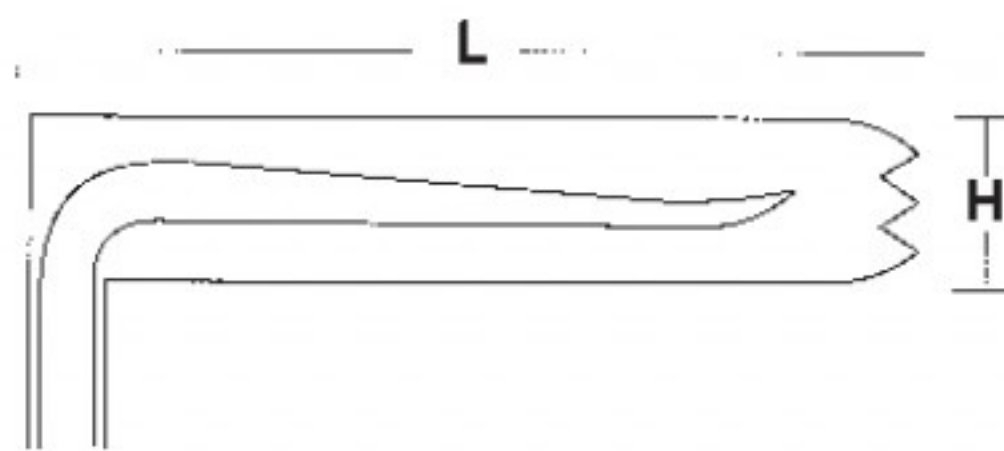

L	H	Linksmodell Left-type	Rechtsmodell Right-type
50 mm x 10 mm		KS 521/51	KS 522/51
60 mm x 10 mm		KS 521/61	KS 522/61
70 mm x 10 mm		KS 521/71	KS 522/71
50 mm x 20 mm		KS 521/52	KS 522/52
60 mm x 20 mm		KS 521/62	KS 522/62
70 mm x 20 mm		KS 521/72	KS 522/72

Wundspreizer Wirbelsäule
 Cervical Retractors
 Separadores vertebrales
 Ecarteurs cervicales
 Divaricatori vertebrali

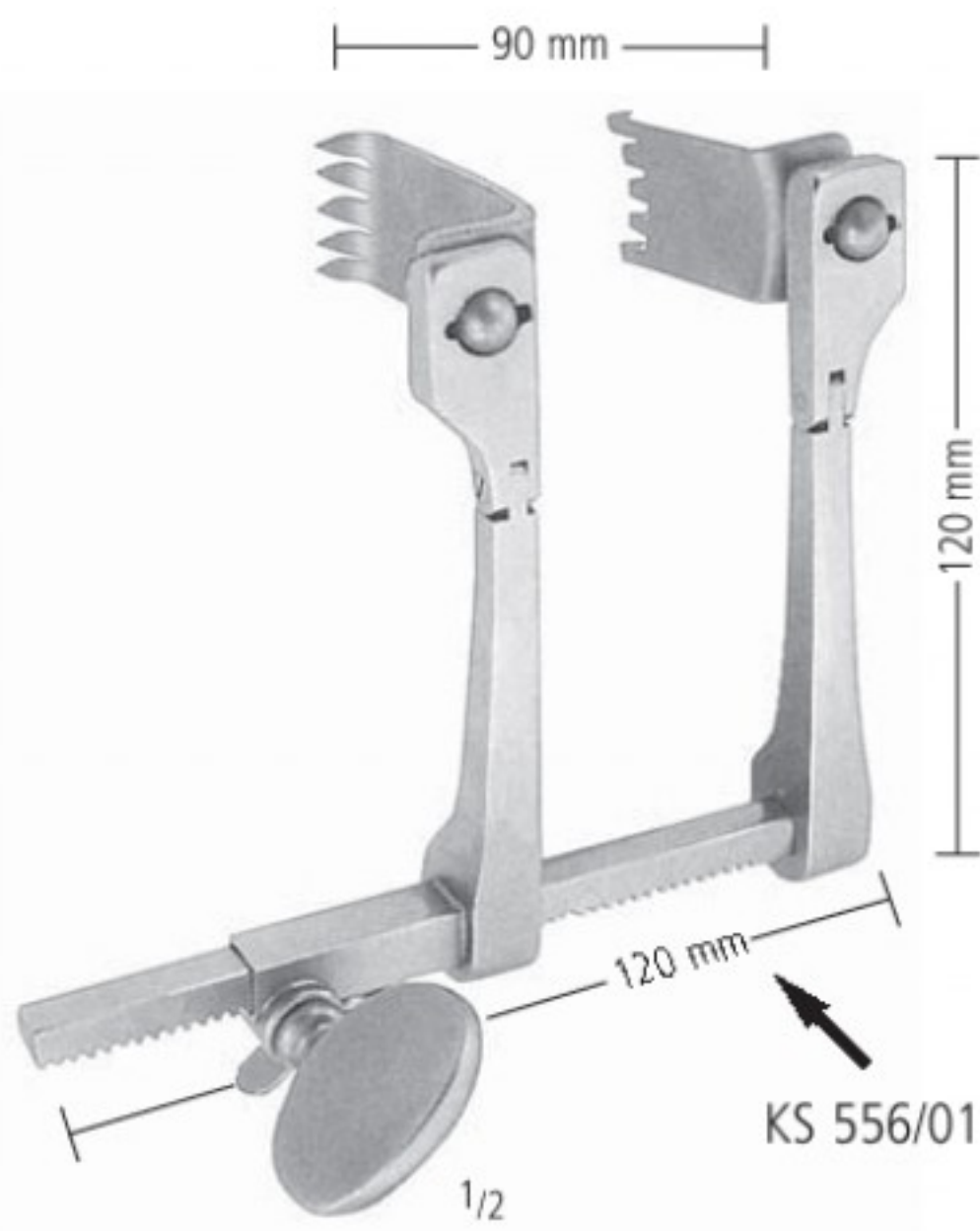

CASPAR
 KS 556/00
 Transversal



CASPAR
 KS 557/00

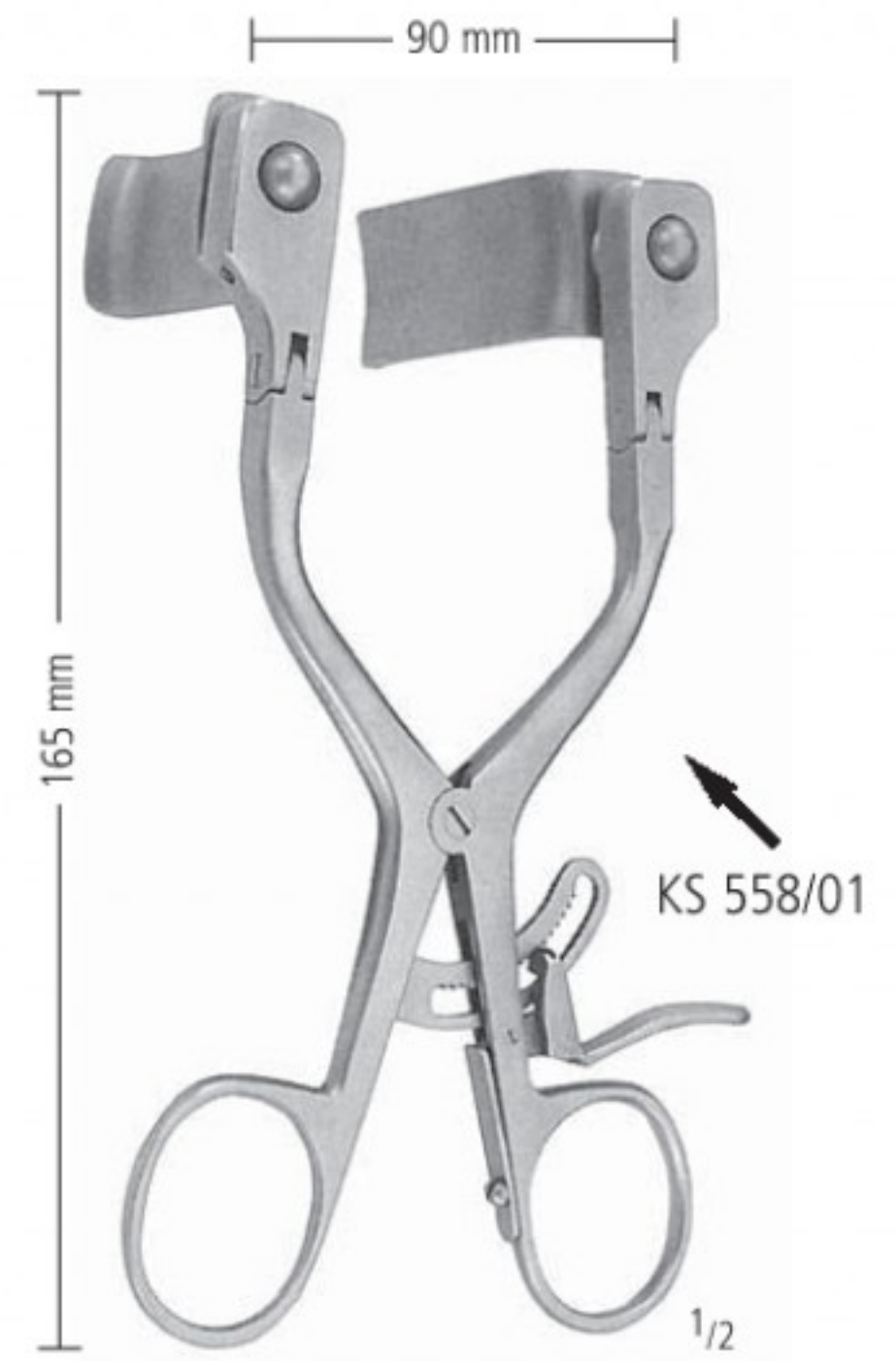

CASPAR
 KS 558/00

- KS 556/00 = 1 x KS 556/01
- + 1 x KS 559/01
- + 1 x KS 559/02
- + 1 x KS 559/03
- + 1 x KS 559/04
- + 1 x KS 559/05
- + 1 x KS 559/11
- + 1 x KS 559/12
- + 1 x KS 559/13
- + 1 x KS 559/14
- + 1 x KS 559/15

- KS 557/00 = 1 x KS 557/01
- + 1 x KS 559/21
- + 1 x KS 559/22
- + 1 x KS 559/23
- + 1 x KS 559/24
- + 1 x KS 559/25

- KS 558/00 = 1 x KS 558/01
- + 1 x KS 559/21
- + 1 x KS 559/22
- + 1 x KS 559/23
- + 1 x KS 559/24
- + 1 x KS 559/25

Wundspreizer Wirbelsäule
 Cervical Retractors
 Separadores vertebrales
 Ecarteurs cervicales
 Divaricatori vertebrali

AA

AB

AC

AE

AK

AO

AR

KA

KS

XR

XT



1/1

- 40 x 23 mm KS 559/01
- 45 x 23 mm KS 559/02
- 50 x 23 mm KS 559/03
- 55 x 23 mm KS 559/04
- 60 x 23 mm KS 559/05



1/1

- 40 x 23 mm KS 559/11
- 45 x 23 mm KS 559/12
- 50 x 23 mm KS 559/13
- 55 x 23 mm KS 559/14
- 60 x 23 mm KS 559/15



1/1

- 45 x 23 mm KS 559/21
- 50 x 23 mm KS 559/22
- 55 x 23 mm KS 559/23
- 60 x 23 mm KS 559/24
- 65 x 23 mm KS 559/25



1/1

- 50 x 25 mm KS 559/50
- 60 x 25 mm KS 559/60



1/2

KS 564/00
 11,5 cm/4 1/2"

Wundspreizer Wirbelsäule
 Cervical Retractors
 Separadores vertebrales
 Ecarteurs cervicaux
 Divaricatori vertebrali

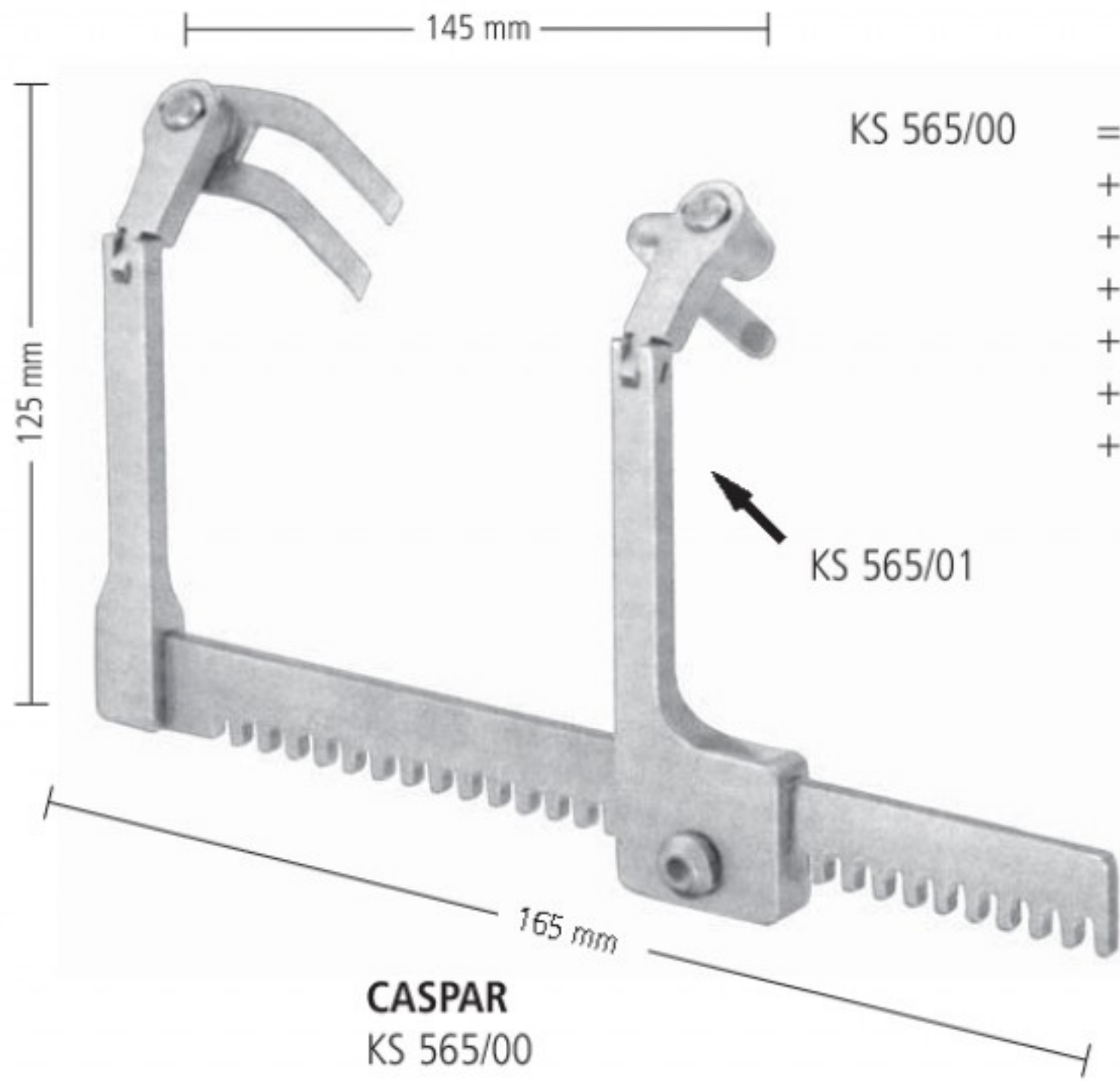

- KS 565/00 = 1 x KS 565/01
 + 1 x KS 565/99
 + 1 x KS 566/21
 + 1 x KS 566/22
 + 1 x KS 566/23
 + 1 x KS 566/24
 + 1 x KS 566/25



38 mm KS 566/01	58 mm KS 566/02	22 mm	37 mm	52 mm
		L		
		32 mm	KS 566/30	KS 566/40
		37 mm	KS 566/21	KS 566/41
		43 mm	KS 566/22	KS 566/42
		47 mm	KS 566/23	KS 566/43
		52 mm	KS 566/24	KS 566/44
		57 mm	KS 566/25	KS 566/45
		62 mm	KS 566/26	KS 566/46
		67 mm	KS 566/27	KS 566/47

Wundspreizer
Retractors
Separadores
Ecarteurs
Divaricatori

AA

AB

AC

AE

AK

AO

AR

KA

KS

XR

XT

Oberfläche geschwärzt
Surface black-finish

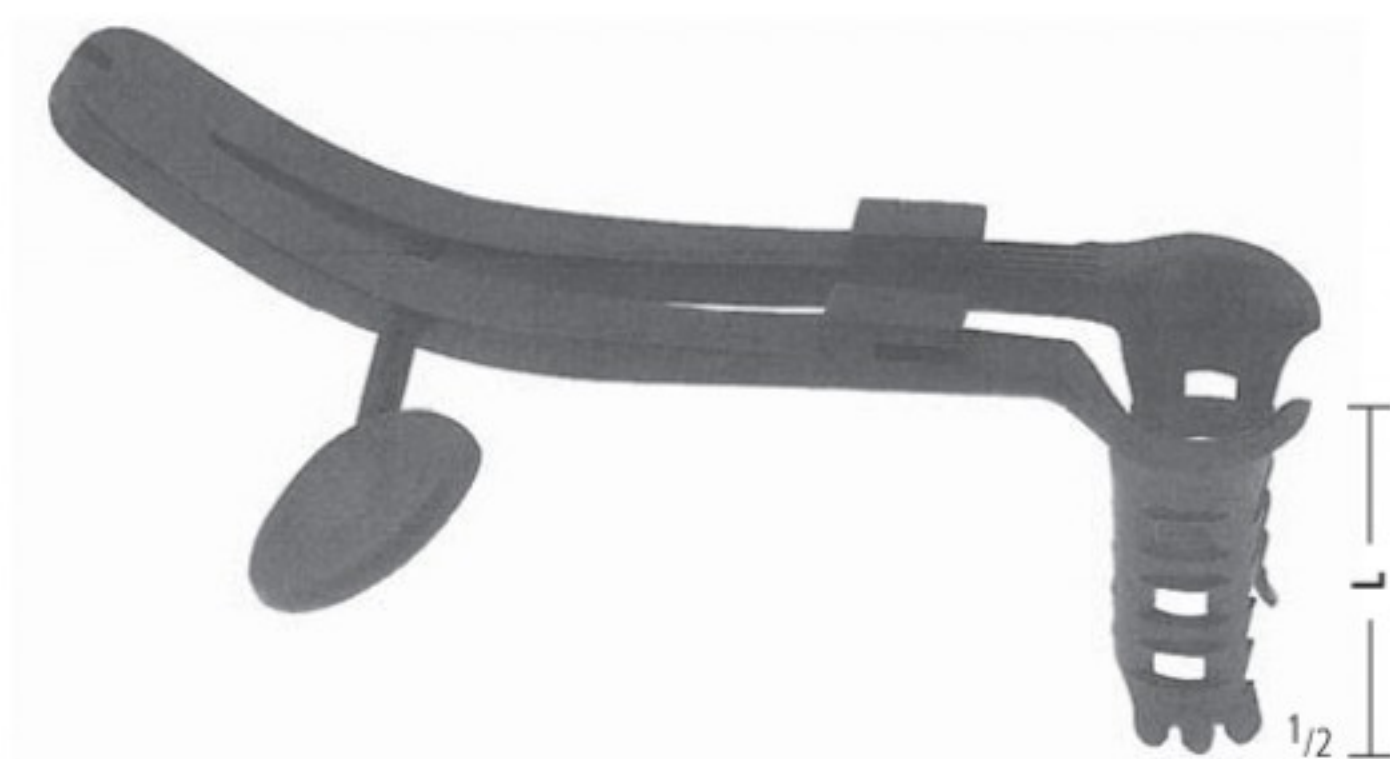

L	
40 mm	KS 568/40
45 mm	KS 568/45
50 mm	KS 568/50
55 mm	KS 568/55
60 mm	KS 568/60

CASPAR



CASPAR

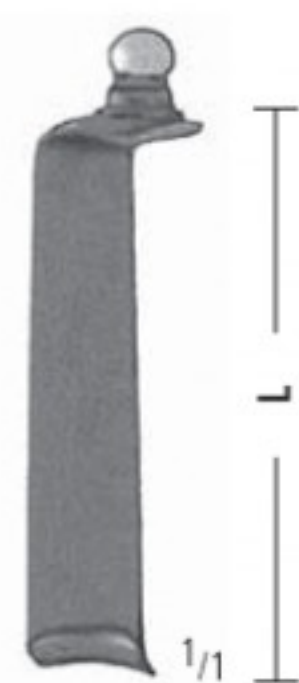

L	
35 mm	KS 569/35
40 mm	KS 569/40
45 mm	KS 569/45
50 mm	KS 569/50
55 mm	KS 569/55
60 mm	KS 569/60

KS 569/00	=	1 x KS 569/01
	+	1 x KS 569/35
	+	1 x KS 569/40
	+	1 x KS 569/45
	+	1 x KS 569/50
	+	1 x KS 569/55
	+	1 x KS 569/60

Wundspreizer
 Retractors
 Separadores
 Ecarteurs
 Divaricatori

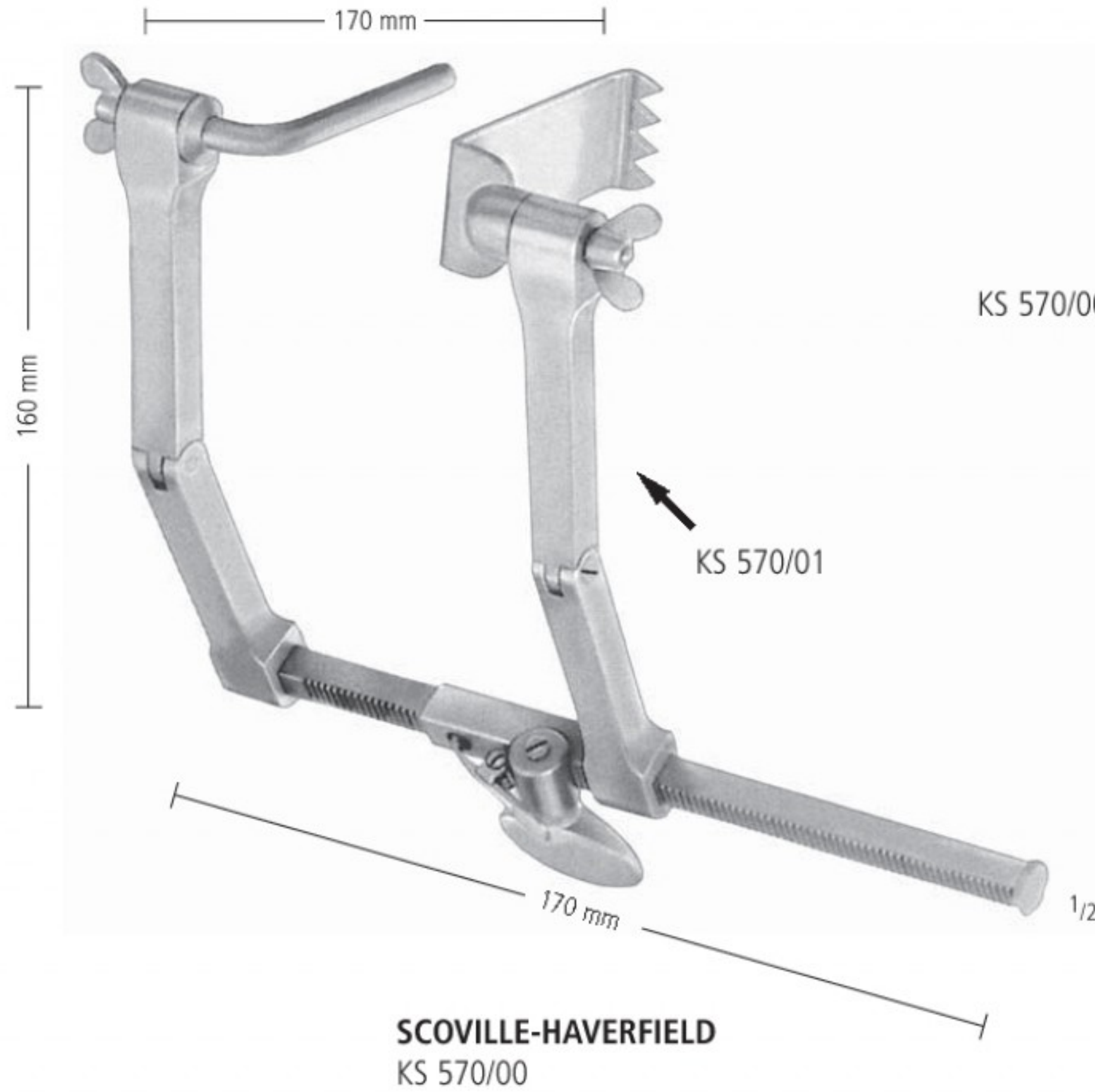

KS 570/00 = 1 x KS 570/01
 + 1 x KS 570/02
 + 1 x KS 570/10



SCOVILLE
KS 570/02
5,5 cm/2"



SCOVILLE
63 x 25 mm KS 570/10
63 x 51 mm KS 570/11
67 x 32 mm KS 570/12
89 x 25 mm KS 570/13



TAYLOR
47 X 37 mm KS 570/33



TAYLOR
63 X 51 mm KS 570/44

Wundspreizer
Retractors
Separadores
Ecarteurs
Divaricatori

AA

AB

AC

AE

AK

AO

AR

KA

KS

XR

XT

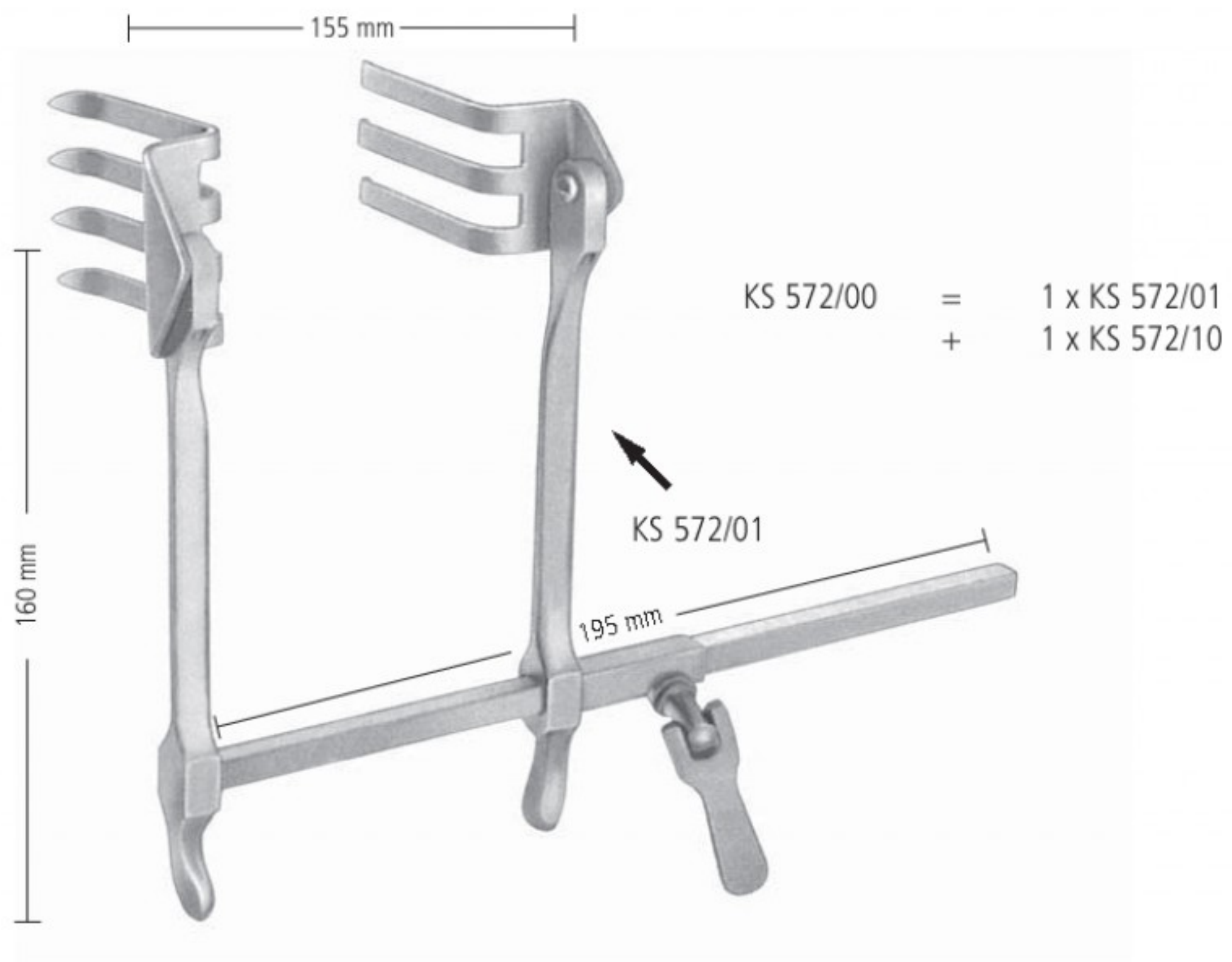

SCOVILLE-RICHTER
KS 572/00



KS 572/10 (Paar/Pair)
62 x 52 mm 62 x 37 mm



KS 572/20
47 x 51 mm



KS 572/30
30 x 40 mm



KS 572/40
37 x 62 mm

Wundspreizer
 Retractors
 Separadores
 Ecarteurs
 Divaricatori



CLOWARD modif.
 KS 580/00
 25,0 cm/10"



L	
40 mm	KS 580/10
45 mm	KS 580/11
50 mm	KS 580/12
55 mm	KS 580/13
60 mm	KS 580/14



L	
40 mm	KS 580/20
45 mm	KS 580/21
50 mm	KS 580/22
55 mm	KS 580/23
60 mm	KS 580/24

KS 580/00	=	1 x KS 580/01
	+	1 x KS 580/10
	+	1 x KS 580/11
	+	1 x KS 580/12
	+	1 x KS 580/13
	+	1 x KS 580/14

Wundspreizer
Retractors
Separadores
Ecarteurs
Divaricatori

AA

AB

AC

AE

AK

AO

AR

KA

KS

XR

XT



KS 582/00

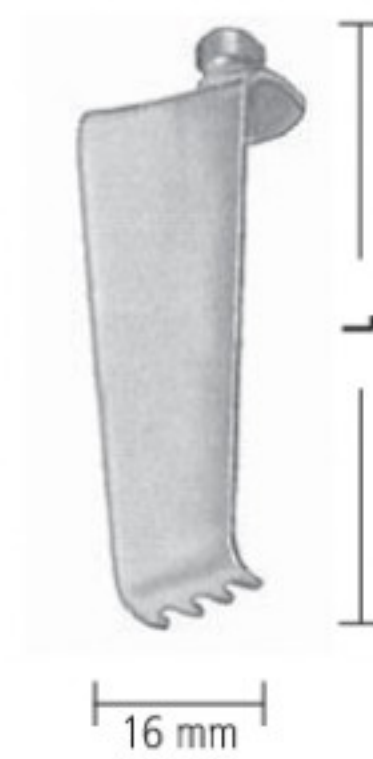

L	
40 mm	KS 580/10
45 mm	KS 580/11
50 mm	KS 580/12
55 mm	KS 580/13
60 mm	KS 580/14



L	
40 mm	KS 580/20
45 mm	KS 580/21
50 mm	KS 580/22
55 mm	KS 580/23
60 mm	KS 580/24

KS 582/00	=	1 x KS 582/01
	+	1 x KS 580/10
	+	1 x KS 580/11
	+	1 x KS 580/12
	+	1 x KS 580/13
	+	1 x KS 580/14

Wirbelkörperspreizer
 Lamina Spreaders
 Separadores para cuerpos vertebrales
 Ecarteurs pour corps vertébraux
 Separatori per vertebre

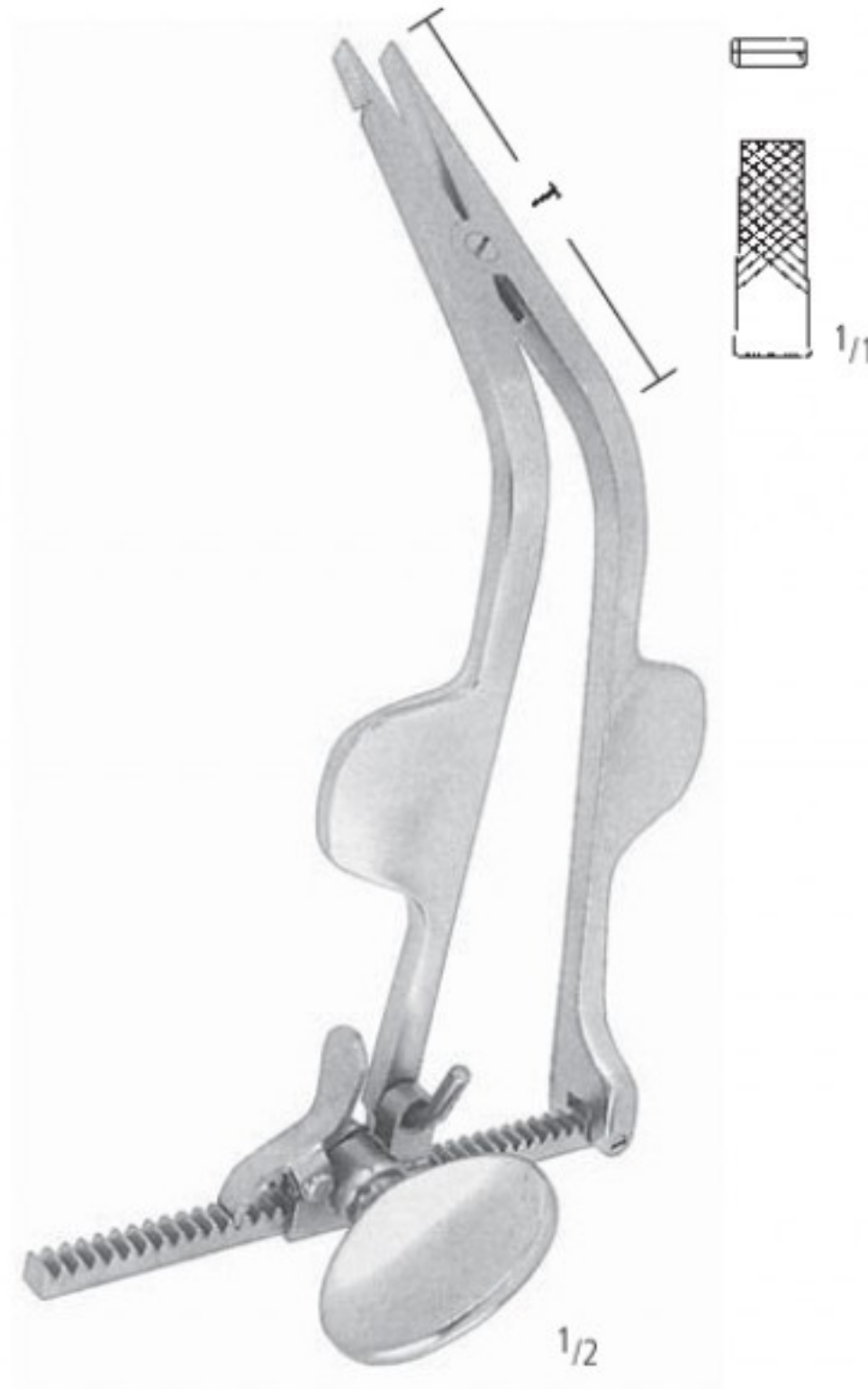

CLOWARD
 KS 587/08
 T = 70 mm



CLOWARD
 KS 588/09 KS 588/11
 9,0 cm/3³/₄" 11,0 cm/4¹/₄"



CLOWARD
 KS 589/00
 21,0 cm/8¹/₄"

Wirbelkörperspreizer
 Lamina Spreaders
 Separadores para cuerpos vertebrales
 Ecarteurs pour corps vertébraux
 Separatori per vertebre

AA

AB

AC

AE

AK

AO

AR

KA

KS

XR

XT



HARMS
 KS 590/01
 18,0 cm/7"



HARMS
 KS 590/02
 18,0 cm/7"

Wirbelkörperspreizer
 Lamina Spreaders
 Separadores para cuerpos vertebrales
 Ecarteurs pour corps vertébraux
 Separatori per vertebre



CLOWARD
 KS 592/16
 16,0 cm/6 1/2"

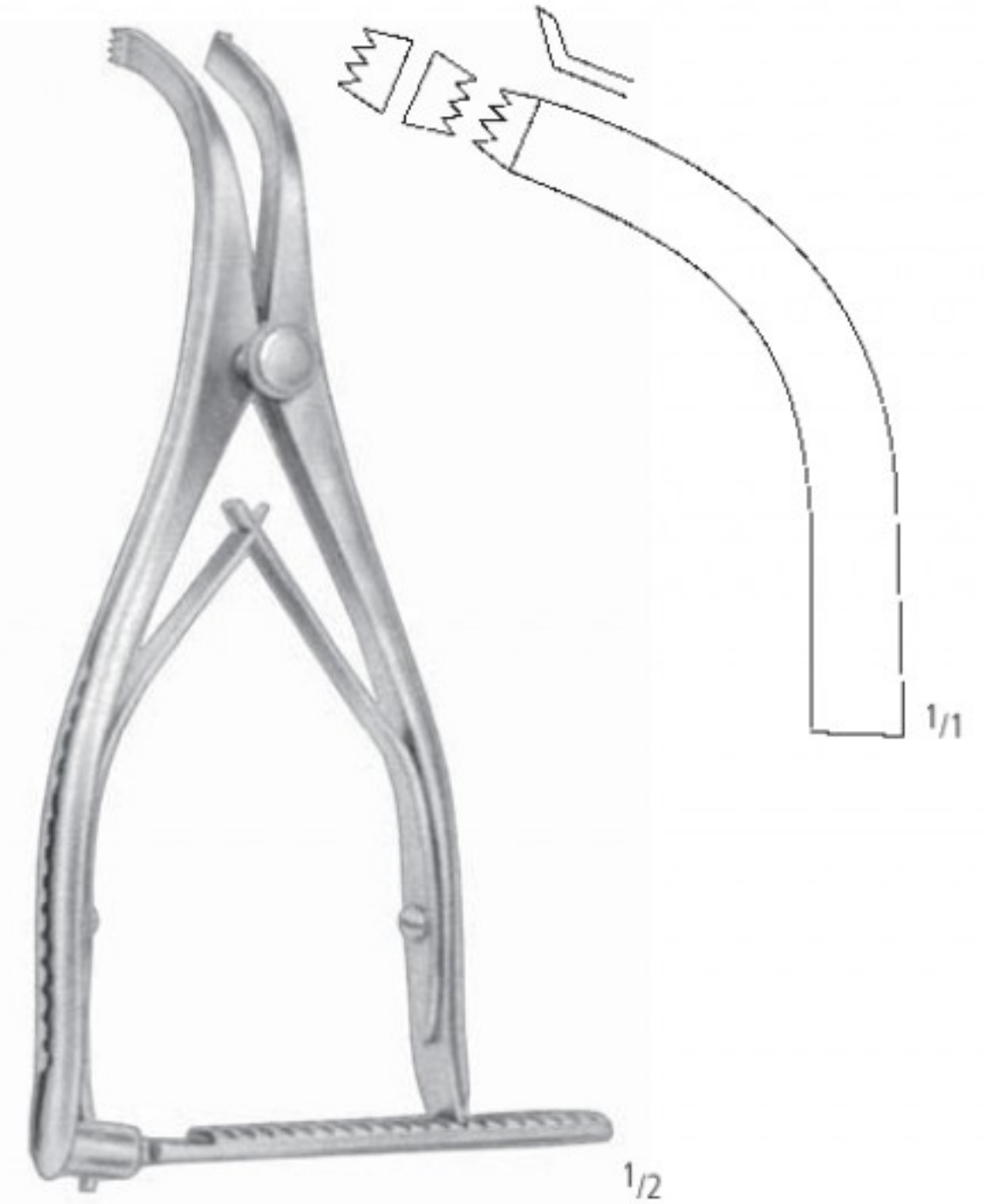

INGE
 KS 593/17
 16,5 cm/6 1/2"



INGE
 KS 594/27
 27,0 cm/10 3/4"

Nervwurzelhaken
 Nerve Root Retractors
 Separadores de raiz de nervios
 Rétracteurs pour racines nerveuses
 Uncini per le radici dei nervi

AA

AB

AC

AE

AK

AO

AR

KA

KS

XR

XT

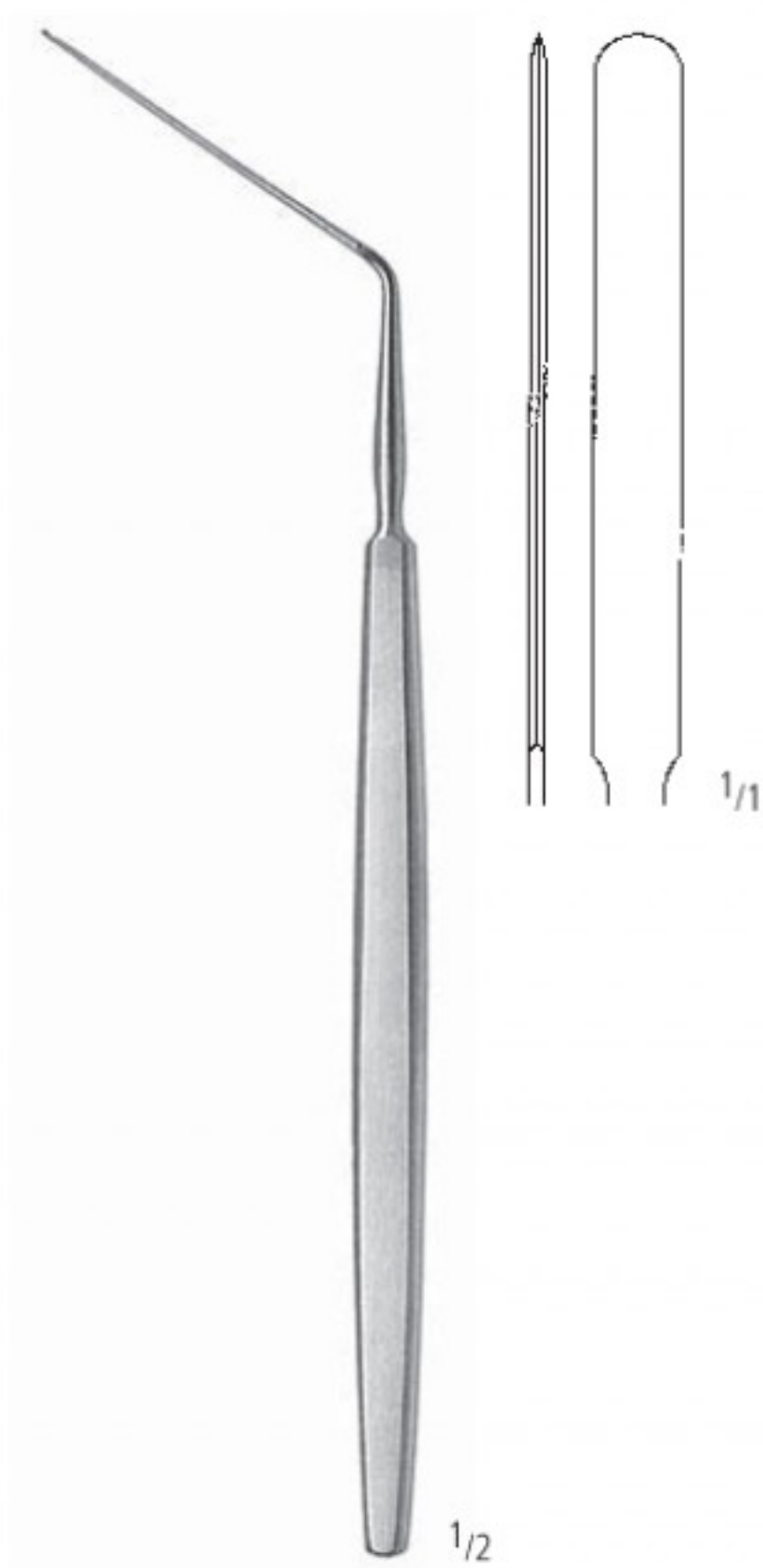

HORSLEY
 KS 607/20
 20,0 cm/8"

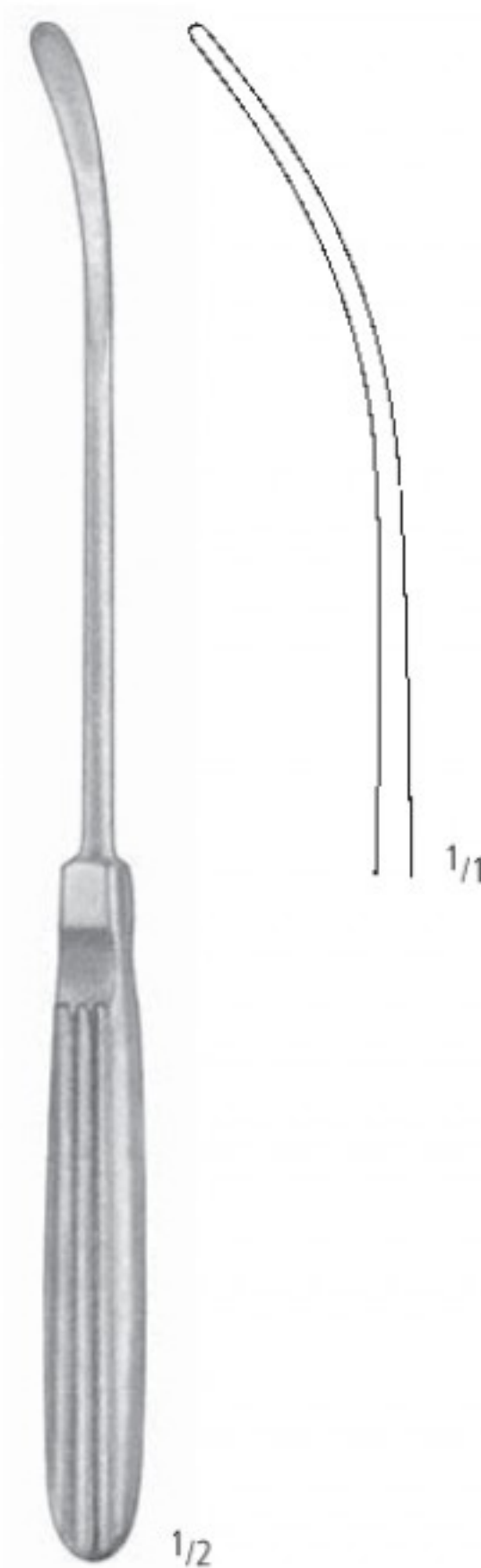

SACHS
 KS 608/21
 21,0 cm/8 1/2"



SCOVILLE
 KS 609/23
 23,0 cm/9 1/4"

Nervwurzelhaken
 Nerve Root Retractors
 Separadores de raiz de nervios
 Rétracteurs pour racines nerveuses
 Uncini per le radici dei nervi

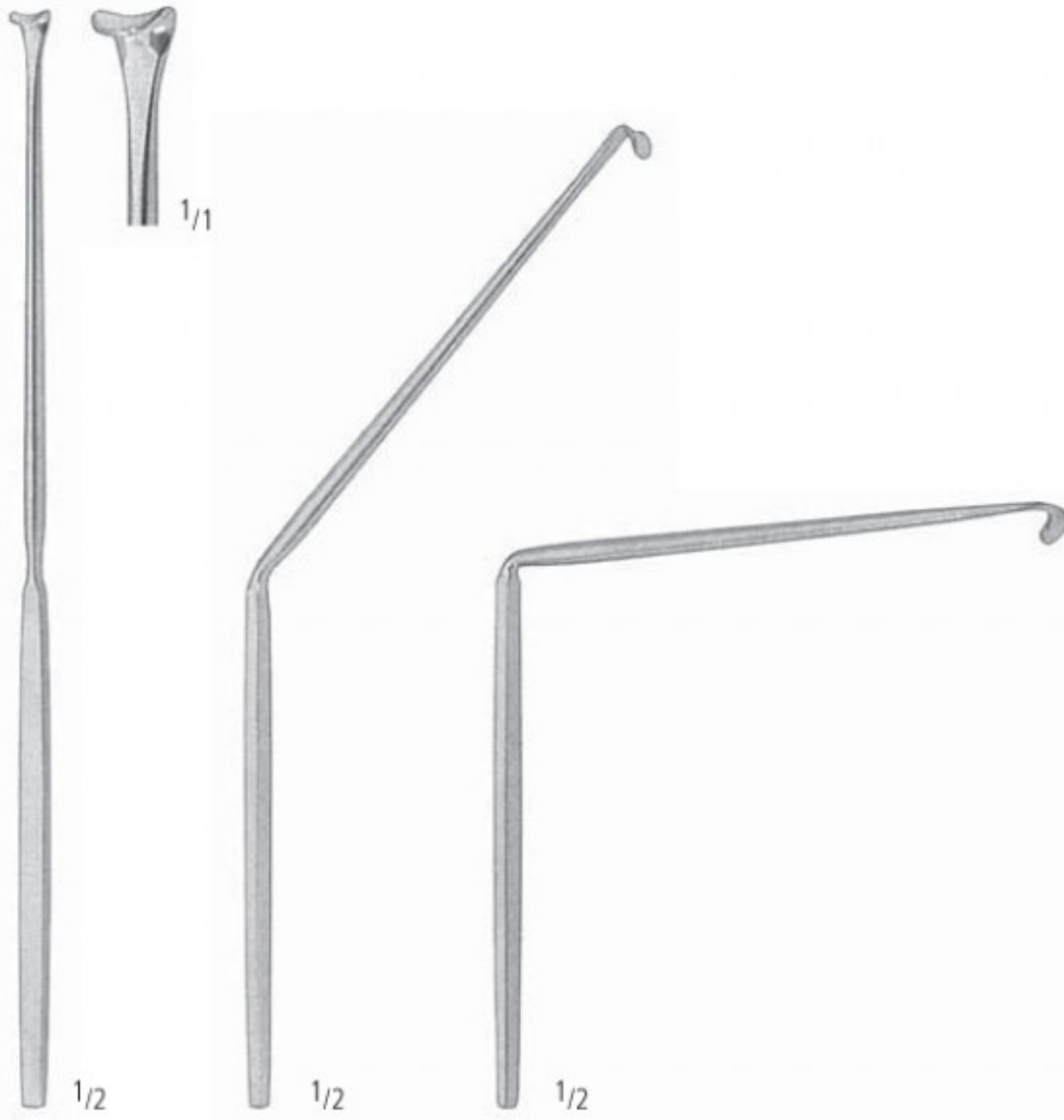

Tip
 3 mm
 5 mm
 7 mm

L	L
7,0 cm/3"	10,0 cm/4"
KS 610/11	KS 610/21
KS 610/12	KS 610/22
KS 610/13	KS 610/23

LOVE

	45°	90°
KS 610/01	KS 610/02	KS 610/03
19,0 cm/7 1/2"	19,0 cm/7 1/2"	19,0 cm/7 1/2"

LOVE modif.

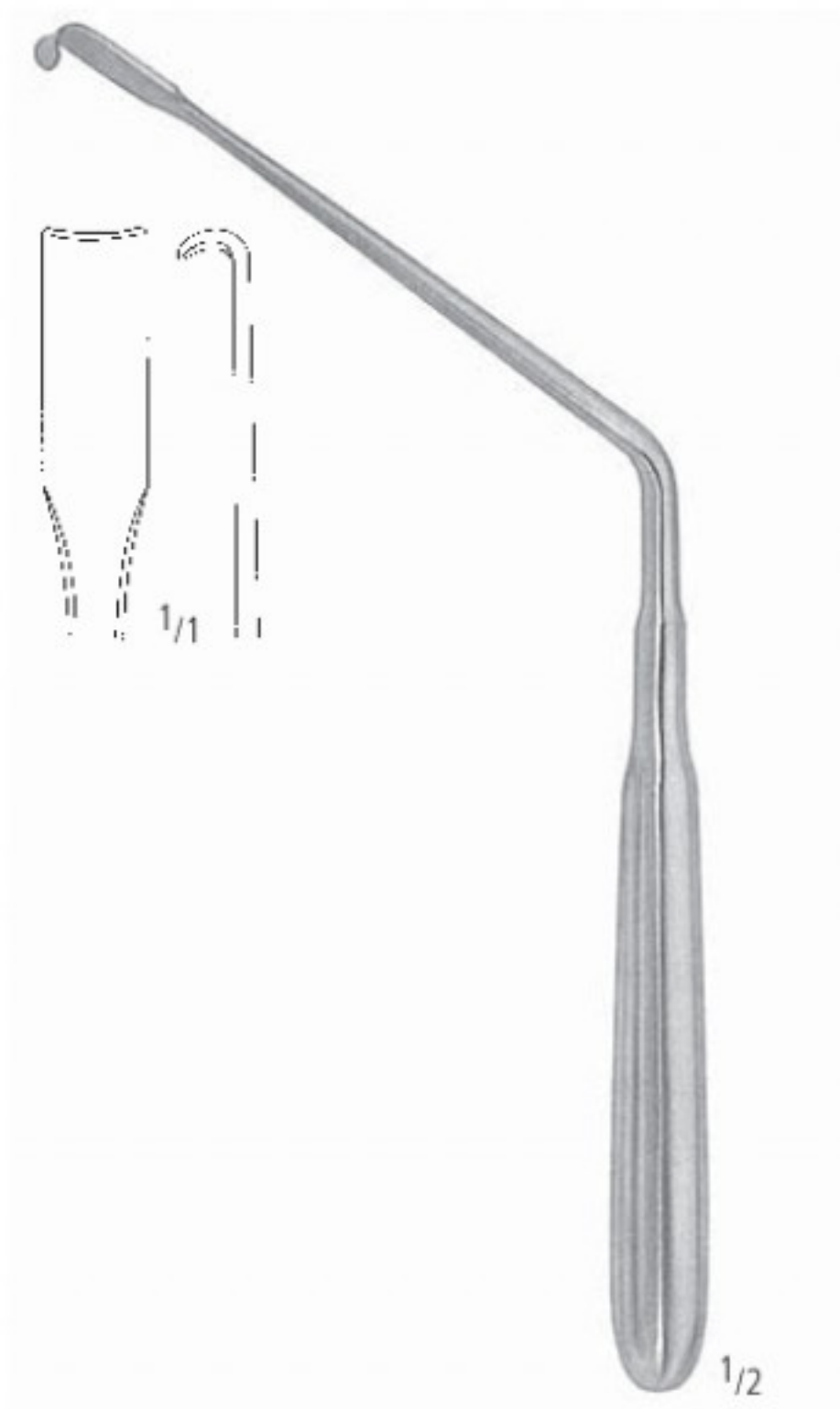

KS 611/20
 20,0 cm/8"

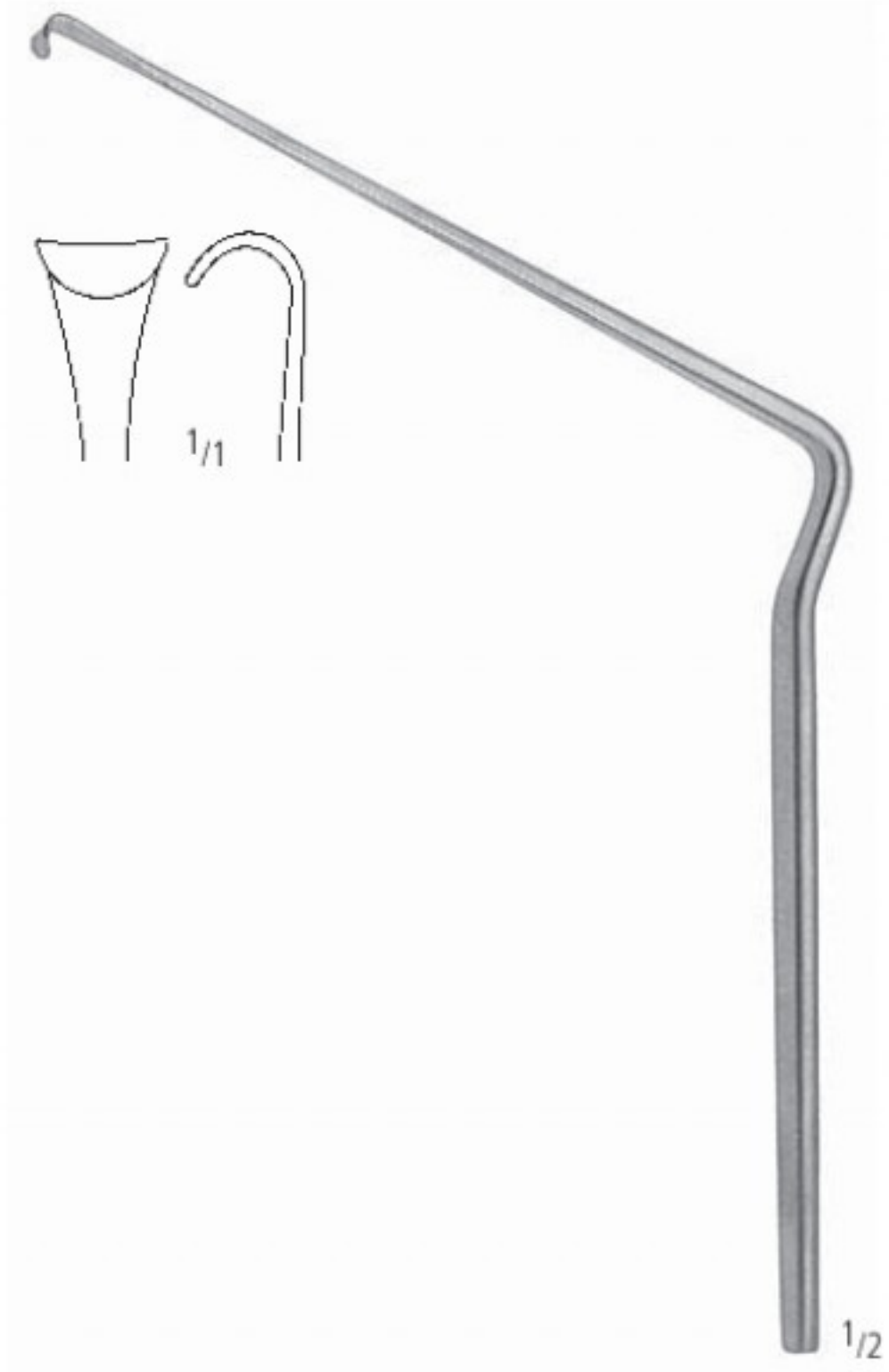

MARTIN
 KS 612/21
 21,0 cm/8 1/4"

Nervhaken
Nerve Hooks
Ganchos para nervios
Crochets à nerfs
Uncini per nervi

AA

AB

AC

AE

AK

AO

AR

KA

KS

XR

XT



GRONINGEN
26,0 cm/10¹/₄"

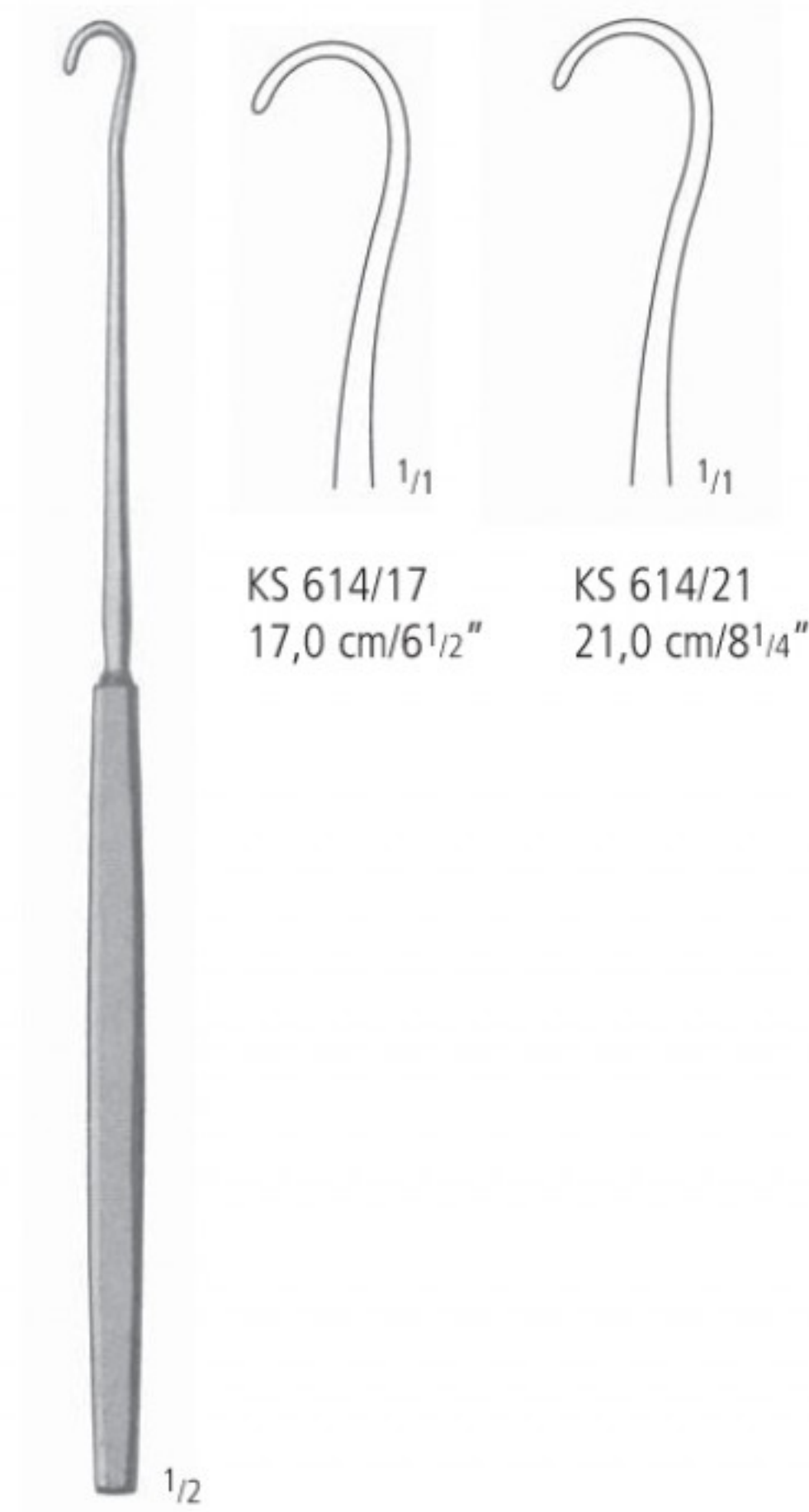

SMITHWICK



DANDY
KS 615/20
20,0 cm/8"

Nervhaken
Nerve Hooks
Ganchos para nervios
Crochets à nerfs
Uncini per nervi



1/1

KRAYENBÜHL
18,5 cm/7¹/₄"



1/1

KS 616/01



1/1

KS 616/02



1/1

KS 616/03



1/1

KS 616/04

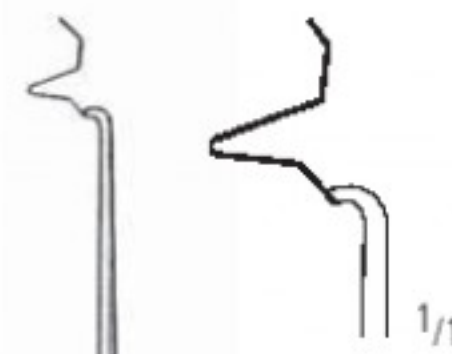

1/1



1/1

BIEMER
KS 617/16
16,0 cm/6¹/₄"



1/1

FISCH
18,5 cm/7¹/₄"



1/1

KS 618/01



1/1

KS 618/02

Durahaken
 Dura Hooks
 Ganchos para dura-madre
 Crochets à dure-mère
 Uncini per dura-madre

AA

AB

AC

AE

AK

AO

AR

KA

KS

XR

XT



CUSHING
 KS 620/14
 14,0 cm/5¹/₂"



ADSON
 KS 621/20
 20,0 cm/8"



GRAHAM
 KS 622/16
 16,5 cm/6¹/₂"

Dura Dissektoren
 Dura Dissectors
 Disecadores para dura-madre
 Dissecteurs à dure-mère
 Dissetori per dura-madre

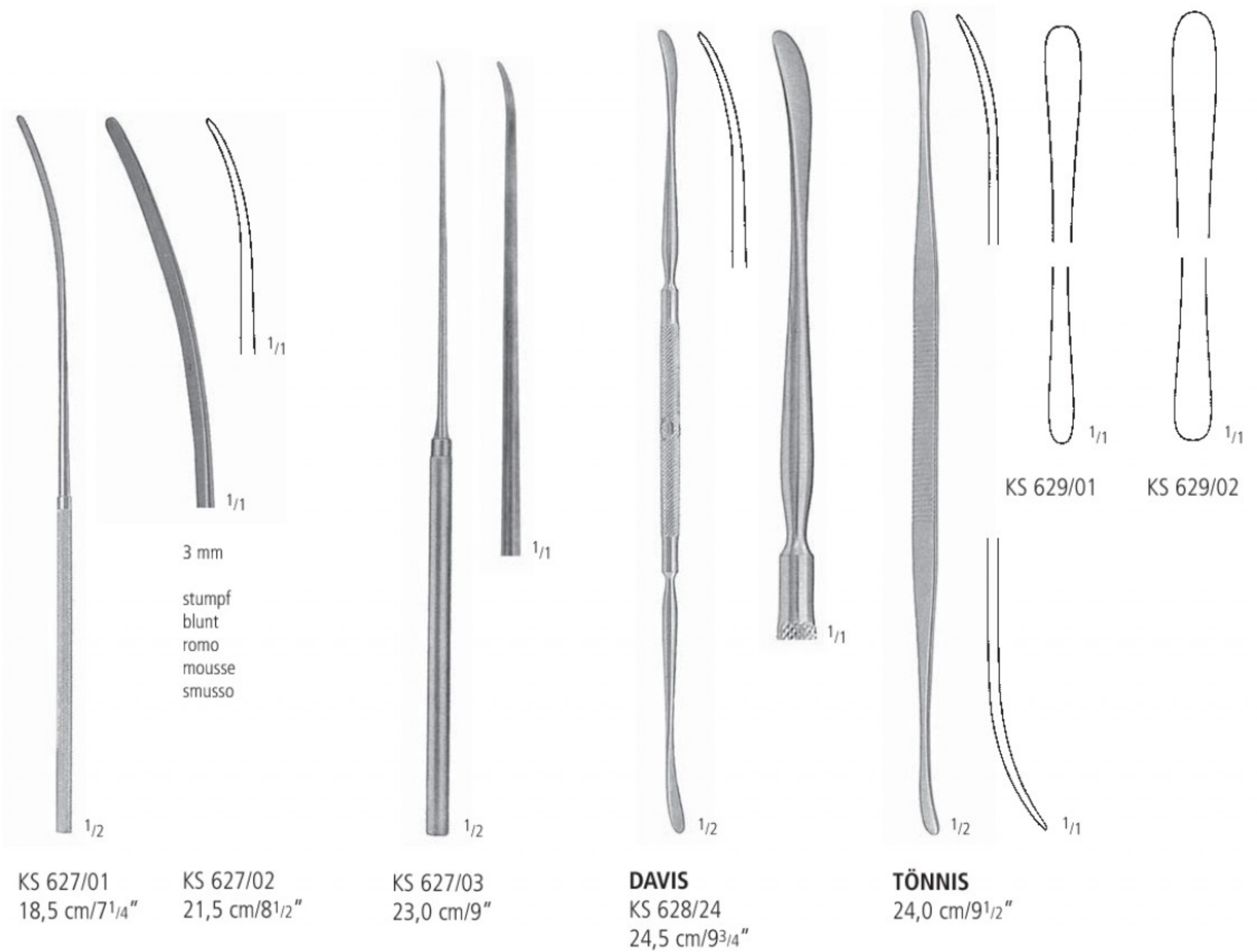

Dura Dissektoren
 Dura Dissectors
 Disecadores para dura-madre
 Dissecteurs à dure-mère
 Dissetori per dura-madre

AA

AB

AC

AE

AK

AO

AR

KA

KS

XR

XT



SACHS
 KS 631/21
 21,0 cm/8¹/₄"



SACHS
 KS 632/21
 21,0 cm/8¹/₄"



FRAZIER
 KS 633/01
 15,0 cm/6"



HOEN
 KS 633/02
 15,0 cm/6"



HOEN
 KS 633/03
 15,0 cm/6"

Dura Dissektoren
 Dura Dissectors
 Disecadores para dura-madre
 Dissecteurs à dure-mère
 Dissetori per dura-madre

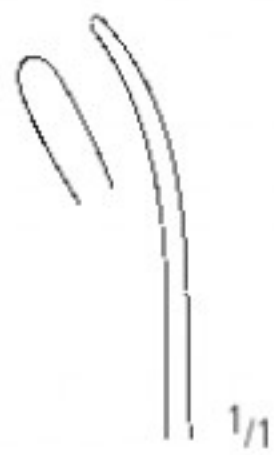

1/1

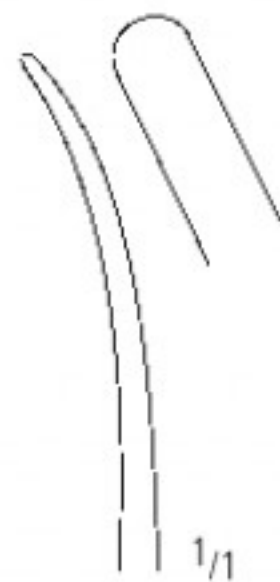

1/1

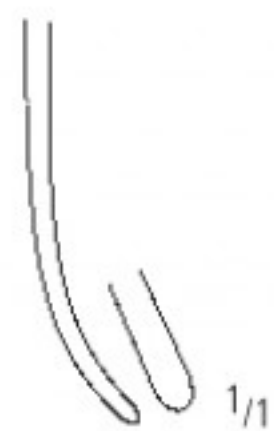

1/1

KS 634/18
 18,0 cm/7"

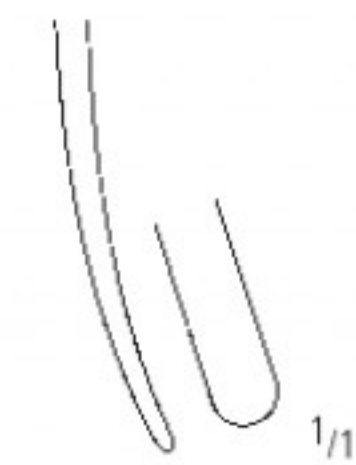

1/1

KS 635/20
 19,5 cm/7³/₄"

KS 634/24
 24,0 cm/9¹/₂"

KS 635/24
 24,0 cm/9¹/₂"

1/2

OLIVECRONA



1/1



1/1



1/1

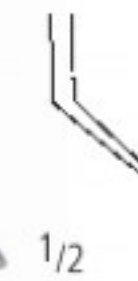

1/2



1/1

MILLIGAN
 KS 636/21
 21,0 cm/8¹/₄"

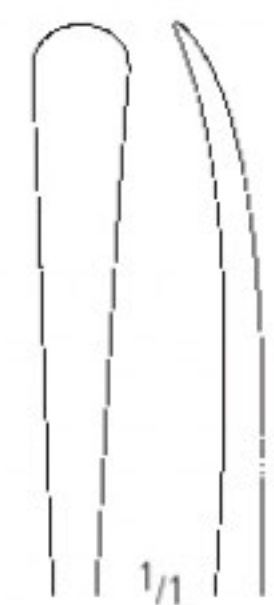

1/1



1/1

KS 637/22
 22,0 cm/8³/₄"

1/2

Dura Dissektoren
 Dura Dissectors
 Disecadores para dura-madre
 Dissecteurs à dure-mère
 Dissetori per dura-madre

AA

AB

AC

AE

AK

AO

AR

KA

KS

XR

XT



PENFIELD
 KS 638/01
 17,5 cm/7"



PENFIELD
 KS 638/02
 19,5 cm/7³/₄"



PENFIELD
 KS 638/03
 19,5 cm/7³/₄"



PENFIELD
 KS 638/04
 20,5 cm/8"



PENFIELD
 KS 638/05
 29,0 cm/11¹/₂"

Mikro-Instrumente
 Micro Instruments
 Instrumentos para microcirugía
 Instruments pour la chirurgie micro
 Strumenti per chirurgia micro



1/1 23,0 cm/9"



1/1 23,0 cm/9"

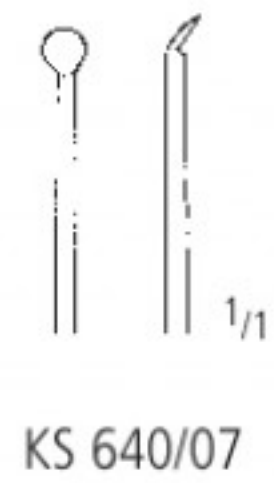
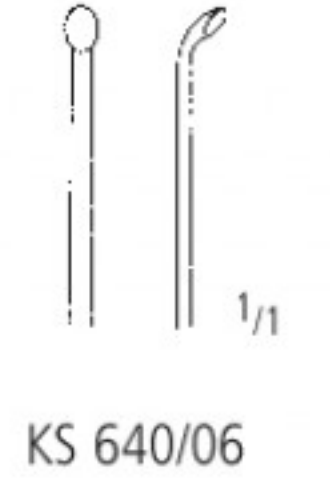
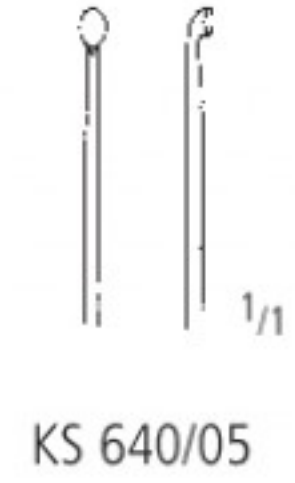
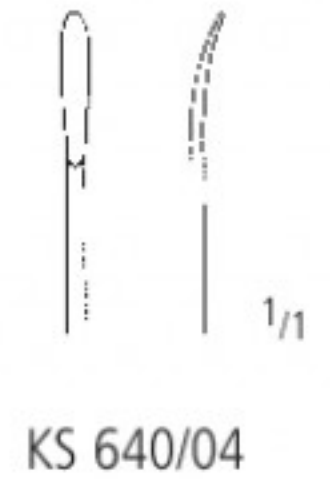
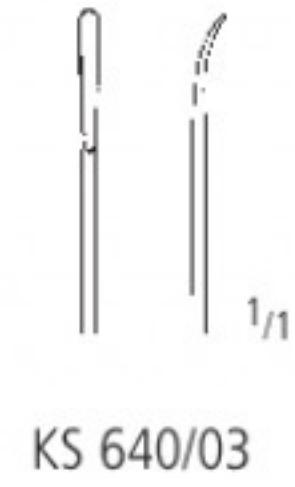

Mikro-Instrumente
 Micro Instruments
 Instrumentos para microcirugía
 Instruments pour la chirurgie micro
 Strumenti per chirurgia micro

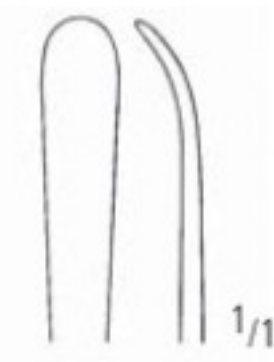

KS 642/01
 23,0 cm/9"

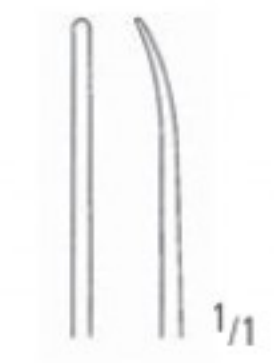

KS 642/02
 20,0 cm/8"

1/1 CASPAR

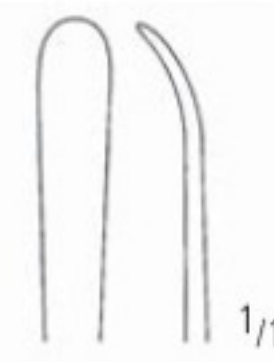

KS 642/03
 23,0 cm/9"

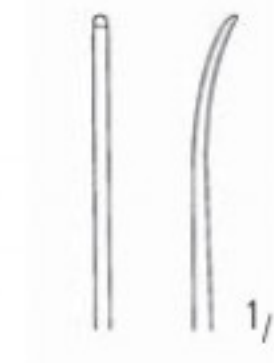

KS 642/05
 21,0 cm/8¹/₄"

1/1 CASPAR

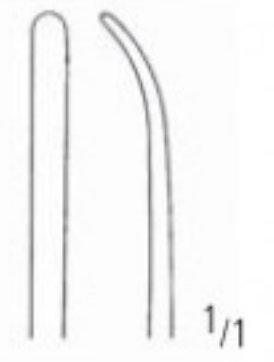

KS 642/04
 23,0 cm/9"

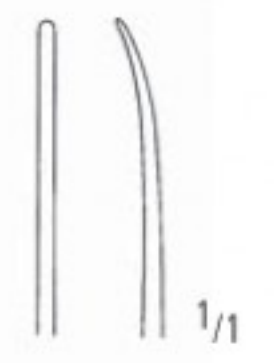

KS 642/06
 21,0 cm/8¹/₄"

AA
 AB
 AC
 AE
 AK
 AO
 AR
 KA
 KS
 XR
 XT

Mikro-Instrumente
 Micro Instruments
 Instrumentos para microcirugía
 Instruments pour la chirurgie micro
 Strumenti per chirurgia micro



KS 643/19
 18,5 cm/7¹/₄"



KS 643/22
 21,5 cm/8¹/₂"

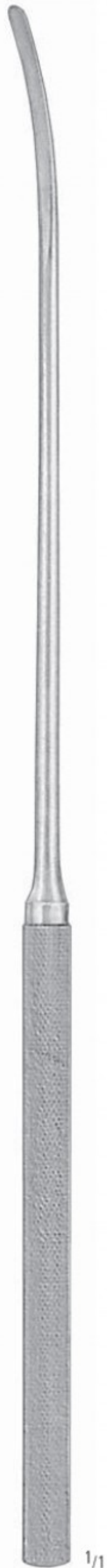

1/1



1/1 **CASPAR**



KS 644/01
 24,5 cm/9³/₄"

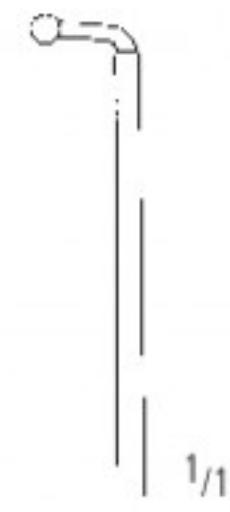

KS 644/02
 24,5 cm/9³/₄"

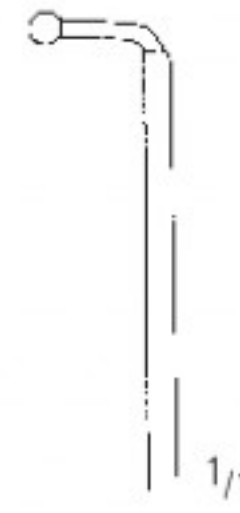

KS 644/03
 24,5 cm/9³/₄"

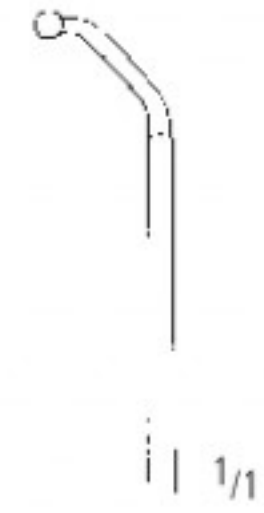

KS 644/04
 24,5 cm/9³/₄"

Mikro-Instrumente
 Micro Instruments
 Instrumentos para microcirugía
 Instruments pour la chirurgie micro
 Strumenti per chirurgia micro

AA

AB

AC

AE

AK

AO

AR

KA

KS

XR

XT



1/1 SAMII

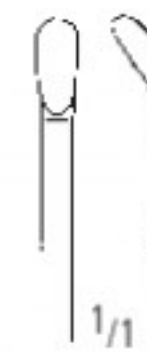
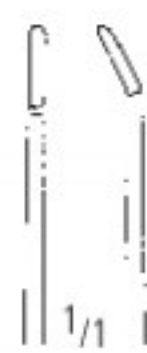

20,0 cm/8"	KS 647/01	KS 647/02	KS 647/03	KS 647/04
23,0 cm/9 ¹ / ₄ "	KS 648/01	KS 648/02	KS 648/03	KS 648/04



20,0 cm/8"	KS 647/05	KS 647/06	KS 647/07	KS 647/08
23,0 cm/9 ¹ / ₄ "	KS 648/05	KS 648/06	KS 648/07	KS 648/08

Mikro-Instrumente
 Micro Instruments
 Instrumentos para microcirugía
 Instruments pour la chirurgie micro
 Strumenti per chirurgia micro



18,5 cm/7¹/₄"

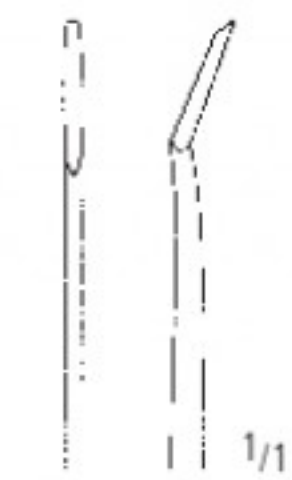

KS 650/01

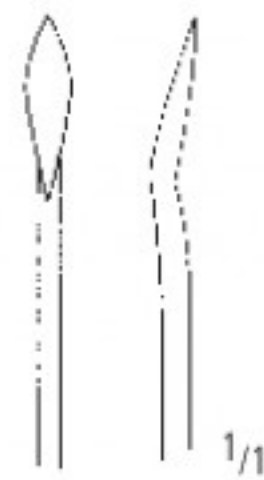

KS 650/02

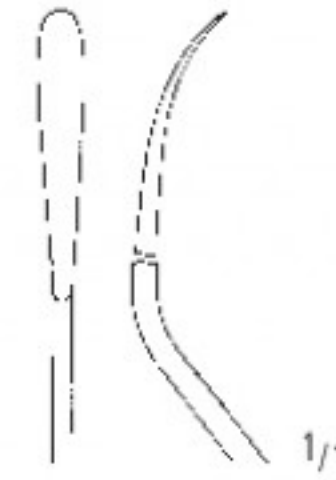

KS 650/06

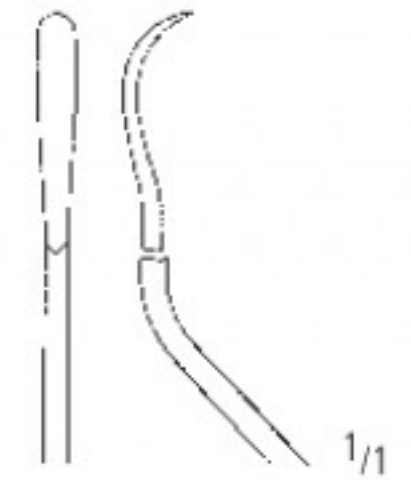

KS 650/07

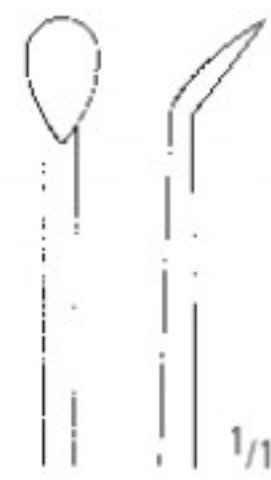

KS 650/03



KS 650/04

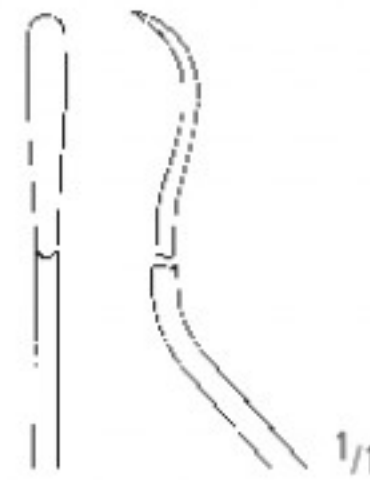

KS 650/08

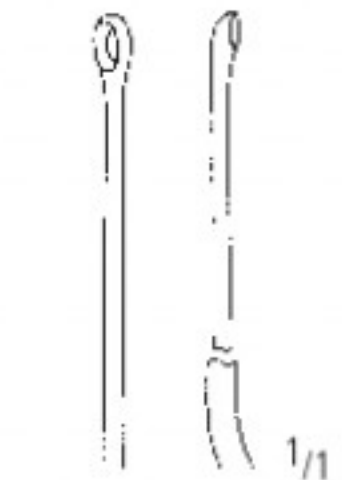

KS 650/09



KS 650/05

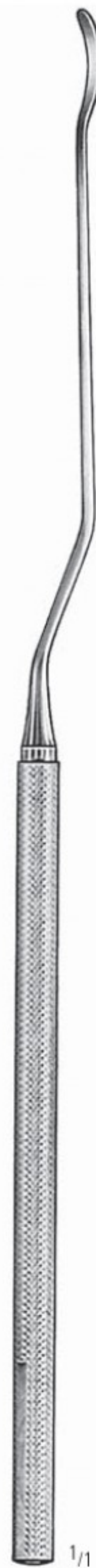

18,5 cm/7¹/₄"

Mikro-Instrumente
 Micro Instruments
 Instrumentos para microcirugía
 Instruments pour la chirurgie micro
 Strumenti per chirurgia micro

AA

AB

AC

AE

AK

AO

AR

KA

KS

XR

XT

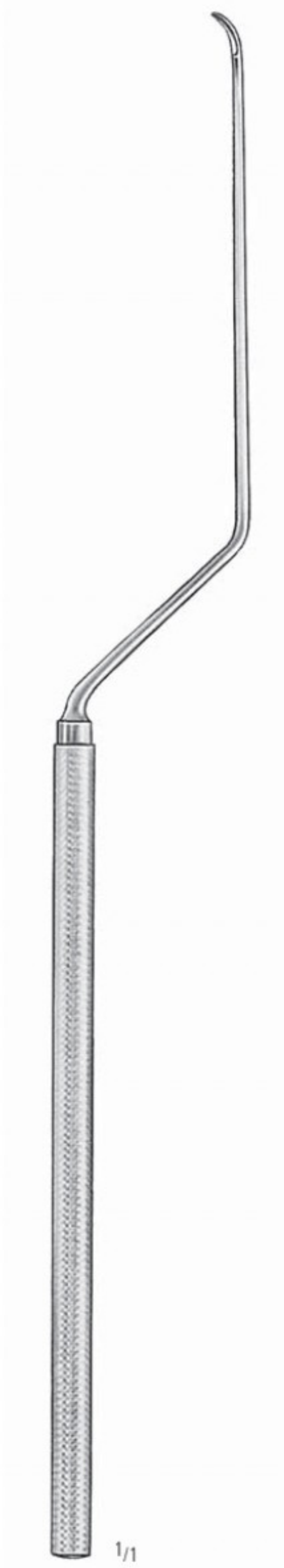

KOOS
 19,0 cm/7¹/₂"



KS 652/01



KS 652/02



KS 652/03



KS 652/04



KS 652/05

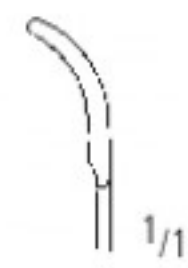

KS 652/06

Mikro-Instrumente
 Micro Instruments
 Instrumentos para microcirugía
 Instruments pour la chirurgie micro
 Strumenti per chirurgia micro

Schneide seitlich
 Lateral cutting edge
 Filo de corte lateral
 Trachant latéral
 Taglio laterale



KRAUS
 KS 653/19
 19,0 cm/7¹/₂"



KS 654/01
 19,0 cm/7¹/₂"



KS 654/02
 19,0 cm/7¹/₂"

Mikro-Instrumente
 Micro Instruments
 Instrumentos para microcirugía
 Instruments pour la chirurgie micro
 Strumenti per chirurgia micro



JACOBSON
 19,0 cm/7¹/₂"



JACOBSON
 18,5 cm/7¹/₄"



CASPAR
 KS 659/23
 23,0 cm/9"

AA
 AB
 AC
 AE
 AK
 AO
 AR
 KA
 KS
 XR
 XT

Mikro-Instrumente
 Micro Instruments
 Instrumentos para microcirugía
 Instruments pour la chirurgie micro
 Strumenti per chirurgia micro



OKONEK
^{1/1} 23,0 cm/9"

3 mm



KS 660/03

4 mm



KS 660/04

5 mm



KS 660/05

8 mm



KS 660/08



^{1/1} 19,0 cm/7 1/2"



KS 665/01

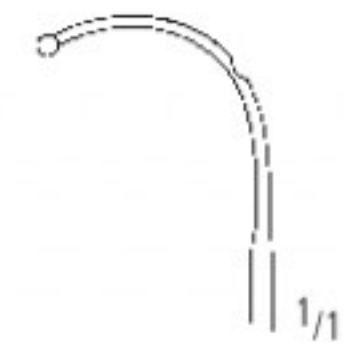

KS 665/02



KS 665/03



KS 665/04

Mikro-Instrumente
 Micro Instruments
 Instrumentos para microcirugía
 Instruments pour la chirurgie micro
 Strumenti per chirurgia micro

AA

AB

AC

AE

AK

AO

AR

KA

KS

XR

XT

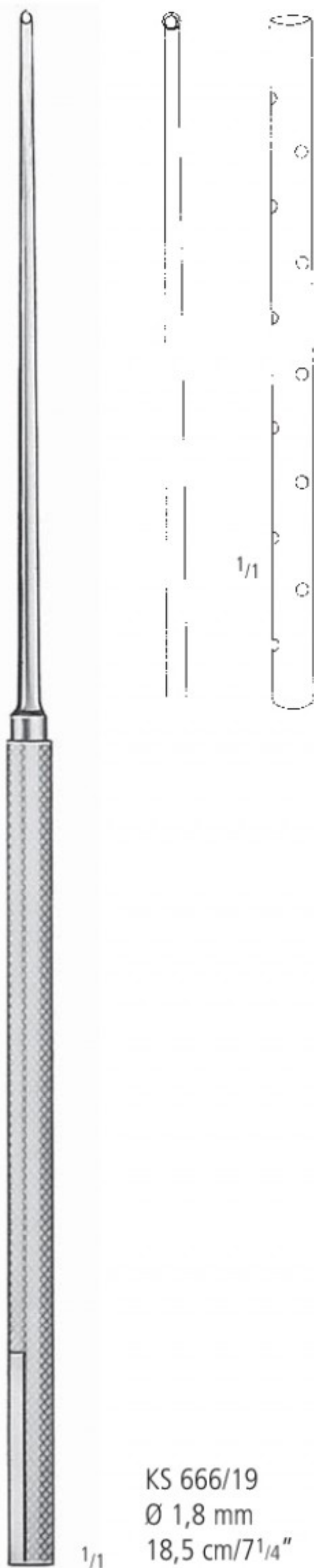

KS 666/19
 Ø 1,8 mm
 18,5 cm/7¹/₄"

1/1



1/1 12,5 cm/5"



KS 670/00

1/1



KS 670/01

1/1



KS 670/02

1/1

Rhoton Mikro Dissektoren
 Rhoton Micro Dissectors
 Rhoton micro disecadores
 Rhoton micro dissecteurs
 Rhoton micro dissetori



KS 680/01



KS 680/02



KS 680/03



KS 680/04

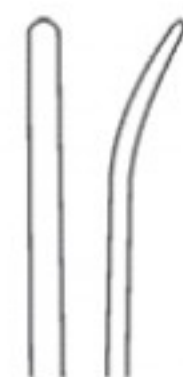

KS 680/05



KS 680/06



KS 680/07



KS 680/08



KS 680/09

RHOTON

Rhoton Mikro Dissektoren
 Rhoton Micro Dissectors
 Rhoton micro disecadores
 Rhoton micro dissecteurs
 Rhoton micro dissetori



RHOTON



KS 680/10



KS 680/11



KS 680/12



KS 680/13



KS 680/14



KS 680/15

KS 680/00 = KS 680/01 - KS 680/15

Set komplett, 15 Dissektoren
 Set complete, 15 dissectors
 Set completo, 15 disecadores
 Jeu complet, 15 dissecteurs
 Set completo, 15 dissetori

AA
 AB
 AC
 AE
 AK
 AO
 AR
 KA
 XR
 XT

KS

Mikro-Instrumente
 Micro Instruments
 Instrumentos para microcirugía
 Instruments pour la chirurgie micro
 Strumenti per la chirurgia micro

8,0 cm/3 1/4"



↑ KS 690/10

rechts
 right
 derecha
 à droite
 destra → KS 690/30

links
 left
 izquierda
 à gauche
 sinistra ← KS 690/40

1/1

BELLUCCI

16,5 cm/6 1/2"



2/3

FAHLBUSCH
 KS 693/17

Mikro-Instrumente
 Micro Instruments
 Instrumentos para microcirugía
 Instruments pour la chirurgie micro
 Strumenti per la chirurgia micro

AA

AB

AC

AE

AK

AO

AR

KA

KS

XR

XT

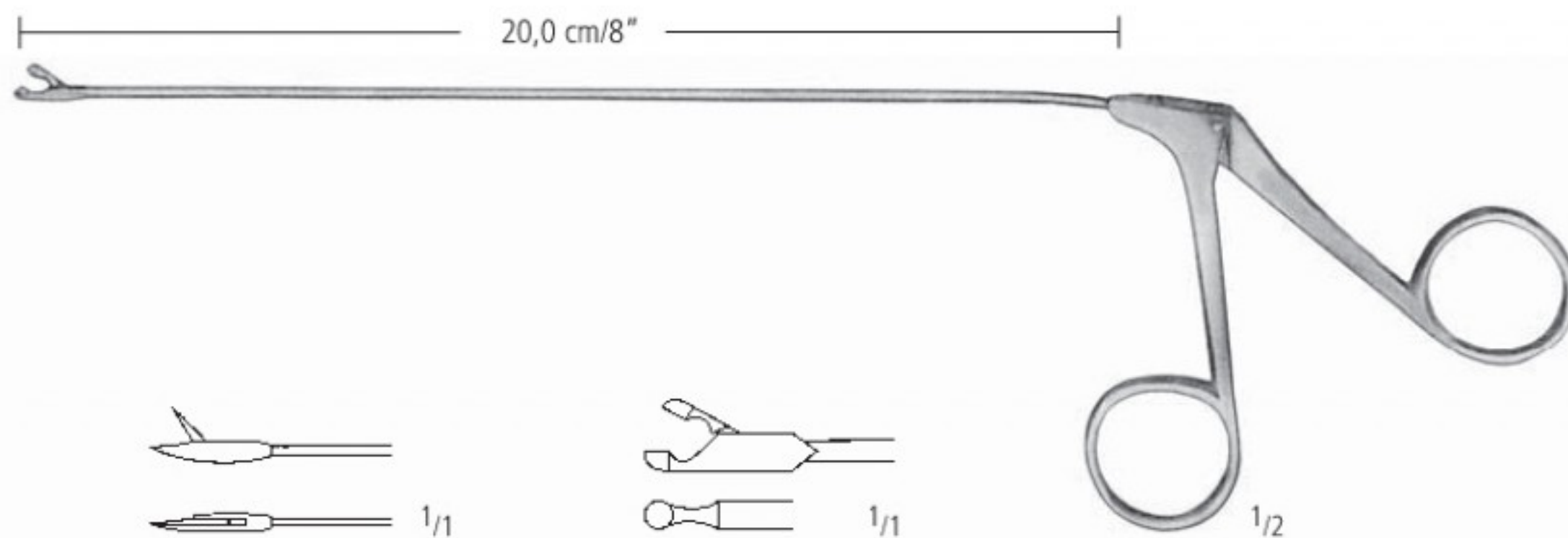

2 mm
KS 694/00

2 mm
KS 695/00

NICOLA

↑ 30° KS 694/10

KS 695/10

rechts
right
derecha
à droite
destra

→ KS 694/30

KS 695/30

links
left
izquierda
à gauche
sinistra

← KS 694/40

KS 695/40

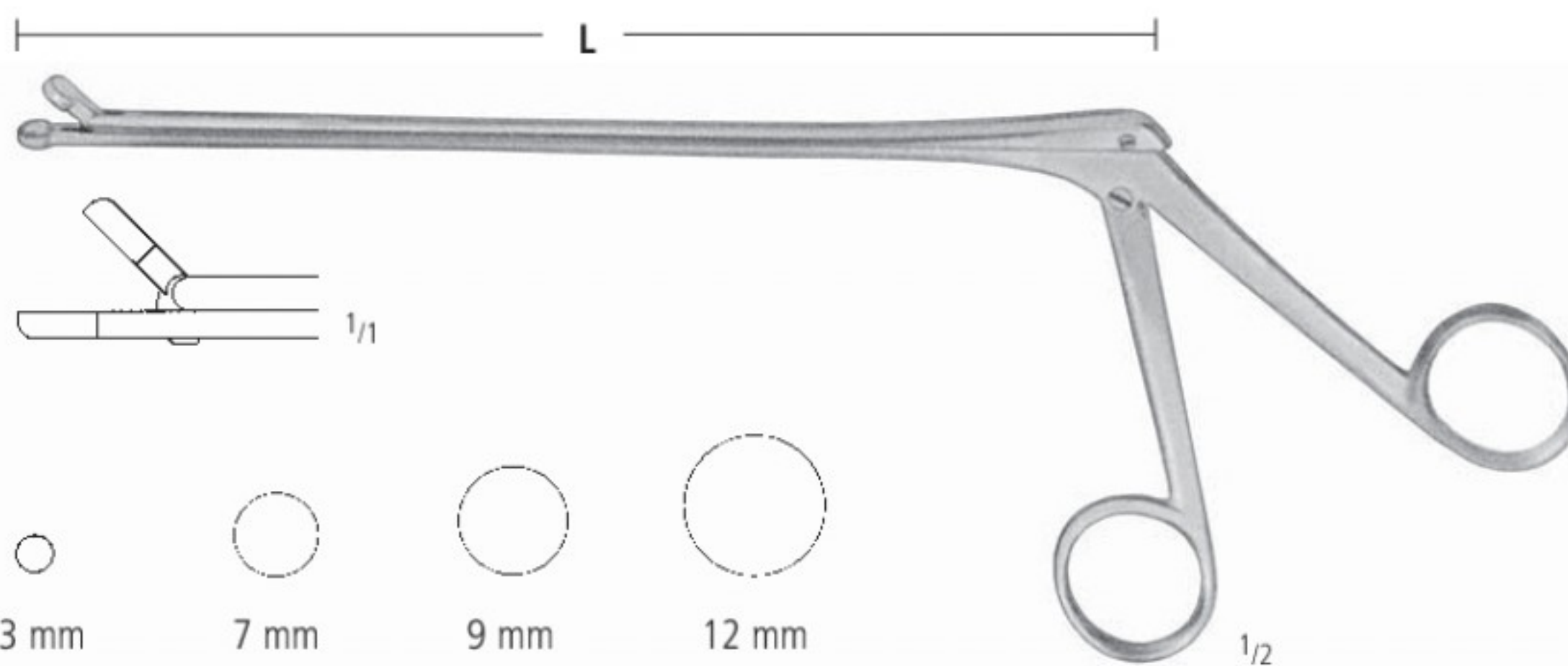

3 mm

7 mm

9 mm

12 mm

1/2

L = 14,0 cm/5 1/2"
 Ø 3 mm KS 696/03
 Ø 7 mm KS 696/07
 Ø 9 mm KS 696/09
 Ø 12 mm KS 696/12

L = 18,0 cm/7"
 KS 697/03
 KS 697/07
 KS 697/09
 KS 697/12

Laminektomie-Stanzen
 Laminectomy Punches
 Pinzas cortantes para discos intervertebrales
 Pincas emporte-pièces pour lames intervertébrales
 Pinze taglianti per dischi intervertebrali



KERRISON

Also available in
TITANIUM

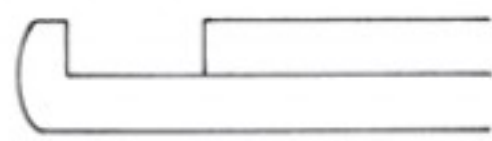

1 mm	15,0 cm/6"	18,0 cm/7"	20,0 cm/8"
2 mm	KS 700/02	KS 701/02	KS 702/02
3 mm	KS 700/03	KS 701/03	KS 702/03
5 mm	KS 700/05	KS 701/05	KS 702/05

Also available in
TITANIUM

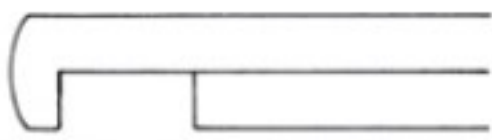

1 mm	15,0 cm/6"	18,0 cm/7"	20,0 cm/8"
2 mm	KS 706/02	KS 707/02	KS 708/02
3 mm	KS 706/03	KS 707/03	KS 708/03
5 mm	KS 706/05	KS 707/05	KS 708/05

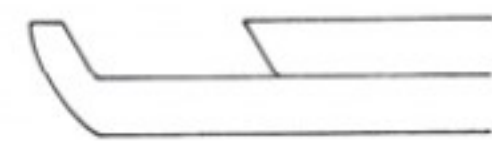

1 mm	15,0 cm/6"	18,0 cm/7"	20,0 cm/8"
2 mm	KS 712/02	KS 713/02	KS 714/02
3 mm	KS 712/03	KS 713/03	KS 714/03
5 mm	KS 712/05	KS 713/05	KS 714/05

Laminektomie-Stanzen
 Laminectomy Punches
 Pinzas cortantes para discos intervertebrales
 Pincas emporte-pièces pour lames intervertébrales
 Pinze taglianti per dischi intervertebrali

AA

AB

AC

AE

AK

AO

AR

KA

KS

XR

XT



easyClean[®]

ZERLEGBAR
 DETACHABLE
 DESMONTABLE
 DEMONTABLE
 SMONTABILE

	1 mm	18,0 cm/7"	20,0 cm/8"
	2 mm	KS 701/12	KS 702/12
	3 mm	KS 701/13	KS 702/13
	4 mm	KS 701/14	KS 702/14
	5 mm	KS 701/15	KS 702/15
	2 mm	18,0 cm/7"	20,0 cm/8"
	3 mm	KS 707/13	KS 708/13
	4 mm	KS 707/14	KS 708/14
	5 mm	KS 707/15	KS 708/15
	2 mm	KS 707/12	KS 708/12
	1 mm	18,0 cm/7"	20,0 cm/8"
	2 mm	KS 713/12	KS 714/12
	3 mm	KS 713/13	KS 714/13
	4 mm	KS 713/14	KS 714/14
	5 mm	KS 713/15	KS 714/15

Laminektomie-Stanzen
 Laminectomy Punches
 Pinzas cortantes para discos intervertebrales
 Pincas emporte-pièces pour lames intervertébrales
 Pinze taglianti per dischi intervertebrali

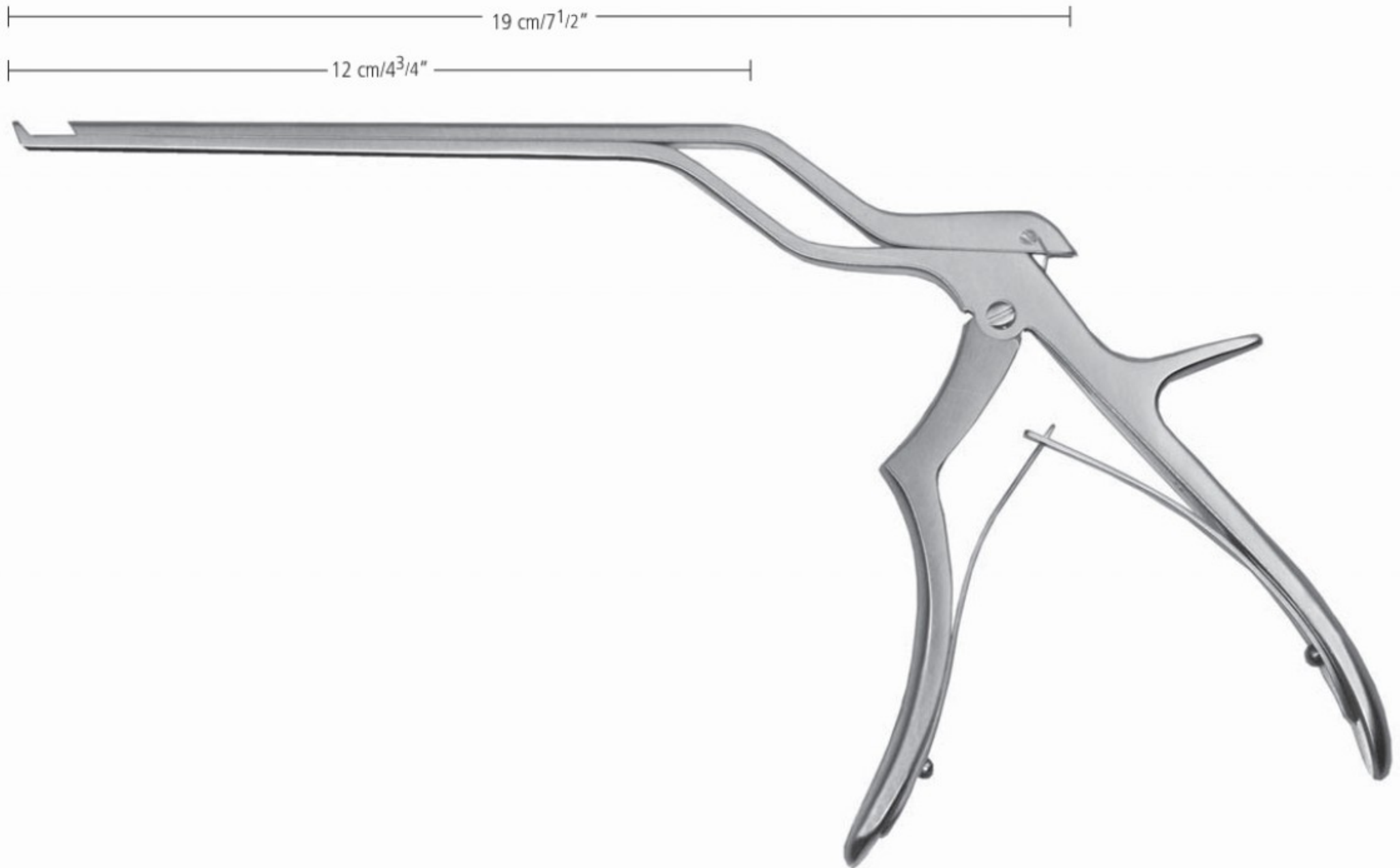

KERRISON-BAJONETT



2 mm
 3 mm
 4 mm
 5 mm

12,0 cm/4³/₄"

KS 715/12
 KS 715/13
 KS 715/14
 KS 715/15

Laminektomie-Stanzen
 Laminectomy Punches
 Pinzas cortantes para discos intervertebrales
 Pincas emporte-pièces pour lames intervertébrales
 Pinze taglianti per dischi intervertebrali



großer Griff
 large handle
 mango grande
 branche grande
 impugnatura grande

KERRISON-COLCLOUGH

Also available in
TITANIUM

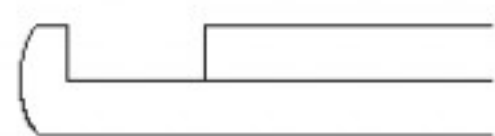

2 mm
 3 mm
 4 mm
 5 mm

15,0 cm/6"
 KS 720/02
 KS 720/03
 KS 720/04
 KS 720/05

18,0 cm/7"
 KS 721/02
 KS 721/03
 KS 721/04
 KS 721/05

20,0 cm/8"
 KS 722/02
 KS 722/03
 KS 722/04
 KS 722/05

30,0 cm/12"
 KS 725/02
 KS 725/03
 KS 725/04
 KS 725/05

KS

Also available in
TITANIUM

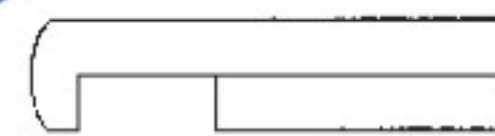

2 mm
 3 mm
 4 mm
 5 mm

15,0 cm/6"
 KS 726/02
 KS 726/03
 KS 726/04
 KS 726/05

18,0 cm/7"
 KS 727/02
 KS 727/03
 KS 727/04
 KS 727/05

20,0 cm/8"
 KS 728/02
 KS 728/03
 KS 728/04
 KS 728/05

30,0 cm/12"
 KS 731/02
 KS 731/03
 KS 731/04
 KS 731/05

XT



2 mm
 3 mm
 4 mm
 5 mm

15,0 cm/6"
 KS 732/02
 KS 732/03
 KS 732/04
 KS 732/05

18,0 cm/7"
 KS 733/02
 KS 733/03
 KS 733/04
 KS 733/05

20,0 cm/8"
 KS 734/02
 KS 734/03
 KS 734/04
 KS 734/05

30,0 cm/12"
 KS 737/02
 KS 737/03
 KS 737/04
 KS 737/05

XR

Laminektomie-Zangen
 Laminectomy Rongeurs
 Pinzas cortantes para laminectomía
 Pincas emporte-pièces à laminectomie
 Pinze taglianti per laminectomia



Also available in
TITANIUM

CUSHING
LOVE-GRUENWALD
SPURLING



CUSHING
 2 x 10 mm



13,0 cm/5"	KS 742/00
15,0 cm/6"	KS 742/04
18,0 cm/7"	KS 742/08
20,0 cm/8"	KS 742/12
25,0 cm/10"	KS 742/16
30,0 cm/12"	KS 742/20

KS 742/01
KS 742/05
KS 742/09
KS 742/13
KS 742/17
KS 742/21

KS 742/03
KS 742/07
KS 742/11
KS 742/15
KS 742/19
KS 742/23

LOVE-GRUENWALD
 3 x 10 mm



13,0 cm/5"	KS 743/00
15,0 cm/6"	KS 743/04
18,0 cm/7"	KS 743/08
20,0 cm/8"	KS 743/12
25,0 cm/10"	KS 743/16
30,0 cm/12"	KS 743/20

KS 743/01
KS 743/05
KS 743/09
KS 743/13
KS 743/17
KS 743/21

KS 743/03
KS 743/07
KS 743/11
KS 743/15
KS 743/19
KS 743/23

SPURLING
 4 x 10 mm



13,0 cm/5"	KS 744/00
15,0 cm/6"	KS 744/04
18,0 cm/7"	KS 744/08
20,0 cm/8"	KS 744/12
25,0 cm/10"	KS 744/16
30,0 cm/12"	KS 744/20

KS 744/01
KS 744/05
KS 744/09
KS 744/13
KS 744/17
KS 744/21

KS 744/03
KS 744/07
KS 744/11
KS 744/15
KS 744/19
KS 744/23

Laminektomie-Zangen
 Laminectomy Rongeurs
 Pinzas cortantes para laminectomía
 Pincas emporte-pièces à laminectomie
 Pinze taglianti per laminectomia

AA

AB

AC

AE

AK

AO

AR

KA

KS

XR

XT



2 x 3 mm
 KS 750/03



2 x 5 mm
 KS 750/05

SELVERSTONE

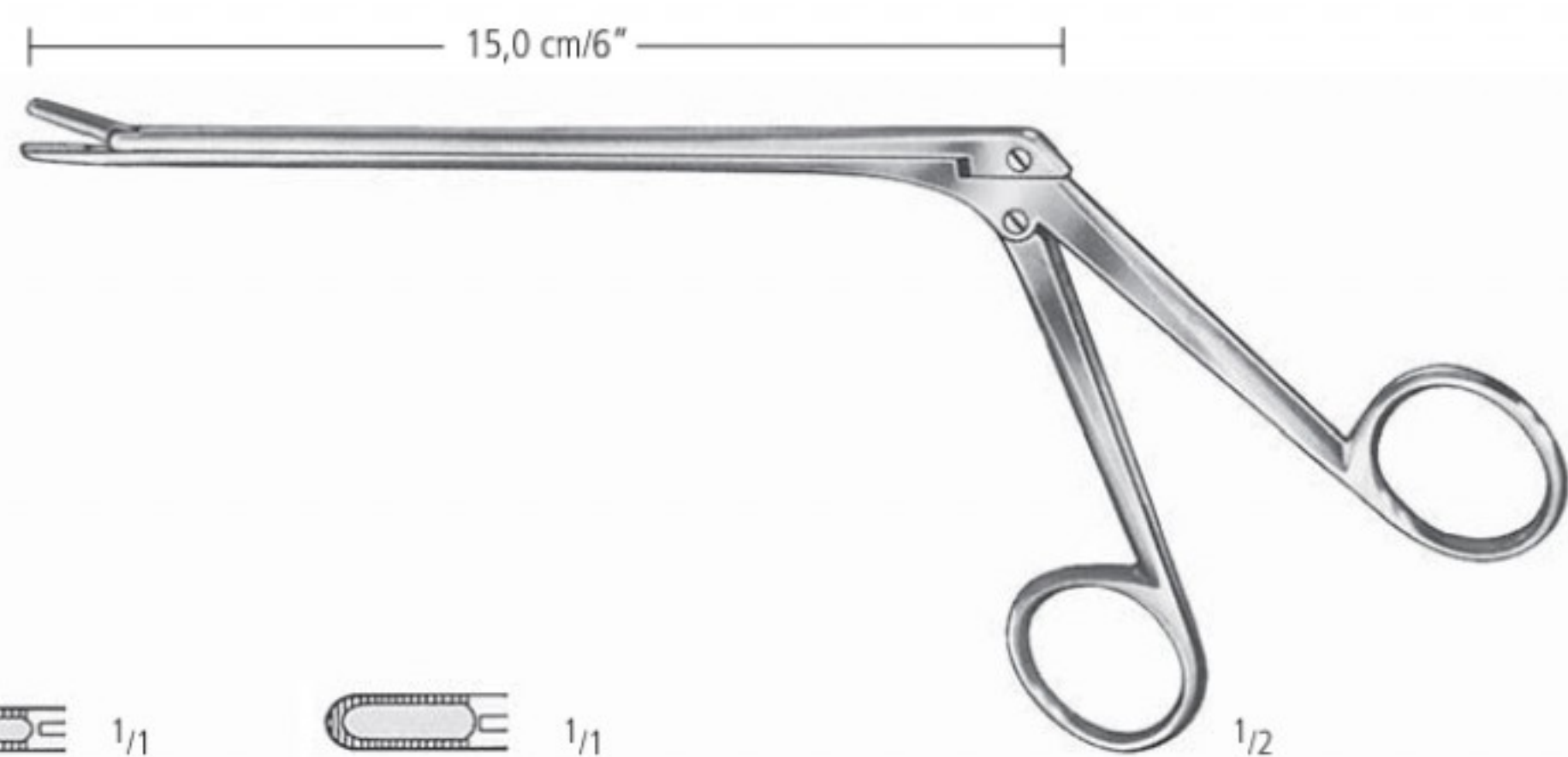

2 x 10 mm
 KS 752/02

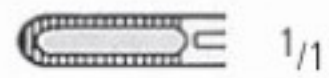

3 x 10 mm
 KS 752/03

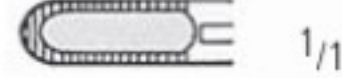

4 x 10 mm
 KS 752/04

SCHLESINGER

Laminektomie-Zangen
 Laminectomy Rongeurs
 Pinzas cortantes para laminectomía
 Pincas emporte-pièces à laminectomie
 Pinze taglianti per laminectomia



2 x 10 mm
KS 754/02



3 x 10 mm
KS 754/03



4 x 10 mm
KS 754/04

CASPAR



6 x 10 mm

CLOWARD

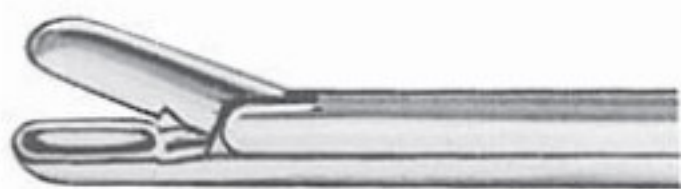

KS 756/01

1/1



KS 756/02

1/1







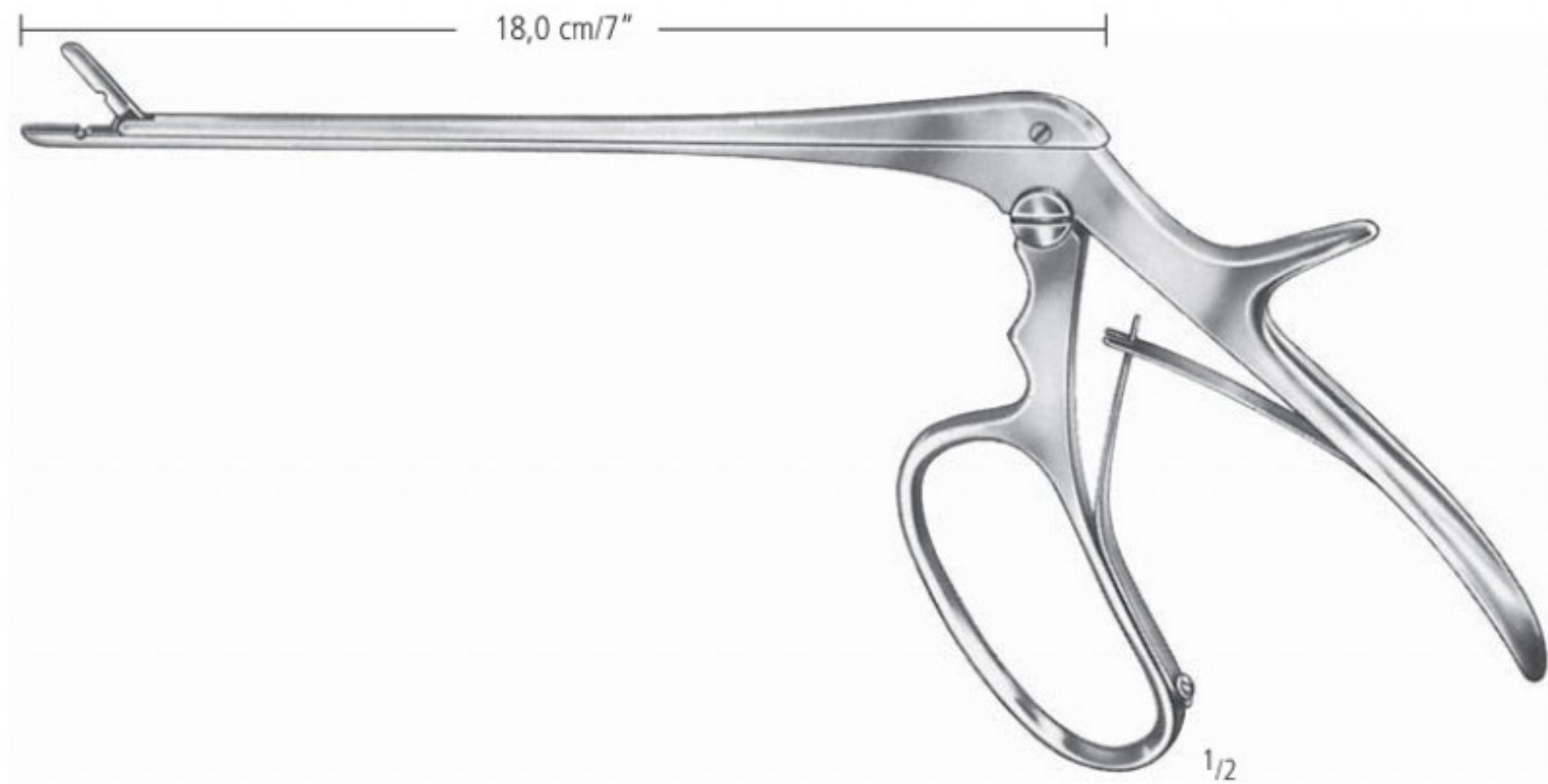

KS 756/03

1/1

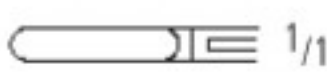
Laminektomie-Zangen
 Laminectomy Rongeurs
 Pinzas cortantes para laminectomía
 Pincas emporte-pièces à laminectomie
 Pinze taglianti per laminectomia

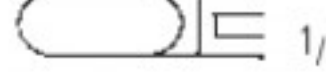

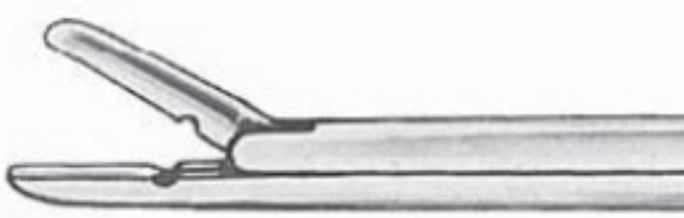
FERRIS-SMITH-CUSHING

	 1/1	 1/1	 1/1	 1/1
	2 x 10 mm	3 x 10 mm	4 x 10 mm	6 x 12 mm
 1/1	KS 762/00	KS 763/00	KS 764/00	KS 766/00
 1/1	KS 762/01	KS 763/01	KS 764/01	KS 766/01
 1/1	KS 762/03	KS 763/03	KS 764/03	KS 766/03

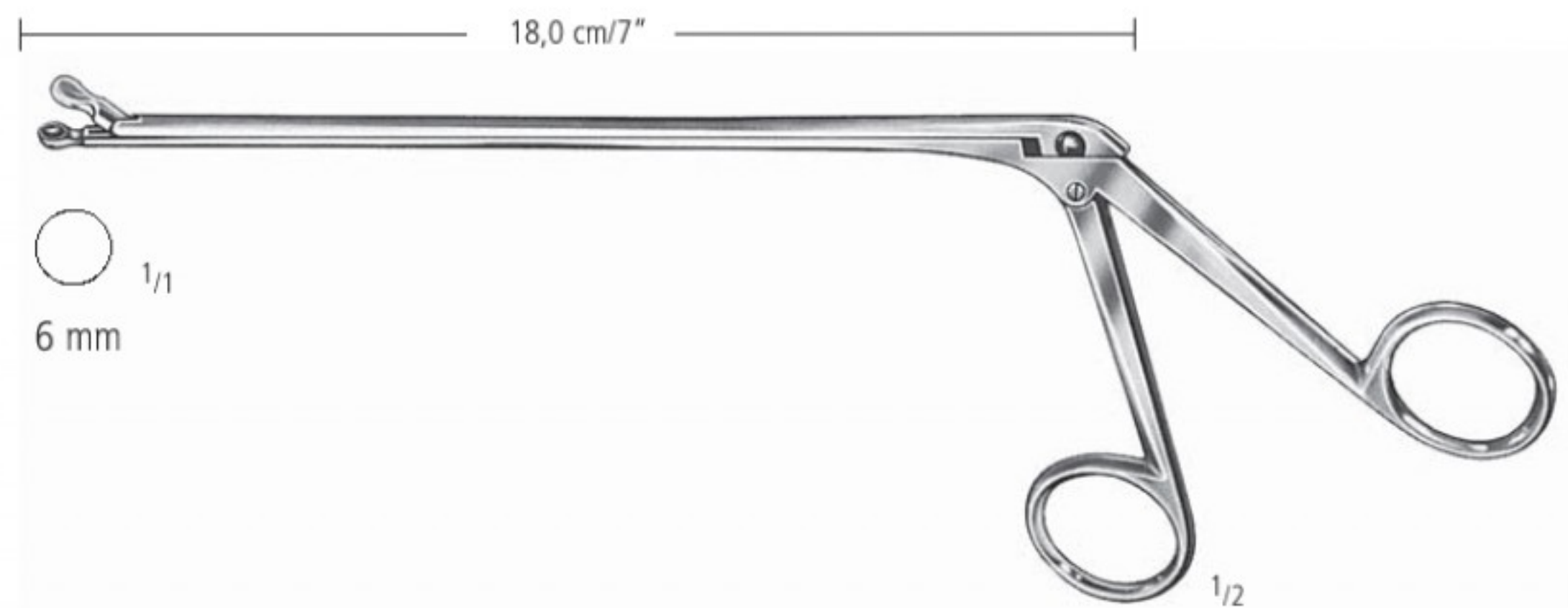

OLDBERG
 KS 770/00

Laminektomie-Stanzen
 Laminectomy Punches
 Pinzas cortantes para discos intervertebrales
 Pincas emporte-pièces pour lames intervertébrales
 Pinze taglianti per dischi intervertebrali

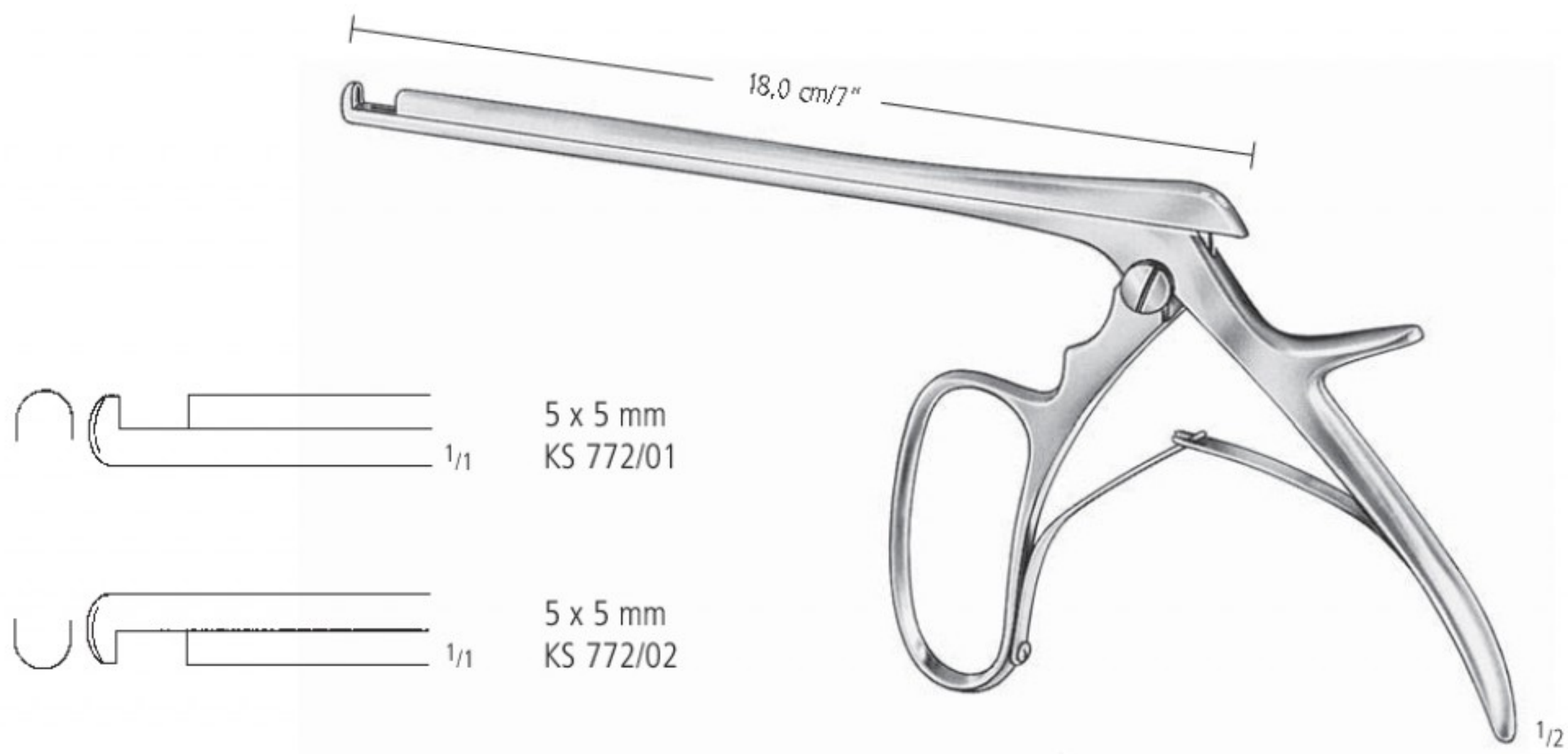

FERRIS-SMITH

Laminektomie-Stanzen
 Laminectomy Punches
 Pinzas cortantes para discos intervertebrales
 Pincas emporte-pièces pour lames intervertébrales
 Pinze taglianti per dischi intervertebrali

AA

AB

AC

AE

AK

AO

AR

KA

KS

XR

XT

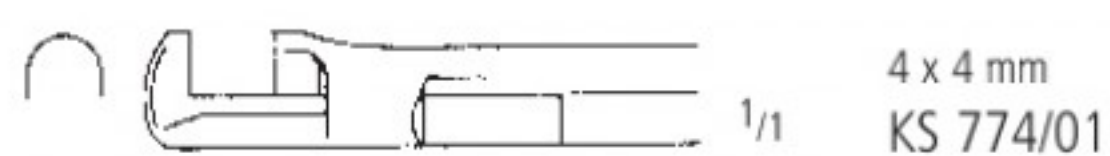

4 x 4 mm
KS 774/01



4 x 4 mm
KS 774/02



3,5 x 3,5 mm
KS 774/03

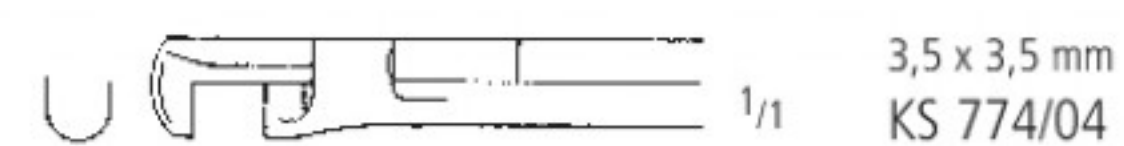

3,5 x 3,5 mm
KS 774/04



HAJEK-KOFFLER



HAJEK-KOFFLER
KS 774/16

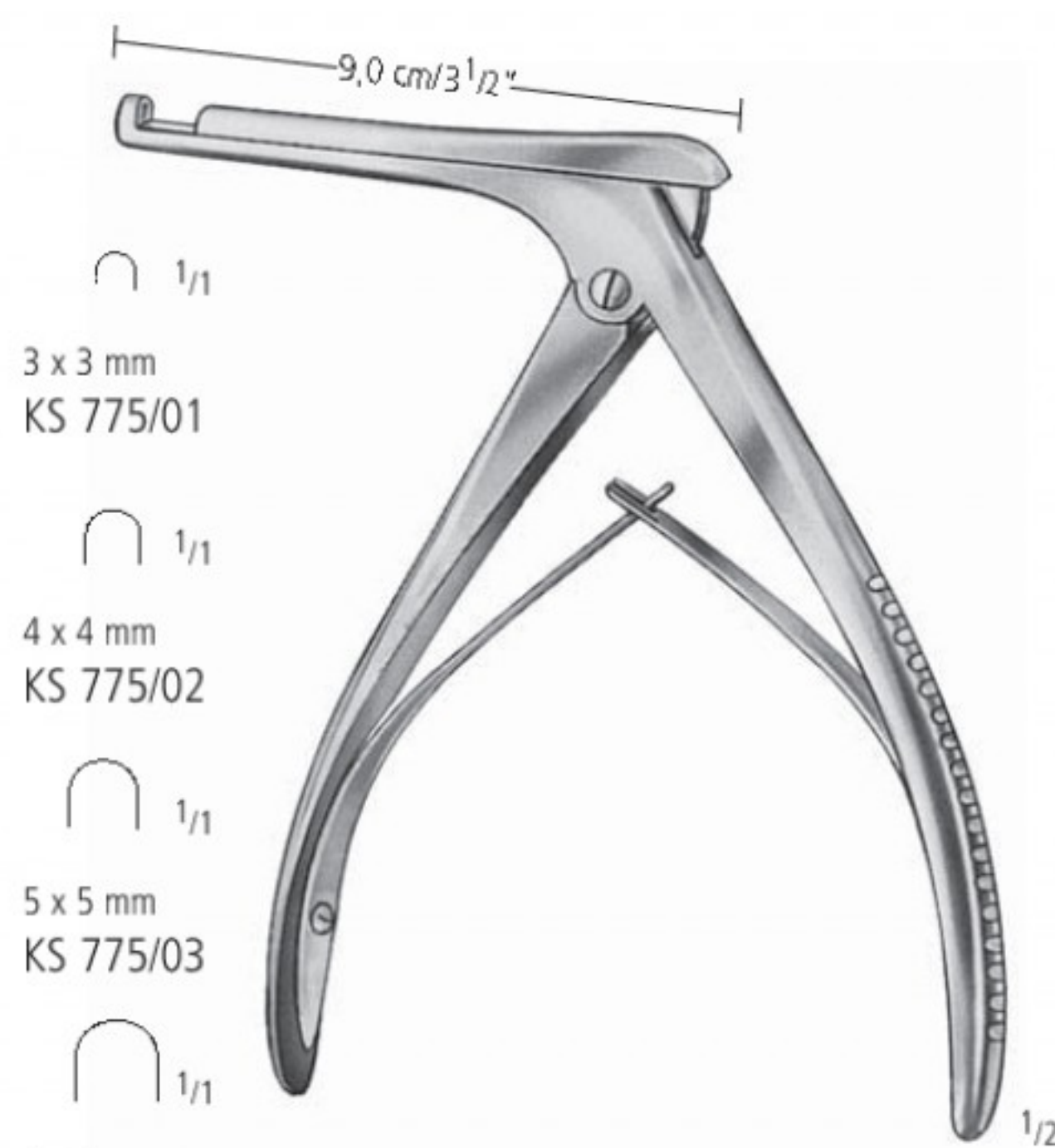

KERRISON

3 x 3 mm
KS 775/01

4 x 4 mm
KS 775/02

5 x 5 mm
KS 775/03

6 x 6 mm
KS 775/04

Laminektomie-Stanzen
 Laminectomy Punches
 Pinzas cortantes para discos intervertebrales
 Pincas emporte-pièces pour lames intervertébrales
 Pinze taglianti per dischi intervertebrali

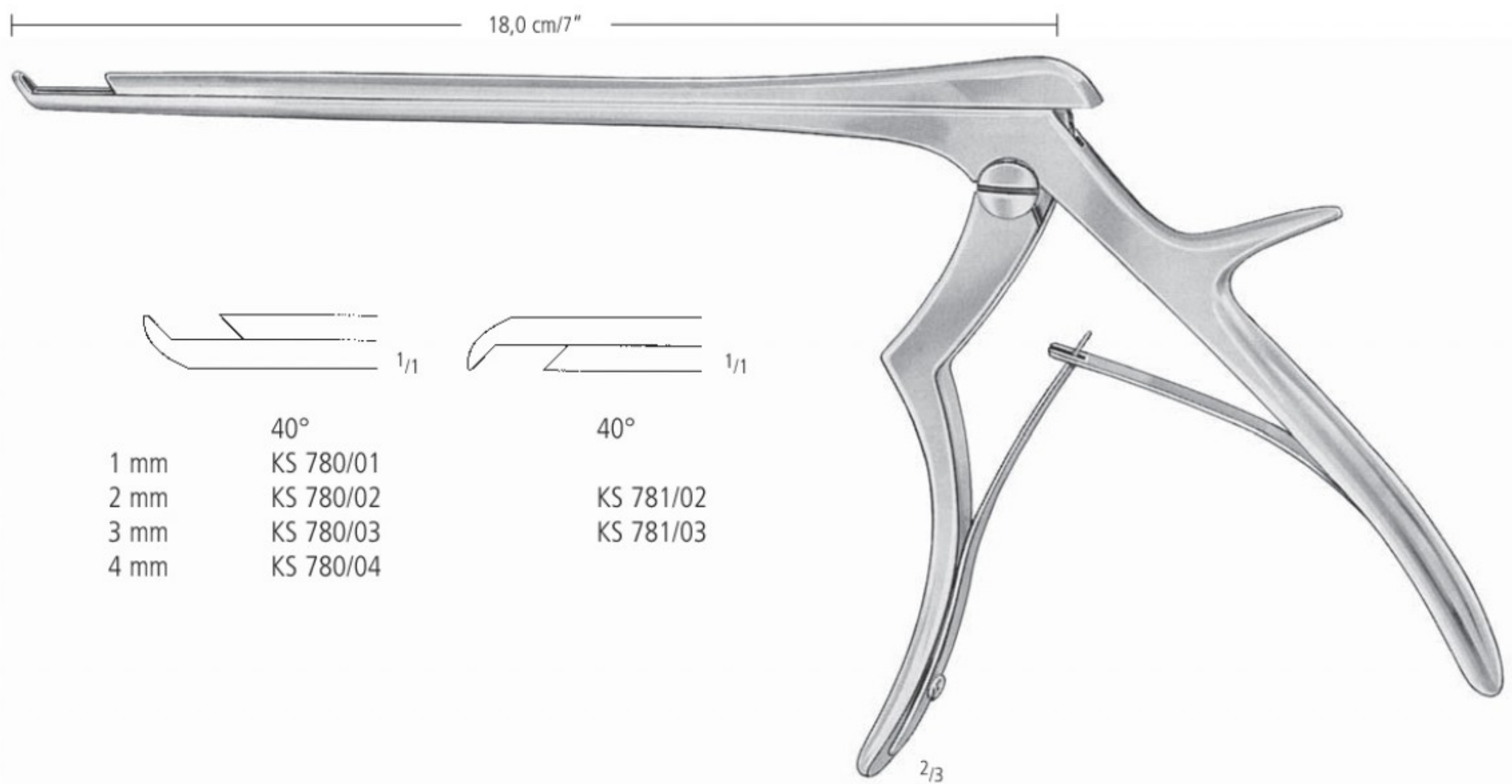

PLATTFUSS

Hypophysen-Instrumente
 Pituitary Instruments
 Instrumentos para hipófisis
 Instruments pour la chirurgie pituitaire
 Strumenti per ipofisi cerebrale

AA

AB

AC

AE

AK

AO

AR

KA

KS

XR

XT

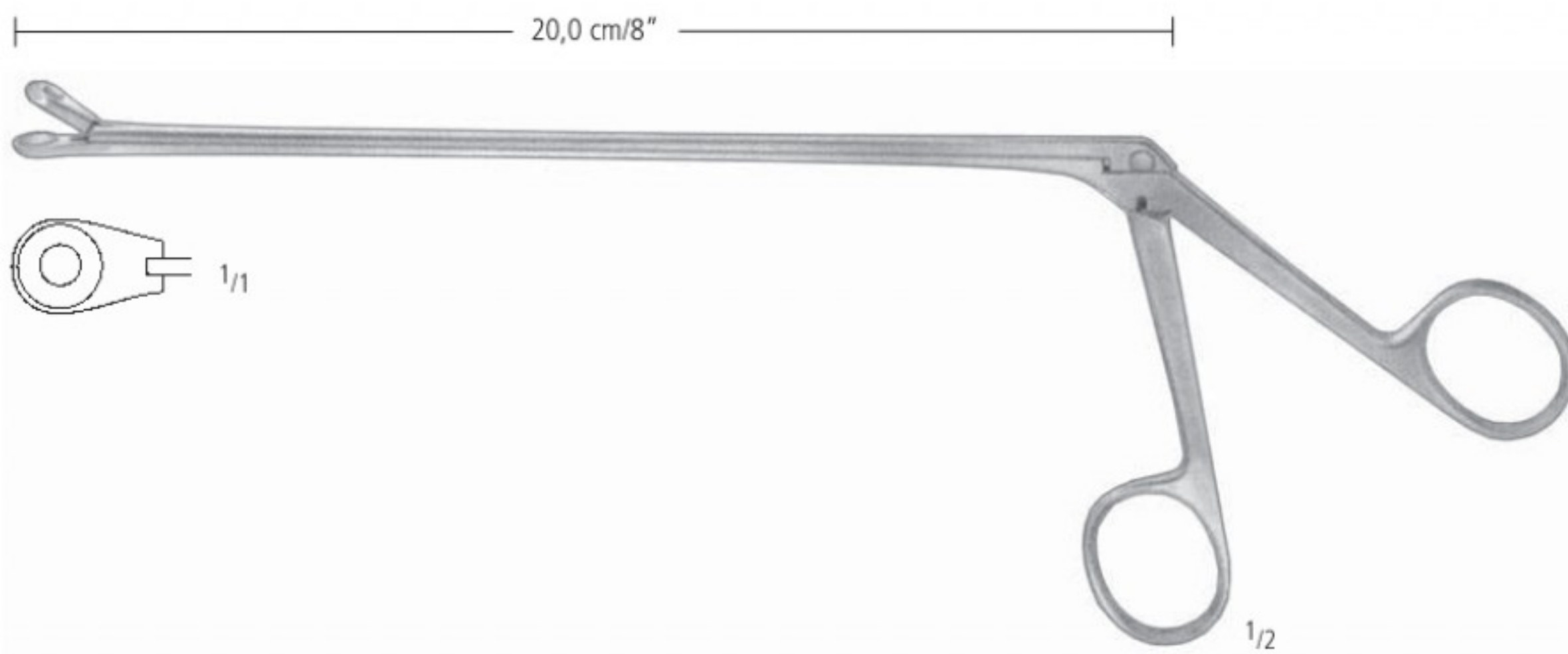
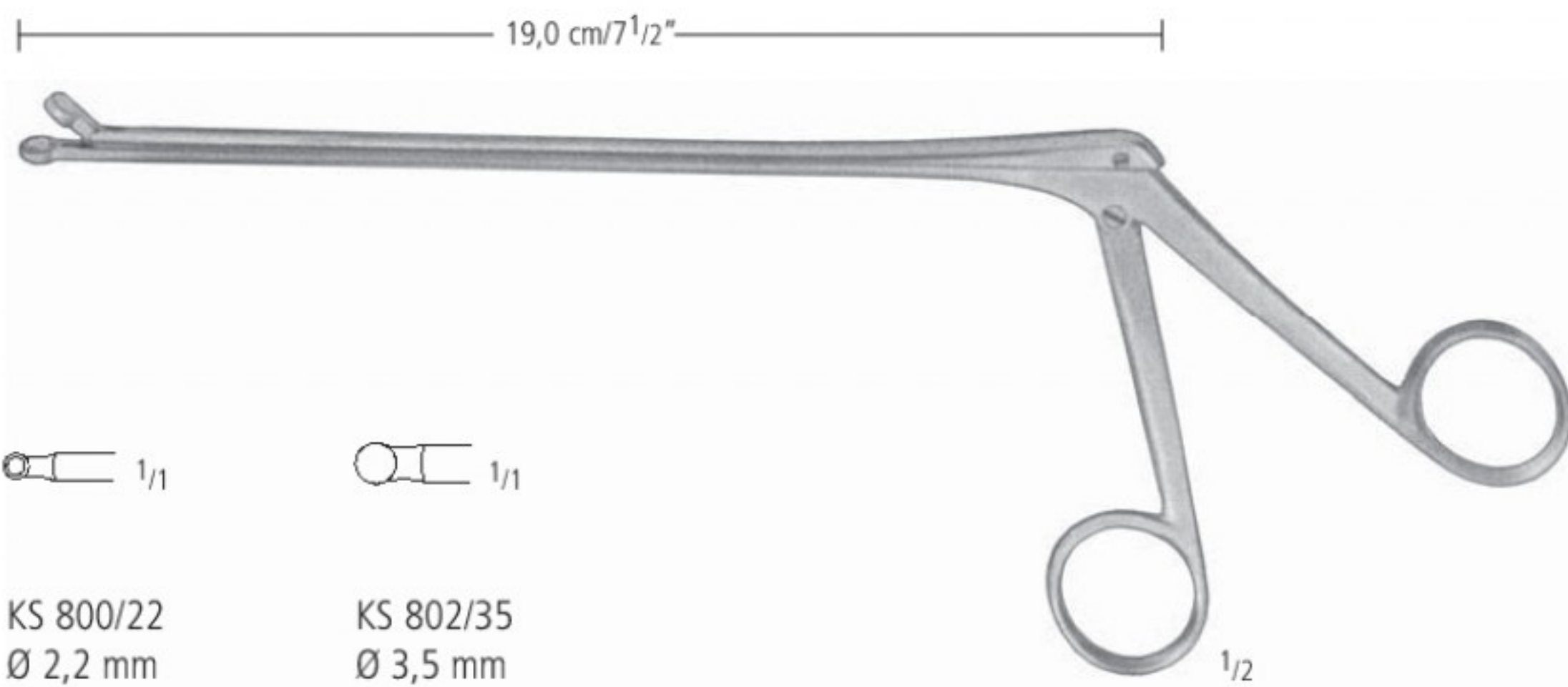

LANDOLT
 KS 804/09
 Ø 9 mm

Hypophysen-Instrumente
 Pituitary Instruments
 Instrumentos para hipófisis
 Instruments pour la chirurgie pituitaire
 Strumenti per ipofisi cerebrale

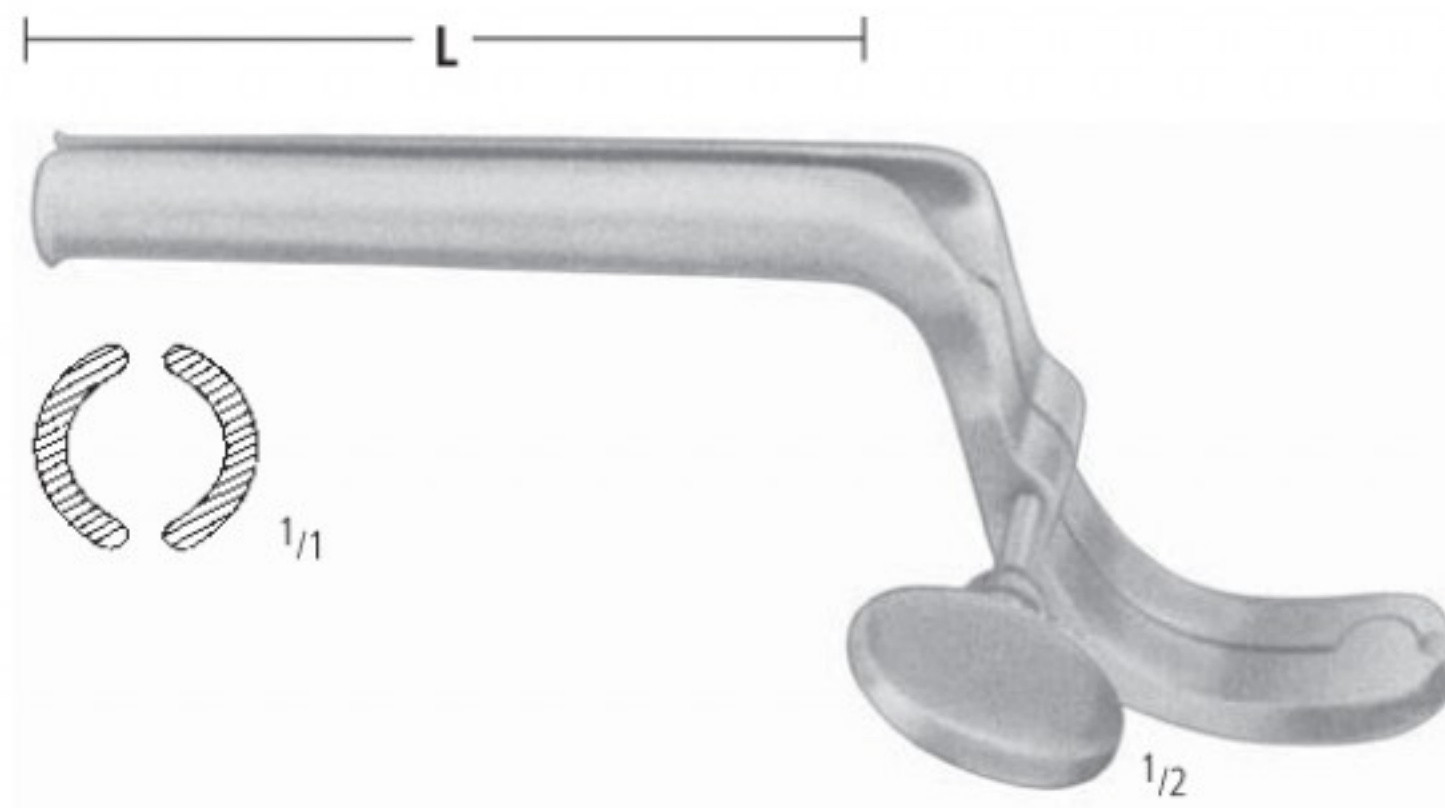

CUSHING-LANDOLT

L	
70 x 15 mm	KS 820/01
90 x 15 mm	KS 820/02
110 x 15 mm	KS 820/03



LANDOLT
 KS 821/21
 21,5 cm/8 1/2"

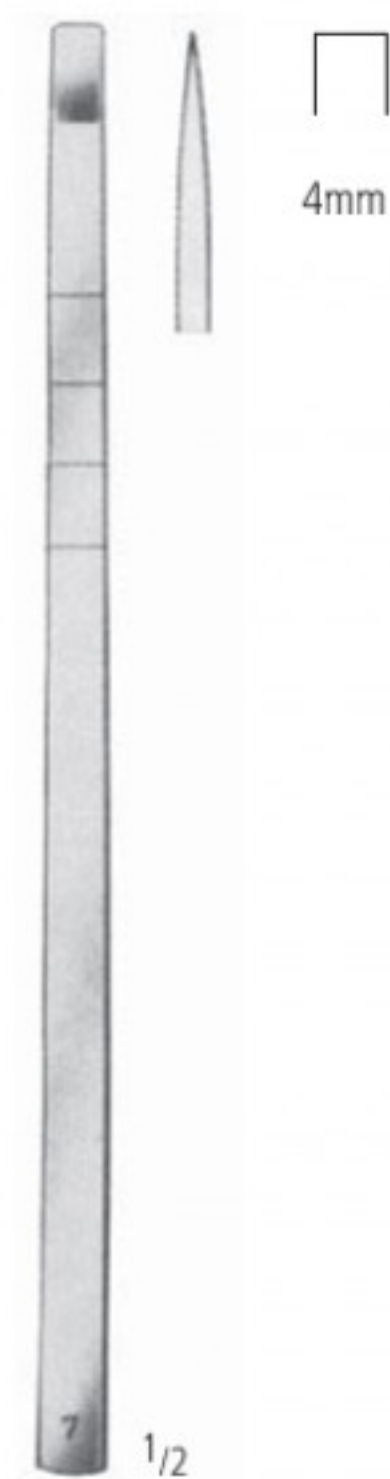

COTTLE
 KS 822/04
 18 cm/7"

Hypophysen-Instrumente
 Pituitary Instruments
 Instrumentos para hipófisis
 Instruments pour la chirurgie pituitaire
 Strumenti per ipofisi cerebrale

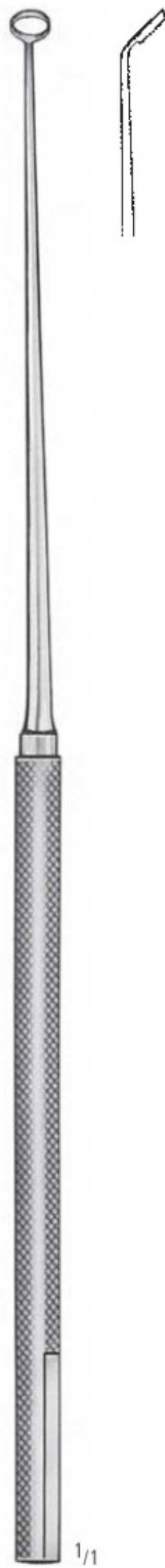

RAY
 18,0 cm/7¹/₄"

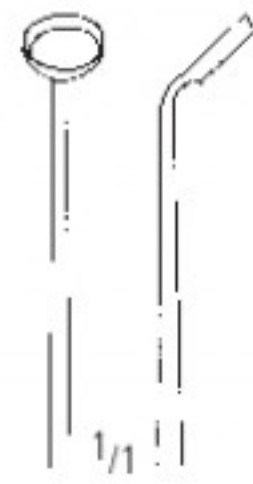

Ø 4 mm
 KS 830/18

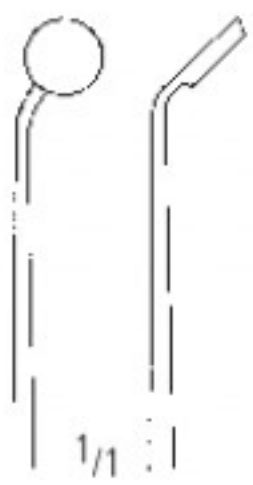

Ø 4 mm
 KS 831/18

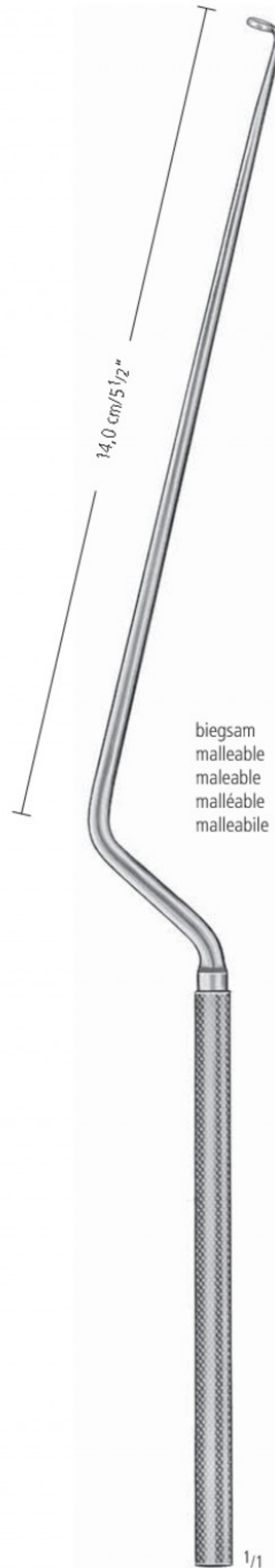

biegsam
 malleable
 maleable
 malléable
 malleabile

HARDY
 26,0 cm/10¹/₄"



Ø 4 mm
 KS 832/04

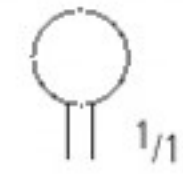

Ø 6 mm
 KS 832/06

AA

AB

AC

AE

AK

AO

AR

KA

KS

XR

XT

Hypophysen-Instrumente
 Pituitary Instruments
 Instrumentos para hipófisis
 Instruments pour la chirurgie pituitaire
 Strumenti per ipofisi cerebrale

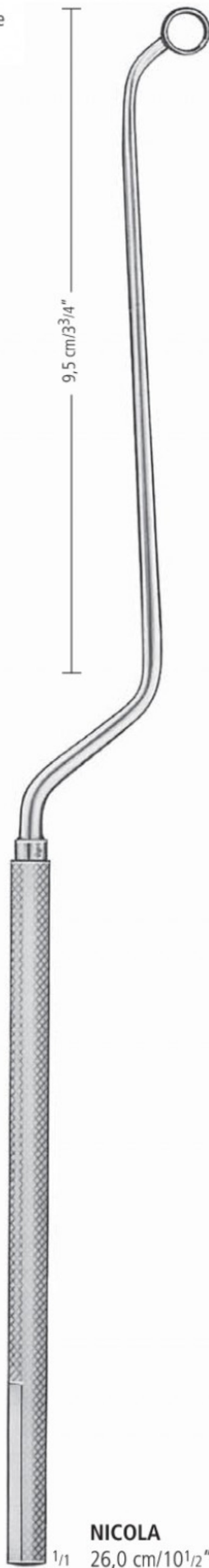

9,5 cm/3 3/4"

NICOLA
 1/1 26,0 cm/10 1/2"



KS 834/01
 biegsam
 malleable
 maleable
 malléable
 malleabile



KS 834/02
 biegsam
 malleable
 maleable
 malléable
 malleabile



KS 835/22



KS 836/22

Hypophysen-Instrumente
 Pituitary Instruments
 Instrumentos para hipófisis
 Instruments pour la chirurgie pituitaire
 Strumenti per ipofisi cerebrale

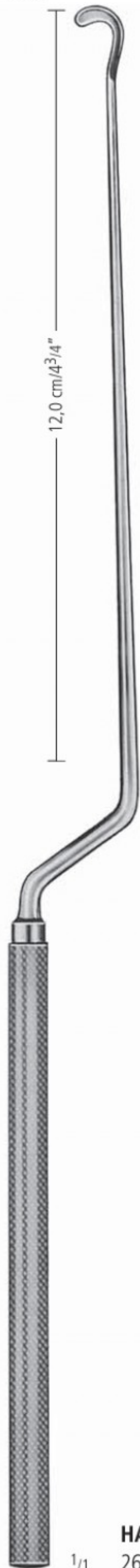

HARDY
 1/1 26,0 cm/10 1/4\"/>



KS 837/01
 stumpf
 blunt
 romo
 mousse
 smusso



KS 837/02
 stumpf
 blunt
 romo
 mousse
 smusso



KS 837/03
 scharf
 sharp
 cortante
 tranchante
 tagliente



KS 837/04
 scharf
 sharp
 cortante
 tranchante
 tagliente



HARDY
 KS 838/25



HARDY-FAHLBUSCH
 KS 839/01
 scharf
 sharp
 cortante
 tranchante
 tagliente



HARDY-FAHLBUSCH
 KS 839/02
 scharf
 sharp
 cortante
 tranchante
 tagliente

AA
 AB
 AC
 AE
 AK
 AO
 AR
 KA
 KS
 XR
 XT

Hypophysen-Instrumente
 Pituitary Instruments
 Instrumentos para hipófisis
 Instruments pour la chirurgie pituitaire
 Strumenti per ipofisi cerebrale

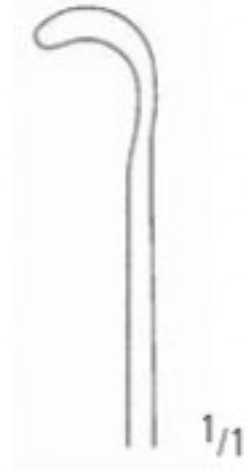
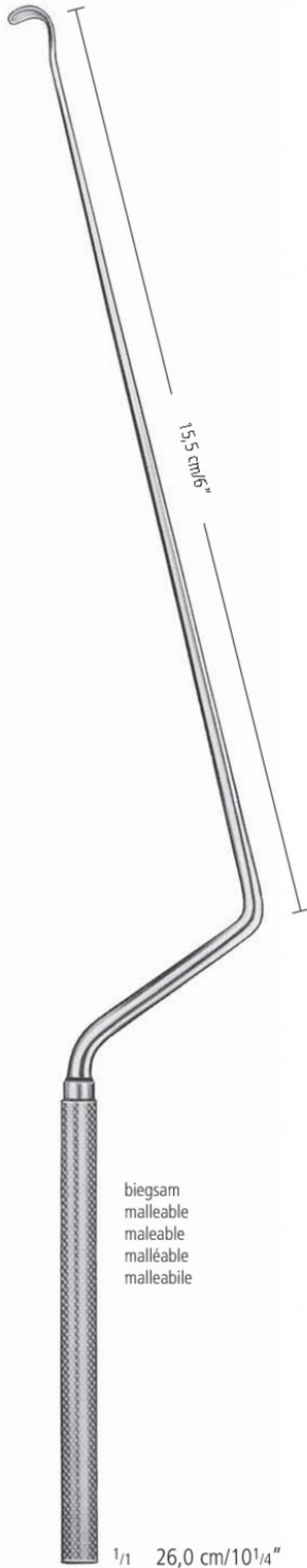

LANDOLT
KS 840/01



LANDOLT
KS 840/02

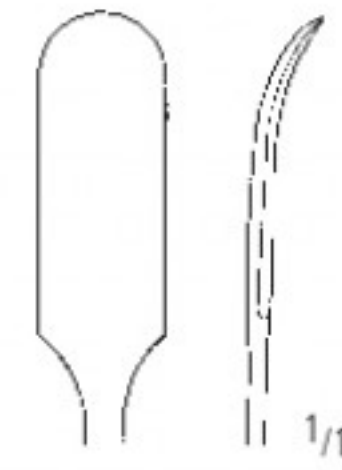

LANDOLT
KS 841/26

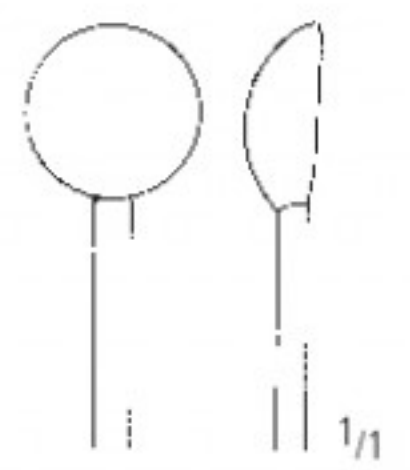

LANDOLT
KS 842/26



LANDOLT
KS 843/26



FAHLBUSCH
KS 844/26



FAHLBUSCH
KS 845/26

Hypophysen-Instrumente
 Pituitary Instruments
 Instrumentos para hipófisis
 Instruments pour la chirurgie pituitaire
 Strumenti per ipofisi cerebrale

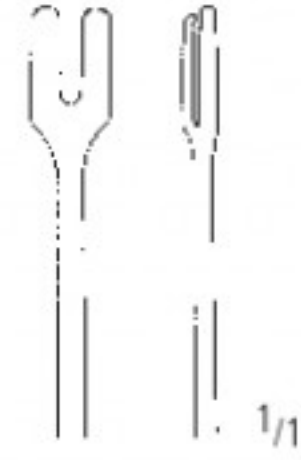
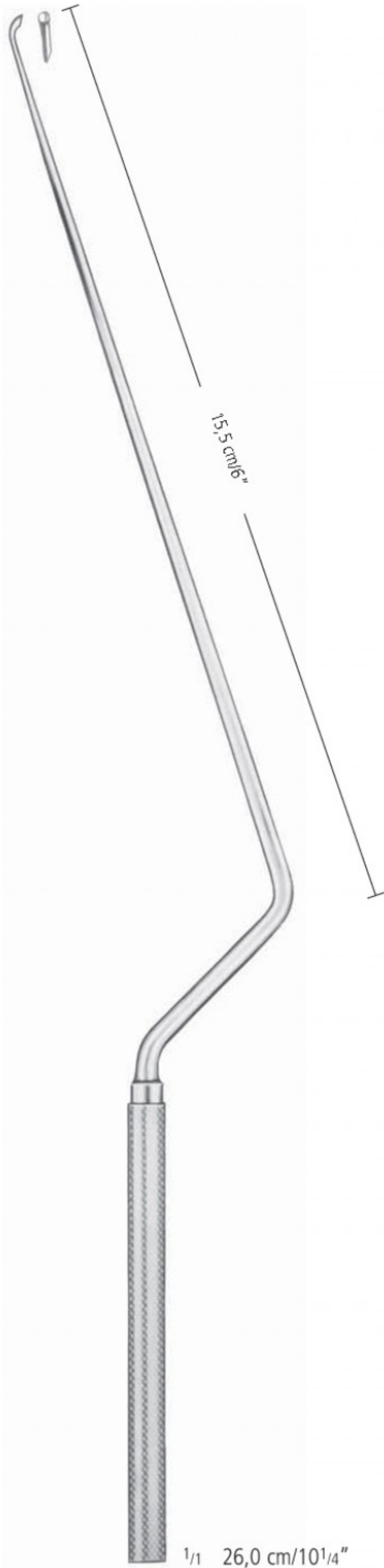

HOSOBUCHI
 KS 846/26

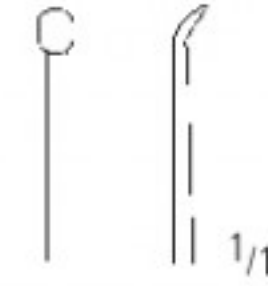

LANDOLT-REULEN
 Ø 2,2 mm
 KS 847/22

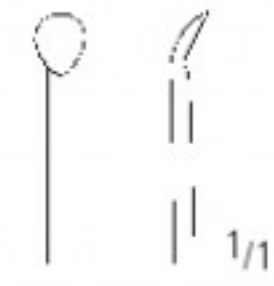

LANDOLT-REULEN
 Ø 3,2 mm
 KS 847/32

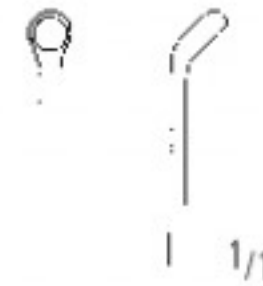

LANDOLT-REULEN
 Ø 2,5 mm
 KS 848/25



LANDOLT-REULEN
 Ø 1,7 mm
 KS 849/17

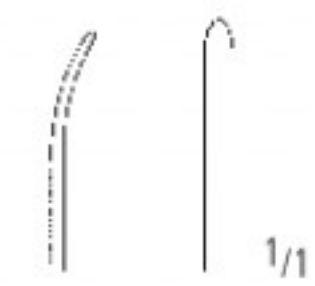

LANDOLT-REULEN
 Ø 2,0 mm
 KS 850/20

AA
 AB
 AC
 AE
 AK
 AO
 AR
 KA
 KS
 XR
 XT

ENDOSKOPIE
ENDOSCOPY
ENDOSCOPIA
ENDOSCOPIE
ENDOSCOPIA

XR

nopa[®] instruments

Unser komplettes **Endoskopie**-Programm finden Sie in Katalog **X - ENDOSKOPIE**.

For our complete program in **endoscopy** please refer to catalogue **X - ENDOSCOPY**.

Para nuestro programa completo de **endoscopia** vea el catálogo **X - ENDOSCOPIA**.

Pour notre programme complet d'**endoscopie** voir le catalogue **X - ENDOSCOPIE**.

Per la nostra gamma completa di **endoscopia** la preghiamo di consultare il catalogo **X - ENDOSCOPIA**.



Anschlußkabel
 Connection Cords
 Cables de connexion
 Câbles de raccordement
 Cavi da connessione

monopolar

bipolar



MARTIN/BERCHTOLD

300 cm XR 827/03
 500 cm XR 827/05

XR 828/03
 XR 828/05

XR 830/03
 XR 830/05

monopolar

bipolar

monopolar

bipolar



ERBE
 300 cm XR 831/03
 500 cm XR 831/05
 (ACC/ICC)

ERBE
 XR 831/13
 XR 831/15
 (T-Serie)

ERBE/SELECT
 XR 832/03
 XR 832/05

ERBE
 XR 833/03
 XR 833/05

VALLEYLAB
 XR 834/03
 XR 834/05
 (in D nicht zulässig
 nach MedGV)

ENDOSKOPIE ENDOSCOPY ENDOSCOPIA ENDOSOIPIE ENDOSCOPIA

Bi-Koagulations-Pinzetten
 Bi-Coagulation-Forceps
 Pinzas para la Bi-Coagulación
 Pince pour la Bi-Coagulation
 Pinze per la Bi-Coagulazione



16,0 cm/6 ¹ / ₄ "	XR 890/16 A	XR 891/16 C	XR 894/16 C		
16,0 cm/6 ¹ / ₄ "	XR 890/16 C	XR 891/16 D	XR 894/16 D		
16,0 cm/6 ¹ / ₄ "	XR 890/16 E	XR 891/16 E	XR 894/16 E		
20,0 cm/8"	XR 890/20 A	XR 891/20 A	XR 894/20 A		
20,0 cm/8"	XR 890/20 C	XR 891/20 C	XR 894/20 C	XR 895/20 C	XR 896/20 C
20,0 cm/8"	XR 890/20 E	XR 891/20 F	XR 894/20 E		
20,0 cm/8"			XR 894/20 F		
22,0 cm/8 ³ / ₄ "	XR 890/22 A	XR 891/22 C	XR 894/22 D		
22,0 cm/8 ³ / ₄ "	XR 890/22 C		XR 894/22 E	XR 895/22 C	XR 896/22 C

A=2,0 mm

C=1,0 mm



D=0,5 mm

E=Nadel

F=Profil



11,0 cm/4 ¹ / ₄ "	XR 898/11 D	XR 899/11 D
11,0 cm/4 ¹ / ₄ "	XR 898/11 E	XR 899/11 E

AA

AB

AC

AE

AK

AO

AR

KA

KS

XR

XT

ENDOSKOPIE
ENDOSCOPY
ENDOSCOPIA
ENDOSCOPIE
ENDOSCOPIA

XT

nopa[®] instruments

Unser komplettes **Endoskopie**-Programm finden Sie in Katalog **X - ENDOSKOPIE**.

For our complete program in **endoscopy** please refer to catalogue **X - ENDOSCOPY**.

Para nuestro programa completo de **endoscopia** vea el catálogo **X - ENDOSCOPIA**.

Pour notre programme complet d'**endoscopie** voir le catalogue **X - ENDOSCOPIE**.

Per la nostra gamma completa di **endoscopia** la preghiamo di consultare il catalogo **X - ENDOSCOPIA**.



Kaltlichtkabel
 Fibre optic cable
 Cable fibra óptica
 Câble fibre optique
 Cavo fibra ottica

AA

AB

AC

AE

AK

AO

AR

KA

KS

XR



Kaltlichtkabel-Grundkabel
Basic fibre optic cable

XT 035/18	Ø 3,5 mm, 180 cm
XT 035/23	Ø 3,5 mm, 230 cm
XT 035/30	Ø 3,5 mm, 300 cm
XT 045/18	Ø 4,5 mm, 180 cm
XT 045/23	Ø 4,5 mm, 230 cm
XT 045/30	Ø 4,5 mm, 300 cm
XT 060/18	Ø 6,0 mm, 180 cm
XT 060/23	Ø 6,0 mm, 230 cm
XT 060/30	Ø 6,0 mm, 300 cm



XT 070/18	Ø 3,5 mm, 180 cm
XT 070/23	Ø 3,5 mm, 230 cm
XT 070/30	Ø 3,5 mm, 300 cm

XT

- >> **Zusätzliche Isolierung**
- >> **Metallspirale**
- >> **Silikonmantel**
- >> **Sterilisierbar**

- >> **Additionally insulated**
- >> **Metal spiral**
- >> **Silicon tube**
- >> **Autoclavable**

Adapter
Adapter
Adaptador
Connexion
Adattatore

**Projektor-Seite
Projector side**

**Endoskop-Seite
Endoscope side**

XT 100/01



STORZ



XT 100/11

**STORZ/WINTER + IBE
OLYMPUS/STRYKER**

XT 100/02



WOLF/HENKE-SASS



XT 100/12

WOLF/HENKE-SASS

XT 100/03



ACM/HEINE



XT 100/13

ACM/HEINE

XT 100/04



WINTER + IBE

XT 100/05



OLYMPUS

Bestellinformation / Ordering information

**>> Bitte bestellen Sie Kaltlicht-
grundkabel mit 2 Adaptern**

**>> Please order the basic fibre
optic cable and two adapters**

Kaltlichtquellen
Cold Light Sources
Fuente de luz fría
Source à lumière froide
Sorgente luce fredda

nopa[®] light halogen 2 x 250W future 100



XT 170/00 = 110 - 230 VAC

XT 169/00 = Ersatzlampe
Spare bulb
Bombilla de recambio
Lampe de rechange
Lampadina di ricambio

nopalight halogen 2 x 250W

Beschreibung XT 170/00

Die nopalight halogen 2 x 250 W Lichtquelle kann bei allen Einsätzen angewendet werden, besonders dann, wenn eine starke Ausleuchtung oder eine Videoaufzeichnung notwendig ist.

Alle modernen Autoshutter-Videokameras werden mit ausreichender Lichtzufuhr versorgt. Die zweite Lampe wird als Reserve bei Lampendefekten oder Lampenausfall durch sofortiges Umschalten während den Einsätzen aktiviert.

Spezielle Wärmeschutzfilter sorgen für eine Schonung der Lichtleiter und eine optimale Lichtfiltrierung. Das Gerät ist MedGV-geprüft.

Technische Daten

Elektr. Versorgung:	100-240 VAC/50-60Hz Weltnetzteil
Farbtemperatur:	über 3500° K
Lichtregelung:	automatisch, stufenlos
Maße (B x H x T):	355 x 110 x 320 mm
Gewicht:	ca. 8,5 kg

Zubehör

Lampe XT 169/00: 250 Watt Halogen

nopalight halogen 2 x 250W

Description XT 170/00

The nopalight halogen 2 x 250 W lightsource can be utilized in all procedures, especially if a strong illumination or video-monitoring is required.

All modern autoshutter-videocameras will be supplied with sufficient light-intensity, the second lamp serves as stand-by. Simply switch-over.

Special temperature-filters guarantee long life of light cables and optimal light output. The nopalight halogen 2 x 250 W lightsource is approved by MedGV.

Technical data

Power supply:	100-240 VAC/50-60Hz world power supply
Color temperature:	more than 3500° K
Light control:	automatic
Measurements (W x H x D):	355 x 110 x 320 mm
Weight:	approx. 8,5 kg

Accessories

Bulb XT 169/00: 250 Watt Halogen