dental und oral
dental and oral
odontología y oral
dental et oral
odontoiatría e orale

nopa[®] instruments



AA/AB	>> Klemmen • Hemostats • Pinzas hemostáticas • Pinces hémostatiques • Pinze emostatiche >> Pinzetten • Forceps • Pinzas • Pinces • Pinze	7–32
AC/AD	>> Scheren • Scissors • Tijeras • Ciseaux • Forbici >> Skalpelle • Scalpels • Bisturías • Bistouris • Bisturi	33–64
AE	>> Naht • Suture • Sutura • Suture • Sutura	65–84
AF	>> Tupferzangen • Sponge Forceps • Pinzas para pólipos • Pinces à pansements Pinze per polipi	85–88
AK	>> Wundhaken • Retractors • Separadores • Ecarteurs • Divaricatori	89–100
AL/AO	>> Sonden, Trokare, Saugrohre • Probes, Trocars, Suction Tubes Sondas, Trócares, Tubos de aspiración • Sondes, Trocarts, canules d'aspiration Sonde, Trequarti, Cannule per aspirazione	101–110
AR	>> Messinstrumente • Measuring instruments • Instrumentos para medidas Instruments pour mesurer • Strumenti per misurare	111–118
KA	>> Knocheninstrumente • Bone instruments • Instrumentos para hueso Instruments à l'os • Strumenti per osso	119–138
KL	>> Mund/Zunge • Oral Instruments • Boca/Lengua • Bouche/Langue • Bocca/Lingua	139–150
KU	>> Verschiedenes • Various items • Diversos articulos • Articles divers • Articoli diversi	151–160

<p>>> Zahnzangen • Extracting forceps • Forceps de extracción • Daviers • Pinza per estrazione – english pattern –</p> <p style="text-align: right;">161–204</p>	<p>PA</p>
<p>>> Zahnzangen • Extracting forceps • Forceps de extracción • Daviers • Pinza per estrazione – american pattern –</p> <p style="text-align: right;">205–224</p>	<p>PB</p>
<p>>> Wurzelheber • Root elevators • Elevadores para raíces • Elevateurs à racines Elevatori per radici</p> <p style="text-align: right;">225–248</p>	<p>PF</p>
<p>>> Zahnreiniger • Dental scalers • Limpiadores de sarro • Instruments à detarter Levatartari dentali</p> <p>>> Paradontologie • Periodontology • Paradontologia • Paradontologie • Paradontologia</p> <p>>> Sonden • Probes/Explorers • Sondas • Sondes • Sonde</p> <p>>> Exkavatoren • Excavators • Excavadores • Excavateurs • Escavatori</p> <p style="text-align: right;">249–280</p>	<p>PI-PM</p>
<p>>> Schmelzmeißel, Füllungsinstrumente • Enamel chisels, filling instruments Cinceles para esmalte, instrumentos para obturaciones • Ciseaux à email, instruments pour plombages • Tagliasmalto, Otturatori</p> <p style="text-align: right;">281–302</p>	<p>PP/PS</p>
<p>>> Prothetik und Orthodontie • Prothetics and orthodontia • Prothesis y ortodoncia Prothese et orthodontie • Protesi e ortodonzia</p> <p style="text-align: right;">303–332</p>	<p>PT</p>
<p>>> Matrizen • Matrix • Matrices • Matrice • Matrici</p> <p style="text-align: right;">333–338</p>	<p>PU</p>
<p>>> Implantologie • Implantology • Implantologia • Implantologie • Implantologia</p> <p style="text-align: right;">339–346</p>	<p>PV</p>
<p>>> Sterilisationsbehältnisse und Norm-Trays • Sterilizing containers and standard trays Cajas para esterilización y bandejas estándar • Des boîtes à instruments et pour la stérilisation et trays standard • Astucci per la sterilizzazione e bacinelle standard</p> <p style="text-align: right;">347–362</p>	<p>KYE</p>

KLEMMEN
HEMOSTATS
PINZAS HEMOSTATICAS
PINCES HEMOSTATIQUES
PINZE EMOSTATICHE

AA

nopa[®] instruments



Arterienklemmen
 Artery Forceps
 Pinzas hemostáticas
 Pincés hémostatiques
 Pinze emostatiche



PEAN
 14,0 cm/5¹/₂" AA 080/14
 16,0 cm/6¹/₄" AA 080/16

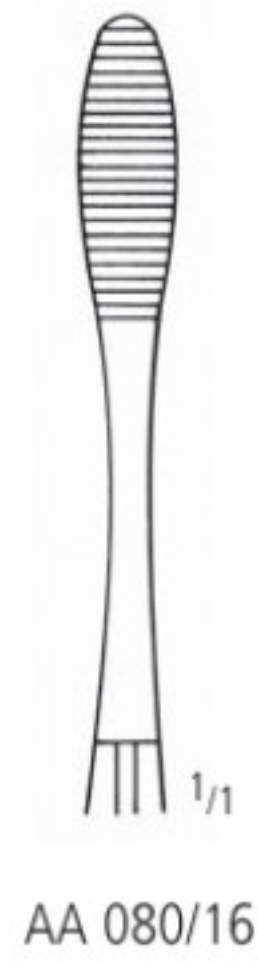

HARTMANN
 AA 114/10
 10,0 cm/4"



HARTMANN
 AA 115/10
 10,0 cm/4"

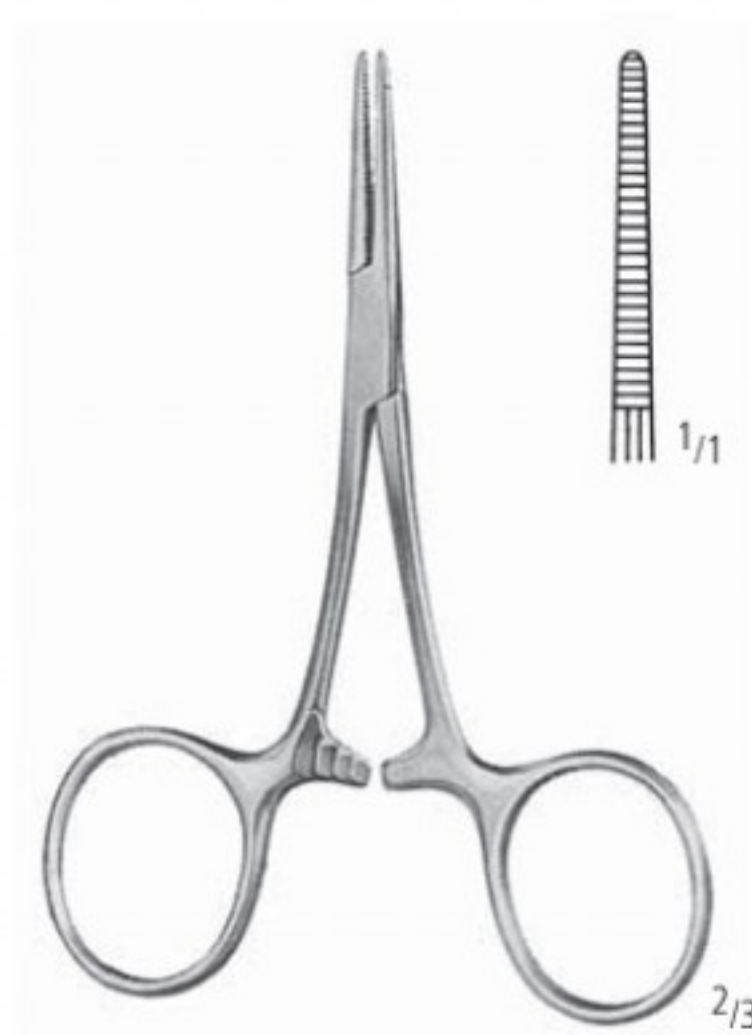

CARREL
 AA 116/08
 8,5 cm/3¹/₂"

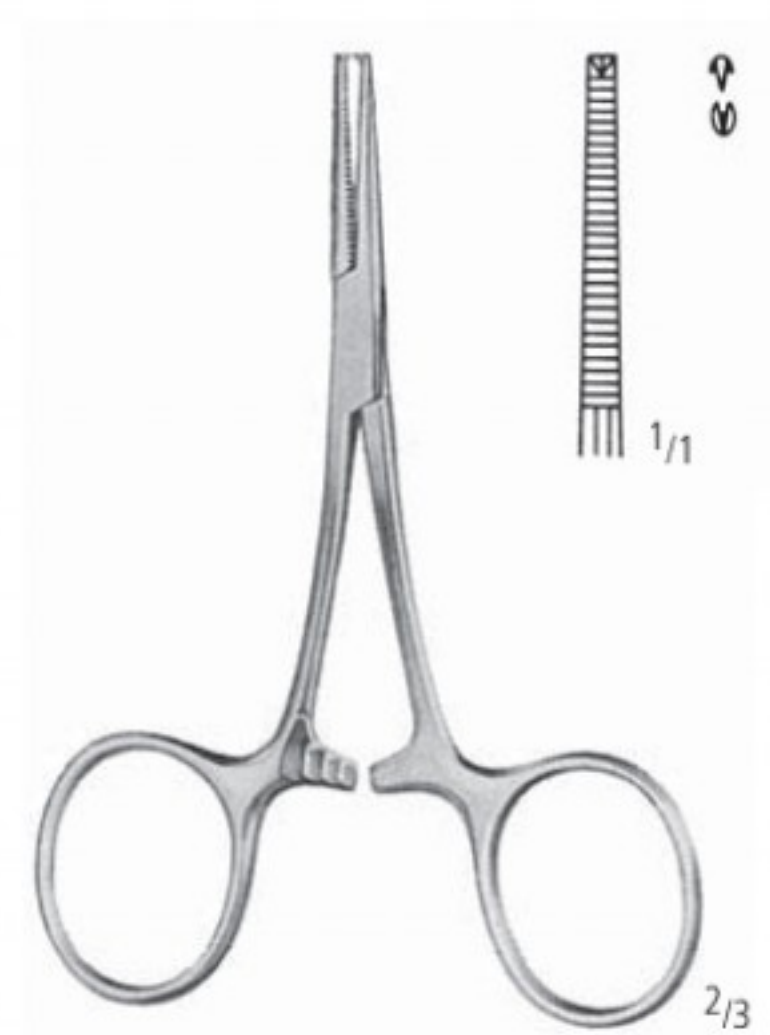

TERRIER 1:2
 AA 118/08
 8,5 cm/3¹/₂"

Arterienklemmen
 Artery Forceps
 Pinzas hemostáticas
 Pincés hémostatiques
 Pinze emostatiche

AA

AB

AC

AD

AE

AF

AK

AL

AO

AR

KA

KL

KU

PA

PB

PF

PI

PK

PL

PM

PP

PS

PT

PU

PV

KYE

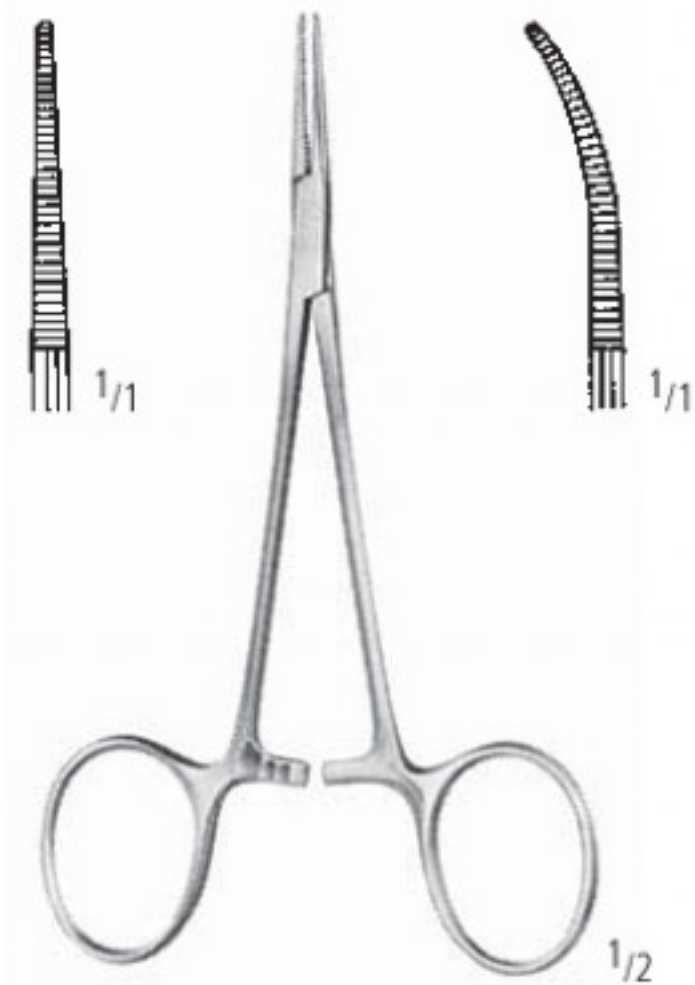

MICRO-MOSQUITO

AA 130/10 AA 131/10
 AA 130/12 AA 131/12

10,0 cm/4"
 12,0 cm/4³/₄"

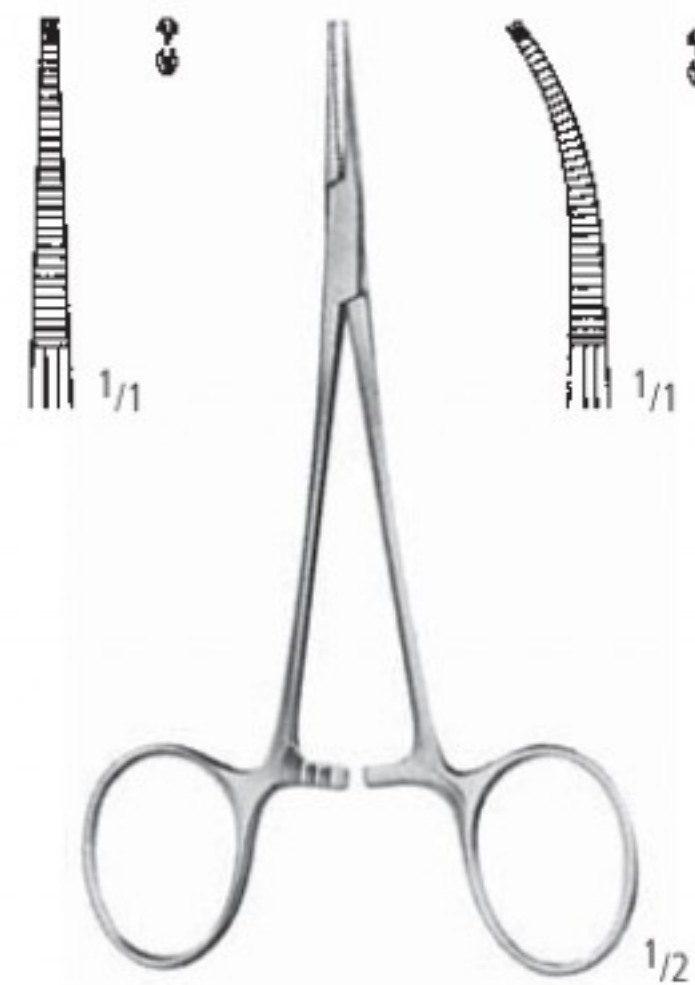

MICRO-MOSQUITO 1:2

AA 132/10 AA 133/10
 AA 132/12 AA 133/12

WILLIAM STEWART HALSTED

was professor of surgery in the Johns Hopkins University. In 1890 he had bronze casts made of his own hands. On these casts the first surgical rubber gloves were moulded.

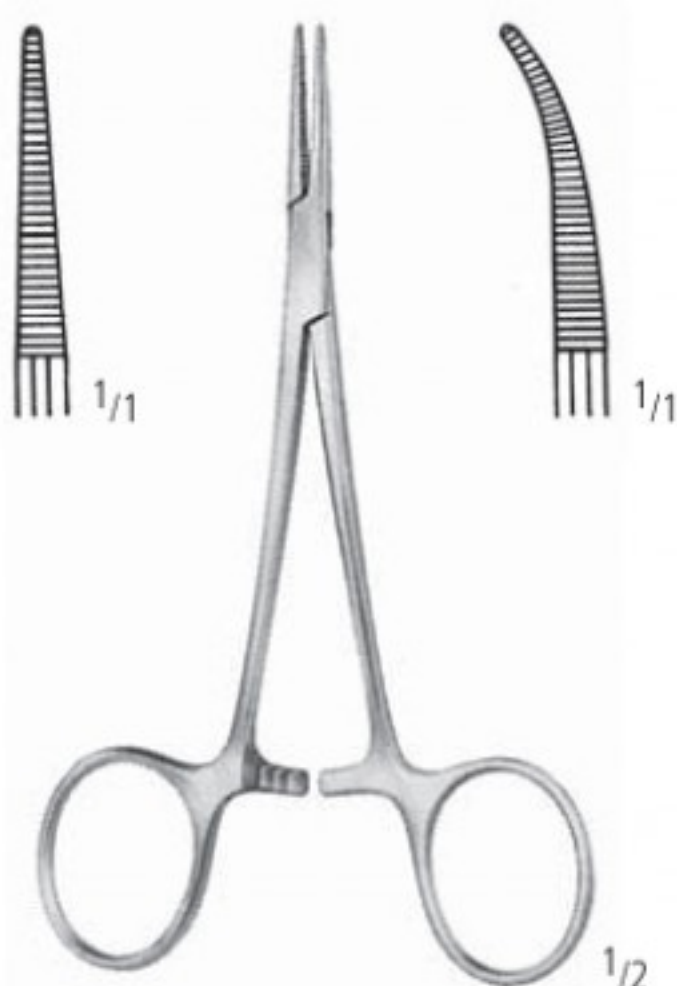

HALSTED-MOSQUITO

AA 150/12 AA 151/12
 AA 150/14 AA 151/14

12,5 cm/5"
 14,0 cm/5¹/₂"

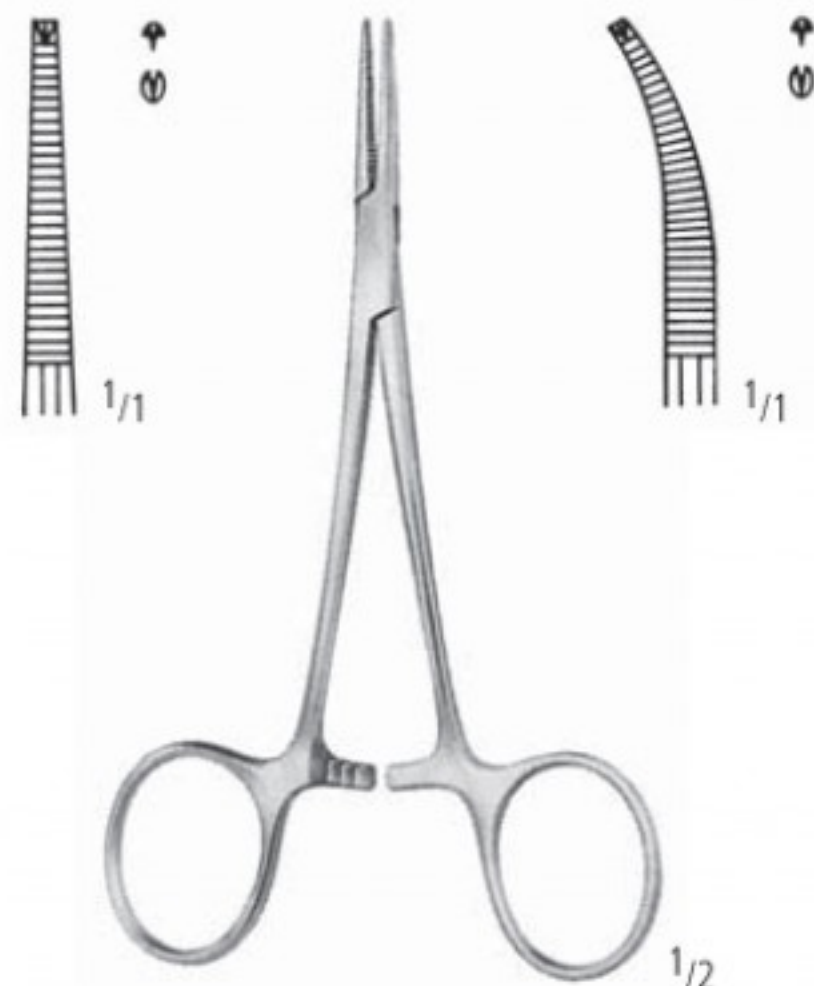

HALSTED-MOSQUITO 1:2

AA 152/12 AA 153/12
 AA 152/14 AA 153/14

Arterienklemmen
 Artery Forceps
 Pinzas hemostáticas
 Pincas hémostatiques
 Pinze emostatiche

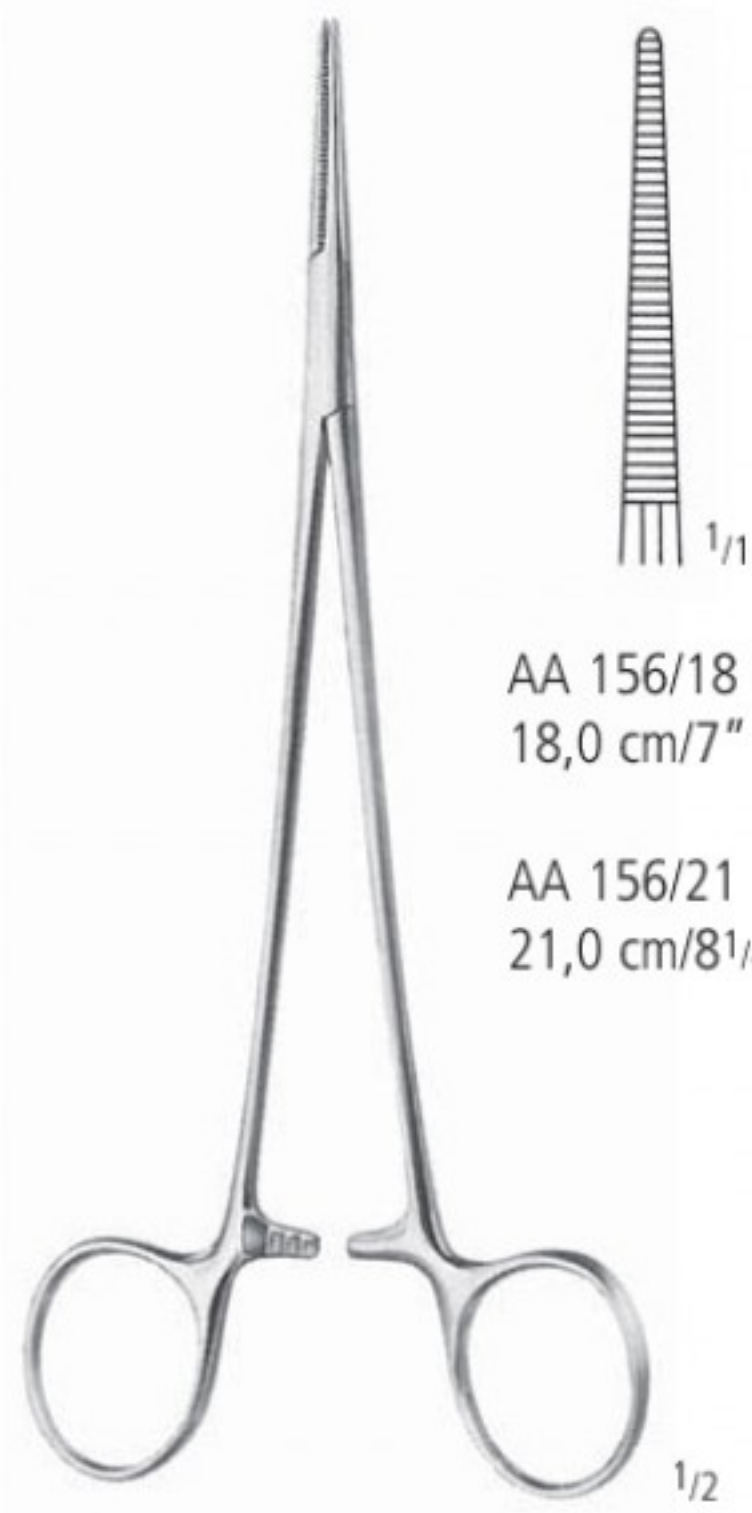

AA 156/18
 18,0 cm/7"

AA 156/21
 21,0 cm/8¹/₄"

HALSTED

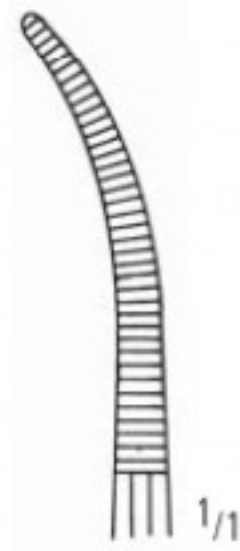

AA 157/18
 18,0 cm/7"

AA 157/21
 21,0 cm/8¹/₄"

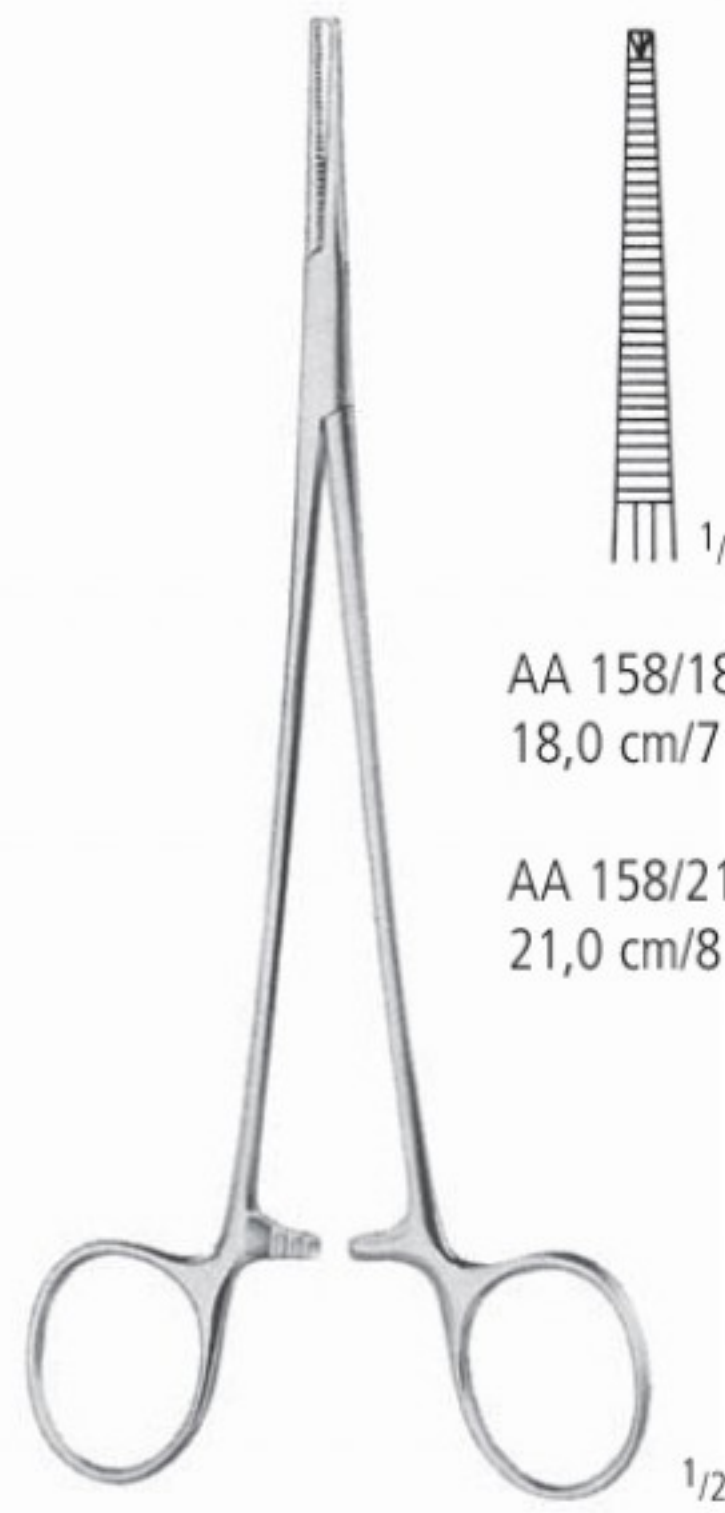

AA 158/18
 18,0 cm/7"

AA 158/21
 21,0 cm/8¹/₄"

HALSTED 1:2

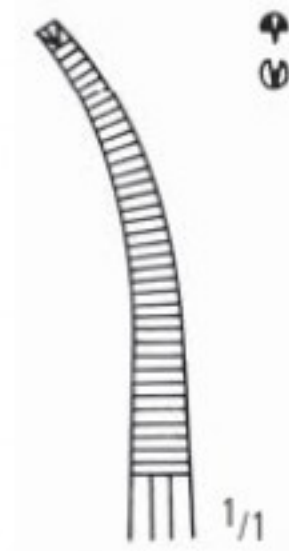

AA 159/18
 18,0 cm/7"

AA 159/21
 21,0 cm/8¹/₄"

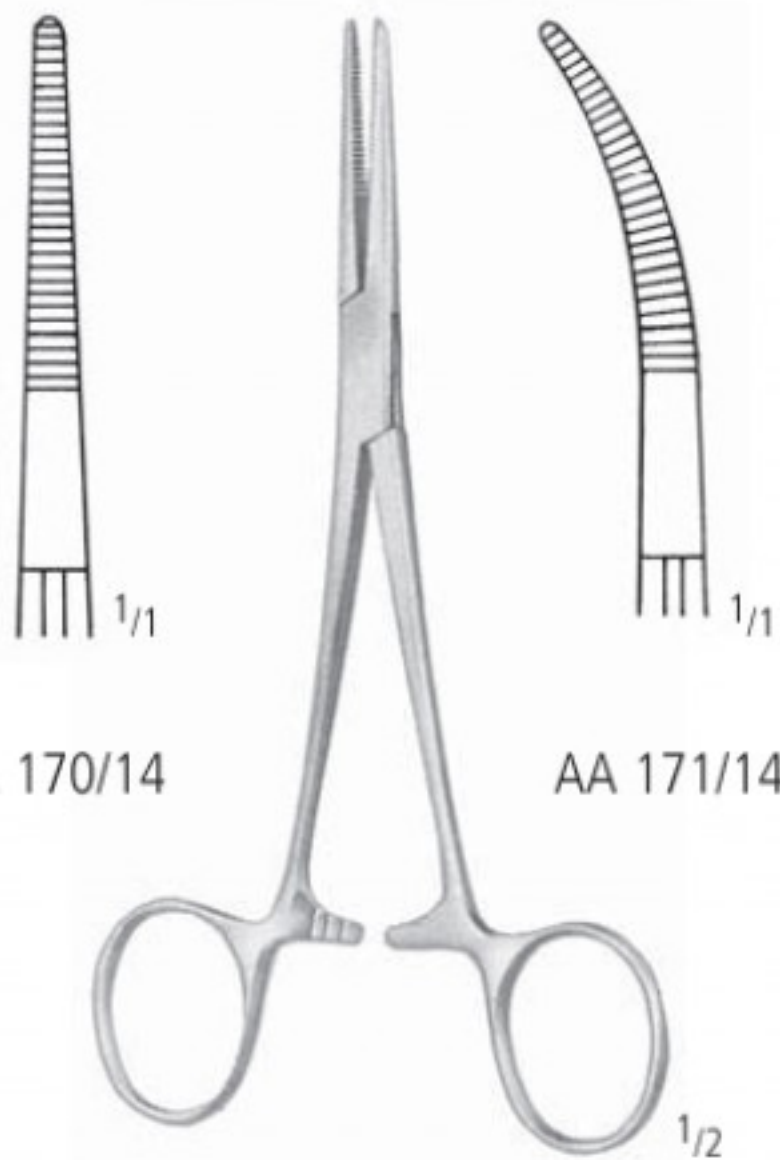

AA 170/14

AA 171/14

KELLY
 14,0 cm/5¹/₂"

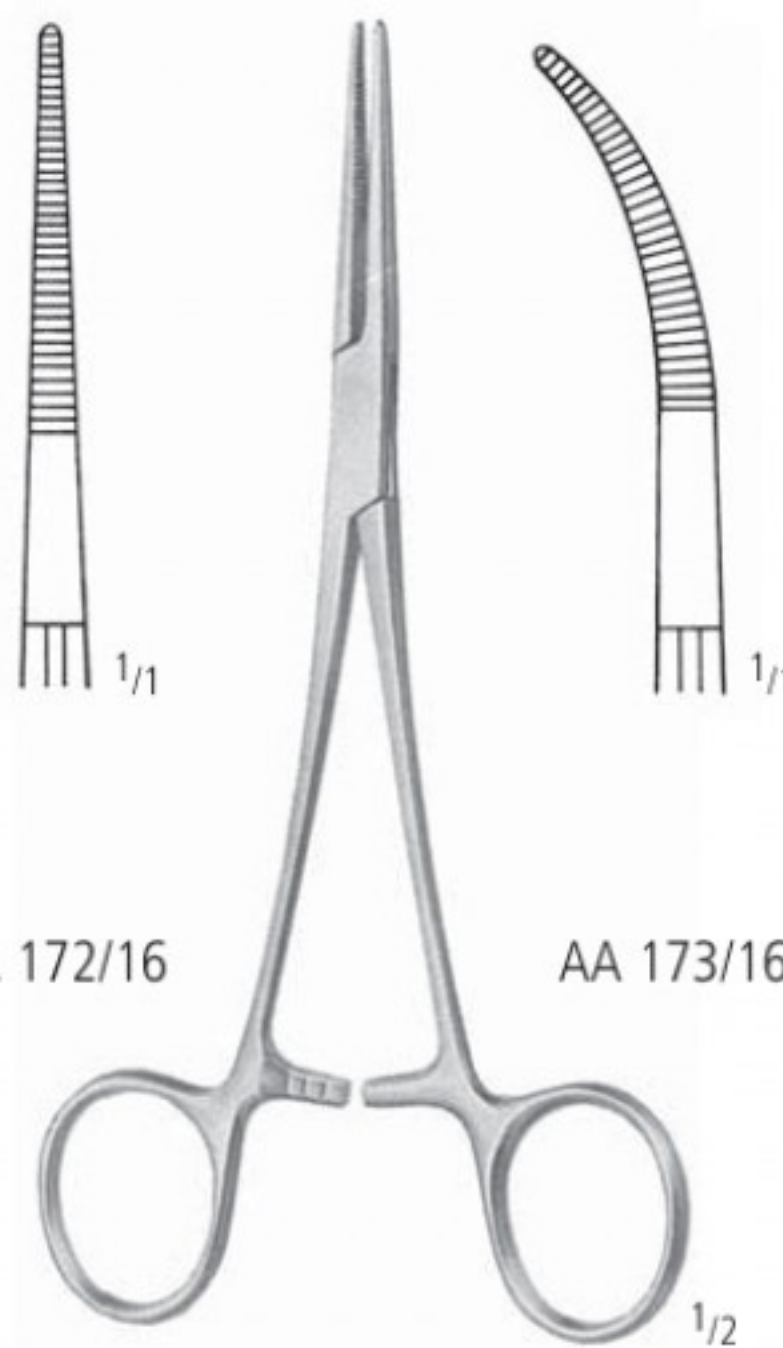

AA 172/16

AA 173/16

KELLY-RANKIN
 16,0 cm/6¹/₄"

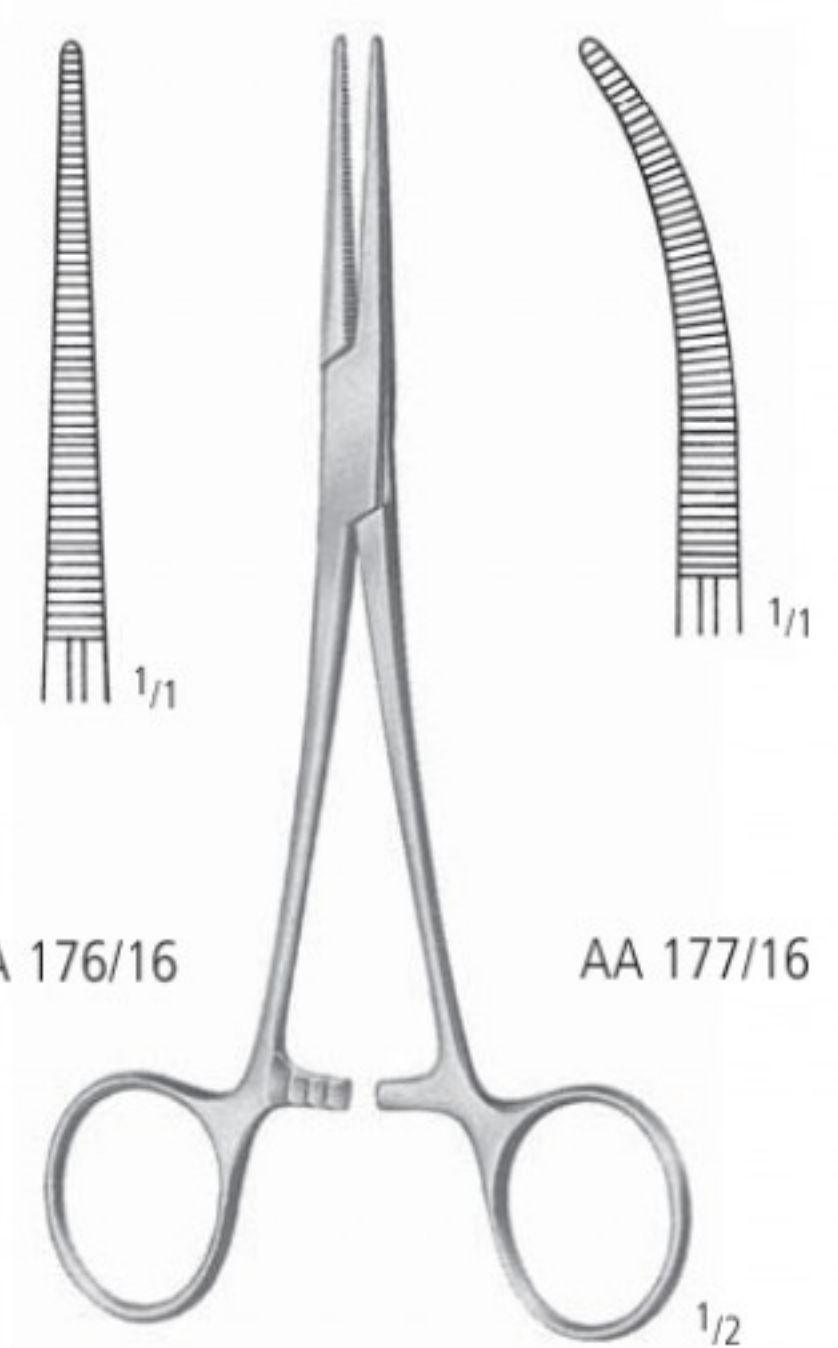

AA 176/16

AA 177/16

COLLER
 AA 176/14 14,0 cm/5¹/₂" AA 177/14
 AA 176/16 16,0 cm/6¹/₄" AA 177/16

KLEMMEN HEMOSTATS PINZAS HEMOSTATICAS PINCES HEMOSTATIQUES PINZE EMOSTATICHE

Arterienklemmen
 Artery Forceps
 Pinzas hemostáticas
 Pincas hémostatiques
 Pinze emostatiche

AA

AB

AC

AD

AE

AF

AK

AL

AO

AR

KA

KL

KU

PA

PB

PF

PI

PK

PL

PM

PP

PS

PT

PU

PV

KYE

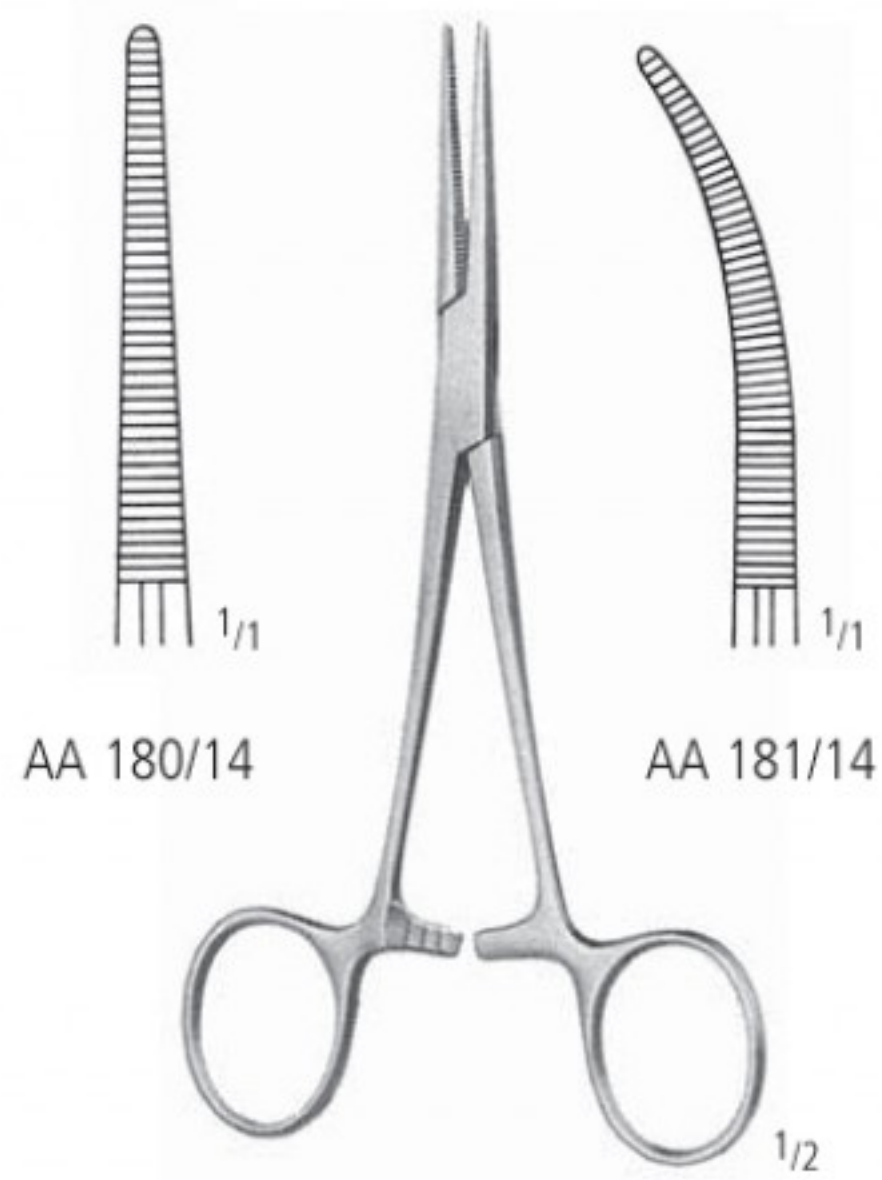

AA 180/14

AA 181/14

CRILE
 14,0 cm/5 1/2"

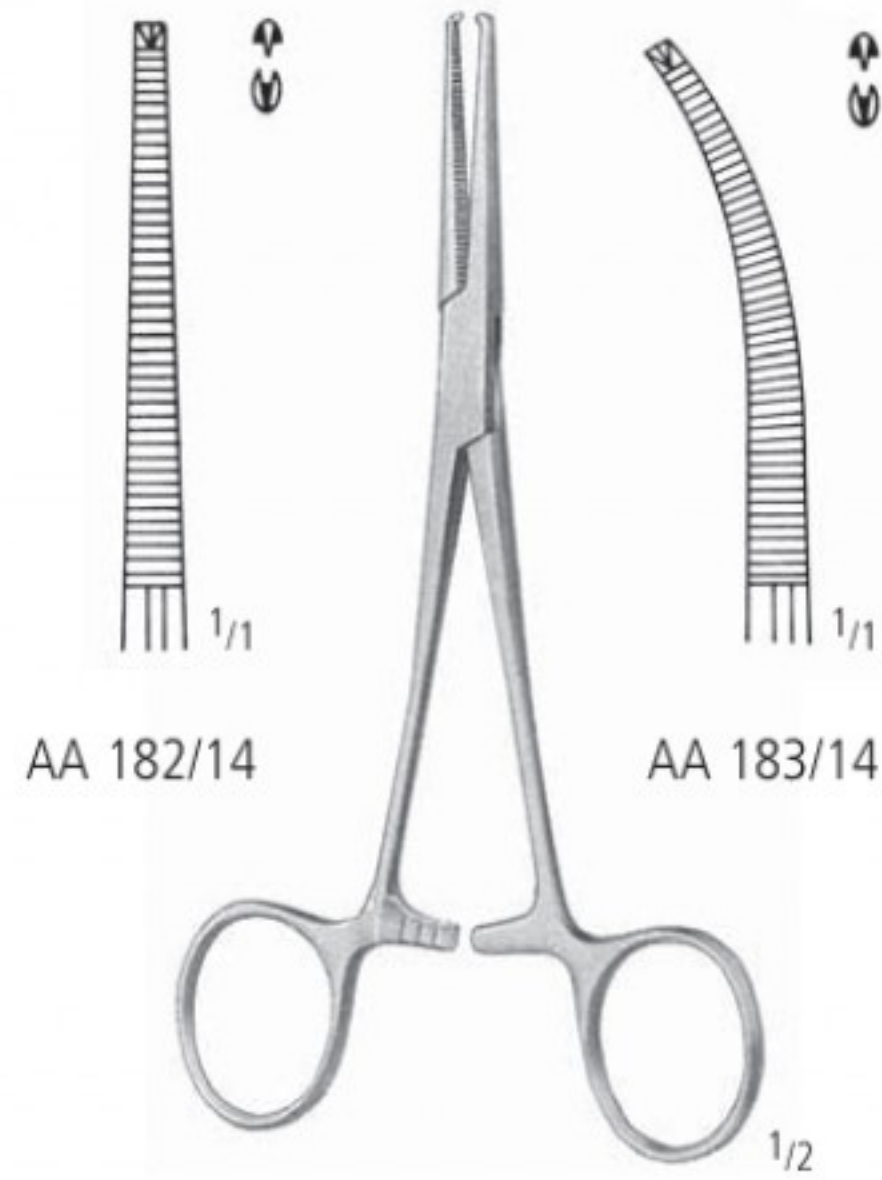

AA 182/14

AA 183/14

CRILE 1:2
 14,0 cm/5 1/2"

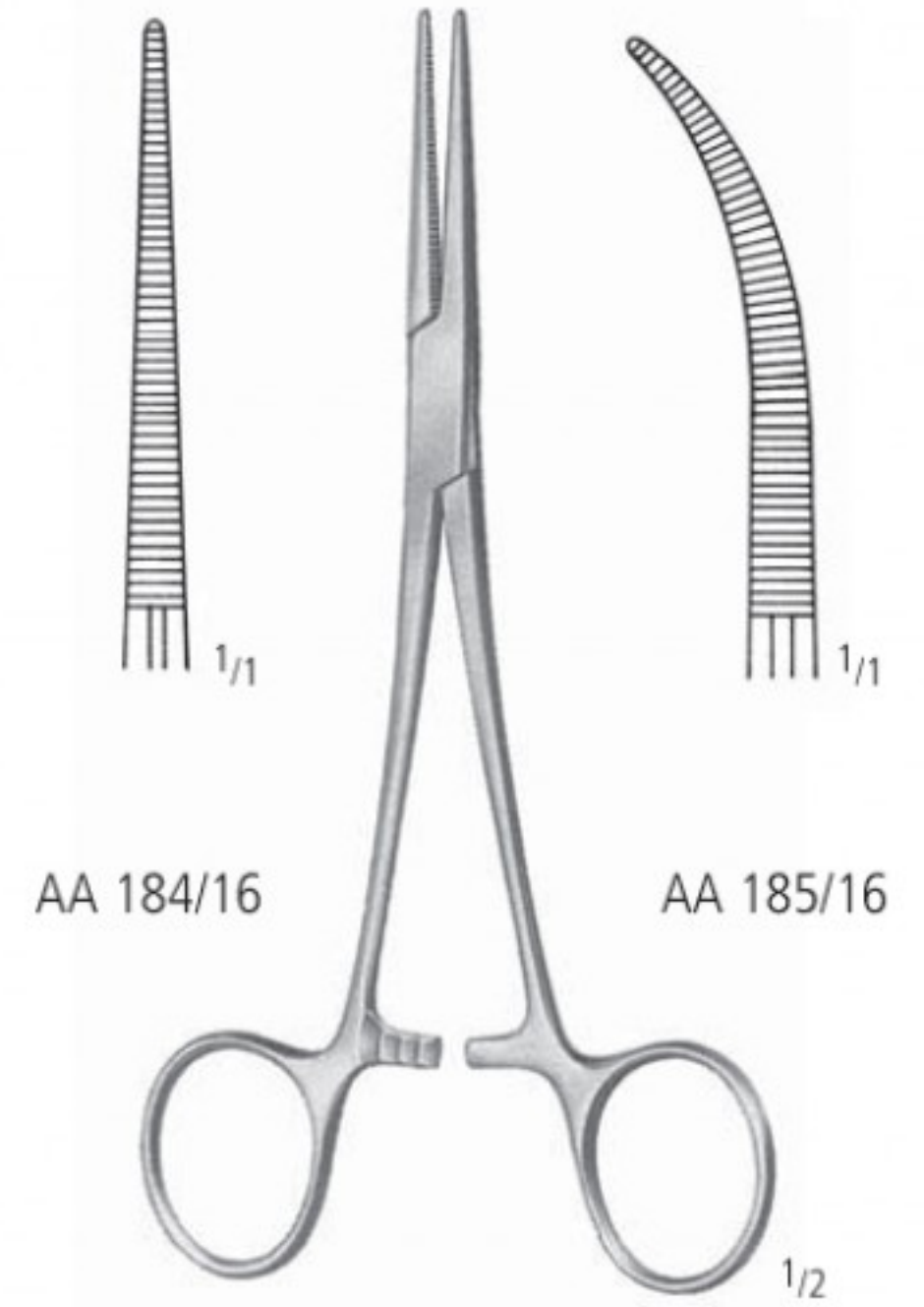

AA 184/16

AA 185/16

CRILE-RANKIN
 16,0 cm/6 1/4"



ROCHESTER-PEAN

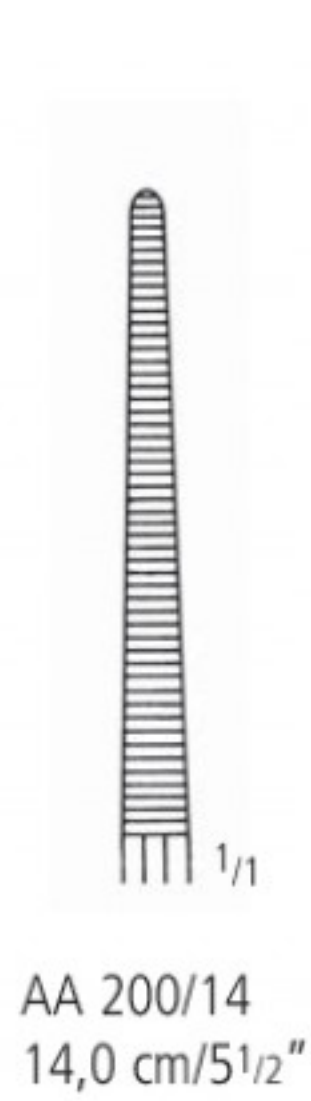

AA 200/14
 14,0 cm/5 1/2"

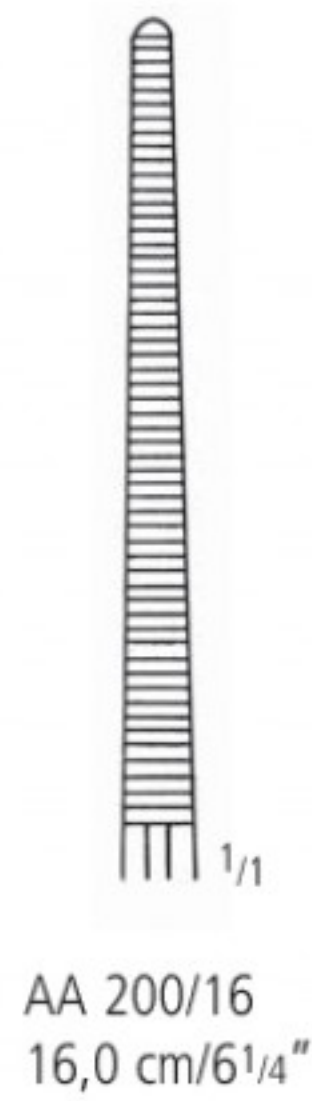

AA 200/16
 16,0 cm/6 1/4"



AA 201/14
 14,0 cm/5 1/2"

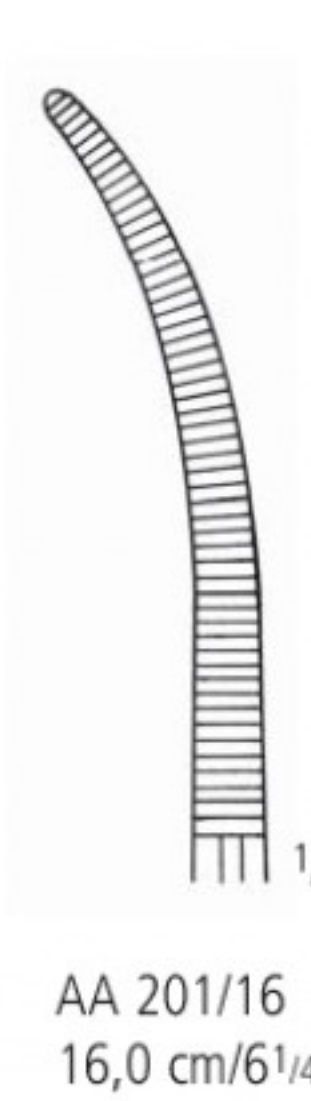

AA 201/16
 16,0 cm/6 1/4"

Arterienklemmen
 Artery Forceps
 Pinzas hemostáticas
 Pincas hémostatiques
 Pinze emostatiche



1/2

OCHSNER-KOCHER 1:2



AA 210/14
 14,0 cm/5 1/2"

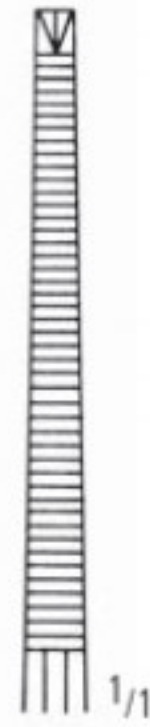

AA 210/16
 16,0 cm/6 1/4"

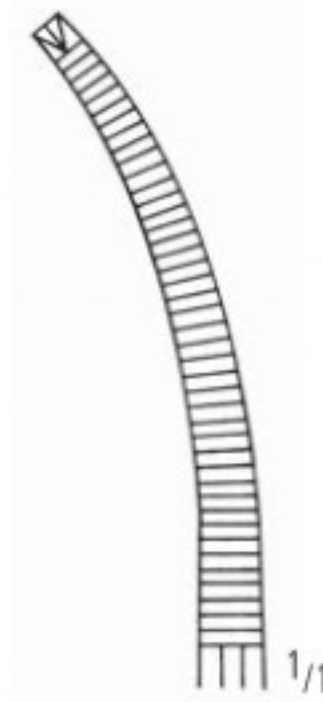

AA 211/14
 14,0 cm/5 1/2"

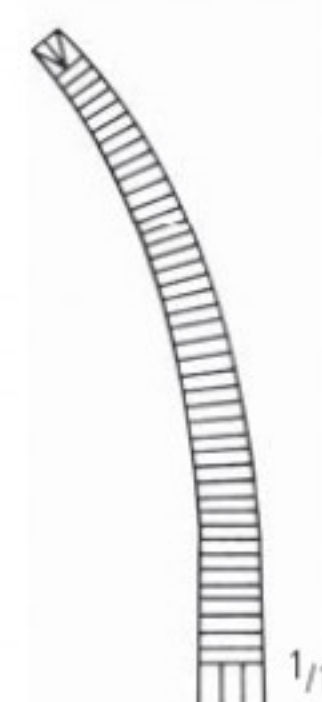

AA 211/16
 16,0 cm/6 1/4"

KLEMMEN HEMOSTATS PINZAS HEMOSTATICAS PINCES HEMOSTATIQUES PINZE EMOSTATICHE

Arterienklemmen, Grazile Arterienklemmen
 Artery Forceps, Delicate Artery Forceps
 Pinzas hemostáticas, Pinzas hemostáticas delgadas
 Pincés hémostatiques, Pincés hémostatiques graciles
 Pinze emostatiche, Pinze emostatiche delicate

AA
AB
AC
AD
AE
AF
AK
AL
AO
AR
KA
KL
KU
PA
PB
PF
PI
PK
PL
PM
PP
PS
PT
PU
PV
KYE

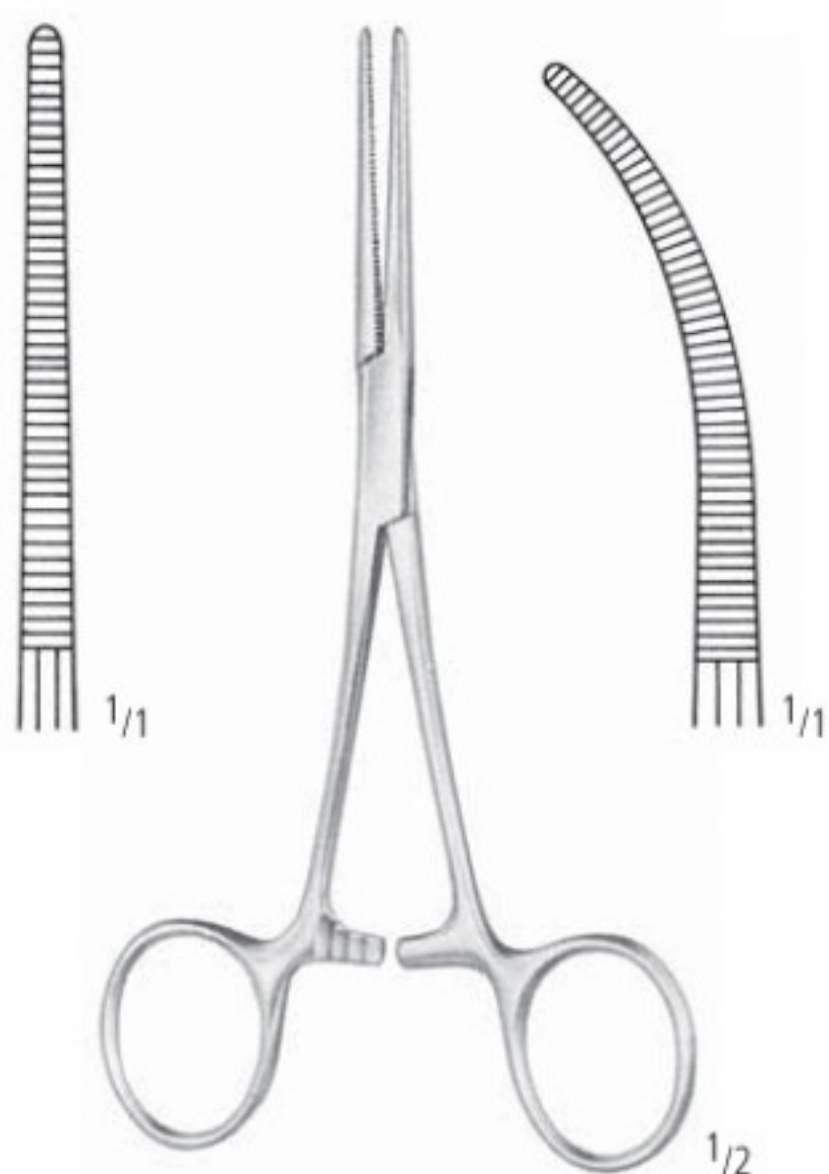

PEAN - DELICATE

- | | |
|-----------|-----------|
| AA 214/13 | AA 215/13 |
| AA 214/14 | AA 215/14 |
| AA 214/16 | AA 215/16 |

- | |
|----------------|
| 13,0 cm/5" |
| 14,0 cm/5 1/2" |
| 16,0 cm/6 1/4" |

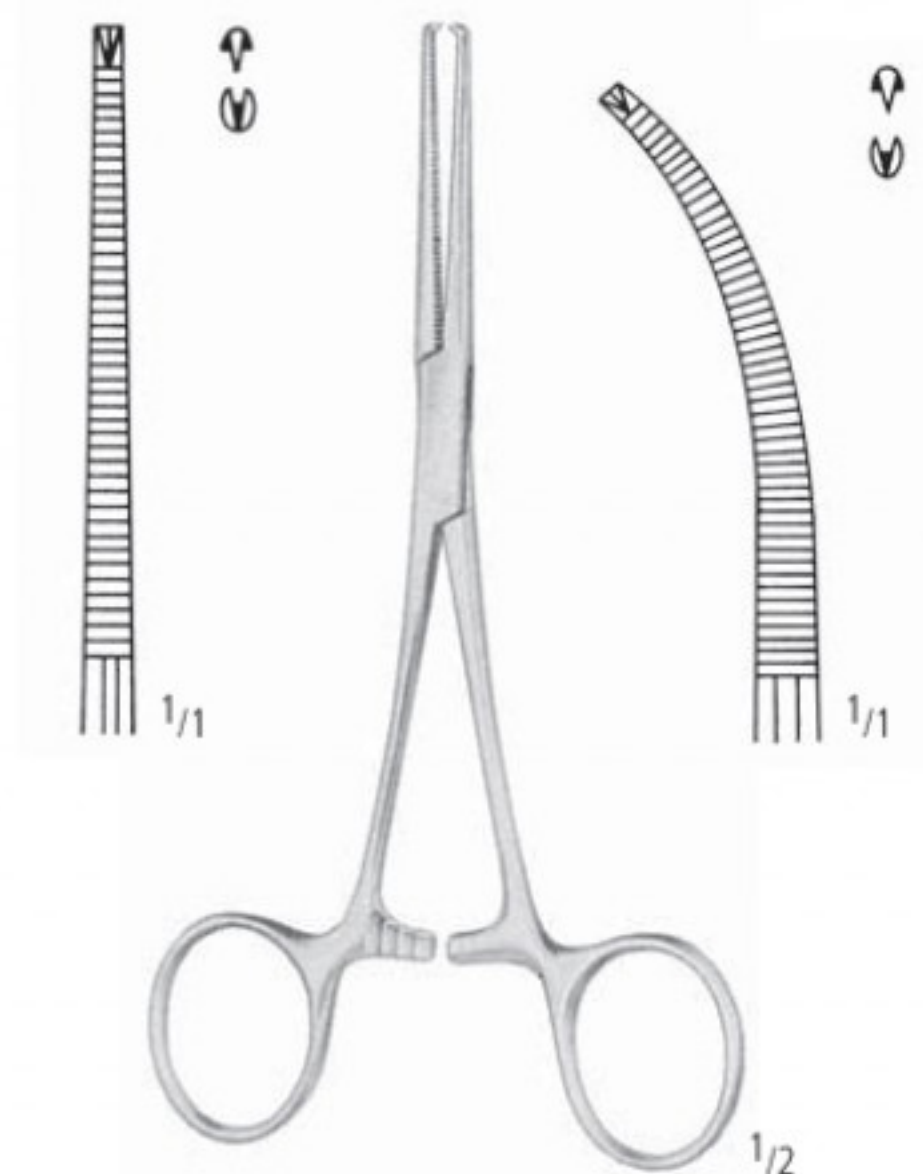

KOCHER 1:2 - DELICATE

- | | |
|-----------|-----------|
| AA 216/13 | AA 217/13 |
| AA 216/14 | AA 217/14 |
| AA 216/16 | AA 217/16 |



BABY-ADSON

- | |
|----------------|
| AA 235/14 |
| 14,0 cm/5 1/2" |



BABY-ADSON

- | |
|------------|
| AA 237/18 |
| 18,0 cm/7" |

Tuchklemmen
Towel Forceps
Pinzas para compresas, Pinzas de campo
Pincas à champs, Pincas à compresses
Pinze per fissare le compresse (Fissatele)



SCHAEDEL
AA 710/09
9,0 cm/3¹/₂"



JONES
5,0 cm/2"
9,0 cm/3¹/₂"
AA 711/05
AA 711/09



ENGL. MODELL
AA 717/09
9,0 cm/3¹/₂"



AA 749/11
11,0 cm/4¹/₂"

- >> mit Schlauch- oder Kabelhalter
- >> with Clip for Tubing or Cable
- >> con porta-tubo o porta-cable
- >> avec clamp porte-Tube ou porte-corton d'alimentation
- >> con porta tubo o porta cavo

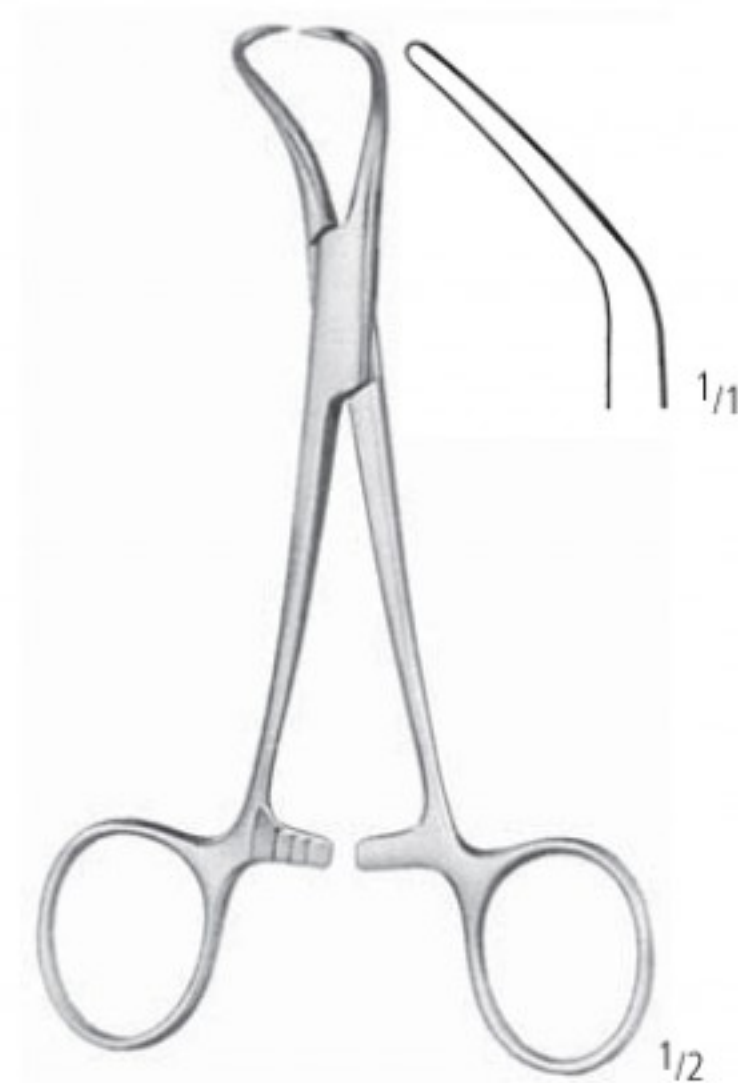

BACKHAUS
8,0 cm/3¹/₄" AA 751/08
11,0 cm/4¹/₂" AA 751/11
13,0 cm/5" AA 751/13
15,0 cm/6" AA 751/15

KLEMMEN HEMOSTATS PINZAS HEMOSTATICAS PINCES HEMOSTATIQUES PINZE EMOSTATICHE

Tuchklemmen
Towel Forceps
Pinzas para compresas, Pinzas de campo
Pinces à champs, Pinces à compresses
Pinze per fissare le compresse (Fissatele)

AA
AB
AC
AD
AE
AF
AK
AL
AO
AR
KA
KL
KU
PA
PB
PF
PI
PK
PL
PM
PP
PS
PT
PU
PV
KYE



BALL & SOCKET

11,0 cm/4³/₈" AA 753/11
13,0 cm/5" AA 753/13



ROEDER

13,0 cm/5" AA 761/13
15,0 cm/6" AA 761/15

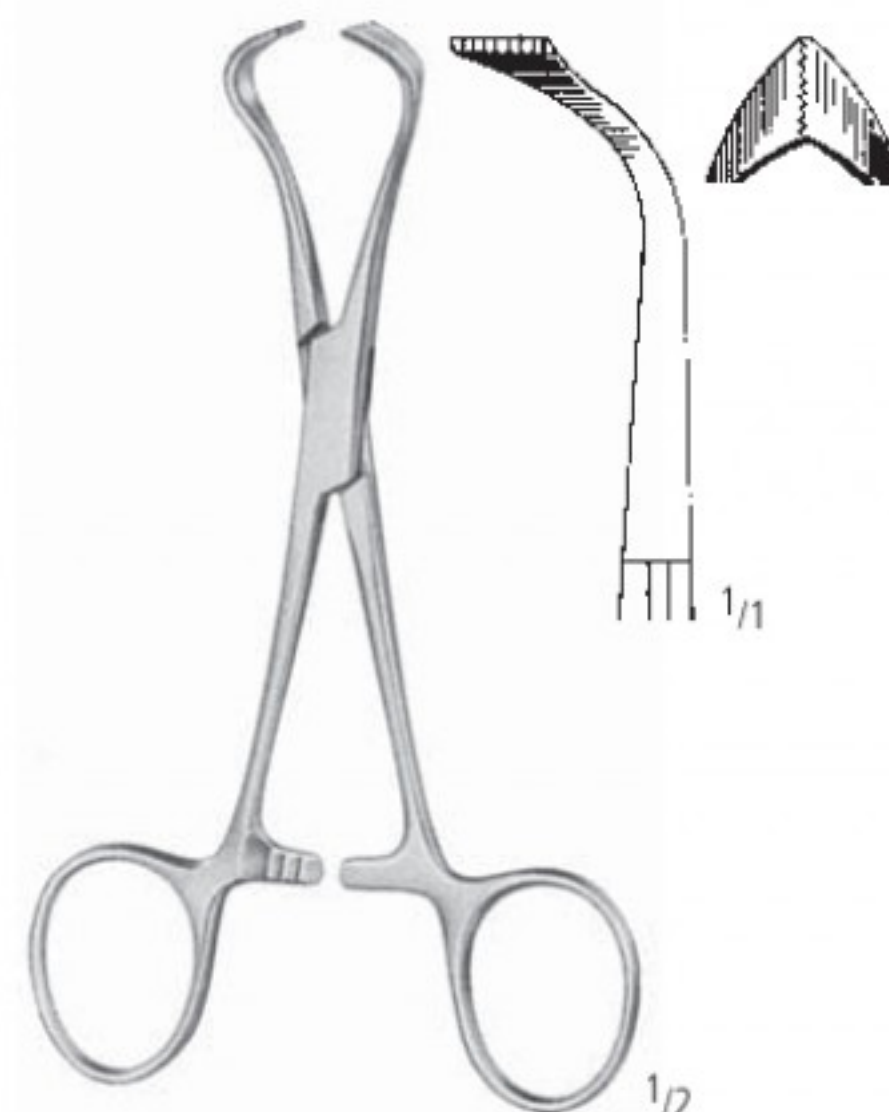

LORNA

10,0 cm/4" AA 763/10
13,0 cm/5" AA 763/13

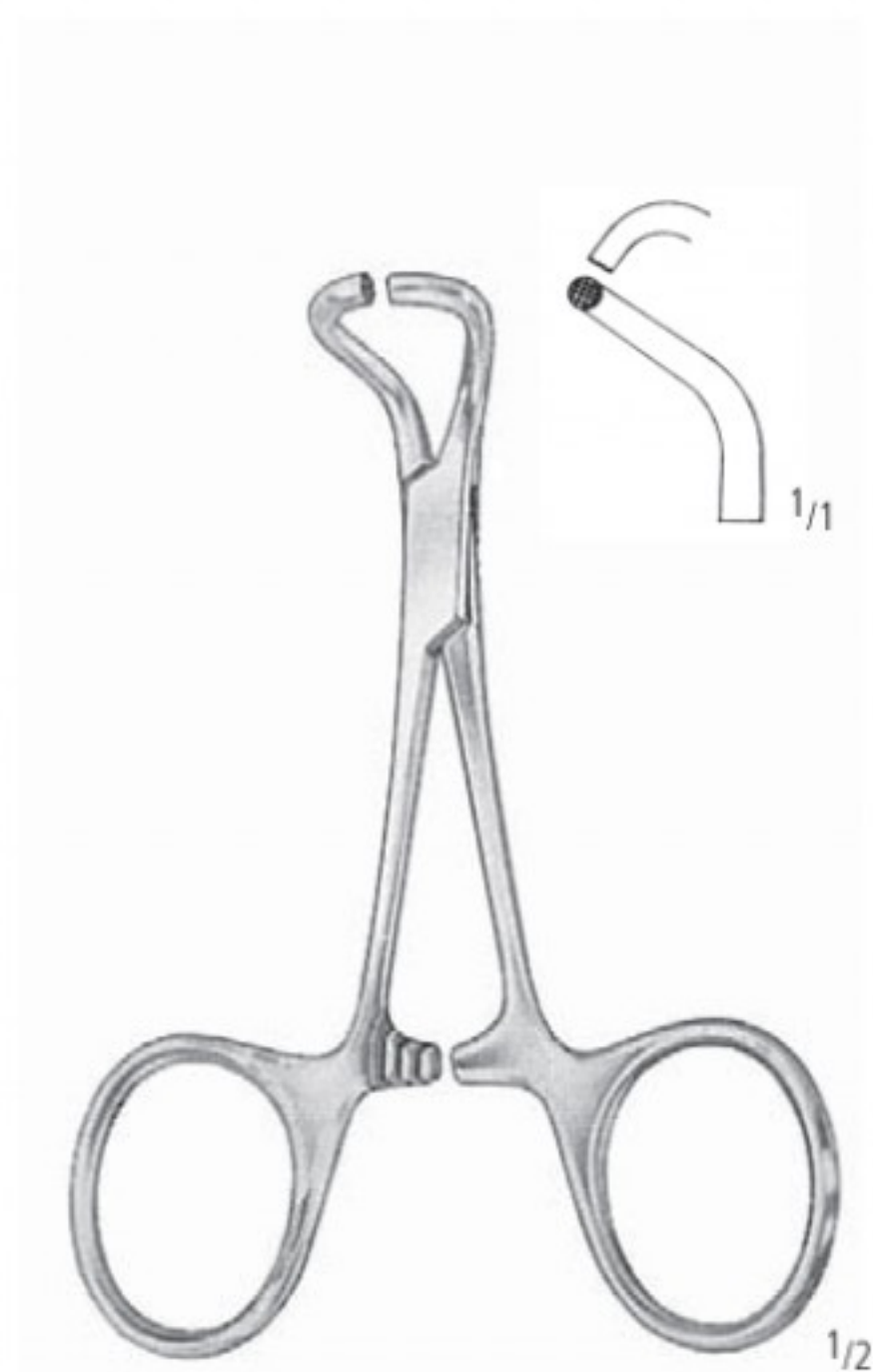

TOHOKU-JAPAN

10,0 cm/4" AA 764/10
13,0 cm/5" AA 764/13



PEERS

AA 765/14
14,5 cm/5³/₄"

- >> für Papiertücher
- >> for paper tissues
- >> para servilletas de papel
- >> pour serviettes en papier
- >> per tessuti di carta

PINZETTEN
FORCEPS
PINZAS
PINCES
PINZE

AB

nopa[®] instruments



PINZETTEN FORCEPS PINZAS PINCES PINZE

Anatomische Pinzetten, Chirurgische Pinzetten
 Dressing Forceps, Tissue Forceps
 Pinzas de disección, Pinzas de disección con dientes
 Pincés à dissection, Pincés à griffes
 Pinze anatomiche per dissezione, Pinze chirurgiche a denti di topo

AA
AB
 AC
 AD
 AE
 AF
 AK
 AL
 AO
 AR
 KA
 KL
 KU
 PA
 PB
 PF
 PI
 PK
 PL
 PM
 PP
 PS
 PT
 PU
 PV
 KYE



STANDARD



AB 050/10
 10,5 cm/4¹/₄"



AB 050/11
 11,5 cm/4¹/₂"



AB 050/13
 13,0 cm/5"

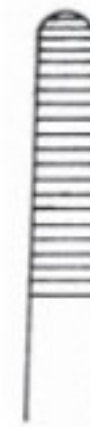

AB 050/14
 14,5 cm/5³/₄"



AB 050/16
 16,0 cm/6¹/₄"

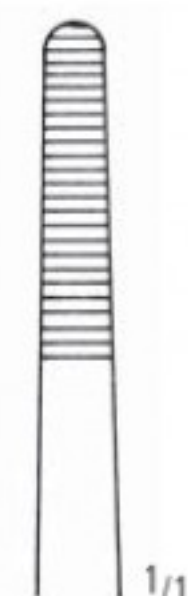

AB 050/18
 18,0 cm/7"

10,5 cm/4 ¹ / ₄ "	AB 050/10
11,5 cm/4 ¹ / ₂ "	AB 050/11
13,0 cm/5"	AB 050/13
14,5 cm/5 ³ / ₄ "	AB 050/14
16,0 cm/6 ¹ / ₄ "	AB 050/16
18,0 cm/7"	AB 050/18



STANDARD 1:2



AB 060/10
 10,5 cm/4¹/₄"



AB 060/11
 11,5 cm/4¹/₂"



AB 060/13
 13,0 cm/5"



AB 060/14
 14,5 cm/5³/₄"



AB 060/16
 16,0 cm/6¹/₄"

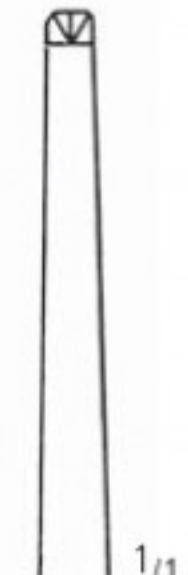

AB 060/18
 18,0 cm/7"

10,5 cm/4 ¹ / ₄ "	AB 060/10
11,5 cm/4 ¹ / ₂ "	AB 060/11
13,0 cm/5"	AB 060/13
14,5 cm/5 ³ / ₄ "	AB 060/14
16,0 cm/6 ¹ / ₄ "	AB 060/16
18,0 cm/7"	AB 060/18

AB PINZETTEN FORCEPS PINZAS PINCES PINZE

Anatomische Pinzetten, Chirurgische Pinzetten
 Dressing Forceps, Tissue Forceps
 Pinzas de disección, Pinzas de disección con dientes
 Pincès à dissection, Pincès à griffes
 Pinze anatomiche per dissezione, Pinze chirurgiche a denti di topo

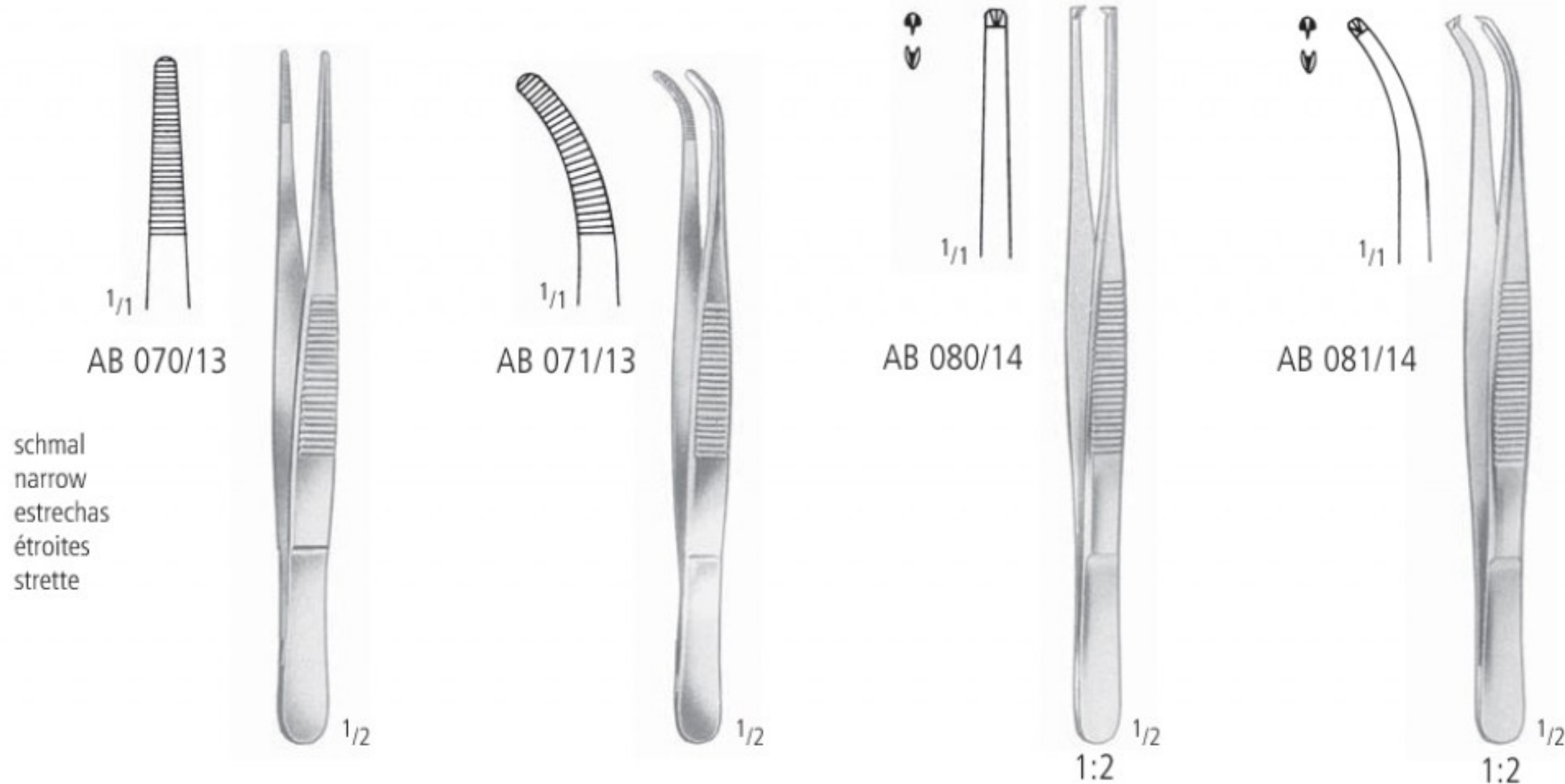

schmal
 narrow
 estrechas
 étroites
 strette

-----schmal >> narrow >> estrechas >> étroites >> strette -----

10,5 cm/4 ¹ / ₄ "	AB 070/10	AB 071/10	AB 080/10	AB 081/10
11,5 cm/4 ¹ / ₂ "	AB 070/11	AB 071/11	AB 080/11	AB 081/11
13,0 cm/5"	AB 070/13	AB 071/13	AB 080/13	AB 081/13
14,5 cm/5 ³ / ₄ "	AB 070/14	AB 071/14	AB 080/14	AB 081/14
16,0 cm/6 ¹ / ₄ "	AB 070/16	AB 071/16	AB 080/16	AB 081/16
18,0 cm/7"	AB 070/18	AB 071/18	AB 080/18	AB 081/18
20,0 cm/8"	AB 070/20	AB 071/20	AB 080/20	AB 081/20
23,0 cm/9"	AB 070/23		AB 080/23	
25,0 cm/10"	AB 070/25	AB 071/25	AB 080/25	AB 081/25
30,0 cm/12"	AB 070/30	AB 071/30	AB 080/30	AB 081/30

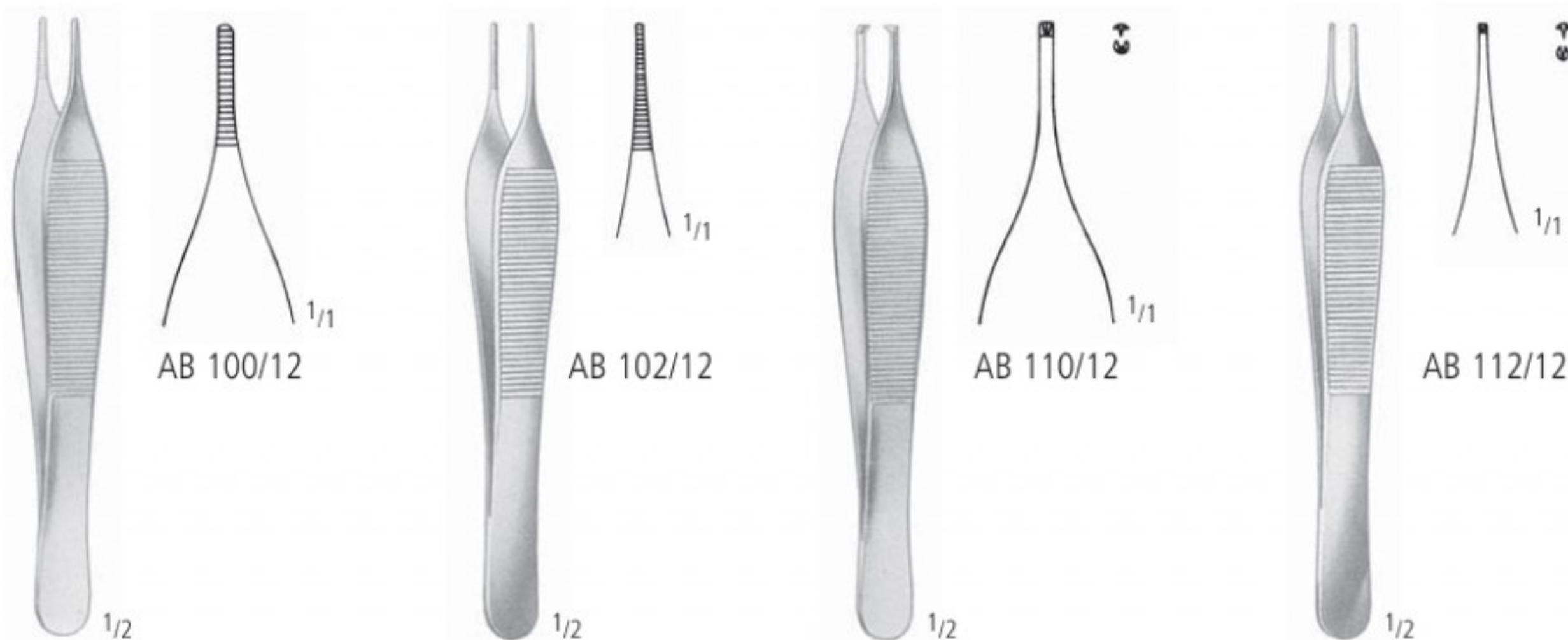

12,0 cm/4 ³ / ₄ "	ADSON AB 100/12	MICRO-ADSON AB 102/12	ADSON 1:2 AB 110/12	MICRO-ADSON 1:2 AB 112/12
15,0 cm/6"	AB 100/15	AB 102/15	AB 110/15	AB 112/15

PINZETTEN FORCEPS PINZAS PINCES PINZE

Anatomische Pinzetten, Chirurgische Pinzetten
 Dressing Forceps, Tissue Forceps
 Pinzas de disección, Pinzas de disección con dientes
 Pincès à dissection, Pincès à griffes
 Pinze anatomiche per dissezione, Pinze chirurgiche a denti di topo

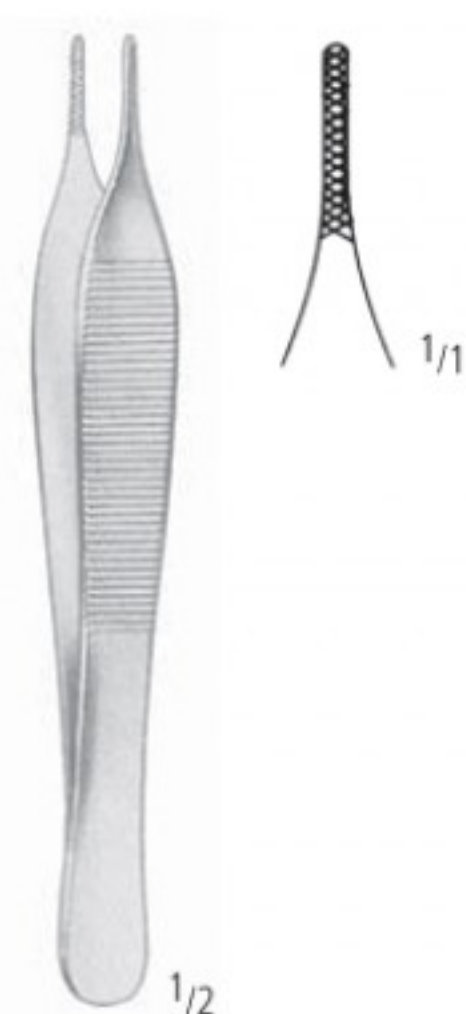

ADSON
 AB 114/12
 12,0 cm/4³/₄"

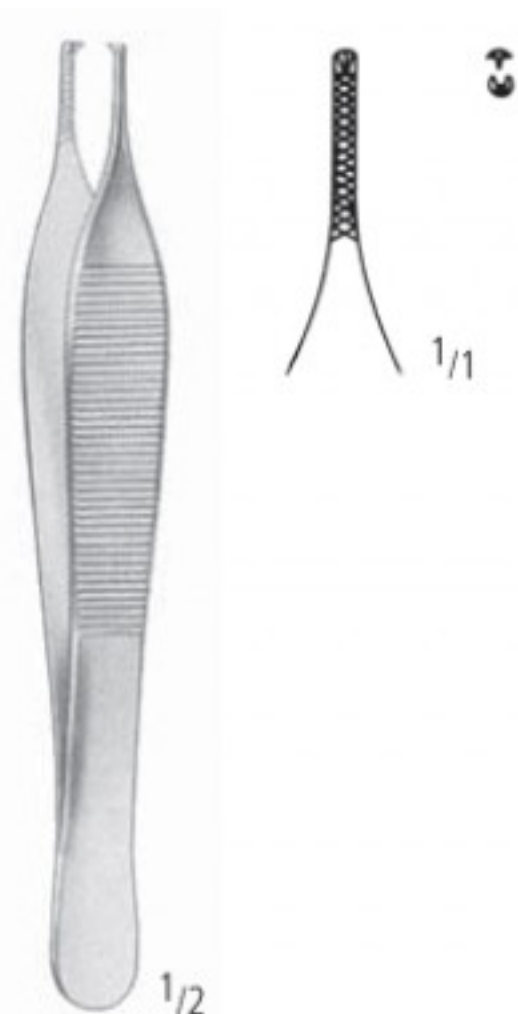

ADSON 1:2
 AB 115/12
 12,0 cm/4³/₄"

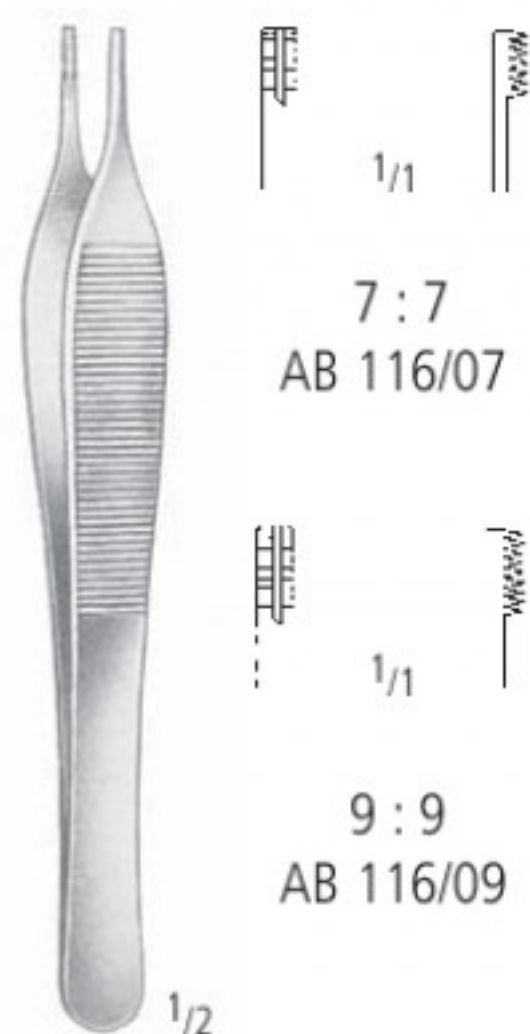

ADSON-BROWN
 12,0 cm/4³/₄"



ADSON-BROWN
 AB 117/09
 12,0 cm/4³/₄"

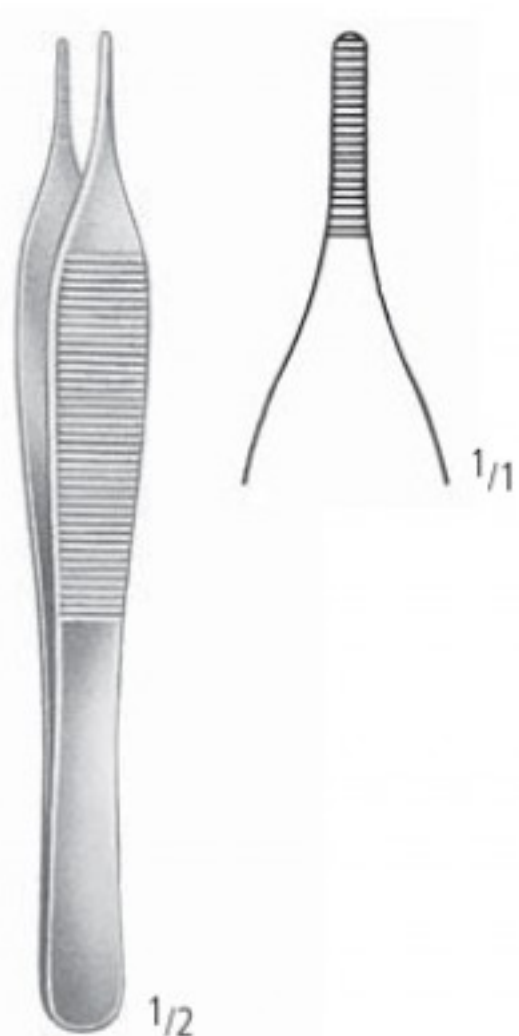

EWALD
 AB 118/01
 12,0 cm/4³/₄"

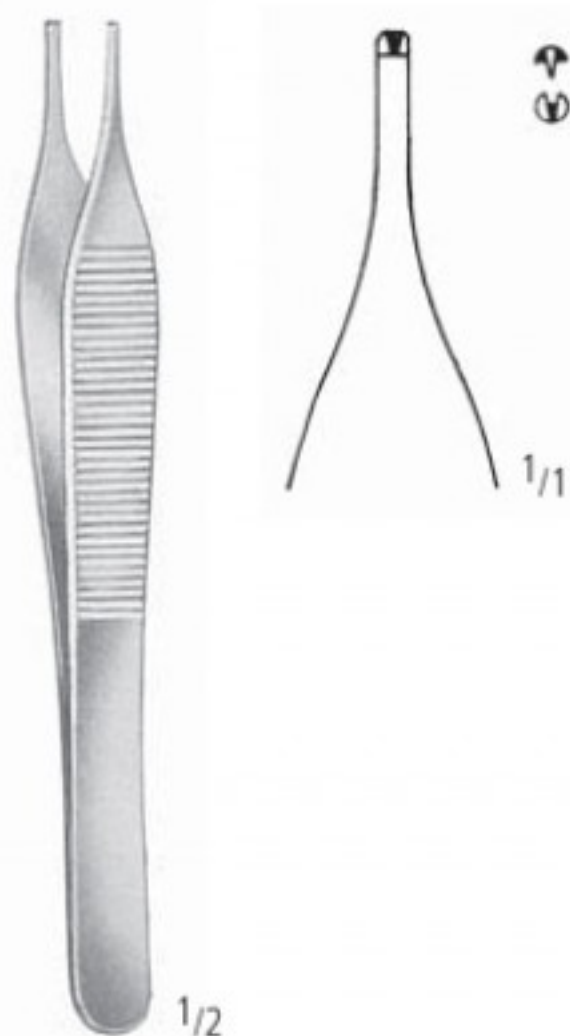

EWALD 1:2
 AB 118/02
 12,0 cm/4³/₄"



McINDOE
 AB 119/15
 15,0 cm/6"



SEMKEN
 AB 120/12
 AB 120/15

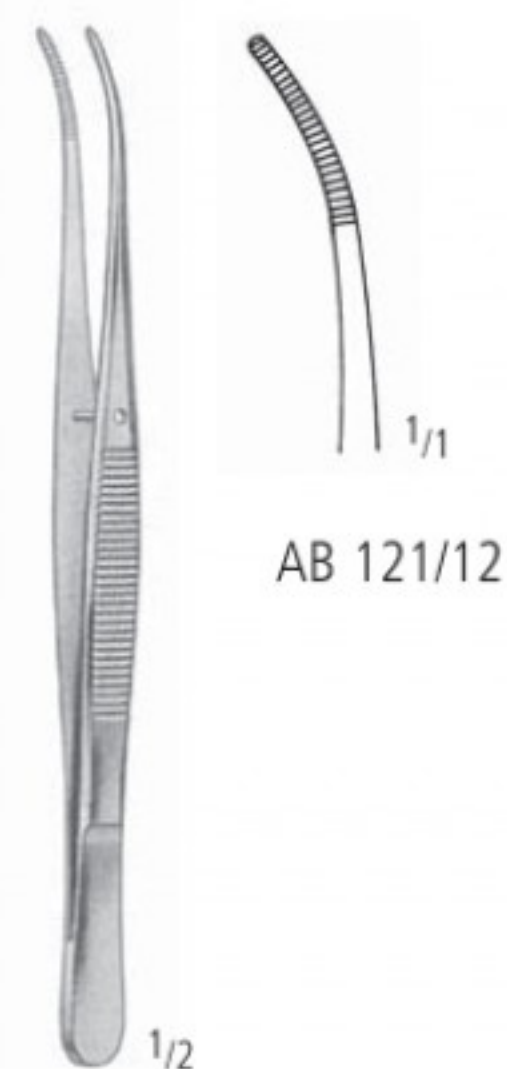

SEMKEN
 12,5 cm/5"
 15,5 cm/6"
 AB 121/12
 AB 121/15

AA
 AB
 AC
 AD
 AE
 AF
 AG
 AH
 AI
 AJ
 AK
 AL
 AM
 AN
 AO
 AP
 AQ
 AR
 AS
 AT
 AU
 AV
 AW
 AX
 AY
 AZ
 BA
 BB
 BC
 BD
 BE
 BF
 BG
 BH
 BI
 BJ
 BK
 BL
 BM
 BN
 BO
 BP
 BQ
 BR
 BS
 BT
 BU
 BV
 BW
 BX
 BY
 BZ
 CA
 CB
 CC
 CD
 CE
 CF
 CG
 CH
 CI
 CJ
 CK
 CL
 CM
 CN
 CO
 CP
 CQ
 CR
 CS
 CT
 CU
 CV
 CW
 CX
 CY
 CZ
 DA
 DB
 DC
 DD
 DE
 DF
 DG
 DH
 DI
 DJ
 DK
 DL
 DM
 DN
 DO
 DP
 DQ
 DR
 DS
 DT
 DU
 DV
 DW
 DX
 DY
 DZ
 EA
 EB
 EC
 ED
 EE
 EF
 EG
 EH
 EI
 EJ
 EK
 EL
 EM
 EN
 EO
 EP
 EQ
 ER
 ES
 ET
 EU
 EV
 EW
 EX
 EY
 EZ
 FA
 FB
 FC
 FD
 FE
 FF
 FG
 FH
 FI
 FJ
 FK
 FL
 FM
 FN
 FO
 FP
 FQ
 FR
 FS
 FT
 FU
 FV
 FW
 FX
 FY
 FZ
 GA
 GB
 GC
 GD
 GE
 GF
 GG
 GH
 GI
 GJ
 GK
 GL
 GM
 GN
 GO
 GP
 GQ
 GR
 GS
 GT
 GU
 GV
 GW
 GX
 GY
 GZ
 HA
 HB
 HC
 HD
 HE
 HF
 HG
 HH
 HI
 HJ
 HK
 HL
 HM
 HN
 HO
 HP
 HQ
 HR
 HS
 HT
 HU
 HV
 HW
 HX
 HY
 HZ
 IA
 IB
 IC
 ID
 IE
 IF
 IG
 IH
 II
 IJ
 IK
 IL
 IM
 IN
 IO
 IP
 IQ
 IR
 IS
 IT
 IU
 IV
 IW
 IX
 IY
 IZ
 JA
 JB
 JC
 JD
 JE
 JF
 JG
 JH
 JI
 JJ
 JK
 JL
 JM
 JN
 JO
 JP
 JQ
 JR
 JS
 JT
 JU
 JV
 JW
 JX
 JY
 JZ
 KA
 KB
 KC
 KD
 KE
 KF
 KG
 KH
 KI
 KJ
 KK
 KL
 KM
 KN
 KO
 KP
 KQ
 KR
 KS
 KT
 KU
 KV
 KW
 KX
 KY
 KZ
 LA
 LB
 LC
 LD
 LE
 LF
 LG
 LH
 LI
 LJ
 LK
 LL
 LM
 LN
 LO
 LP
 LQ
 LR
 LS
 LT
 LU
 LV
 LW
 LX
 LY
 LZ
 MA
 MB
 MC
 MD
 ME
 MF
 MG
 MH
 MI
 MJ
 MK
 ML
 MM
 MN
 MO
 MP
 MQ
 MR
 MS
 MT
 MU
 MV
 MW
 MX
 MY
 MZ
 NA
 NB
 NC
 ND
 NE
 NF
 NG
 NH
 NI
 NJ
 NK
 NL
 NM
 NN
 NO
 NP
 NQ
 NR
 NS
 NT
 NU
 NV
 NW
 NX
 NY
 NZ
 OA
 OB
 OC
 OD
 OE
 OF
 OG
 OH
 OI
 OJ
 OK
 OL
 OM
 ON
 OO
 OP
 OQ
 OR
 OS
 OT
 OU
 OV
 OW
 OX
 OY
 OZ
 PA
 PB
 PC
 PD
 PE
 PF
 PG
 PH
 PI
 PJ
 PK
 PL
 PM
 PN
 PO
 PP
 PQ
 PR
 PS
 PT
 PU
 PV
 PW
 PX
 PY
 PZ
 QA
 QB
 QC
 QD
 QE
 QF
 QG
 QH
 QI
 QJ
 QK
 QL
 QM
 QN
 QO
 QP
 QQ
 QR
 QS
 QT
 QU
 QV
 QW
 QX
 QY
 QZ
 RA
 RB
 RC
 RD
 RE
 RF
 RG
 RH
 RI
 RJ
 RK
 RL
 RM
 RN
 RO
 RP
 RQ
 RR
 RS
 RT
 RU
 RV
 RW
 RX
 RY
 RZ
 SA
 SB
 SC
 SD
 SE
 SF
 SG
 SH
 SI
 SJ
 SK
 SL
 SM
 SN
 SO
 SP
 SQ
 SR
 SS
 ST
 SU
 SV
 SW
 SX
 SY
 SZ
 TA
 TB
 TC
 TD
 TE
 TF
 TG
 TH
 TI
 TJ
 TK
 TL
 TM
 TN
 TO
 TP
 TQ
 TR
 TS
 TT
 TU
 TV
 TW
 TX
 TY
 TZ
 UA
 UB
 UC
 UD
 UE
 UF
 UG
 UH
 UI
 UJ
 UK
 UL
 UM
 UN
 UO
 UP
 UQ
 UR
 US
 UT
 UY
 UZ
 VA
 VB
 VC
 VD
 VE
 VF
 VG
 VH
 VI
 VJ
 VK
 VL
 VM
 VN
 VO
 VP
 VQ
 VR
 VS
 VT
 VU
 VV
 VW
 VX
 VY
 VZ
 WA
 WB
 WC
 WD
 WE
 WF
 WG
 WH
 WI
 WJ
 WK
 WL
 WM
 WN
 WO
 WP
 WQ
 WR
 WS
 WT
 WU
 WV
 WW
 WX
 WY
 WZ
 XA
 XB
 XC
 XD
 XE
 XF
 XG
 XH
 XI
 XJ
 XK
 XL
 XM
 XN
 XO
 XP
 XQ
 XR
 XS
 XT
 XU
 XV
 XW
 XX
 XY
 XZ
 YA
 YB
 YC
 YD
 YE
 YF
 YG
 YH
 YI
 YJ
 YK
 YL
 YM
 YN
 YO
 YP
 YQ
 YR
 YS
 YT
 YU
 YV
 YW
 YX
 YZ
 ZA
 ZB
 ZC
 ZD
 ZE
 ZF
 ZG
 ZH
 ZI
 ZJ
 ZK
 ZL
 ZM
 ZN
 ZO
 ZP
 ZQ
 ZR
 ZS
 ZT
 ZU
 ZV
 ZW
 ZX
 ZY
 ZZ

AB PINZETTEN FORCEPS PINZAS PINCES PINZE

Anatomische Pinzetten, Chirurgische Pinzetten
 Dressing Forceps, Tissue Forceps
 Pinzas de disección, Pinzas de disección con dientes
 Pincés à dissection, Pincés à griffes
 Pinze anatomiche per dissezione, Pinze chirurgiche a denti di topo



AB 130/12

AB 130/12
 AB 130/15

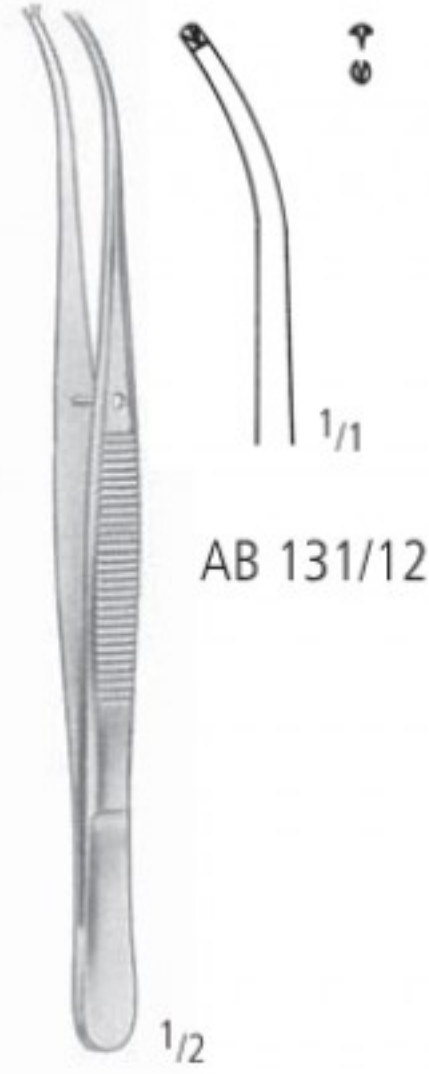

AB 131/12

AB 131/12
 AB 131/15

SEMKEN 1:2
 12,5 cm/5"
 15,5 cm/6"



TAYLOR
 AB 140/17
 17,5 cm/7"



TAYLOR
 AB 141/17
 17,5 cm/7"



TAYLOR
 AB 142/17
 17,5 cm/7"



TAYLOR
 AB 143/17
 17,5 cm/7"



TAYLOR 1:2
 AB 150/17
 17,5 cm/7"



TAYLOR 1:2
 AB 151/17
 17,5 cm/7"



TAYLOR 1:2
 AB 152/17
 17,5 cm/7"



TAYLOR 1:2
 AB 153/17
 17,5 cm/7"

PINZETTEN FORCEPS PINZAS PINCES PINZE

Anatomische Pinzetten, Chirurgische Pinzetten
 Dressing Forceps, Tissue Forceps
 Pinzas de disección, Pinzas de disección con dientes
 Pincés à dissection, Pincés à griffes
 Pinze anatomiche per dissezione, Pinze chirurgiche a denti di topo

AA
AB
 AC
 AD
 AE
 AF
 AG
 AH
 AI
 AJ
 AK
 AL
 AM
 AN
 AO
 AP
 AQ
 AR
 AS
 AT
 AU
 AV
 AW
 AX
 AY
 AZ
 BA
 BB
 BC
 BD
 BE
 BF
 BG
 BH
 BI
 BJ
 BK
 BL
 BM
 BN
 BO
 BP
 BQ
 BR
 BS
 BT
 BU
 BV
 BW
 BX
 BY
 BZ
 CA
 CB
 CC
 CD
 CE
 CF
 CG
 CH
 CI
 CJ
 CK
 CL
 CM
 CN
 CO
 CP
 CQ
 CR
 CS
 CT
 CU
 CV
 CW
 CX
 CY
 CZ
 DA
 DB
 DC
 DD
 DE
 DF
 DG
 DH
 DI
 DJ
 DK
 DL
 DM
 DN
 DO
 DP
 DQ
 DR
 DS
 DT
 DU
 DV
 DW
 DX
 DY
 DZ
 EA
 EB
 EC
 ED
 EE
 EF
 EG
 EH
 EI
 EJ
 EK
 EL
 EM
 EN
 EO
 EP
 EQ
 ER
 ES
 ET
 EU
 EV
 EW
 EX
 EY
 EZ
 FA
 FB
 FC
 FD
 FE
 FF
 FG
 FH
 FI
 FJ
 FK
 FL
 FM
 FN
 FO
 FP
 FQ
 FR
 FS
 FT
 FU
 FV
 FW
 FX
 FY
 FZ
 GA
 GB
 GC
 GD
 GE
 GF
 GG
 GH
 GI
 GJ
 GK
 GL
 GM
 GN
 GO
 GP
 GQ
 GR
 GS
 GT
 GU
 GV
 GW
 GX
 GY
 GZ
 HA
 HB
 HC
 HD
 HE
 HF
 HG
 HH
 HI
 HJ
 HK
 HL
 HM
 HN
 HO
 HP
 HQ
 HR
 HS
 HT
 HU
 HV
 HW
 HX
 HY
 HZ
 IA
 IB
 IC
 ID
 IE
 IF
 IG
 IH
 II
 IJ
 IK
 IL
 IM
 IN
 IO
 IP
 IQ
 IR
 IS
 IT
 IU
 IV
 IW
 IX
 IY
 IZ
 JA
 JB
 JC
 JD
 JE
 JF
 JG
 JH
 JI
 JJ
 JK
 JL
 JM
 JN
 JO
 JP
 JQ
 JR
 JS
 JT
 JU
 JV
 JW
 JX
 JY
 JZ
 KA
 KB
 KC
 KD
 KE
 KF
 KG
 KH
 KI
 KJ
 KK
 KL
 KM
 KN
 KO
 KP
 KQ
 KR
 KS
 KT
 KU
 KV
 KW
 KX
 KY
 KZ
 LA
 LB
 LC
 LD
 LE
 LF
 LG
 LH
 LI
 LJ
 LK
 LL
 LM
 LN
 LO
 LP
 LQ
 LR
 LS
 LT
 LU
 LV
 LW
 LX
 LY
 LZ
 MA
 MB
 MC
 MD
 ME
 MF
 MG
 MH
 MI
 MJ
 MK
 ML
 MM
 MN
 MO
 MP
 MQ
 MR
 MS
 MT
 MU
 MV
 MW
 MX
 MY
 MZ
 NA
 NB
 NC
 ND
 NE
 NF
 NG
 NH
 NI
 NJ
 NK
 NL
 NM
 NN
 NO
 NP
 NQ
 NR
 NS
 NT
 NU
 NV
 NW
 NX
 NY
 NZ
 OA
 OB
 OC
 OD
 OE
 OF
 OG
 OH
 OI
 OJ
 OK
 OL
 OM
 ON
 OO
 OP
 OQ
 OR
 OS
 OT
 OU
 OV
 OW
 OX
 OY
 OZ
 PA
 PB
 PC
 PD
 PE
 PF
 PG
 PH
 PI
 PJ
 PK
 PL
 PM
 PN
 PO
 PP
 PQ
 PR
 PS
 PT
 PU
 PV
 PW
 PX
 PY
 PZ
 QA
 QB
 QC
 QD
 QE
 QF
 QG
 QH
 QI
 QJ
 QK
 QL
 QM
 QN
 QO
 QP
 QQ
 QR
 QS
 QT
 QU
 QV
 QW
 QX
 QY
 QZ
 RA
 RB
 RC
 RD
 RE
 RF
 RG
 RH
 RI
 RJ
 RK
 RL
 RM
 RN
 RO
 RP
 RQ
 RR
 RS
 RT
 RU
 RV
 RW
 RX
 RY
 RZ
 SA
 SB
 SC
 SD
 SE
 SF
 SG
 SH
 SI
 SJ
 SK
 SL
 SM
 SN
 SO
 SP
 SQ
 SR
 SS
 ST
 SU
 SV
 SW
 SX
 SY
 SZ
 TA
 TB
 TC
 TD
 TE
 TF
 TG
 TH
 TI
 TJ
 TK
 TL
 TM
 TN
 TO
 TP
 TQ
 TR
 TS
 TT
 TU
 TV
 TW
 TX
 TY
 TZ
 UA
 UB
 UC
 UD
 UE
 UF
 UG
 UH
 UI
 UJ
 UK
 UL
 UM
 UN
 UO
 UP
 UQ
 UR
 US
 UT
 UY
 UZ
 VA
 VB
 VC
 VD
 VE
 VF
 VG
 VH
 VI
 VJ
 VK
 VL
 VM
 VN
 VO
 VP
 VQ
 VR
 VS
 VT
 VY
 VZ
 WA
 WB
 WC
 WD
 WE
 WF
 WG
 WH
 WI
 WJ
 WK
 WL
 WM
 WN
 WO
 WP
 WQ
 WR
 WS
 WT
 WY
 WZ
 XA
 XB
 XC
 XD
 XE
 XF
 XG
 XH
 XI
 XJ
 XK
 XL
 XM
 XN
 XO
 XP
 XQ
 XR
 XS
 XT
 XY
 XZ
 YA
 YB
 YC
 YD
 YE
 YF
 YG
 YH
 YI
 YJ
 YK
 YL
 YM
 YN
 YO
 YP
 YQ
 YR
 YS
 YT
 YZ
 ZA
 ZB
 ZC
 ZD
 ZE
 ZF
 ZG
 ZH
 ZI
 ZJ
 ZK
 ZL
 ZM
 ZN
 ZO
 ZP
 ZQ
 ZR
 ZS
 ZT
 ZY
 ZZ



AB 160/18

GERALD
18,0 cm/7"

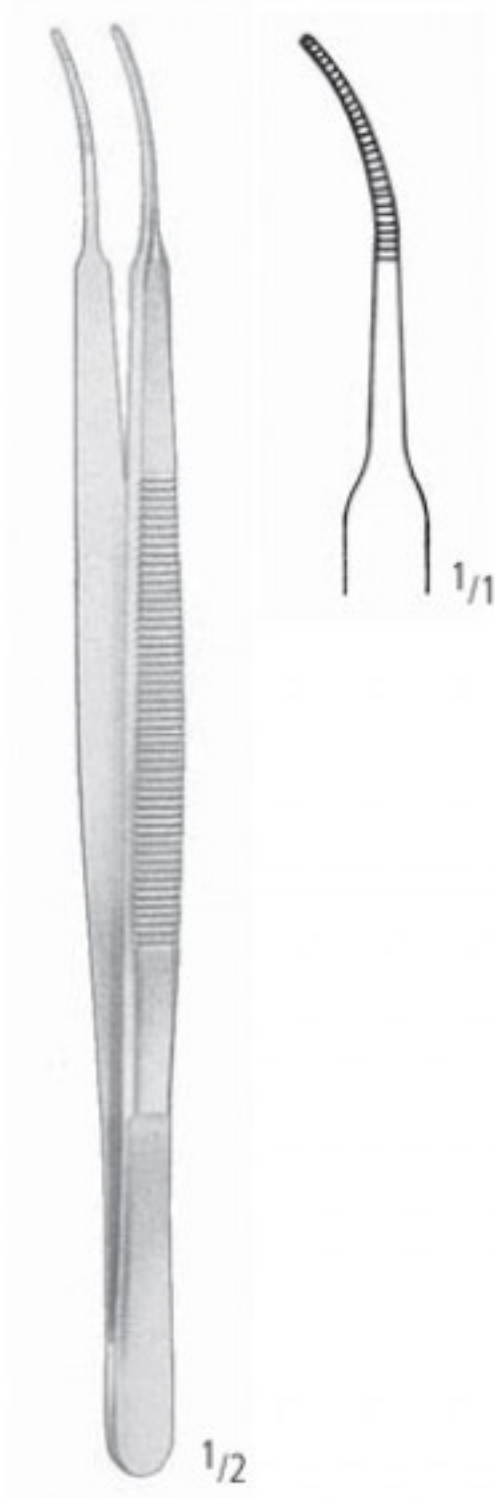

AB 161/18

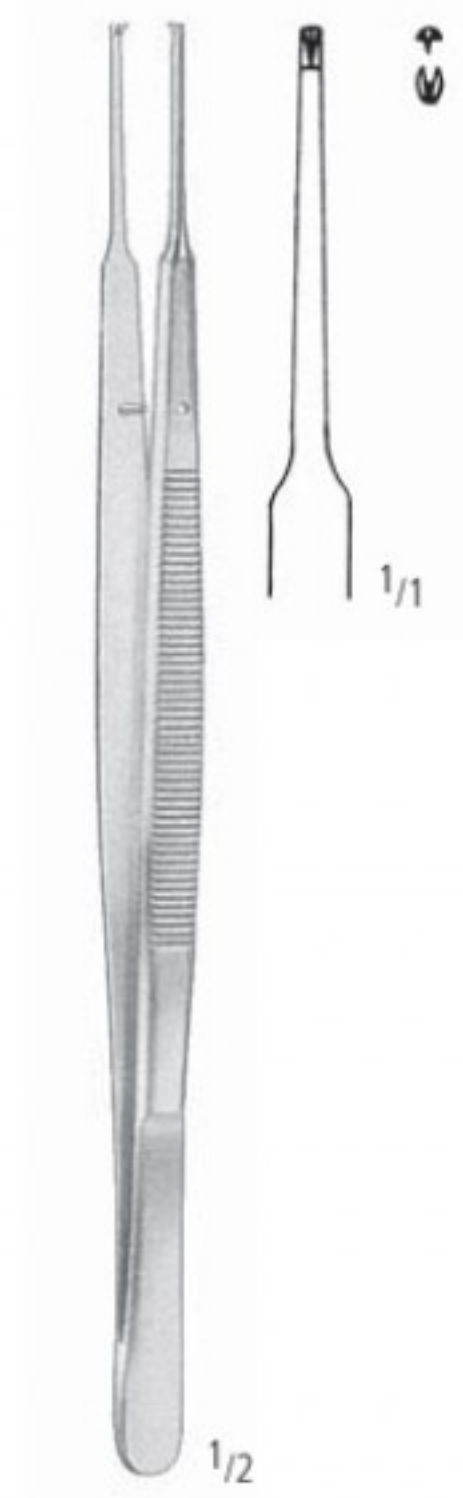

AB 170/18

GERALD 1:2
18,0 cm/7"

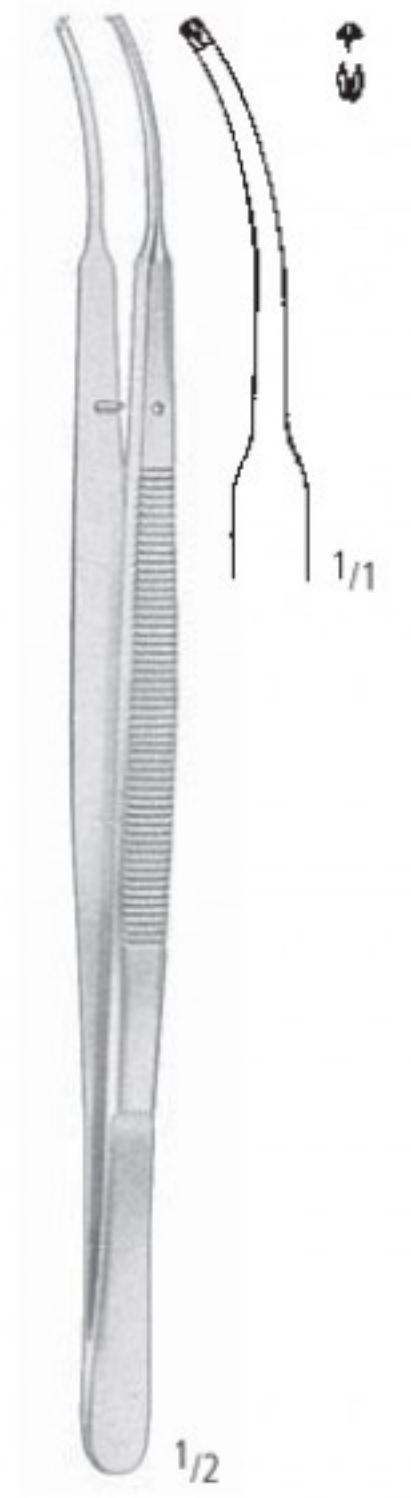

AB 171/18



AB 180/17

CUSHING
17,5 cm/7"



AB 181/17



AB 190/17

CUSHING 1:2
17,5 cm/7"

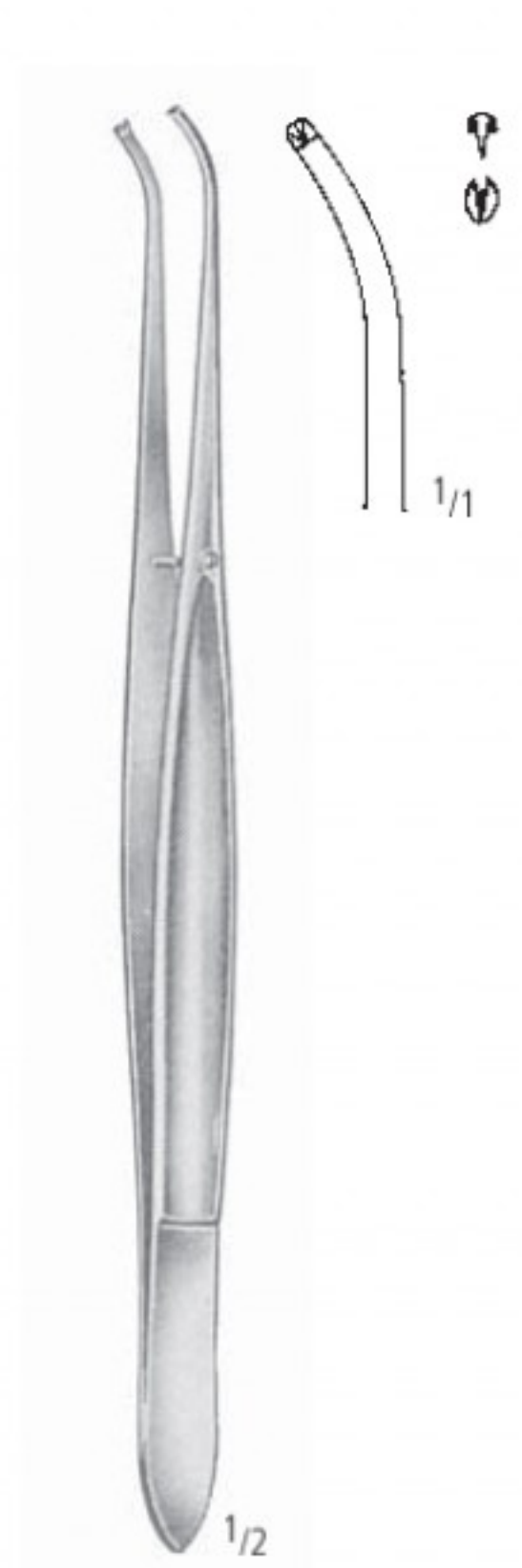

AB 191/17

AB PINZETTEN FORCEPS PINZAS PINCES PINZE

Splitter-Pinzetten
 Splinter Forceps
 Pinzas para espigas
 Pincas à échardes
 Pinze per schegge

mit Führungstift
 with guide pin
 con espiga de guía
 avec repères
 con perno da guida

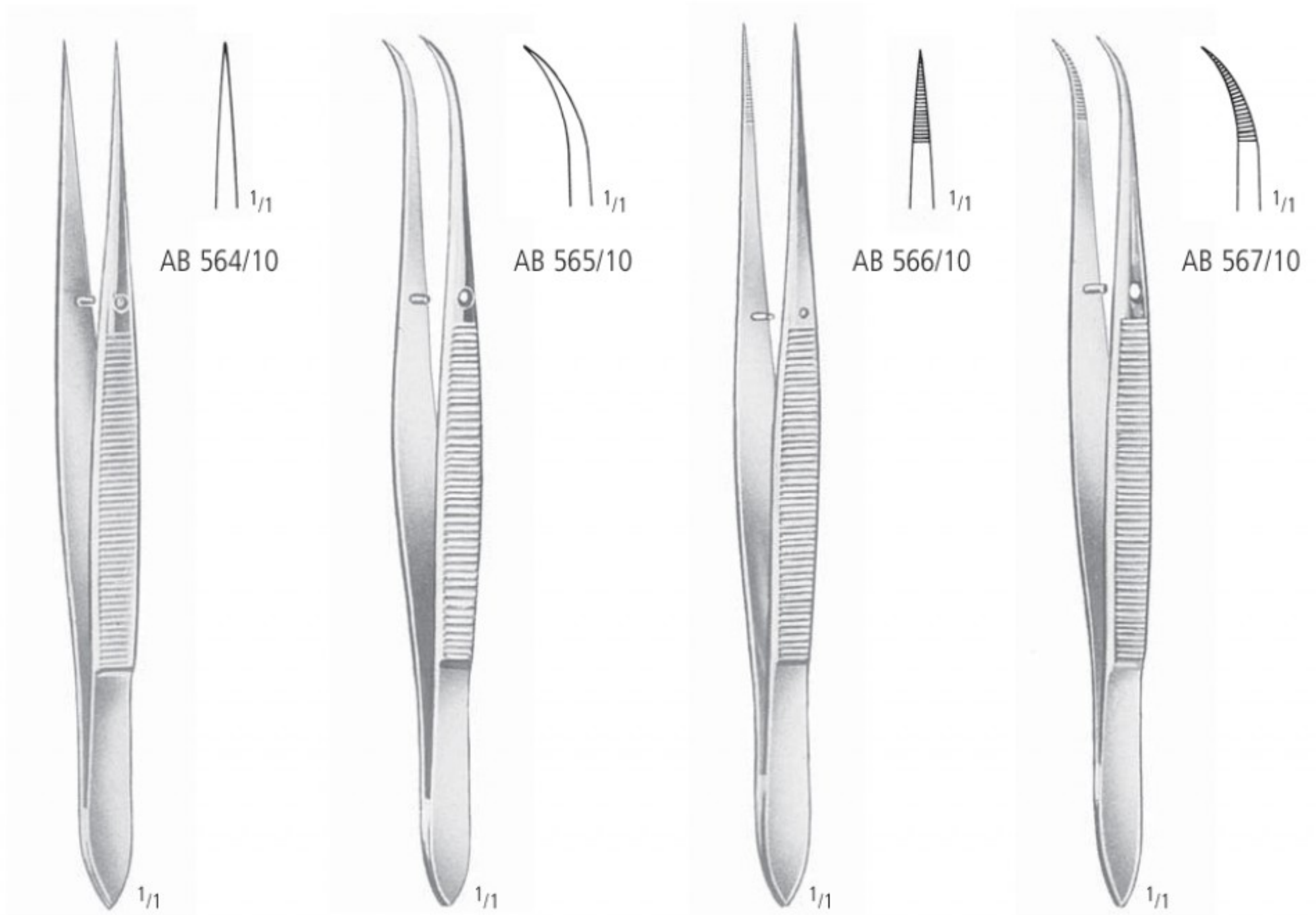

8,0 cm/3"	AB 564/08	AB 565/08	AB 566/08	AB 567/08
9,0 cm/3 1/2"	AB 564/09	AB 565/09	AB 566/09	AB 567/09
10,5 cm/4 1/4"	AB 564/10	AB 565/10	AB 566/10	AB 567/10
11,5 cm/4 1/2"	AB 564/11	AB 565/11	AB 566/11	AB 567/11
12,5 cm/5"	AB 564/12	AB 565/12	AB 566/12	AB 567/12
14,5 cm/5 3/4"	AB 564/14	AB 565/14	AB 566/14	AB 567/14

PINZETTEN FORCEPS PINZAS PINCES PINZE

Splitter-Pinzetten
 Splinter Forceps
 Pinzas para espigas
 Pincas à échardes
 Pinze per schegge

AA
 AB
 AC
 AD
 AE
 AF
 AG
 AH
 AI
 AJ
 AK
 AL
 AM
 AN
 AO
 AP
 AQ
 AR
 AS
 AT
 AU
 AV
 AW
 AX
 AY
 AZ
 BA
 BB
 BC
 BD
 BE
 BF
 BG
 BH
 BI
 BJ
 BK
 BL
 BM
 BN
 BO
 BP
 BQ
 BR
 BS
 BT
 BU
 BV
 BW
 BX
 BY
 BZ
 CA
 CB
 CC
 CD
 CE
 CF
 CG
 CH
 CI
 CJ
 CK
 CL
 CM
 CN
 CO
 CP
 CQ
 CR
 CS
 CT
 CU
 CV
 CW
 CX
 CY
 CZ
 DA
 DB
 DC
 DD
 DE
 DF
 DG
 DH
 DI
 DJ
 DK
 DL
 DM
 DN
 DO
 DP
 DQ
 DR
 DS
 DT
 DU
 DV
 DW
 DX
 DY
 DZ
 EA
 EB
 EC
 ED
 EE
 EF
 EG
 EH
 EI
 EJ
 EK
 EL
 EM
 EN
 EO
 EP
 EQ
 ER
 ES
 ET
 EU
 EV
 EW
 EX
 EY
 EZ
 FA
 FB
 FC
 FD
 FE
 FF
 FG
 FH
 FI
 FJ
 FK
 FL
 FM
 FN
 FO
 FP
 FQ
 FR
 FS
 FT
 FU
 FV
 FW
 FX
 FY
 FZ
 GA
 GB
 GC
 GD
 GE
 GF
 GG
 GH
 GI
 GJ
 GK
 GL
 GM
 GN
 GO
 GP
 GQ
 GR
 GS
 GT
 GU
 GV
 GW
 GX
 GY
 GZ
 HA
 HB
 HC
 HD
 HE
 HF
 HG
 HH
 HI
 HJ
 HK
 HL
 HM
 HN
 HO
 HP
 HQ
 HR
 HS
 HT
 HU
 HV
 HW
 HX
 HY
 HZ
 IA
 IB
 IC
 ID
 IE
 IF
 IG
 IH
 II
 IJ
 IK
 IL
 IM
 IN
 IO
 IP
 IQ
 IR
 IS
 IT
 IU
 IV
 IW
 IX
 IY
 IZ
 JA
 JB
 JC
 JD
 JE
 JF
 JG
 JH
 JI
 JJ
 JK
 JL
 JM
 JN
 JO
 JP
 JQ
 JR
 JS
 JT
 JU
 JV
 JW
 JX
 JY
 JZ
 KA
 KB
 KC
 KD
 KE
 KF
 KG
 KH
 KI
 KJ
 KK
 KL
 KM
 KN
 KO
 KP
 KQ
 KR
 KS
 KT
 KU
 KV
 KW
 KX
 KY
 KZ
 LA
 LB
 LC
 LD
 LE
 LF
 LG
 LH
 LI
 LJ
 LK
 LL
 LM
 LN
 LO
 LP
 LQ
 LR
 LS
 LT
 LU
 LV
 LW
 LX
 LY
 LZ
 MA
 MB
 MC
 MD
 ME
 MF
 MG
 MH
 MI
 MJ
 MK
 ML
 MM
 MN
 MO
 MP
 MQ
 MR
 MS
 MT
 MU
 MV
 MW
 MX
 MY
 MZ
 NA
 NB
 NC
 ND
 NE
 NF
 NG
 NH
 NI
 NJ
 NK
 NL
 NM
 NN
 NO
 NP
 NQ
 NR
 NS
 NT
 NU
 NV
 NW
 NX
 NY
 NZ
 OA
 OB
 OC
 OD
 OE
 OF
 OG
 OH
 OI
 OJ
 OK
 OL
 OM
 ON
 OO
 OP
 OQ
 OR
 OS
 OT
 OU
 OV
 OW
 OX
 OY
 OZ
 PA
 PB
 PC
 PD
 PE
 PF
 PG
 PH
 PI
 PJ
 PK
 PL
 PM
 PN
 PO
 PP
 PQ
 PR
 PS
 PT
 PU
 PV
 PW
 PX
 PY
 PZ
 QA
 QB
 QC
 QD
 QE
 QF
 QG
 QH
 QI
 QJ
 QK
 QL
 QM
 QN
 QO
 QP
 QQ
 QR
 QS
 QT
 QU
 QV
 QW
 QX
 QY
 QZ
 RA
 RB
 RC
 RD
 RE
 RF
 RG
 RH
 RI
 RJ
 RK
 RL
 RM
 RN
 RO
 RP
 RQ
 RR
 RS
 RT
 RU
 RV
 RW
 RX
 RY
 RZ
 SA
 SB
 SC
 SD
 SE
 SF
 SG
 SH
 SI
 SJ
 SK
 SL
 SM
 SN
 SO
 SP
 SQ
 SR
 SS
 ST
 SU
 SV
 SW
 SX
 SY
 SZ
 TA
 TB
 TC
 TD
 TE
 TF
 TG
 TH
 TI
 TJ
 TK
 TL
 TM
 TN
 TO
 TP
 TQ
 TR
 TS
 TT
 TU
 TV
 TW
 TX
 TY
 TZ
 UA
 UB
 UC
 UD
 UE
 UF
 UG
 UH
 UI
 UJ
 UK
 UL
 UM
 UN
 UO
 UP
 UQ
 UR
 US
 UT
 UY
 UZ
 VA
 VB
 VC
 VD
 VE
 VF
 VG
 VH
 VI
 VJ
 VK
 VL
 VM
 VN
 VO
 VP
 VQ
 VR
 VS
 VT
 VU
 VV
 VW
 VX
 VY
 VZ
 WA
 WB
 WC
 WD
 WE
 WF
 WG
 WH
 WI
 WJ
 WK
 WL
 WM
 WN
 WO
 WP
 WQ
 WR
 WS
 WT
 WU
 WV
 WW
 WX
 WY
 WZ
 XA
 XB
 XC
 XD
 XE
 XF
 XG
 XH
 XI
 XJ
 XK
 XL
 XM
 XN
 XO
 XP
 XQ
 XR
 XS
 XT
 XU
 XV
 XW
 XX
 XY
 XZ
 YA
 YB
 YC
 YD
 YE
 YF
 YG
 YH
 YI
 YJ
 YK
 YL
 YM
 YN
 YO
 YP
 YQ
 YR
 YS
 YT
 YU
 YV
 YW
 YX
 YZ
 ZA
 ZB
 ZC
 ZD
 ZE
 ZF
 ZG
 ZH
 ZI
 ZJ
 ZK
 ZL
 ZM
 ZN
 ZO
 ZP
 ZQ
 ZR
 ZS
 ZT
 ZU
 ZV
 ZW
 ZX
 ZY
 ZZ

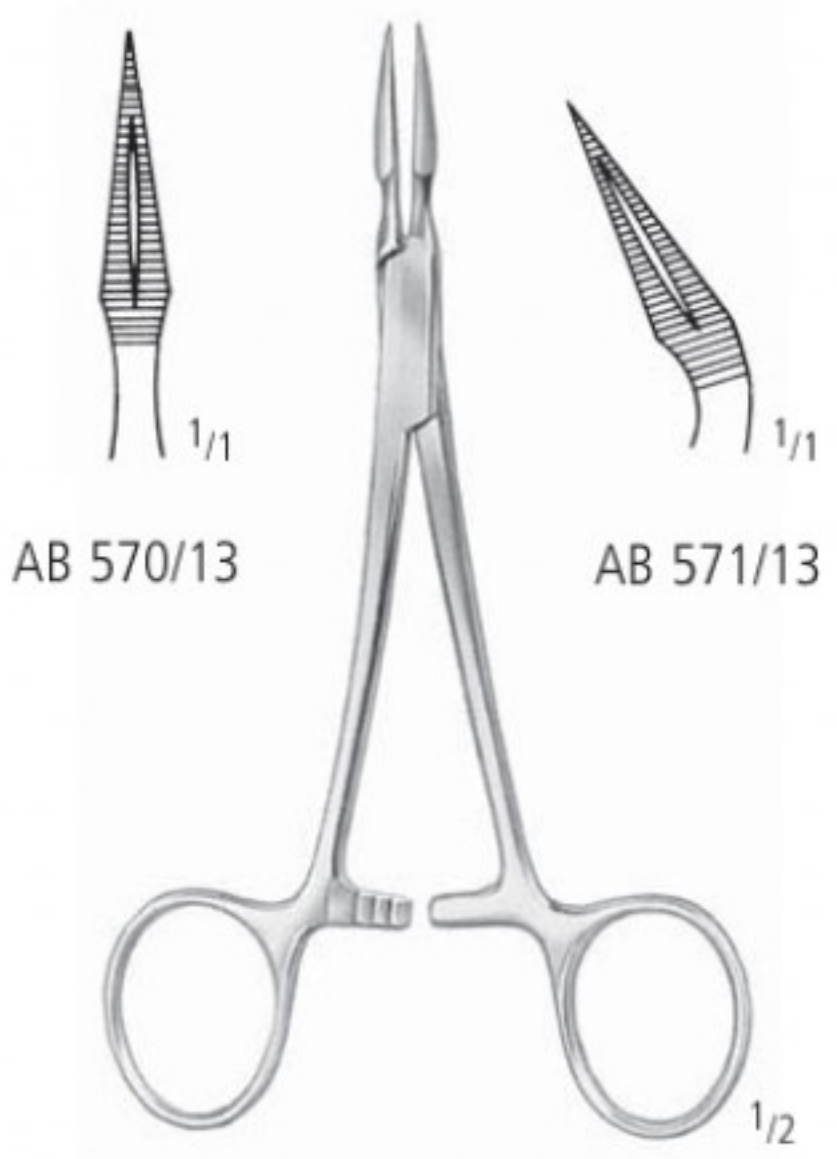

STIEGLITZ
 13,5 cm/5¹/₄"



STIEGLITZ
 AB 571/90
 13,5 cm/5¹/₄"

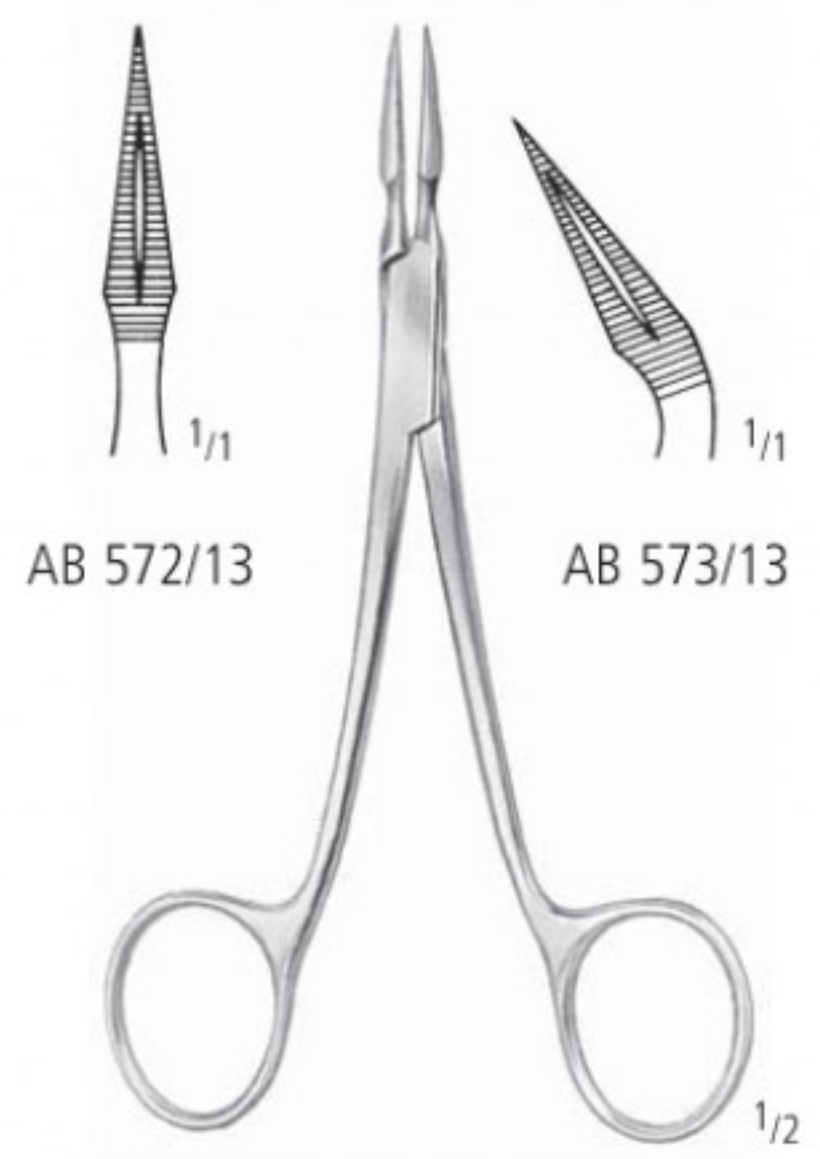

STIEGLITZ
 13,5 cm/5¹/₄"



PEET
 AB 580/11
 11,5 cm/4¹/₂"

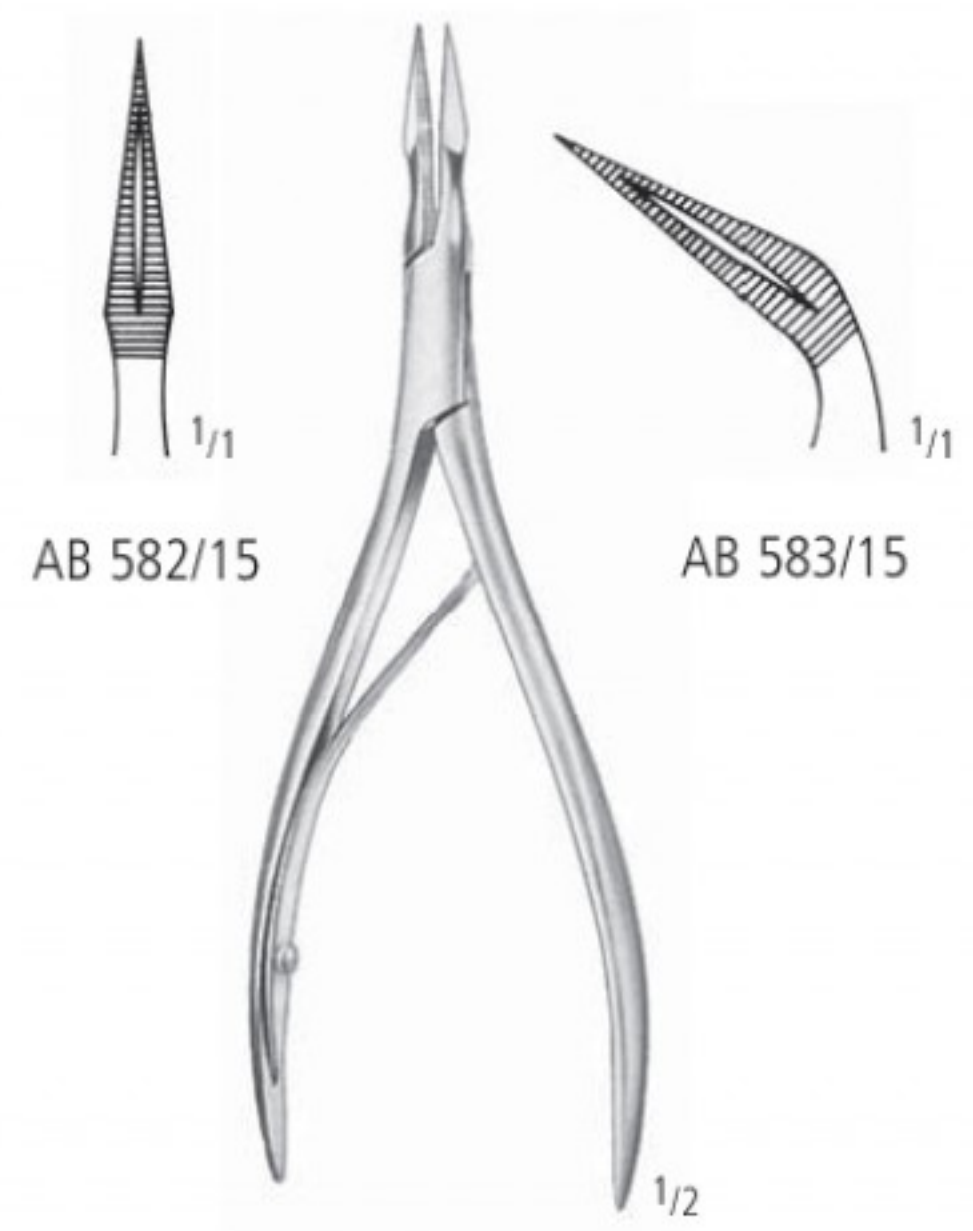

RALK
 15,0 cm/6"

Atraumatische Pinzetten
 Non-traumatic Vascular Tissue Forceps
 Pinzas Atrauma
 Pincas Atrauma
 Pinze Atrauma



DE BAKEY
 AB 860/16
 16,0 cm/6¹/₄"



DE BAKEY
 AB 862/16
 16,0 cm/6¹/₄"

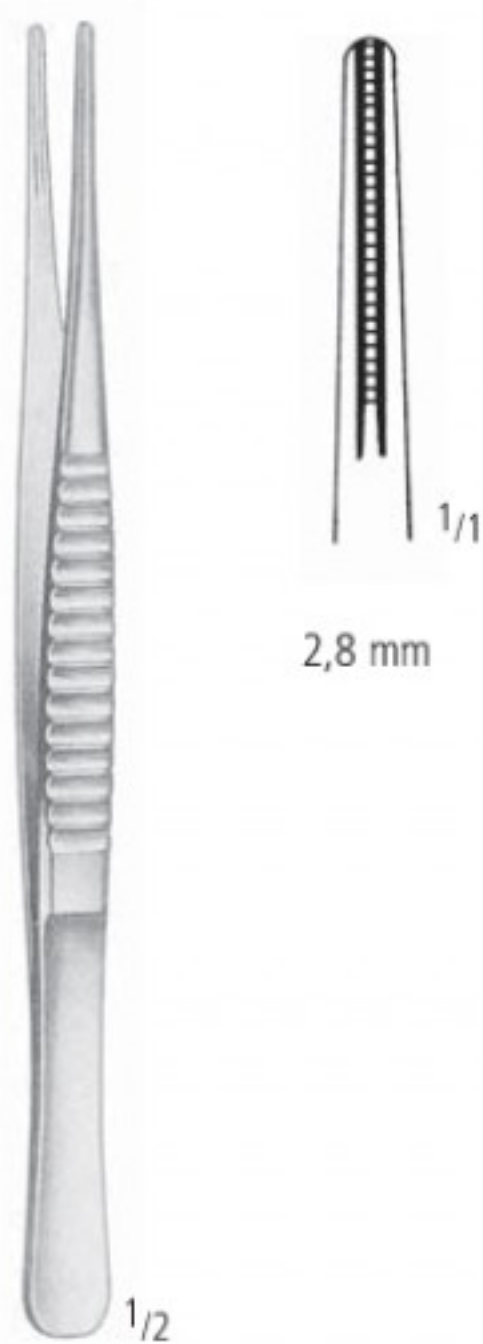

DE BAKEY
 AB 864/16
 16,0 cm/6¹/₄"

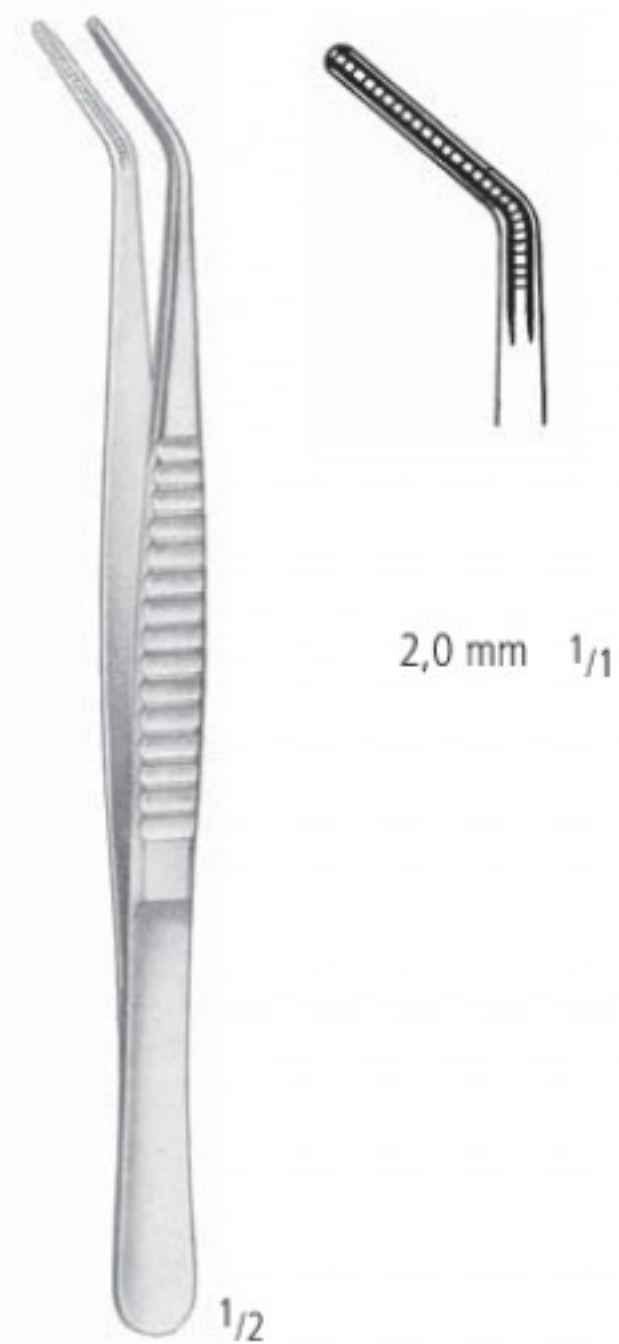

DE BAKEY
 AB 869/16
 16,0 cm/6¹/₄"

PINZETTEN FORCEPS PINZAS PINCES PINZE

Pinzetten mit Hartmetalleinsätzen

Dissecting Forceps with Tungsten Carbide Inserts

Pinzas de disección con bocas de carburo de tungsteno

Pinces à dissection avec mors en carbure de tungstène

Pinze per dissezione con punte di carburo di tungsteno

AA
AB
AC
AD
AE
AF
AK
AL
AO
AR
KA
KL
KU
PA
PB
PF
PI
PK
PL
PM
PP
PS
PT
PU
PV
KYE



1/2

POTTS-SMITH



AB 880/15
15,0 cm/6"



AB 880/18
18,0 cm/7"



1/2

OEHLER 1:2



AB 882/14
14,0 cm/5 1/2"



AB 882/16
16,0 cm/6 1/4"

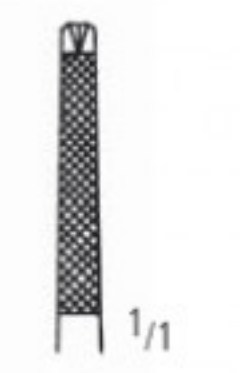

AB 882/18
18,0 cm/7"



1/2

SEMKEN

- AB 890/12 12,5 cm/5"
- AB 890/15 15,5 cm/6"



AB 890/12



1/2

GILLIES 1:2

- AB 900/15 15,0 cm/6"

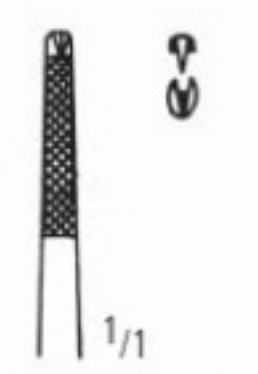

1/1



1/2

JEWELER

- AB 902/15 15,0 cm/6"



1/1

AB PINZETTEN FORCEPS PINZAS PINCES PINZE

Pinzetten mit Hartmetalleinsätzen
 Dissecting Forceps with Tungsten Carbide Inserts
 Pinzas de disección con bocas de carburo de tungsteno
 Pincas à dissection avec mors en carbure de tungstène
 Pinze per dissezione con punte di carburo di tungsteno



ADSON

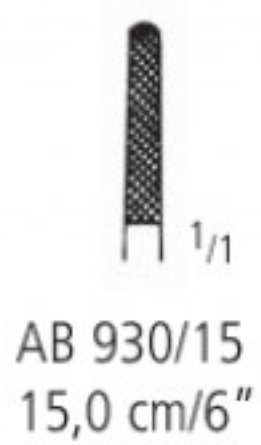
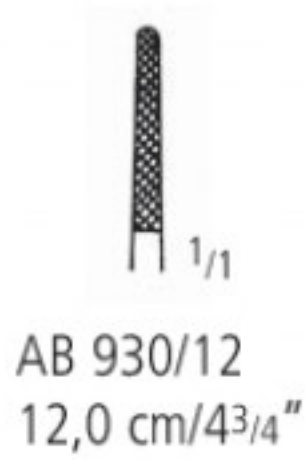

CUSHING
17,5 cm/7"



mit Dissektor-Ende
 with dissector end
 con cabo disecador
 avec bout dissecteur
 con dissettore



CUSHING-TAYLOR
AB 943/18
18,0 cm/7"



PINZETTEN FORCEPS PINZAS PINCES PINZE

Zahnpinzetten
Cotton and Dressing Pliers
Pinzas para algodón y curaciones
Précettes (Brucelles) pour coton
Pinze per cotone

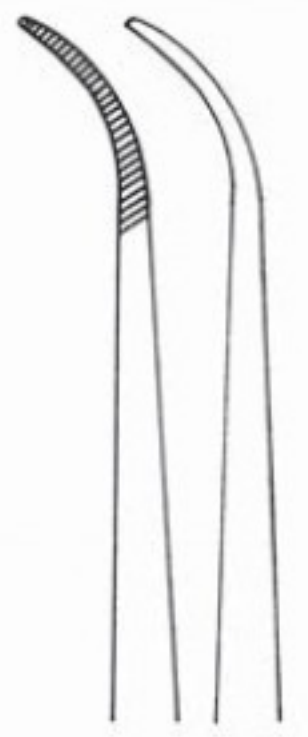

FIG. 1

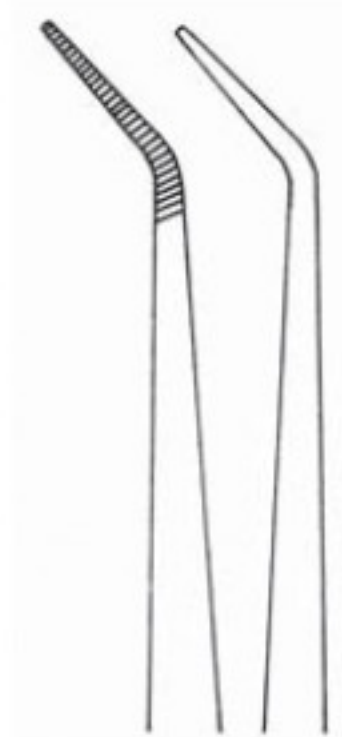

FIG. 3

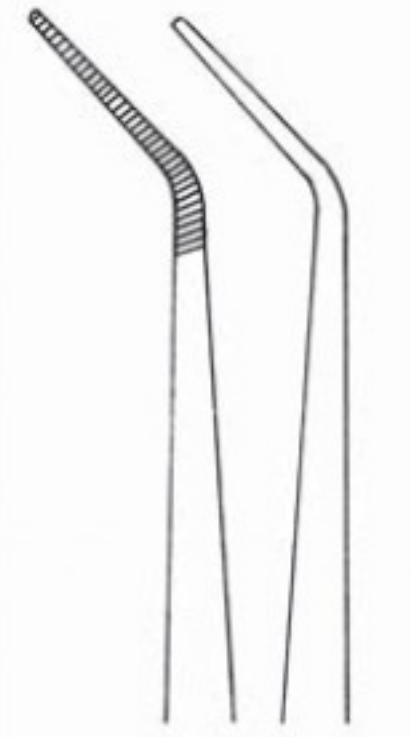

FIG. 5

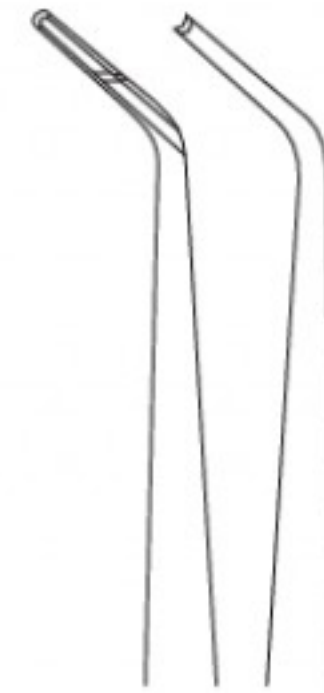

FIG. 8

für Silberspitzen
for silver points
para puntas de plata
pour cônes d'argent
per punte d'argento



LONDON COLLEGE

15,0 cm/6"

AB 970/01

AB 970/03

AB 970/05

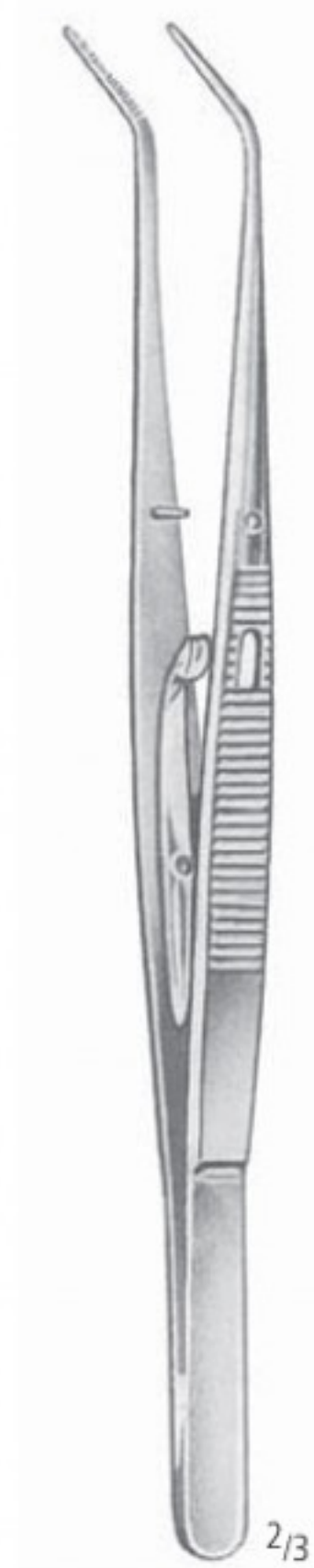

LONDON COLLEGE

15,0 cm/6"

AB 973/01

AB 973/03

AB 973/05

AB 973/08

Fig. 1
Fig. 3
Fig. 5
Fig. 8

AA
AB
AC
AD
AE
AF
AK
AL
AO
AR
KA
KL
KU
PA
PB
PF
PI
PK
PL
PM
PP
PS
PT
PU
PV
KYE

AB PINZETTEN FORCEPS PINZAS PINCES PINZE

Zahnpinzetten
 Cotton and Dressing Pliers
 Pinzas para algodón y curaciones
 Précelles (Brucelles) pour coton
 Pinze per cotone

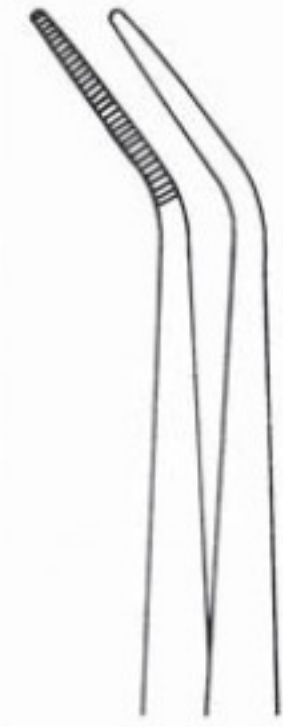

FIG. 1



FIG. 3



FIG. 5



MERIAM
 16,0 cm/6¹/₄"
 AB 976/01
 AB 976/03
 AB 976/05



MERIAM
 16,0 cm/6¹/₄"
 AB 977/01
 AB 977/03
 AB 977/05

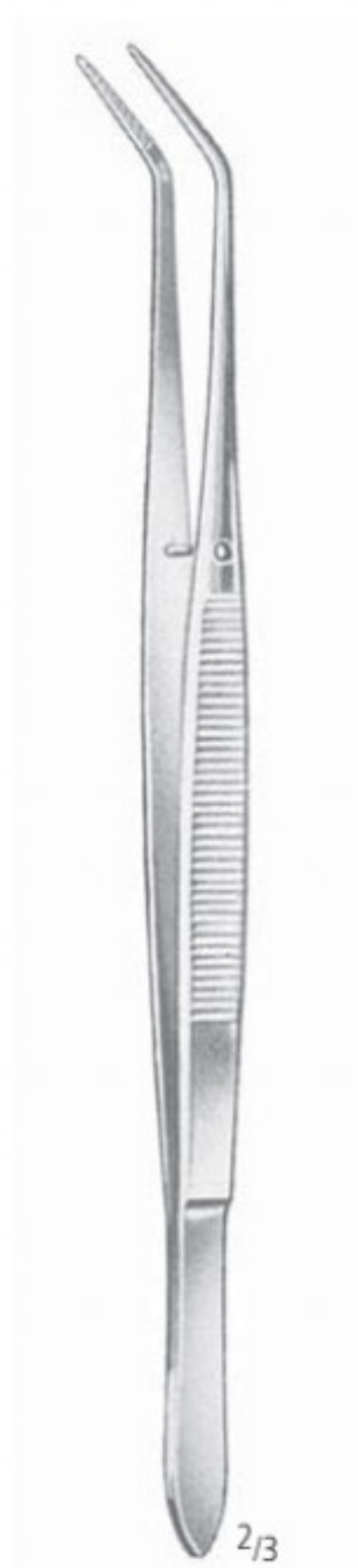

FLAGG
 16,0 cm/6¹/₄"
 AB 978/01
 AB 978/03



FLAGG
 16,0 cm/6¹/₄"
 AB 979/01
 AB 979/03

Fig. 1
 Fig. 3
 Fig. 5

PINZETTEN FORCEPS PINZAS PINCES PINZE

Zahnpinzetten, Nahtpinzetten
 Cotton and Dressing Pliers, Suture Forceps
 Pinzas para algodón y curaciones, pinzas para sutura
 Précelles (Brucelles) pour coton, pinces pour sutures
 Pinze per cotone, pinze per sutura

AA
AB
 AC
 AD
 AE
 AF
 AK
 AL
 AO
 AR
 KA
 KL
 KU
 PA
 PB
 PF
 PI
 PK
 PL
 PM
 PP
 PS
 PT
 PU
 PV
 KYE



2/3

LANDGRAF
 15,0 cm/6"



Fig. 1
 AB 981/01

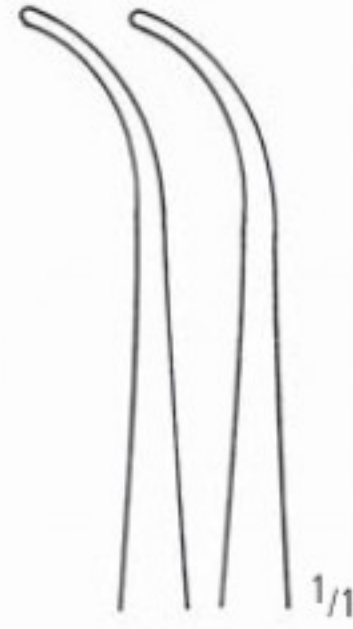

Fig. 2
 AB 981/02

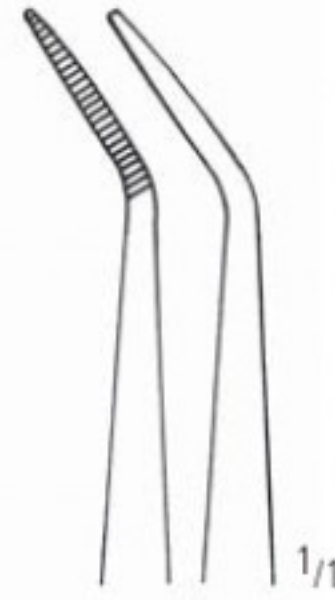

Fig. 3
 AB 981/03

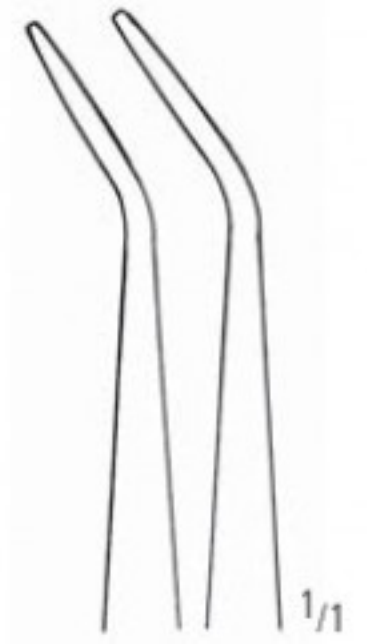

Fig. 4
 AB 981/04



2/3

PERRY
 12,5 cm/5"

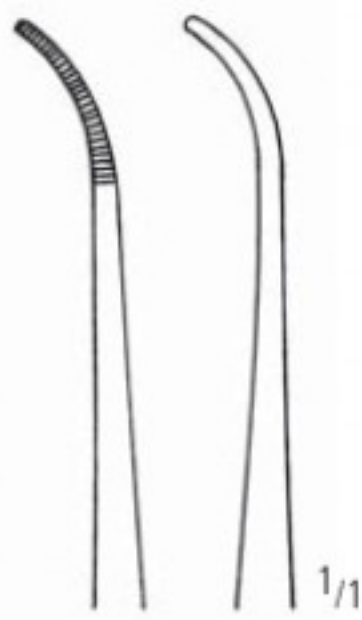

Fig. 1
 AB 983/01

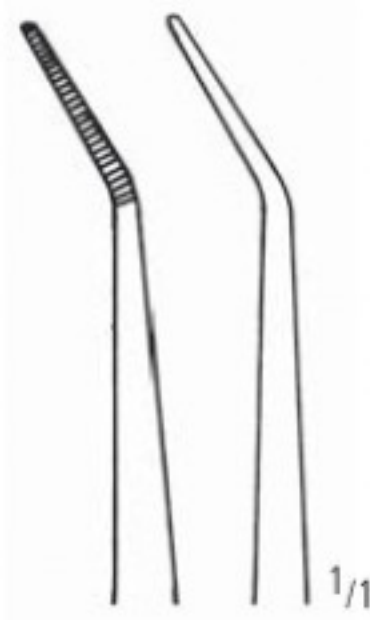
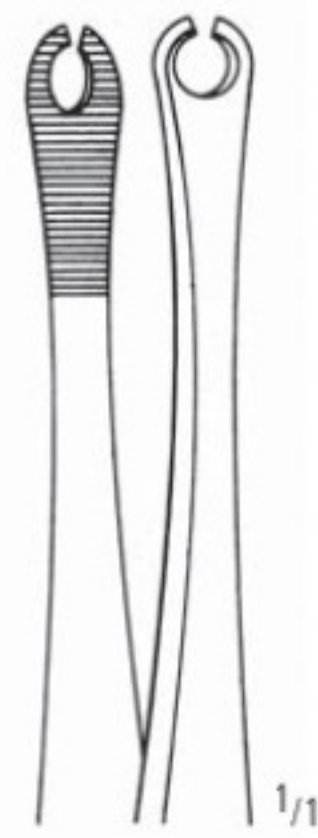

Fig. 2
 AB 983/02



15,0 cm/6"



AB 988/01

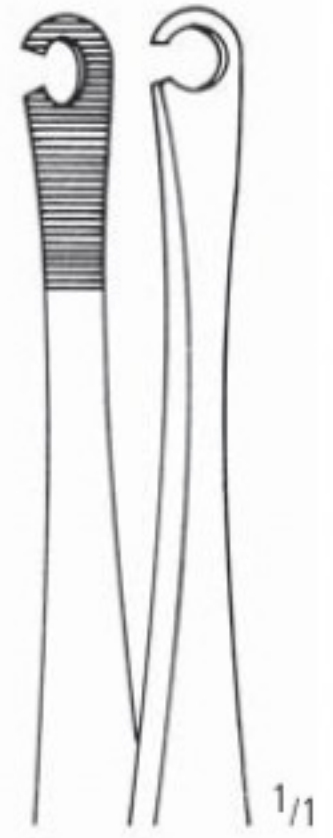

AB 988/02

AB PINZETTEN FORCEPS PINZAS PINCES PINZE

Markierungspinzetten, Artikulationspapier-Pinzetten
 Pocket Markers, Articulating Paper Forceps
 Pinzas para bolsas, Pinzas para papel de articular
 Pincés pour cul-de-sac, Pincés pour papier à articulation
 Pinze per marcazione, Pinze per carta di articolazione

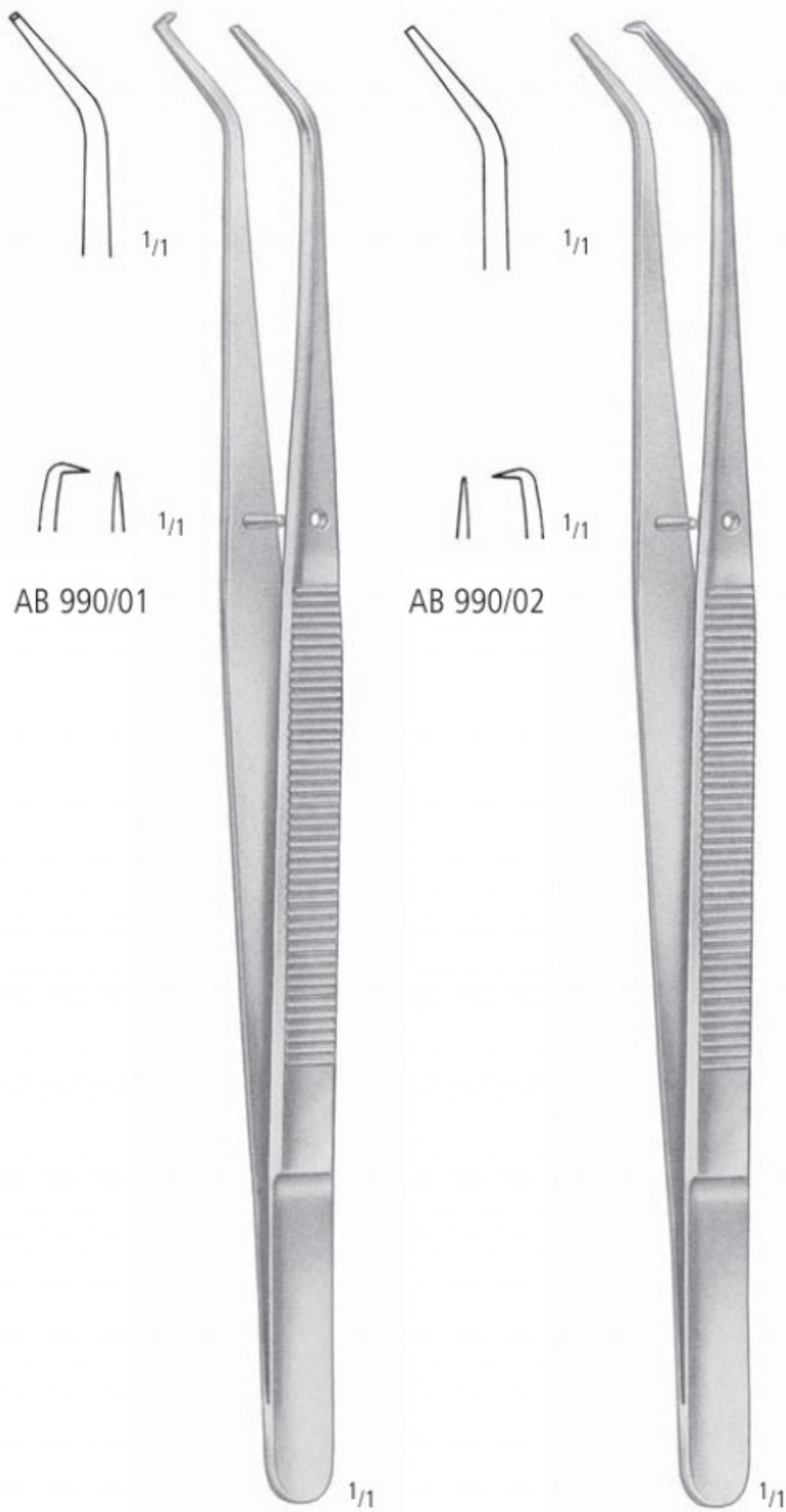

CRANE-KAPLAN

AB 990/01
 15,0 cm/6"

AB 990/02
 15,0 cm/6"

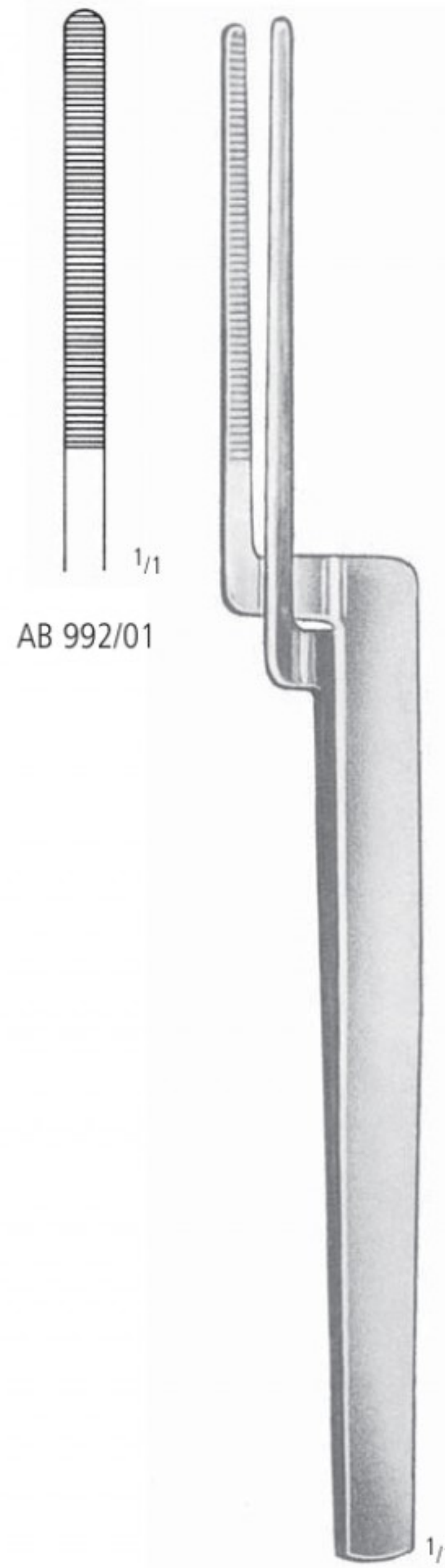

AB 992/01

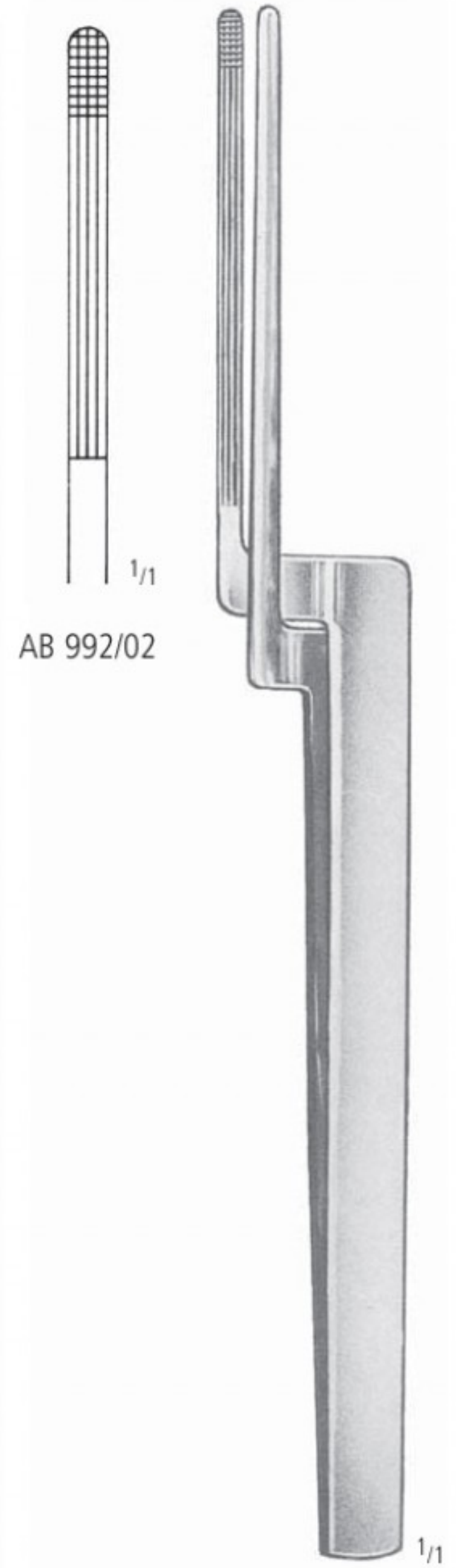

AB 992/02

MILLER

15,0 cm/6"

SCHEREN
SCISSORS
TIJERAS
CISEAUX
FORBICI

AC

nopa[®] instruments



nopa[®] SC
SUPER CUT



SUPER CUT

Verfügbare Modelle / Available Patterns

Im Katalog durch * markiert. / Marked in catalog with * .

AC	020/13	SC	STANDARD OPER.SCS.STR.SH/BL	13,0 CM	SC
AC	020/14	SC	STANDARD OPER.SCS.STR.SH/BL	14,0 CM	SC
AC	021/13	SC	STANDARD OPER.SCS.CVD.SH/BL	13,0 CM	SC
AC	021/14	SC	STANDARD OPER.SCS.CVD.SH/BL	14,0 CM	SC
AC	070/14	SC	MAYO OPER.SCS.STR.BL/BL	14,5 CM	SC
AC	070/17	SC	MAYO OPER.SCS.STR.BL/BL	17,0 CM	SC
AC	071/14	SC	MAYO OPER.SCS.CVD.BL/BL	14,5 CM	SC
AC	071/17	SC	MAYO OPER.SCS.CVD.BL/BL	17,0 CM	SC
AC	100/14	SC	METZENBAUM SCISSORS STR.BL/BL	14,0 CM	SC
AC	101/14	SC	METZENBAUM SCISSORS CVD.BL/BL	14,0 CM	SC
AC	110/18	SC	METZENBAUM-NELSON SCS.BL/BL	18,0 CM	SC
AC	111/18	SC	METZENBAUM-NELSON SCS.CVD.	18,0 CM	SC
AC	140/14	SC	METZENBAUM-DELICATE BL/BL STR.	14,5 CM	SC
AC	141/14	SC	METZENBAUM-DELICATE BL/BL CVD.	14,5 CM	SC
AC	142/14	SC	METZENBAUM-DELICATE SH/SH STR.	14,5 CM	SC
AC	143/14	SC	METZENBAUM-DELICATE SH/SH CVD.	14,5 CM	SC
AC	150/18	SC	METZENBAUM-DELICATE BL/BL STR.	18,0 CM	SC
AC	151/18	SC	METZENBAUM-DELICATE BL/BL CVD.	18,0 CM	SC
AC	152/18	SC	METZENBAUM-DELICATE SH/SH STR.	18,0 CM	SC
AC	153/18	SC	METZENBAUM-DELICATE SH/SH CVD.	18,0 CM	SC
AC	214/15	SC	REYNOLDS DISS.SCISSORS STR.SH	15,0 CM	SC
AC	214/18	SC	REYNOLDS DISS.SCISSORS STR. SHARP	18,0 CM	SC
AC	215/15	SC	REYNOLDS DISS.SCISSORS CVD. SHARP	15,0 CM	SC
AC	215/18	SC	REYNOLDS DISS.SCS. CVD. SHARP	18,0 CM	SC
AC	476/11	SC	STEVENS TENOTOM.SCS.STR. BLUNT	11,5 CM	SC

Besonderheit:

nopa Super Cut Scheren haben eine rasierklingenscharfe Schneide, kombiniert mit einer mikrogezahnten Schneide.

>> Diese Scheren sind durch schwarze Ringe gekennzeichnet.

Features:

nopa Super Cut scissors have a razor-like edge combined with one micro serrated blade.

>> Black rings for easy identification.

AC SCHEREN SCISSORS TIJERAS CISEAUX FORBICI

Chirurgische Scheren
Operating Scissors
Tijeras para cirugía
Ciseaux à chirurgie
Forbici per chirurgia



Original 13,0 cm

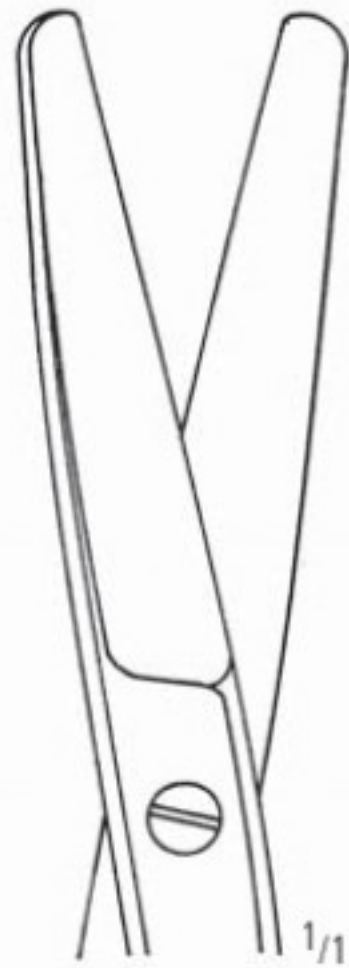

STANDARD

Fig.1
gerade
straight
rectas
droits
rette

AC 010/10	10,5 cm/4 ¹ / ₄ "
AC 010/11	11,5 cm/4 ¹ / ₂ "
AC 010/13	13,0 cm/5"
AC 010/14	14,5 cm/5 ³ / ₄ "
AC 010/15	15,5 cm/6"
AC 010/16	16,5 cm/6 ¹ / ₂ "
AC 010/17	17,5 cm/7"
AC 010/18	18,5 cm/7 ¹ / ₃ "
AC 010/20	20,0 cm/8"

STANDARD Original 13,0 cm

Fig.1
gebogen
curved
curvas
courbes
curve



Original 14,5 cm



STANDARD

Fig.2
gerade
straight
rectas
droits
rette

AC 020/10	10,5 cm/4 ¹ / ₄ "
AC 020/11	11,5 cm/4 ¹ / ₂ "
AC 020/13*	13,0 cm/5"
AC 020/14*	14,5 cm/5 ³ / ₄ "
AC 020/15	15,5 cm/6"
AC 020/16	16,5 cm/6 ¹ / ₂ "
AC 020/17	17,5 cm/7"
AC 020/18	18,5 cm/7 ¹ / ₃ "
AC 020/20	20,0 cm/8"

STANDARD Original 14,5 cm

Fig.2
gebogen
curved
curvas
courbes
curve



Original 16,5 cm

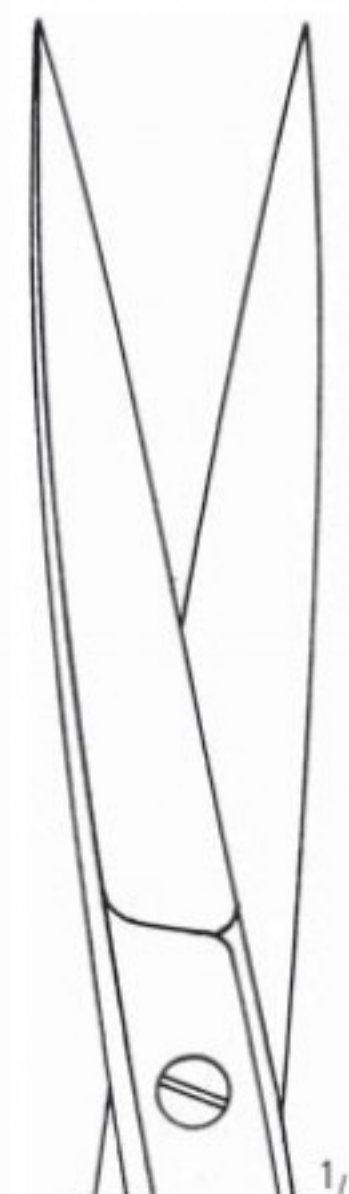

STANDARD

Fig.3
gerade
straight
rectas
droits
rette

AC 030/10	10,5 cm/4 ¹ / ₄ "
AC 030/11	11,5 cm/4 ¹ / ₂ "
AC 030/13	13,0 cm/5"
AC 030/14	14,5 cm/5 ³ / ₄ "
AC 030/15	15,5 cm/6"
AC 030/16	16,5 cm/6 ¹ / ₂ "
AC 030/17	17,5 cm/7"
AC 030/18	18,5 cm/7 ¹ / ₃ "
AC 030/20	20,0 cm/8"

STANDARD Original 16,5 cm

Fig.3
gebogen
curved
curvas
courbes
curve

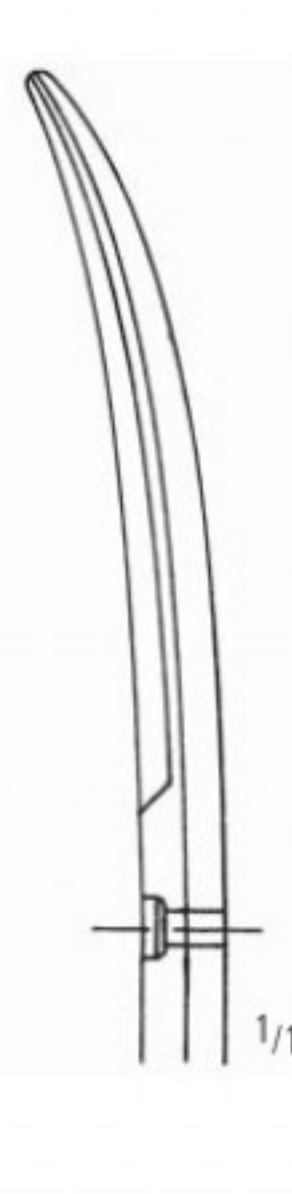

SCHEREN SCISSORS TIJERAS CISEAUX FORBICI

Chirurgische Scheren
 Operating Scissors
 Tijeras para cirugía
 Ciseaux à chirurgie
 Forbici per chirurgia

AA
 AB
 AC
 AD
 AE
 AF
 AK
 AL
 AO
 AR
 KA
 KL
 KU
 PA
 PB
 PF
 PI
 PK
 PL
 PM
 PP
 PS
 PT
 PU
 PV
 KYE

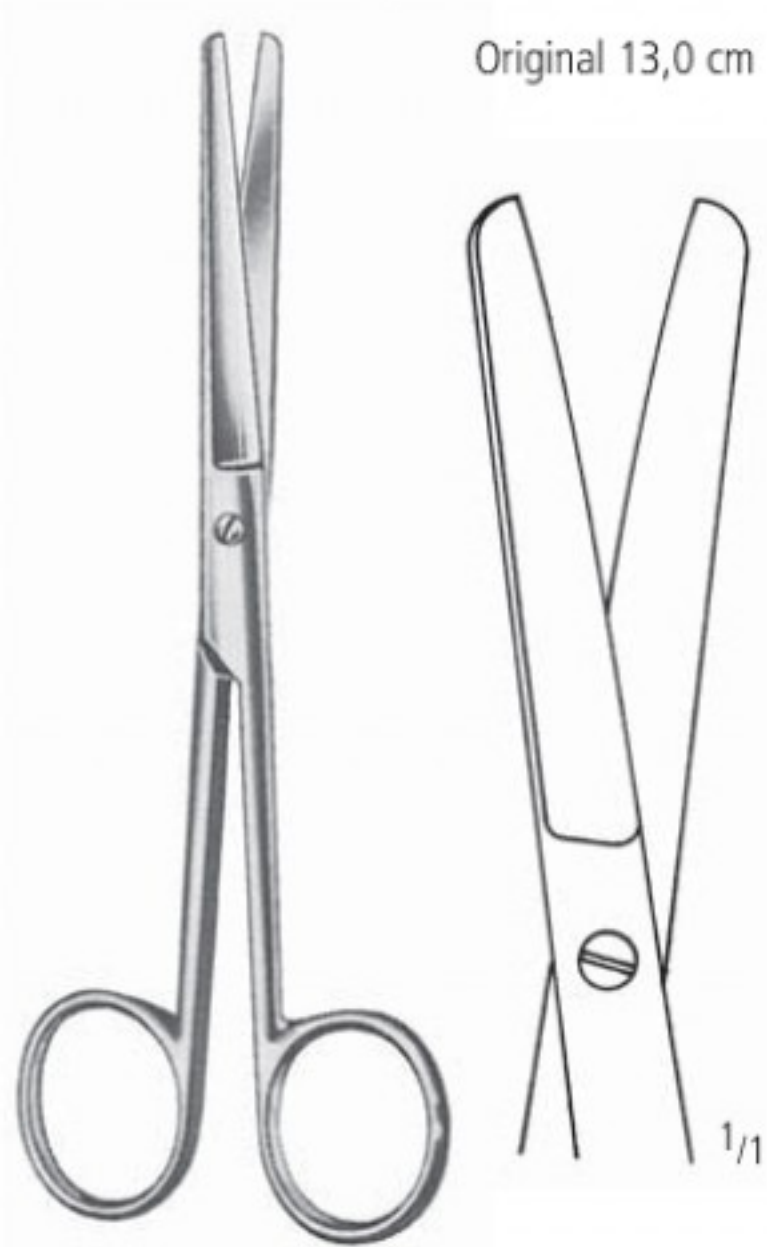

Original 13,0 cm

GRAZIL

Fig.1
 gerade
 straight
 rectas
 droits
 rette

AC 040/13
 AC 040/14

13,0 cm/5"
 14,5 cm/5³/₄"

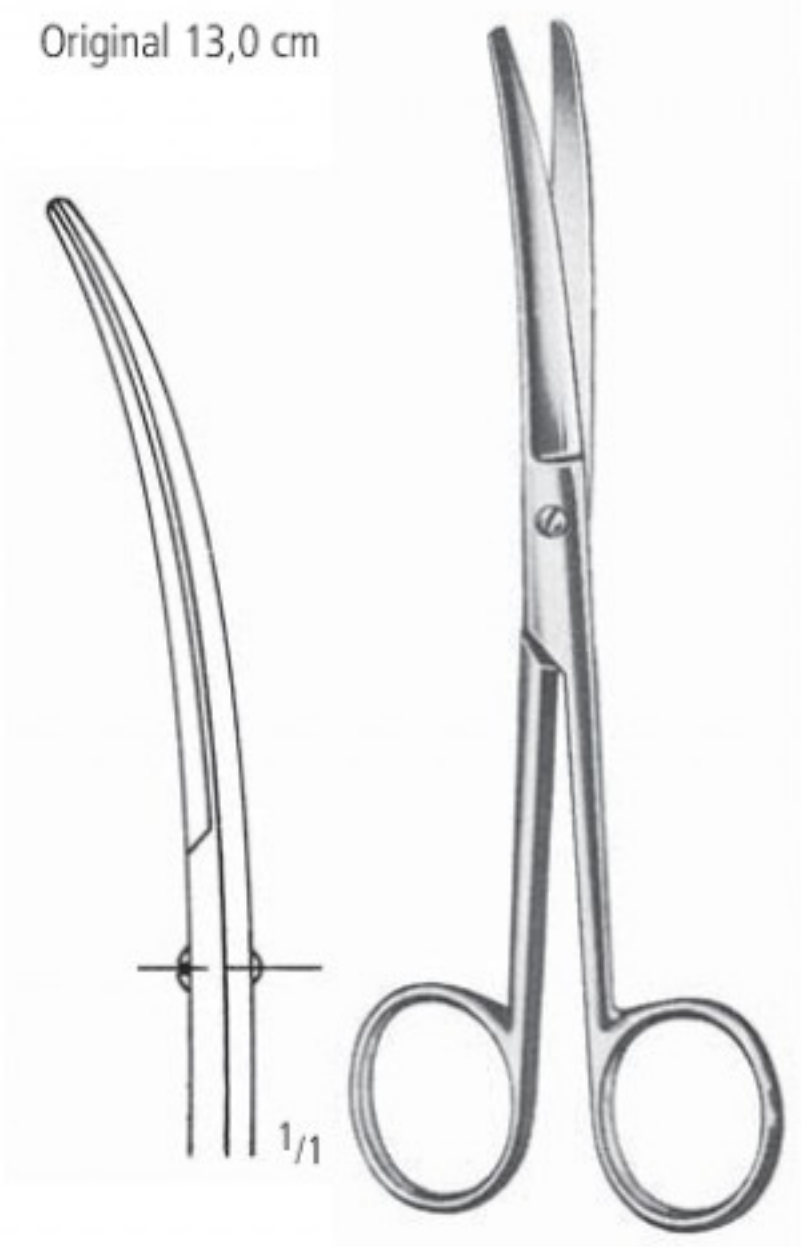

Original 13,0 cm

GRAZIL

Fig. 1
 gebogen
 curved
 curvas
 courbes
 curve

AC 041/13
 AC 041/14

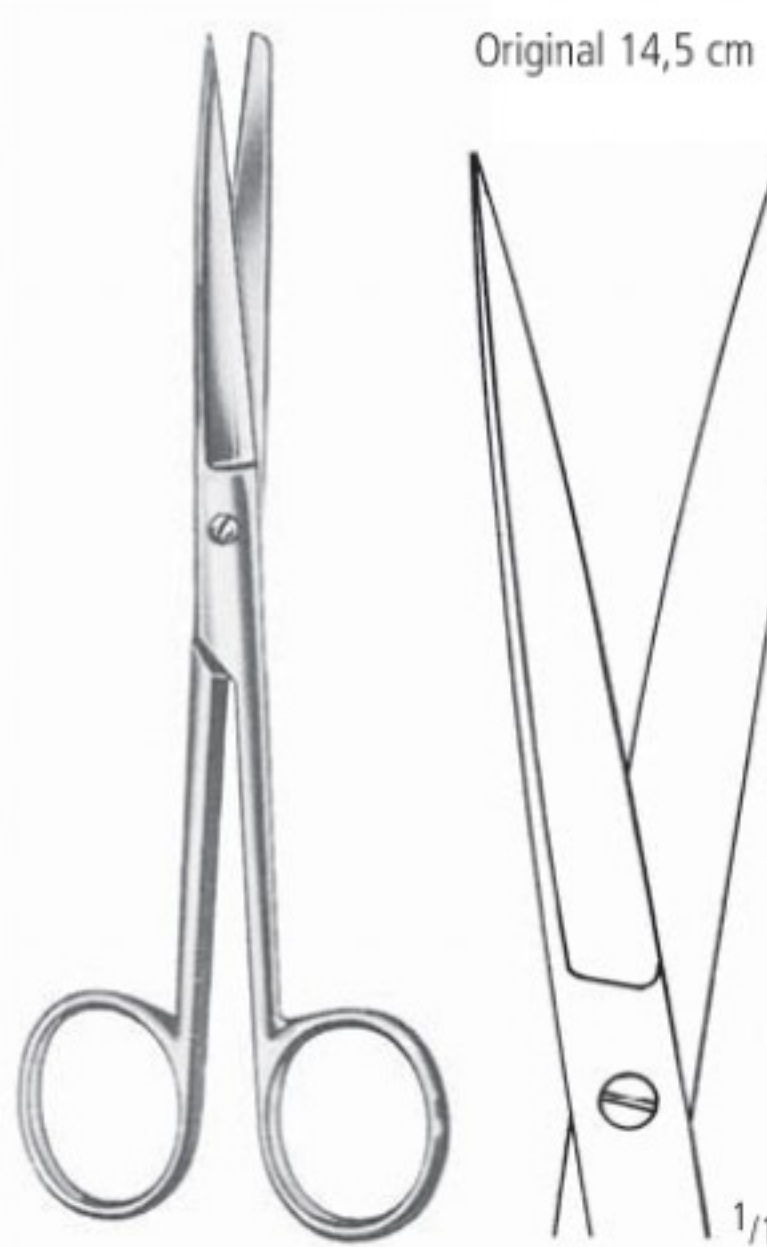

Original 14,5 cm

GRAZIL

Fig.2
 gerade
 straight
 rectas
 droits
 rette

AC 042/13
 AC 042/14

13,0 cm/5"
 14,5 cm/5³/₄"



Original 14,5 cm

GRAZIL

Fig. 2
 gebogen
 curved
 curvas
 courbes
 curve

AC 043/13
 AC 043/14

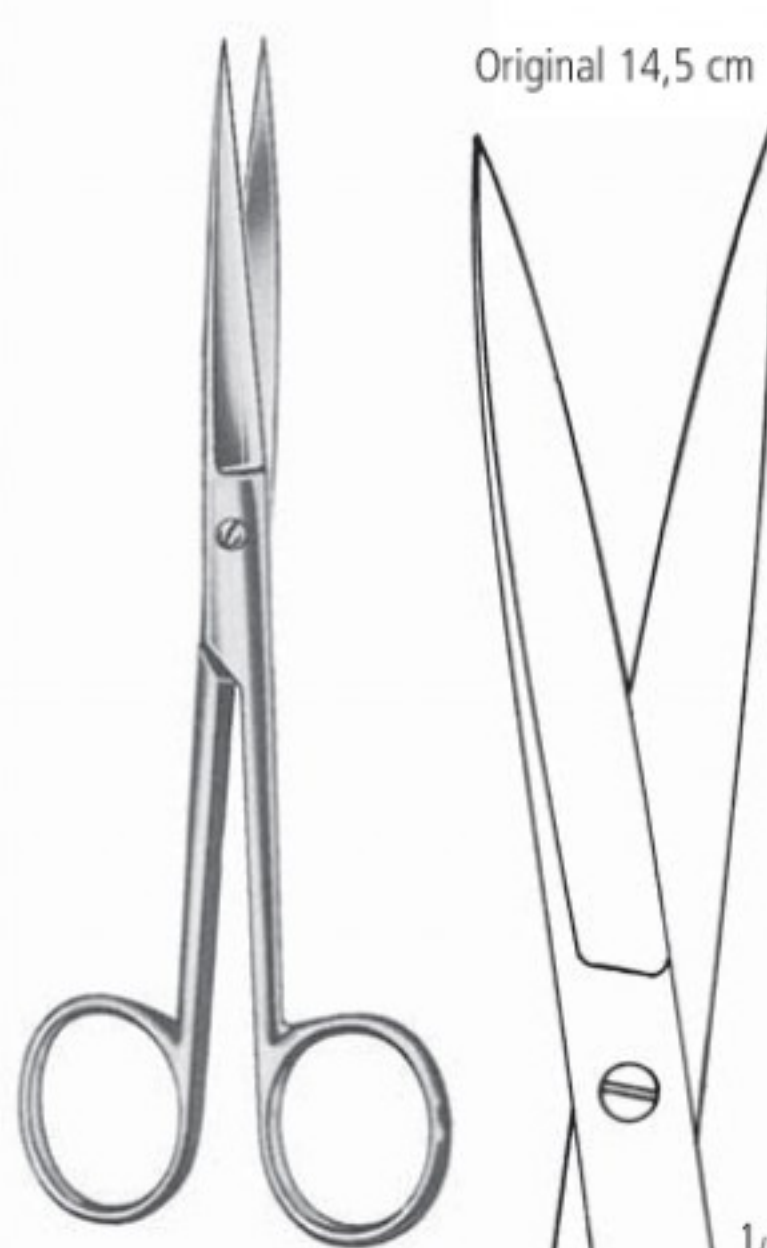

Original 14,5 cm

GRAZIL

Fig.3
 gerade
 straight
 rectas
 droits
 rette

AC 046/13
 AC 046/14

13,0 cm/5"
 14,5 cm/5³/₄"



Original 14,5 cm

GRAZIL

Fig. 3
 gebogen
 curved
 curvas
 courbes
 curve

AC 047/13
 AC 047/14

Chirurgische Scheren
 Operating Scissors
 Tijeras para cirugía
 Ciseaux à chirurgie
 Forbici per chirurgia

Original 15,0 cm

Original 16,0 cm

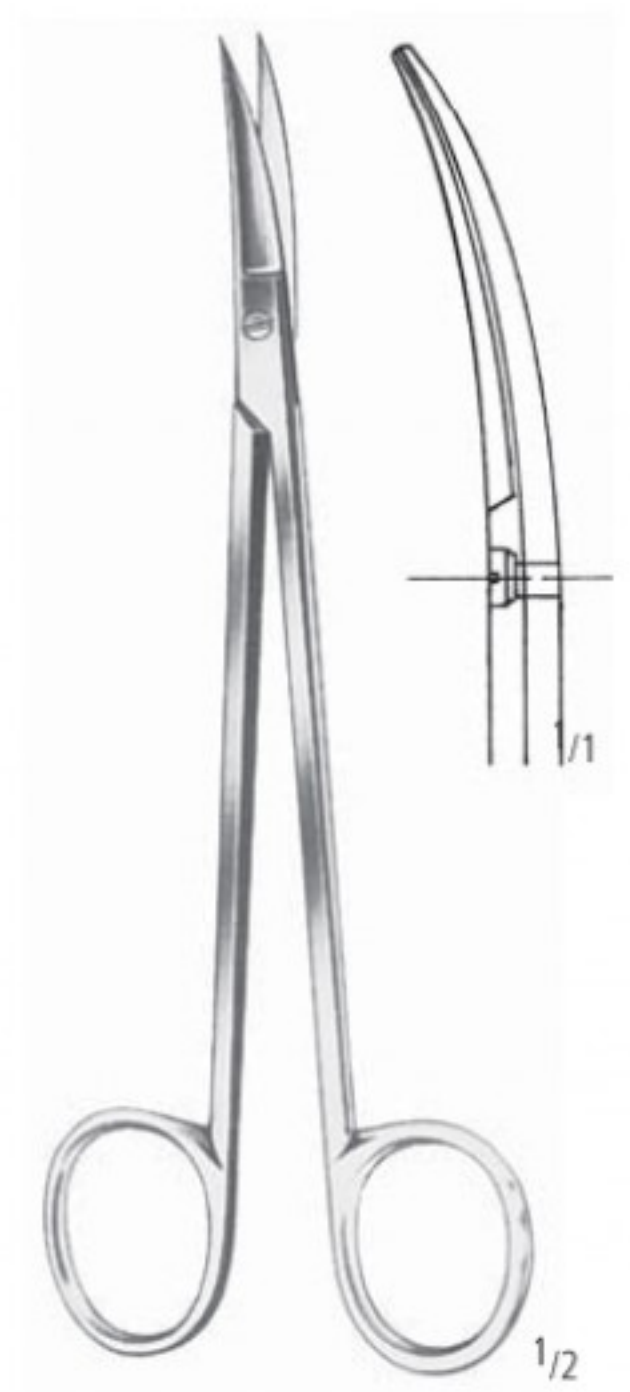
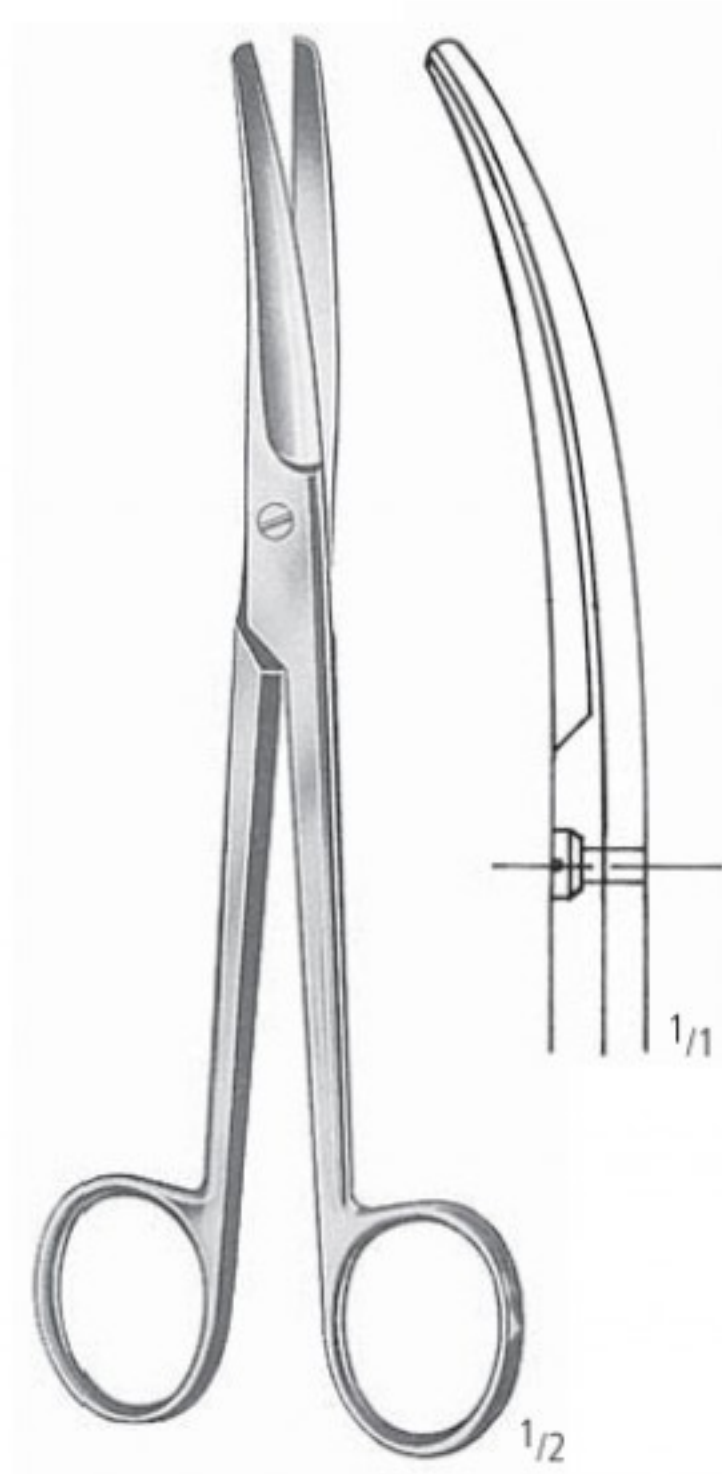

MAYO

KELLY

AC 070/14*
 AC 070/17*

14,5 cm/5³/₄"
 17,0 cm/6³/₄"

AC 071/14*
 AC 071/17*

AC 086/16
 AC 086/18

16,0 cm/6¹/₄"
 18,0 cm/7"

AC 087/16
 AC 087/18

SCHEREN SCISSORS TIJERAS CISEAUX FORBICI

Präparierscheren
Dissecting Scissors
Tijeras para preparaciones
Ciseaux à dissection
Forbici per preparazioni

AA
AB
AC
AD
AE
AF
AK
AL
AO
AR
KA
KL
KU
PA
PB
PF
PI
PK
PL
PM
PP
PS
PT
PU
PV
KYE

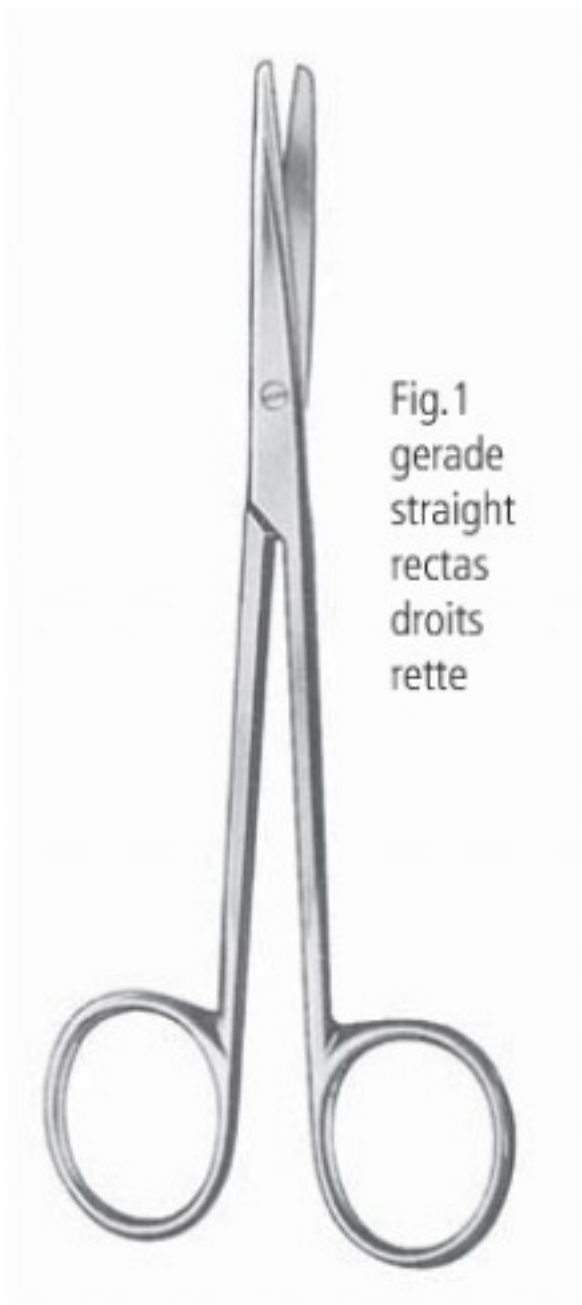

Fig.1
gerade
straight
rectas
droits
rette

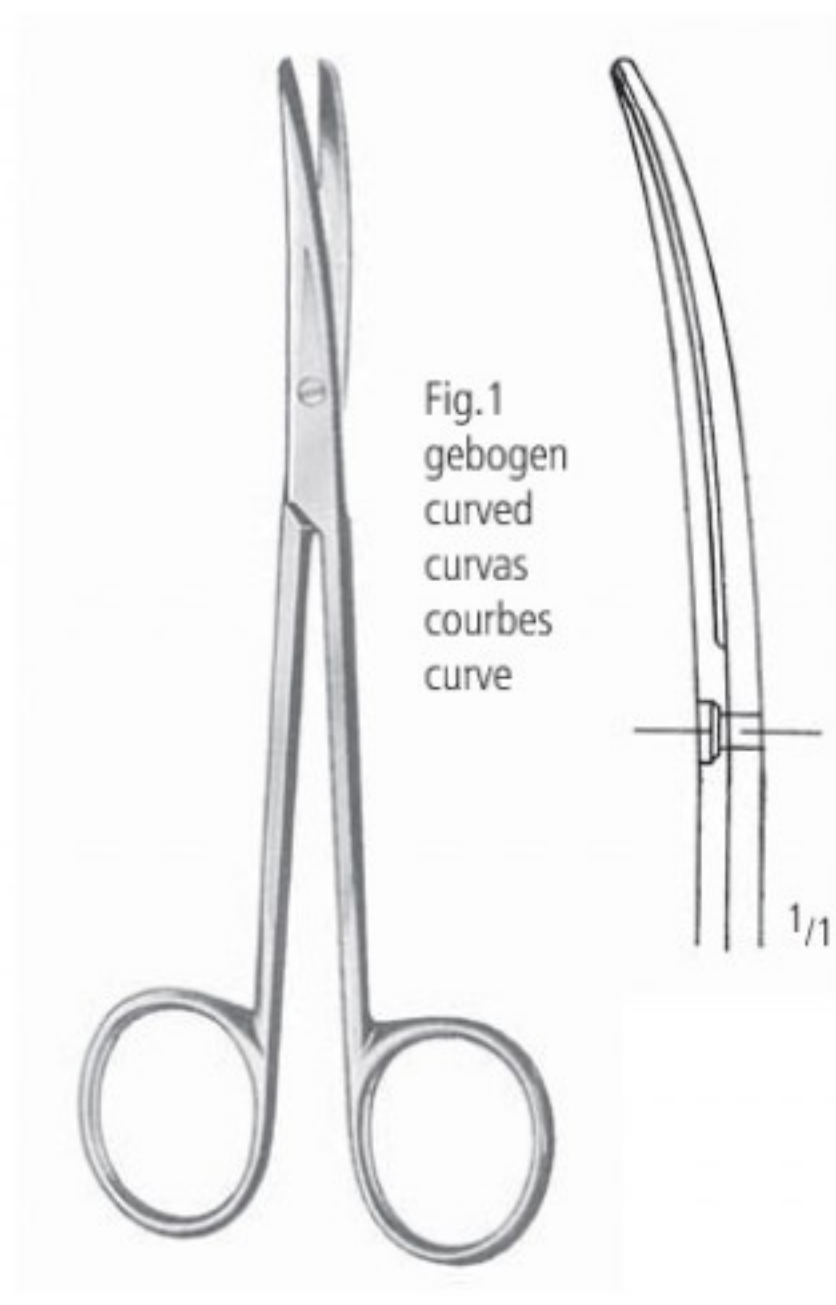

Fig.1
gebogen
curved
curvas
courbes
curve

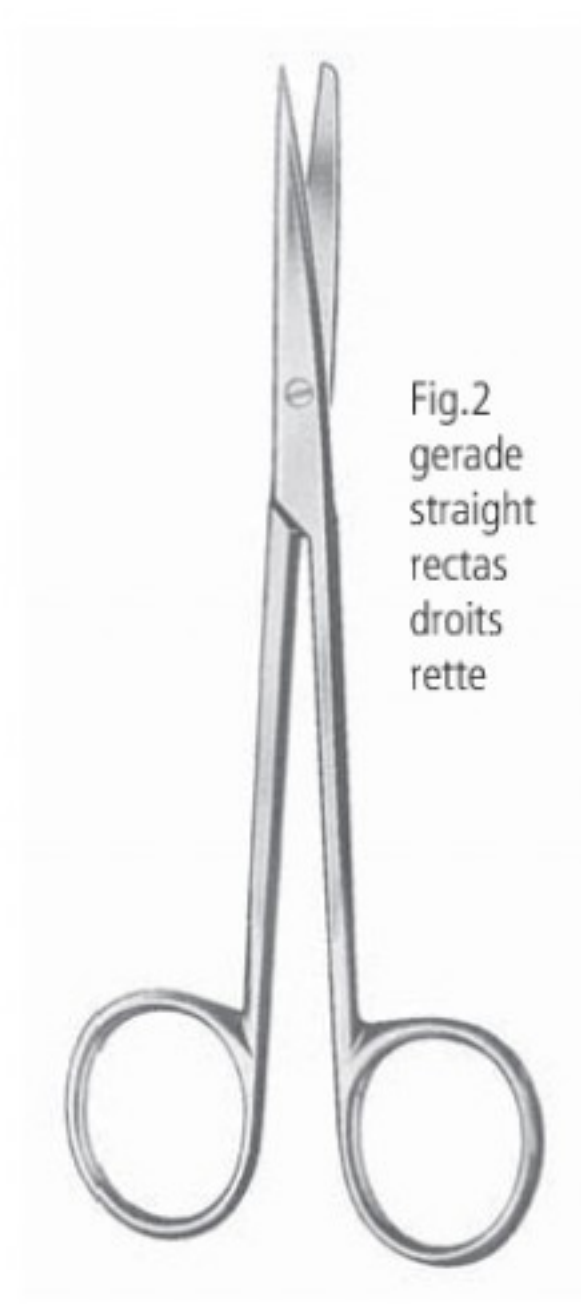

Fig.2
gerade
straight
rectas
droits
rette

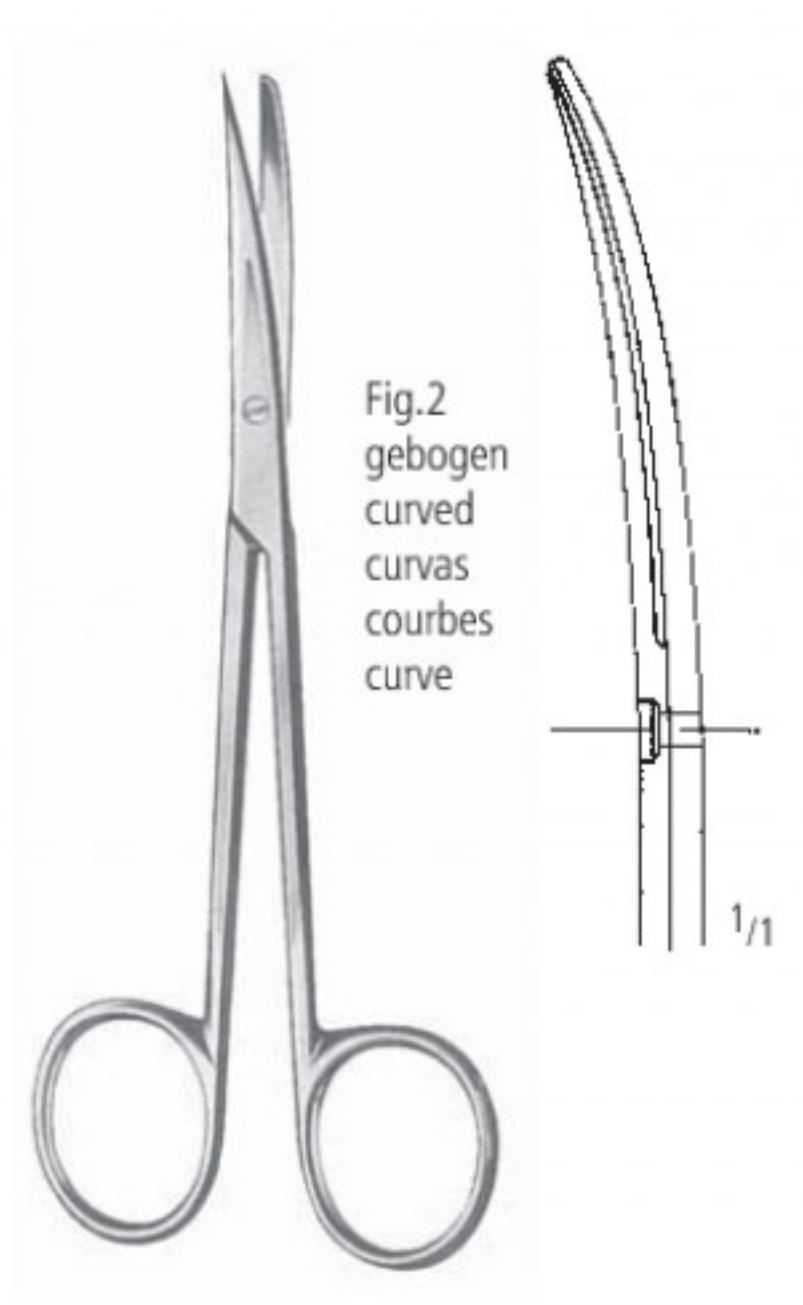

Fig.2
gebogen
curved
curvas
courbes
curve

METZENBAUM

AC 100/14*
14,5 cm/5³/₄"

AC 101/14*
14,5 cm/5³/₄"

METZENBAUM

AC 102/14
14,5 cm/5³/₄"

AC 103/14
14,5 cm/5³/₄"

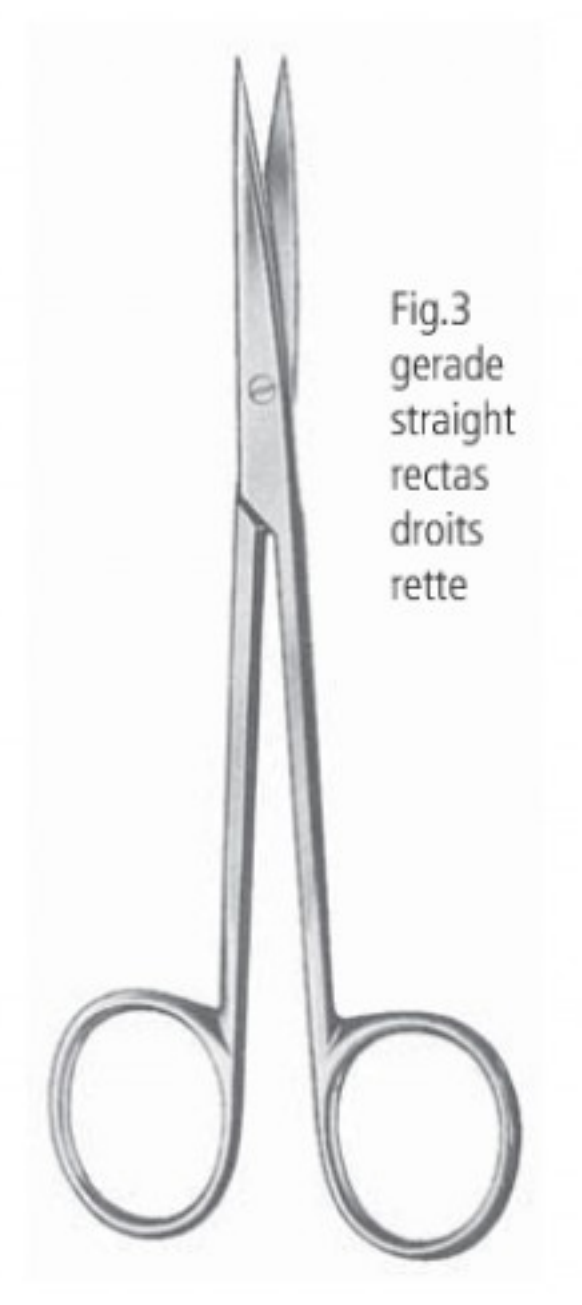

Fig.3
gerade
straight
rectas
droits
rette

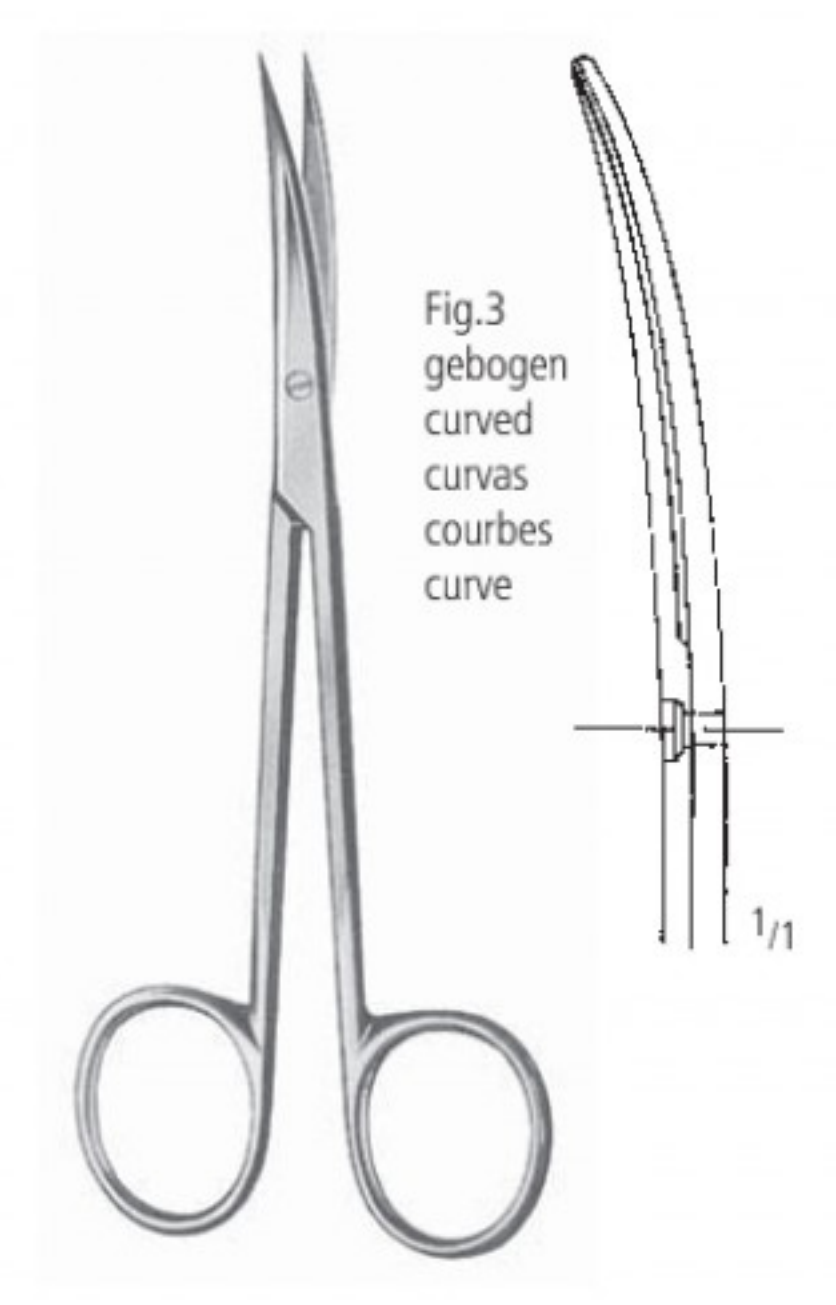
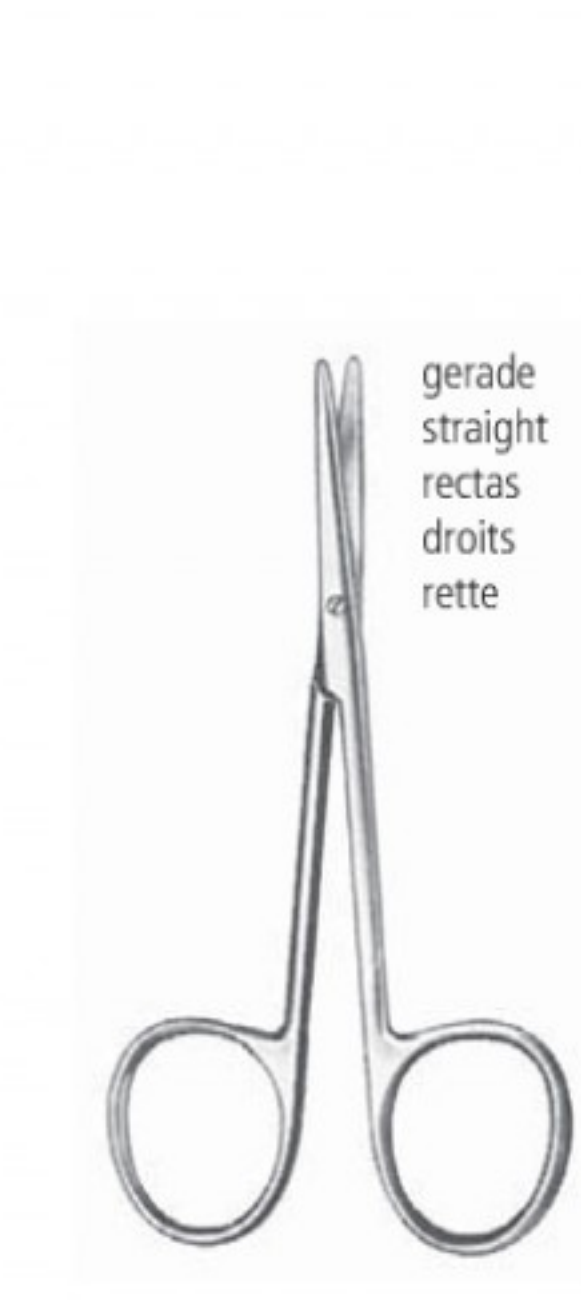
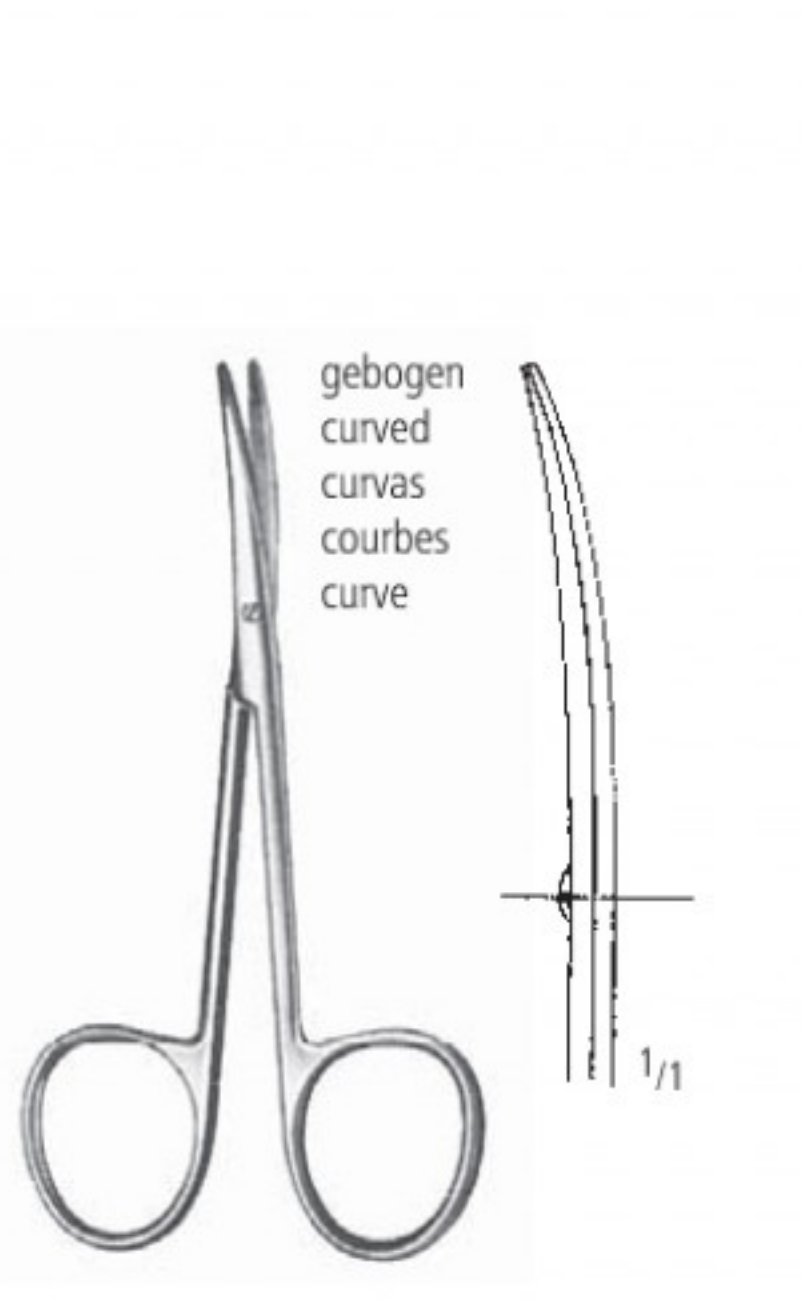

Fig.3
gebogen
curved
curvas
courbes
curve



gerade
straight
rectas
droits
rette



gebogen
curved
curvas
courbes
curve

METZENBAUM

AC 104/14
14,5 cm/5³/₄"

AC 105/14
14,5 cm/5³/₄"

METZENBAUM-BABY

AC 108/11

AC 109/11

11,5 cm/4¹/₂"

* Auch erhältlich als SC

* Also available as SC

Präparierscheren
 Dissecting Scissors
 Tijeras para preparaciones
 Ciseaux à dissection
 Forbici per preparazioni



METZENBAUM-NELSON



METZENBAUM-NELSON



Fig. 1

18,0 cm/7"

AC 110/18*

AC 111/18*



Fig. 2

AC 120/18

AC 121/18



Fig. 3

AC 130/18

AC 131/18

SCHEREN SCISSORS TIJERAS CISEAUX FORBICI

Präparierscheren, DELICATE
 Dissecting Scissors, DELICATE
 Tijeras para preparaciones, DELICATE
 Ciseaux à dissection, DELICATE
 Forbici per preparazioni, DELICATE

METZENBAUM-DELICATE

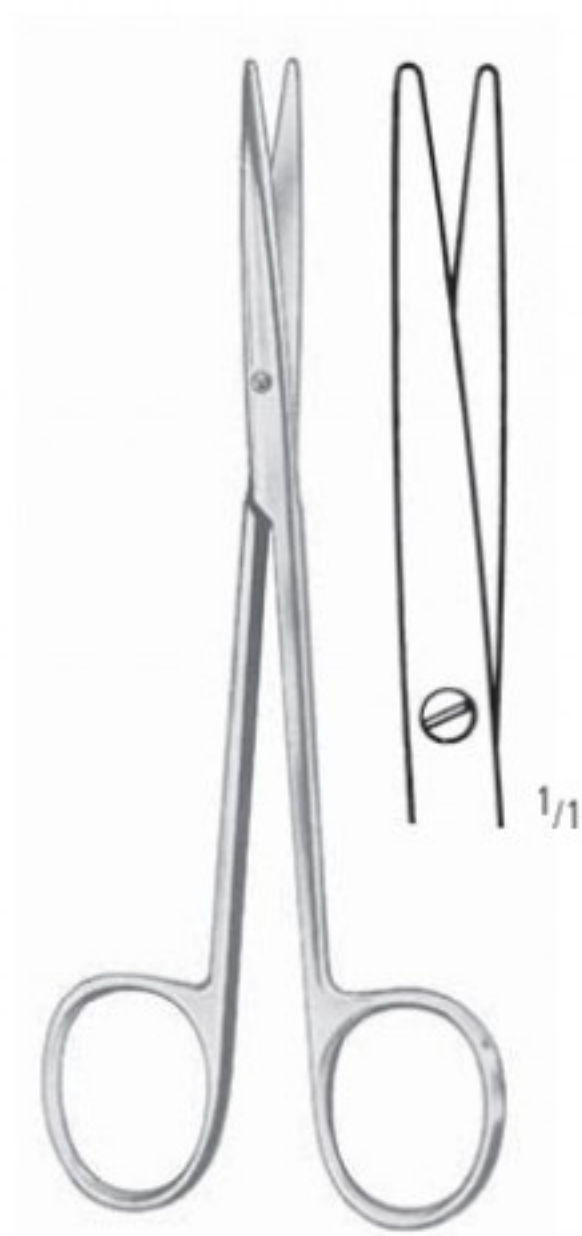

Fig. 1
 AC 140/14*
 14,5 cm/5³/₄"

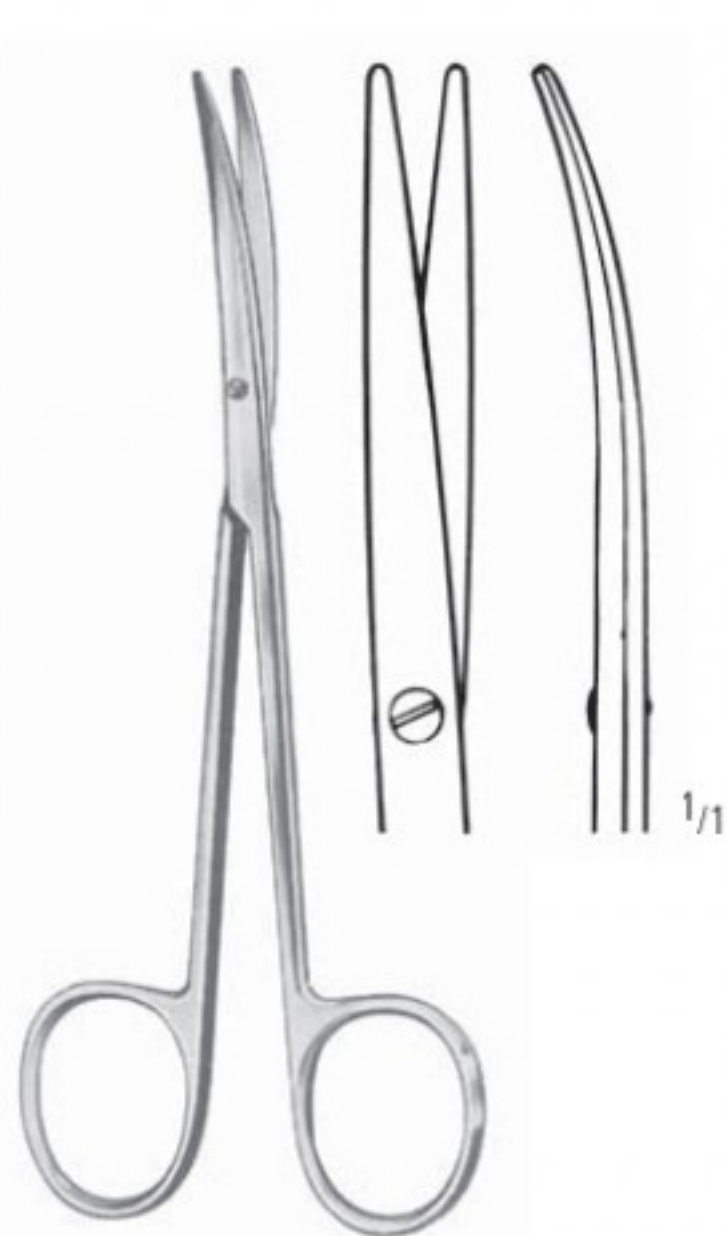

Fig. 1
 AC 141/14*
 14,5 cm/5³/₄"



Fig. 3
 AC 142/14*
 14,5 cm/5³/₄"



Fig. 3
 AC 143/14*
 14,5 cm/5³/₄"

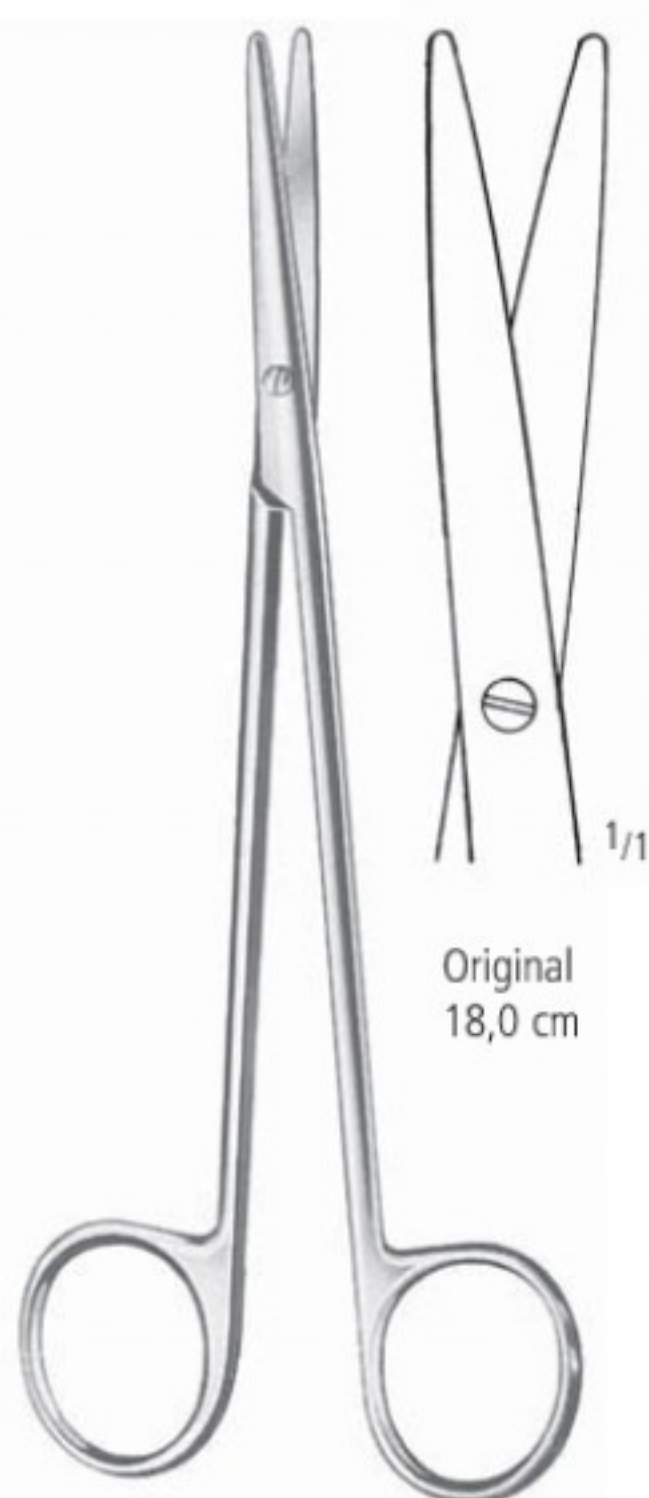

18,0 cm/7"
 Fig. 1
 AC 150/18*

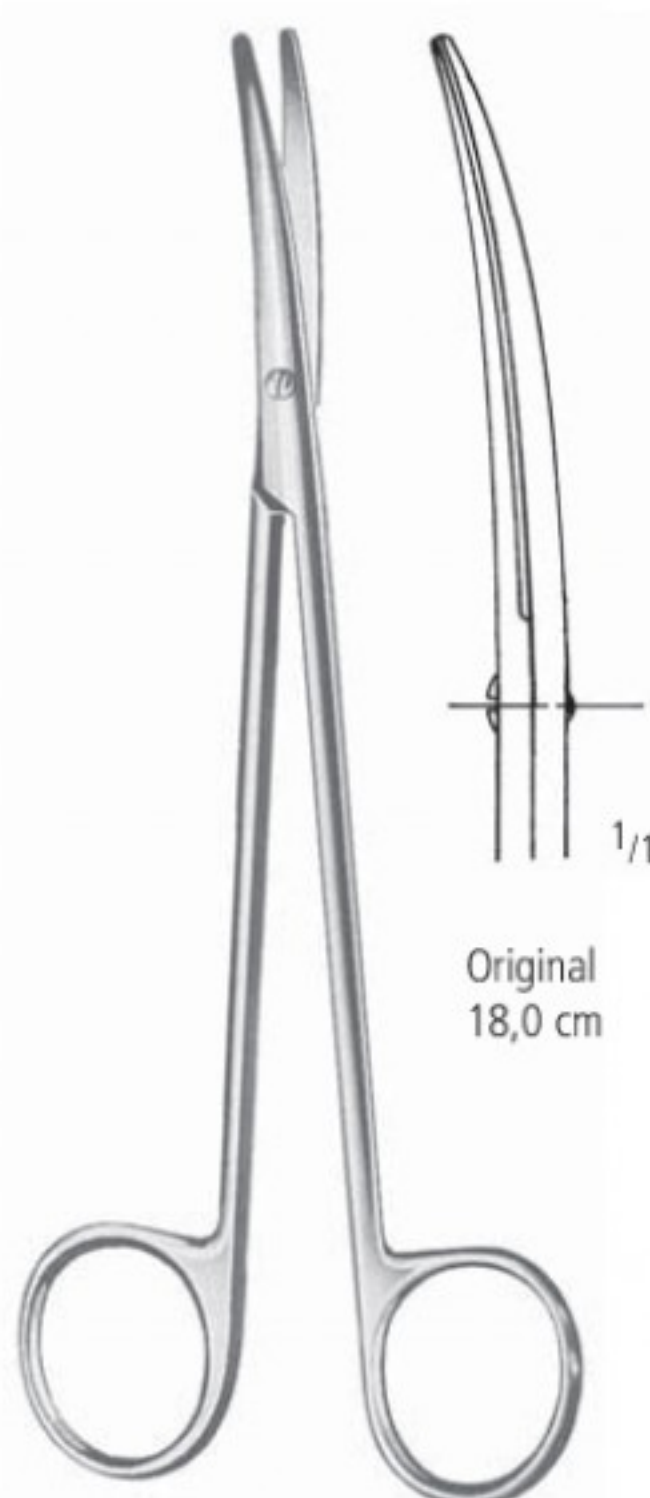

18,0 cm
 Fig. 1
 AC 151/18*

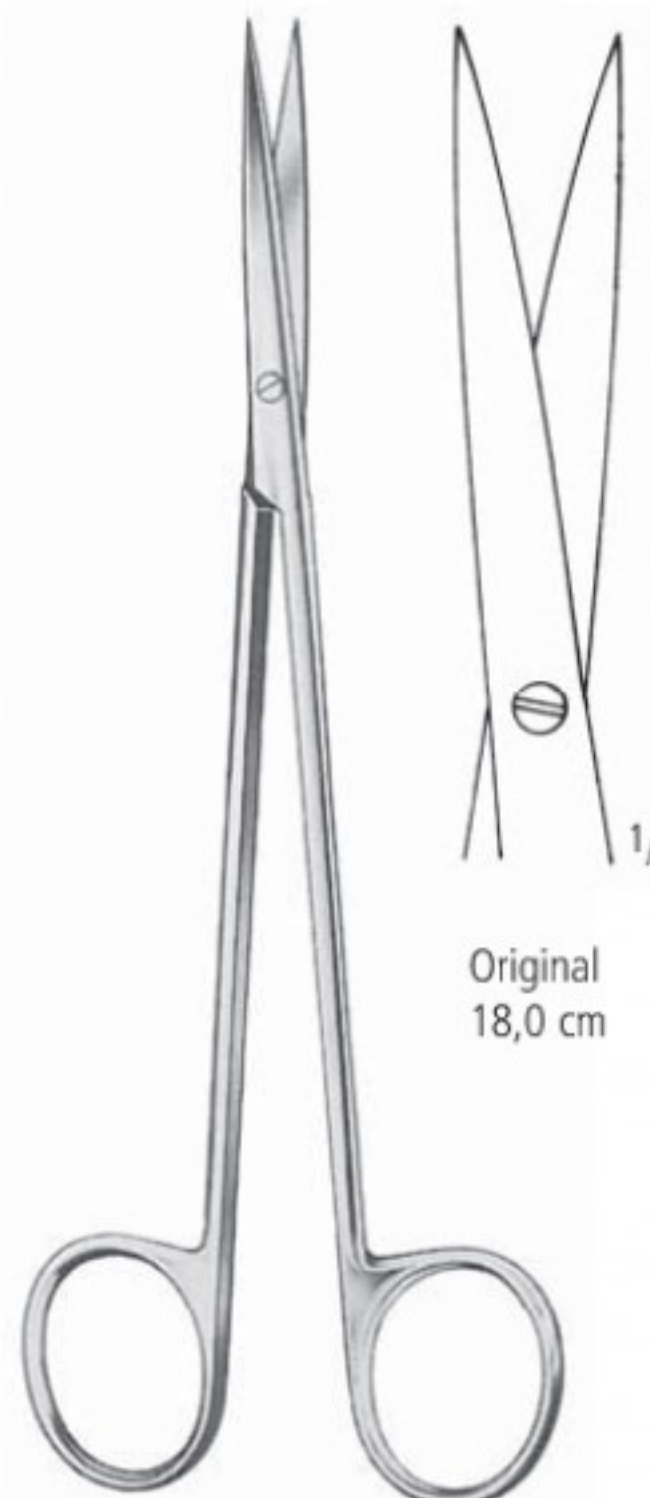

18,0 cm
 Fig. 3
 AC 152/18*

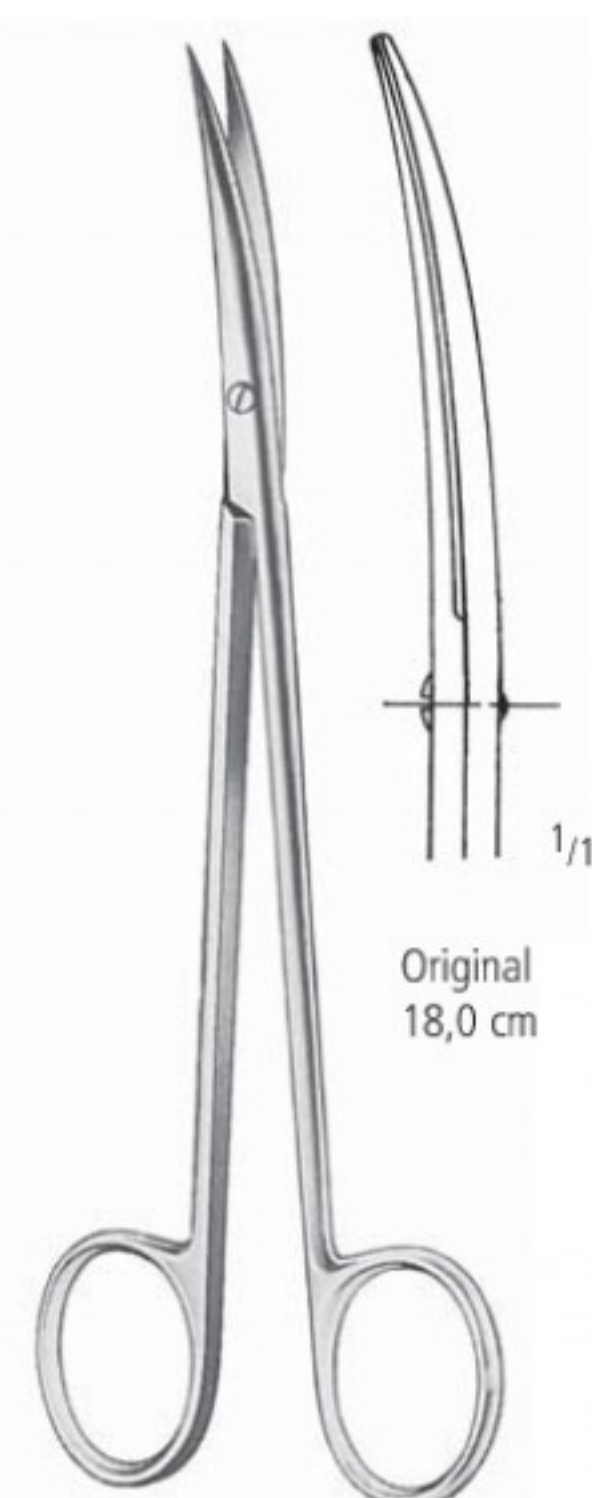

18,0 cm
 Fig. 3
 AC 153/18*

AA
 AB
 AC
 AD
 AE
 AF
 AK
 AL
 AO
 AR
 KA
 KL
 KU
 PA
 PB
 PF
 PI
 PK
 PL
 PM
 PP
 PS
 PT
 PU
 PV
 KYE

AC SCHEREN SCISSORS TIJERAS CISEAUX FORBICI

Präparierscheren
Dissecting Scissors
Tijeras para preparaciones
Ciseaux à dissection
Forbici per preparazioni

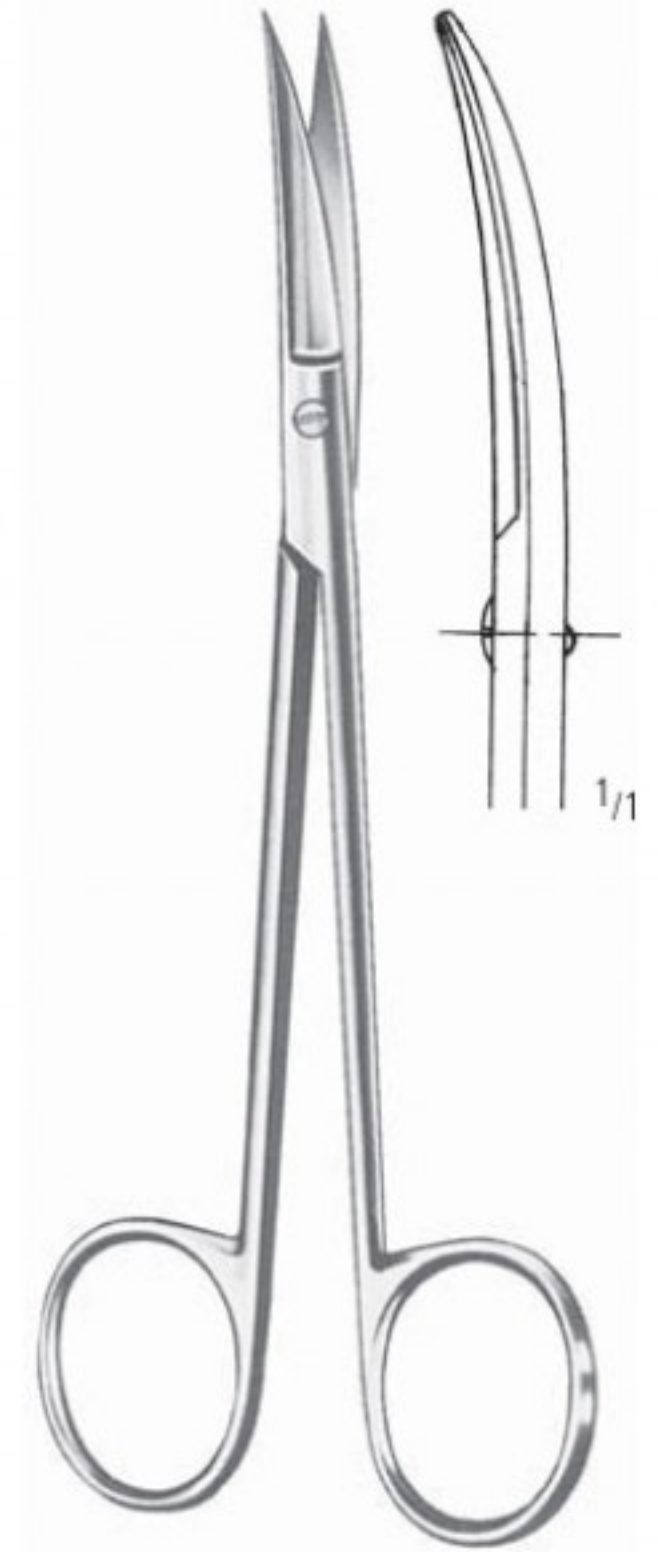
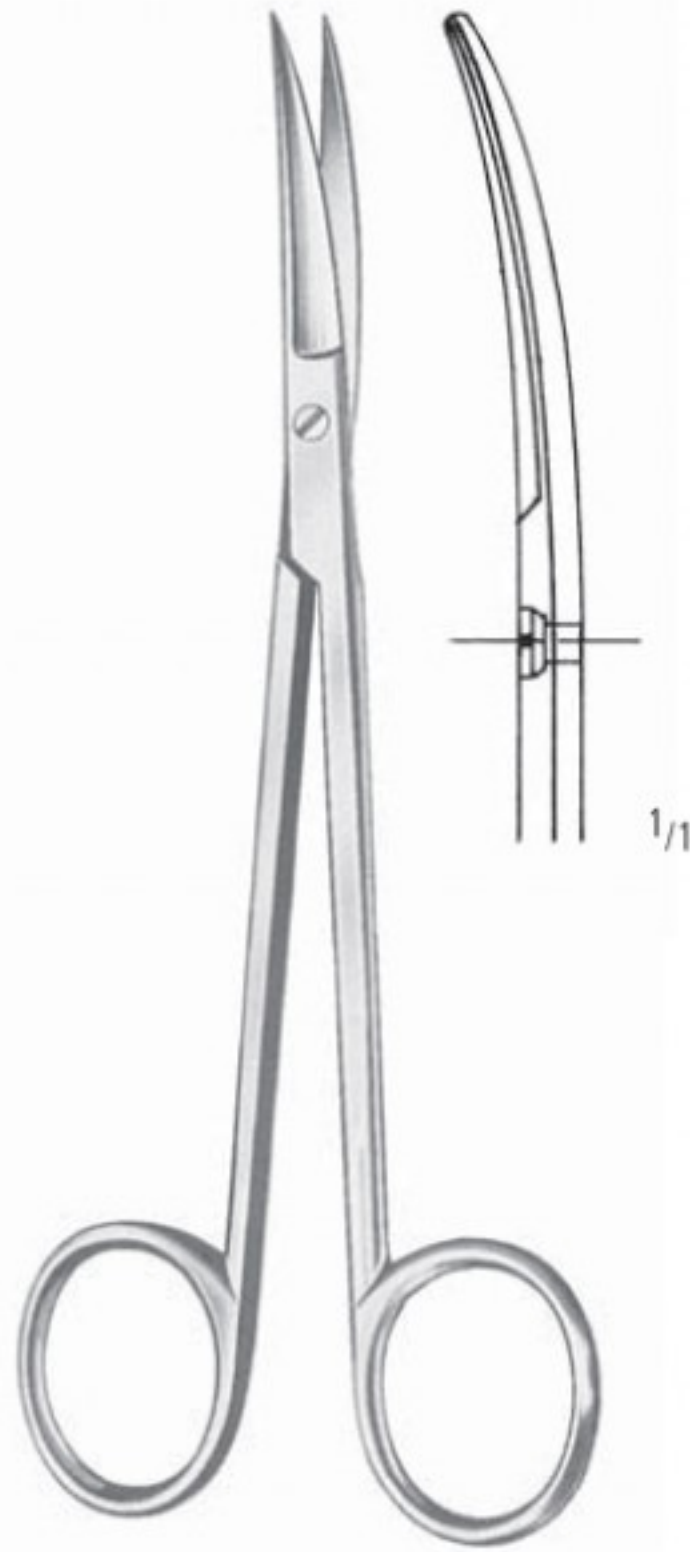

SANVENERO

AC 200/14
14,0 cm/5 1/2"

AC 201/14
14,0 cm/5 1/2"

JOSEPH

AC 204/14
14,0 cm/5 1/2"

AC 205/14
14,0 cm/5 1/2"

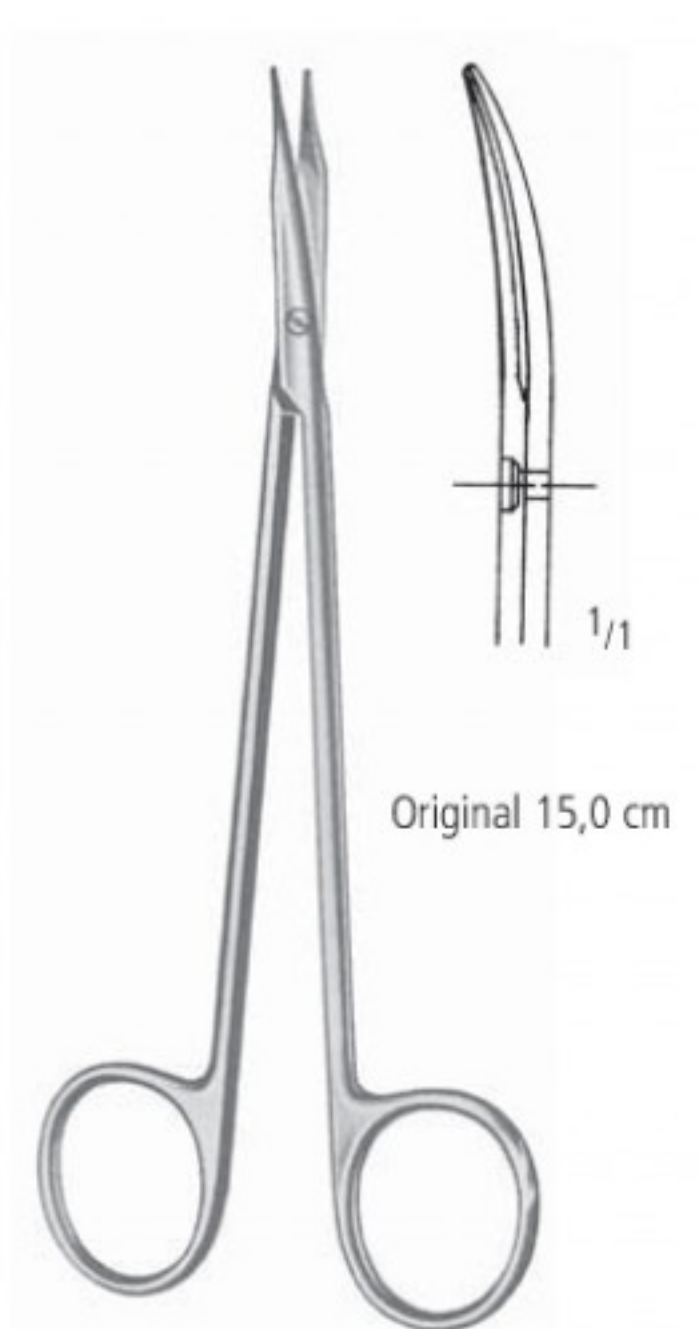
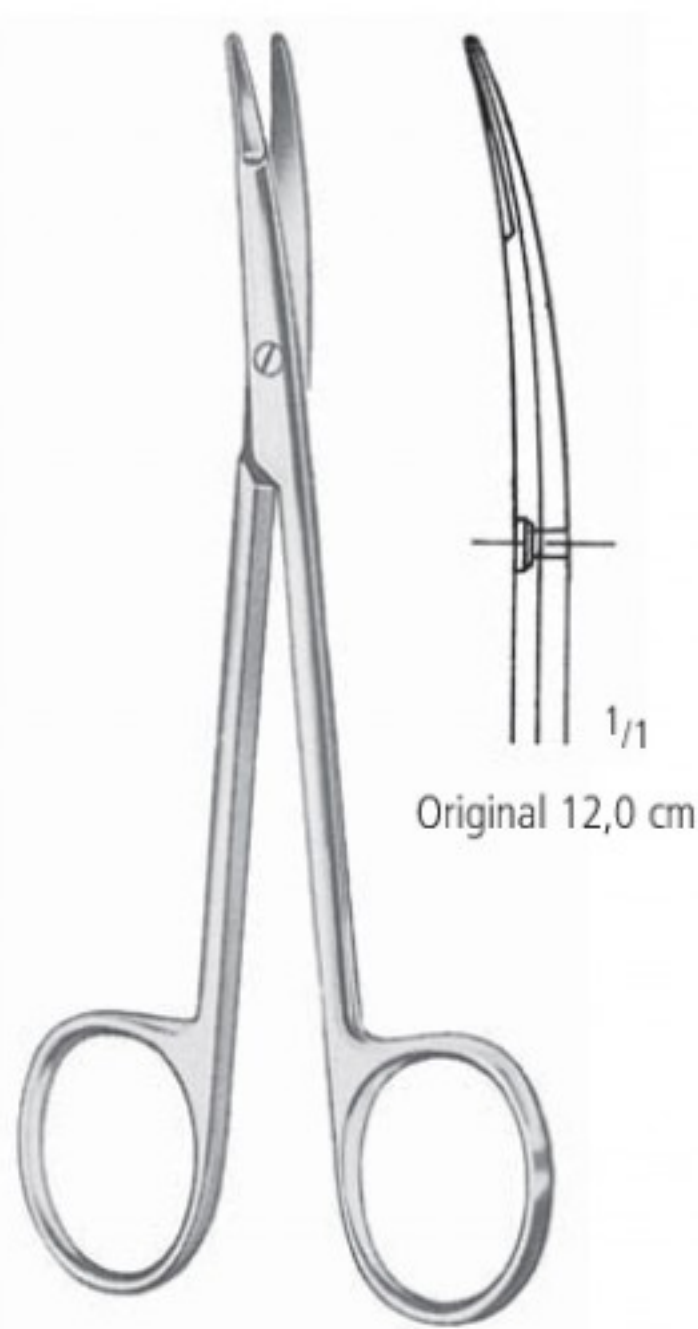

KILNER (RAGNELL)

AC 208/12	12,0 cm/4 3/4"	AC 210/12
AC 208/15	15,0 cm/6"	AC 210/15
AC 208/18	18,0 cm/7"	AC 210/18

REYNOLDS

AC 214/15*	15,0 cm/6"	AC 215/15*
AC 214/18*	18,0 cm/7"	AC 215/18*

SCHEREN SCISSORS TIJERAS CISEAUX FORBICI

Feine chirurgische Scheren
 Fine Operating Scissors
 Tijeras finas para cirugía
 Ciseaux fins à chirurgie
 Forbici fini per chirurgia



WAGNER
 12,0 cm/4³/₄"

gerade
 straight
 rectas
 droits
 rette



Fig. 1
 AC 404/01



Fig. 2
 AC 404/02



Fig. 3
 AC 404/03

gebogen
 curved
 curvas
 courbes
 curve



Fig. 1
 AC 405/01



Fig. 2
 AC 405/02



Fig. 3
 AC 405/03



AC 408/11
 11,0 cm/4¹/₃"



AC 409/11
 11,0 cm/4¹/₃"

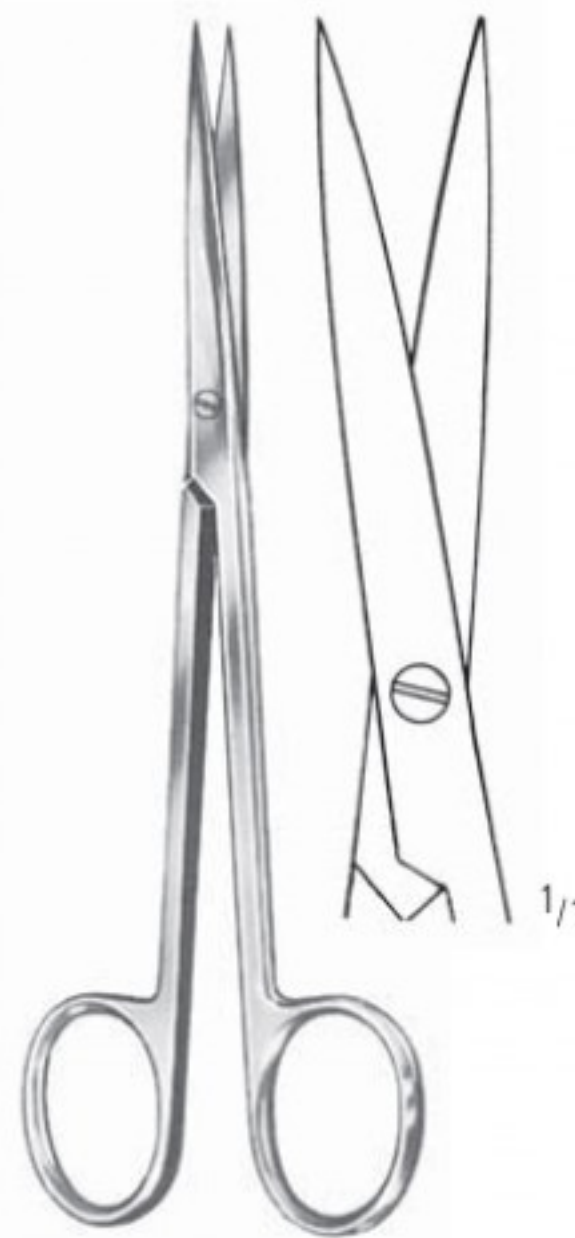

BROPHY (SULLIVAN)
 AC 414/14
 14,5 cm/5³/₄"

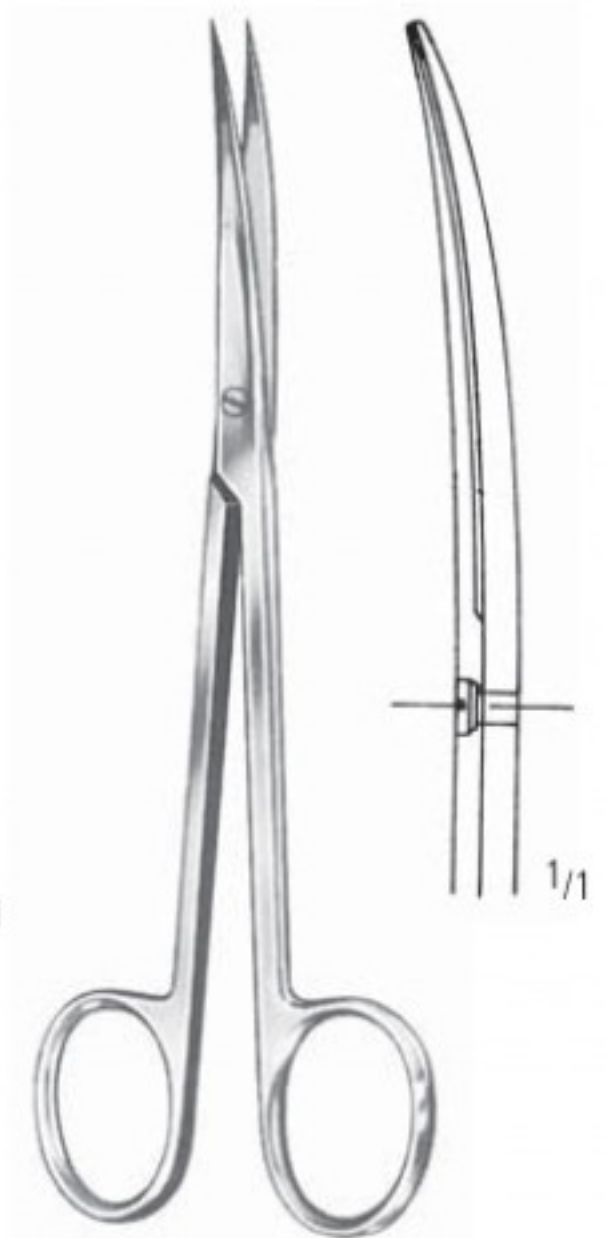

AC 415/14
 14,5 cm/5³/₄"

AA
 AB
 AC
 AD
 AE
 AF
 AG
 AH
 AI
 AJ
 AK
 AL
 AM
 AN
 AO
 AP
 AQ
 AR
 AS
 AT
 AU
 AV
 AW
 AX
 AY
 AZ
 BA
 BB
 BC
 BD
 BE
 BF
 BG
 BH
 BI
 BJ
 BK
 BL
 BM
 BN
 BO
 BP
 BQ
 BR
 BS
 BT
 BU
 BV
 BW
 BX
 BY
 BZ
 CA
 CB
 CC
 CD
 CE
 CF
 CG
 CH
 CI
 CJ
 CK
 CL
 CM
 CN
 CO
 CP
 CQ
 CR
 CS
 CT
 CU
 CV
 CW
 CX
 CY
 CZ
 DA
 DB
 DC
 DD
 DE
 DF
 DG
 DH
 DI
 DJ
 DK
 DL
 DM
 DN
 DO
 DP
 DQ
 DR
 DS
 DT
 DU
 DV
 DW
 DX
 DY
 DZ
 EA
 EB
 EC
 ED
 EE
 EF
 EG
 EH
 EI
 EJ
 EK
 EL
 EM
 EN
 EO
 EP
 EQ
 ER
 ES
 ET
 EU
 EV
 EW
 EX
 EY
 EZ
 FA
 FB
 FC
 FD
 FE
 FF
 FG
 FH
 FI
 FJ
 FK
 FL
 FM
 FN
 FO
 FP
 FQ
 FR
 FS
 FT
 FU
 FV
 FW
 FX
 FY
 FZ
 GA
 GB
 GC
 GD
 GE
 GF
 GG
 GH
 GI
 GJ
 GK
 GL
 GM
 GN
 GO
 GP
 GQ
 GR
 GS
 GT
 GU
 GV
 GW
 GX
 GY
 GZ
 HA
 HB
 HC
 HD
 HE
 HF
 HG
 HH
 HI
 HJ
 HK
 HL
 HM
 HN
 HO
 HP
 HQ
 HR
 HS
 HT
 HU
 HV
 HW
 HX
 HY
 HZ
 IA
 IB
 IC
 ID
 IE
 IF
 IG
 IH
 II
 IJ
 IK
 IL
 IM
 IN
 IO
 IP
 IQ
 IR
 IS
 IT
 IU
 IV
 IW
 IX
 IY
 IZ
 JA
 JB
 JC
 JD
 JE
 JF
 JG
 JH
 JI
 JJ
 JK
 JL
 JM
 JN
 JO
 JP
 JQ
 JR
 JS
 JT
 JU
 JV
 JW
 JX
 JY
 JZ
 KA
 KB
 KC
 KD
 KE
 KF
 KG
 KH
 KI
 KJ
 KK
 KL
 KM
 KN
 KO
 KP
 KQ
 KR
 KS
 KT
 KU
 KV
 KW
 KX
 KY
 KZ
 LA
 LB
 LC
 LD
 LE
 LF
 LG
 LH
 LI
 LJ
 LK
 LL
 LM
 LN
 LO
 LP
 LQ
 LR
 LS
 LT
 LU
 LV
 LW
 LX
 LY
 LZ
 MA
 MB
 MC
 MD
 ME
 MF
 MG
 MH
 MI
 MJ
 MK
 ML
 MM
 MN
 MO
 MP
 MQ
 MR
 MS
 MT
 MU
 MV
 MW
 MX
 MY
 MZ
 NA
 NB
 NC
 ND
 NE
 NF
 NG
 NH
 NI
 NJ
 NK
 NL
 NM
 NN
 NO
 NP
 NQ
 NR
 NS
 NT
 NU
 NV
 NW
 NX
 NY
 NZ
 OA
 OB
 OC
 OD
 OE
 OF
 OG
 OH
 OI
 OJ
 OK
 OL
 OM
 ON
 OO
 OP
 OQ
 OR
 OS
 OT
 OU
 OV
 OW
 OX
 OY
 OZ
 PA
 PB
 PC
 PD
 PE
 PF
 PG
 PH
 PI
 PJ
 PK
 PL
 PM
 PN
 PO
 PP
 PQ
 PR
 PS
 PT
 PU
 PV
 PW
 PX
 PY
 PZ
 QA
 QB
 QC
 QD
 QE
 QF
 QG
 QH
 QI
 QJ
 QK
 QL
 QM
 QN
 QO
 QP
 QQ
 QR
 QS
 QT
 QU
 QV
 QW
 QX
 QY
 QZ
 RA
 RB
 RC
 RD
 RE
 RF
 RG
 RH
 RI
 RJ
 RK
 RL
 RM
 RN
 RO
 RP
 RQ
 RR
 RS
 RT
 RU
 RV
 RW
 RX
 RY
 RZ
 SA
 SB
 SC
 SD
 SE
 SF
 SG
 SH
 SI
 SJ
 SK
 SL
 SM
 SN
 SO
 SP
 SQ
 SR
 SS
 ST
 SU
 SV
 SW
 SX
 SY
 SZ
 TA
 TB
 TC
 TD
 TE
 TF
 TG
 TH
 TI
 TJ
 TK
 TL
 TM
 TN
 TO
 TP
 TQ
 TR
 TS
 TT
 TU
 TV
 TW
 TX
 TY
 TZ
 UA
 UB
 UC
 UD
 UE
 UF
 UG
 UH
 UI
 UJ
 UK
 UL
 UM
 UN
 UO
 UP
 UQ
 UR
 US
 UT
 UY
 UZ
 VA
 VB
 VC
 VD
 VE
 VF
 VG
 VH
 VI
 VJ
 VK
 VL
 VM
 VN
 VO
 VP
 VQ
 VR
 VS
 VT
 VU
 VV
 VW
 VX
 VY
 VZ
 WA
 WB
 WC
 WD
 WE
 WF
 WG
 WH
 WI
 WJ
 WK
 WL
 WM
 WN
 WO
 WP
 WQ
 WR
 WS
 WT
 WU
 WV
 WW
 WX
 WY
 WZ
 XA
 XB
 XC
 XD
 XE
 XF
 XG
 XH
 XI
 XJ
 XK
 XL
 XM
 XN
 XO
 XP
 XQ
 XR
 XS
 XT
 XU
 XV
 XW
 XX
 XY
 XZ
 YA
 YB
 YC
 YD
 YE
 YF
 YG
 YH
 YI
 YJ
 YK
 YL
 YM
 YN
 YO
 YP
 YQ
 YR
 YS
 YT
 YU
 YV
 YW
 YX
 YZ
 ZA
 ZB
 ZC
 ZD
 ZE
 ZF
 ZG
 ZH
 ZI
 ZJ
 ZK
 ZL
 ZM
 ZN
 ZO
 ZP
 ZQ
 ZR
 ZS
 ZT
 ZU
 ZV
 ZW
 ZX
 ZY
 ZZ

AC SCHEREN SCISSORS TIJERAS CISEAUX FORBICI

Feine Scheren
 Fine Scissors
 Tijeras finas
 Ciseaux fins
 Forbici fini



11,5 cm/4 1/2"

Fig. 1

gerade
 straight
 rectas
 droits
 droits
 rette

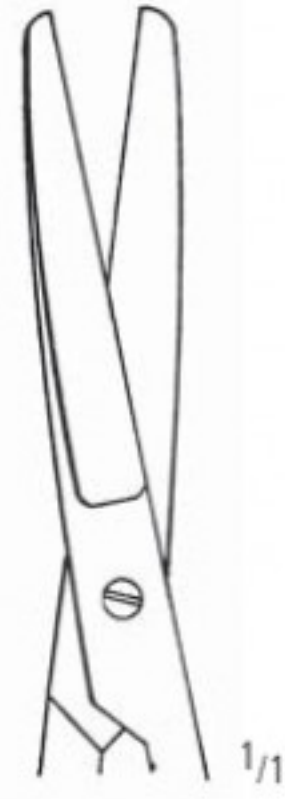

AC 446/01

Fig. 2

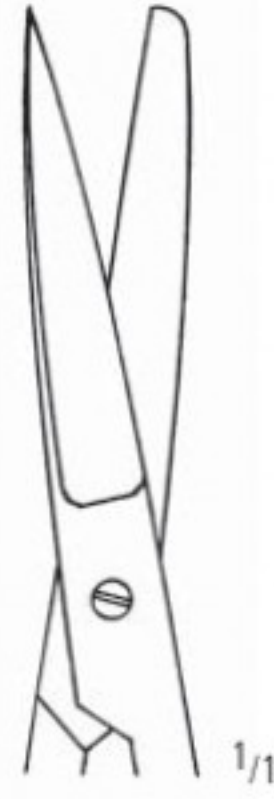

AC 446/02

Fig. 1

gebogen
 curved
 curvas
 courbes
 curve



AC 447/01

Fig. 2



AC 447/02



AC 448/11
 11,5 cm/4 1/2"



AC 449/11
 11,5 cm/4 1/2"

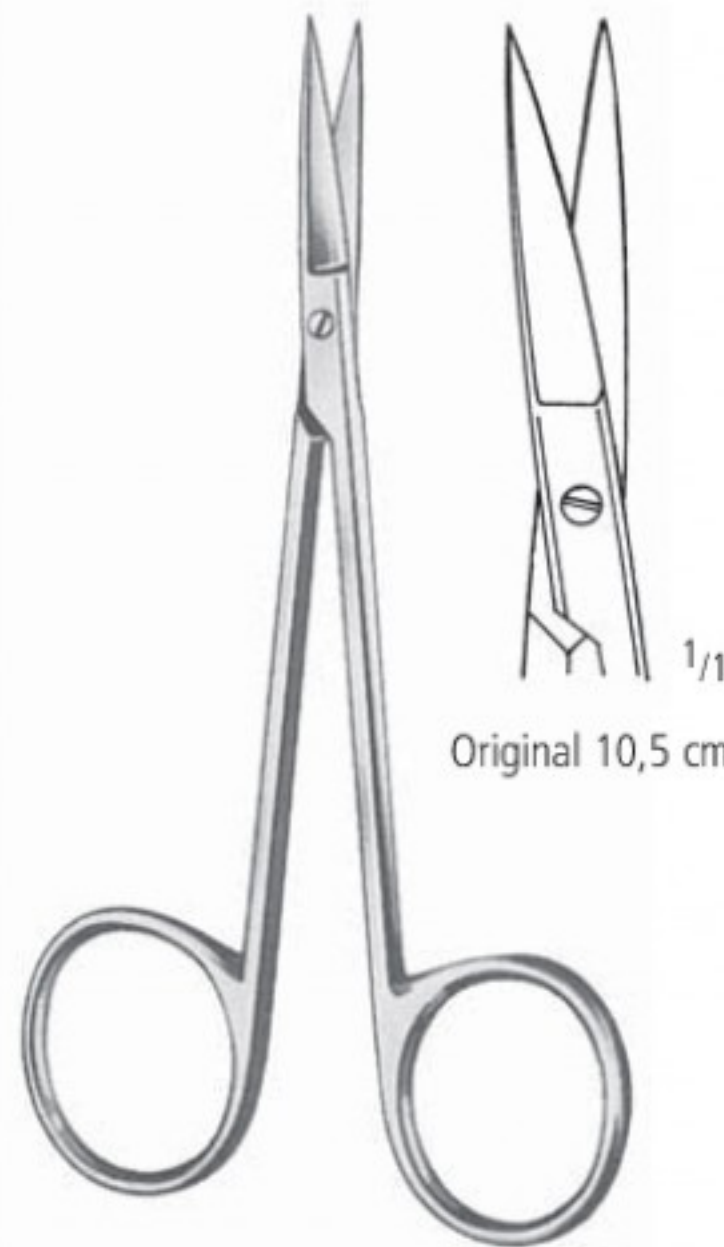

Original 10,5 cm

9,0 cm/3 1/2"
 10,5 cm/4 1/4"
 11,5 cm/4 1/2"

AC 450/09
 AC 450/10
 AC 450/11

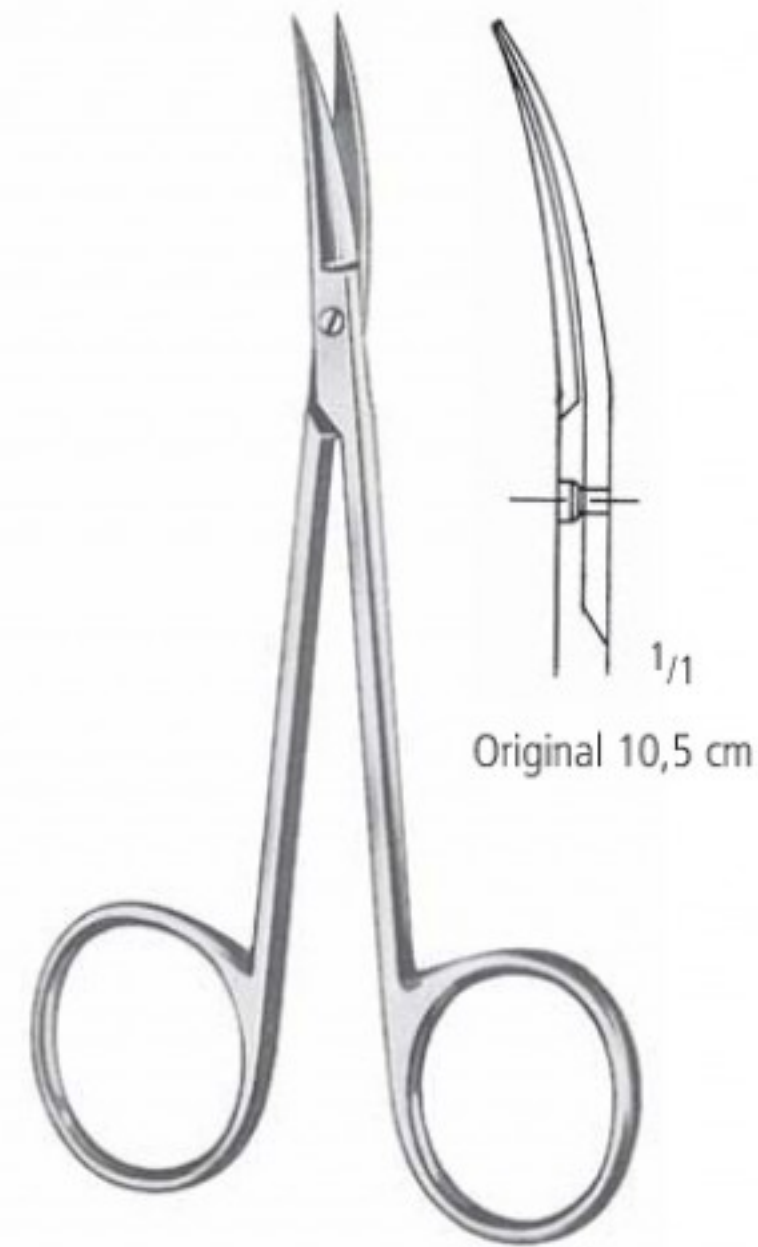

Original 10,5 cm

AC 451/09
 AC 451/10
 AC 451/11

SCHEREN SCISSORS TIJERAS CISEAUX FORBICI

Feine Scheren
Fine Scissors
Tijeras finas
Ciseaux fins
Forbici fini

mit großen Ringen
with large bows
con anillos grandes
avec grands anneaux
con anelli grandi

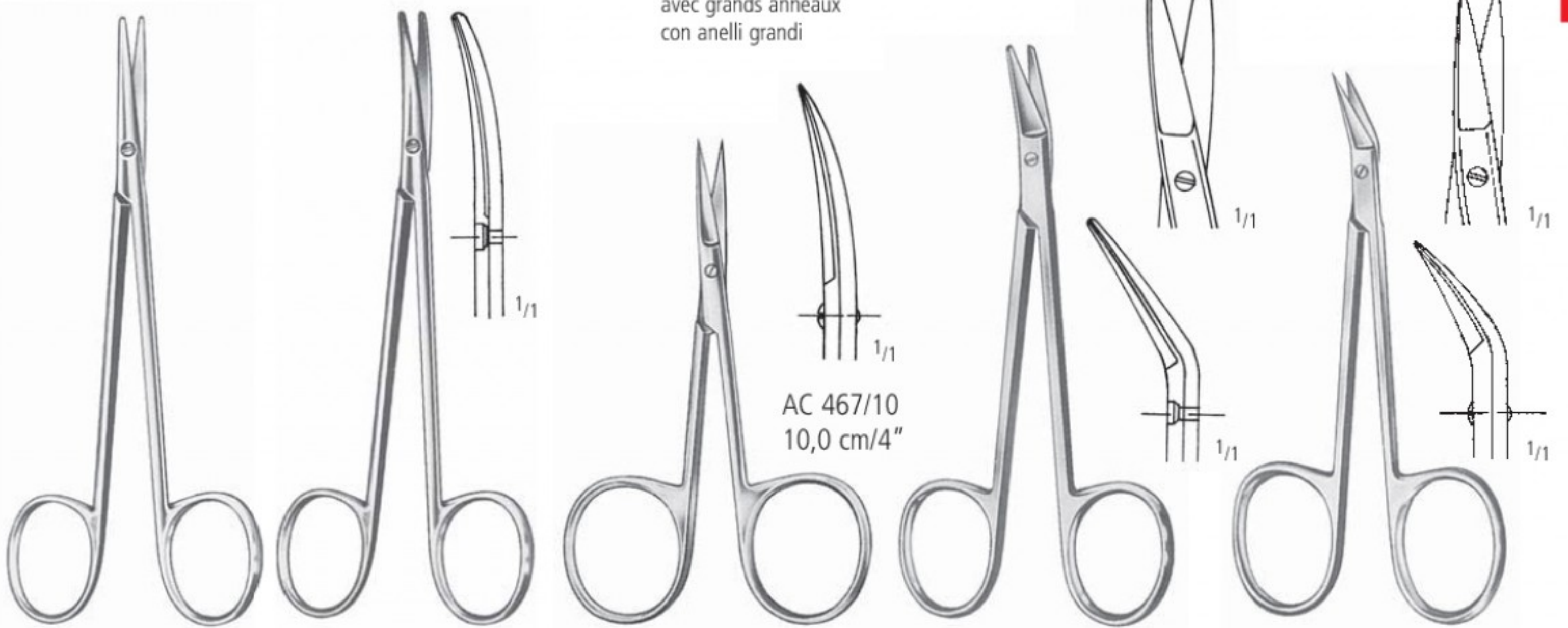

AC 460/11
11,5 cm/4 1/2"

AC 461/11
11,5 cm/4 1/2"

AC 466/10
10,0 cm/4"

GRAEFE
AC 469/10
10,5 cm/4 1/4"

WILMER
AC 471/10
10,0 cm/4"



Original 11,5 cm

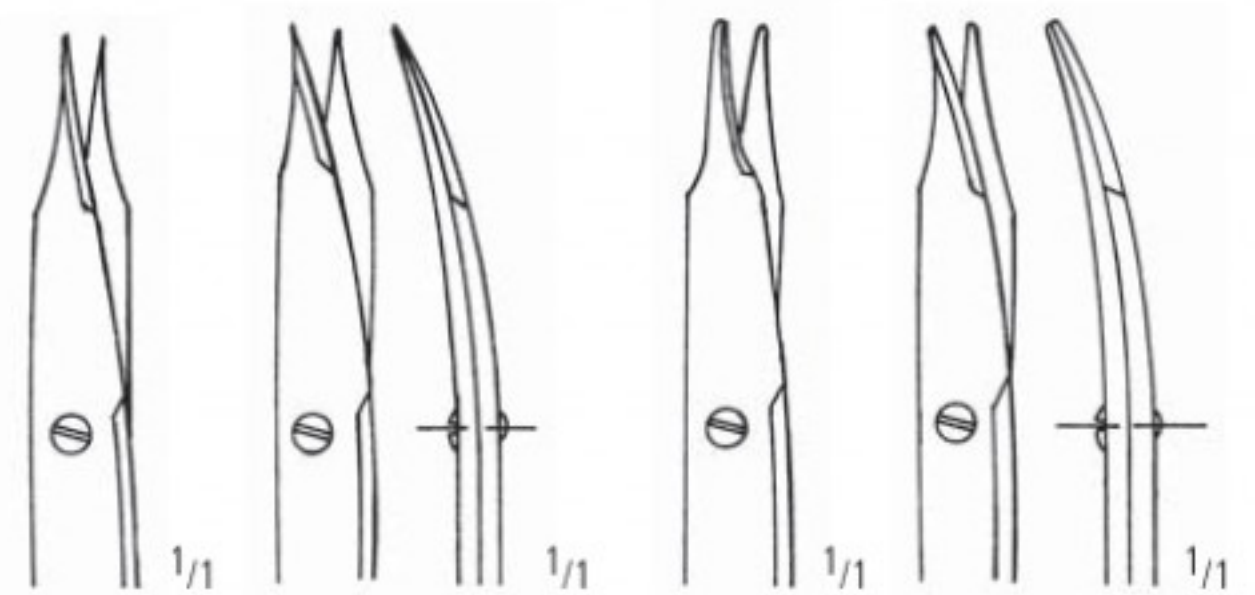

spitz
pointed
agudas
pointues
acuta

stumpf
blunt
romas
mousses
smussa

gerade
straight
rectas
droits
rette

gebogen
curved
curvas
courbes
curve

gerade
straight
rectas
droits
rette

gebogen
curved
curvas
courbes
curve

LA GRANGE
AC 472/11
11,5 cm/4 1/2"

CHADWICK
AC 473/11
11,0 cm/4 1/3"

STEVENS
10,5 cm/4 1/4"
11,5 cm/4 1/2"

AC 474/10
AC 474/11

AC 475/10
AC 475/11

AC 476/10
AC 476/11*

AC 477/10
AC 477/11

* Auch erhältlich als SC

* Also available as SC

AA
AB
AC
AD
AE
AF
AK
AL
AO
AR
KA
KL
KU
PA
PB
PF
PI
PK
PL
PM
PP
PS
PT
PU
PV
KYE

Ligaturscheren
Ligature Scissors
Tijeras para ligaduras
Ciseaux à ligatures
Forbici per legatura



SPENCER

9,0 cm/3¹/₂" AC 500/09
10,5 cm/4¹/₄" AC 500/10
12,5 cm/5" AC 500/13



SPENCER-DELICATE

AC 501/11
11,0 cm/4¹/₃"



LITTAUER

AC 502/14
14,0 cm/5¹/₂"



AC 503/16
16,0 cm/6¹/₄"



EISELSBERG

AC 504/12
11,0 cm/4¹/₃"



SCHOEMAKER-LOTH

AC 505/12
12,5 cm/5"



AC 506/11
11,5 cm/4¹/₂"

SCHEREN SCISSORS TIJERAS CISEAUX FORBICI

Draht- und Kronenscheren
 Wire Cutting and Crown Scissors
 Cizallas para cortar alambre, Tijeras para coronas
 Cisailles pour fils, Ciseaux à couronnes
 Forbici per filo metallico e per corone

AA
 AB
 AC
 AD
 AE
 AF
 AK
 AL
 AO
 AR
 KA
 KL
 KU
 PA
 PB
 PF
 PI
 PK
 PL
 PM
 PP
 PS
 PT
 PU
 PV
 KYE

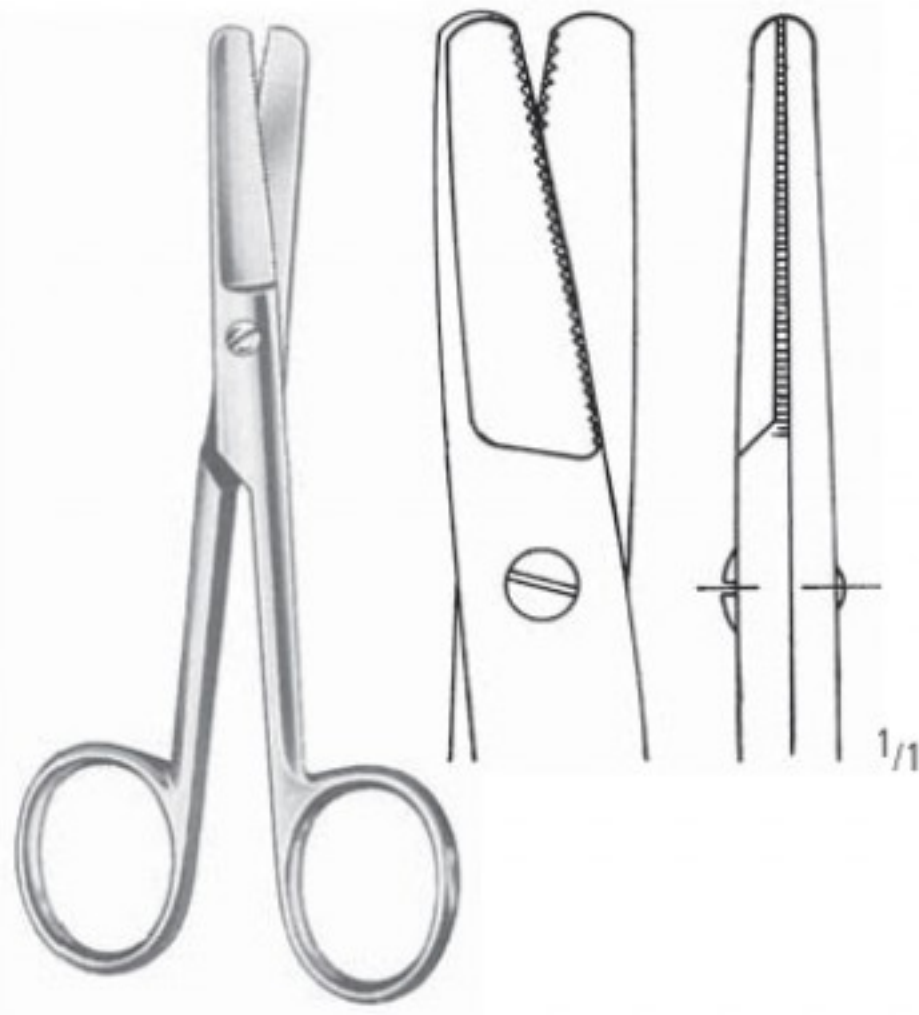

HARVEY
 AC 520/12
 12,5 cm/5"

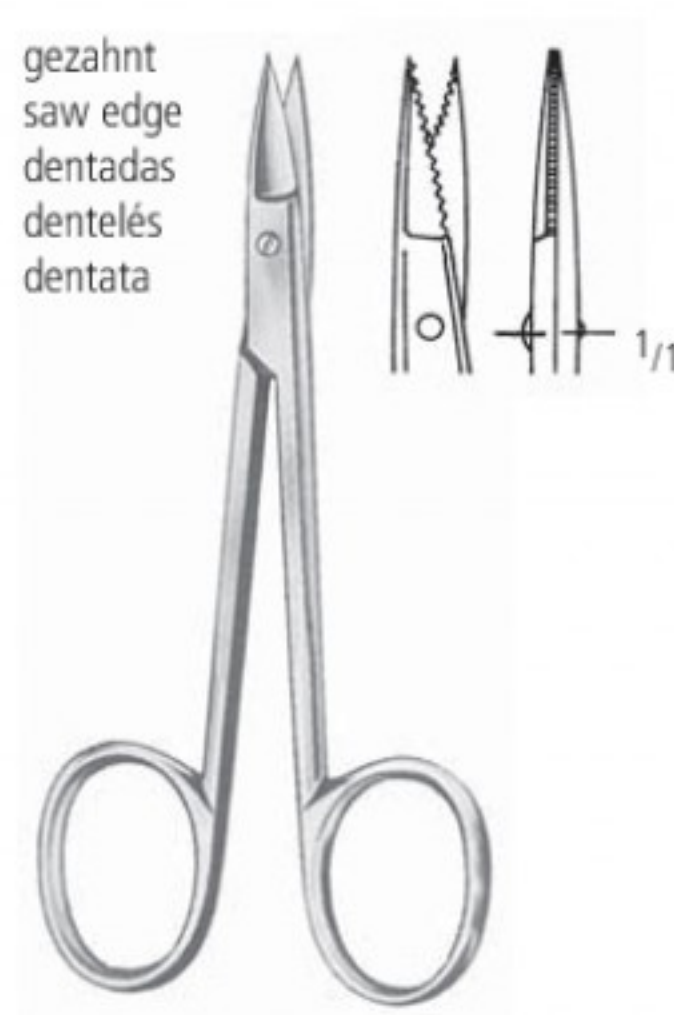

SCHUKNECHT
 AC 521/10
 10,0 cm/4"

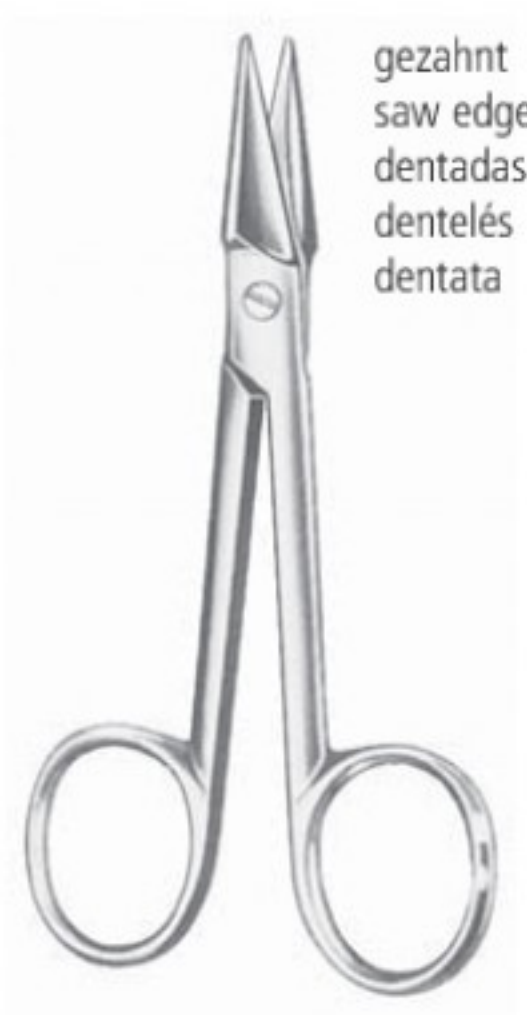

AC 522/11
 11,0 cm/4¹/₃"

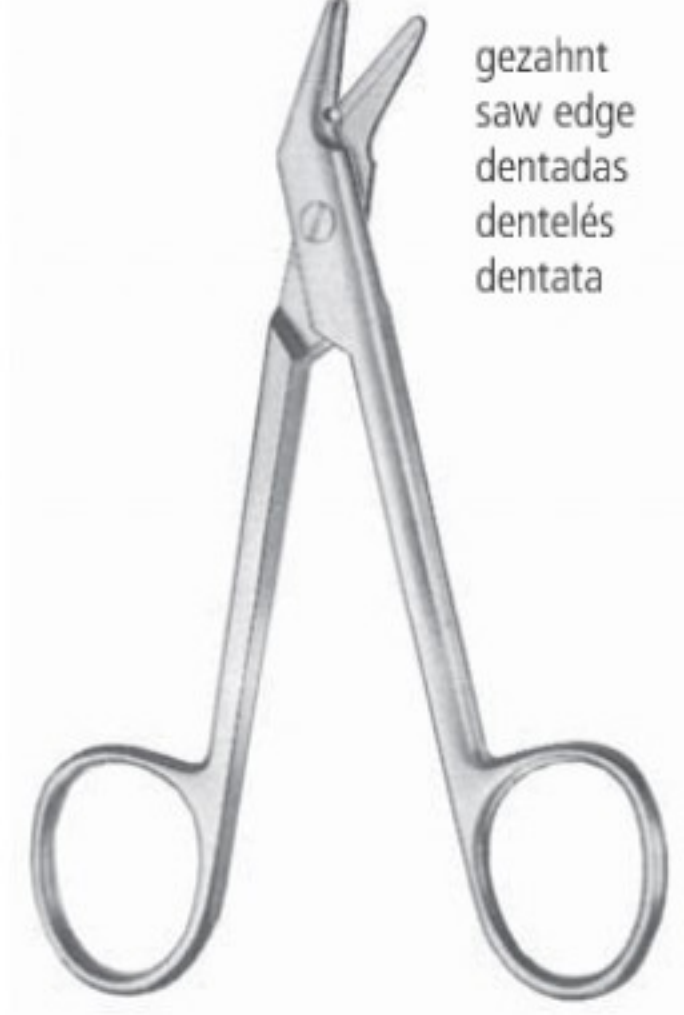

UNIVERSAL
 AC 524/12
 12,0 cm/4³/₄"



SMITH
 AC 525/17
 17,5 cm/7"

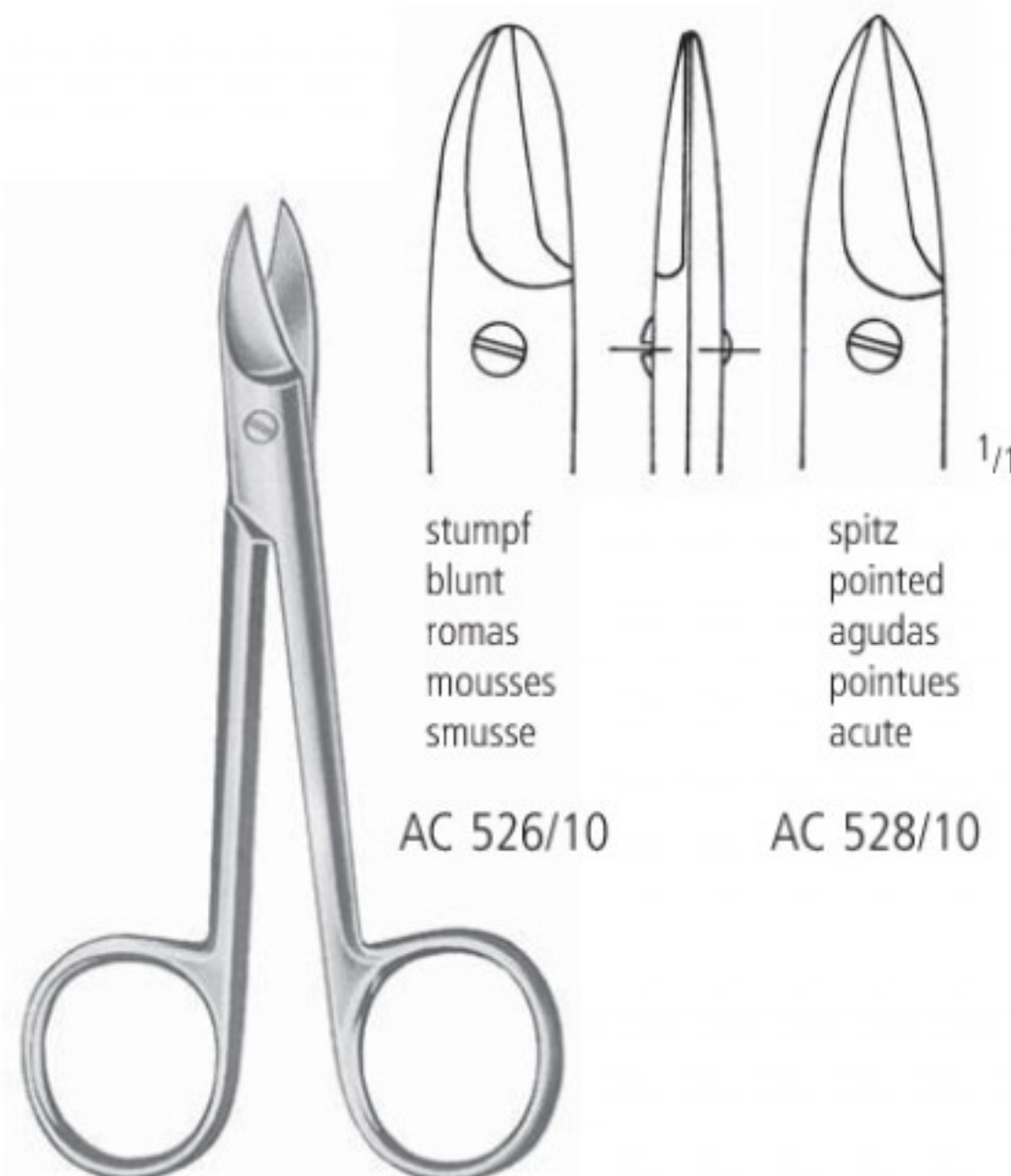

BEEBEE
 10,5 cm/4¹/₄"
 gerade - straight - rectas - droits - rette

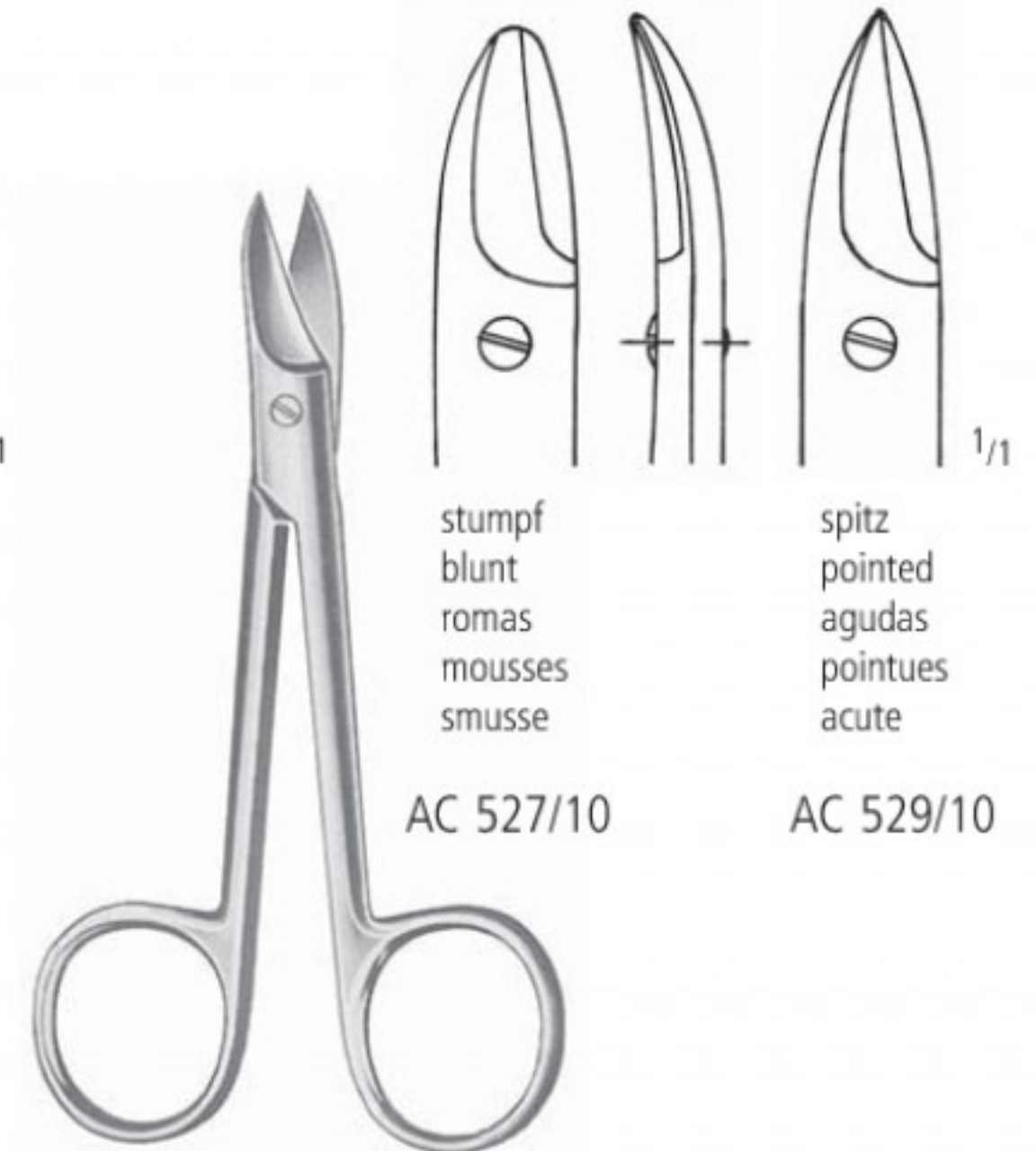

BEEBEE
 10,5 cm/4¹/₄"
 gebogen - curved - curvas - courbes - curve

AC SCHEREN SCISSORS TIJERAS CISEAUX FORBICI

Kronenscheren
 Crown Scissors
 Tijeras para coronas
 Ciseaux à couronnes
 Forbici per corone

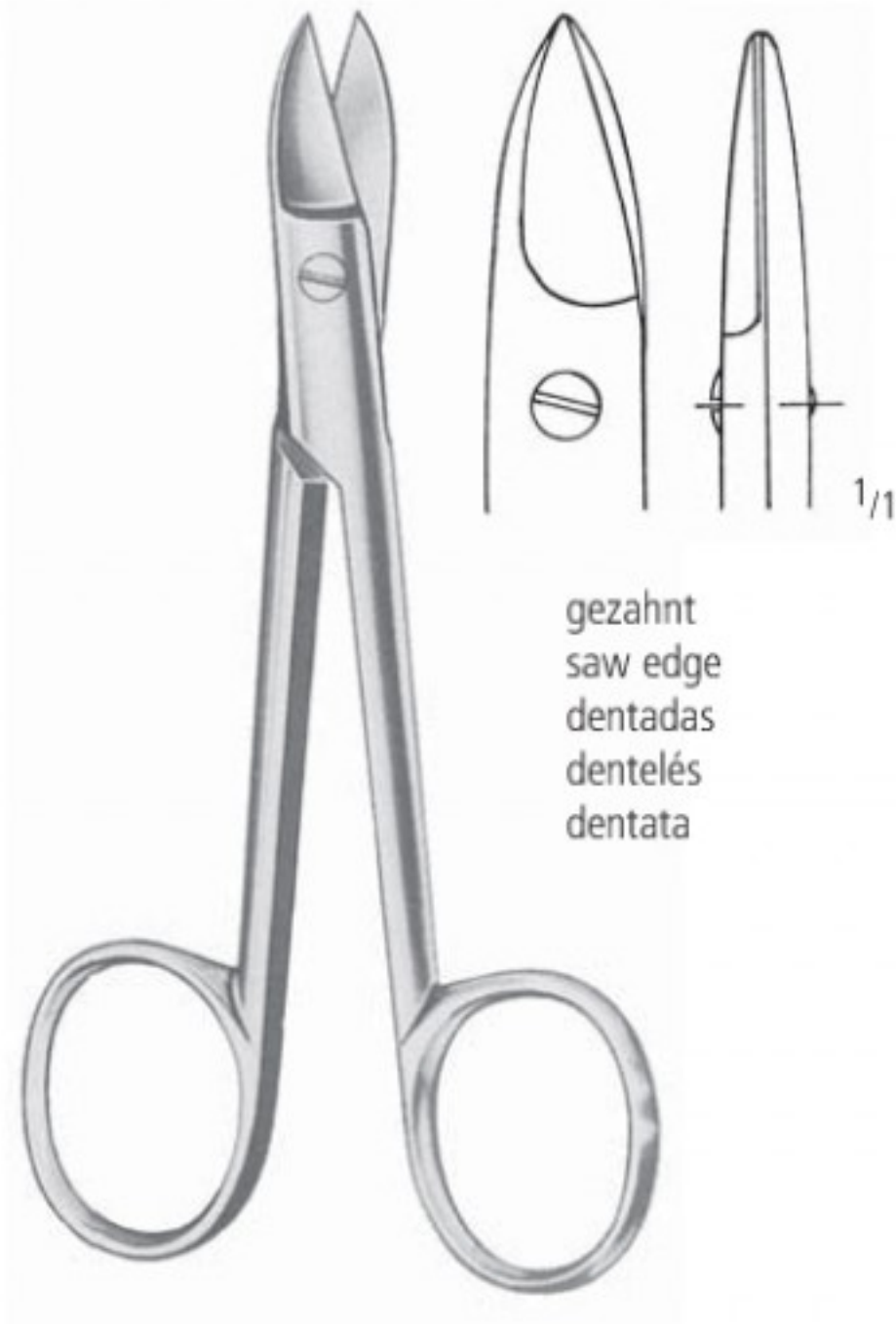

gezahnt
 saw edge
 dentadas
 dentelés
 dentata

BEEBEE
 AC 530/12
 12,0 cm/4³/₄"

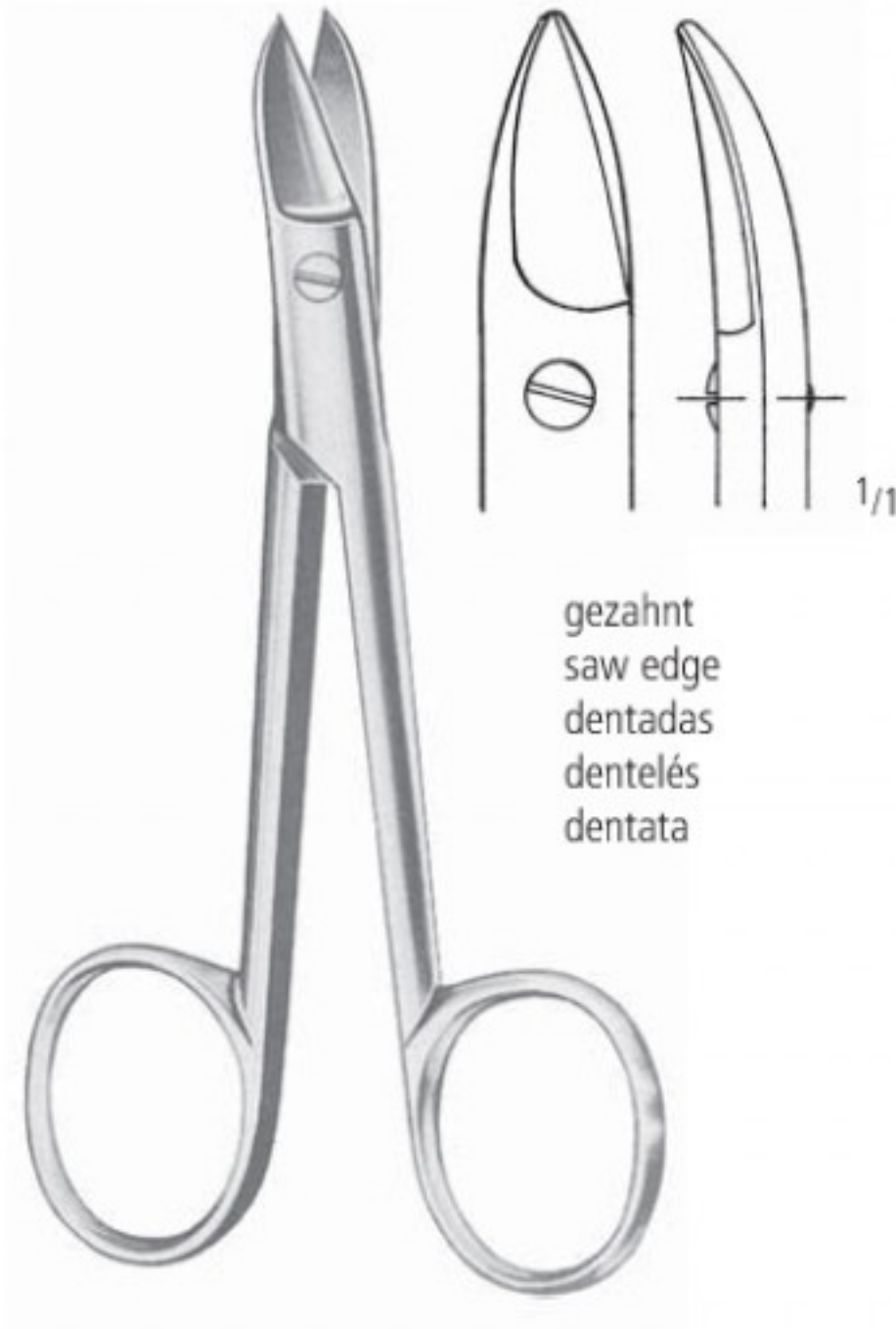

gezahnt
 saw edge
 dentadas
 dentelés
 dentata

BEEBEE
 AC 531/12
 12,0 cm/4³/₄"



AC 535/10
 10,5 cm/4¹/₄"



AC 536/09
 9,0 cm/3¹/₂"



AC 537/09
 9,0 cm/3¹/₂"



AC 538/11
 11,0 cm/4¹/₃"



AC 539/11
 11,0 cm/4¹/₃"

SCHEREN SCISSORS TIJERAS CISEAUX FORBICI

Zahnfleischscheren
Gum Scissors
Tijeras para encias
Ciseaux à gencives
Forbici per gengiva

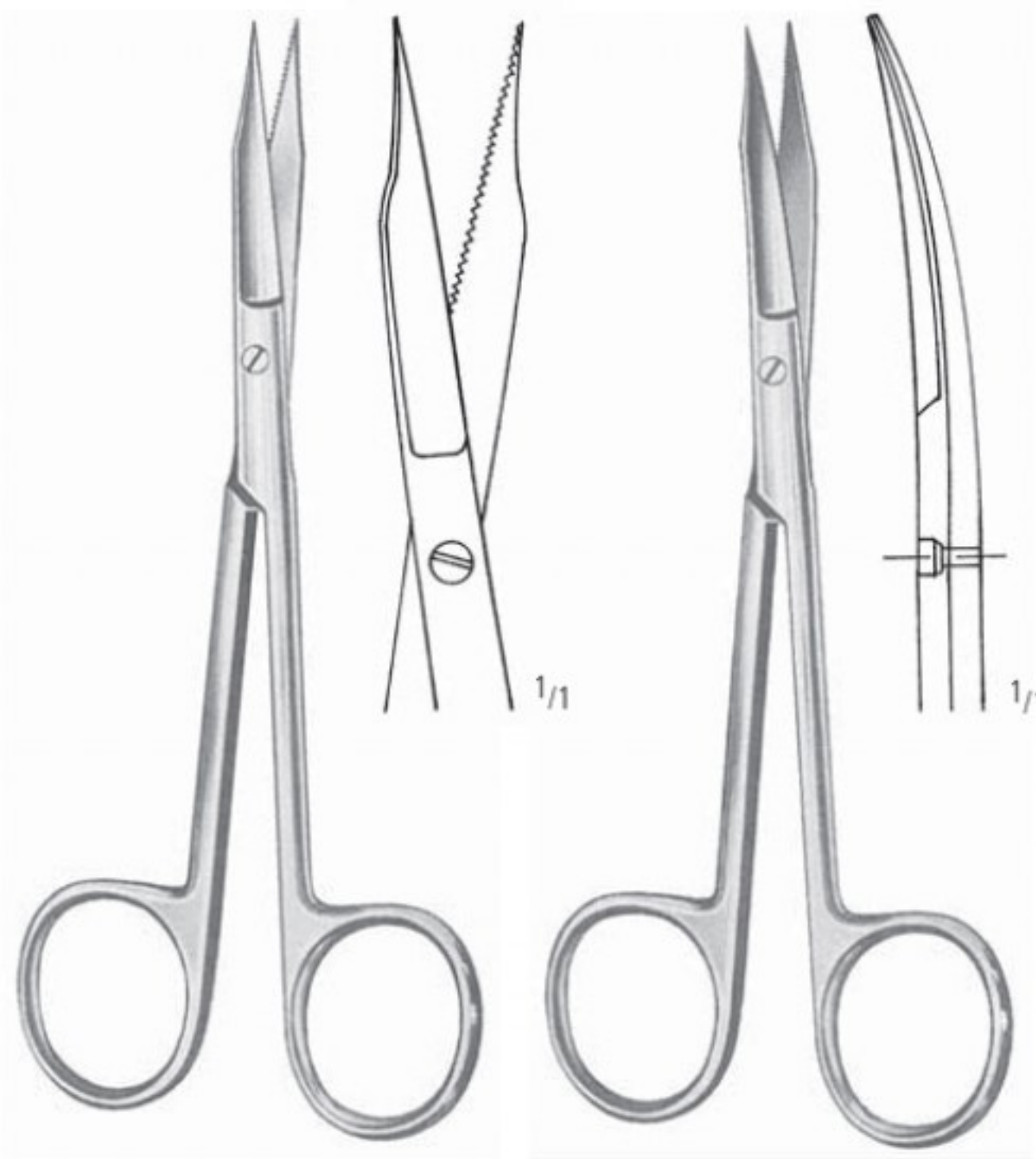

GOLDMAN-FOX

AC 630/13
13,0 cm/5"

AC 631/13
13,0 cm/5"

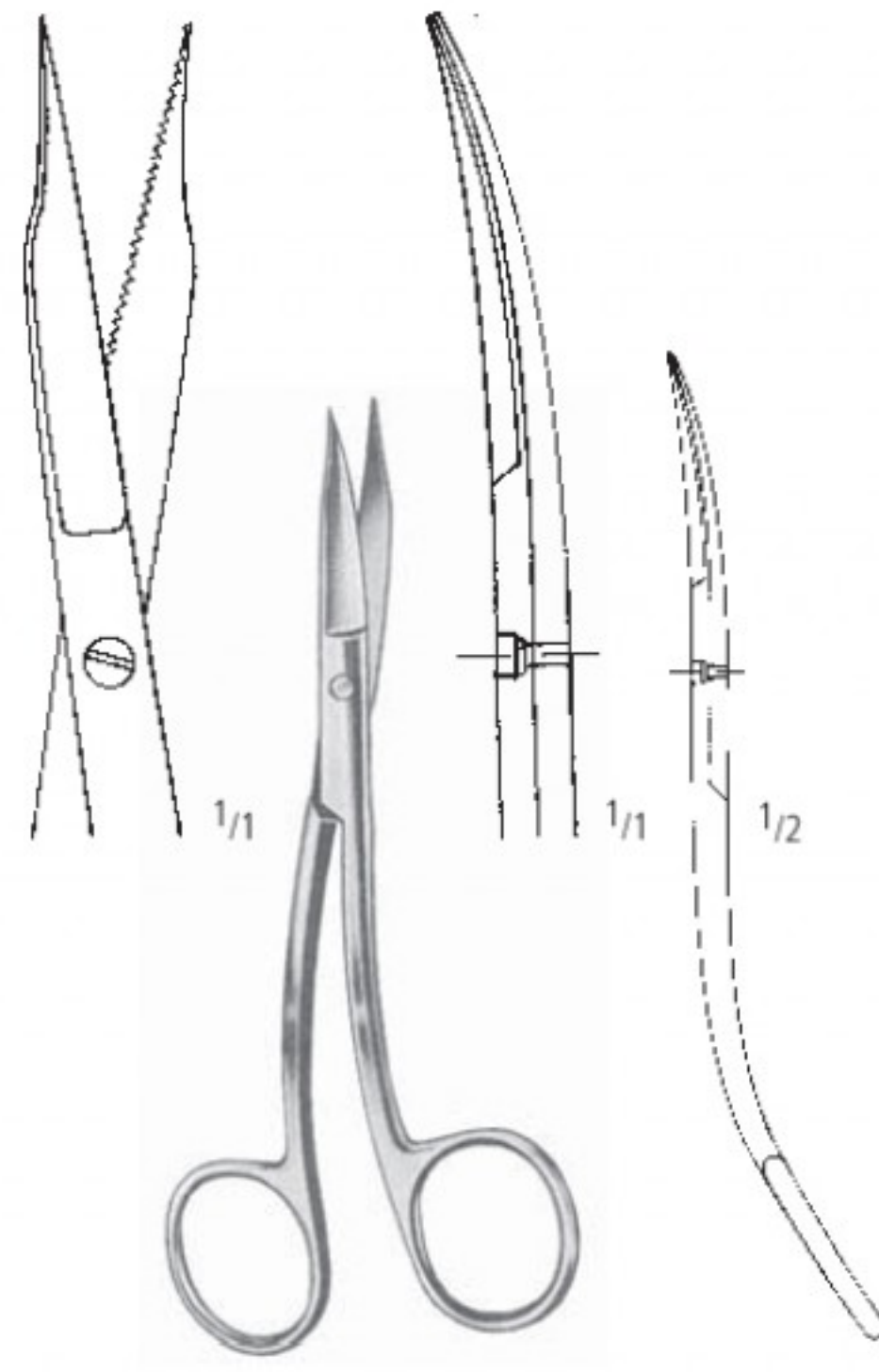

GOLDMAN-FOX (SPEZIAL)

AC 635/13
13,0 cm/5"

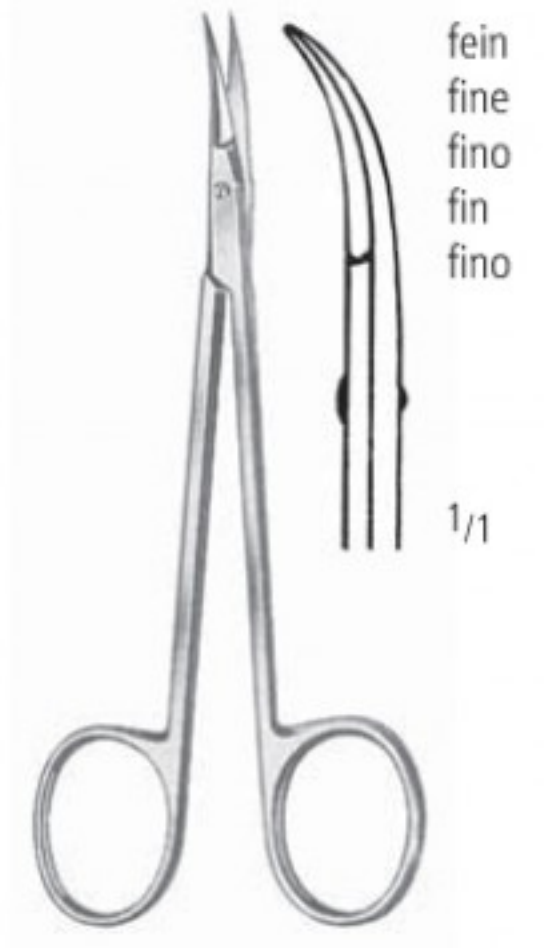

AC 637/11
11,5 cm/4 1/2"

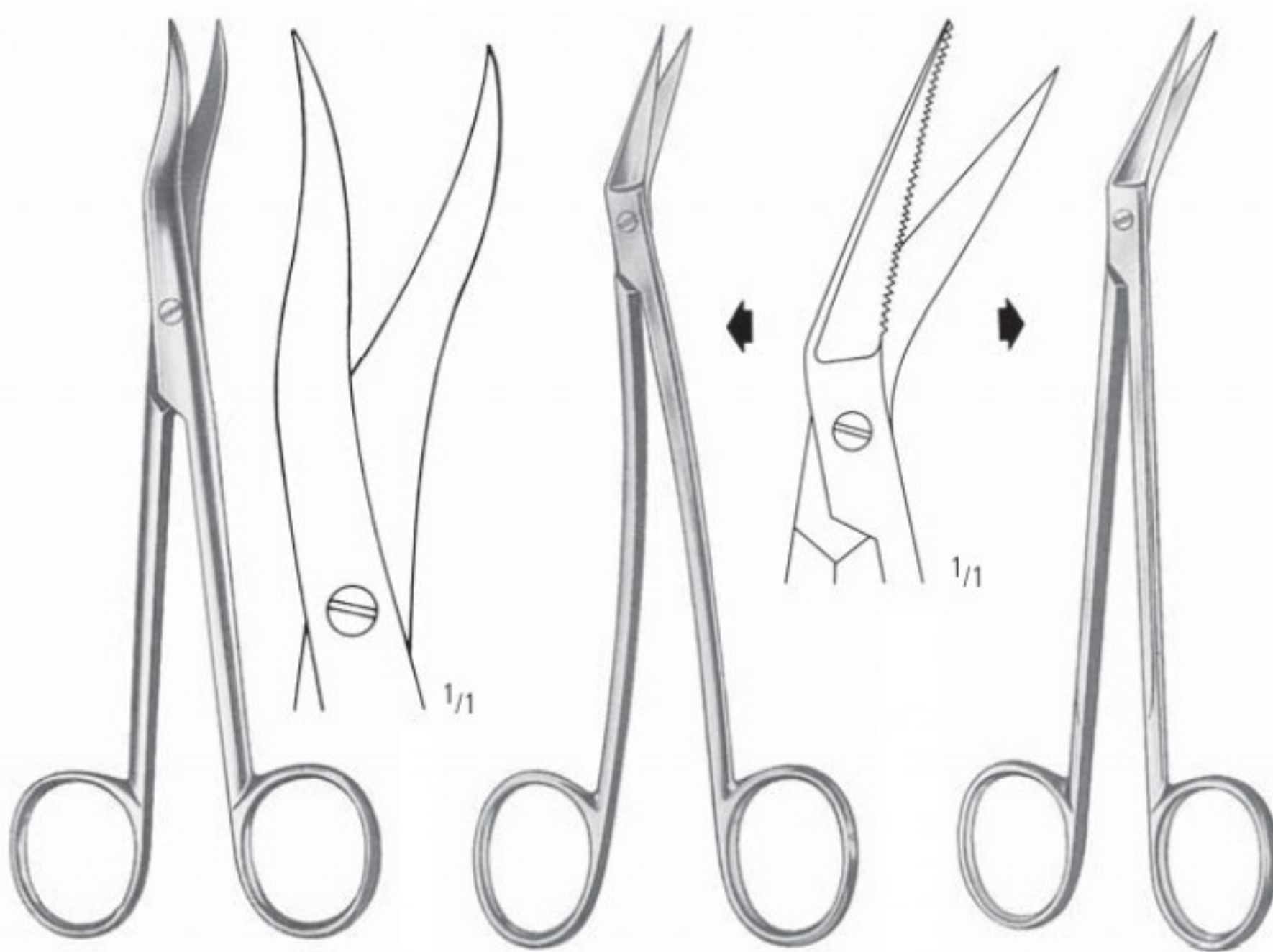

LOCKLIN

AC 639/16
16,0 cm/6 1/4"

AC 640/16
16,5 cm/6 1/2"

LOCKLIN

AC 641/16
16,5 cm/6 1/2"

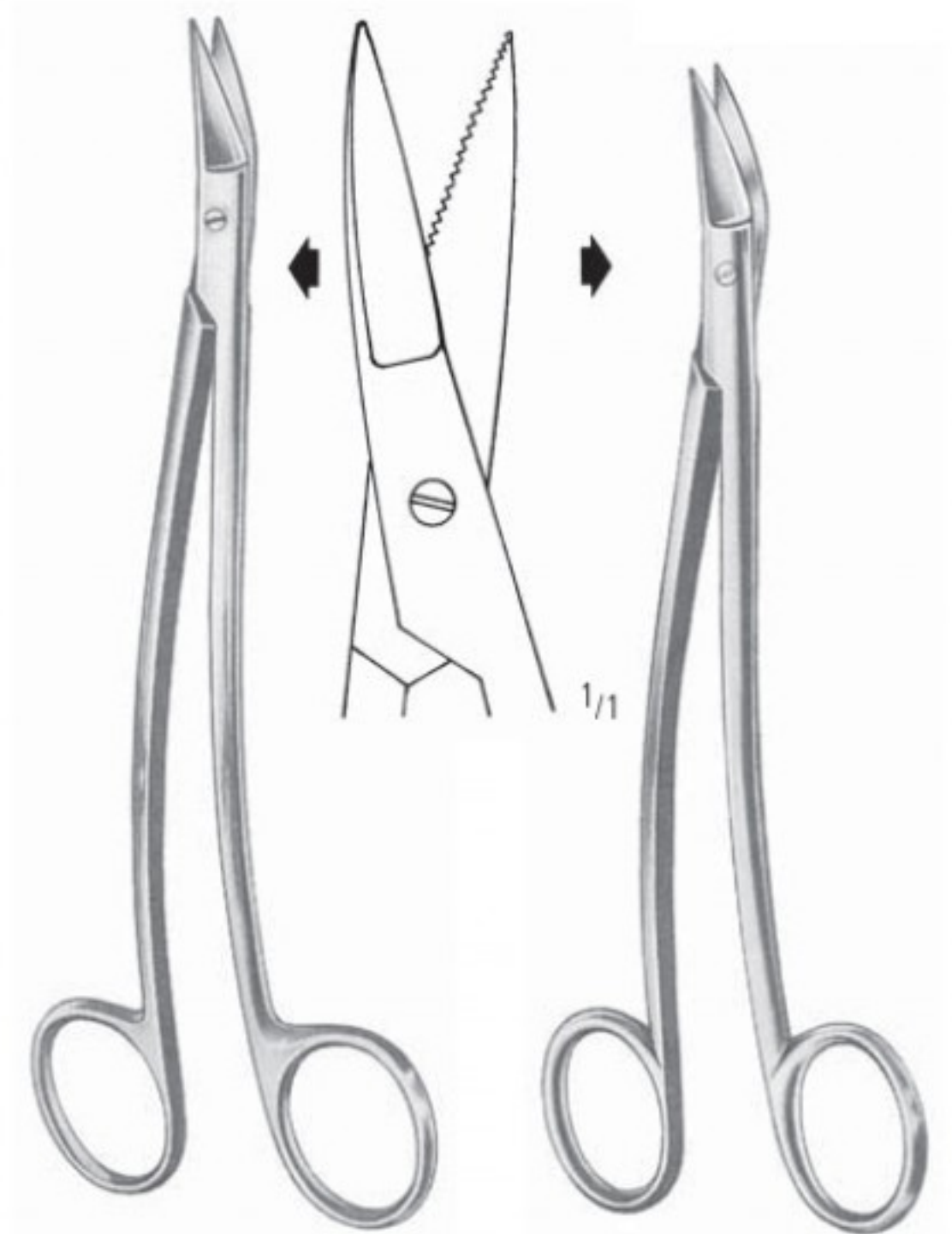

DEAN-DELICATE

AC 642/17
17,0 cm/6 3/4"

DEAN

AC 643/17
17,0 cm/6 3/4"

AA
AB
AC
AD
AE
AF
AK
AL
AO
AR
KA
KL
KU
PA
PB
PF
PI
PK
PL
PM
PP
PS
PT
PU
PV
KYE

AC SCHEREN SCISSORS TIJERAS CISEAUX FORBICI

Zahnfleischscheren
 Gum Scissors
 Tijeras para encias
 Ciseaux à gencives
 Forbici per gengiva



QUINBY

AC 646/12
 12,0 cm/4³/₄"

AC 647/12
 12,0 cm/4³/₄"



STANDARD

AC 648/11
 11,0 cm/4¹/₃"

AC 649/11
 11,0 cm/4¹/₃"

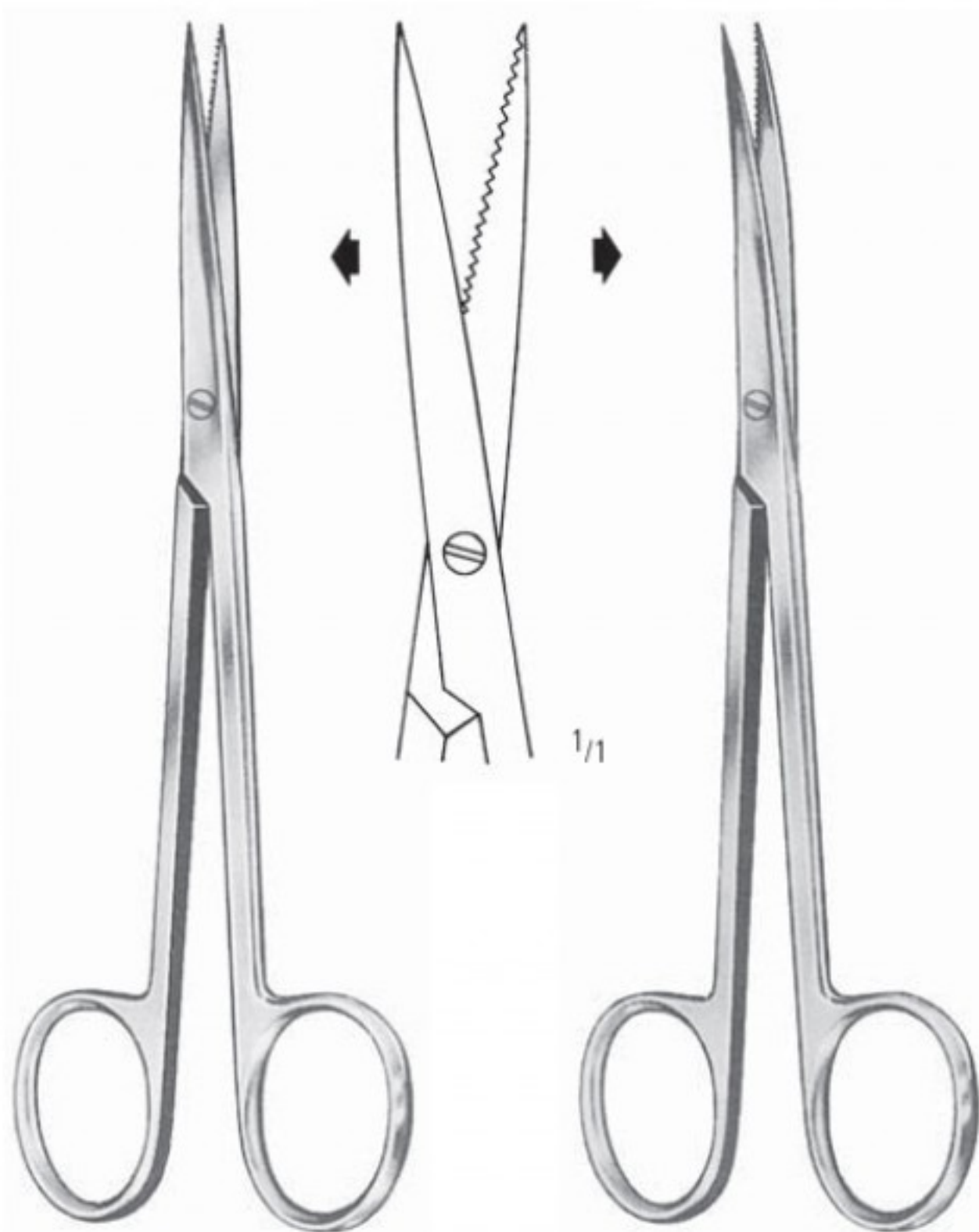

SULLIVAN

AC 650/14
 14,5 cm/5³/₄"

AC 651/14
 14,5 cm/5³/₄"

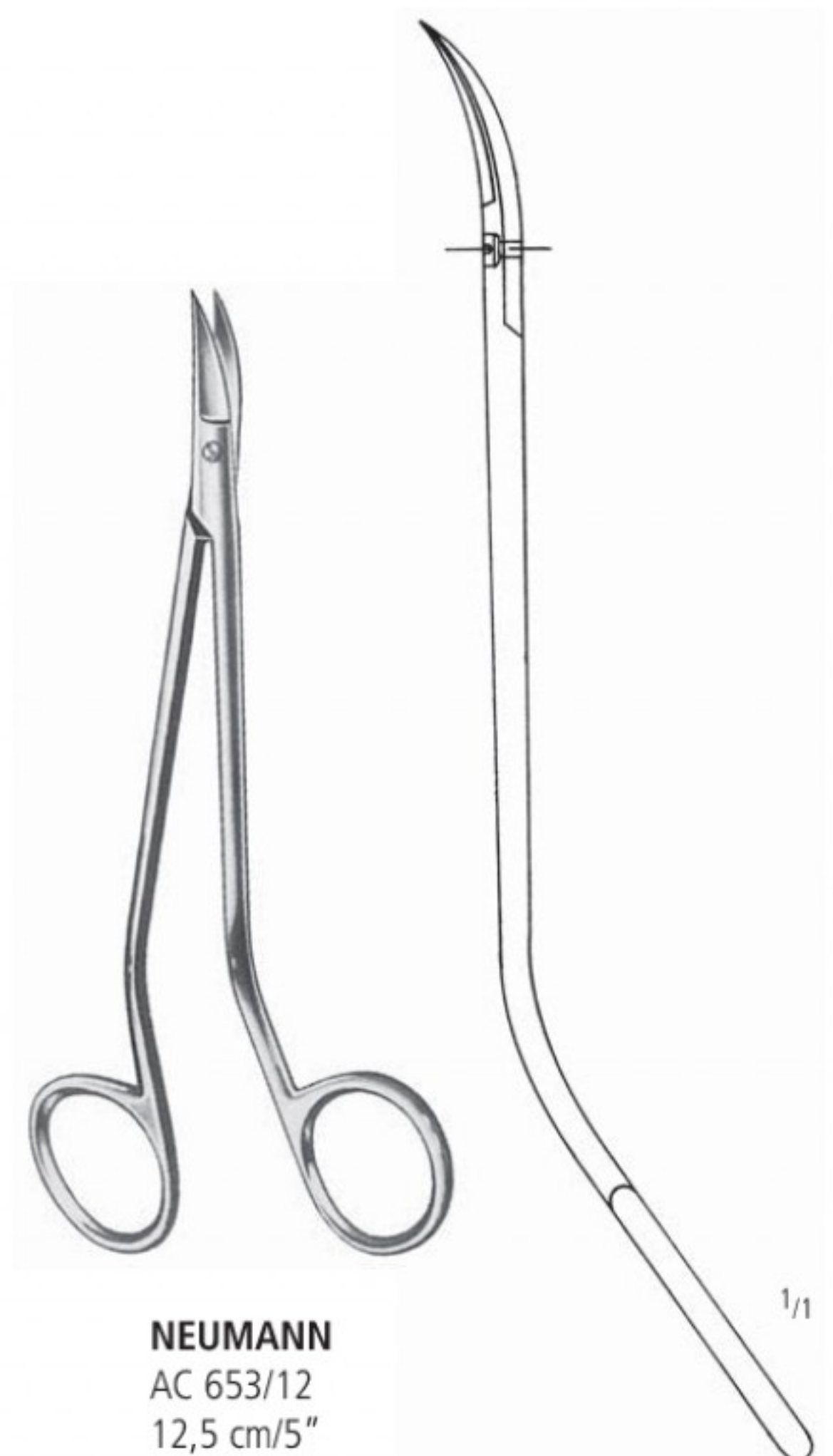

NEUMANN

AC 653/12
 12,5 cm/5"

SCHEREN SCISSORS TIJERAS CISEAUX FORBICI

Mikroscheren
Micro Scissors
Micro Tijeras
Micro-ciseaux
Micro forbici

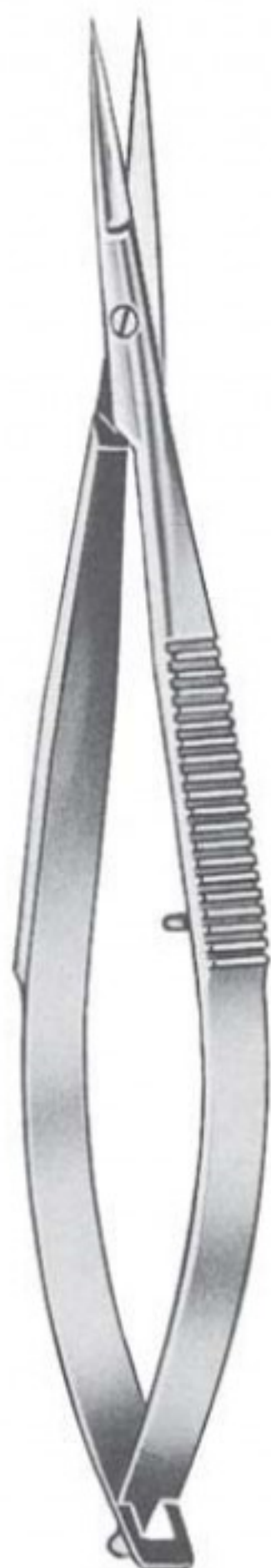

Fig. 1



Fig. 2

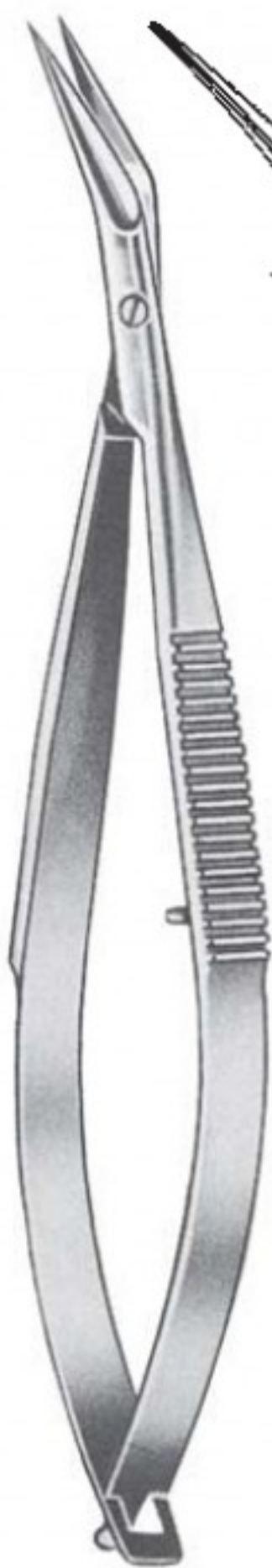

Fig. 3

NOYES

12,0 cm/4³/₄"

- Fig. 1 AC 750/12
- Fig. 2 AC 752/12
- Fig. 3 AC 754/12



- Fig. 1 AC 751/12
- Fig. 2 AC 753/12
- Fig. 3 AC 755/12



WECKER

11,0 cm/4¹/₃"

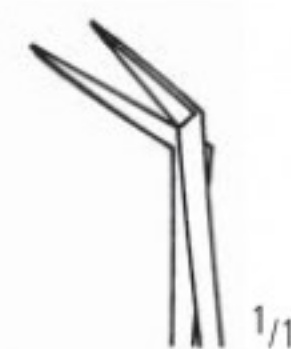

AC 760/11

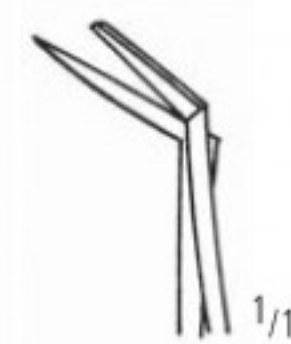

AC 762/11



AC 764/11

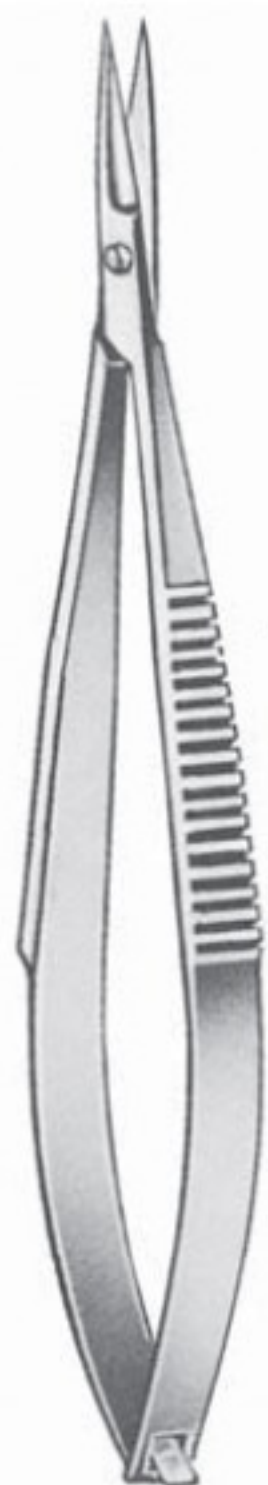

CASTROVIEJO
AC 770/00
9,0 cm/3¹/₂"



AC 770/02

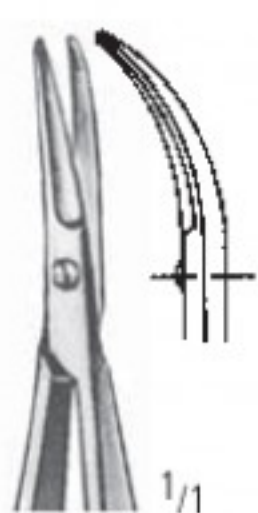

AC 770/03



AC 771/09



AC 772/09

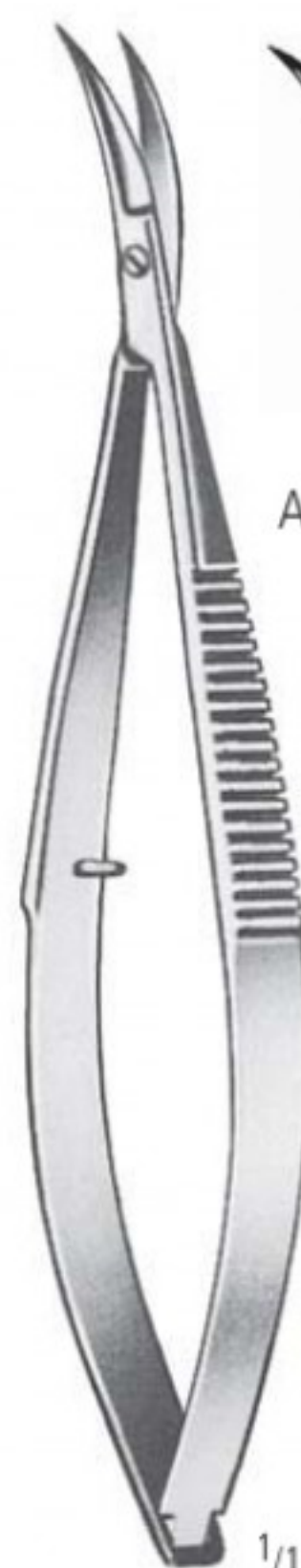

CASTROVIEJO
10,0 cm/4"



AC 773/10
spitz
pointed
agudas
pointues
acute

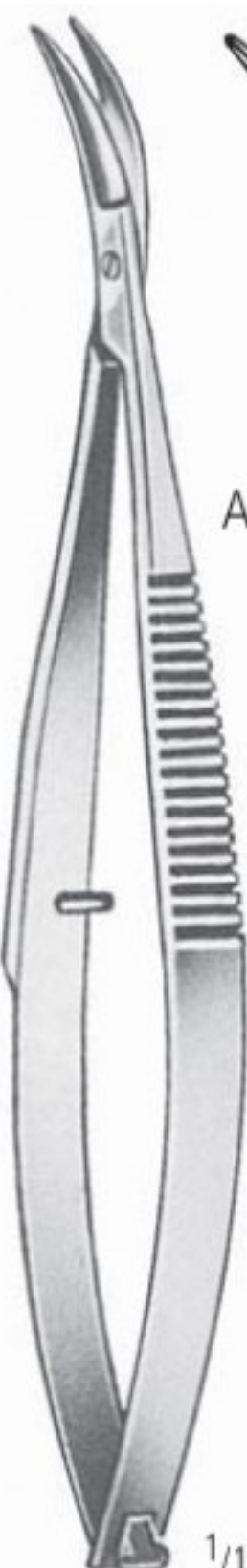

CASTROVIEJO
10,0 cm/4"



AC 775/10
stumpf
blunt
romas
mousses
smusse

AA AB AC AD AE AF AK AL AO AR KA KL KU PA PB PF PI PK PL PM PP PS PT PU PV KYE

Mikroscheren
 Micro Scissors
 Micro Tijeras
 Micro-ciseaux
 Micro forbici



WESTCOTT
 AC 780/11
 11,0 cm/4¹/₃"



WESTCOTT
 AC 782/11
 11,0 cm/4¹/₃"



WESTCOTT
 AC 797/01
 11,5 cm/4¹/₂"

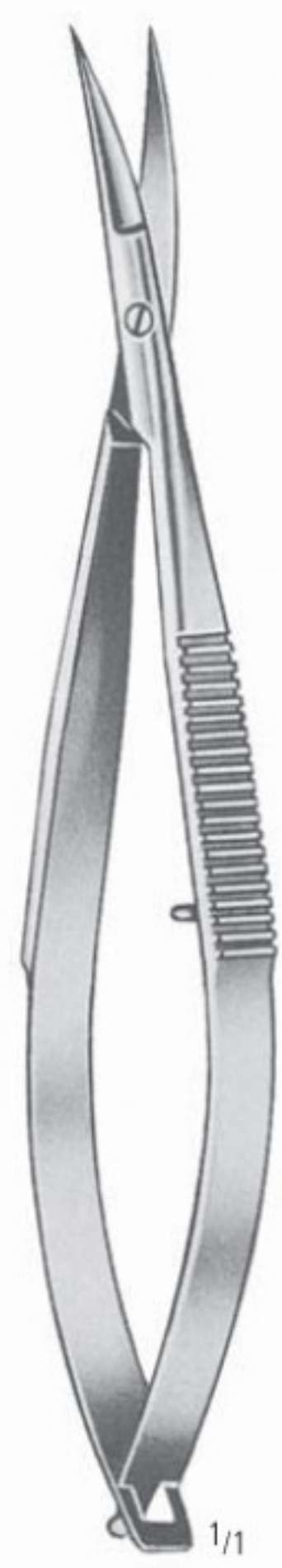

WESTCOTT
 AC 797/02
 11,5 cm/4¹/₂"

nopa[®] TUC[®]

SC Super Cut

SUPER CUT TUC



SUPER CUT TUC

Verfügbare Modelle / Available Patterns

Im Katalog durch * markiert. / Marked in catalog with * .

AC	930/14	SC	METZENBAUM SCS.TUC STR.BL/BL	14,5 CM	SC
AC	931/14	SC	METZENBAUM SCS.TUC CVD.BL/BL	14,5 CM	SC
AC	940/18	SC	METZENBAUM SCS.TUC STR.BL/BL	18,0 CM	SC
AC	941/18	SC	METZENBAUM SCS.TUC CVD.BL/BL	18,0 CM	SC
AC	960/14	SC	METZENBAUM-DELIC. TUC STR.BL/BL	14,5 CM	SC
AC	961/14	SC	METZENBAUM-DELIC. TUC CVD.BL/BL	14,5 CM	SC
AC	970/18	SC	METZENBAUM-DELIC. SCS.TUC STR.BL/BL	18,0 CM	SC
AC	971/18	SC	METZENBAUM-DELIC. SCS.TUC CVD.BL/BL	18,0 CM	SC
AC	974/11	SC	STEVENS TENOTOM.SCS. TUC STR.SH/SH	11,5CM	SC
AC	975/11	SC	STEVENS TENOTOM.SCS. TUC CVD.SH/SH	11,5 CM	SC
AC	976/11	SC	STEVENS TENOTOM.SCS. TUC STR. BL/BL	11,5 CM	SC
AC	977/11	SC	TENOTOMY SCISSORS TUC CVD. BL/BL	11,5 CM	SC
AC	984/11	SC	IRIS SCS.TUC STR.SH/SH	11,5 CM	SC
AC	985/11	SC	IRIS SCS.TUC CVD.SH/SH	11,5 CM	SC

Besonderheit:

Nutzen Sie die Vorteile von Hartmetalleinsätzen.

nopa TUC Super Cut Scheren haben eine rasierklingscharfe Schneide, kombiniert mit einer mikrogezahnten Schneide.

>> Diese Scheren sind durch schwarz/goldene Ringe gekennzeichnet.

Features:

Use the advantages of Tungsten Carbide.

nopa TUC Super Cut scissors have a razor-like edge combined with one micro serrated blade.

>> Black/golden rings for easy identification.

Scheren mit Hartmetalleinlagen
 Scissors with Tungsten Carbide Inserts
 Tijeras con filos de carburo de tungsteno
 Ciseaux avec plaquettes en carbure de tungstène
 Forbici con taglio al carburo di tungsteno



AC 912/16

KELLY
 16,0 cm/6¹/₄"

AC 913/16

SCHEREN SCISSORS TIJERAS CISEAUX FORBICI

Scheren mit Hartmetalleinlagen
 Scissors with Tungsten Carbide Inserts
 Tijeras con filos de carburo de tungsteno
 Ciseaux avec plaquettes en carbure de tungstène
 Forbici con taglio al carburo di tungsteno

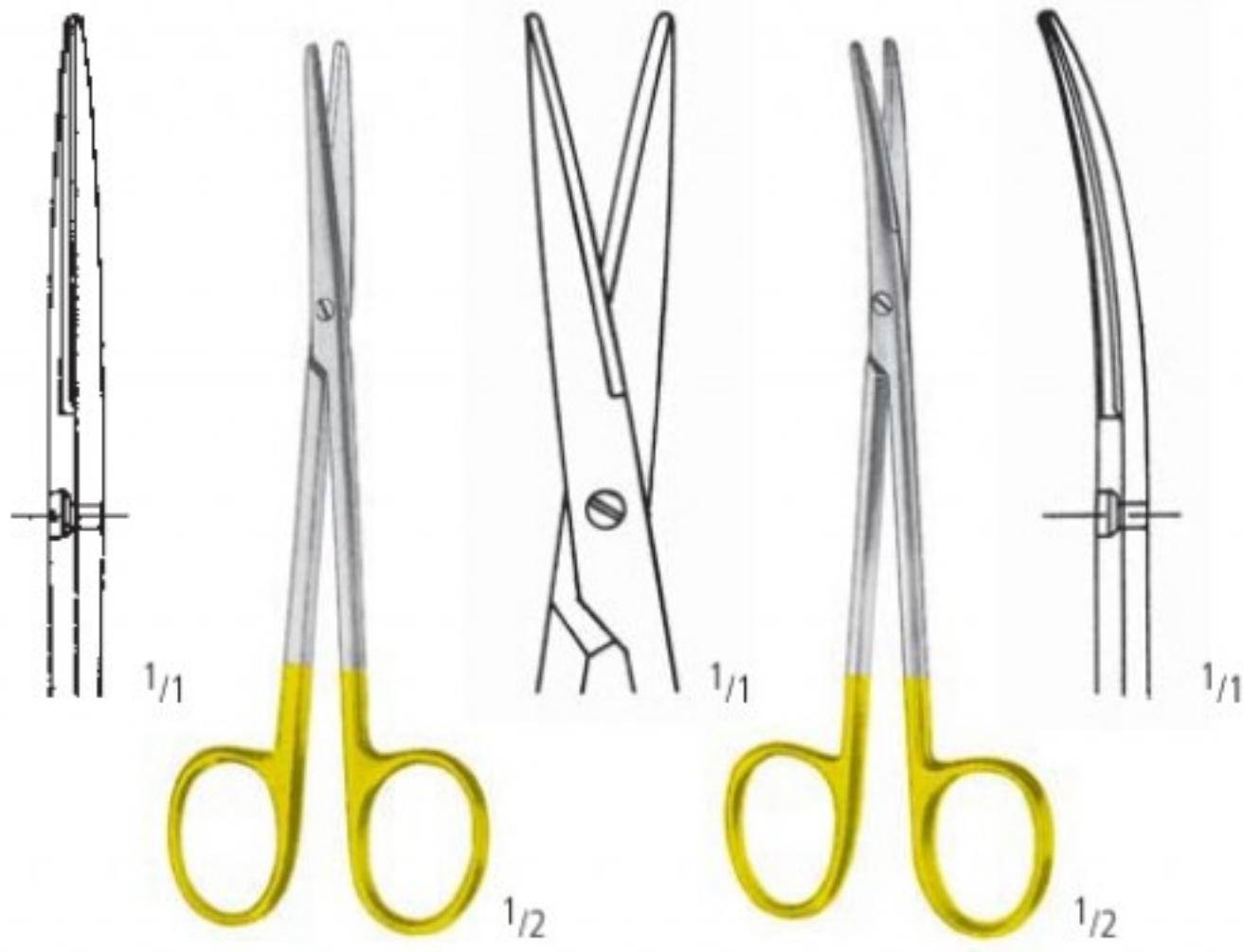

METZENBAUM

AC 922/11
 11,5 cm/4 1/2"

AC 923/11
 11,5 cm/4 1/2"

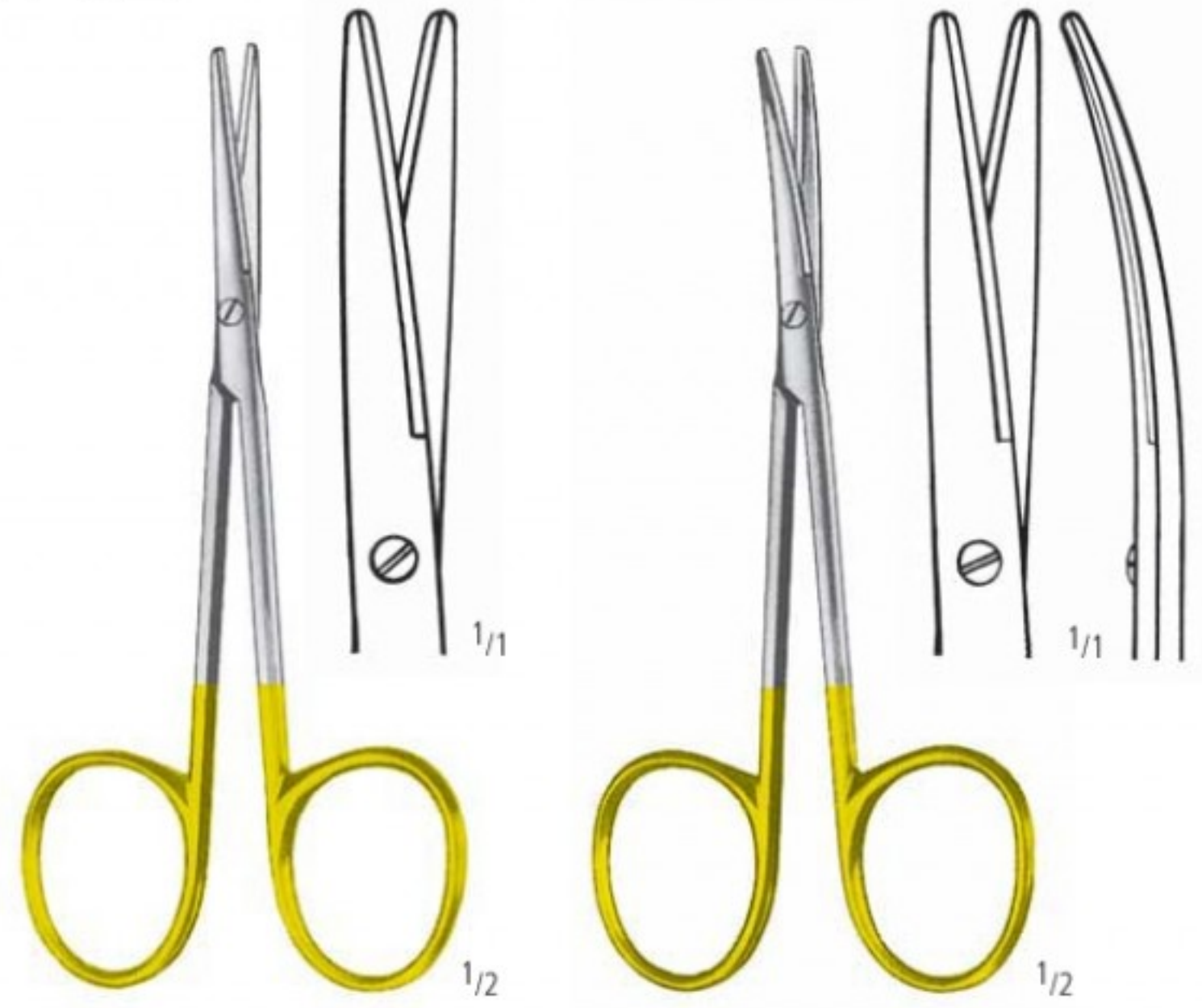

METZENBAUM

AC 930/14*
 14,5 cm/5 3/4"

AC 931/14*
 14,5 cm/5 3/4"

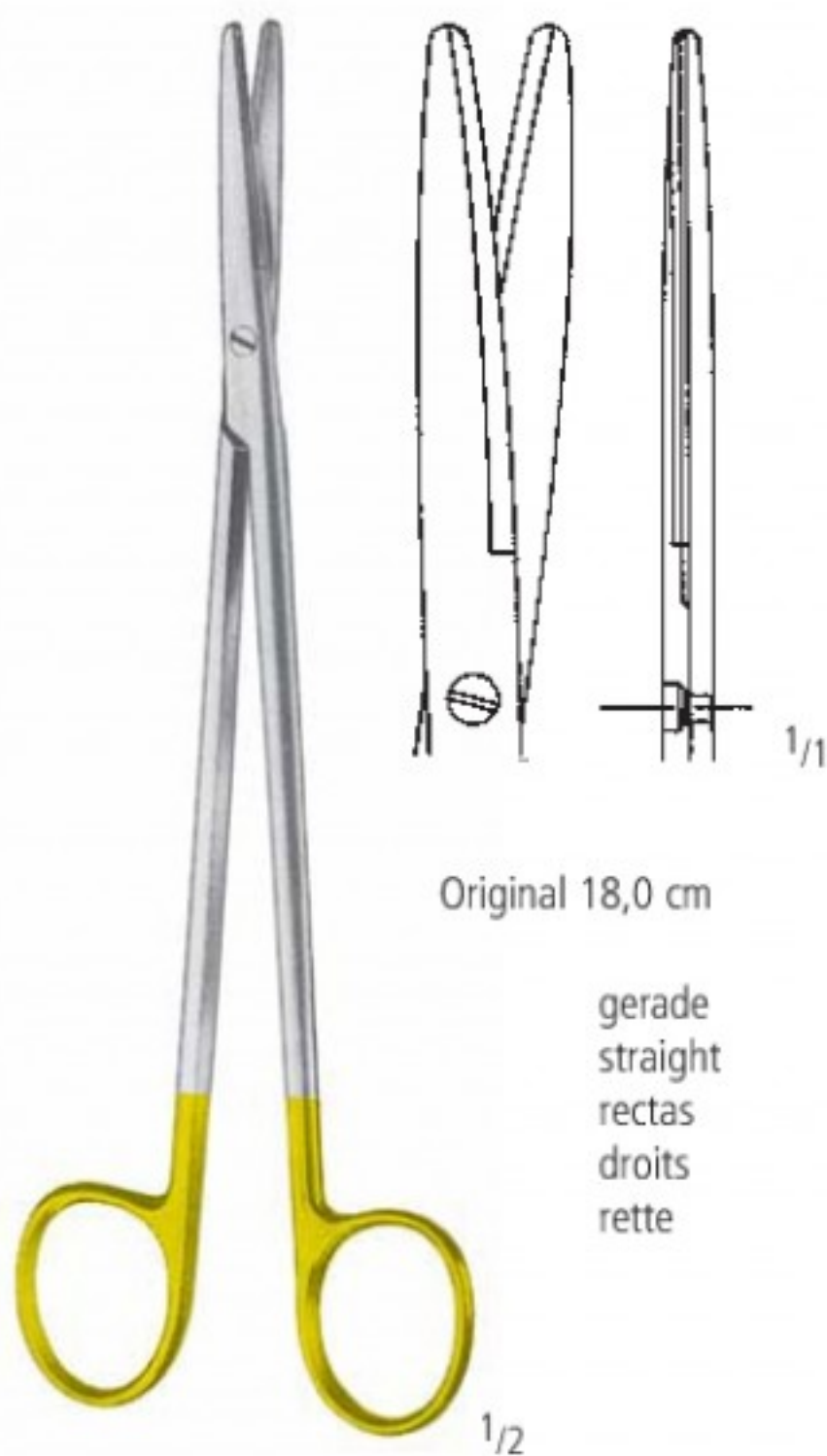

Original 18,0 cm

gerade
 straight
 rectas
 droits
 rette

METZENBAUM

AC 940/18*
 18,0 cm/7"



Original 20,0 cm

gebogen
 curved
 curvas
 courbes
 curve

METZENBAUM

AC 941/18*
 18,0 cm/7"

* Auch erhältlich als SC * Also available as SC

AA
 AB
 AC
 AD
 AE
 AF
 AK
 AL
 AO
 AR
 KA
 KL
 KU
 PA
 PB
 PF
 PI
 PK
 PL
 PM
 PP
 PS
 PT
 PU
 PV
 KYE

Scheren mit Hartmetalleinlagen
 Scissors with Tungsten Carbide Inserts
 Tijeras con filos de carburo de tungsteno
 Ciseaux avec plaquettes en carbure de tungstène
 Forbici con taglio al carburo di tungsteno

METZENBAUM-DELICATE



AC 960/14*
 14,5 cm/5³/₄"

AC 961/14*
 14,5 cm/5³/₄"

METZENBAUM-DELICATE

AC 962/14
 14,5 cm/5³/₄"

AC 963/14
 14,5 cm /5³/₄"



Original 18,0 cm

gerade
 straight
 rectas
 droits
 rette

METZENBAUM-DELICATE

AC 970/18*
 18,0 cm/7"



Original 20,0 cm

gebogen
 curved
 curvas
 courbes
 curve

METZENBAUM-DELICATE

AC 971/18*
 18,0 cm/7"

SCHEREN SCISSORS TIJERAS CISEAUX FORBICI

Scheren mit Hartmetalleinlagen
 Scissors with Tungsten Carbide Inserts
 Tijeras con filos de carburo de tungsteno
 Ciseaux avec plaquettes en carbure de tungstène
 Forbici con taglio al carburo di tungsteno

Original 11,5 cm

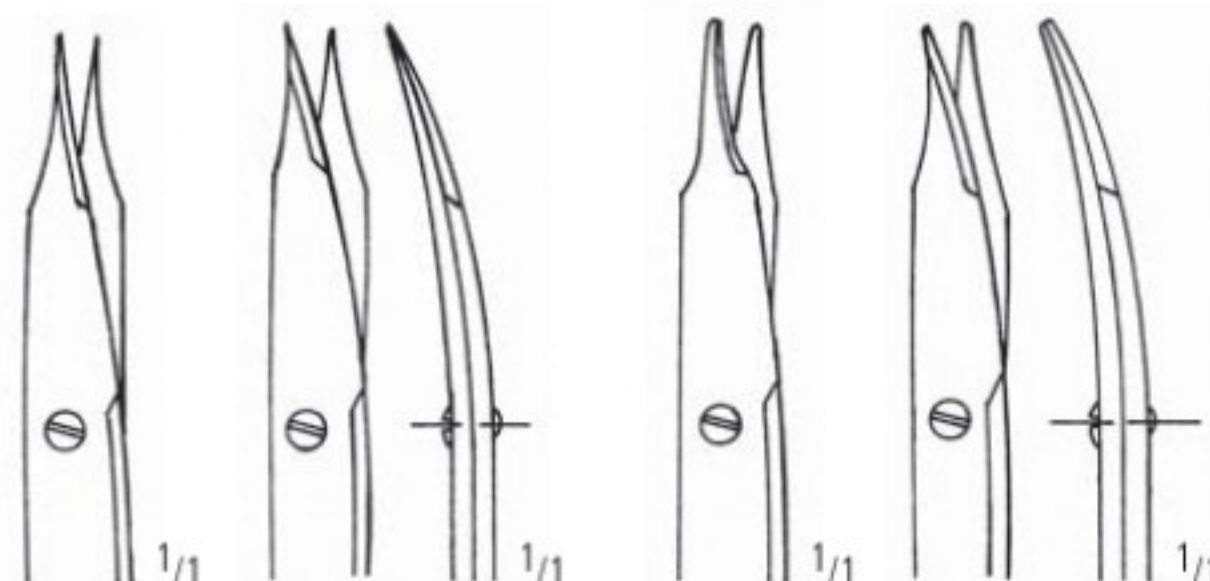

spitz
pointed
agudas
pointues
acuta

stumpf
blunt
romas
mousses
smussa

gerade
straight
rectas
droits
rette

gebogen
curved
curvas
courbes
curve

gerade
straight
rectas
droits
rette

gebogen
curved
curvas
courbes
curve

STEVENS

10,5 cm/4¹/₄"
 11,5 cm/4¹/₂"

AC 974/10
 AC 974/11*

AC 975/10
 AC 975/11*

AC 976/10
 AC 976/11*

AC 977/10
 AC 977/11*

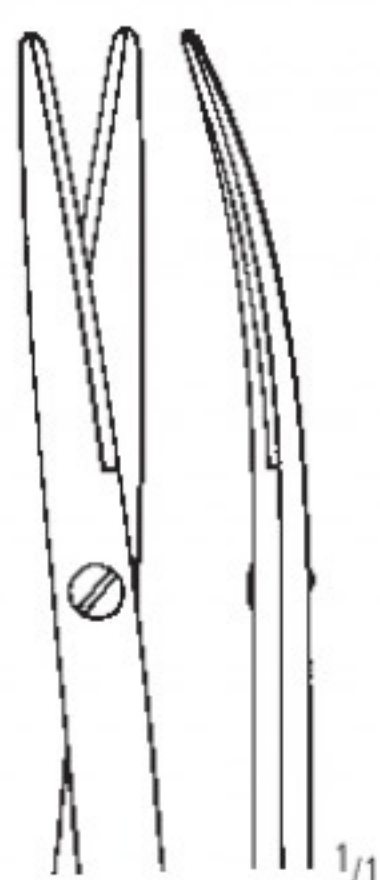

gebogen
curved
curvas
courbes
curve

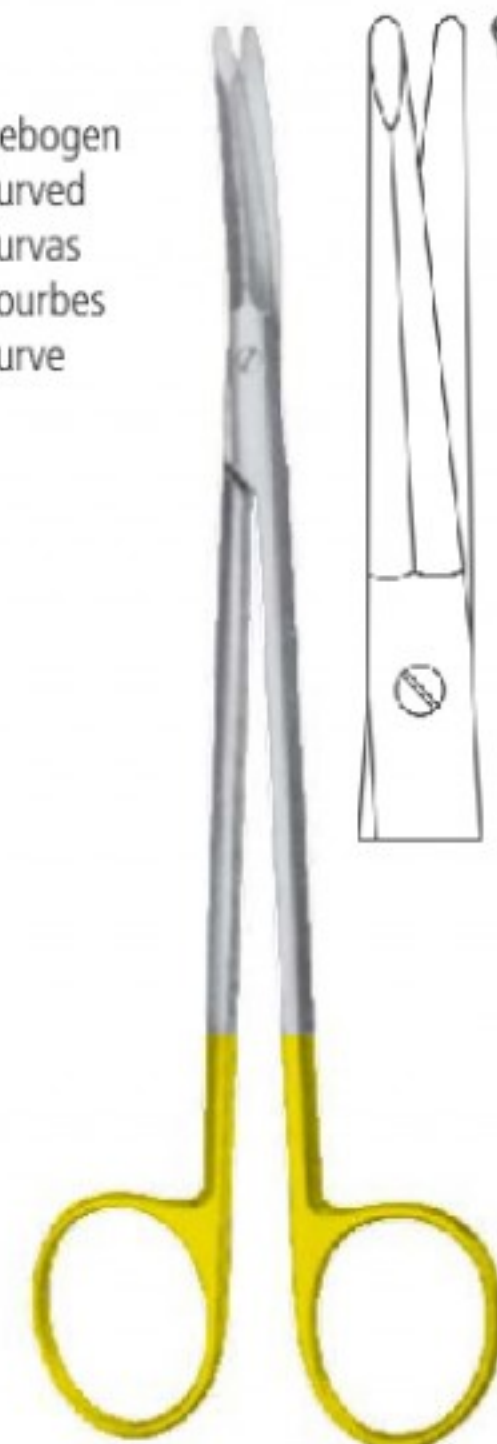

gezahnt
toothed
dentada
dentelés
dentata

TOENNIS-ADSON-DELICATE

AC 977/17
 17,5 cm/7"

GOLDMAN-FOX

AC 980/13
 13,0 cm/5"

AC 981/13
 13,0 cm/5"

KAYE

AC 983/15
 15,0 cm/6"

* Auch erhältlich als SC * Also available as SC

AA
AB
AC
AD
AE
AF
AK
AL
AO
AR
KA
KL
KU
PA
PB
PF
PI
PK
PL
PM
PP
PS
PT
PU
PV
KYE

AC SCHEREN SCISSORS TIJERAS CISEAUX FORBICI

Scheren mit Hartmetalleinlagen
 Scissors with Tungsten Carbide Inserts
 Tijeras con filos de carburo de tungsteno
 Ciseaux avec plaquettes en carbure de tungstène
 Forbici con taglio al carburo di tungsteno



AC 984/11*
 11,5 cm/4 1/2"



AC 985/11*
 11,5 cm/4 1/2"

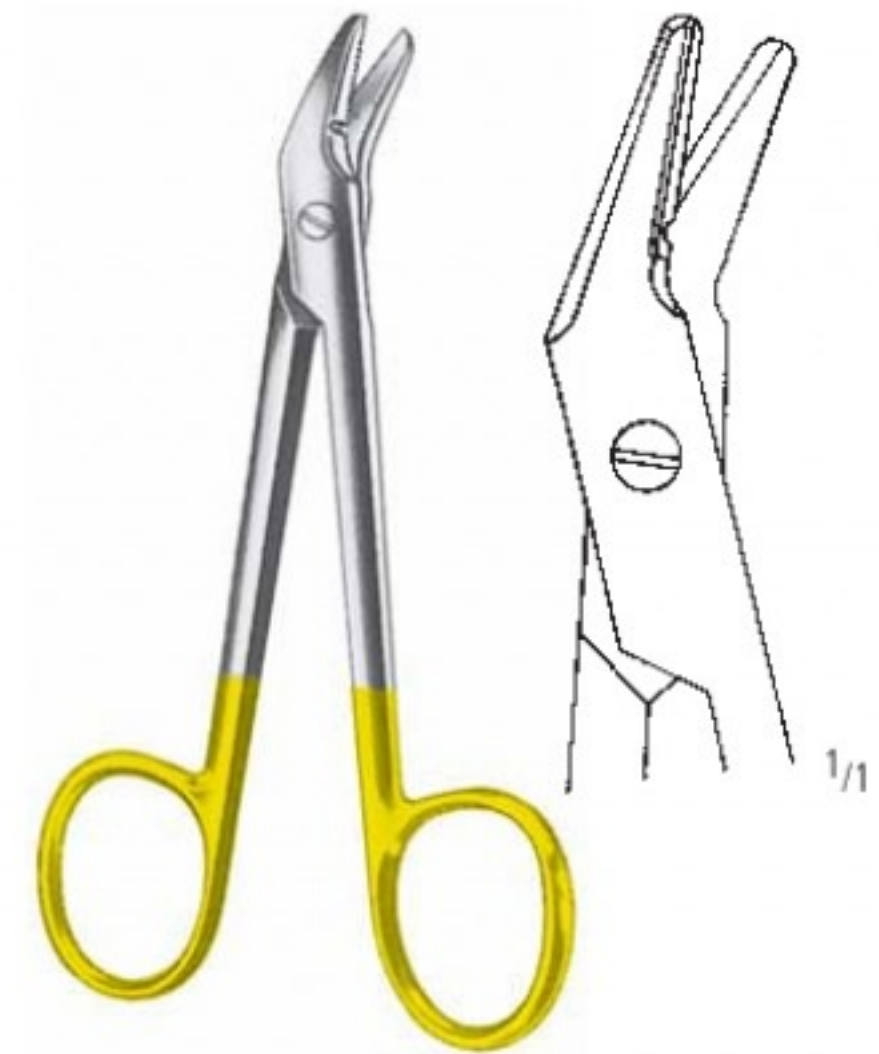

UNIVERSAL
 AC 987/12
 12,0 cm/4 3/4"

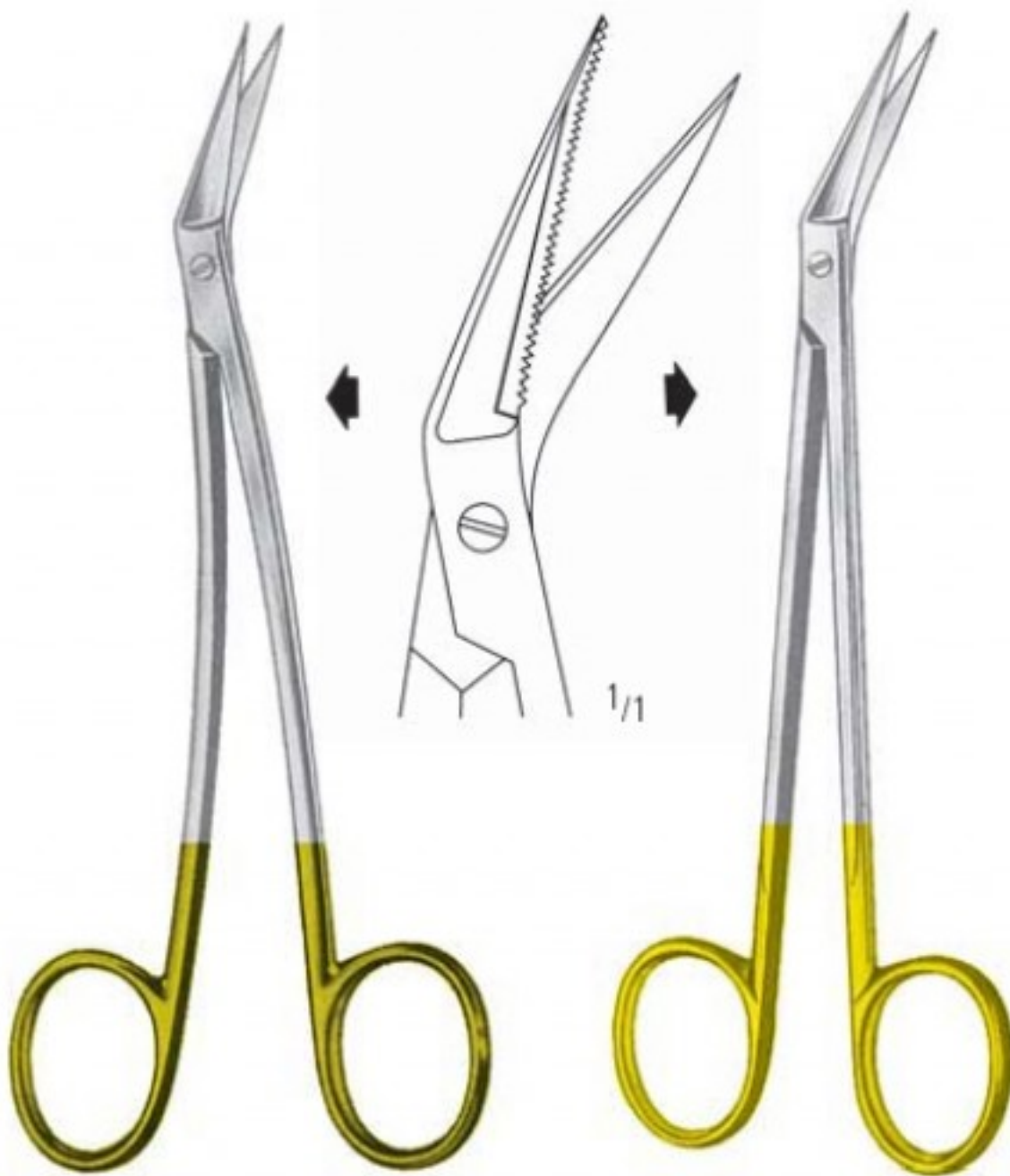

LOCKLIN
 AC 988/16
 16,5 cm/6 1/2"

LOCKLIN
 AC 989/16
 16,5 cm/6 1/2"

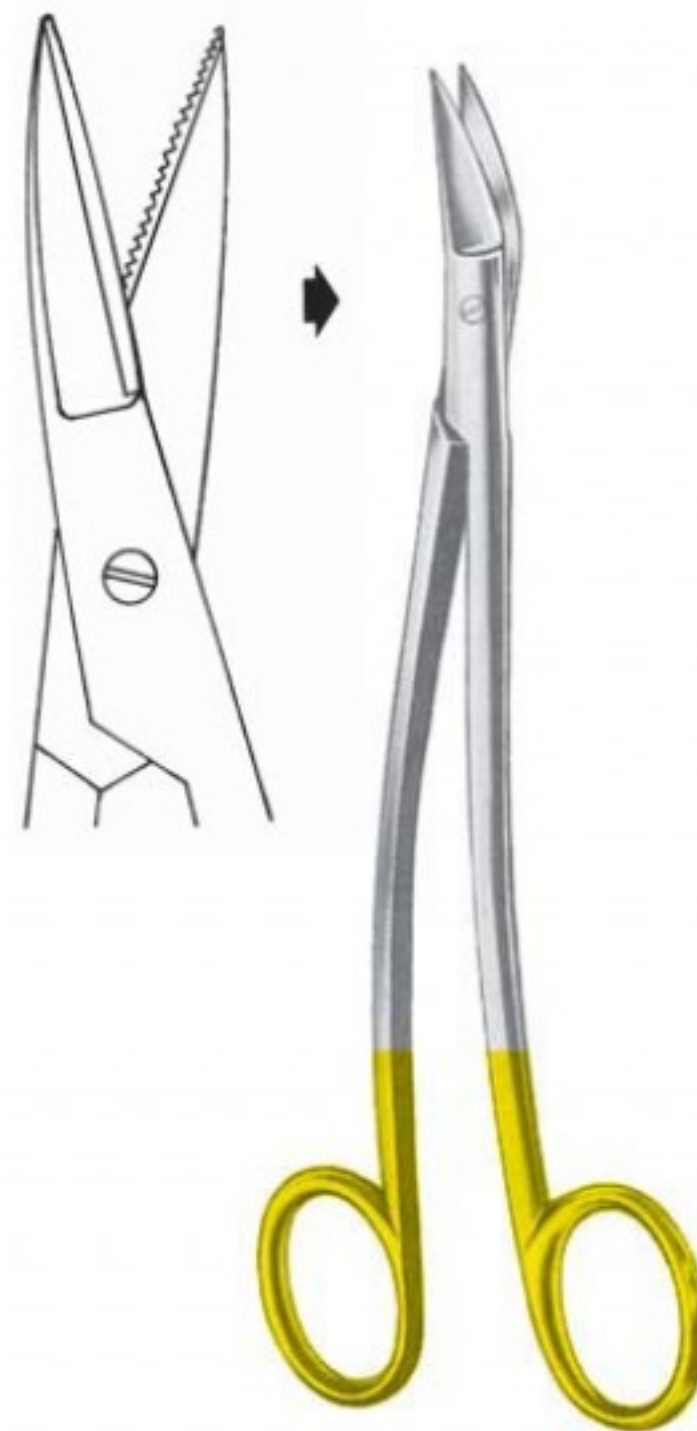

DEAN
 AC 990/17
 17,0 cm/6 3/4"



LISTER
 AC 999/18
 18,0 cm/7"

SKALPELLE
SCALPELS
BISTURIES
BISTOURIS
BISTURI

AD

nopa[®] instruments



SKALPELLE SCALPELS BISTURIES BISTOURIS BISTURI

Skalpеллgriffe
 Scalpel Handles
 Mangos de bisturías
 Manches pour bistouris
 Manici per bisturi

für Skalpеллklingen Größe 3
 for Scalpel Blades size 3
 para hojas de bisturías tamaño 3
 pour lames pour bistouris taille 3
 per lame per bisturi formato 3



AD 009/03
 No. 3



AD 010/03
 No. 3



AD 027/07
 No. 7K



AD 030/16



AD 031/16
 No. 3

AA
 AB
 AC
AD
 AE
 AF
 AG
 AH
 AI
 AJ
 AK
 AL
 AO
 AP
 AQ
 AR
 AS
 AT
 AU
 AV
 AW
 AX
 AY
 AZ
 BA
 BB
 BC
 BD
 BE
 BF
 BG
 BH
 BI
 BJ
 BK
 BL
 BM
 BN
 BO
 BP
 BQ
 BR
 BS
 BT
 BU
 BV
 BW
 BX
 BY
 BZ
 CA
 CB
 CC
 CD
 CE
 CF
 CG
 CH
 CI
 CJ
 CK
 CL
 CM
 CN
 CO
 CP
 CQ
 CR
 CS
 CT
 CU
 CV
 CW
 CX
 CY
 CZ
 DA
 DB
 DC
 DD
 DE
 DF
 DG
 DH
 DI
 DJ
 DK
 DL
 DM
 DN
 DO
 DP
 DQ
 DR
 DS
 DT
 DU
 DV
 DW
 DX
 DY
 DZ
 EA
 EB
 EC
 ED
 EE
 EF
 EG
 EH
 EI
 EJ
 EK
 EL
 EM
 EN
 EO
 EP
 EQ
 ER
 ES
 ET
 EU
 EV
 EW
 EX
 EY
 EZ
 FA
 FB
 FC
 FD
 FE
 FF
 FG
 FH
 FI
 FJ
 FK
 FL
 FM
 FN
 FO
 FP
 FQ
 FR
 FS
 FT
 FU
 FV
 FW
 FX
 FY
 FZ
 GA
 GB
 GC
 GD
 GE
 GF
 GG
 GH
 GI
 GJ
 GK
 GL
 GM
 GN
 GO
 GP
 GQ
 GR
 GS
 GT
 GU
 GV
 GW
 GX
 GY
 GZ
 HA
 HB
 HC
 HD
 HE
 HF
 HG
 HH
 HI
 HJ
 HK
 HL
 HM
 HN
 HO
 HP
 HQ
 HR
 HS
 HT
 HU
 HV
 HW
 HX
 HY
 HZ
 IA
 IB
 IC
 ID
 IE
 IF
 IG
 IH
 II
 IJ
 IK
 IL
 IM
 IN
 IO
 IP
 IQ
 IR
 IS
 IT
 IU
 IV
 IW
 IX
 IY
 IZ
 JA
 JB
 JC
 JD
 JE
 JF
 JG
 JH
 JI
 JJ
 JK
 JL
 JM
 JN
 JO
 JP
 JQ
 JR
 JS
 JT
 JU
 JV
 JW
 JX
 JY
 JZ
 KA
 KB
 KC
 KD
 KE
 KF
 KG
 KH
 KI
 KJ
 KK
 KL
 KM
 KN
 KO
 KP
 KQ
 KR
 KS
 KT
 KU
 KV
 KW
 KX
 KY
 KZ
 LA
 LB
 LC
 LD
 LE
 LF
 LG
 LH
 LI
 LJ
 LK
 LL
 LM
 LN
 LO
 LP
 LQ
 LR
 LS
 LT
 LU
 LV
 LW
 LX
 LY
 LZ
 MA
 MB
 MC
 MD
 ME
 MF
 MG
 MH
 MI
 MJ
 MK
 ML
 MM
 MN
 MO
 MP
 MQ
 MR
 MS
 MT
 MU
 MV
 MW
 MX
 MY
 MZ
 NA
 NB
 NC
 ND
 NE
 NF
 NG
 NH
 NI
 NJ
 NK
 NL
 NM
 NN
 NO
 NP
 NQ
 NR
 NS
 NT
 NU
 NV
 NW
 NX
 NY
 NZ
 OA
 OB
 OC
 OD
 OE
 OF
 OG
 OH
 OI
 OJ
 OK
 OL
 OM
 ON
 OO
 OP
 OQ
 OR
 OS
 OT
 OU
 OV
 OW
 OX
 OY
 OZ
 PA
 PB
 PC
 PD
 PE
 PF
 PG
 PH
 PI
 PJ
 PK
 PL
 PM
 PN
 PO
 PP
 PQ
 PR
 PS
 PT
 PU
 PV
 PW
 PX
 PY
 PZ
 QA
 QB
 QC
 QD
 QE
 QF
 QG
 QH
 QI
 QJ
 QK
 QL
 QM
 QN
 QO
 QP
 QQ
 QR
 QS
 QT
 QU
 QV
 QW
 QX
 QY
 QZ
 RA
 RB
 RC
 RD
 RE
 RF
 RG
 RH
 RI
 RJ
 RK
 RL
 RM
 RN
 RO
 RP
 RQ
 RR
 RS
 RT
 RU
 RV
 RW
 RX
 RY
 RZ
 SA
 SB
 SC
 SD
 SE
 SF
 SG
 SH
 SI
 SJ
 SK
 SL
 SM
 SN
 SO
 SP
 SQ
 SR
 SS
 ST
 SU
 SV
 SW
 SX
 SY
 SZ
 TA
 TB
 TC
 TD
 TE
 TF
 TG
 TH
 TI
 TJ
 TK
 TL
 TM
 TN
 TO
 TP
 TQ
 TR
 TS
 TT
 TU
 TV
 TW
 TX
 TY
 TZ
 UA
 UB
 UC
 UD
 UE
 UF
 UG
 UH
 UI
 UJ
 UK
 UL
 UM
 UN
 UO
 UP
 UQ
 UR
 US
 UT
 UY
 UZ
 VA
 VB
 VC
 VD
 VE
 VF
 VG
 VH
 VI
 VJ
 VK
 VL
 VM
 VN
 VO
 VP
 VQ
 VR
 VS
 VT
 VU
 VV
 VW
 VX
 VY
 VZ
 WA
 WB
 WC
 WD
 WE
 WF
 WG
 WH
 WI
 WJ
 WK
 WL
 WM
 WN
 WO
 WP
 WQ
 WR
 WS
 WT
 WU
 WV
 WW
 WX
 WY
 WZ
 XA
 XB
 XC
 XD
 XE
 XF
 XG
 XH
 XI
 XJ
 XK
 XL
 XM
 XN
 XO
 XP
 XQ
 XR
 XS
 XT
 XU
 XV
 XW
 XX
 XY
 XZ
 YA
 YB
 YC
 YD
 YE
 YF
 YG
 YH
 YI
 YJ
 YK
 YL
 YM
 YN
 YO
 YP
 YQ
 YR
 YS
 YT
 YU
 YV
 YW
 YX
 YZ
 ZA
 ZB
 ZC
 ZD
 ZE
 ZF
 ZG
 ZH
 ZI
 ZJ
 ZK
 ZL
 ZM
 ZN
 ZO
 ZP
 ZQ
 ZR
 ZS
 ZT
 ZU
 ZV
 ZW
 ZX
 ZY
 ZZ

Skalpellgriffe, Skalpellklingen
 Scalpel Handles, Scalpel Blades
 Mangos de bisturías, Hojas de busturías
 Manches pour bistouris, Lames de bistouris
 Manici per bisturi, Lame per bisturi

MINI

Verpackungseinheit / packing unit = 10 St./pc.

steril
 sterile
 estériles
 stériles
 sterili



Fig. 61
AD 065/61

Fig. 62
AD 065/62

Fig. 62S
AD 065/63

Fig. 64
AD 065/64

Fig. 65
AD 065/65

Fig. 67
AD 065/67

Fig. 69
AD 065/69

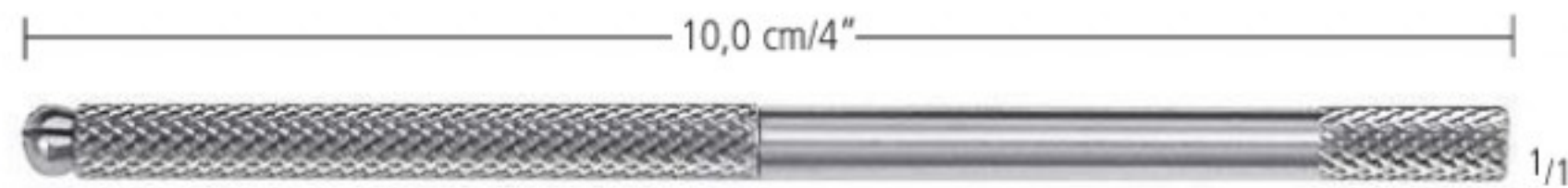

AD 065/10

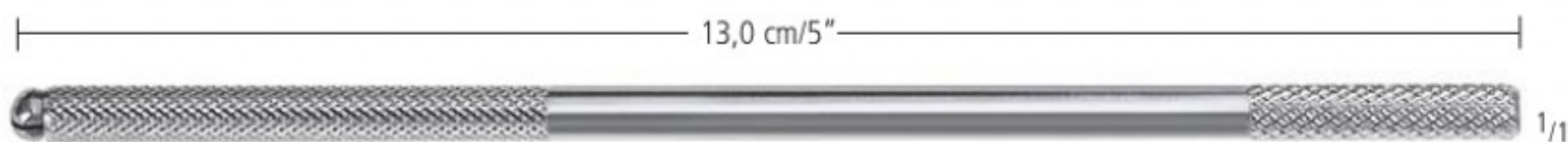

AD 065/13

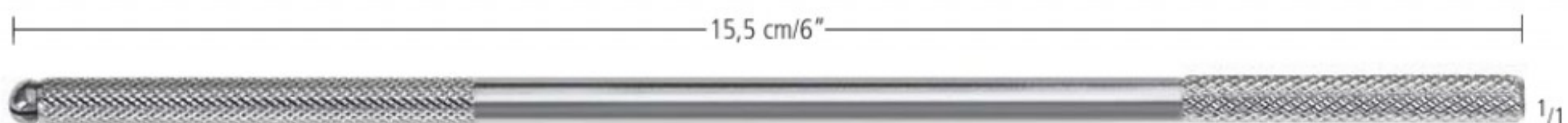

AD 065/15

SKALPELLE SCALPELS BISTURIES BISTOURIS BISTURI

Skalpellinge
Scalpel Blades
Hojas de bisturías
Lames pour bistouris
Lame per bisturi

passend für die Griffe
for handles
para los mangos
pour les manches
per i manici

AD 009/03
AD 010/03
AD 027/07
AD 030/16
AD 031/16



Fig.10
AD 075/10



Fig.11
AD 075/11



Fig.12d
AD 076/12



Fig.15
AD 075/15



Fig.15c
AD 076/15



steril
sterile
estériles
stériles
sterili

AA
AB
AC
AD
AE
AF
AK
AL
AO
AR
KA
KL
KU
PA
PB
PF
PI
PK
PL
PM
PP
PS
PT
PU
PV
KYE

AD SKALPELLE SCALPELS BISTURIES BISTOURIS BISTURI

Zahnfleischmesser
 Gum knives
 Bisturías para encías
 Couteaux à gencives
 Coltelli per gengive



AD 435/01
 No. 1



AD 435/02
 No. 2



AD 435/03
 No. 3

NAHT
SUTURE
SUTURA
SUTURE
SUTURA

AE

nopa[®] instruments



AE NAHT SUTURE SUTURA SUTURE SUTURA

Nadelhalter
Needle Holders
Porta-agujas
Porte-aiguilles
Portaghi



BOYNTON
AE 036/12
12,0 cm/4³/₄"

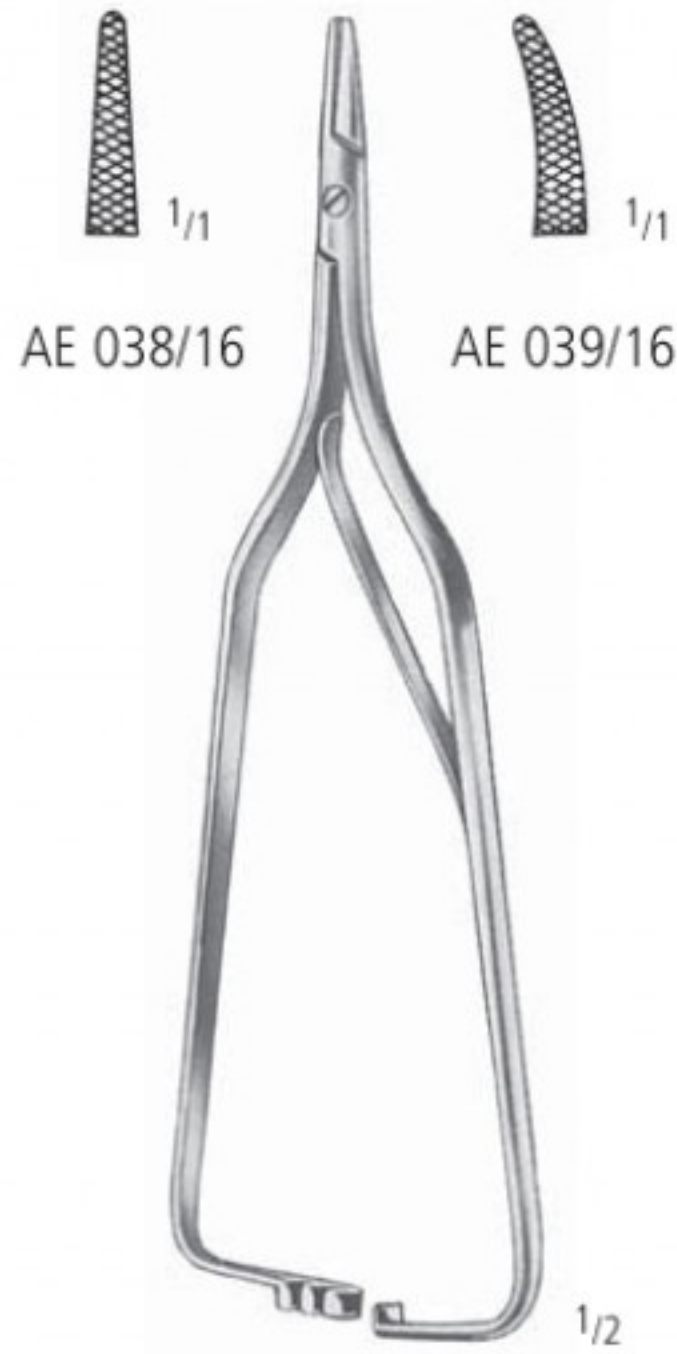

ARRUGA
16,0 cm/6¹/₄"

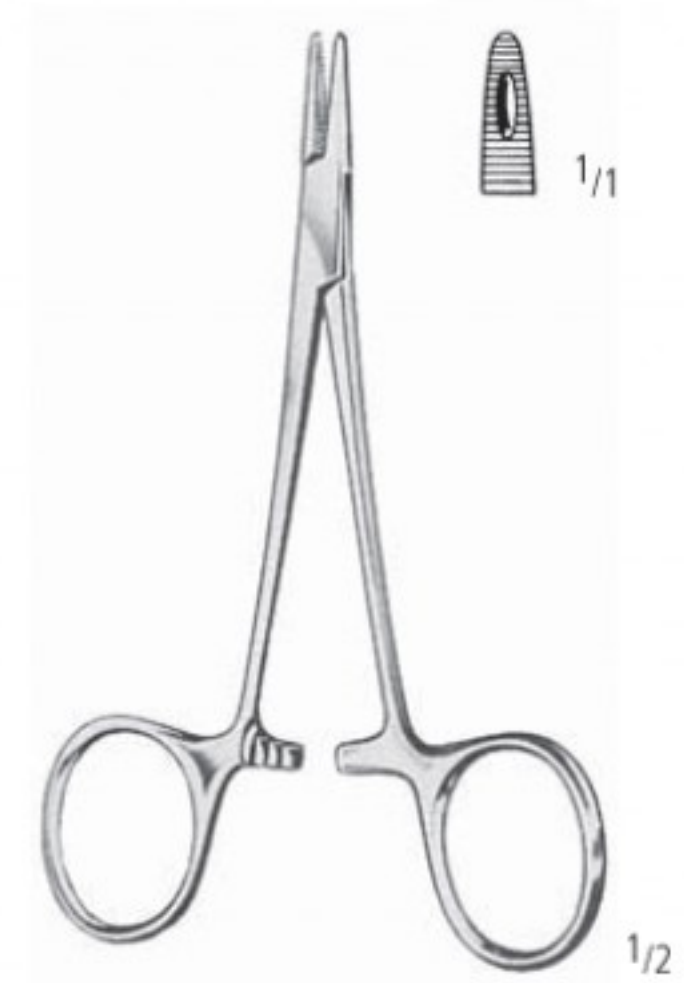

DERF
AE 050/12
12,0 cm/4³/₄"

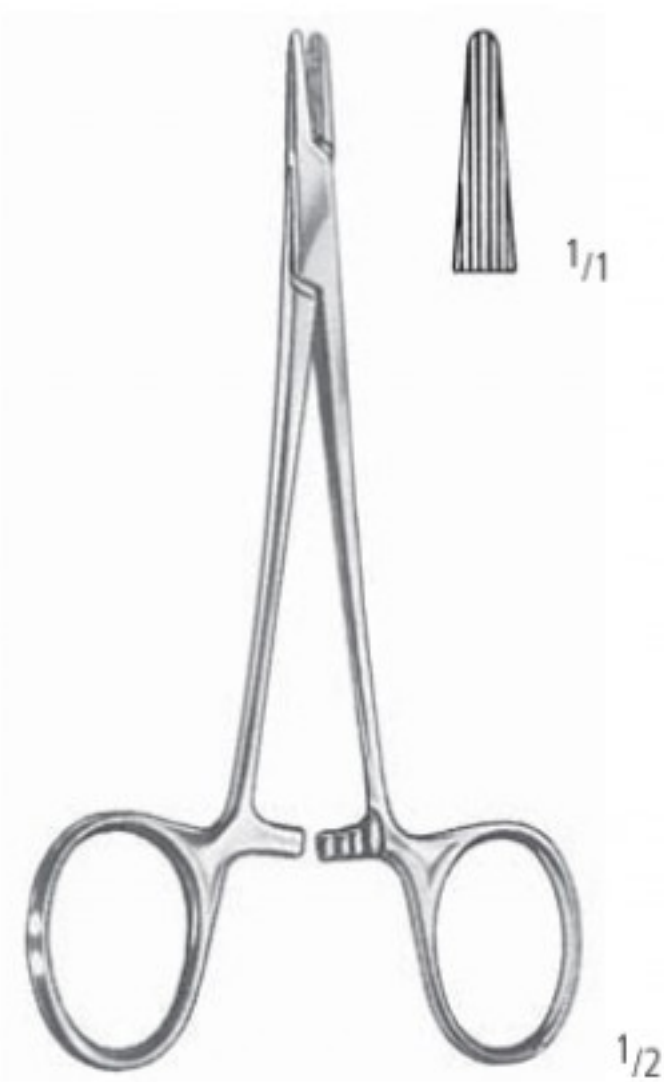

DERF-CONVERSE
AE 052/12
12,5 cm/5"



COLLIER
AE 056/12
12,5 cm/5"

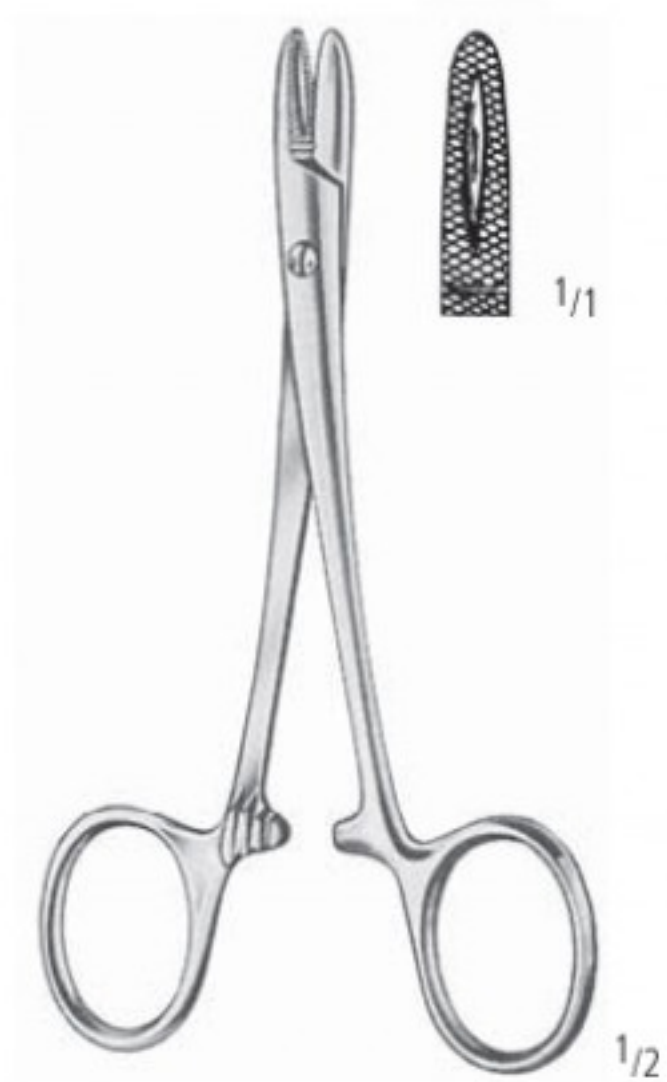

DOYEN
AE 058/12
12,5 cm/5"

NAHT SUTURE SUTURA SUTURE SUTURA

Nadelhalter
Needle Holders
Porta-agujas
Porte-aiguilles
Portaghi

AA
AB
AC
AD
AE
AF
AK
AL
AO
AR
KA
KL
KU
PA
PB
PF
PI
PK
PL
PM
PP
PS
PT
PU
PV
KYE

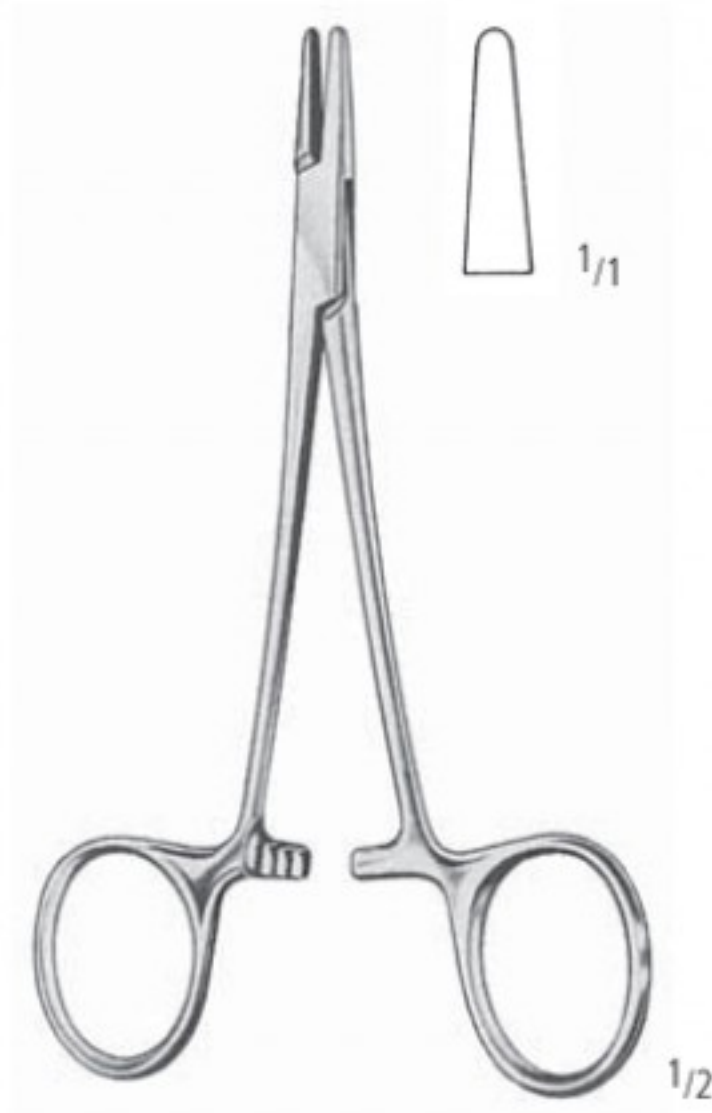

WEBSTER
AE 060/13
13,0 cm/5"

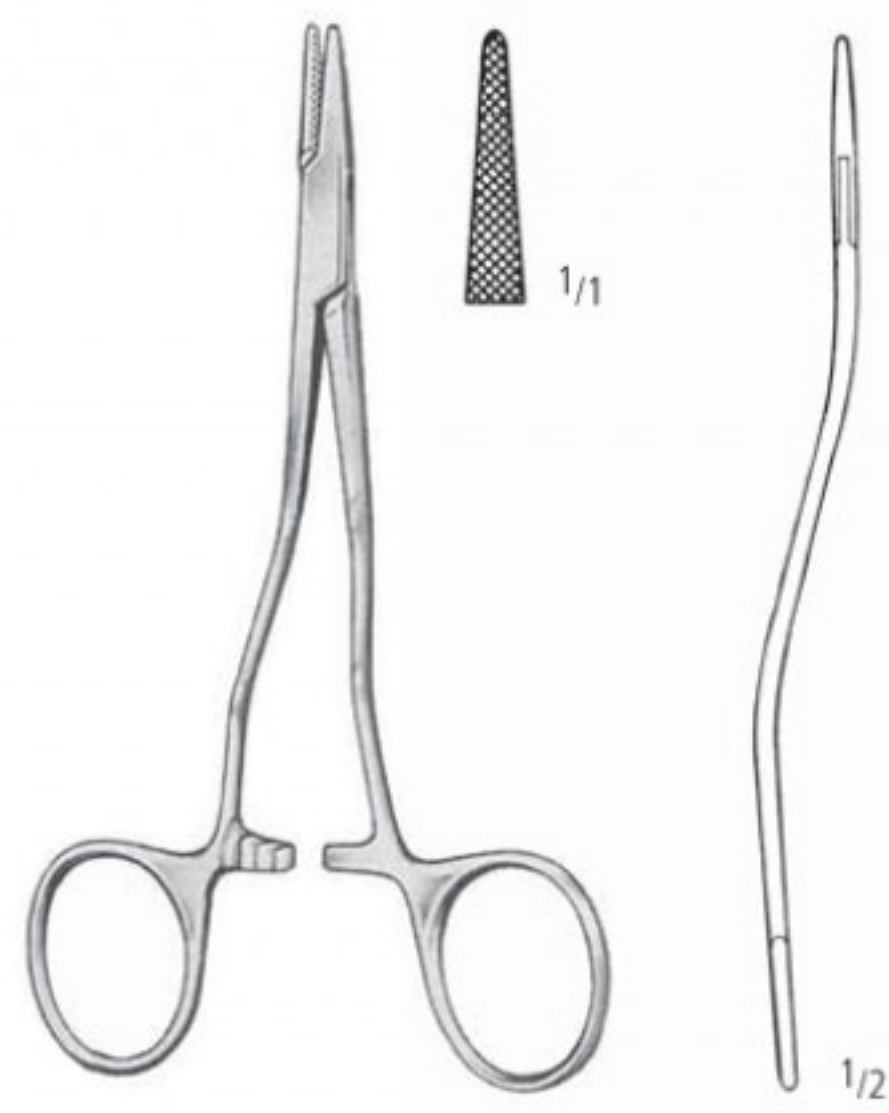

KILNER
AE 063/13
13,0 cm/5"

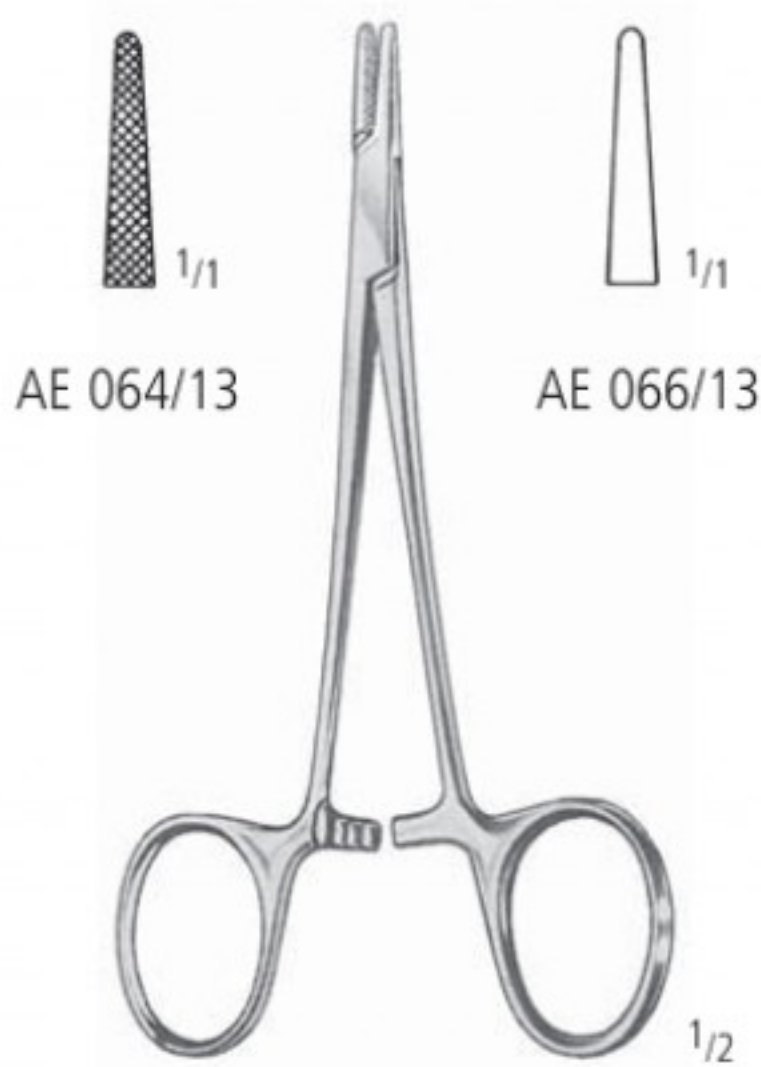

HALSEY
13,0 cm/5"

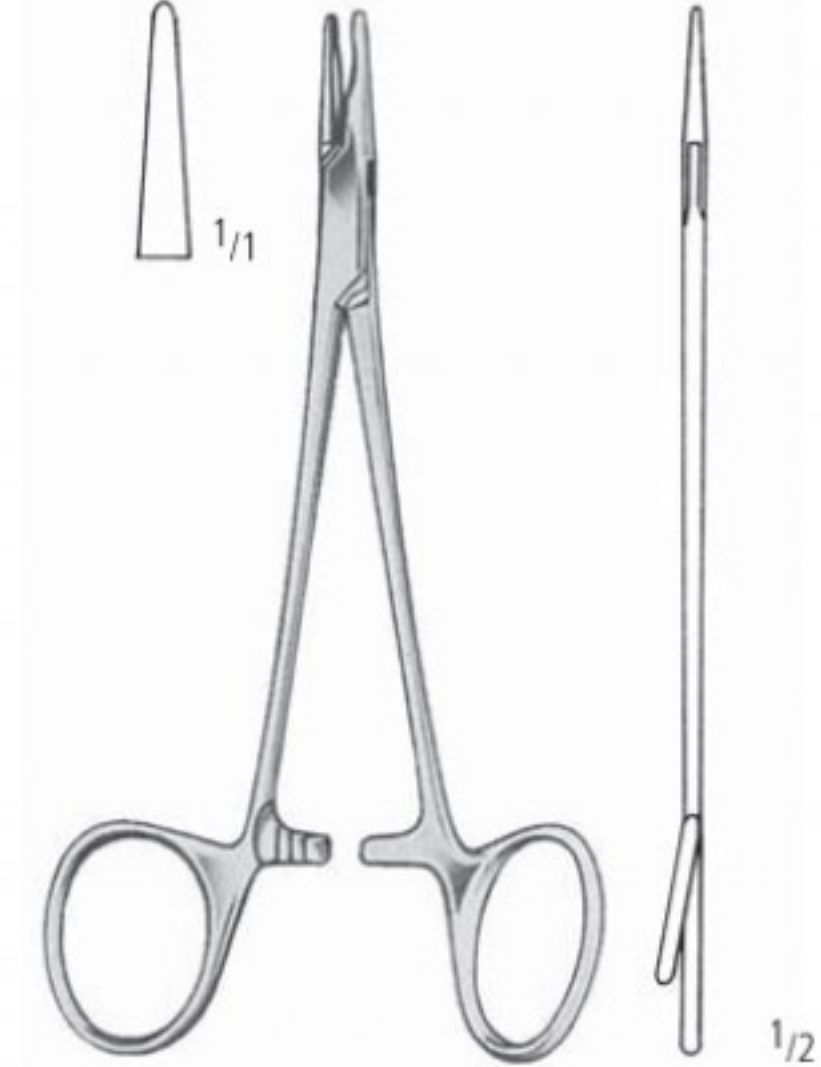

NEIVERT
AE 068/13
13,0 cm/5"

AE NAHT SUTURE SUTURA SUTURE SUTURA

Nadelhalter
Needle Holders
Porta-agujas
Porte-aiguilles
Portaghi



CRILE-WOOD
15,0 cm/6" AE 070/15
18,0 cm/7" AE 070/18



BABY-CRILE-WOOD
AE 072/15
15,0 cm/6"



CARROLL
AE 074/15
15,0 cm/6"



MAYO-HEGAR



AE 100/14
14,0 cm/5 1/2"



AE 100/16
16,0 cm/6 1/4"



AE 100/18
18,0 cm/7"



AE 100/20
20,0 cm/8"

MAYO-HEGAR-DELICATE



AE 110/16
16,0 cm/6 1/4"



AE 110/18
18,0 cm/7"





AE 110/20
20,0 cm/8"

NAHT SUTURE SUTURA SUTURE SUTURA

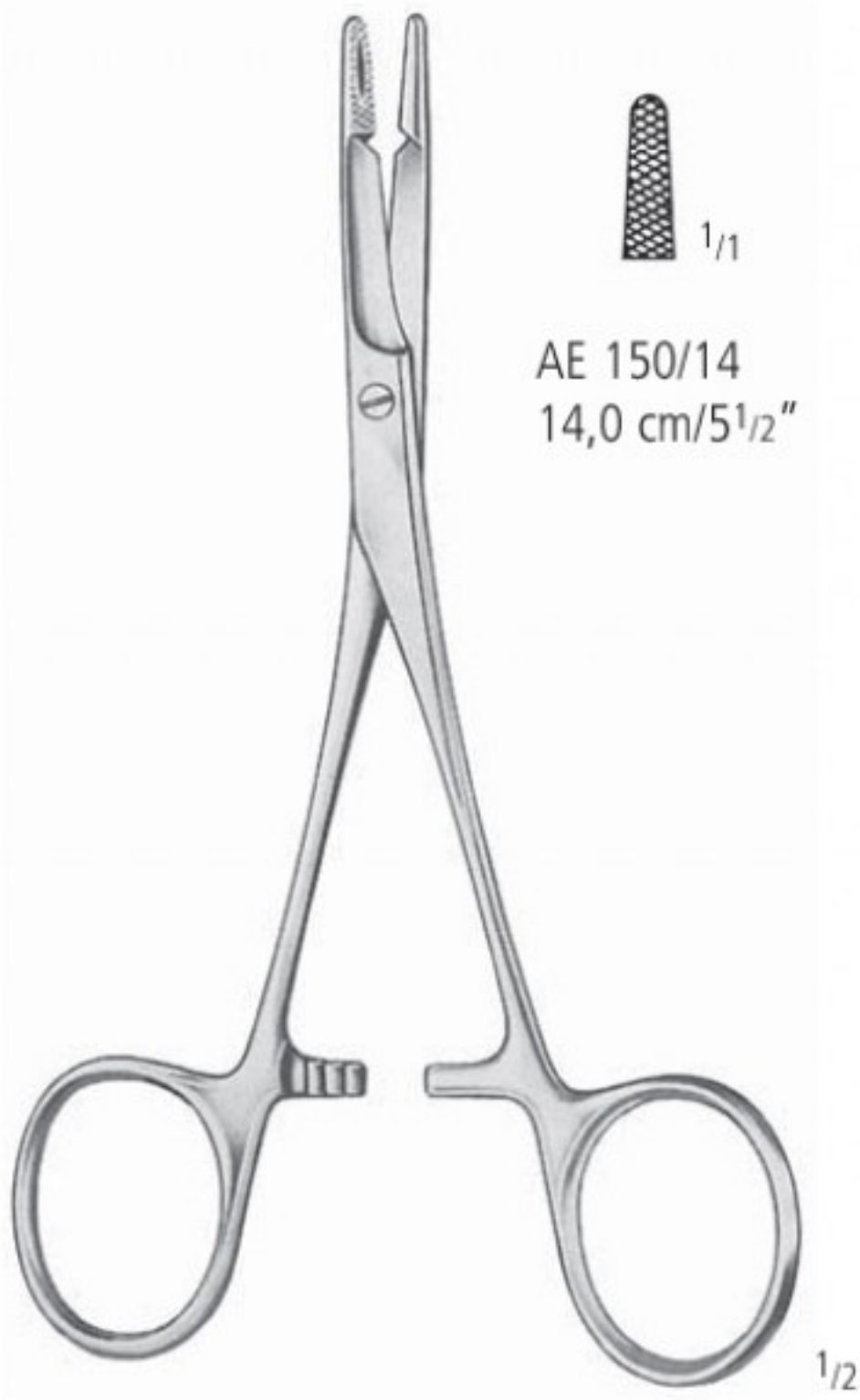
Nadelhalter
Needle Holders
Porta-agujas
Porte-aiguilles
Portaghi



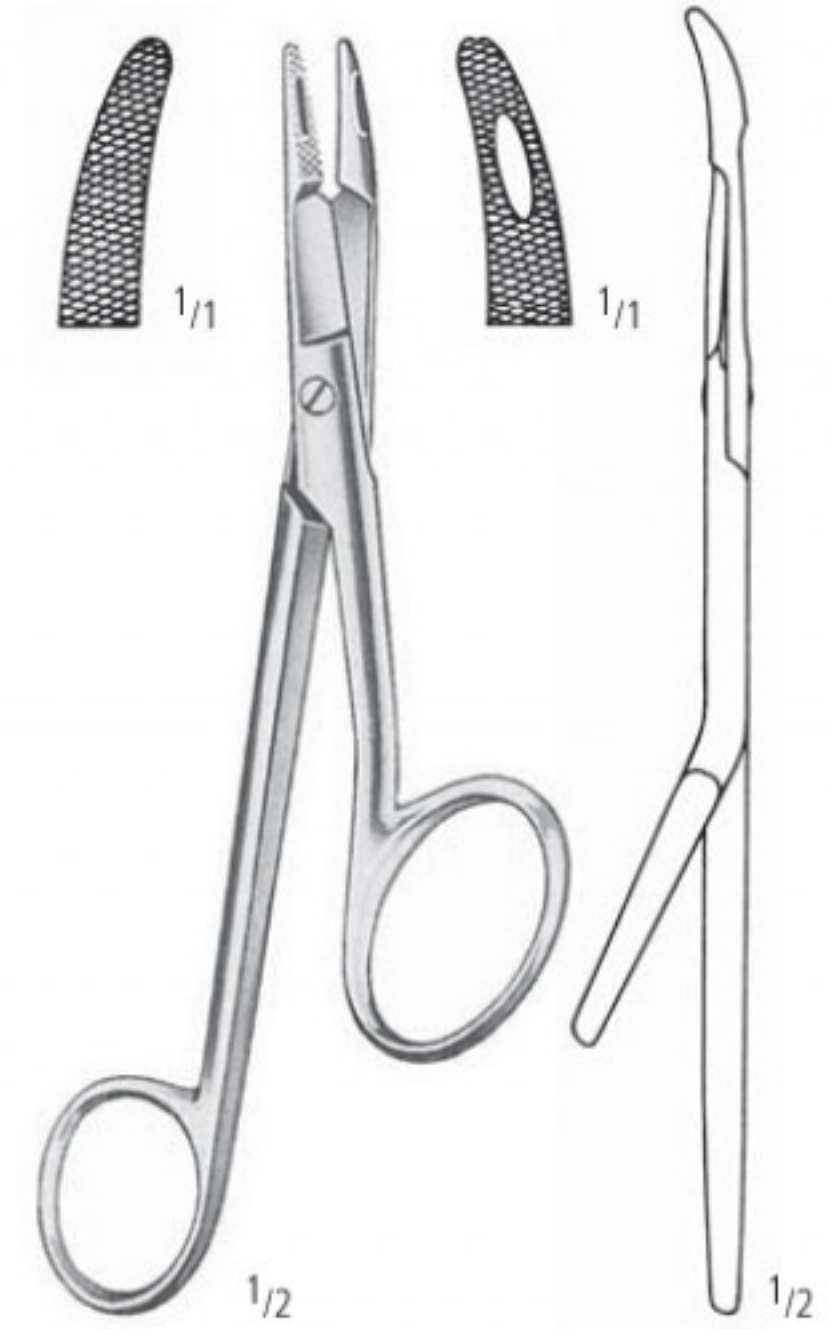

-  1/1
AE 150/14
14,0 cm/5 1/2"
-  1/1
AE 150/17
17,0 cm/6 3/4"
-  1/1
AE 150/19
19,0 cm/7 1/2"

OLSEN-HEGAR



GILLIES
AE 155/16
16,0 cm/6 1/4"



-  1/1
AE 200/14
14,0 cm/5 1/2"
-  1/1
AE 200/17
17,0 cm/6 3/4"
-  1/1
AE 200/20
20,0 cm/8"

MATHIEU



-  1/1
AE 210/14
14,0 cm/5 1/2"
-  1/1
AE 210/17
17,0 cm/6 3/4"

MATHIEU-DELICATE



-  1/1
AE 214/17
17,0 cm/6 3/4"
-  1/1
AE 214/20
20,0 cm/8"

MATHIEU

AA
AB
AC
AD
AE
AF
AK
AL
AO
AR
KA
KL
KU
PA
PB
PF
PI
PK
PL
PM
PP
PS
PT
PU
PV
KYE

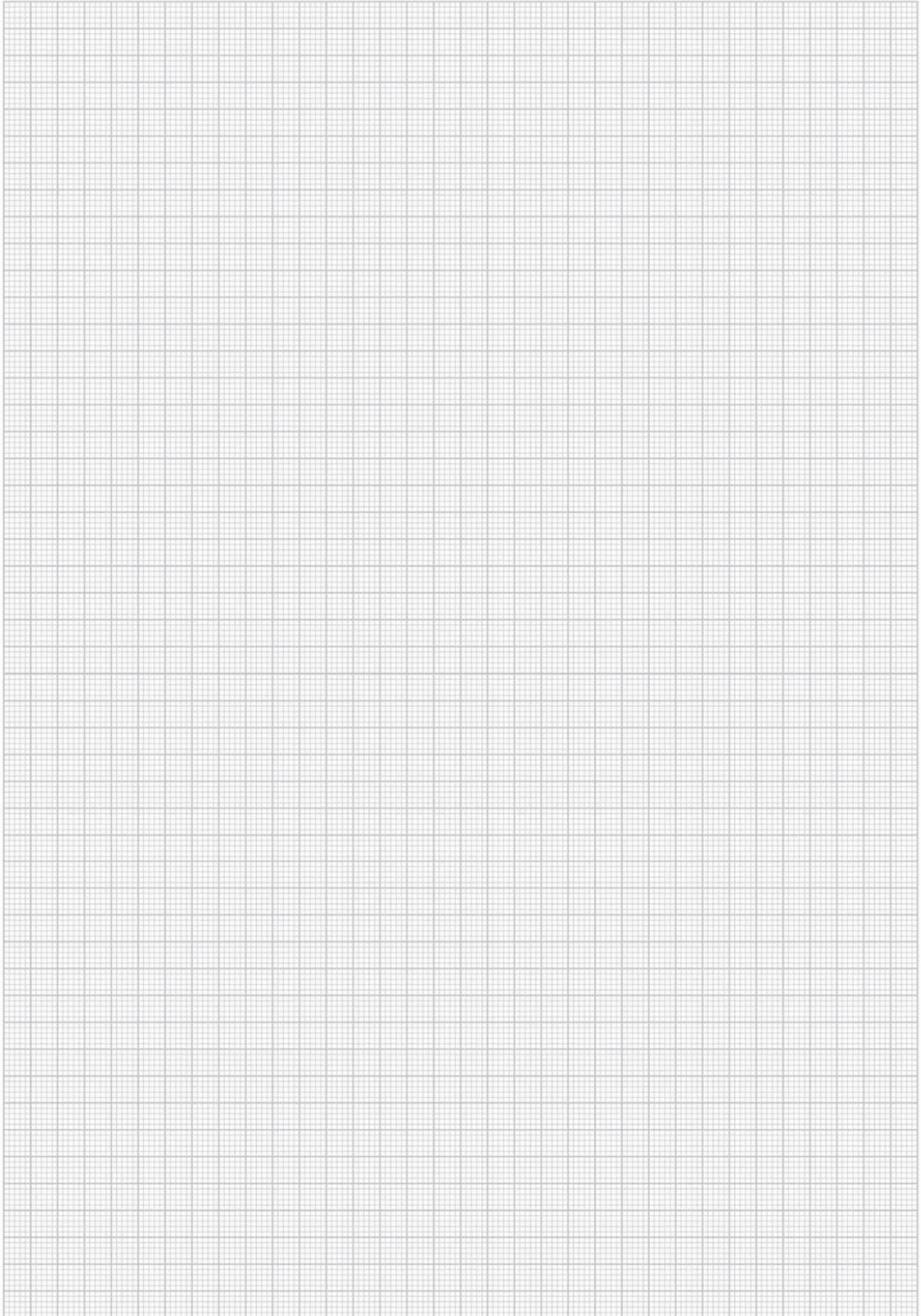

NAHT SUTURE SUTURA SUTURE SUTURA

Nadelhalter
Needle Holders
Porta-agujas
Porte-aiguilles
Portaghi

AA
AB
AC
AD
AE
AF
AK
AL
AO
AR
KA
KL
KU
PA
PB
PF
PI
PK
PL
PM
PP
PS
PT
PU
PV
KYE



TOENNIS
AE 226/18
18,0 cm/7"

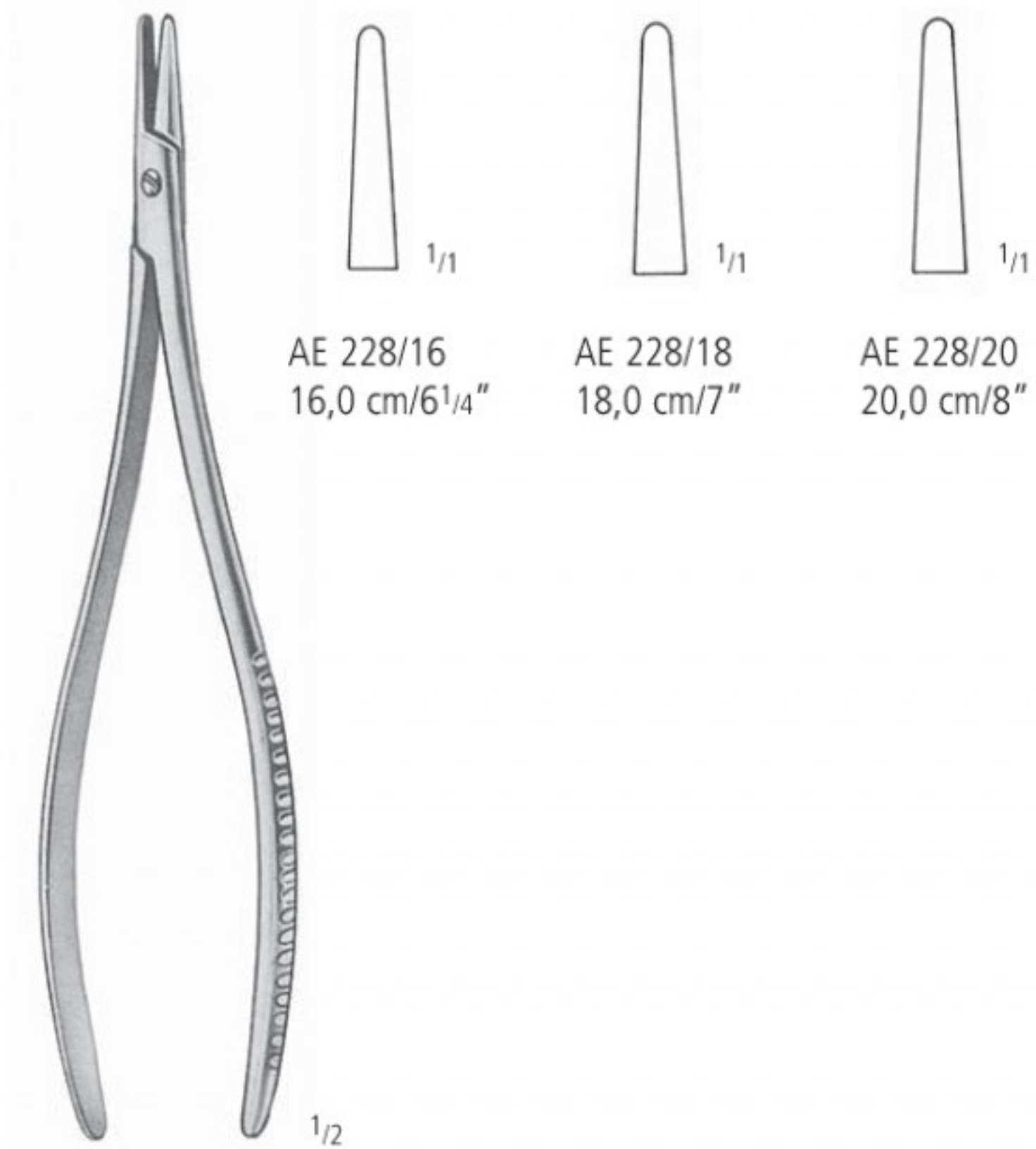

AE 228/16
16,0 cm/6¹/₄"

AE 228/18
18,0 cm/7"

AE 228/20
20,0 cm/8"

LANGENBECK

AE NAHT SUTURE SUTURA SUTURE SUTURA

Hartmetalleinsatzplättchen mit Pyramidenprofil
 Tungsten Carbide Tips with pyramidal profile
 Bocas de carburo de tungsteno con perfil de estructura piramidal
 Plaquettes en carbure de tungstène avec profil pyramidal
 Placche di carburo di tungsteno con profilo in forma piramidale

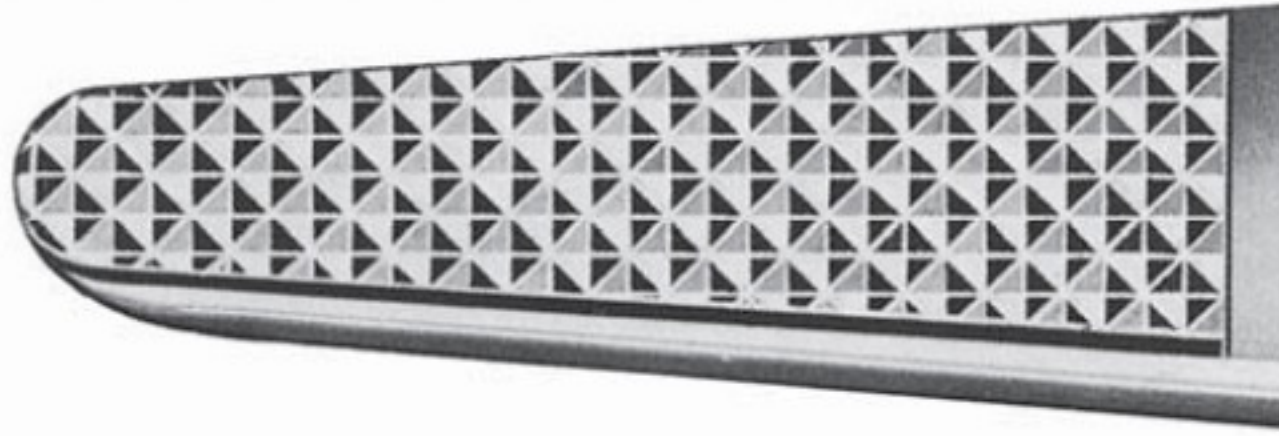

Teilung:	0,5 mm	Für Nahtmaterial 3/0 und größer
Serration:	0,5 mm	For suture sizes 3/0 and larger
Graduación:	0,5 mm	Para sutura 3/0 y más grande
Graduation:	0,5 mm	Pour suture 3/0 et plus grand
Graduazione:	0,5 mm	Per sutura 3/0 e più grande

"STANDARD"

(Mayo-Hegar, Mathieu, etc.)

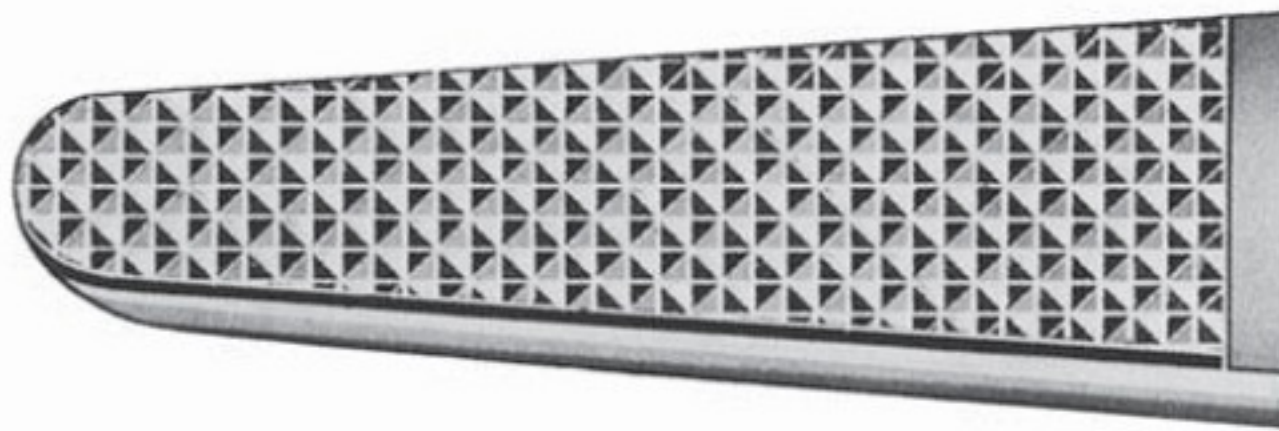

Teilung:	0,4 mm	Für Nahtmaterial zwischen 3/0 und 6/0
Serration:	0,4 mm	For sutures sizes between 3/0 and 6/0
Graduación:	0,4 mm	Para suturas entre 3/0 y 0/6
Graduation:	0,4 mm	Pour sutures entre 3/0 et 0/6
Graduazione:	0,4 mm	Per sutura tra 3/0 e 0/6

"FINE"

(Crile-Wood, Halsey, etc.)

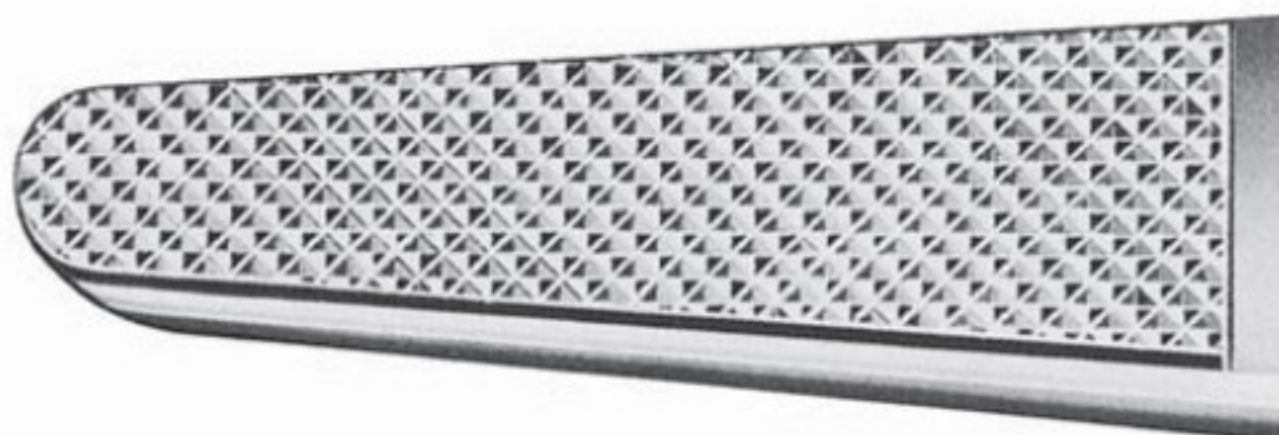

Teilung:	0,2 mm	Für Nahtmaterial zwischen 7/0 und 10/0
Serration:	0,2 mm	For sutures sizes between 7/0 and 10/0
Graduación:	0,2 mm	Para suturas entre 7/0 y 10/0
Graduation:	0,2 mm	Pour sutures entre 7/0 et 10/0
Graduazione:	0,2 mm	Per sutura tra 7/0 e 10/0

"MICRO"

(Castroviejo)

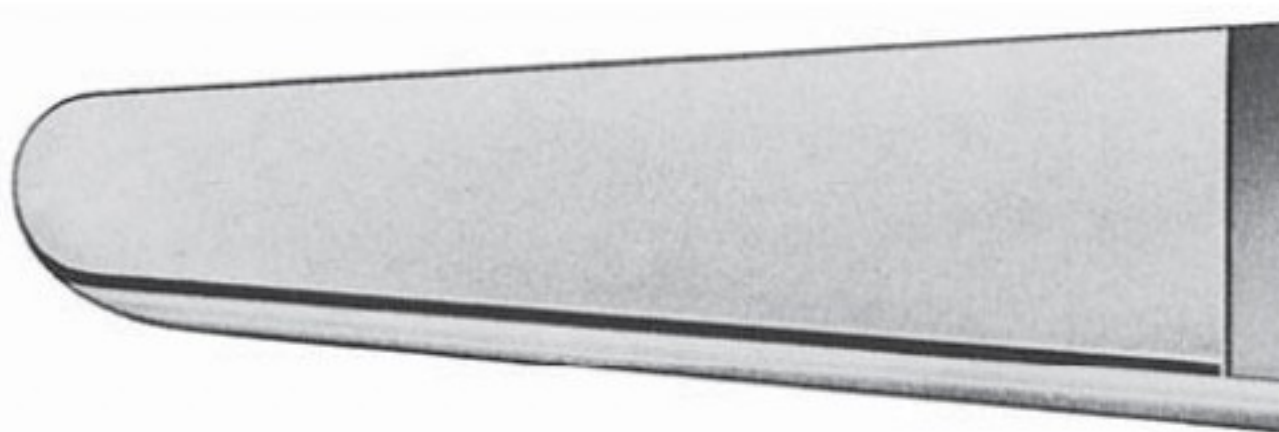

glatt	Für extrem feines Nahtmaterial
smooth	For the smallest suture sizes available
lisa	Para suturas extremamente finas
lisses	Pour matériel de suture extrêmement fin
liscio	Per materiale di sutura finissima

"SMOOTH"

(Webster, Halsey, Reill, Castroviejo, Jacobson, etc.)

NAHT SUTURE SUTURA SUTURE SUTURA

Nadelhalter mit Hartmetalleinsätzen
 Needle Holders with Tungsten Carbide Inserts
 Porta-agujas con bocas de carburo de Tungsteno
 Porte-aiguilles à mors en carbure de tungstène
 Portaghi con placche di carburo di tungsteno



MAYO-HEGAR



AE 400/14
14,0 cm/5¹/₂"



AE 400/16
16,0 cm/6¹/₄"



AE 400/18
18,0 cm/7"



AE 400/20
20,0 cm/8"

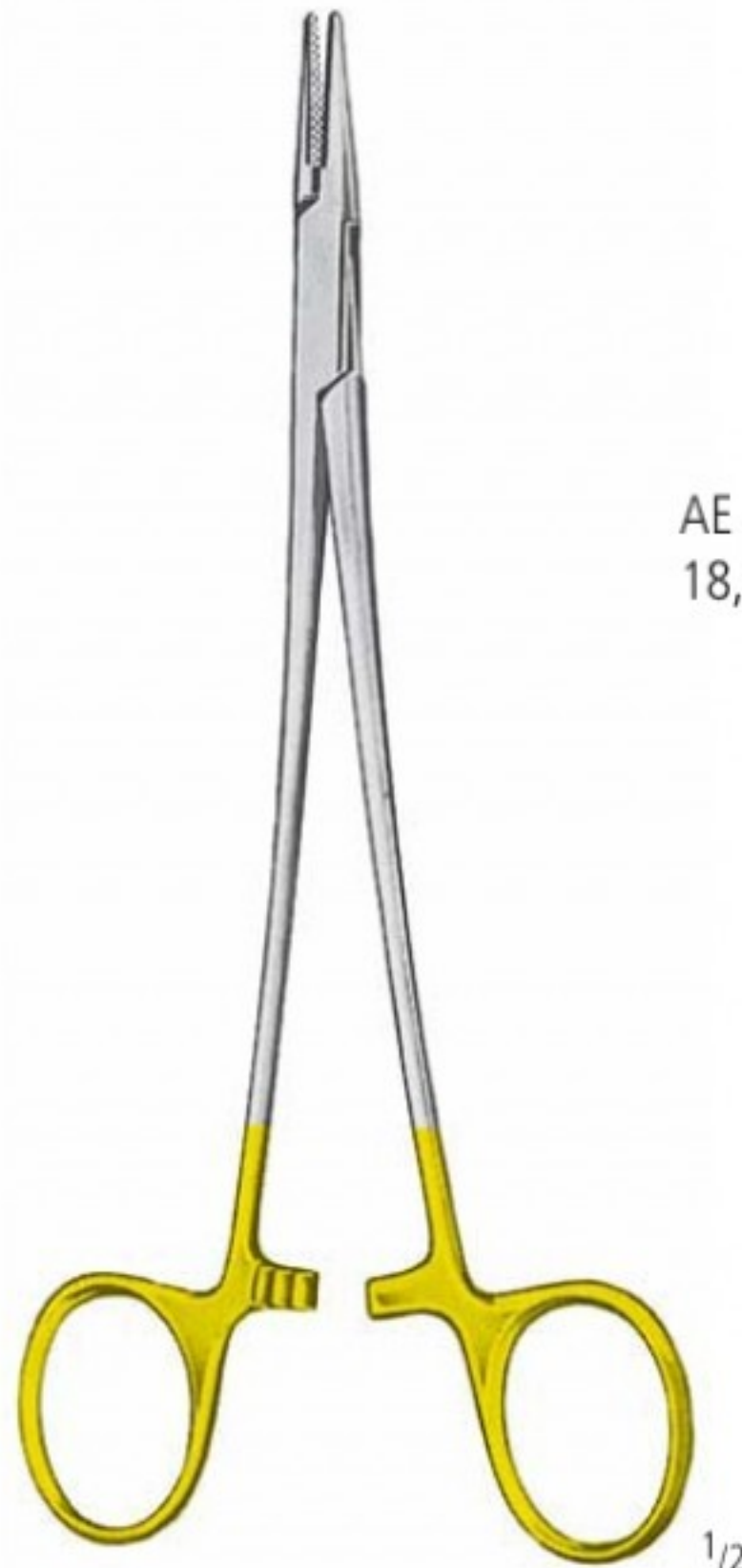

DE BAKEY
(MAYO-HEGAR-DELICATE)



AE 420/18
18,0 cm/7"



AE 420/20
20,0 cm/8"

AA
AB
AC
AD
AE
AF
AK
AL
AO
AR
KA
KL
KU
PA
PB
PF
PI
PK
PL
PM
PP
PS
PT
PU
PV
KYE

AE NAHT SUTURE SUTURA SUTURE SUTURA

Nadelhalter mit Hartmetalleinsätzen
 Needle Holders with Tungsten Carbide Inserts
 Porta-agujas con bocas de carburo de Tungsteno
 Porte-aiguilles à mors en carbure de tungstène
 Portaghi con placche di carburo di tungsteno



DERF
 AE 450/12
 12,5 cm/5"

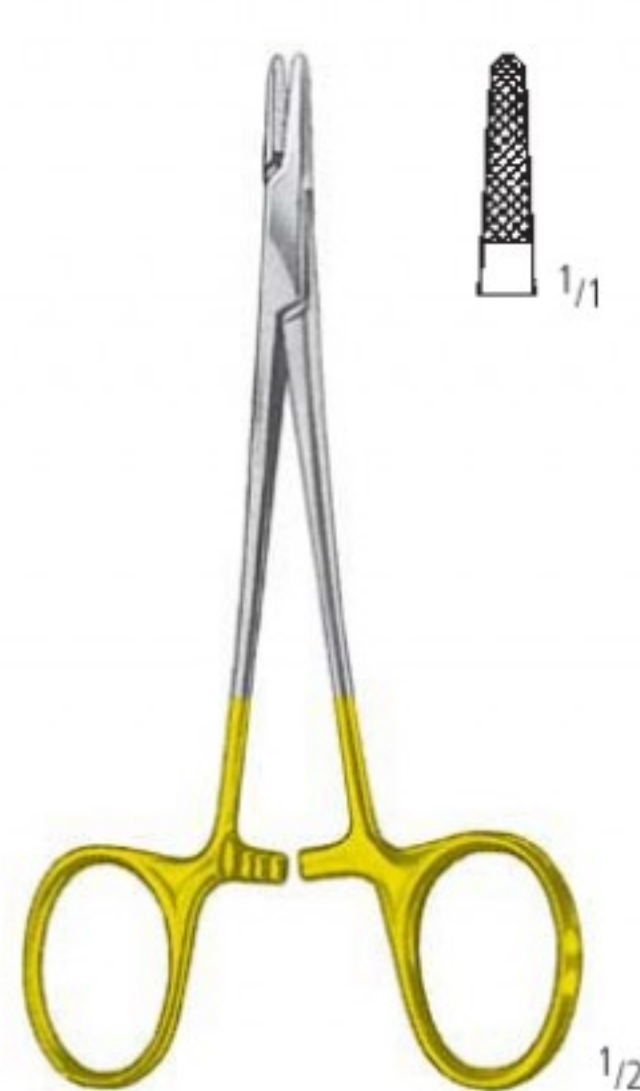

CONVERSE
 AE 452/12
 12,5 cm/5"

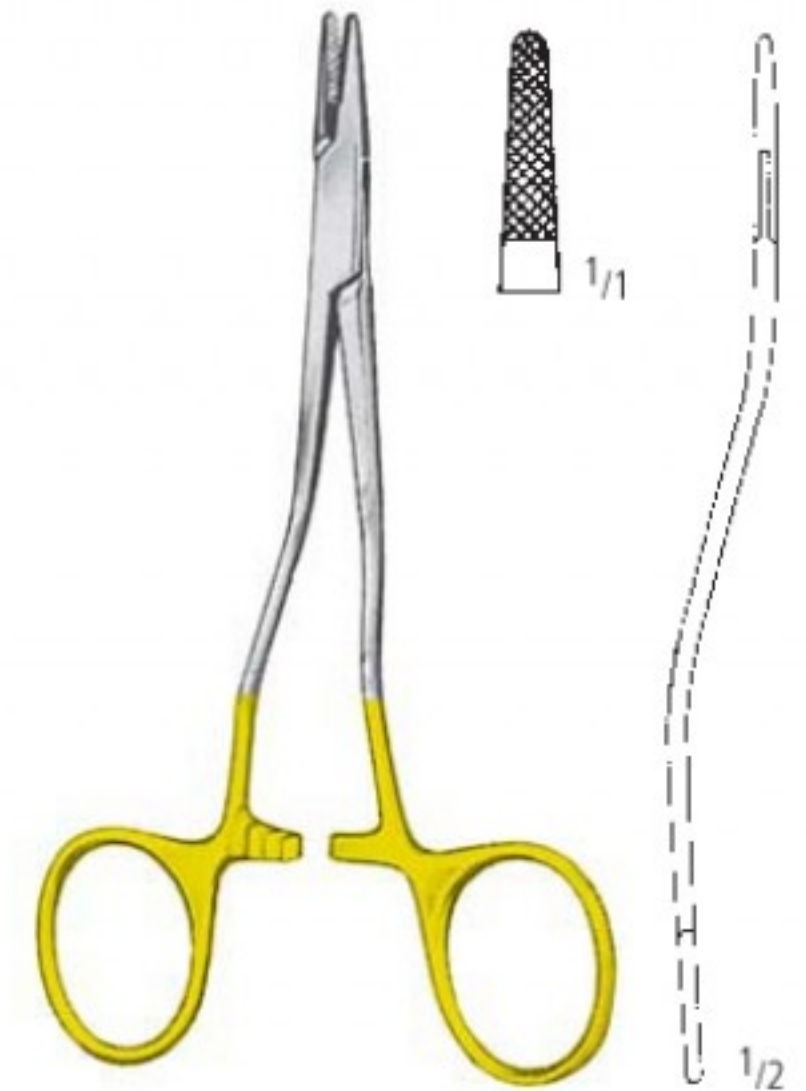

KILNER
 AE 455/13
 13,5 cm/5 1/4"



NEIVERT
 AE 456/13
 13,0 cm/5"

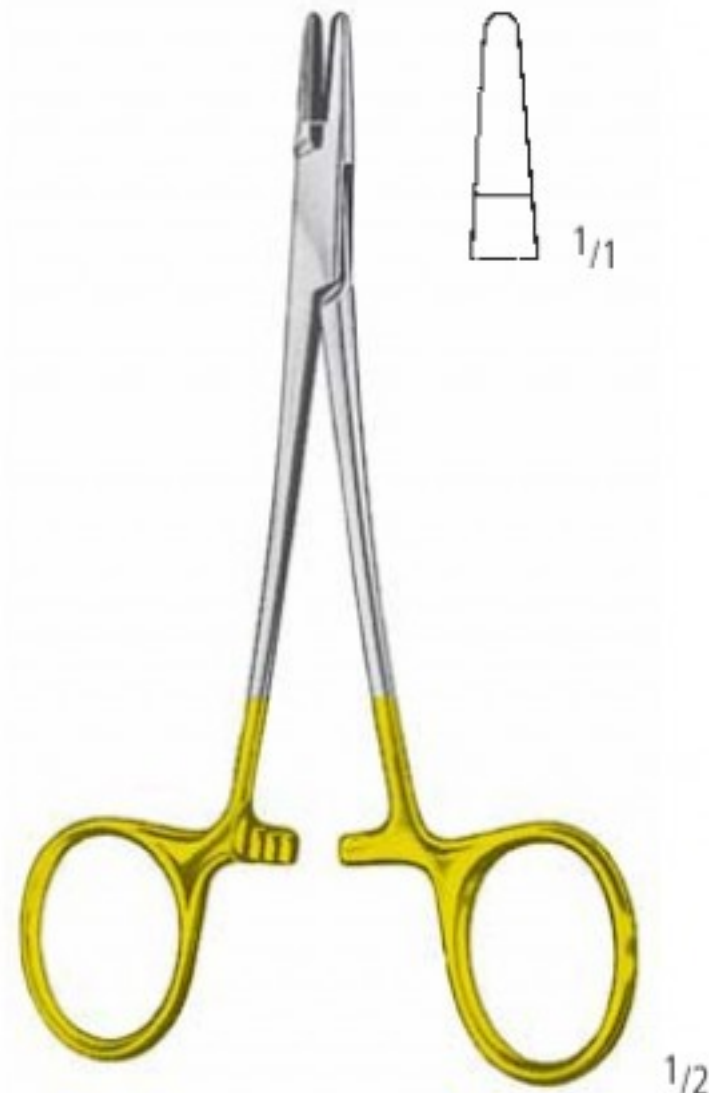

WEBSTER
 AE 460/13
 13,0 cm/5"



HALSEY
 AE 464/13
 AE 466/13
 13,0 cm/5"

NAHT SUTURE SUTURA SUTURE SUTURA

Nadelhalter mit Hartmetalleinsätzen
 Needle Holders with Tungsten Carbide Inserts
 Porta-agujas con bocas de carburo de Tungsteno
 Porte-aiguilles à mors en carbure de tungstène
 Portaghi con placche di carburo di tungsteno



BABY-CRILE-WOOD
 AE 468/15
 15,0 cm/6"



CRILE-WOOD
 AE 469/15
 15,0 cm/6"

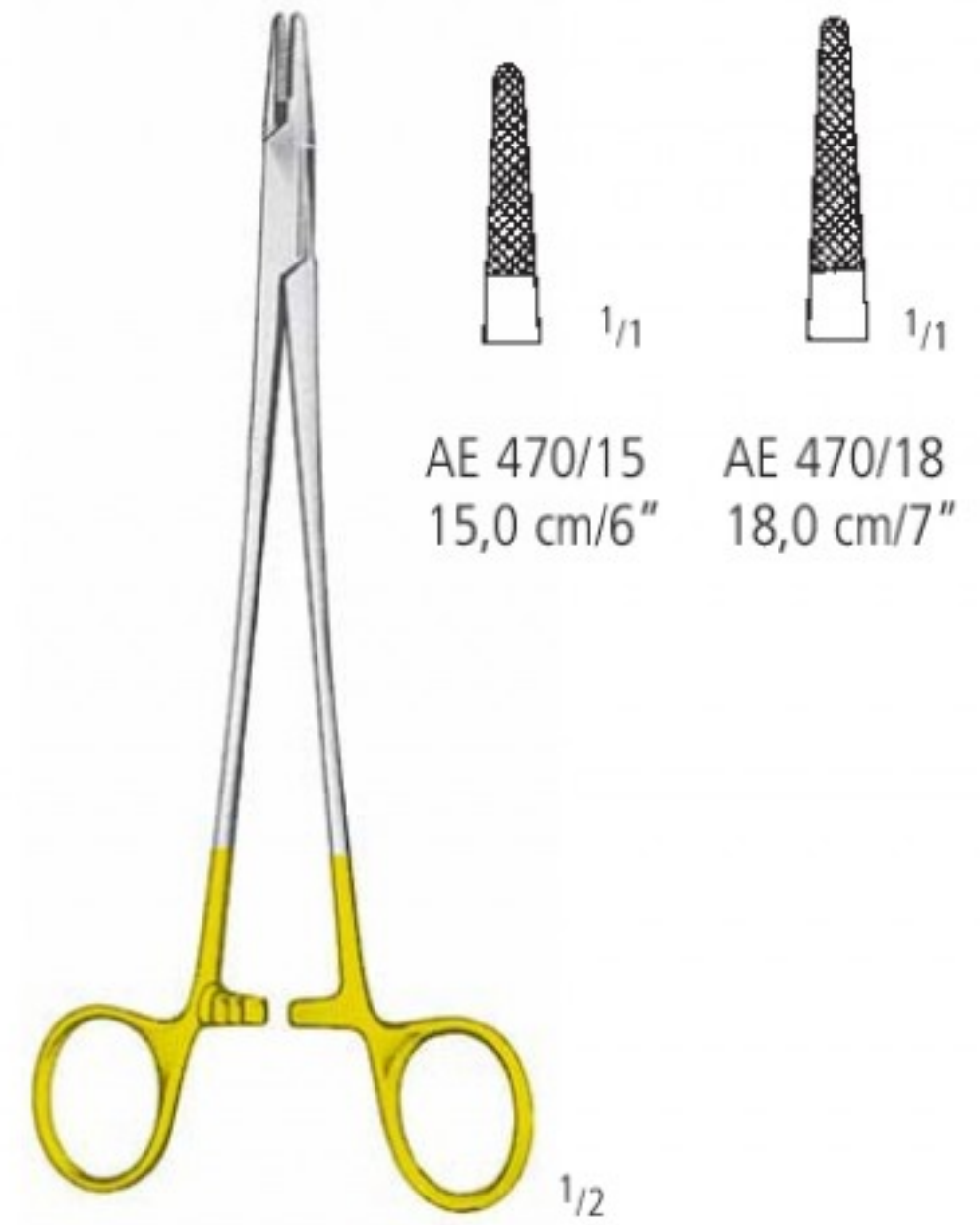

AE 470/15 15,0 cm/6"
 AE 470/18 18,0 cm/7"

CRILE-WOOD



OLSEN-HEGAR

AE 488/14
 14,0 cm/5 1/2"

AE 488/17
 17,0 cm/6 3/4"



OLSEN-HEGAR-USA
 AE 489/16
 16,0 cm/6 1/4"

AA
 AB
 AC
 AD
AE
 AF
 AK
 AL
 AO
 AR
 KA
 KL
 KU
 PA
 PB
 PF
 PI
 PK
 PL
 PM
 PP
 PS
 PT
 PU
 PV
 KYE

AE NAHT SUTURE SUTURA SUTURE SUTURA

Nadelhalter mit Hartmetalleinsätzen
 Needle Holders with Tungsten Carbide Inserts
 Porta-agujas con bocas de carburo de Tungsteno
 Porte-aiguilles à mors en carbure de tungstène
 Portaghi con placche di carburo di tungsteno

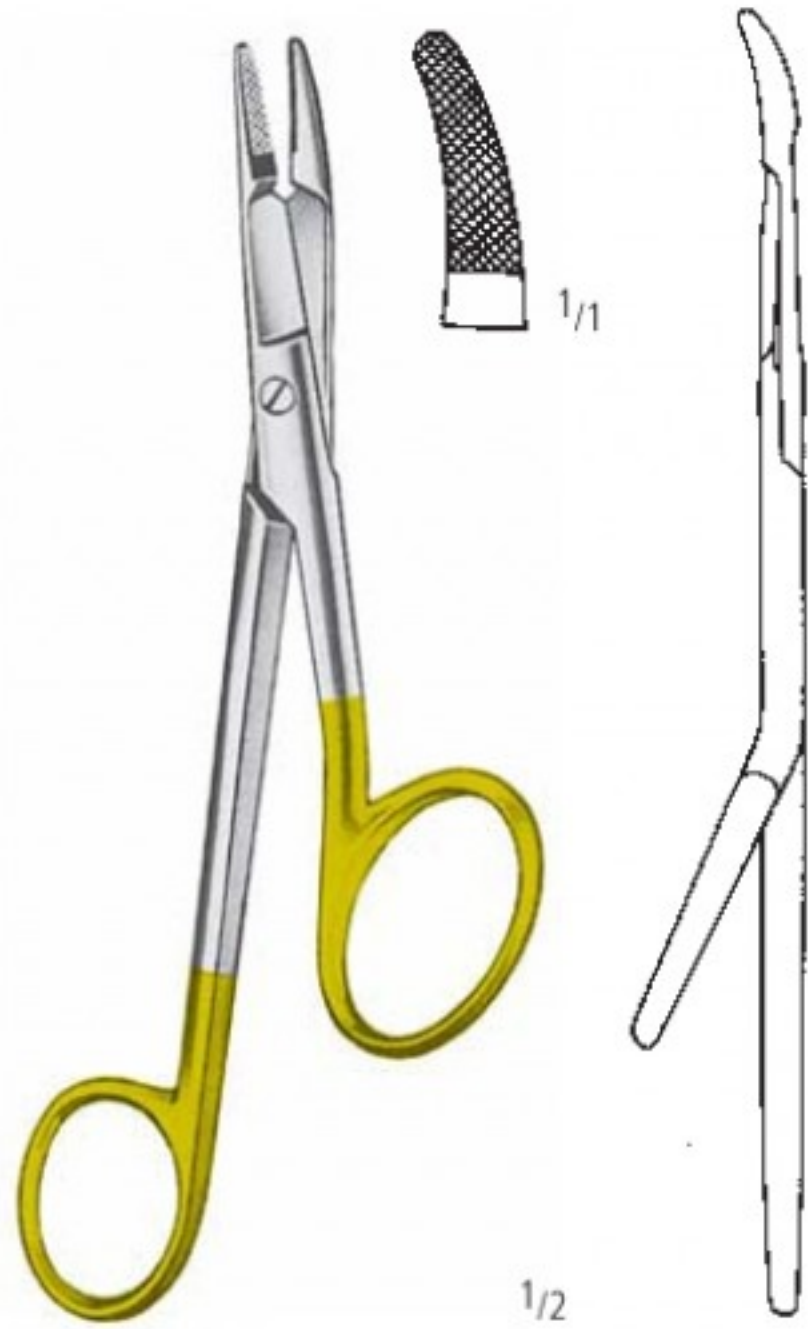

GILLIES
 AE 490/16
 16,0 cm/6¹/₄"



AE 500/14
 14,0 cm/5¹/₂"



AE 500/17
 17,0 cm/6³/₄"



AE 500/20
 20,0 cm/8"



MATHIEU
 AE 501/14
 14,0 cm/5¹/₂"



AE 502/17
 17,0 cm/6³/₄"



AE 502/20
 20,0 cm/8"

MATHIEU



AE 504/14
 14,0 cm/5¹/₂"



AE 504/17
 17,0 cm/6³/₄"



AE 504/20
 20,0 cm/8"

MATHIEU-DELICATE

NAHT SUTURE SUTURA SUTURE SUTURA

Nadelhalter mit Hartmetalleinsätzen
 Needle Holders with Tungsten Carbide Inserts
 Porta-agujas con bocas de carburo de Tungsteno
 Porte-aiguilles à mors en carbure de tungstène
 Portaghi con placche di carburo di tungsteno



AE 507/17
 17,0 cm/6³/₄"

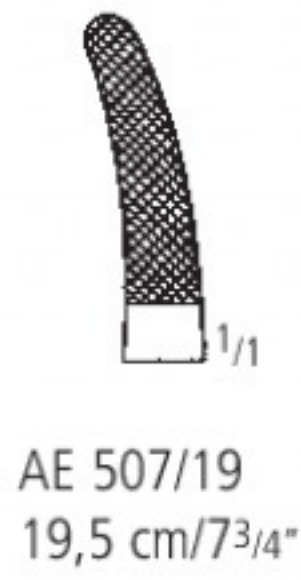

AE 507/19
 19,5 cm/7³/₄"

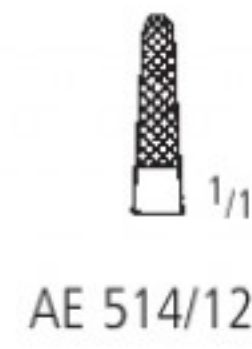

AE 514/12



AE 515/12

BOYNTON
 12,0 cm/4³/₄"

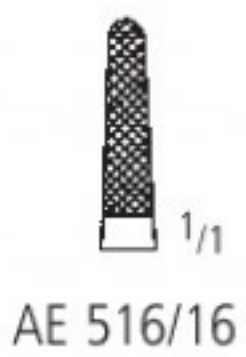

AE 516/16



ARRUGA
 16,0 cm/6¹/₄"

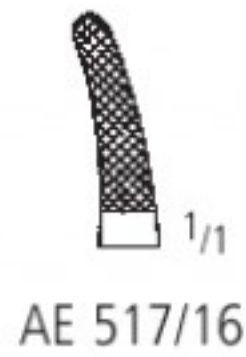

AE 517/16



TOENNIS
 AE 522/18
 18,0 cm/7"











LICHTENBERG
 AE 524/20
 20,0 cm/8"

AA
 AB
 AC
 AD
AE
 AF
 AG
 AH
 AI
 AJ
 AK
 AL
 AO
 AP
 AQ
 AR
 AS
 AT
 AU
 AV
 AW
 AX
 AY
 AZ
 BA
 BB
 BC
 BD
 BE
 BF
 BG
 BH
 BI
 BJ
 BK
 BL
 BM
 BN
 BO
 BP
 BQ
 BR
 BS
 BT
 BU
 BV
 BW
 BX
 BY
 BZ
 CA
 CB
 CC
 CD
 CE
 CF
 CG
 CH
 CI
 CJ
 CK
 CL
 CM
 CN
 CO
 CP
 CQ
 CR
 CS
 CT
 CU
 CV
 CW
 CX
 CY
 CZ
 DA
 DB
 DC
 DD
 DE
 DF
 DG
 DH
 DI
 DJ
 DK
 DL
 DM
 DN
 DO
 DP
 DQ
 DR
 DS
 DT
 DU
 DV
 DW
 DX
 DY
 DZ
 EA
 EB
 EC
 ED
 EE
 EF
 EG
 EH
 EI
 EJ
 EK
 EL
 EM
 EN
 EO
 EP
 EQ
 ER
 ES
 ET
 EU
 EV
 EW
 EX
 EY
 EZ
 FA
 FB
 FC
 FD
 FE
 FF
 FG
 FH
 FI
 FJ
 FK
 FL
 FM
 FN
 FO
 FP
 FQ
 FR
 FS
 FT
 FU
 FV
 FW
 FX
 FY
 FZ
 GA
 GB
 GC
 GD
 GE
 GF
 GG
 GH
 GI
 GJ
 GK
 GL
 GM
 GN
 GO
 GP
 GQ
 GR
 GS
 GT
 GU
 GV
 GW
 GX
 GY
 GZ
 HA
 HB
 HC
 HD
 HE
 HF
 HG
 HH
 HI
 HJ
 HK
 HL
 HM
 HN
 HO
 HP
 HQ
 HR
 HS
 HT
 HU
 HV
 HW
 HX
 HY
 HZ
 IA
 IB
 IC
 ID
 IE
 IF
 IG
 IH
 II
 IJ
 IK
 IL
 IM
 IN
 IO
 IP
 IQ
 IR
 IS
 IT
 IU
 IV
 IW
 IX
 IY
 IZ
 JA
 JB
 JC
 JD
 JE
 JF
 JG
 JH
 JI
 JJ
 JK
 JL
 JM
 JN
 JO
 JP
 JQ
 JR
 JS
 JT
 JU
 JV
 JW
 JX
 JY
 JZ
 KA
 KB
 KC
 KD
 KE
 KF
 KG
 KH
 KI
 KJ
 KK
 KL
 KM
 KN
 KO
 KP
 KQ
 KR
 KS
 KT
 KU
 KV
 KW
 KX
 KY
 KZ
 LA
 LB
 LC
 LD
 LE
 LF
 LG
 LH
 LI
 LJ
 LK
 LL
 LM
 LN
 LO
 LP
 LQ
 LR
 LS
 LT
 LU
 LV
 LW
 LX
 LY
 LZ
 MA
 MB
 MC
 MD
 ME
 MF
 MG
 MH
 MI
 MJ
 MK
 ML
 MM
 MN
 MO
 MP
 MQ
 MR
 MS
 MT
 MU
 MV
 MW
 MX
 MY
 MZ
 NA
 NB
 NC
 ND
 NE
 NF
 NG
 NH
 NI
 NJ
 NK
 NL
 NM
 NN
 NO
 NP
 NQ
 NR
 NS
 NT
 NU
 NV
 NW
 NX
 NY
 NZ
 OA
 OB
 OC
 OD
 OE
 OF
 OG
 OH
 OI
 OJ
 OK
 OL
 OM
 ON
 OO
 OP
 OQ
 OR
 OS
 OT
 OU
 OV
 OW
 OX
 OY
 OZ
 PA
 PB
 PC
 PD
 PE
 PF
 PG
 PH
 PI
 PJ
 PK
 PL
 PM
 PN
 PO
 PP
 PQ
 PR
 PS
 PT
 PU
 PV
 PW
 PX
 PY
 PZ
 QA
 QB
 QC
 QD
 QE
 QF
 QG
 QH
 QI
 QJ
 QK
 QL
 QM
 QN
 QO
 QP
 QQ
 QR
 QS
 QT
 QU
 QV
 QW
 QX
 QY
 QZ
 RA
 RB
 RC
 RD
 RE
 RF
 RG
 RH
 RI
 RJ
 RK
 RL
 RM
 RN
 RO
 RP
 RQ
 RR
 RS
 RT
 RU
 RV
 RW
 RX
 RY
 RZ
 SA
 SB
 SC
 SD
 SE
 SF
 SG
 SH
 SI
 SJ
 SK
 SL
 SM
 SN
 SO
 SP
 SQ
 SR
 SS
 ST
 SU
 SV
 SW
 SX
 SY
 SZ
 TA
 TB
 TC
 TD
 TE
 TF
 TG
 TH
 TI
 TJ
 TK
 TL
 TM
 TN
 TO
 TP
 TQ
 TR
 TS
 TT
 TU
 TV
 TW
 TX
 TY
 TZ
 UA
 UB
 UC
 UD
 UE
 UF
 UG
 UH
 UI
 UJ
 UK
 UL
 UM
 UN
 UO
 UP
 UQ
 UR
 US
 UT
 UY
 UZ
 VA
 VB
 VC
 VD
 VE
 VF
 VG
 VH
 VI
 VJ
 VK
 VL
 VM
 VN
 VO
 VP
 VQ
 VR
 VS
 VT
 VU
 VV
 VW
 VX
 VY
 VZ
 WA
 WB
 WC
 WD
 WE
 WF
 WG
 WH
 WI
 WJ
 WK
 WL
 WM
 WN
 WO
 WP
 WQ
 WR
 WS
 WT
 WU
 WV
 WW
 WX
 WY
 WZ
 XA
 XB
 XC
 XD
 XE
 XF
 XG
 XH
 XI
 XJ
 XK
 XL
 XM
 XN
 XO
 XP
 XQ
 XR
 XS
 XT
 XU
 XV
 XW
 XX
 XY
 XZ
 YA
 YB
 YC
 YD
 YE
 YF
 YG
 YH
 YI
 YJ
 YK
 YL
 YM
 YN
 YO
 YP
 YQ
 YR
 YS
 YT
 YU
 YV
 YW
 YX
 YZ
 ZA
 ZB
 ZC
 ZD
 ZE
 ZF
 ZG
 ZH
 ZI
 ZJ
 ZK
 ZL
 ZM
 ZN
 ZO
 ZP
 ZQ
 ZR
 ZS
 ZT
 ZU
 ZV
 ZW
 ZX
 ZY
 ZZ

AE NAHT SUTURE SUTURA SUTURE SUTURA

Nadelhalter mit Hartmetalleinsätzen
 Needle Holders with Tungsten Carbide Inserts
 Porta-agujas con bocas de carburo de Tungsteno
 Porte-aiguilles à mors en carbure de tungstène
 Portaghi con placche di carburo di tungsteno

	 1/1	 1/1	 1/1	
	AE 540/16 16,0 cm/6 ¹ / ₄ "	AE 540/18 18,0 cm/7"	AE 540/20 20,0 cm/8"	LANGENBECK
	 1/1	 1/1	 1/1	
	AE 542/18 18,0 cm/7"	AE 542/20 20,0 cm/8"	AE 542/23 23,0 cm/9"	LANGENBECK-DELICATE
	 1/1	 1/1	 1/1	
	AE 544/18 18,0 cm/7"	AE 544/20 20,0 cm/8"	AE 544/23 23,0 cm/9"	LANGENBECK-RYDER

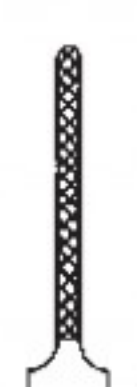
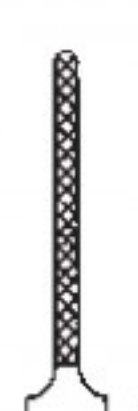
NAHT SUTURE SUTURA SUTURE SUTURA

Drahtzangen mit Hartmetalleinsätzen
 Wire Twisting Forceps with Tungsten Carbide Inserts
 Pinzas para torcer hilos con bocas de carburo de Tungsteno
 Pinces à torsader le fil à mors en carbure de tungstène
 Pinze per ritorcere fili con placche di carburo di tungsteno

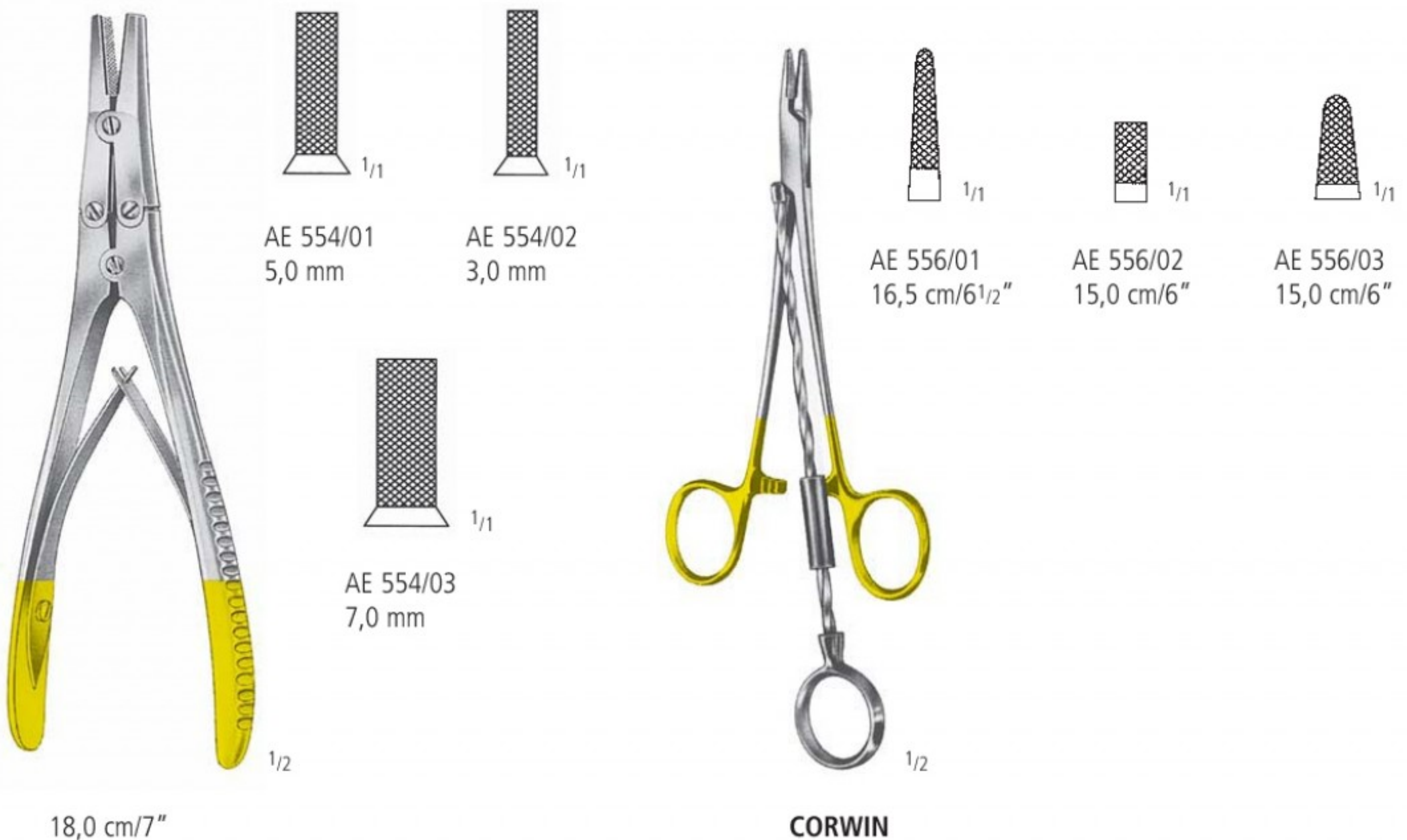
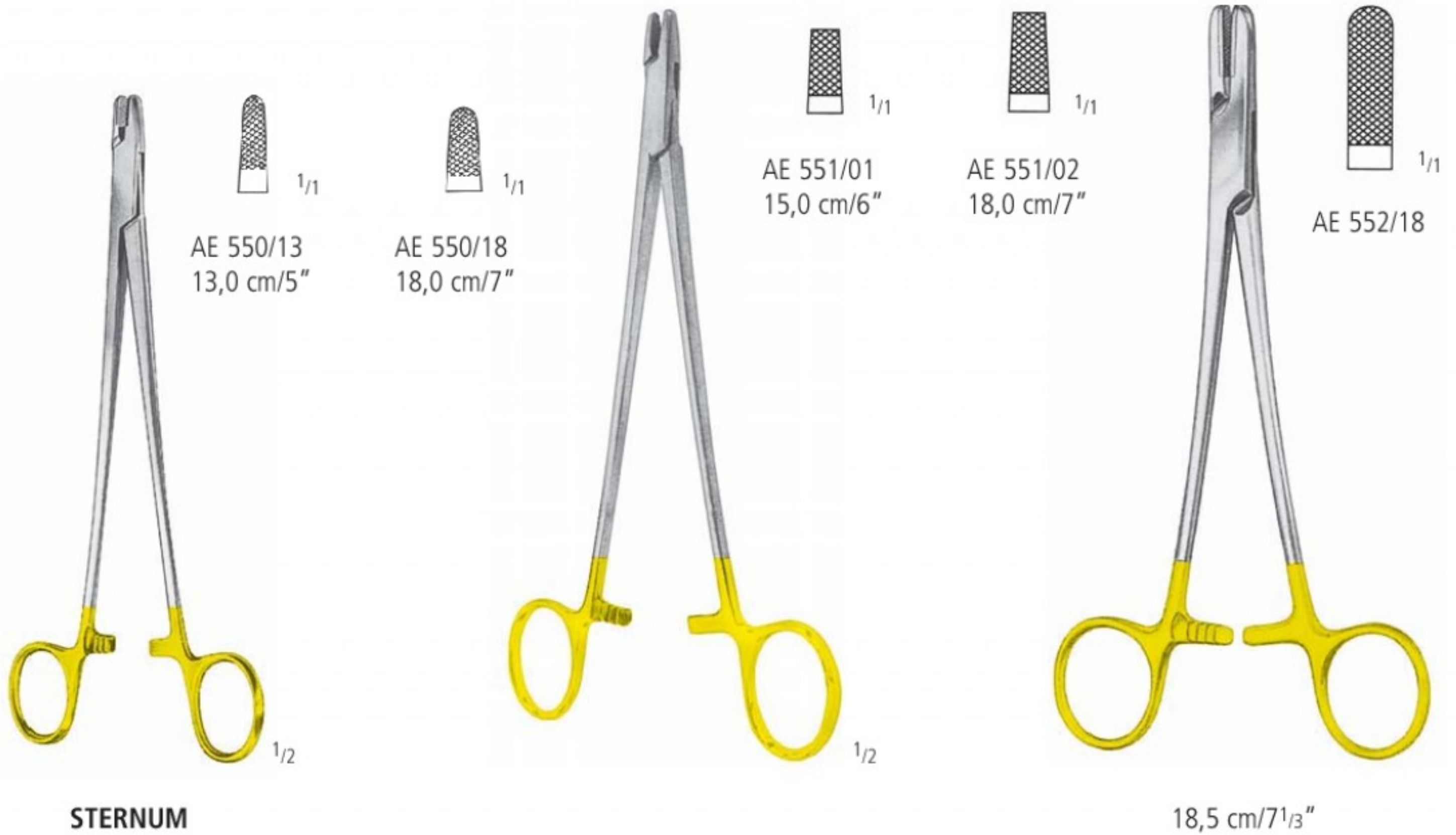

AA
AB
AC
AD
AE
AF
AK
AL
AO
AR
KA
KL
KU
PA
PB
PF
PI
PK
PL
PM
PP
PS
PT
PU
PV
KYE

AE NAHT SUTURE SUTURA SUTURE SUTURA

Mikro-Nadelhalter mit Hartmetalleinsätzen
 Micro-Needle Holders with Tungsten Carbide Inserts
 Micro-Porta-agujas con bocas de carburo de Tungsteno
 Micro-Porte-aiguilles à mors en carbure de tungstène
 Micro-Portaghi con placche di carburo di tungsteno



CASTROVIEJO
 14,0 cm/5 1/2"

CASTROVIEJO
 14,0 cm/5 1/2"

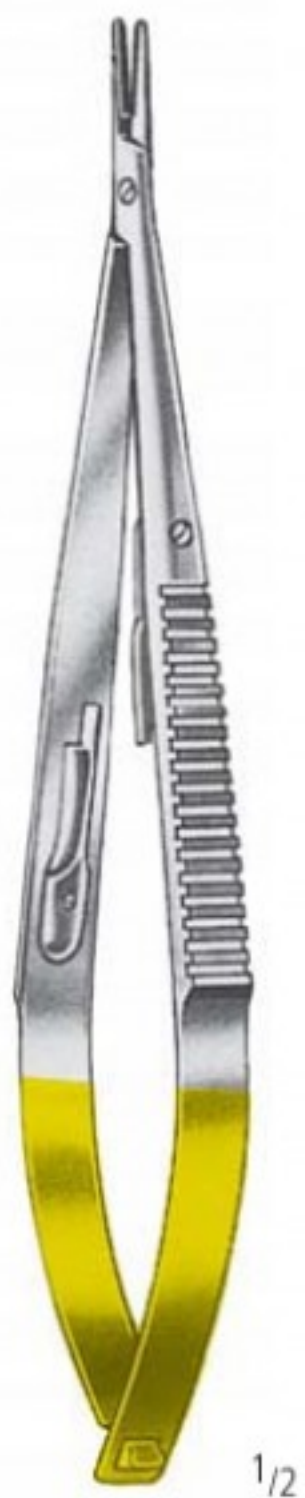

18,0 cm/7"

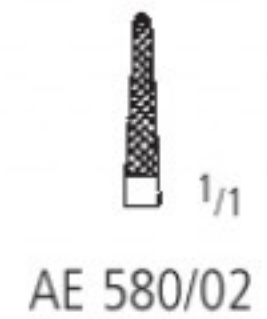
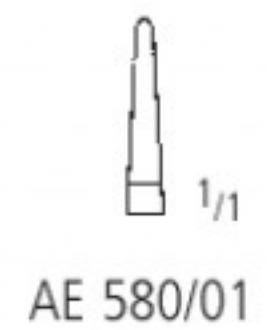
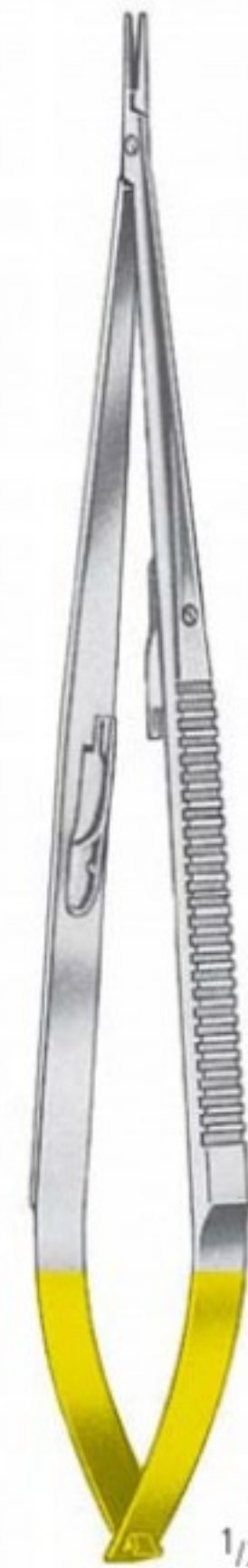

JACOBSON
 21,0 cm/8 1/4"

NAHT SUTURE SUTURA SUTURE SUTURA

Mikro-Nadelhalter mit Rundgriff
 Micro-Needle Holders with Pen-Type Handle
 Micro-Porta-agujas con mango redondo
 Micro-Porte-aiguilles à manches rondes
 Micro-Portaghi con manici rotondi

AA
AB
AC
AD
AE
AF
AG
AH
AI
AJ
AK
AL
AO
AR
AS
AT
AU
AV
AW
AX
AY
AZ
BA
BB
BC
BD
BE
BF
BG
BH
BI
BJ
BK
BL
BM
BN
BO
BP
BQ
BR
BS
BT
BU
BV
BW
BX
BY
BZ
CA
CB
CC
CD
CE
CF
CG
CH
CI
CJ
CK
CL
CM
CN
CO
CP
CQ
CR
CS
CT
CU
CV
CW
CX
CY
CZ
DA
DB
DC
DD
DE
DF
DG
DH
DI
DJ
DK
DL
DM
DN
DO
DP
DQ
DR
DS
DT
DU
DV
DW
DX
DY
DZ
EA
EB
EC
ED
EE
EF
EG
EH
EI
EJ
EK
EL
EM
EN
EO
EP
EQ
ER
ES
ET
EU
EV
EW
EX
EY
EZ
FA
FB
FC
FD
FE
FF
FG
FH
FI
FJ
FK
FL
FM
FN
FO
FP
FQ
FR
FS
FT
FU
FV
FW
FX
FY
FZ
GA
GB
GC
GD
GE
GF
GG
GH
GI
GJ
GK
GL
GM
GN
GO
GP
GQ
GR
GS
GT
GU
GV
GW
GX
GY
GZ
HA
HB
HC
HD
HE
HF
HG
HH
HI
HJ
HK
HL
HM
HN
HO
HP
HQ
HR
HS
HT
HU
HV
HW
HX
HY
HZ
IA
IB
IC
ID
IE
IF
IG
IH
II
IJ
IK
IL
IM
IN
IO
IP
IQ
IR
IS
IT
IU
IV
IW
IX
IY
IZ
JA
JB
JC
JD
JE
JF
JG
JH
JI
JJ
JK
JL
JM
JN
JO
JP
JQ
JR
JS
JT
JU
JV
JW
JX
JY
JZ
KA
KB
KC
KD
KE
KF
KG
KH
KI
KJ
KK
KL
KM
KN
KO
KP
KQ
KR
KS
KT
KU
KV
KW
KX
KY
KZ
LA
LB
LC
LD
LE
LF
LG
LH
LI
LJ
LK
LL
LM
LN
LO
LP
LQ
LR
LS
LT
LU
LV
LW
LX
LY
LZ
MA
MB
MC
MD
ME
MF
MG
MH
MI
MJ
MK
ML
MN
MO
MP
MQ
MR
MS
MT
MU
MV
MW
MX
MY
MZ
NA
NB
NC
ND
NE
NF
NG
NH
NI
NJ
NK
NL
NM
NN
NO
NP
NQ
NR
NS
NT
NU
NV
NW
NX
NY
NZ
OA
OB
OC
OD
OE
OF
OG
OH
OI
OJ
OK
OL
OM
ON
OO
OP
OQ
OR
OS
OT
OU
OV
OW
OX
OY
OZ
PA
PB
PC
PD
PE
PF
PG
PH
PI
PJ
PK
PL
PM
PN
PO
PP
PQ
PR
PS
PT
PU
PV
PW
PX
PY
PZ
QA
QB
QC
QD
QE
QF
QG
QH
QI
QJ
QK
QL
QM
QN
QO
QP
QQ
QR
QS
QT
QU
QV
QW
QX
QY
QZ
RA
RB
RC
RD
RE
RF
RG
RH
RI
RJ
RK
RL
RM
RN
RO
RP
RQ
RR
RS
RT
RU
RV
RW
RX
RY
RZ
SA
SB
SC
SD
SE
SF
SG
SH
SI
SJ
SK
SL
SM
SN
SO
SP
SQ
SR
SS
ST
SU
SV
SW
SX
SY
SZ
TA
TB
TC
TD
TE
TF
TG
TH
TI
TJ
TK
TL
TM
TN
TO
TP
TQ
TR
TS
TT
TU
TV
TW
TX
TY
TZ
UA
UB
UC
UD
UE
UF
UG
UH
UI
UJ
UK
UL
UM
UN
UO
UP
UQ
UR
US
UT
UU
UV
UW
UX
UY
UZ
VA
VB
VC
VD
VE
VF
VG
VH
VI
VJ
VK
VL
VM
VN
VO
VP
VQ
VR
VS
VT
VU
VV
VW
VX
VY
VZ
WA
WB
WC
WD
WE
WF
WG
WH
WI
WJ
WK
WL
WM
WN
WO
WP
WQ
WR
WS
WT
WU
WV
WW
WX
WY
WZ
XA
XB
XC
XD
XE
XF
XG
XH
XI
XJ
XK
XL
XM
XN
XO
XP
XQ
XR
XS
XT
XU
XV
XW
XX
XY
XZ
YA
YB
YC
YD
YE
YF
YG
YH
YI
YJ
YK
YL
YM
YN
YO
YP
YQ
YR
YS
YT
YU
YV
YW
YX
YZ
ZA
ZB
ZC
ZD
ZE
ZF
ZG
ZH
ZI
ZJ
ZK
ZL
ZM
ZN
ZO
ZP
ZQ
ZR
ZS
ZT
ZU
ZV
ZW
ZX
ZY
ZZ



 1/1
 AE 610/15

 1/1
 AE 611/15

REILL
 15,0 cm/6"



 1/1
 AE 612/15

 1/1
 AE 613/15

REILL
 15,0 cm/6"

AE NAHT SUTURE SUTURA SUTURE SUTURA

Mikro-Nadelhalter mit Rundgriff
 Micro-Needle Holders with Pen-Type Handle
 Micro-Porta-agujas con mango redondo
 Micro-Porte-aiguilles à manches rondes
 Micro-Portaghi con manici rotondi



NAHT SUTURE SUTURA SUTURE SUTURA

Mikro-Nadelhalter
 Micro-Needle Holders
 Micro-Porta-agujas
 Micro-Porte-aiguilles
 Micro-Portaghi

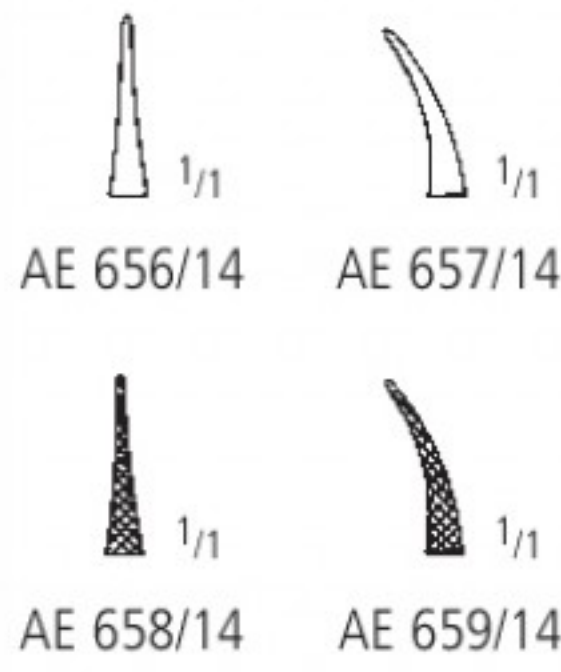

CASTROVIEJO
 14,0 cm/5 1/2"

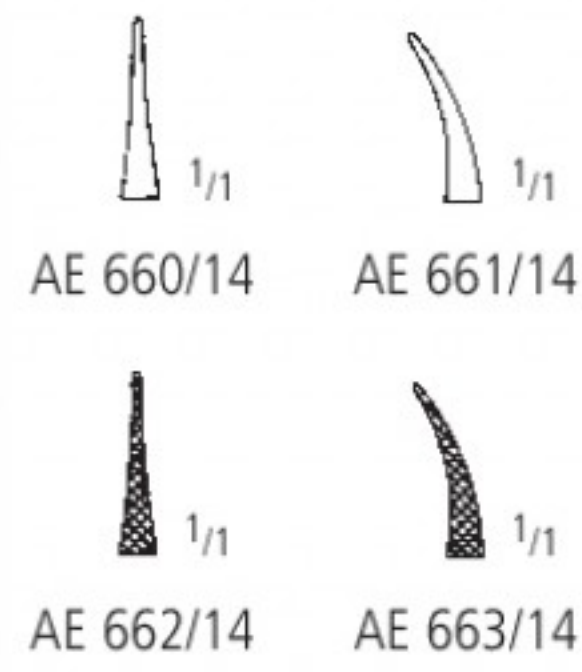
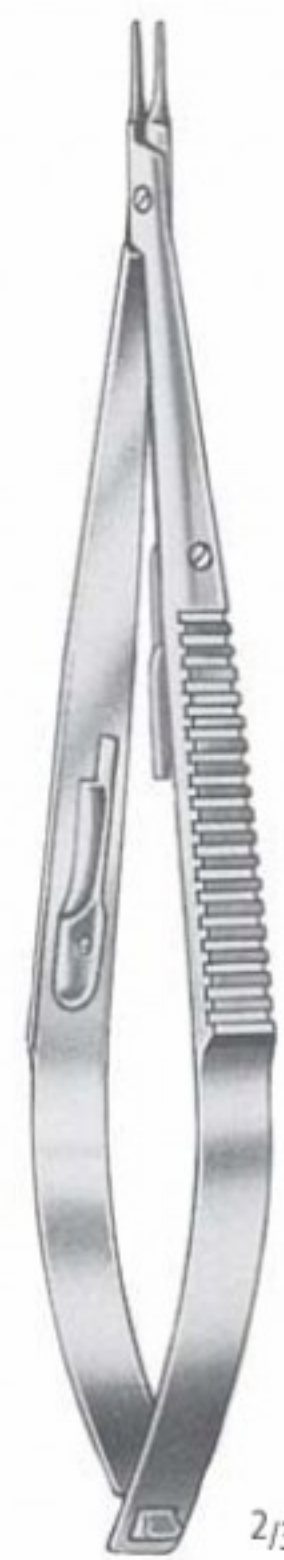

CASTROVIEJO
 14,0 cm/5 1/2"

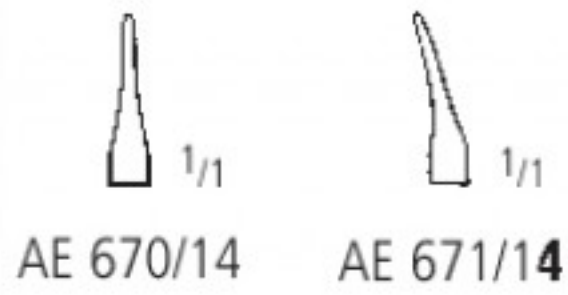
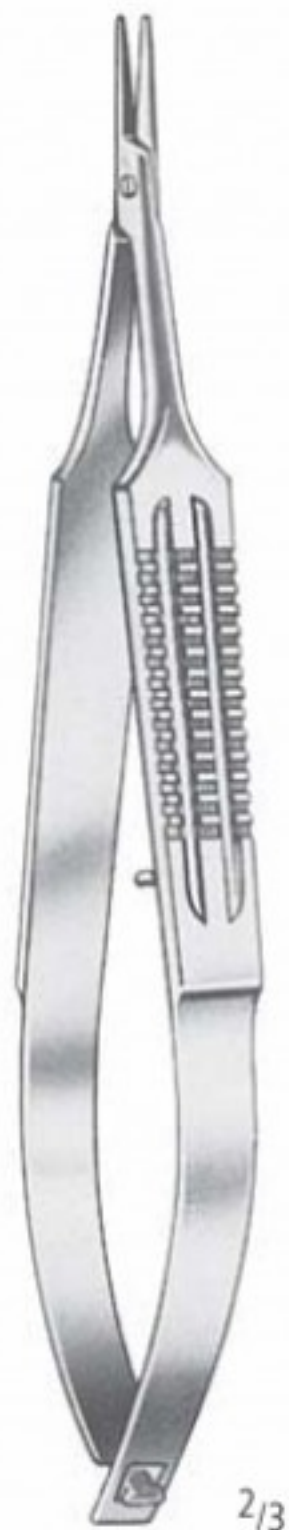

breiter Griff
 wide handle
 mango ancho
 manche large
 manico largo

CASTROVIEJO
 14,0 cm/5 1/2"

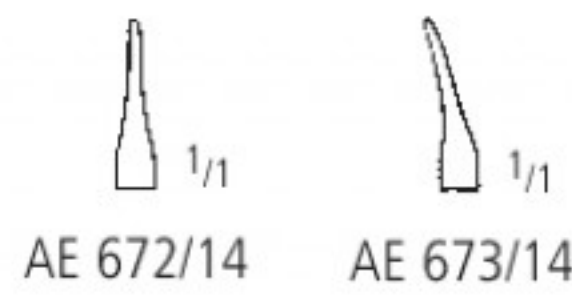
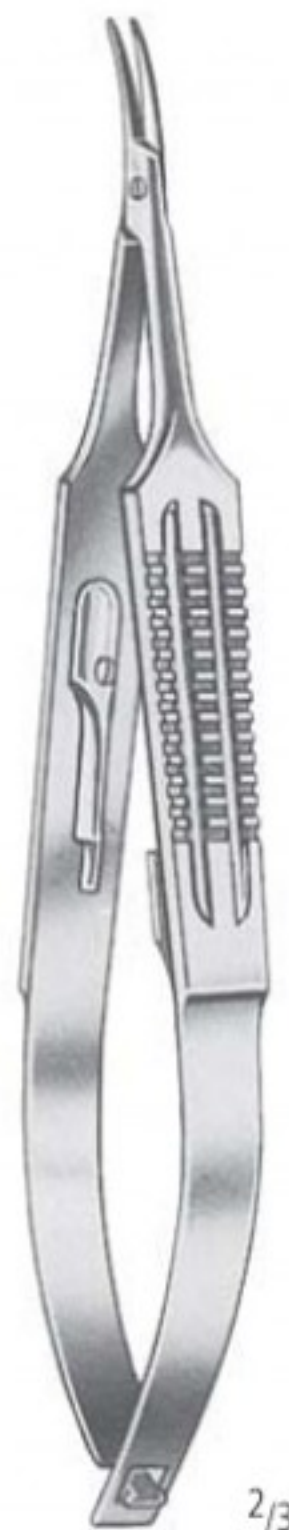

CASTROVIEJO
 14,0 cm/5 1/2"



JACOBSON

AA
 AB
 AC
 AD
AE
 AF
 AK
 AL
 AO
 AR
 KA
 KL
 KU
 PA
 PB
 PF
 PI
 PK
 PL
 PM
 PP
 PS
 PT
 PU
 PV
 KYE

TUPFERZANGEN
SPONGE FORCEPS
PINZAS PARA POLIPOS
PINCES A PANSEMENTS
PINZE PER POLIPI

AF

nopa[®] instruments



TUPFERZANGEN SPONGE FORCEPS PINZAS PARA POLIPOS PINCES A PANSEMENTS PINZE PER POLIPI

Schwammzangen, Korn- und Tupferzangen
 Sponge Holding Forceps, Polypus and Dressing Forceps
 Pinzas para esponjas, pinzas para pólipos
 Pincas à éponges, pincas à pansements
 Pinze per spugne, pinze per polipi

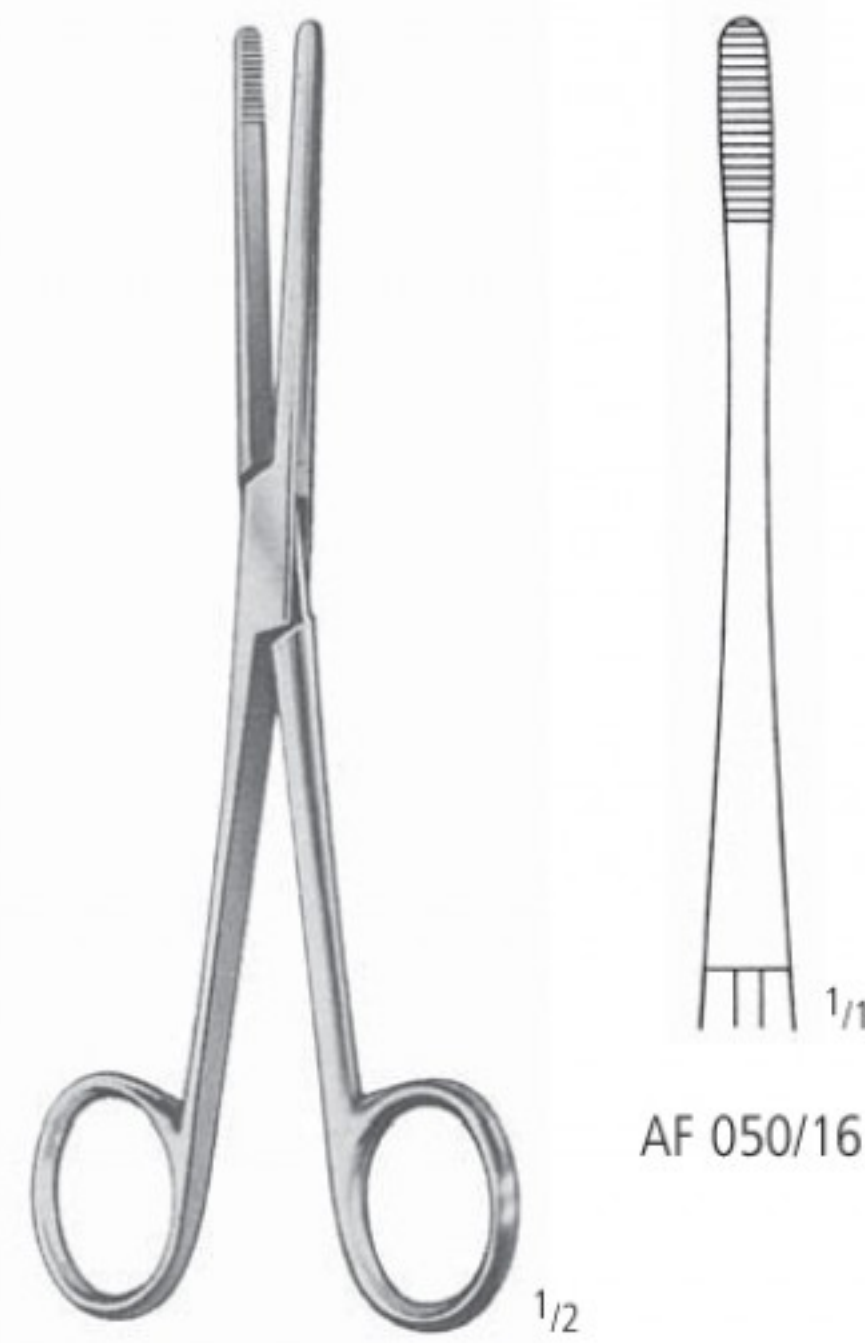

AF 050/16

LISTER

- 13,0 cm/5" AF 050/13
- 16,0 cm/6¹/₄" AF 050/16
- 18,0 cm/7" AF 050/18



GROSS-MAIER

- AF 100/20
- AF 100/22

- 20,0 cm/8"
- 22,0 cm/8³/₄"



GROSS-MAIER

- AF 101/20
- AF 101/22

AA
AB
AC
AD
AE
AF
AK
AL
AO
AR
KA
KL
KU
PA
PB
PF
PI
PK
PL
PM
PP
PS
PT
PU
PV
KYE

Korn- und Tupferzangen
 Polypus and Dressing Forceps
 Pinzas para pólipos
 Pincers à pansements
 Pinze per polipi



AF 226/17

WALTON
 17,0 cm/6³/₄"



AF 227/17

WUNDHAKEN
RETRACTORS
SEPARADORES
ECARTEURS
DIVARICATORI

AK

nopa[®] instruments



AK

WUNDHAKEN RETRACTORS SEPARADORES ECARTEURS DIVARICATORI

Feine Wundhaken
Delicate Hooks
Ganchos
Crochets très fins
Divaricatori sottili

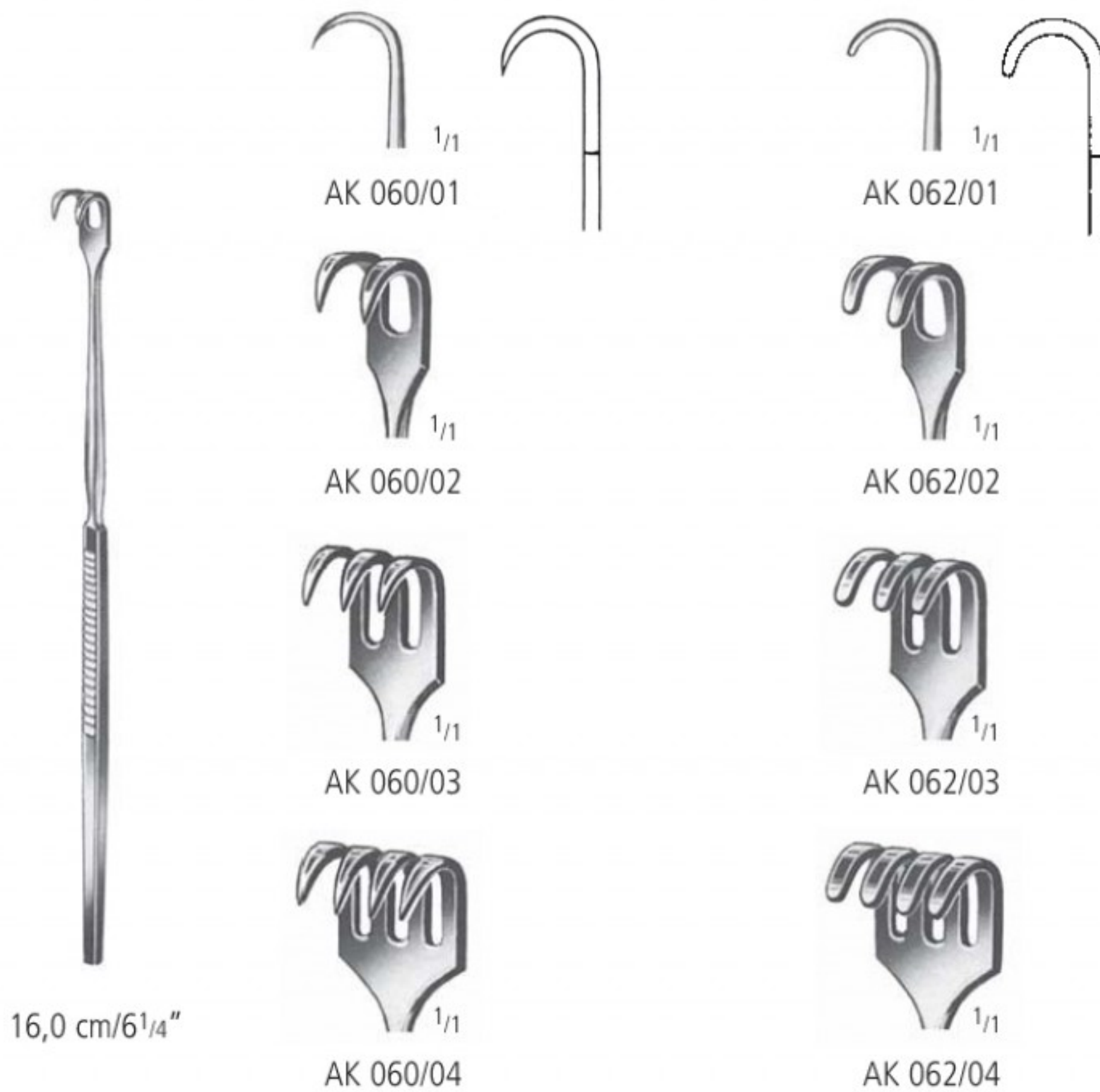
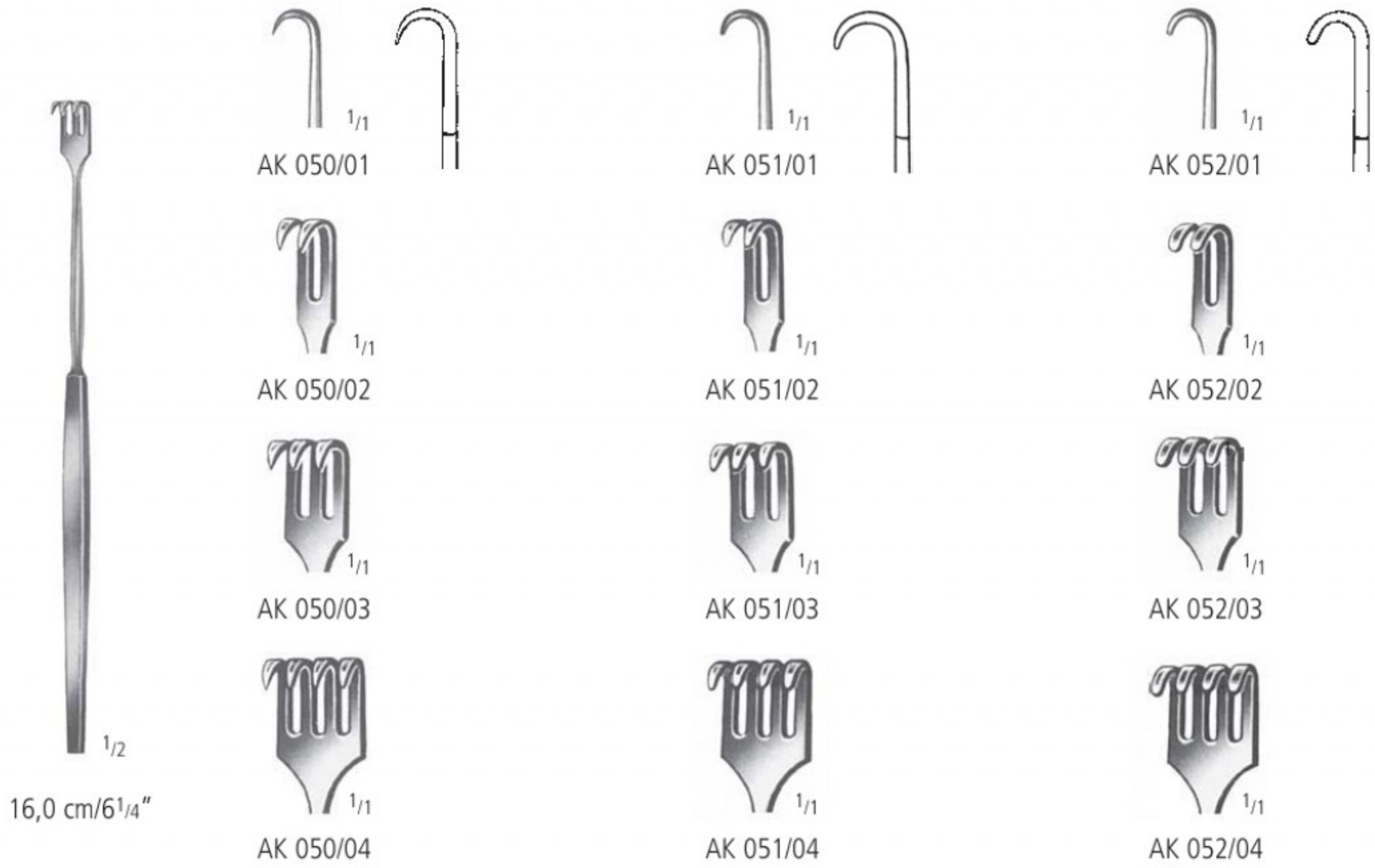

WUNDHAKEN RETRACTORS SEPARADORES ECARTEURS DIVARICATORI

Feine Wundhaken
Delicate Hooks
Ganchos
Crochets très fins
Divaricatori sottili

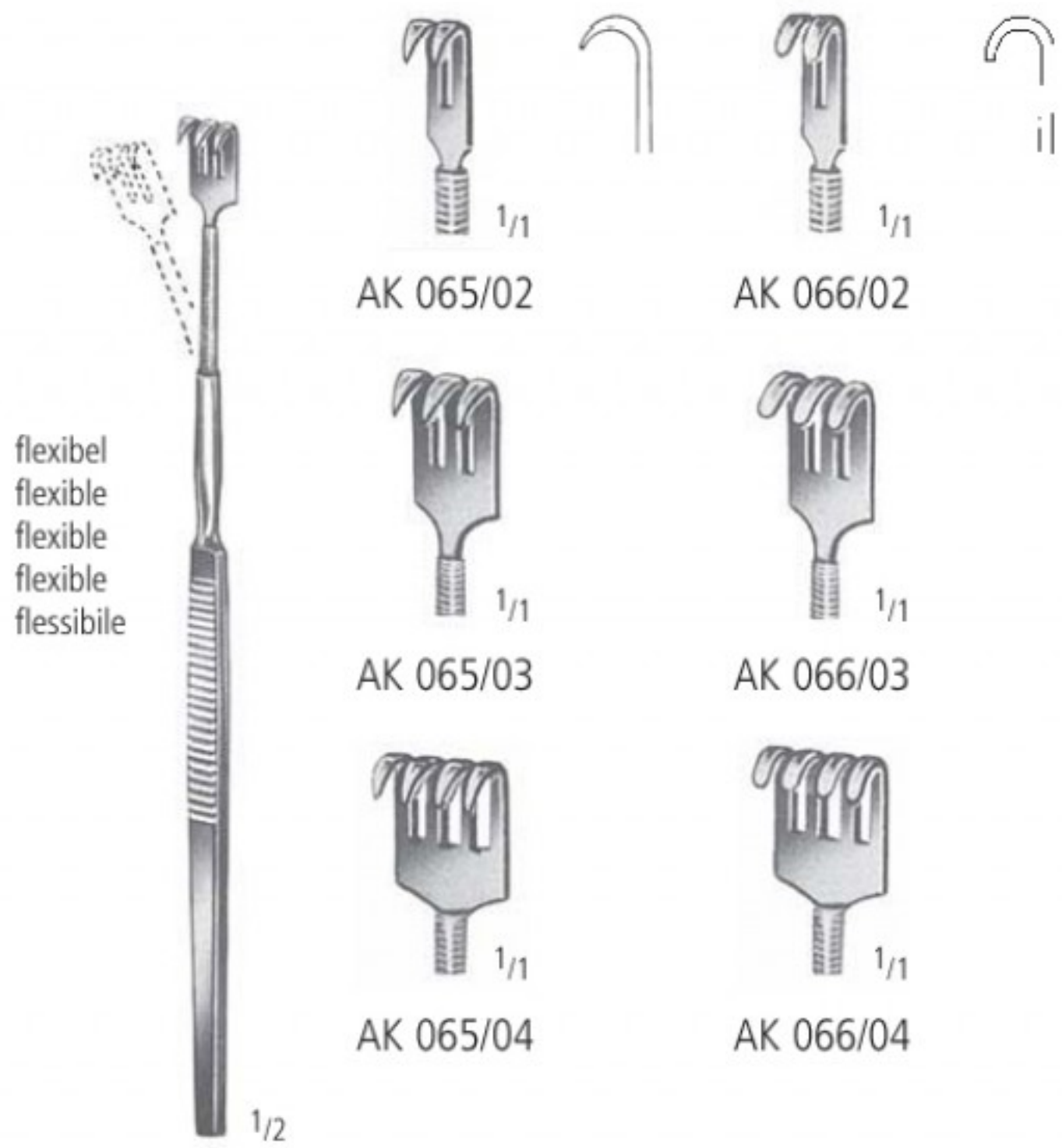

flexibel
flexible
flexible
flexible
flexibile

16,0 cm/6 1/4"

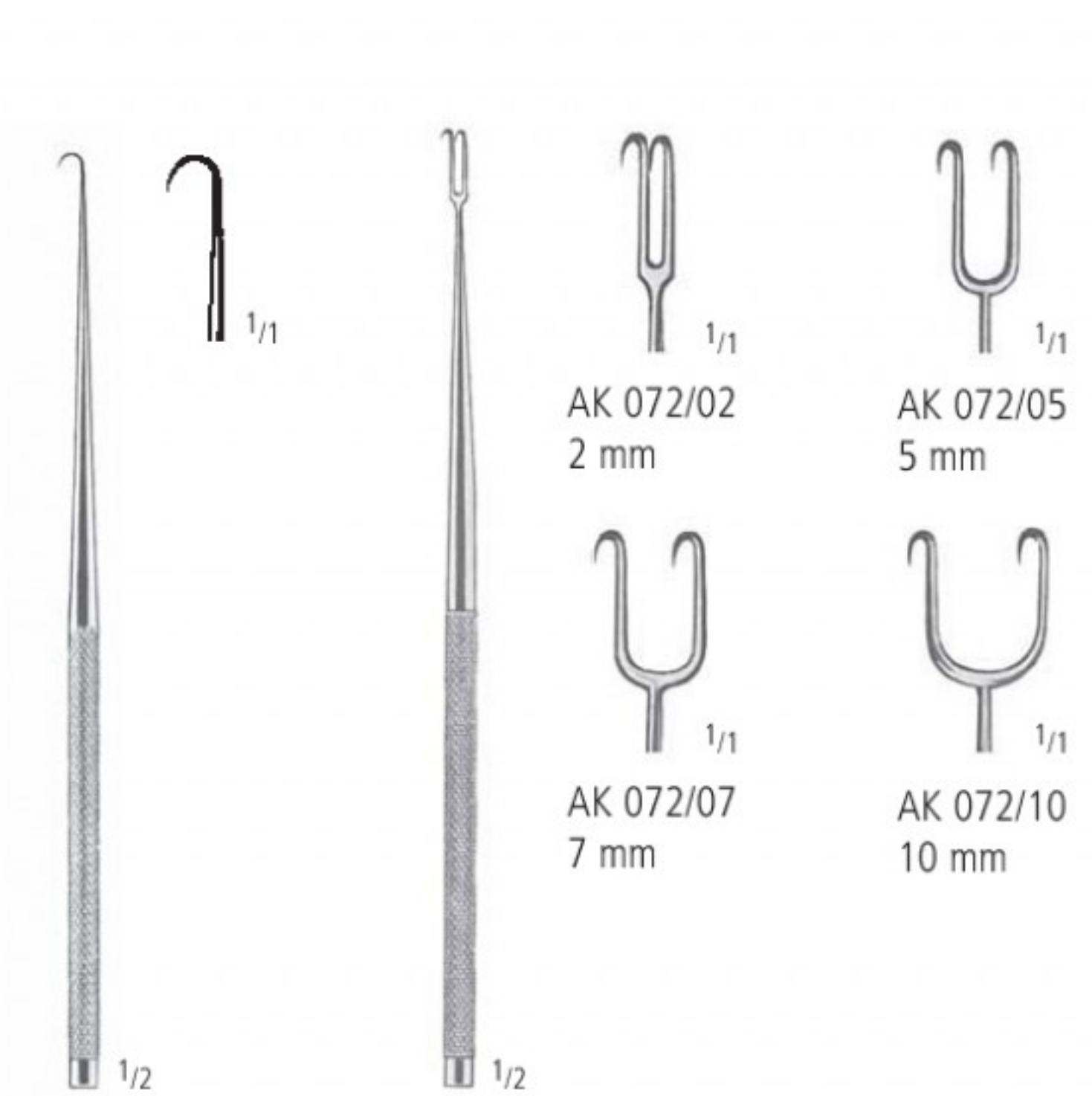

JOSEPH
AK 070/16
16,0 cm/6 1/4"

JOSEPH
16,0 cm/6 1/4"

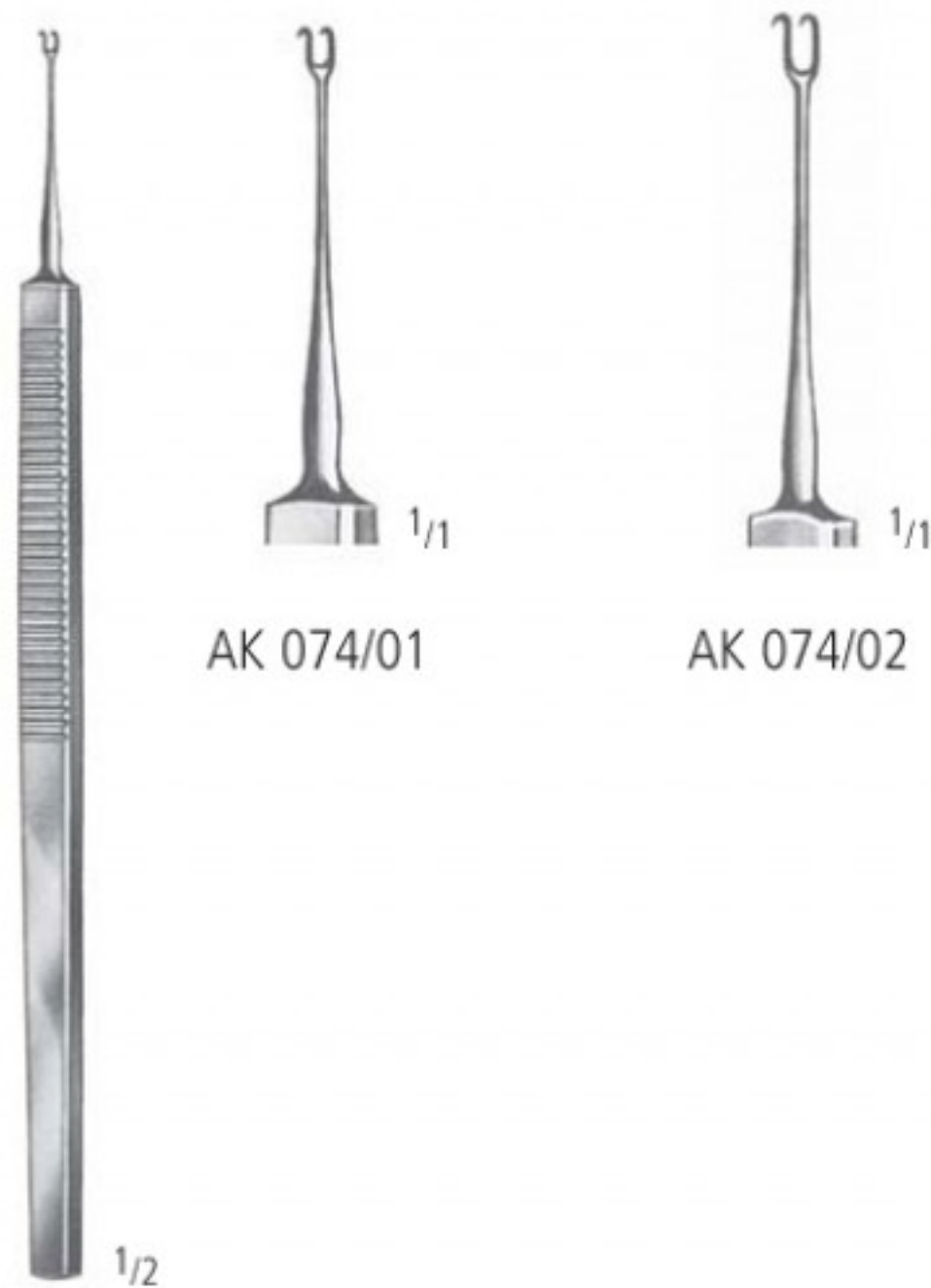

GUTHRIE
16,0 cm/6 1/4"



ROLLET
AK 076/13
13,0 cm/5"

KNAPP
13,0 cm/5"

AA
AB
AC
AD
AE
AF
AK
AL
AO
AR
KA
KL
KU
PA
PB
PF
PI
PK
PL
PM
PP
PS
PT
PU
PV
KYE

AK WUNDHAKEN RETRACTORS SEPARADORES ECARTEURS DIVARICATORI

Feine Wundhaken
Delicate Hooks
Ganchos
Crochets très fins
Divaricatori sottili



MEYERDING
18,0 cm/7"

SENN-GREEN
15,0 cm/6"



MINI-LANGENBECK
16,0 cm/6¹/₄"

WUNDHAKEN RETRACTORS SEPARADORES ECARTEURS DIVARICATORI

Feine Wundhaken
Delicate Hooks
Ganchos
Crochets très fins
Divaricatori sottili



DESMARRES
13,0 cm/5"

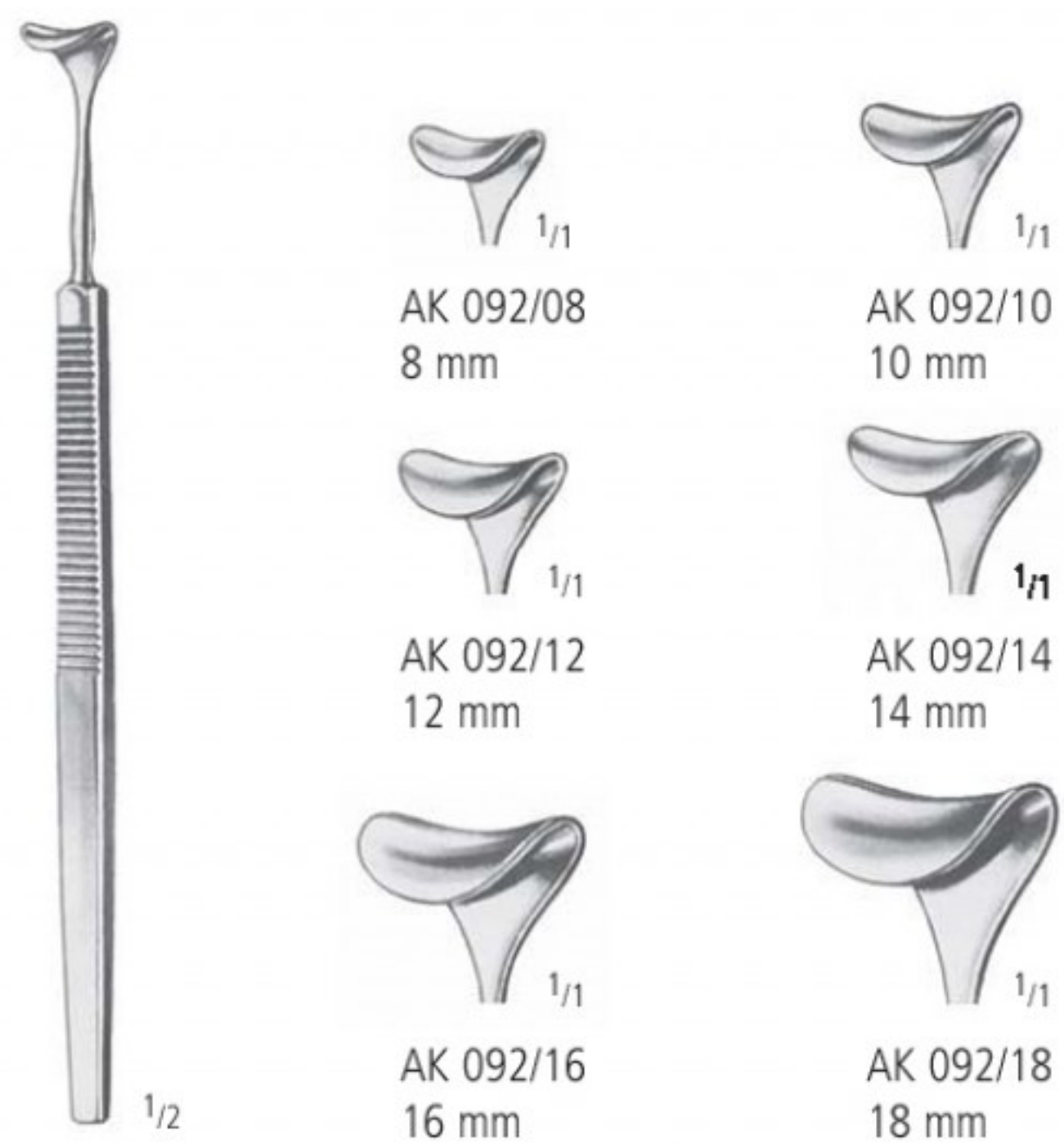

DESMARRES
16,0 cm/6¹/₄"

AA
AB
AC
AD
AE
AF
AK
AL
AO
AR
KA
KL
KU
PA
PB
PF
PI
PK
PL
PM
PP
PS
PT
PU
PV
KYE

Weichteilhaken
 Soft tissue retractors
 Separadores para partes blandas
 Ecarteurs pour parties molles
 Divaricatori per tessuti molli



OBWEGESER
 24,0 cm/9 1/2"



AK 222/01
 10 x 35 mm



AK 222/02
 10 x 42 mm



AK 222/03
 12 x 55 mm



AK 222/04
 14 x 70 mm



AK 222/05
 16 x 80 mm

WUNDHAKEN RETRACTORS SEPARADORES ECARTEURS DIVARICATORI

Weichteilhaken
Soft tissue retractors
Separadores para partes blandas
Ecarteurs pour parties molles
Divaricatori per tessuti molli



OBWEGESER
24,0 cm/9 1/2"

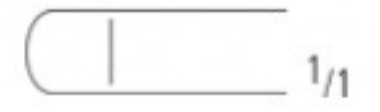

AK 223/01
5 x 16 mm



AK 223/02
7 x 25 mm



AK 223/03
10 x 35 mm



AK 223/04
10 x 42 mm



AK 223/05
12 x 55 mm



AK 223/06
14 x 70 mm



AK 223/07
16 x 80 mm

AA
AB
AC
AD
AE
AF
AK
AL
AO
AR
KA
KL
KU
PA
PB
PF
PI
PK
PL
PM
PP
PS
PT
PU
PV
KYE

Ramushaken
 Ramus retractors
 Separadores para el ramo
 Ecarteurs pour ramus
 Separatore per ramo

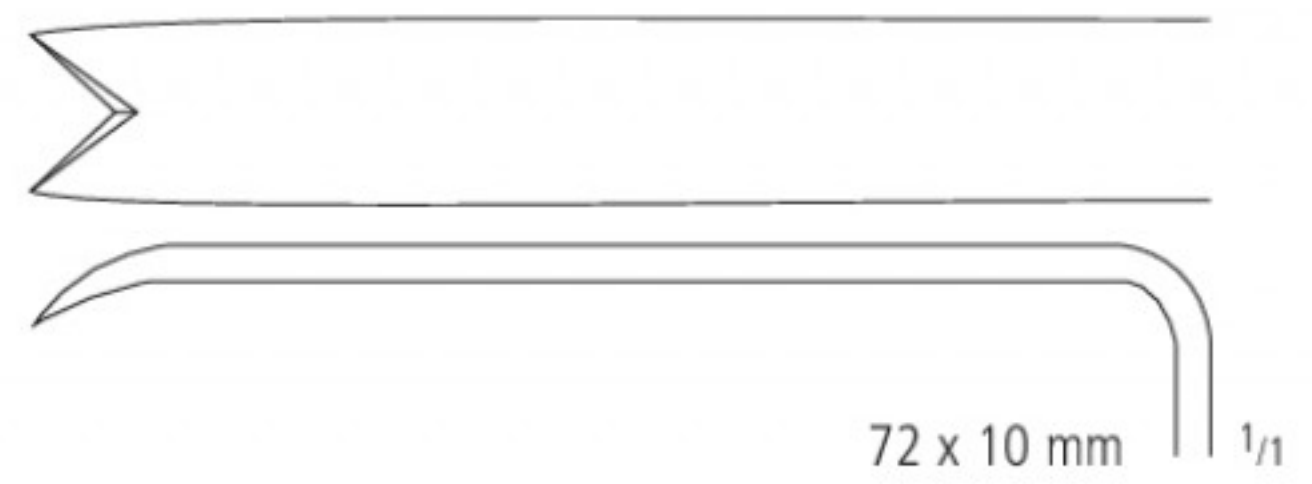
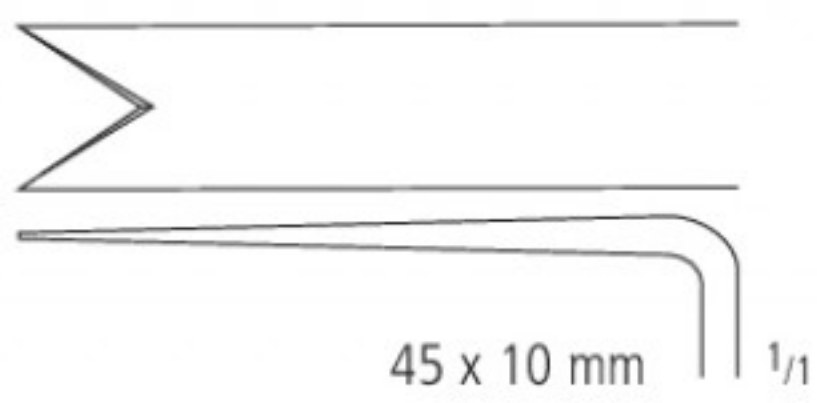

OBWEGESER
 AK 225/01
 22,0 cm/8³/₄"



OBWEGESER
 AK 225/02
 24,0 cm/9¹/₂"



LANGENBECK
AK 230/01-05
22,0 cm/8³/₄"



AK 230/01
AK 231/01
30 x 11 mm



AK 230/02
AK 231/02
30 x 14 mm



AK 230/03
AK 231/03
30 x 16 mm



AK 230/04
AK 231/04
40 x 11 mm



AK 230/05
AK 231/05
50 x 11 mm



LANGENBECK
AK 231/01-05
22,0 cm/8³/₄"



1/2

KOCHER-LANGENBECK
21,5 cm/8 1/2"



1/1

AK 233/01
25 x 6 mm



1/1

AK 233/02
35 x 8 mm



1/1

AK 233/03
35 x 11 mm



1/1

AK 233/04
35 x 15 mm



1/1

AK 233/05
40 x 11 mm



1/1

AK 233/06
55 x 11 mm



1/1

AK 233/07
70 x 14 mm



1/1

AK 233/08
80 x 12 mm



1/1

AK 233/09
80 x 16 mm

WUNDHAKEN RETRACTORS SEPARADORES ECARTEURS DIVARICATORI



14 X 17 mm

AK 244/17
AK 245/17
21,5 cm/8¹/₂"

20 X 22 mm

AK 244/22
AK 245/22
22,0 cm/8³/₄"



26 X 30 mm

AK 244/30
AK 245/30
23,5 cm/9¹/₃"

MIDDELDORPF
AK 244/17-30



MIDDELDORPF
AK 245/17-30

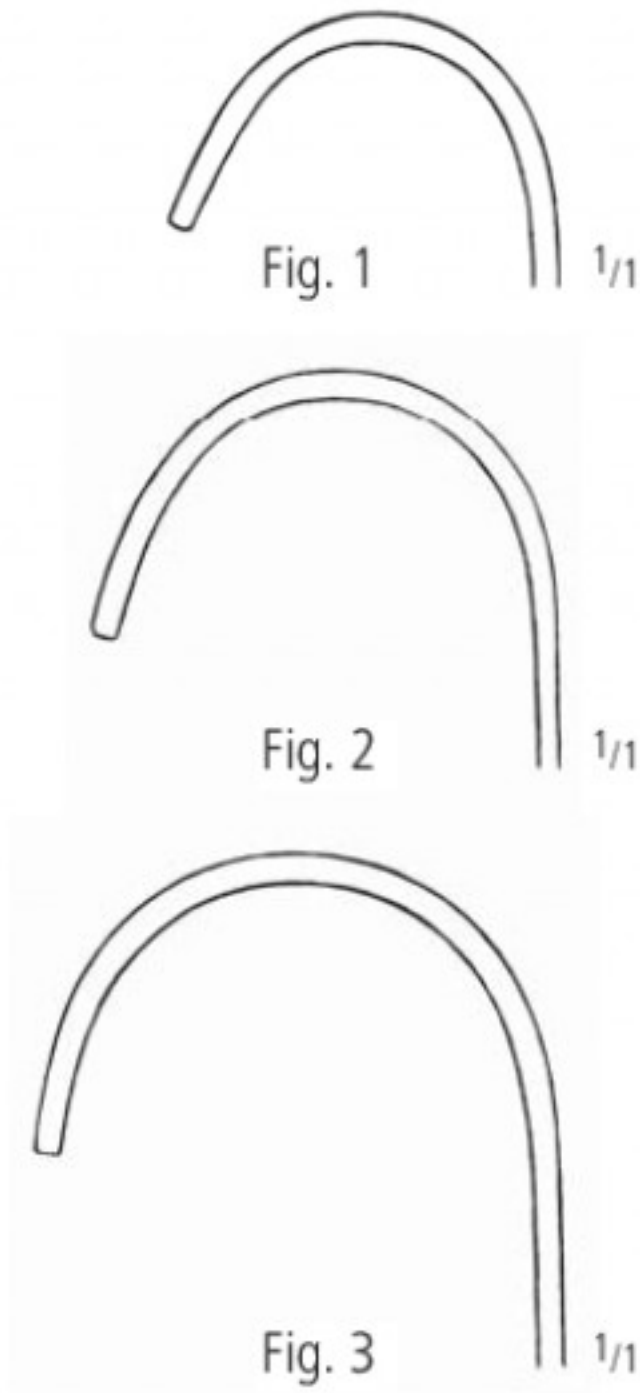

ROUX

16,5 cm/6¹/₂"

Fig. 1+2+3 AK 350/00
Fig. 1 AK 350/01
Fig. 2 AK 350/02
Fig. 3 AK 350/03



Fig. 1 AK 352/01
Fig. 2 AK 352/02

FARABEUF

AK 352/00 Fig. 1+2
12,0 cm/4³/₄"



Fig. 1 AK 354/01
Fig. 2 AK 354/02

FARABEUF

AK 354/00 Fig. 1+2
15,0 cm/6"



Fig. 1 AK 373/01
Fig. 2 AK 373/02

PARKER

AK 373/00 Fig. 1+2
13,5 cm/5¹/₄"

AA
AB
AC
AD
AE
AF
AK
AL
AO
AR
KA
KL
KU
PA
PB
PF
PI
PK
PL
PM
PP
PS
PT
PU
PV
KYE

SONDEN, TROKARE, SAUGROHRE
PROBES, TROCARS, SUCTION TUBES
SONDAS, TROCARES,
TUBOS DE ASPIRACION
SONDES, TROCARTS,
CANULES D'ASPIRATION
SONDE, TREQUARTI,
CANNULE PER ASPIRAZIONE

AL + AO

nopa[®] instruments



Sonden
Probes
Sondas
Sondes
Sonde

AA
AB
AC
AD
AE
AF
AK
AL
AO
AR
KA
KL
KU
PA
PB
PF
PI
PK
PL
PM
PP
PS
PT
PU
PV
KYE

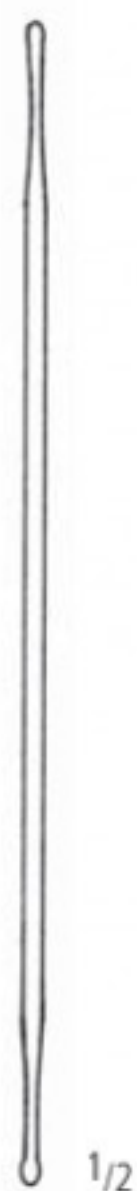

Silber
silver
de plata
en argent
d'argento

	1,0 mm	2,0 mm
11,5 cm/4 1/2"	AL 001/11	AL 002/11
13,0 cm/5"	AL 001/13	AL 002/13
14,5 cm/5 3/4"	AL 001/14	AL 002/14
16,0 cm/6 1/4"	AL 001/16	AL 002/16
18,0 cm/7"	AL 001/18	AL 002/18
20,0 cm/8"	AL 001/20	AL 002/20
25,0 cm/10"	AL 001/25	AL 002/25

AL 003/11
AL 003/13
AL 003/14
AL 003/16
AL 003/18
AL 003/20
AL 003/25

MYRTLE LEAF

AL 007/14
AL 007/16
AL 007/18
AL 007/20

STACKE
AL 013/10
10,5 cm/4 1/4"
Ø 1,0 mm

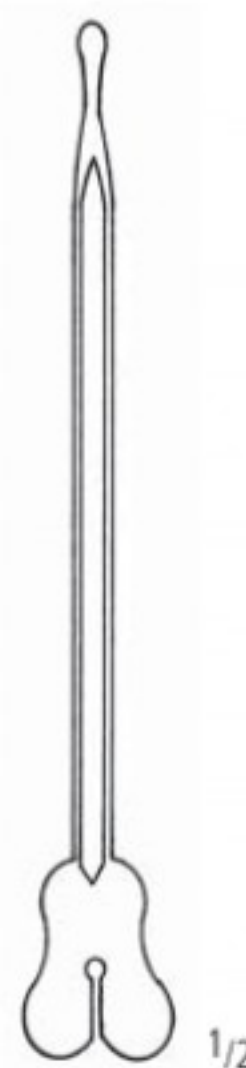
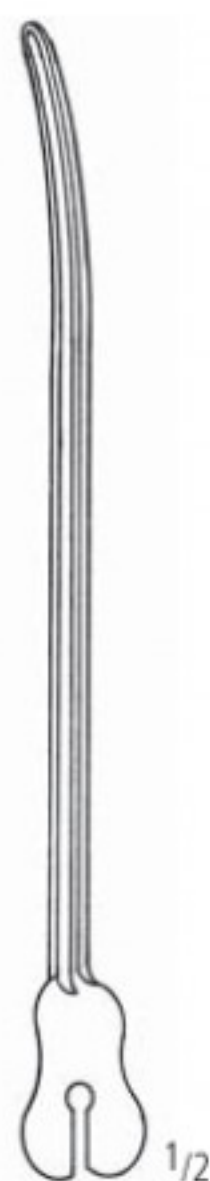

11,5 cm/4 1/2"	AL 015/11
13,0 cm/5"	AL 015/13
14,5 cm/5 3/4"	AL 015/14
16,0 cm/6 1/4"	AL 015/16
18,0 cm/7"	AL 015/18
20,0 cm/8"	AL 015/20

DOYEN

AL 017/14

AL 020/11
AL 020/13
AL 020/14
AL 020/16
AL 020/18

NELATON

AL 022/16

Sonden und Watteträger
 Probes and Cotton Applicators
 Sondas y Porta-algodones
 Sondes et Porte-coton
 Sonde e Portacotone

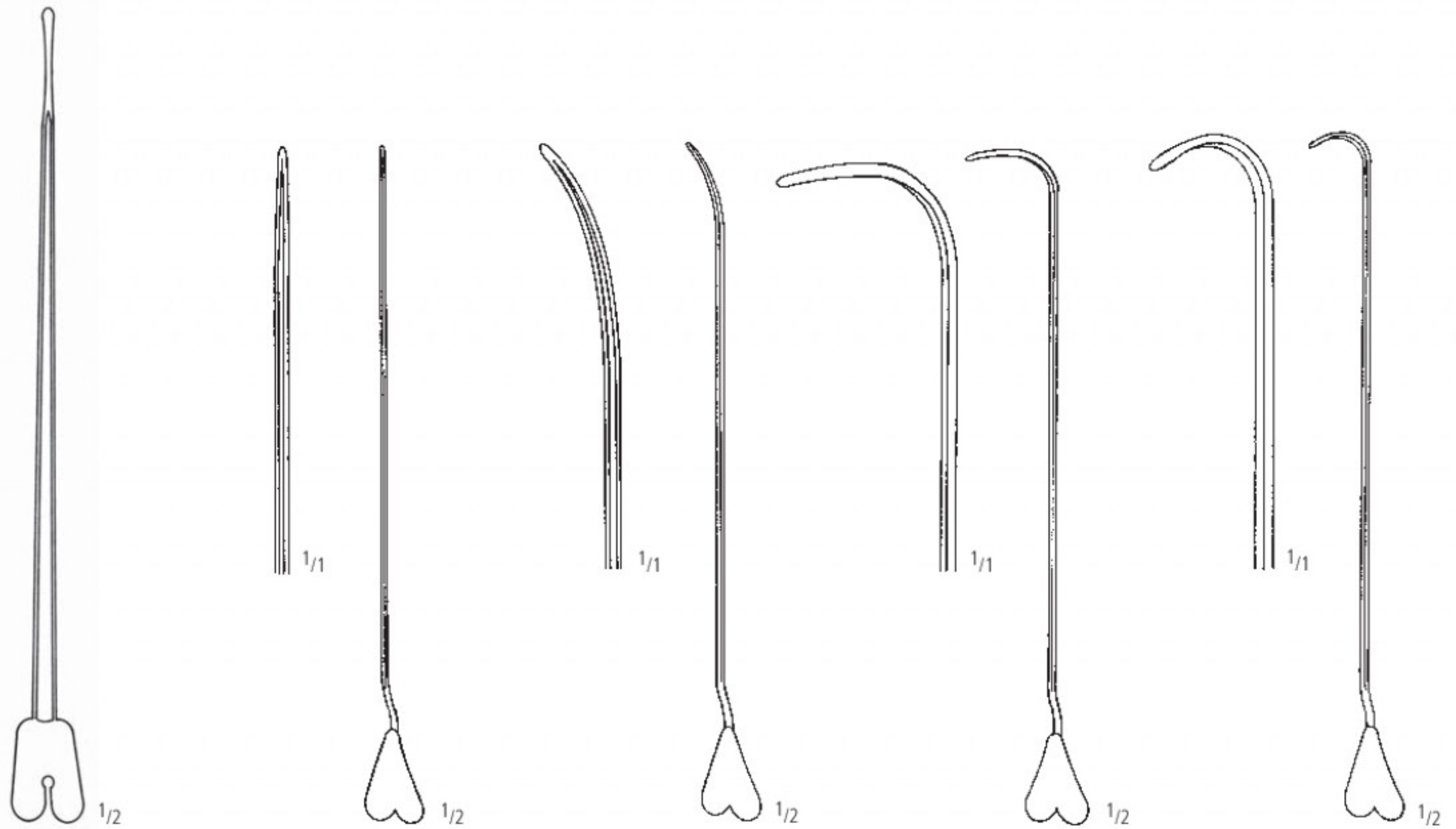

BRODIE

AL 026/20
 20,0 cm/8"

LOCKHART-MUMMERY

Fig. 1
 AL 030/01

Fig. 2
 AL 030/02

LOCKHART-MUMMERY

Fig. 3
 AL 030/03

Fig. 4
 AL 030/04

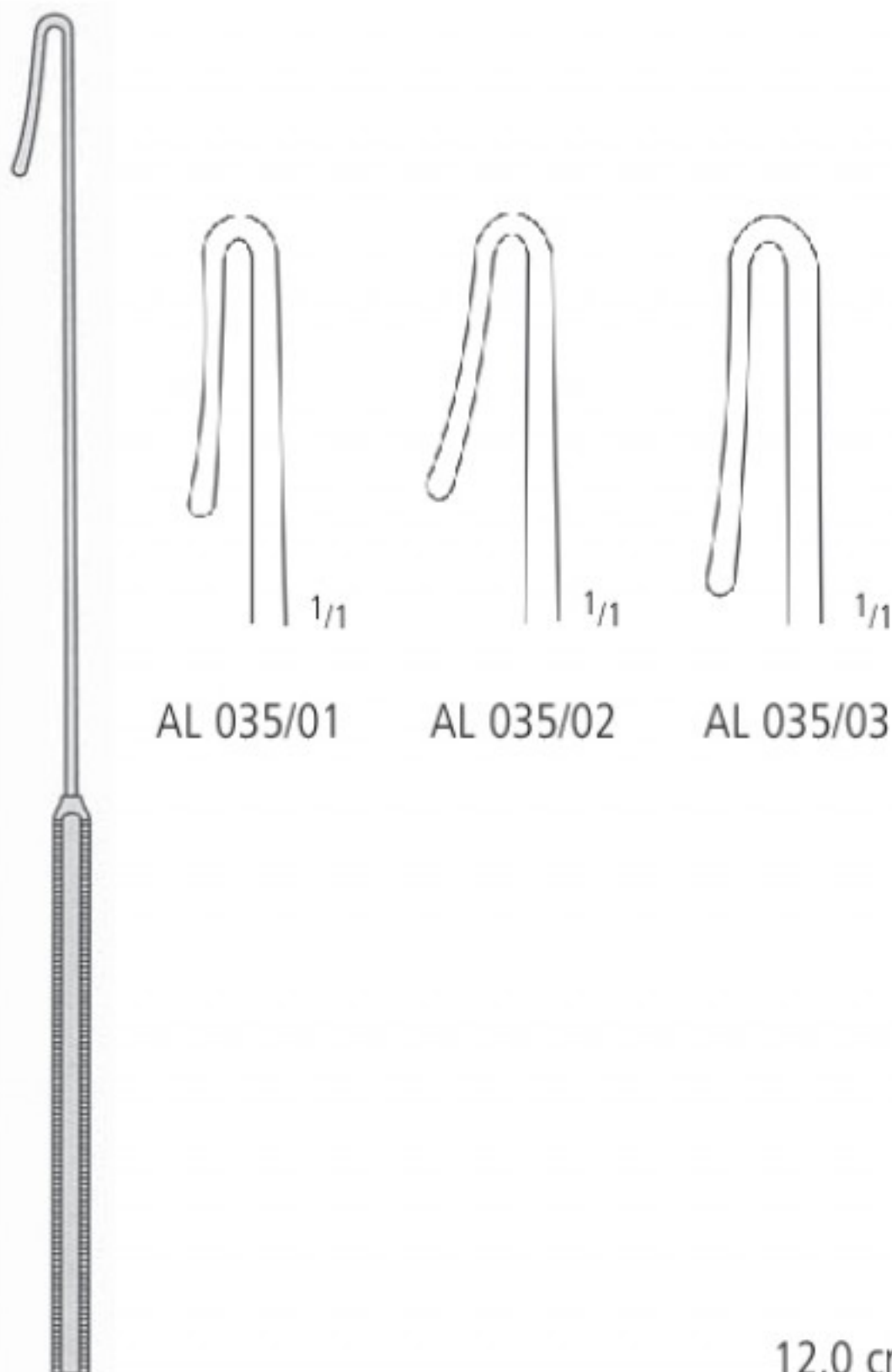

PRATT

21,0 cm/8¹/₄"

AL 035/01

AL 035/02

AL 035/03

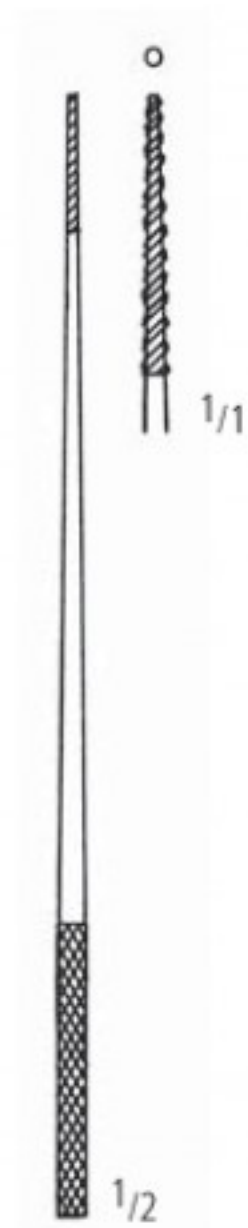

FARRELL

0,9 mm AL 100/12
 1,1 mm AL 100/14
 1,2 mm AL 100/16
 AL 100/18



FARRELL

0,9 mm AL 120/12
 1,1 mm AL 120/14
 1,2 mm AL 120/16
 AL 120/18

Trokare
Trocars
Trocares
Trocarts
Trequarti

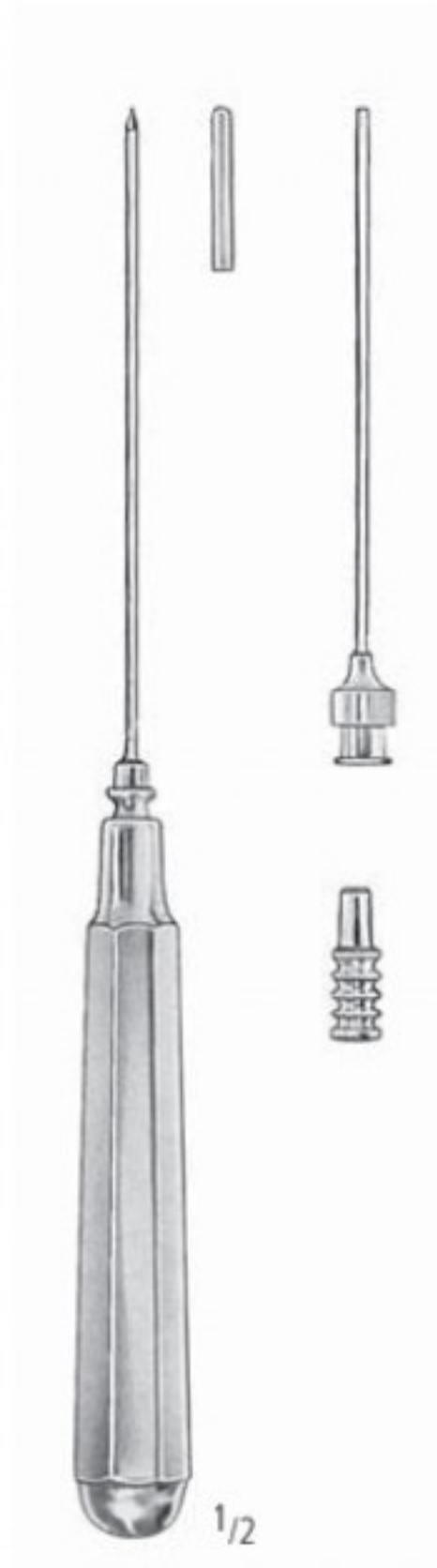

LICHTWITZ
AO 180/00
1,8 mm



LICHTWITZ
AO 182/00
1,6 mm



DOUGLAS
AO 185/00
3,0 mm



PIERCE
AO 190/30
AO 190/40
AO 190/50

Ø 3,0 mm
Ø 4,0 mm
Ø 5,0 mm
Ø 5,5 mm

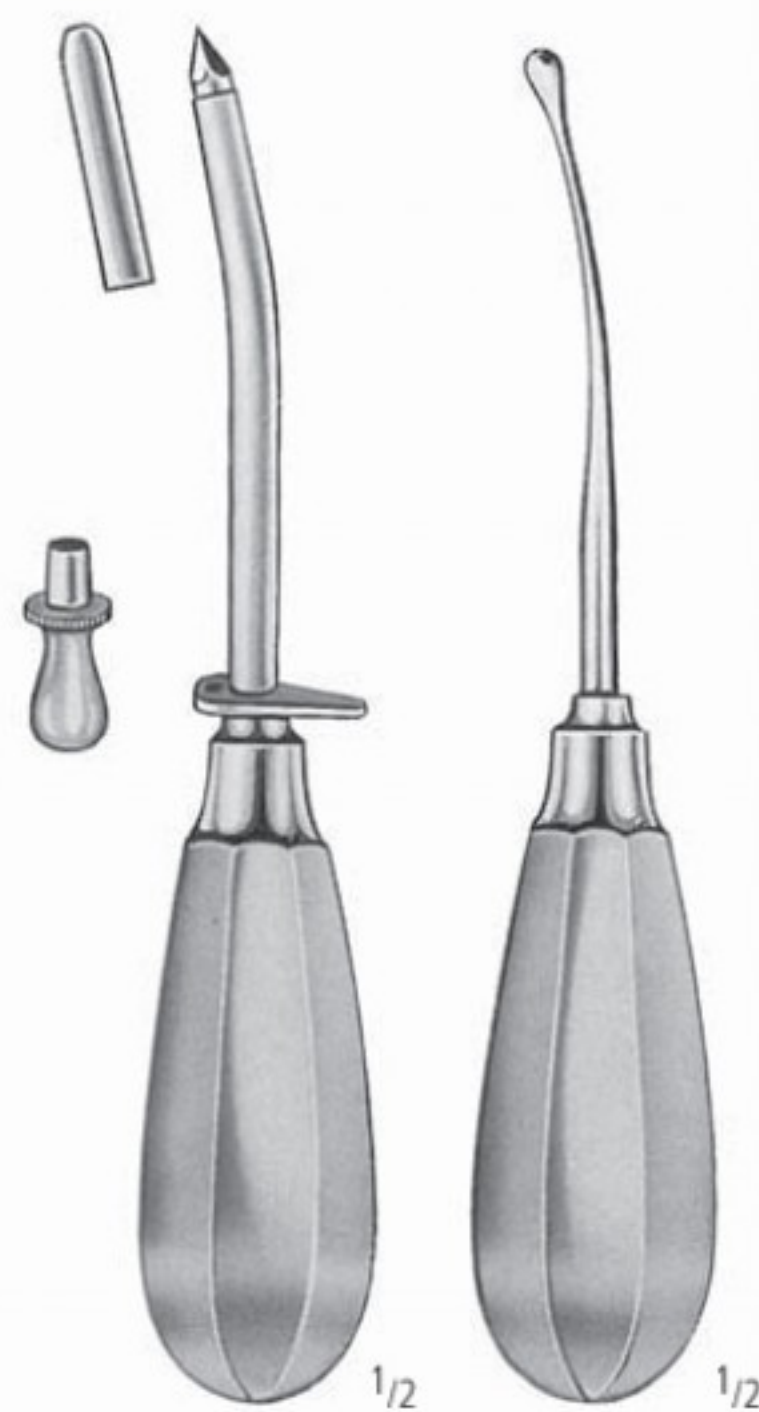

KRAUSE
AO 194/30
AO 194/40
AO 194/50
AO 194/55

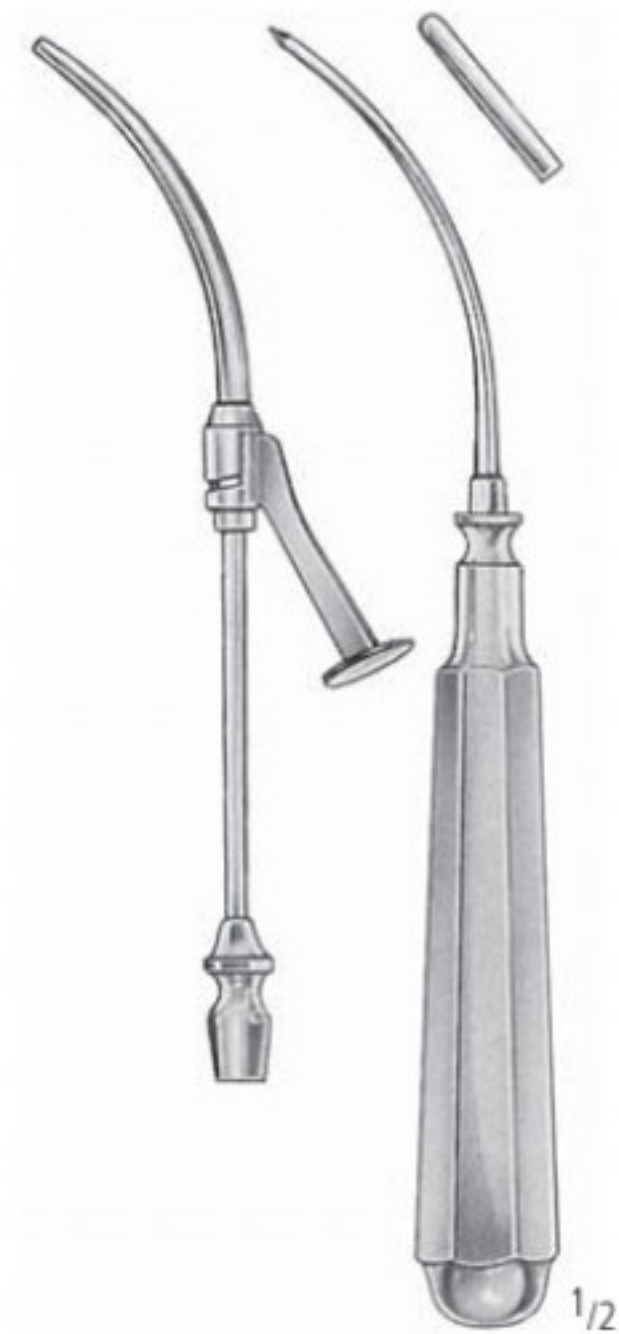

COAKLEY
AO 200/16
2,25 mm

AA
AB
AC
AD
AE
AF
AG
AH
AI
AJ
AK
AL
AO
AR
KA
KL
KU
PA
PB
PF
PI
PK
PL
PM
PP
PS
PT
PU
PV
KYE

Saugrohre
Suction Tubes
Tubos de aspiración
Canules d'aspiration
Cannule per aspirazione



COUPLAND
AO 410/00



BYRD
1,5 mm AO 412/15
2,5 mm AO 412/25
3,5 mm AO 412/35



FRAZIER
6 Charr. AO 430/06
8 Charr. AO 430/08
10 Charr. AO 430/10
12 Charr. AO 430/12

Saugrohre
Suction Tubes
Tubos de aspiración
Canules d'aspiration
Cannule per aspirazione

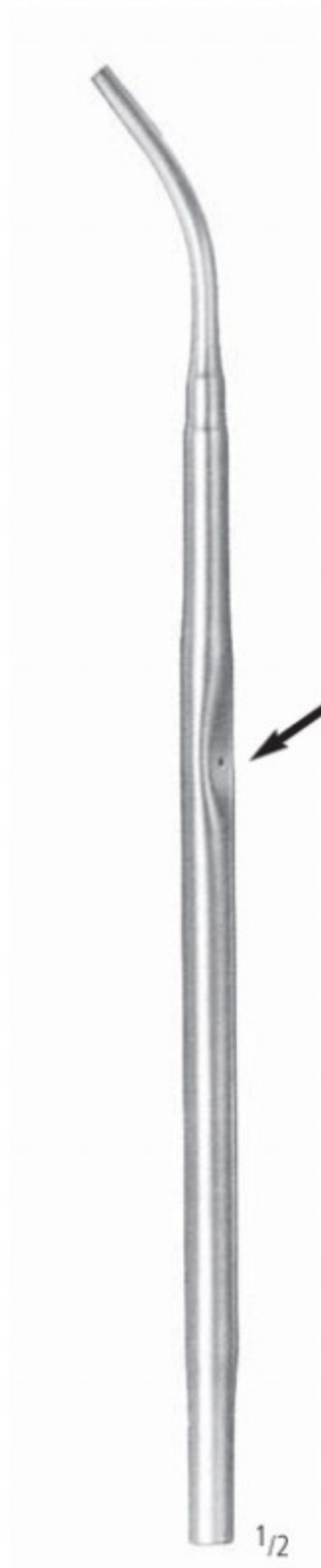

COGSWELL
AO 460/20
24,5 cm/9³/₄"
2,0 mm Ø



LUER
L = 110 mm



AO 461/30
Ø 3,0 mm



AO 461/35
Ø 3,5 mm

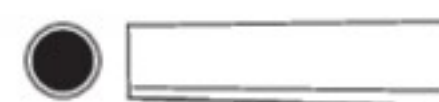

AO 461/45
Ø 4,5 mm

AA
AB
AC
AD
AE
AF
AK
AL
AO
AR
KA
KL
KU
PA
PB
PF
PI
PK
PL
PM
PP
PS
PT
PU
PV
KYE

Saugrohre
Suction Tubes
Tubos de aspiración
Canules d'aspiration
Cannule per aspirazione



Länge/length
14,0 cm
18,0 cm

A=Ø 3,0 mm
AO 463/03
AO 464/03

A=Ø 4,0 mm
AO 463/04
AO 464/04

A=Ø 6,0 mm
AO 463/06
AO 464/06



COUPLAND
AO 465/01
16,5 cm/6¹/₂"

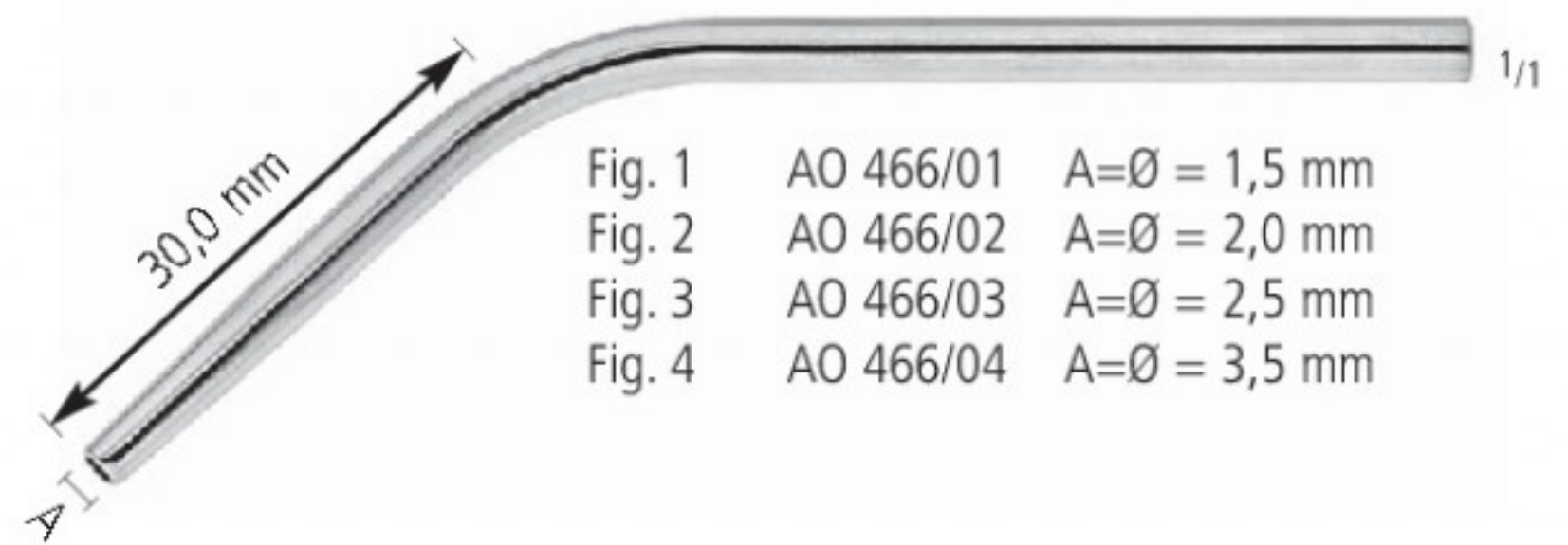

Fig. 1 AO 466/01 A=Ø = 1,5 mm
Fig. 2 AO 466/02 A=Ø = 2,0 mm
Fig. 3 AO 466/03 A=Ø = 2,5 mm
Fig. 4 AO 466/04 A=Ø = 3,5 mm

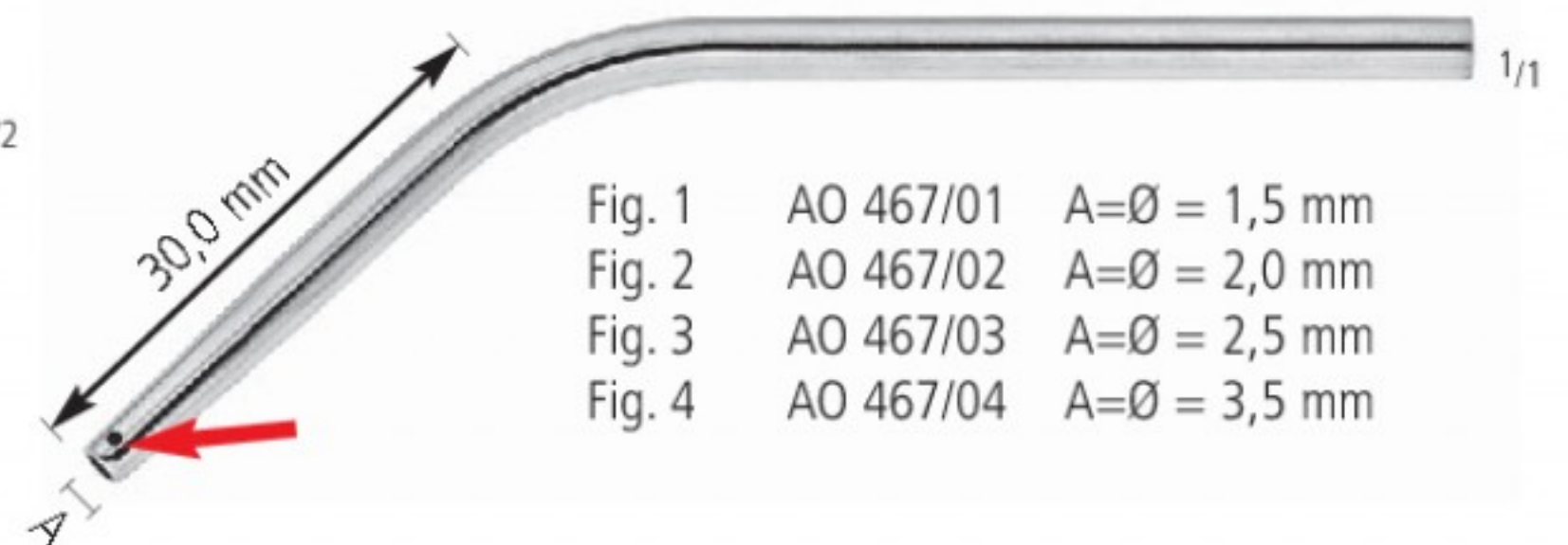

Fig. 1 AO 467/01 A=Ø = 1,5 mm
Fig. 2 AO 467/02 A=Ø = 2,0 mm
Fig. 3 AO 467/03 A=Ø = 2,5 mm
Fig. 4 AO 467/04 A=Ø = 3,5 mm

Ampullenspritzen
 Cartridge Syringes
 Jeringas para cartucho ampollas
 Seringues à ampoule
 Siringhe fiali



mit Aspiration
 with aspiration
 con aspiración
 avec aspiration
 con aspirazione

AO 861/18
 1,8 ml



ohne Aspiration
 without aspiration
 sin aspiración
 sans aspiration
 senza aspirazione

AO 862/18
 1,8 ml



mit Aspiration
 with aspiration
 con aspiración
 avec aspiration
 con aspirazione

AO 865/18
 1,8 ml

stainless



AO 866/18
 1,8 ml

AA
 AB
 AC
 AD
 AE
 AF
 AK
 AL
 AO
 AR
 KA
 KL
 KU
 PA
 PB
 PF
 PI
 PK
 PL
 PM
 PP
 PS
 PT
 PU
 PV
 KYE

MESSINSTRUMENTE
MEASURING INSTRUMENTS
INSTRUMENTOS PARA MEDIDAS
INSTRUMENTS POUR MESURER
STRUMENTI PER MISURARE

AR

nopa[®] instruments





15,0 cm/6" AR 250/15
20,0 cm/8" AR 250/20



AR 251/01
0-80 mm

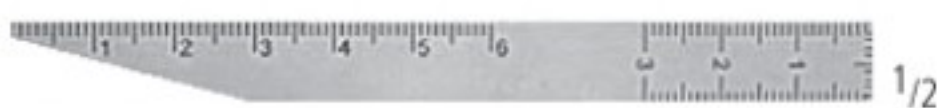

AR 251/02
0-60 mm

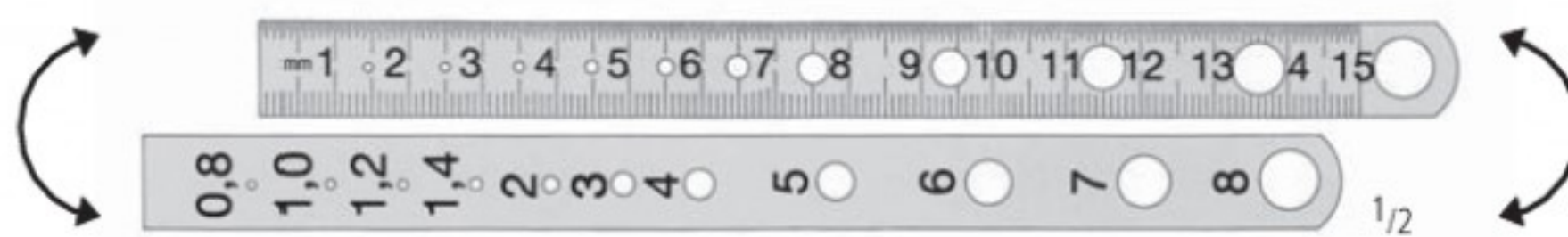

AR 255/15
150 mm

Messbereich und Lochlehre
measuring range and hole gauge
alcance de medición y calibre de agujeros
pour mesurer et calibre avec trous
per misurare fino e calibro forato



VERNIER
AR 260/12
0 - 120 mm



AR 260/18
0 - 200 mm / 0 - 8 inch



JAMESON
AR 261/08
0-80 mm / 0-3 inch



TOWNLEY
AR 262/12
0-80 mm



AR 263/11
0-100 mm



AR 263/12
0-80 mm



AR 263/13
0-80 mm



VERNIER
AR 265/20
0-200 mm



BOLEY
AR 264/11
0-100 mm



BOLEY
AR 264/12
0-100 mm

AA AB AC AD AE AF AG AH AI AJ AK AL AM AN AO **AR** AS AT AU AV AW AX AY AZ BA BB BC BD BE BF BG BH BI BJ BK BL BM BN BO BP BQ BR BS BT BU BV BW BX BY BZ CA CB CC CD CE CF CG CH CI CJ CK CL CM CN CO CP CQ CR CS CT CU CV CW CX CY CZ DA DB DC DE DF DG DH DI DJ DK DL DM DN DO DP DQ DR DS DT DU DV DW DX DY DZ EA EB EC ED EE EF EG EH EI EJ EK EL EM EN EO EP EQ ER ES ET EU EV EW EX EY EZ FA FB FC FD FE FF FG FH FI FJ FK FL FM FN FO FP FQ FR FS FT FU FV FW FX FY FZ GA GB GC GD GE GF GG GH GI GJ GK GL GM GN GO GP GQ GR GS GT GU GV GW GX GY GZ HA HB HC HD HE HF HG HH HI HJ HK HL HM HN HO HP HQ HR HS HT HU HV HW HX HY HZ IA IB IC ID IE IF IG IH II IJ IK IL IM IN IO IP IQ IR IS IT IU IV IW IX IY IZ JA JB JC JD JE JF JG JH JI JJ JK JL JM JN JO JP JQ JR JS JT JU JV JW JX JY JZ KA KB KC KD KE KF KG KH KI KJ KL KM KN KO KP KQ KR KS KT KU KV KW KX KY KZ LA LB LC LD LE LF LG LH LI LJ LK LL LM LN LO LP LQ LR LS LT LU LV LW LX LY LZ MA MB MC MD ME MF MG MH MI MJ MK ML MN MO MP MQ MR MS MT MU MV MW MX MY MZ NA NB NC ND NE NF NG NH NI NJ NK NL NM NO NP NQ NR NS NT NU NV NW NX NY NZ OA OB OC OD OE OF OG OH OI OJ OK OL OM ON OO OP OQ OR OS OT OU OV OW OX OY OZ PA PB PC PD PE PF PG PH PI PJ PK PL PM PN PO PP PQ PR PS PT PU PV PW PX PY PZ QA QB QC QD QE QF QG QH QI QJ QK QL QM QN QO QP QQ QR QS QT QU QV QW QX QY QZ RA RB RC RD RE RF RG RH RI RJ RK RL RM RN RO RP RQ RR RS RT RU RV RW RX RY RZ SA SB SC SD SE SF SG SH SI SJ SK SL SM SN SO SP SQ SR SS ST SU SV SW SX SY SZ TA TB TC TD TE TF TG TH TI TJ TK TL TM TN TO TP TQ TR TS TT TU TV TW TX TY TZ UA UB UC UD UE UF UG UH UI UJ UK UL UM UN UO UP UQ UR US UT UU UV UW UX UY UZ VA VB VC VD VE VF VG VH VI VJ VK VL VM VN VO VP VQ VR VS VT VU VW VX VY VZ WA WB WC WD WE WF WG WH WI WJ WK WL WM WN WO WP WQ WR WS WT WU WV WW WX WY WZ XA XB XC XD XE XF XG XH XI XJ XK XL XM XN XO XP XQ XR XS XT XU XV XW XX XY XZ YA YB YC YD YE YF YG YH YI YJ YK YL YM YN YO YP YQ YR YS YT YU YV YW YX YY YZ ZA ZB ZC ZD ZE ZF ZG ZH ZI ZJ ZK ZL ZM ZN ZO ZP ZQ ZR ZS ZT ZU ZV ZW ZX ZY ZZ



IWANSON
AR 281/00
12,0 cm/4³/₄"

für Kronen
for crowns



IWANSON
AR 282/00
12,0 cm/4³/₄"

mit Tropfenspitzen für Wachs
with drop tips for wax



1/1

CASTROVIEJO
AR 282/15
8,0 cm/ 3"
0-15 mm



1/1

CASTROVIEJO
AR 282/20
8,0 cm/ 3"
0-20 mm



1/1

CASTROVIEJO
AR 283/20
8,0 cm/ 3"
0-20 mm



CASTROVIEJO-EPKER

AR 284/09
9,0 cm/ 3¹/₂"
0-40 mm



CASTROVIEJO-EPKER

AR 284/18
18,0 cm/ 7"
0-40 mm

KNOCHENINSTRUMENTE
BONE INSTRUMENTS
INSTRUMENTOS PARA HUESO
INSTRUMENTS A L'OS
STRUMENTI PER OSSO

KA

nopa[®] instruments



Meißel und Osteotome
 Chisels, Gouges and Osteotomes
 Cinceles y Gubias
 Ciseaux-Burins et Ostéotomes
 Scalpelli, Osteotomi, Sgorbie

AA
AB
AC
AD
AE
AF
AK
AL
AO
AR
KA
KL
KU
PA
PB
PF
PI
PK
PL
PM
PP
PS
PT
PU
PV
KYE

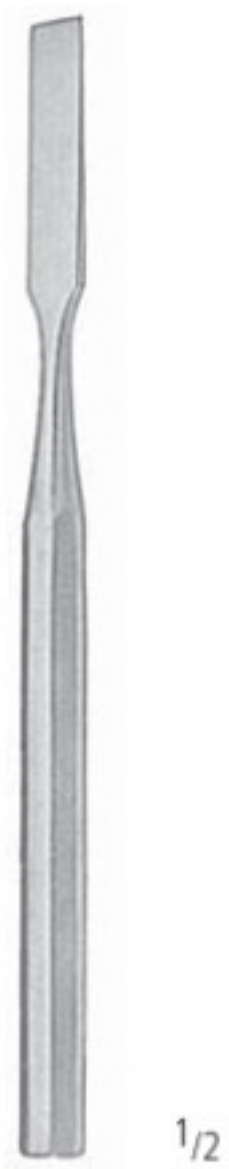

1/2

HOKE
 mm 14,0 cm/5 1/2"

3	KA 404/03
5	KA 404/05
6	KA 404/06
8	KA 404/08
9	KA 404/09



1/2

LUCAS
 mm 16,0 cm/6 1/4"

4	KA 406/04
6	KA 406/06



1/2

LUCAS
 mm 16,0 cm/6 1/4"

3	KA 407/03
5	KA 407/05

Meißel und Osteotome
 Chisels, Gouges and Osteotomes
 Cinceles y Gubias
 Ciseaux-Burins et Ostéotomes
 Scalpelli, Osteotomi, Sgorbie



ALEXANDER
 18,0 cm/7"

mm	
4	KA 418/04
6	KA 418/06
8	KA 418/08
10	KA 418/10
12	KA 418/12
14	KA 418/14



ALEXANDER
 18,0 cm/7"

mm	
4	KA 419/04
6	KA 419/06
8	KA 419/08
10	KA 419/10
12	KA 419/12
14	KA 419/14

Meißel und Osteotome
 Chisels, Gouges and Osteotomes
 Cinceles y Gubias
 Ciseaux-Burins et Ostéotomes
 Scalpelli, Osteotomi, Sgorbie



1/2



1/2

PARTSCH

13,5 cm/5 ¹ / ₄ "	17,0 cm/6 ³ / ₄ "	mm	13,5 cm/5 ¹ / ₄ "	17,0 cm/6 ³ / ₄ "
KA 433/02	KA 437/02	2	KA 443/02	KA 447/02
KA 433/03	KA 437/03	3	KA 443/03	KA 447/03
KA 433/04	KA 437/04	4	KA 443/04	KA 447/04
KA 433/05	KA 437/05	5	KA 443/05	KA 447/05
KA 433/06	KA 437/06	6	KA 443/06	KA 447/06
KA 433/07	KA 437/07	7	KA 443/07	KA 447/07
KA 433/08	KA 437/08	8	KA 443/08	KA 447/08

AA
AB
AC
AD
AE
AF
AK
AL
AO
AR
KA
KL
KU
PA
PB
PF
PI
PK
PL
PM
PP
PS
PT
PU
PV
KYE

Meißel und Osteotome
 Chisels, Gouges and Osteotomes
 Cinceles y Gubias
 Ciseaux-Burins et Ostéotomes
 Scalpelli, Osteotomi, Sgorbie



MINI-LEXER
 18,0 cm/7"

MINI-LEXER
 18,0 cm/7"

mm	
4	KA 470/04
6	KA 470/06
8	KA 470/08
10	KA 470/10
12	KA 470/12
15	KA 470/15
20	KA 470/20

	KA 471/04
	KA 471/06
	KA 471/08
	KA 471/10
	KA 471/12
	KA 471/15
	KA 471/20

Ferrozellgriff
 Hartpress-Handle
 Mango en "Ferrozell"
 Manche en "Ferrozell"
 Manico in "Ferrozell"

Hämmer
Mallets
Martillos
Marteaux
Martelli



Ø 30 mm
220 g
(7³/₄ oz.)

1/2

COLLIN
KA 532/22
20,0 cm/8"



Ø 27 mm
140 g
(5 oz.)

1/2

HAJEK
KA 533/14
22,0 cm/8³/₄"

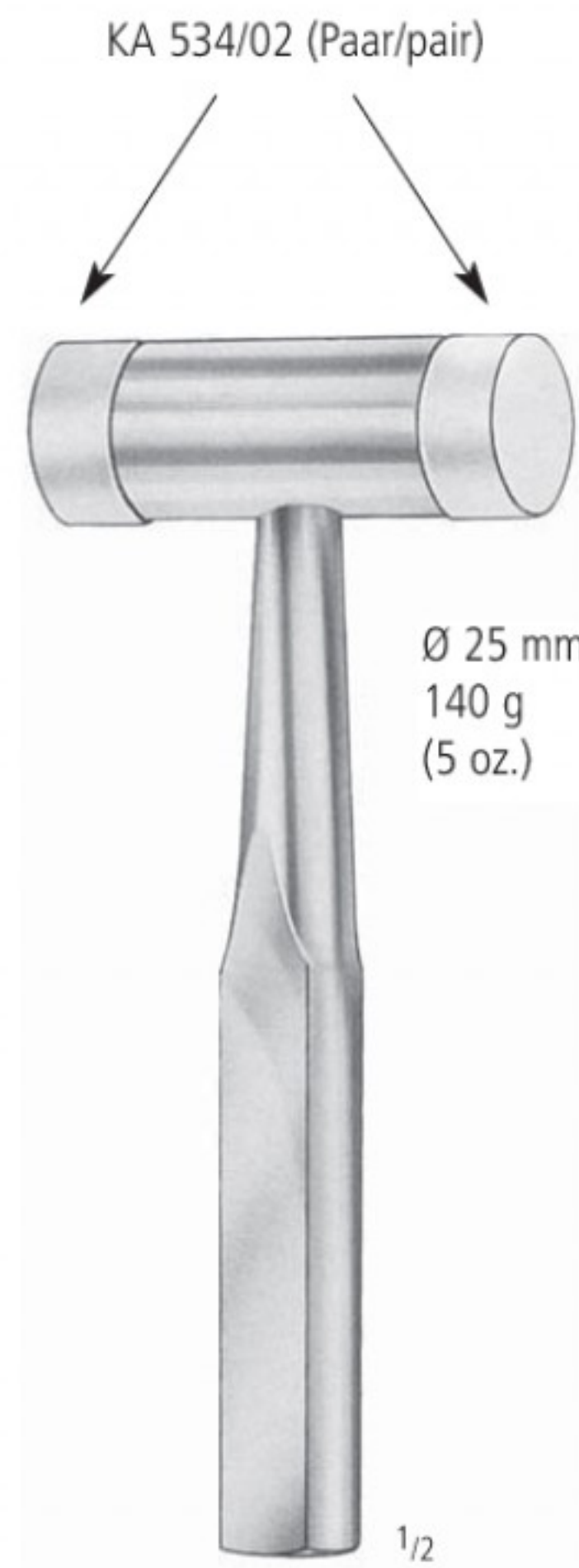

KA 534/02 (Paar/pair)

Ø 25 mm
140 g
(5 oz.)

1/2

KA 534/14
18,0 cm/7"

AA
AB
AC
AD
AE
AF
AK
AL
AO
AR
KA
KL
KU
PA
PB
PF
PI
PK
PL
PM
PP
PS
PT
PU
PV

Hämmer
Mallets
Martillos
Marteaux
Martelli

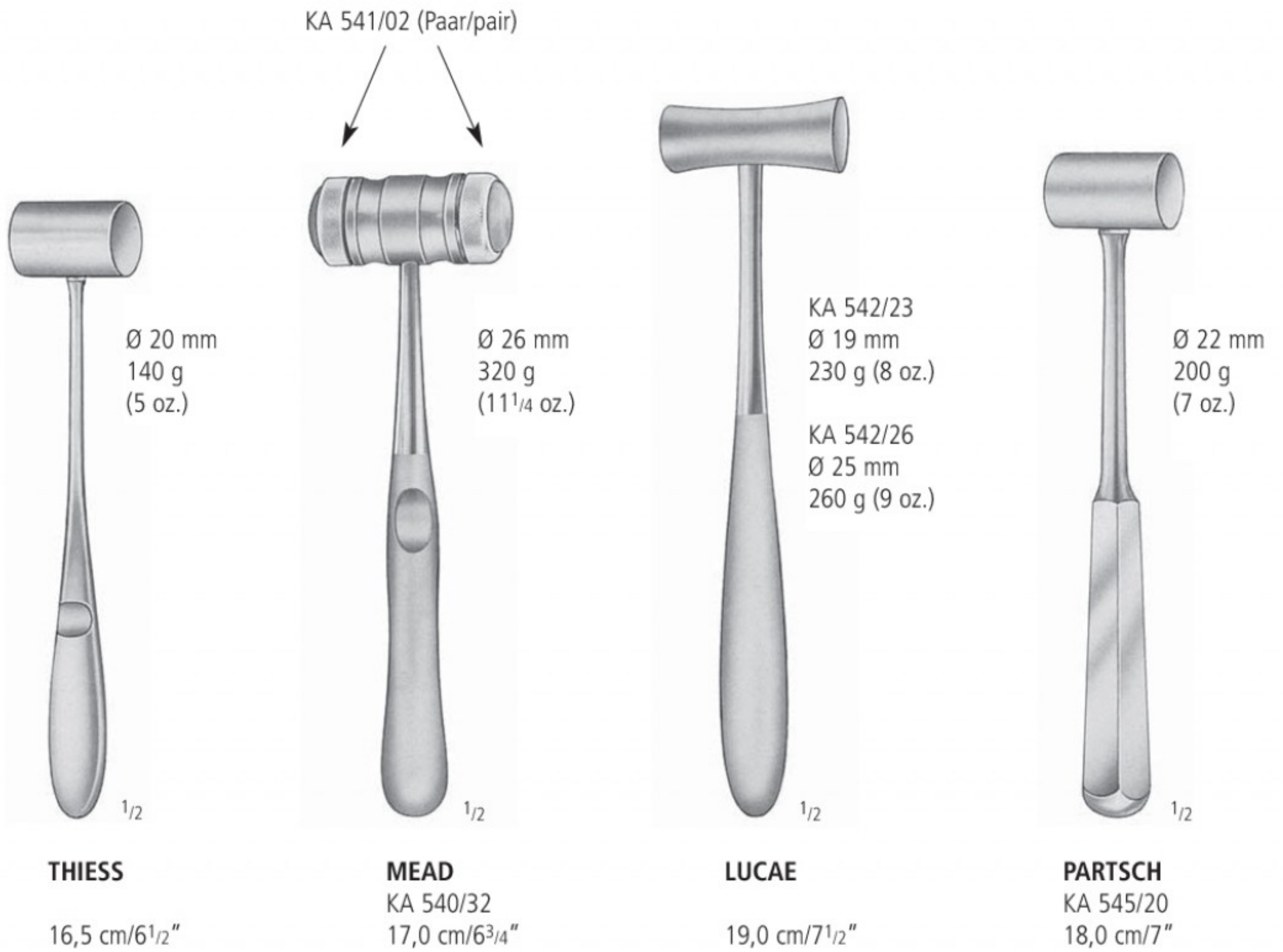

KA 535/16

KA 536/16

bleigefüllt
lead filled
relleno de plomo
garni de plomb
guarnito di piombo

Messing, massiv
brass, solid
latón, macizo
laiton, solide
ottone, solido

Scharfe Löffel
 Bone Currettes
 Cucharillas cortantes
 Curettes tranchantes
 Curette taglienti

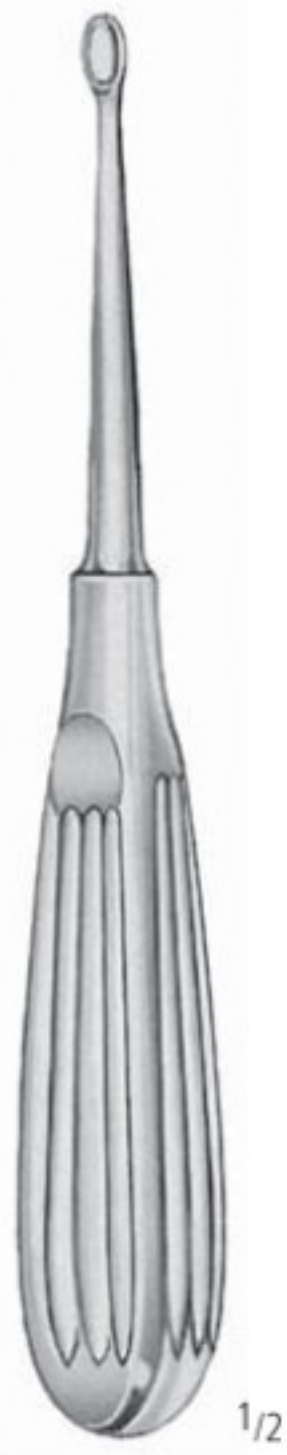

VOLKMANN
 17,0 cm/6³/₄"

- Fig. 0000
KA 600/00
- Fig. 000
KA 601/00
- Fig. 00
KA 602/00
- Fig. 0
KA 603/00
- Fig. 1
KA 603/01



BRUNS
 17,0 cm/6³/₄"

- Fig. 000
KA 610/00
- Fig. 00
KA 611/00
- Fig. 0
KA 612/00



SPRATT
 17,0 cm/6³/₄"

- Fig. 000
KA 615/00
- Fig. 00
KA 616/00
- Fig. 0
KA 617/00



SCHEDE
 17,0 cm/6³/₄"

- Fig. 000
KA 620/00
- Fig. 00
KA 621/00
- Fig. 0
KA 622/00

Scharfe Löffel
 Bone Currettes
 Cucharillas cortantes
 Currettes tranchantes
 Curette taglienti

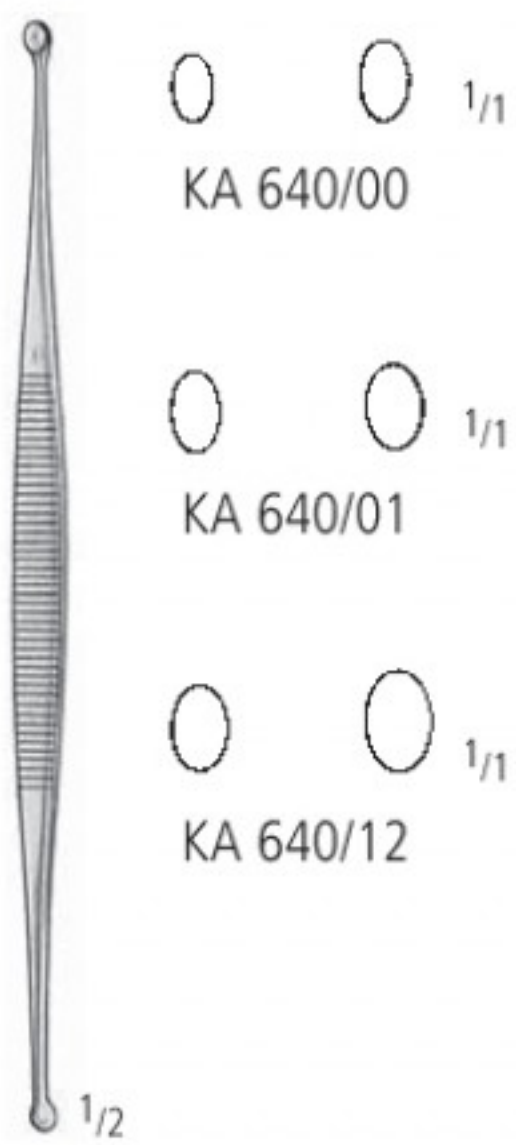

WILLIGER
 13,5 cm/5¹/₄"

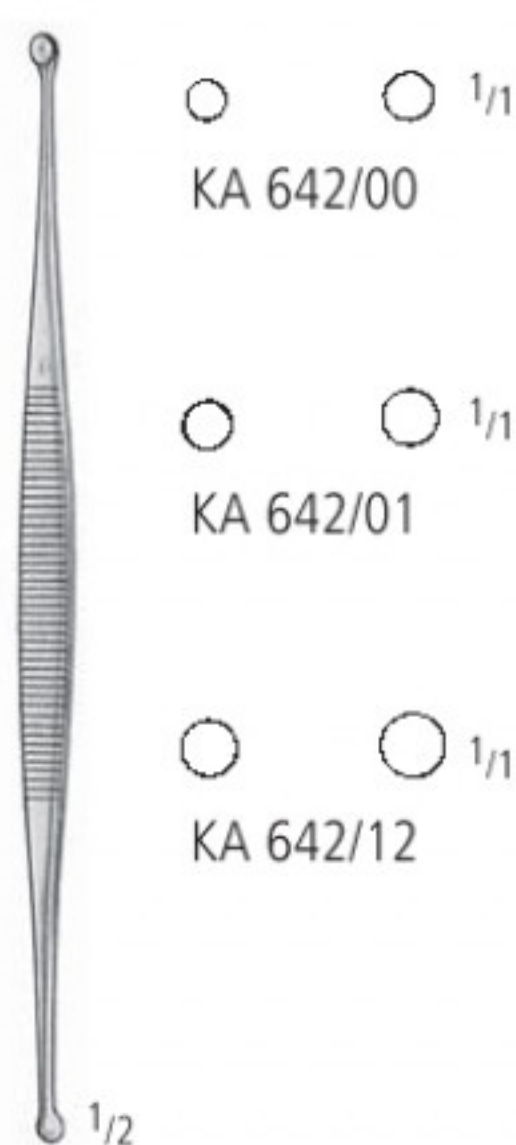

MARTINI
 13,5 cm/5¹/₄"



JANSEN
 KA 644/16
 16,0 cm/6¹/₄"



JANSEN
 KA 645/15
 15,0 cm/6"

Scharfe Löffel
 Bone Currettes
 Cucharillas cortantes
 Curettes tranchantes
 Curette taglienti



HEMINGWAY
 19,0 cm/7¹/₂"

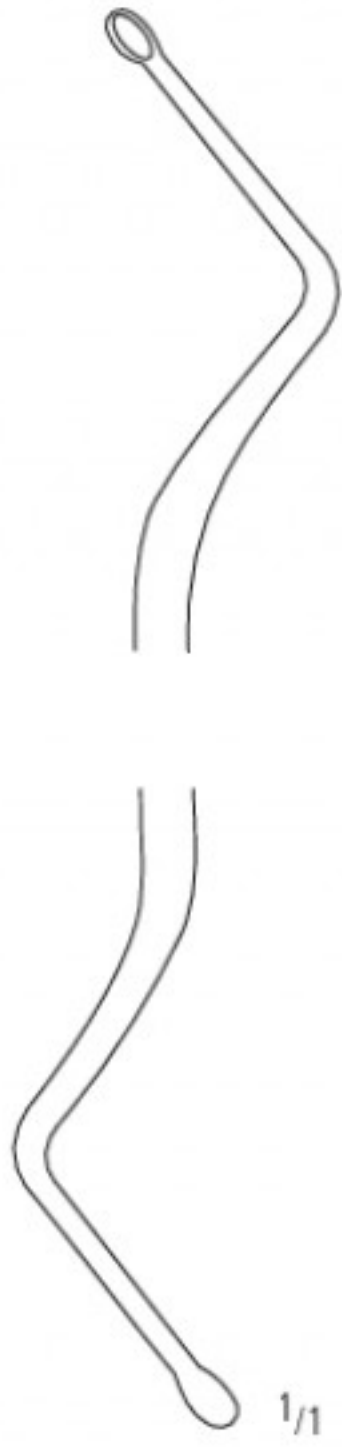

KA 654/11
 19,0 cm/7¹/₂"

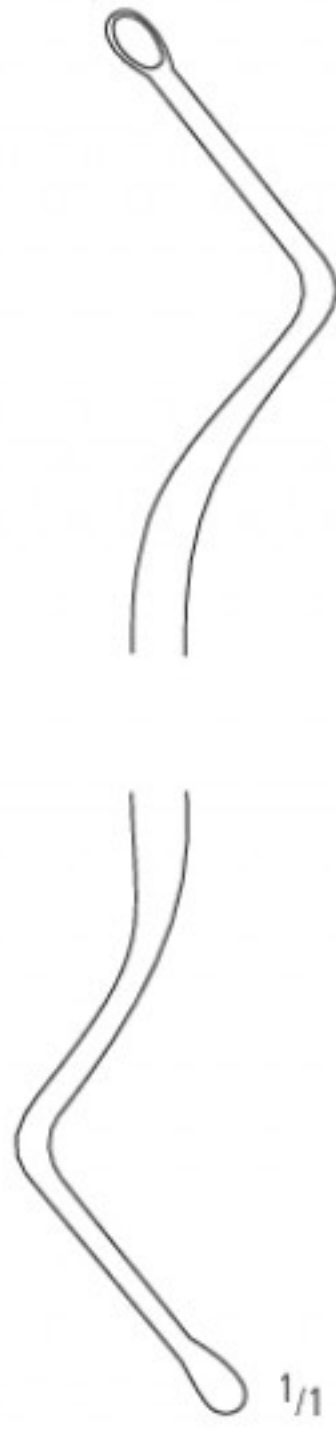

KA 654/22
 19,0 cm/7¹/₂"

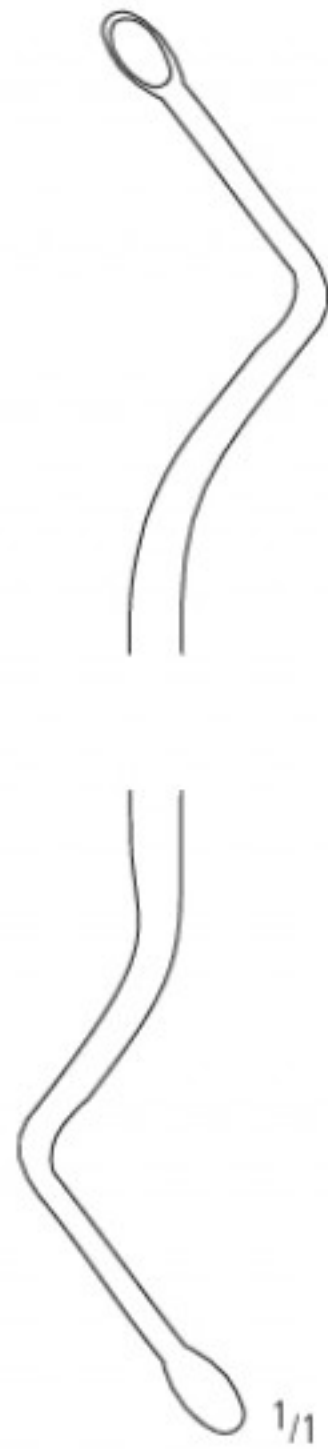

KA 654/33
 19,0 cm/7¹/₂"



LUCAS
 17,0 cm/6³/₄"

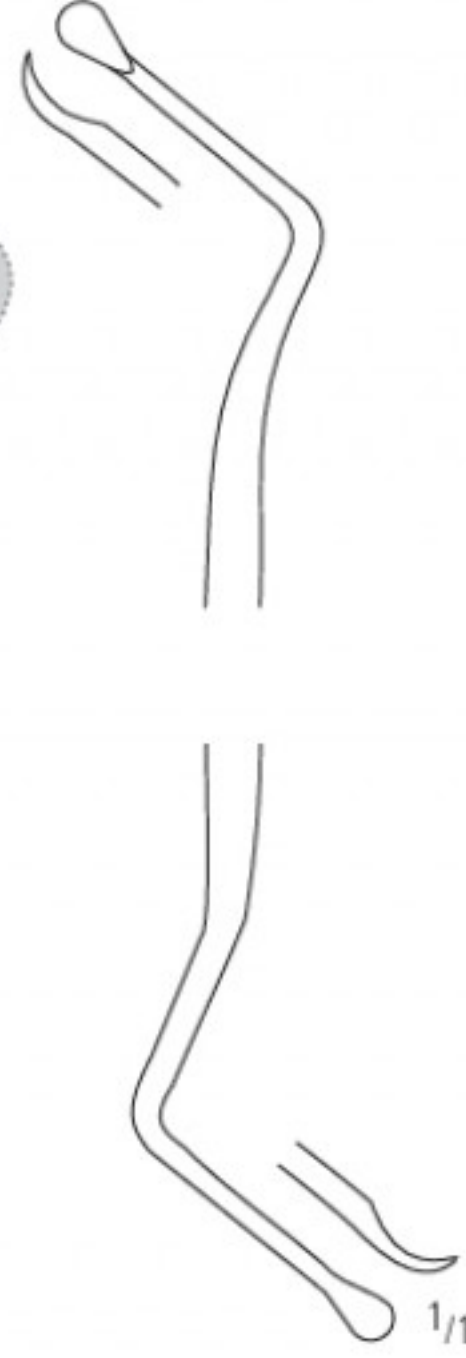

KA 654/85
 17,0 cm/6³/₄"

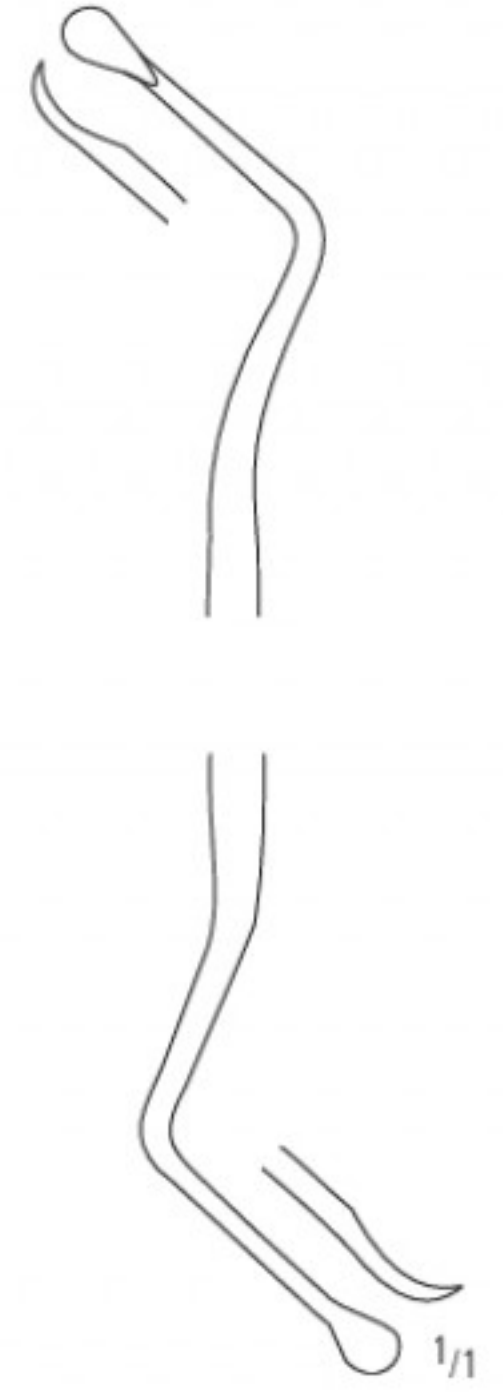

KA 654/86
 17,0 cm/6³/₄"

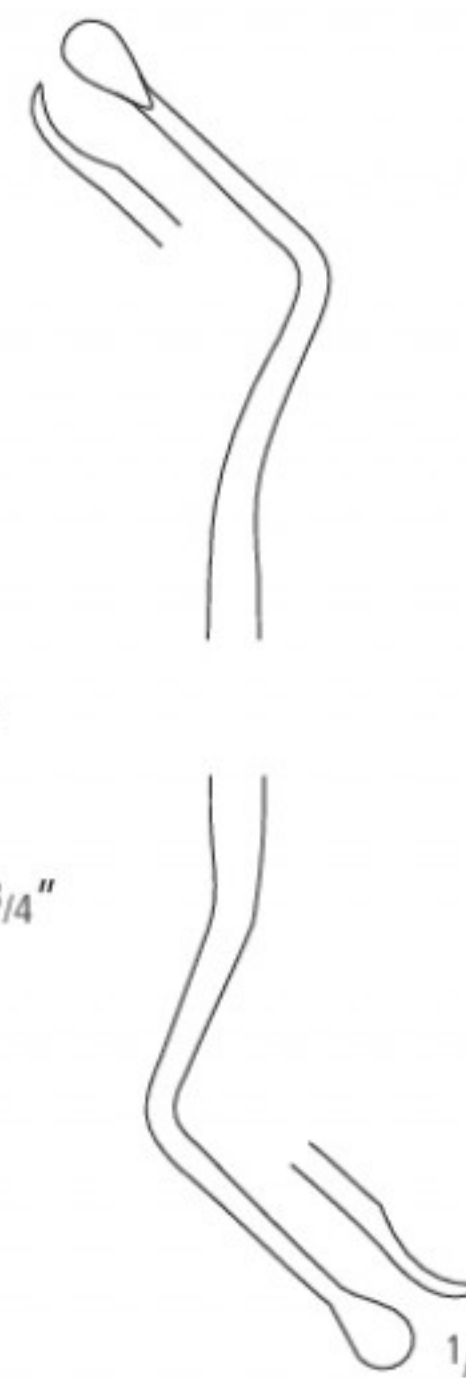

KA 654/87
 17,0 cm/6³/₄"

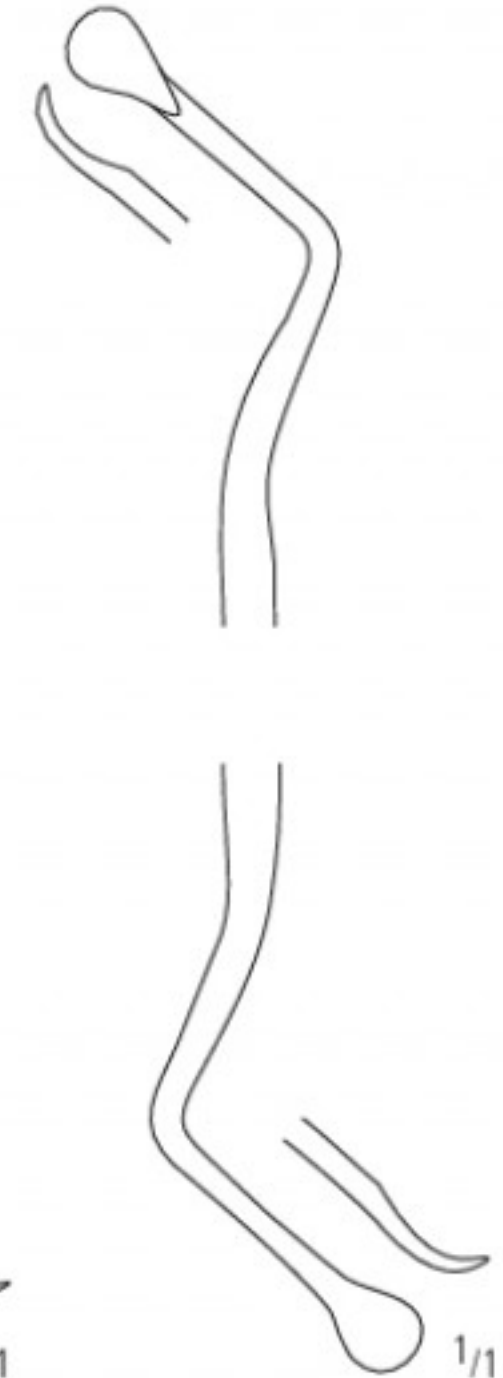

KA 654/88
 17,0 cm/6³/₄"

AA
 AB
 AC
 AD
 AE
 AF
 AK
 AL
 AO
 AR
KA
 KL
 KU
 PA
 PB
 PF
 PI
 PK
 PL
 PM
 PP
 PS
 PT
 PU
 PV
 KYE

Raspatorien
 Raspatories
 Raspadores
 Rugines-Raspatoires
 Periostotomi

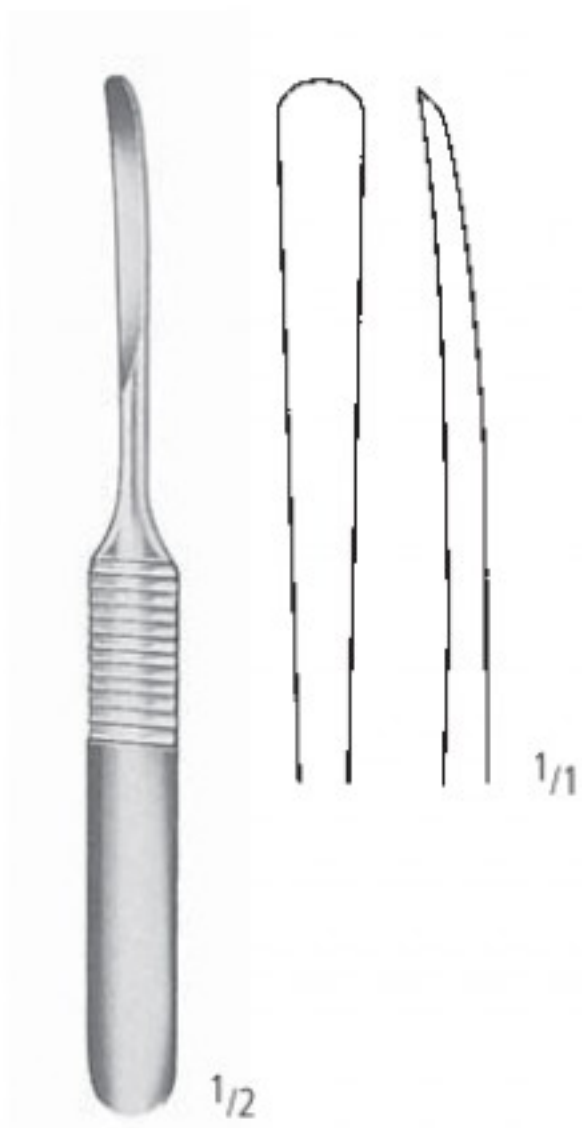

WILLIGER
 KA 680/13
 13,0 cm/5"

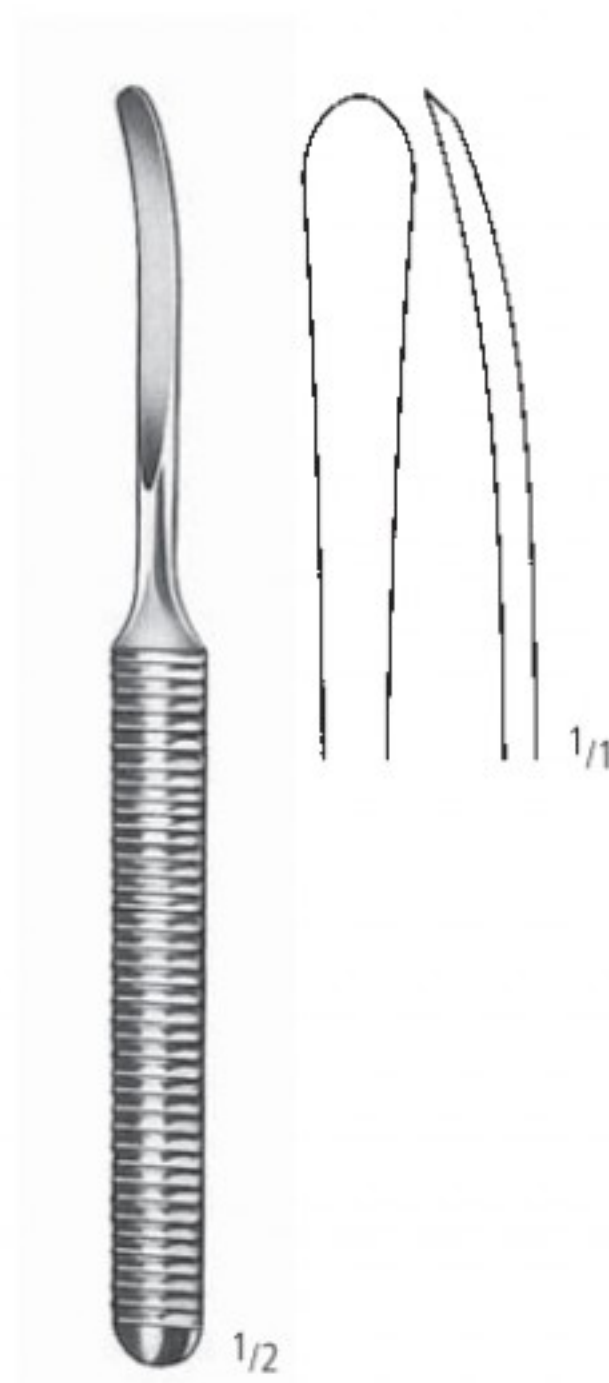

WILLIGER
 KA 680/16
 16,0 cm/6¹/₄"

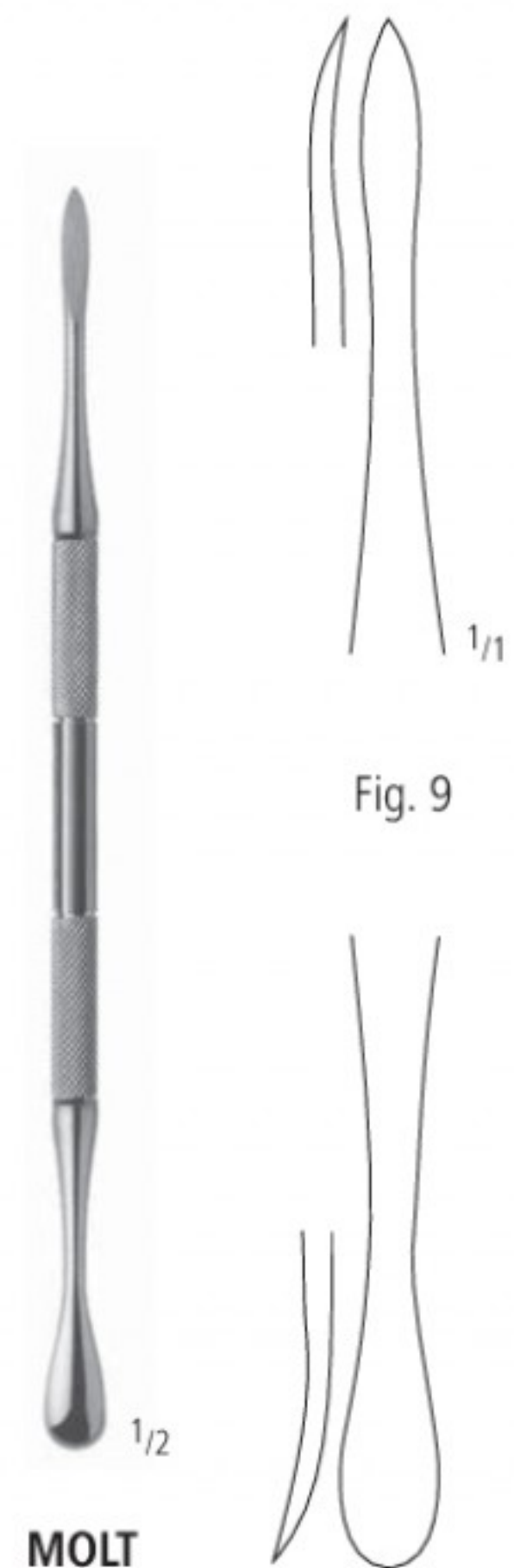

MOLT
 KA 682/09
 18,0 cm/7"

Fig. 9

Hohlmeißelzangen
 Bone Rongeurs
 Pinzas-gubias
 Pincès-gouges
 Pinze-sgorbie

AA
AB
AC
AD
AE
AF
AK
AL
AO
AR
KA
KL
KU
PA
PB
PF
PI
PK
PL
PM
PP
PS
PT
PU
PV
KYE

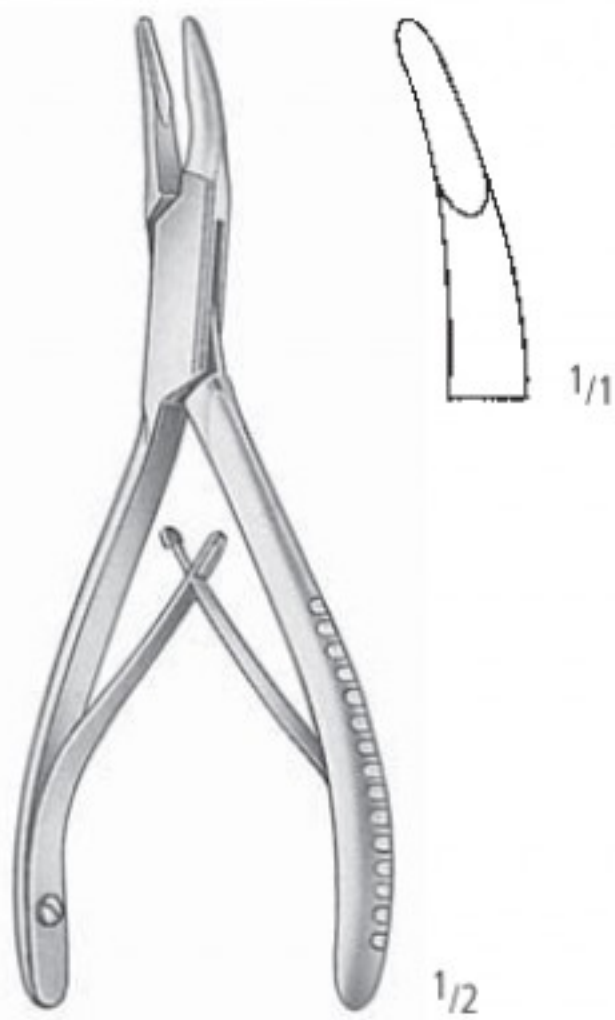

MINI-FRIEDMAN
 KA 800/12
 12,0 cm/4³/₄"

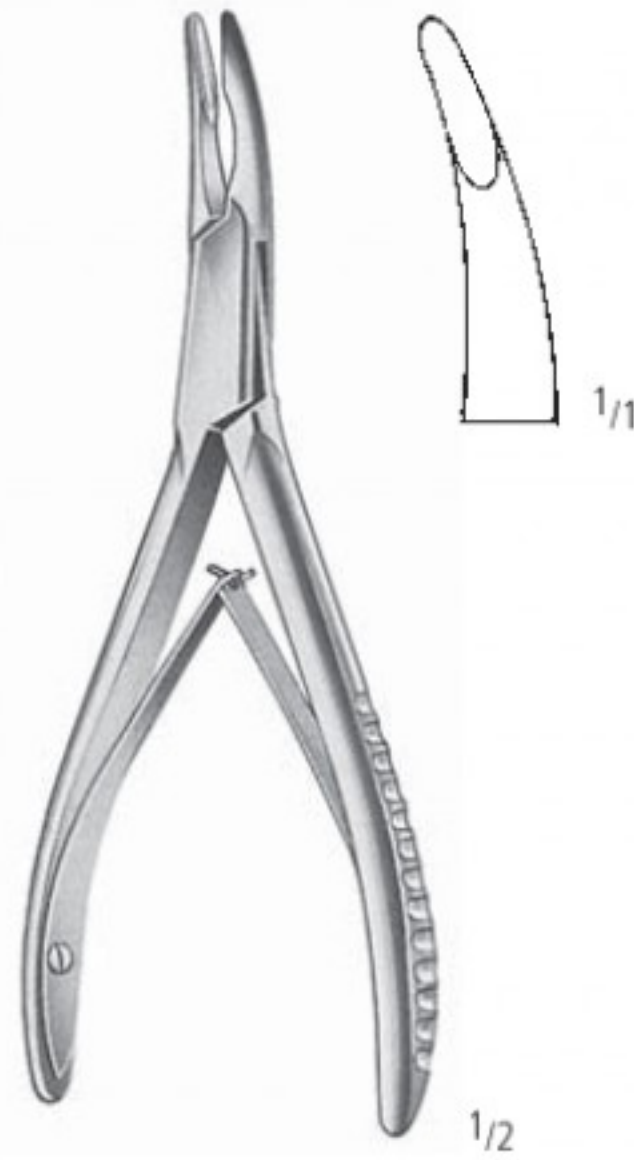

FRIEDMAN
 KA 800/14
 14,0 cm/5¹/₂"

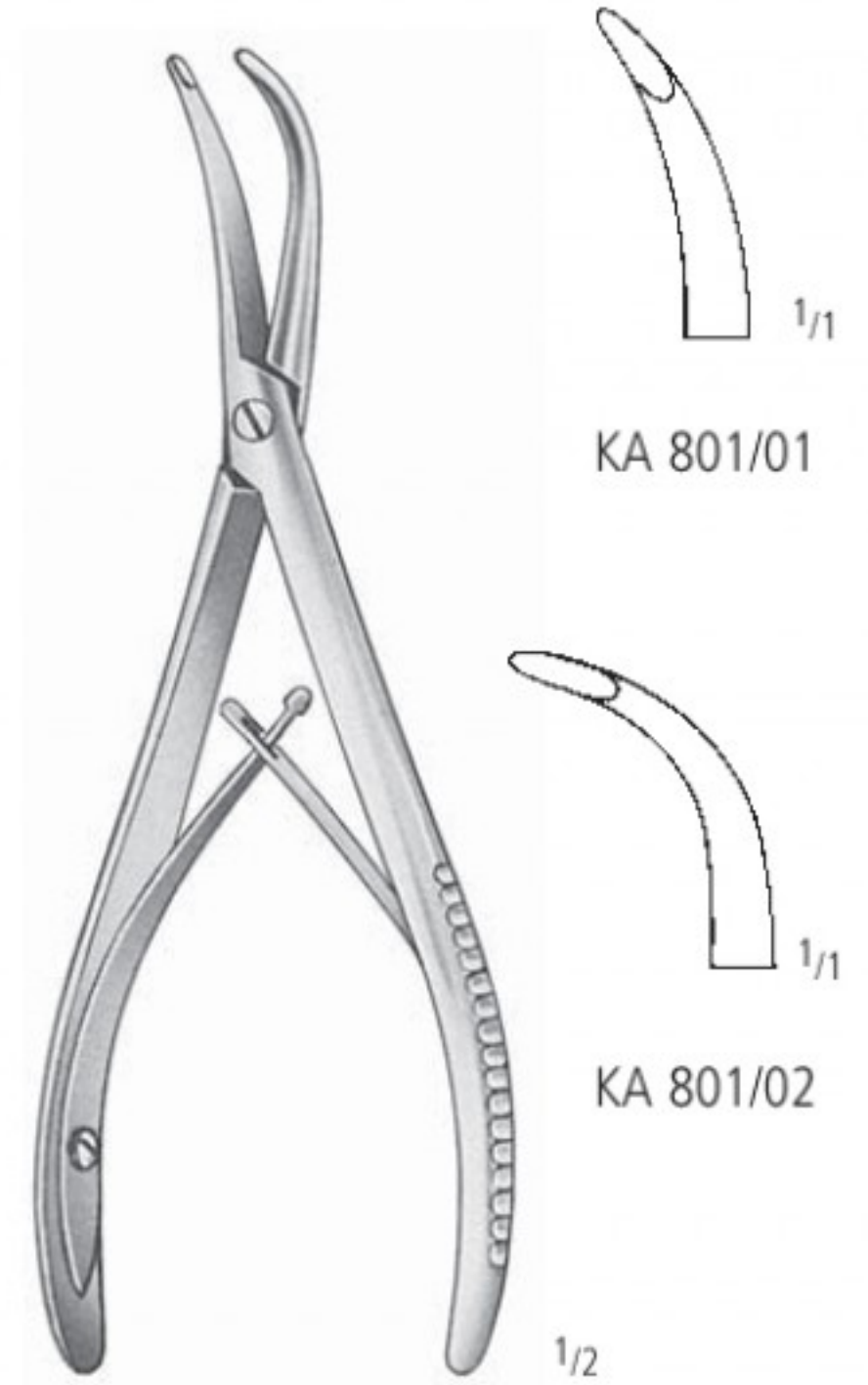

STELLBRINK
 17,0 cm/6³/₄"

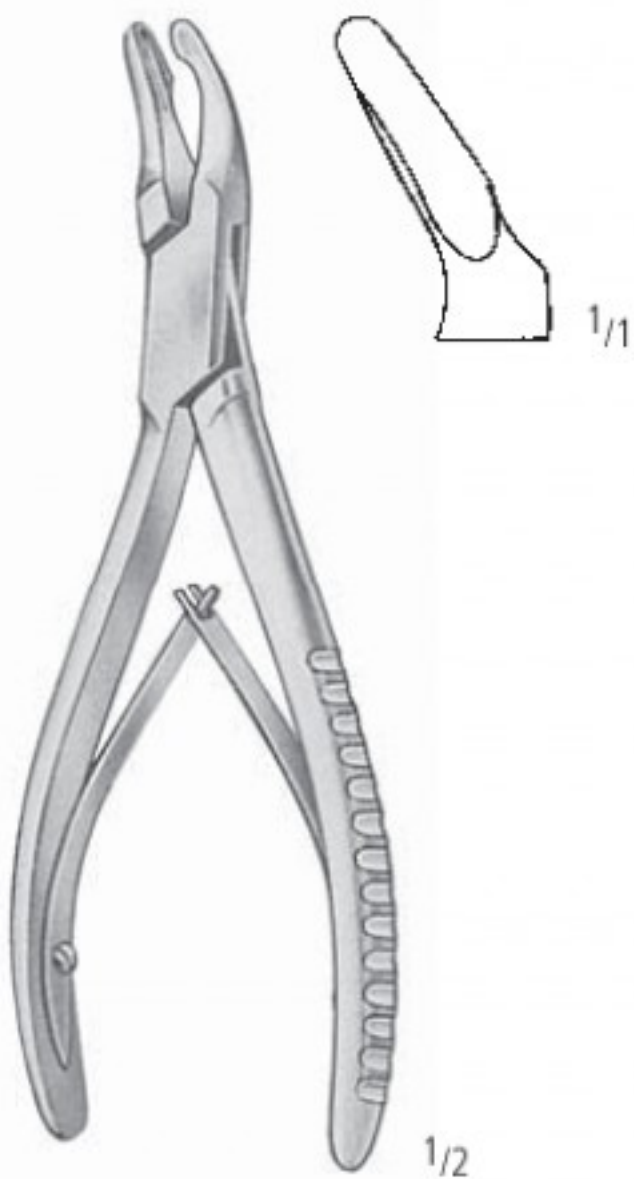

CLEVELAND
 KA 802/14
 14,0 cm/5¹/₂"

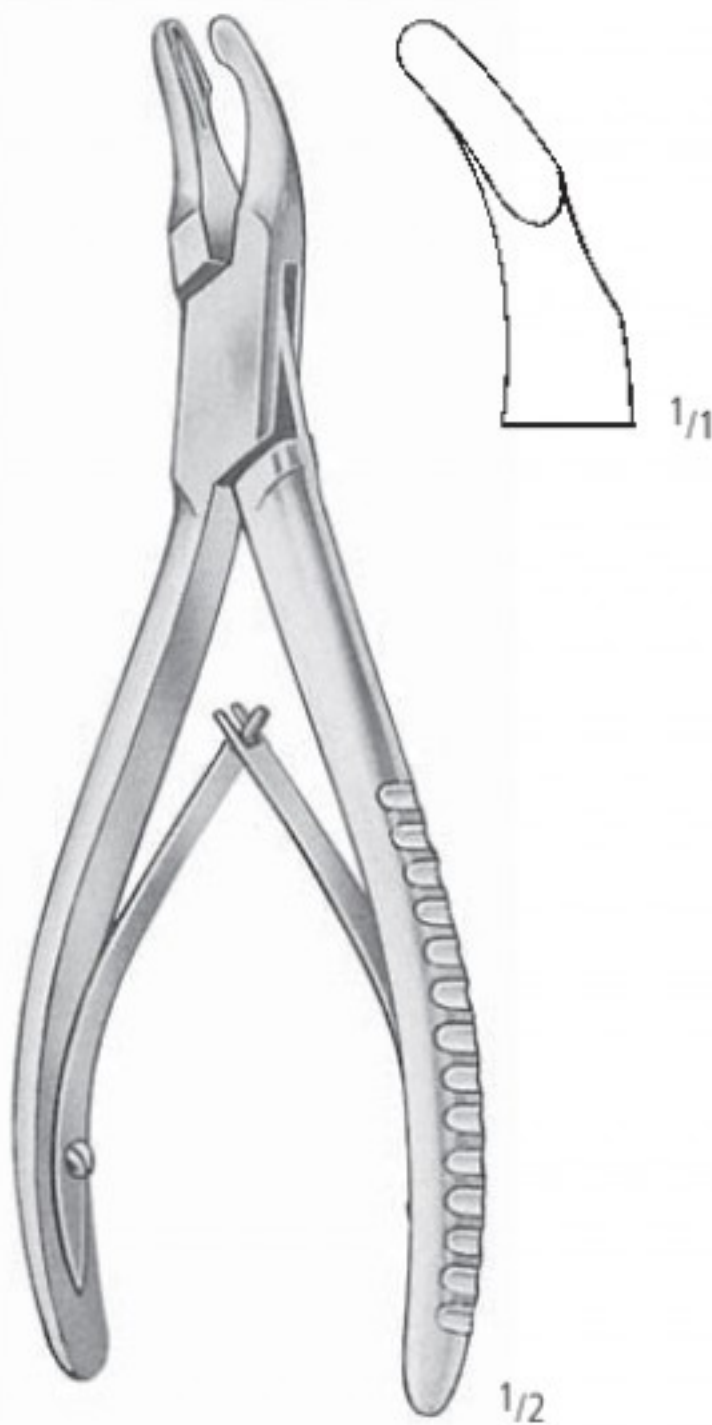

CLEVELAND
 KA 802/17
 17,0 cm/6³/₄"

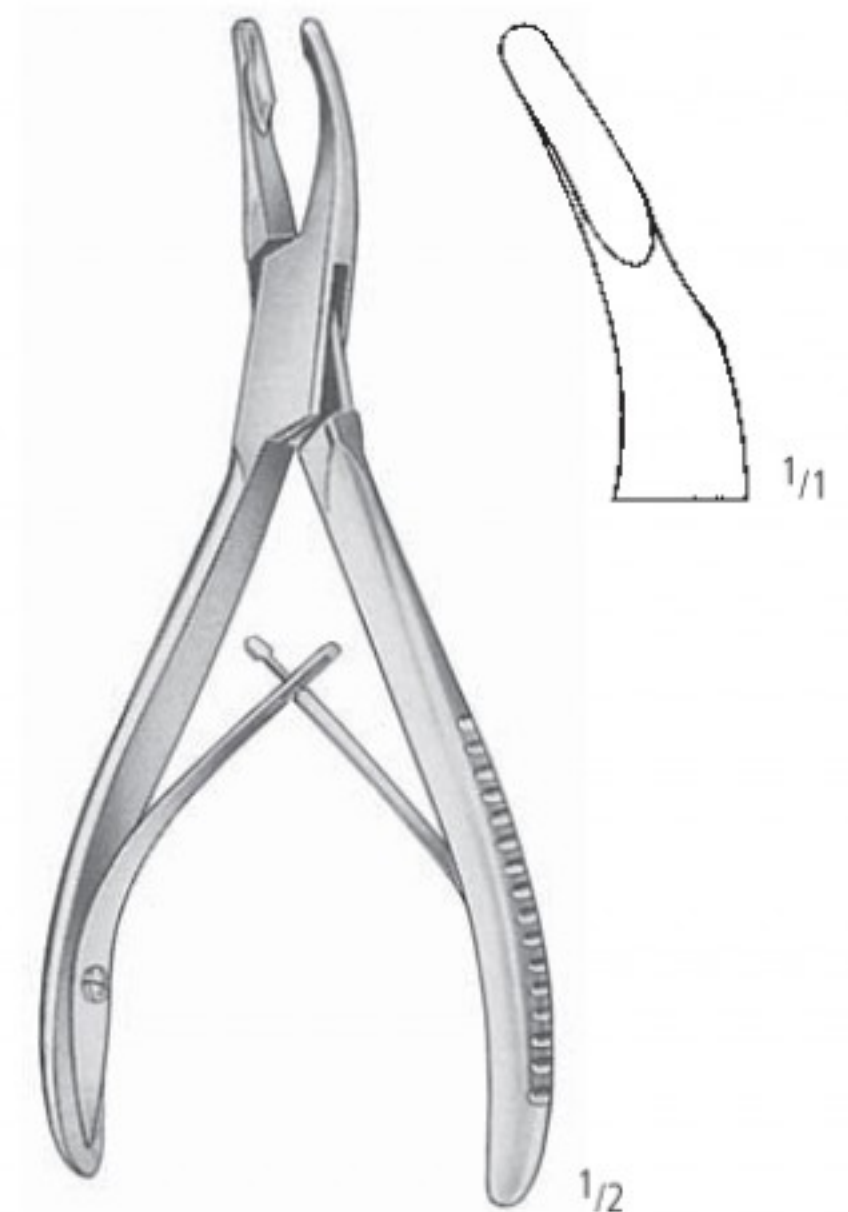

UNIVERSAL
 KA 803/13
 13,5 cm/5¹/₄"

Hohlmeißelzangen
 Bone Rongeurs
 Pinzas-gubias
 Pincas-gouges
 Pinze-sgorbie

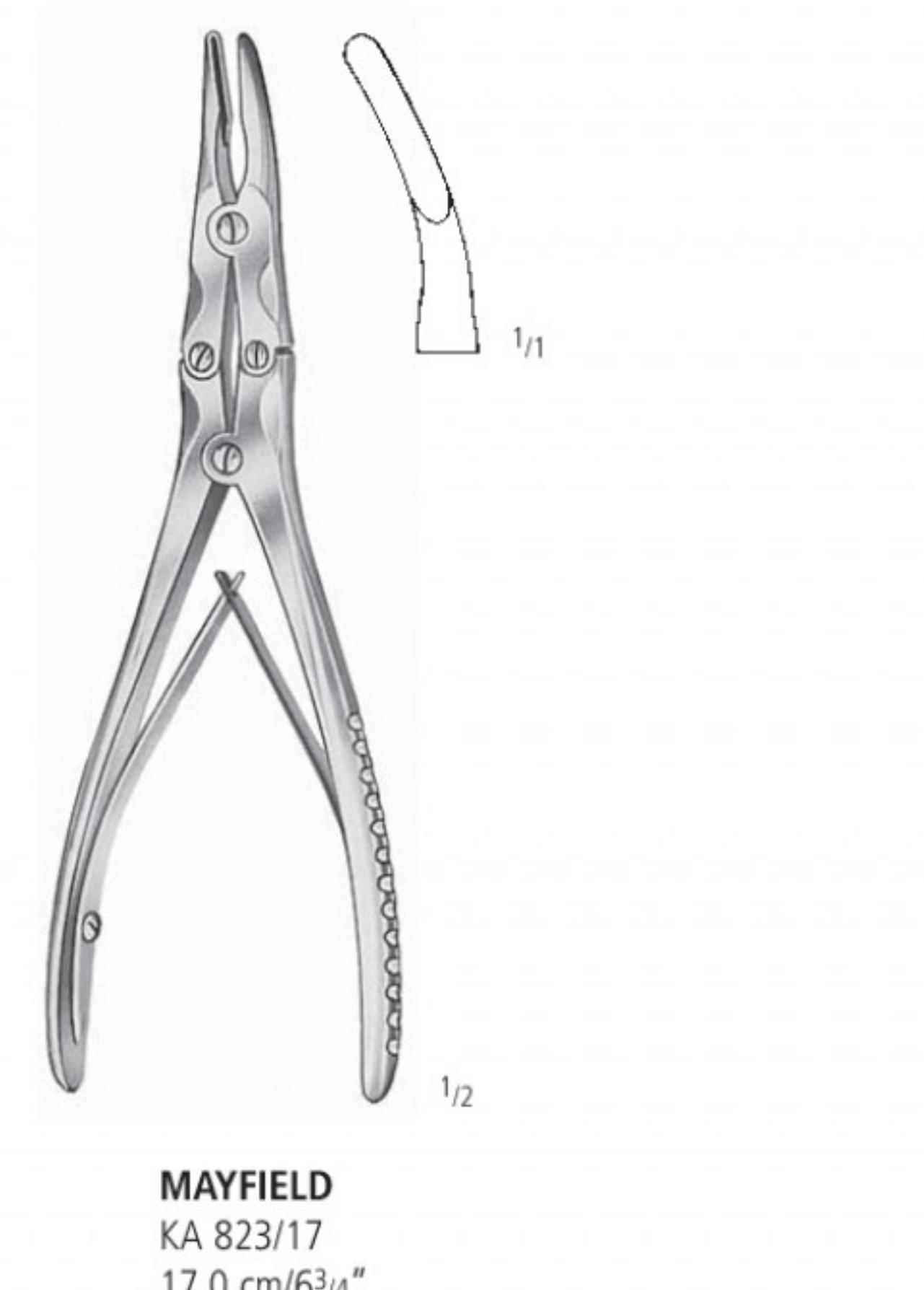
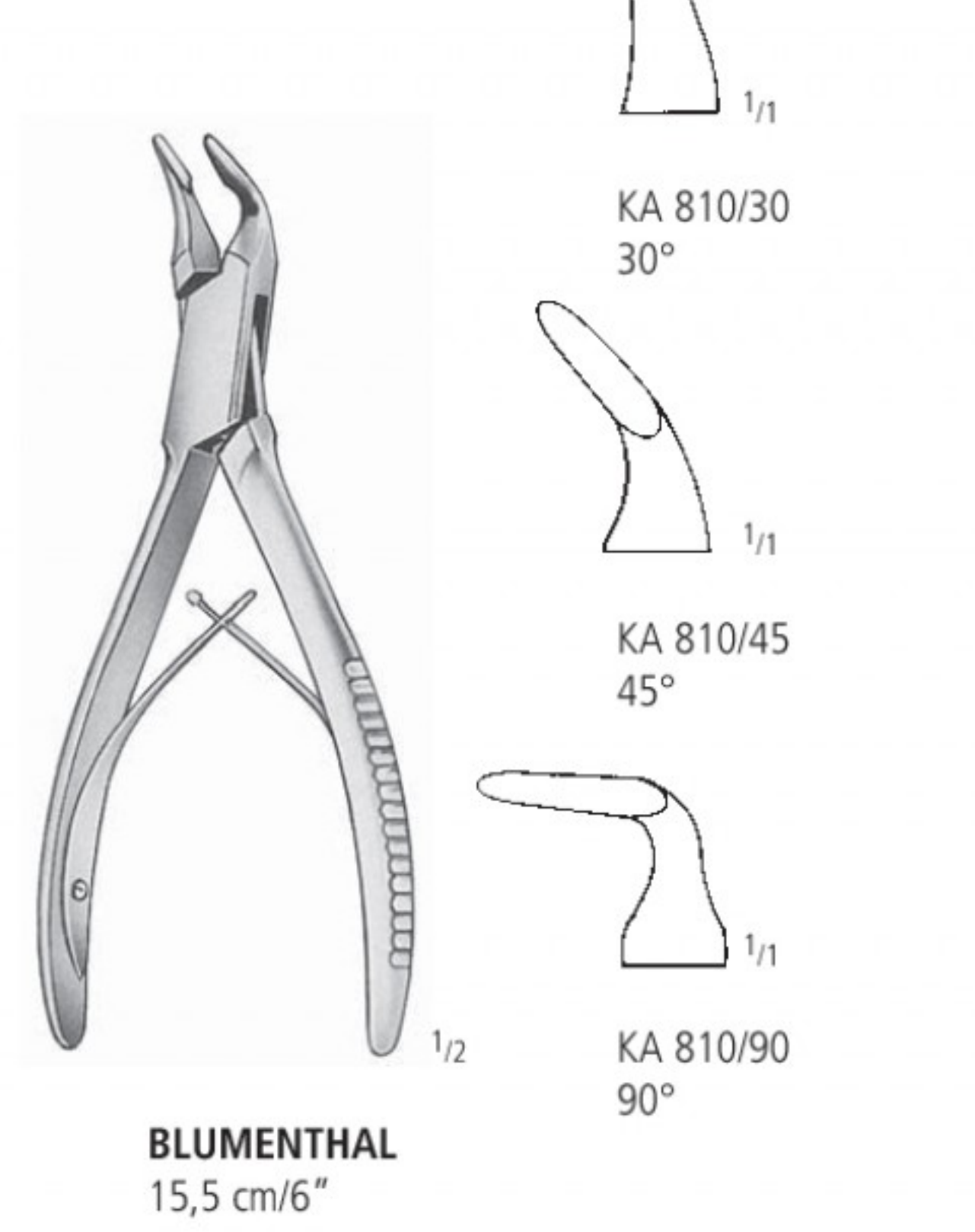
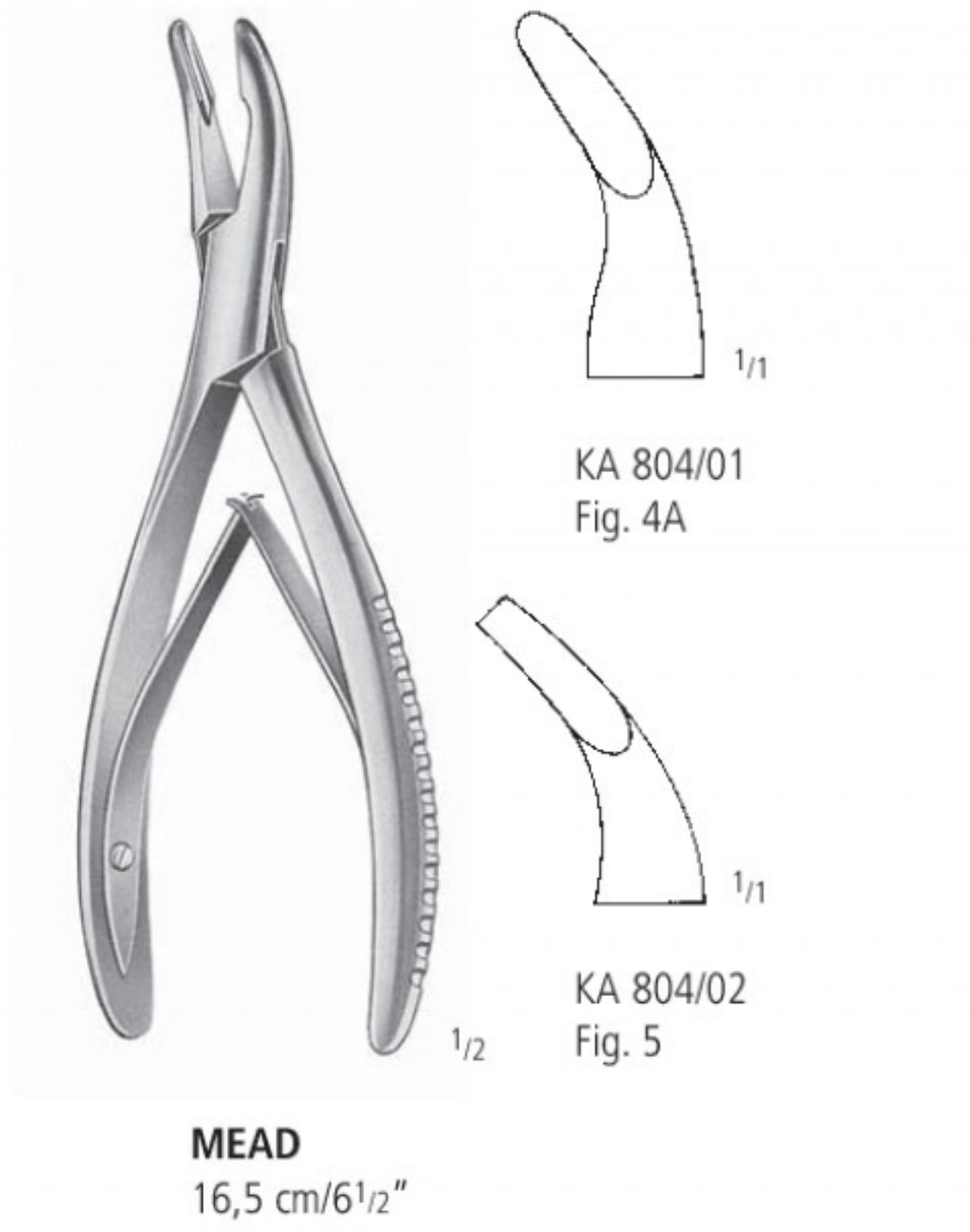

Hohlmeißelzangen
 Bone Rongeurs
 Pinzas-gubias
 Pincers-gouges
 Pinze-sgorbie

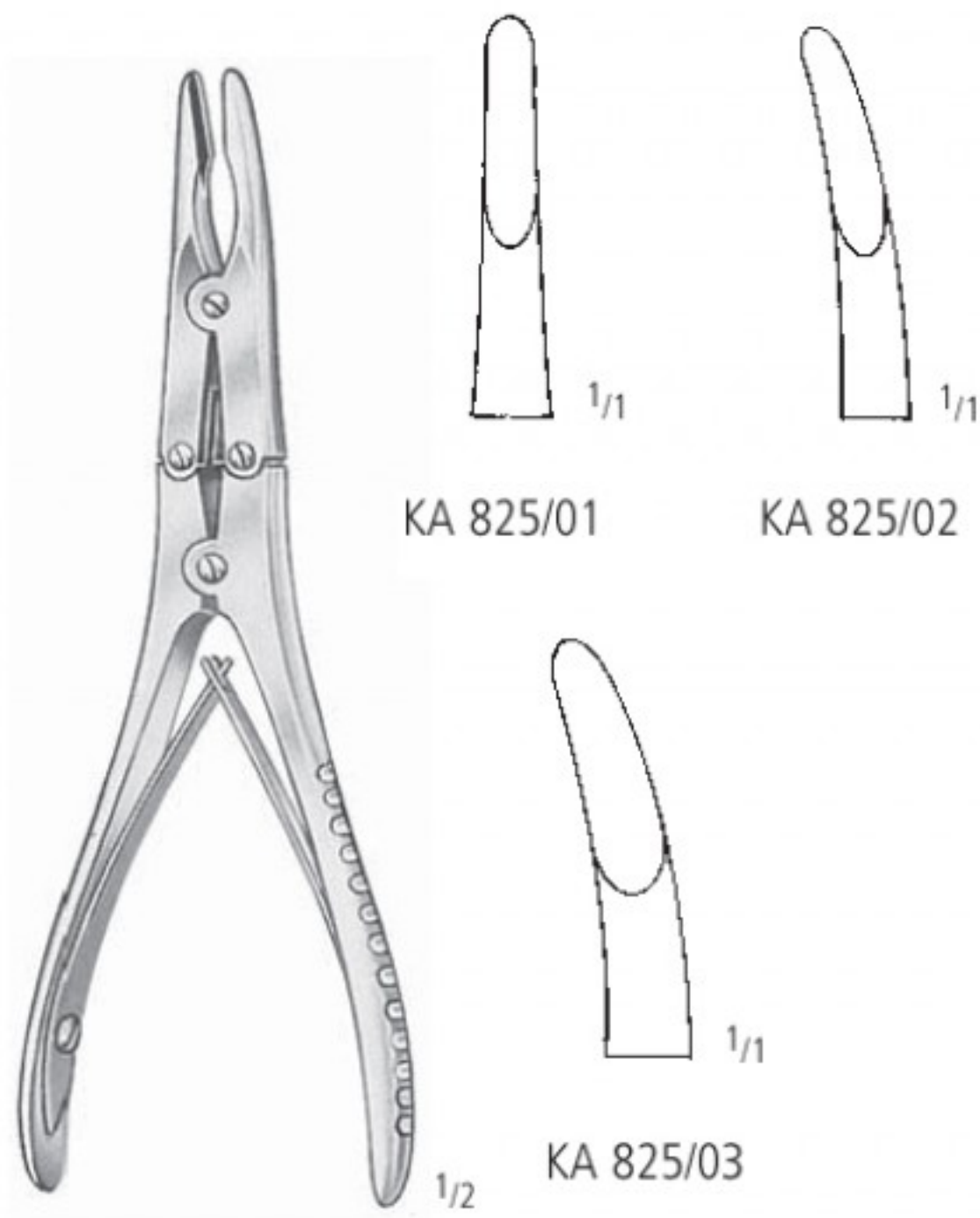

BÖHLER
 15,0 cm/6"

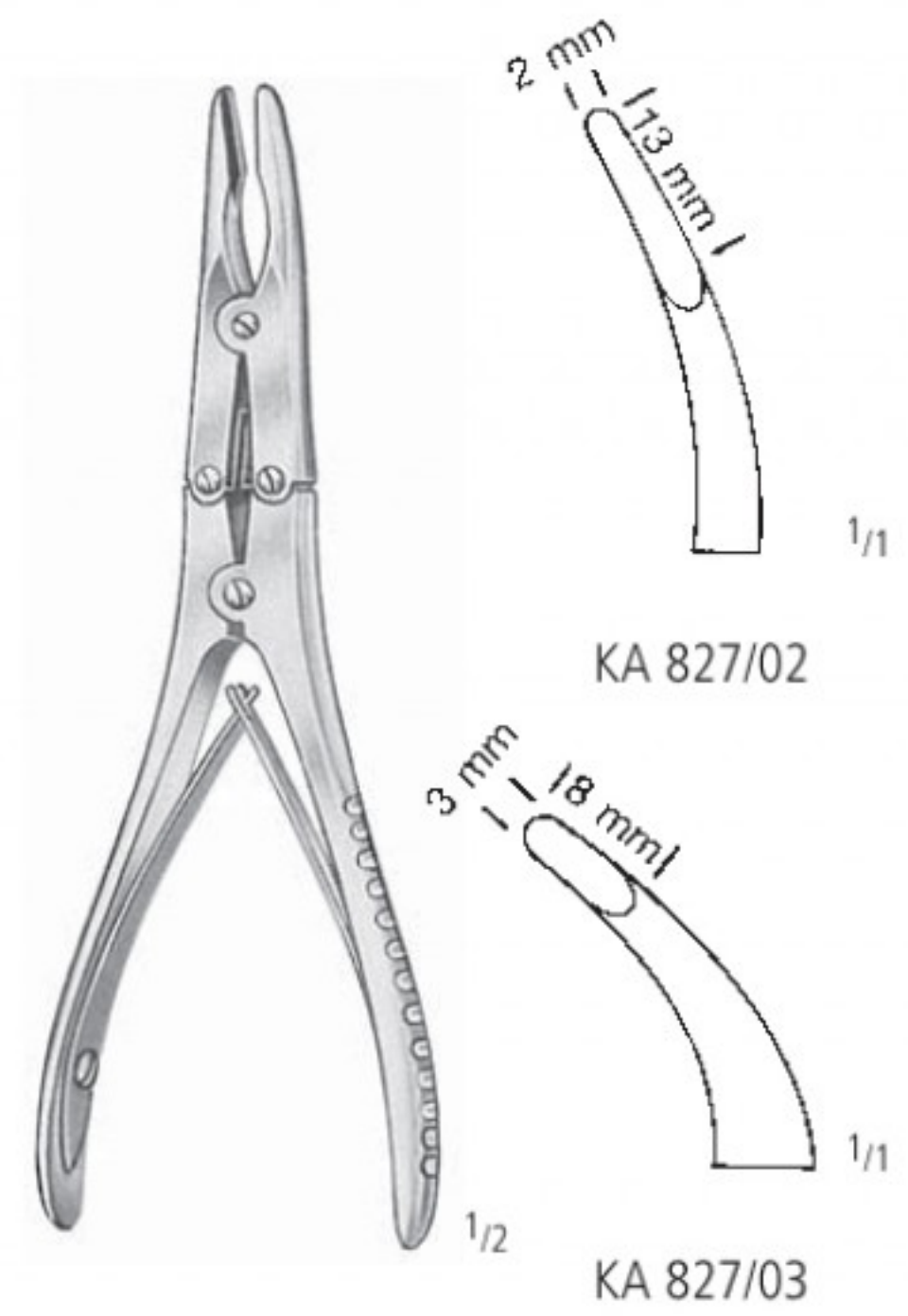

KLEINERT-KUTZ
 15,0 cm/6"

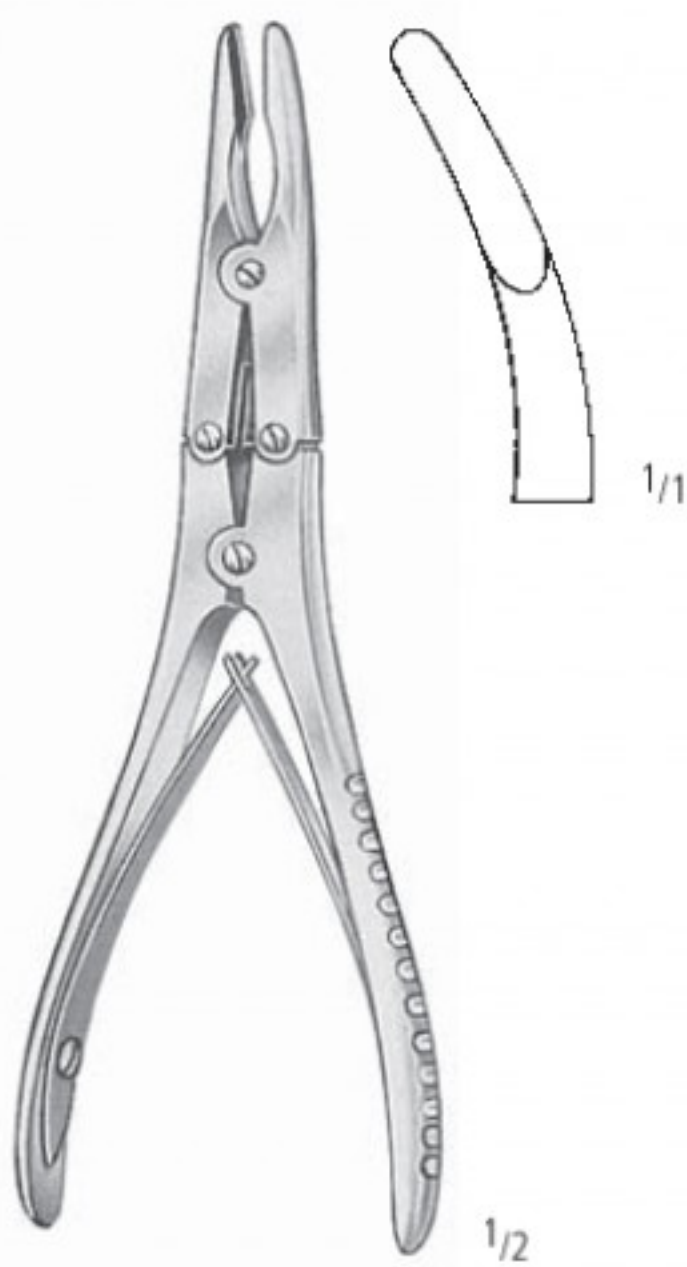

RUSKIN-MINI
 KA 829/15
 15,0 cm/6"



BEYER
 KA 830/18
 18,0 cm/7"

AA
 AB
 AC
 AD
 AE
 AF
 AK
 AL
 AO
 AR
 KA
 KL
 KU
 PA
 PB
 PF
 PI
 PK
 PL
 PM
 PP
 PS
 PT
 PU
 PV
 KYE

Hohlmeißelzangen
 Bone Rongeurs
 Pinzas-gubias
 Pincès-gouges
 Pinze-sgorbie

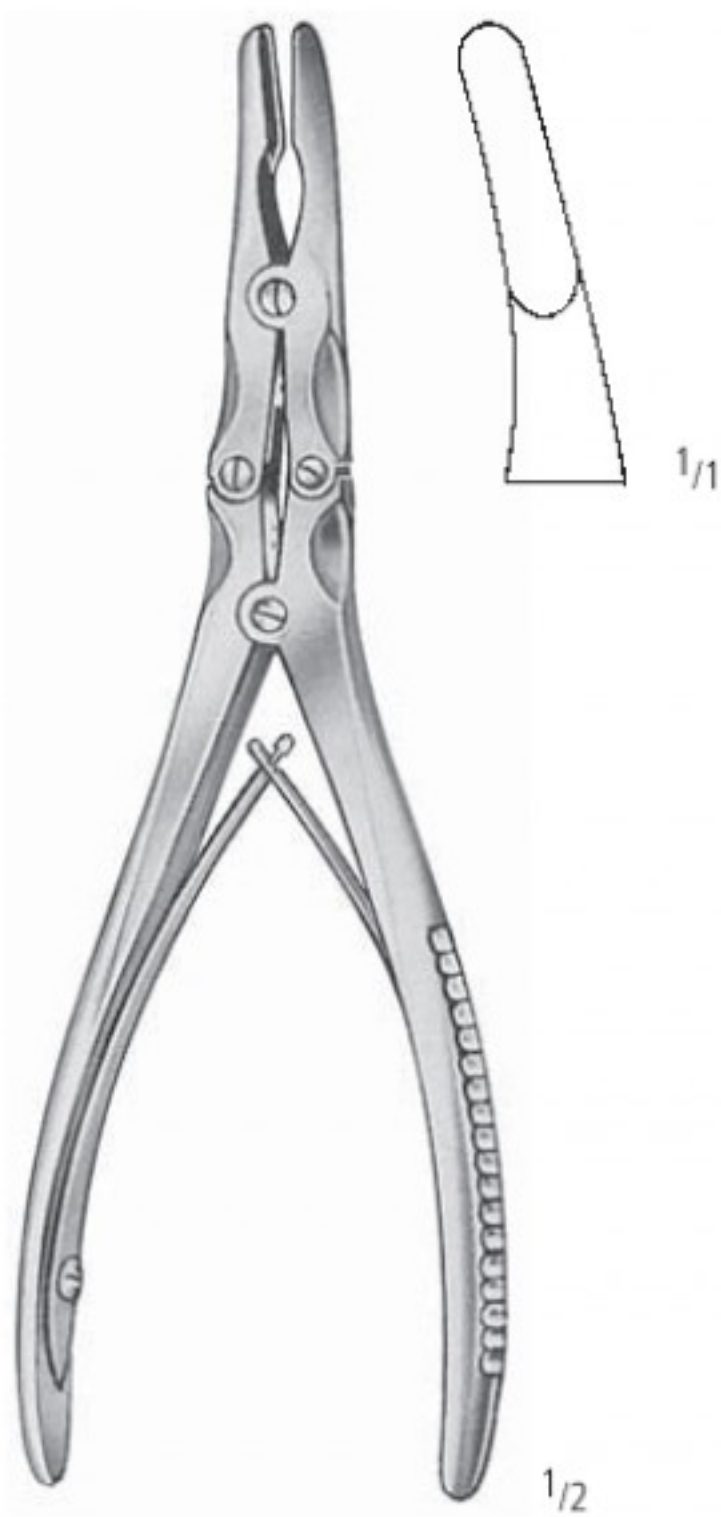

ZAUFAL-JANSEN
 KA 835/18
 18,0 cm/7"

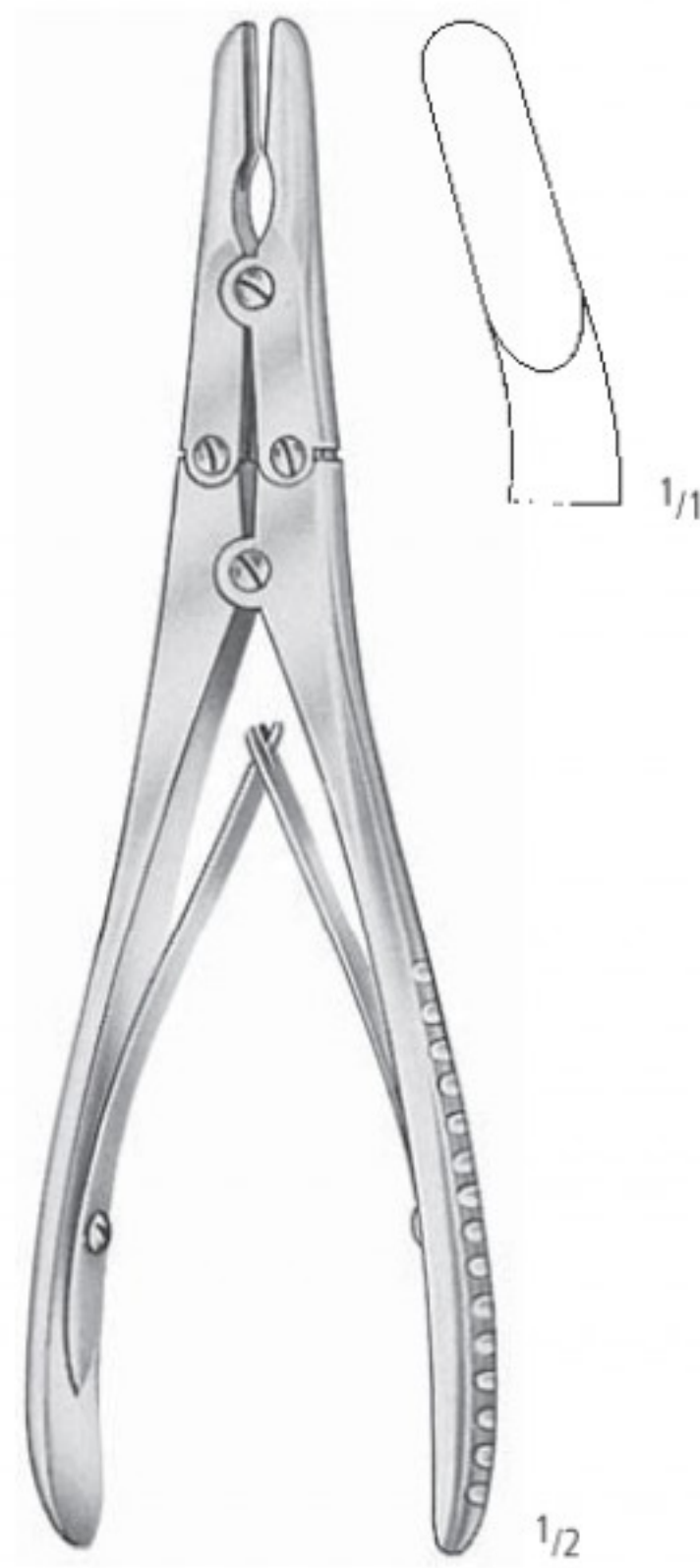

RUSKIN
 KA 836/18
 18,0 cm/7"



RUSKIN
 KA 862/23
 23,0 cm/9"

Hohlmeißelzangen
 Bone Rongeurs
 Pinzas-gubias
 Pincès-gouges
 Pinze-sgorbie

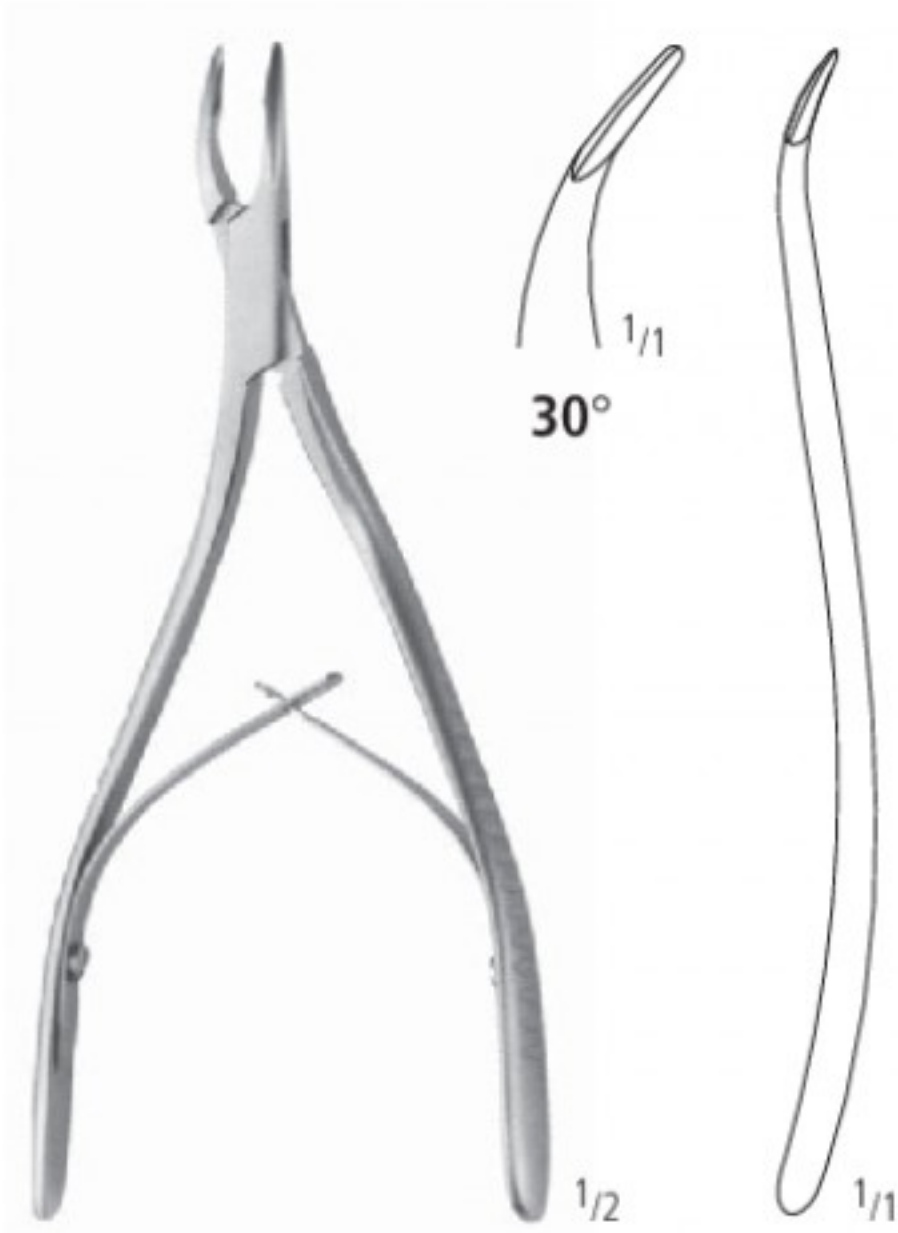

MICRO-FRIEDMAN
 KA 865/14
 14,5 cm/5³/₄"

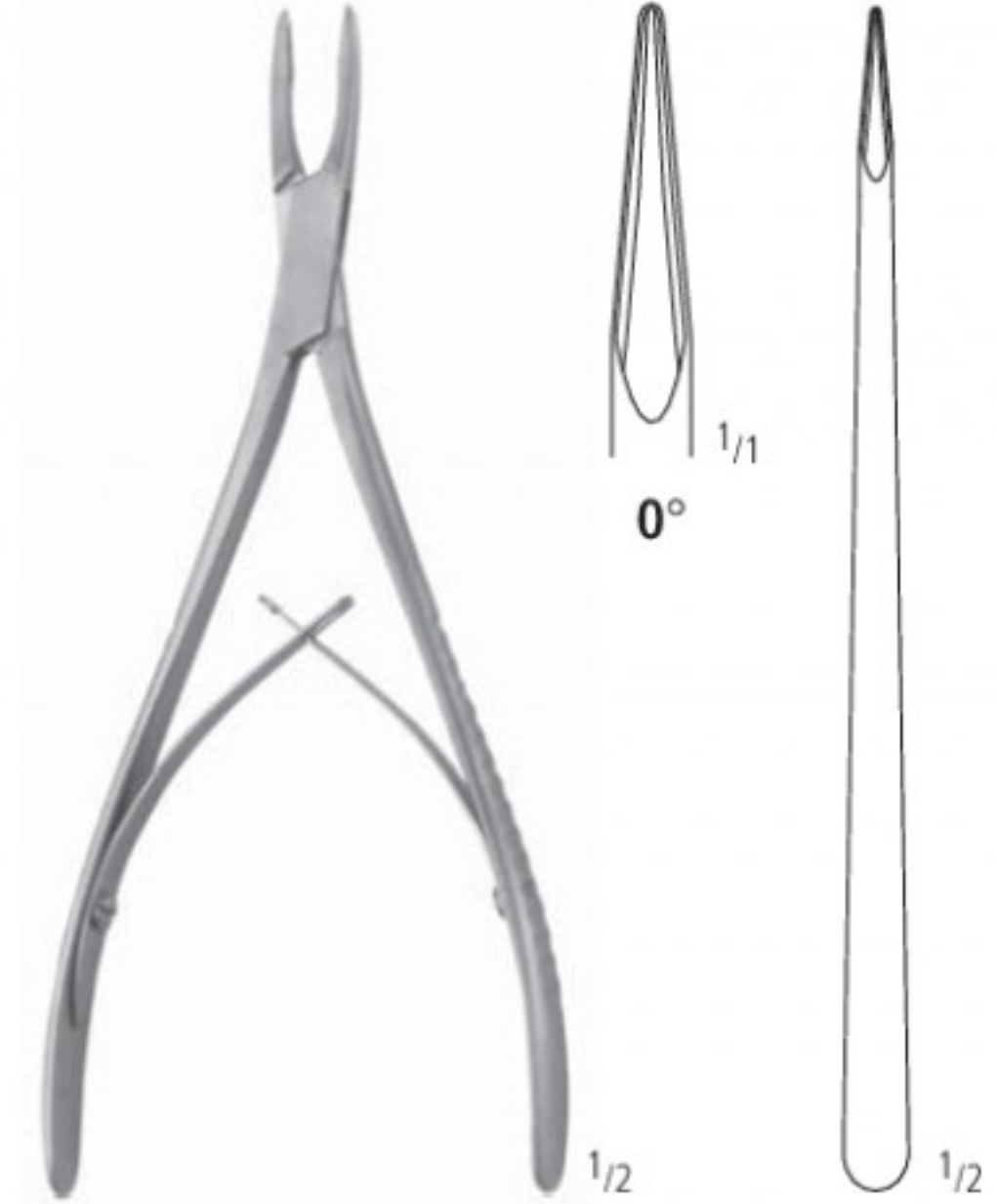

MICRO-FRIEDMAN
 KA 866/15
 15,0 cm/6"

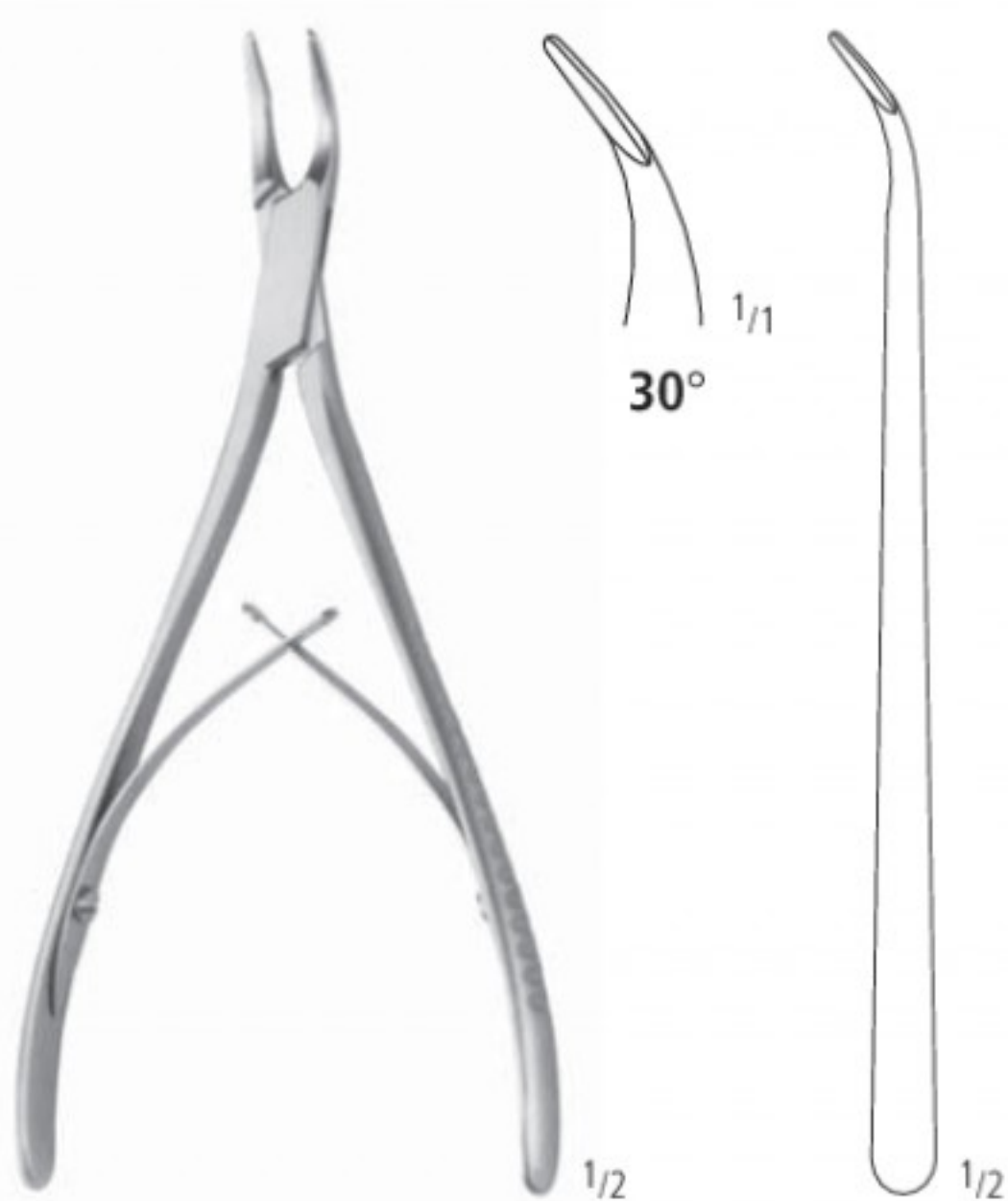

MICRO-FRIEDMAN
 KA 867/15
 15,0 cm/6"

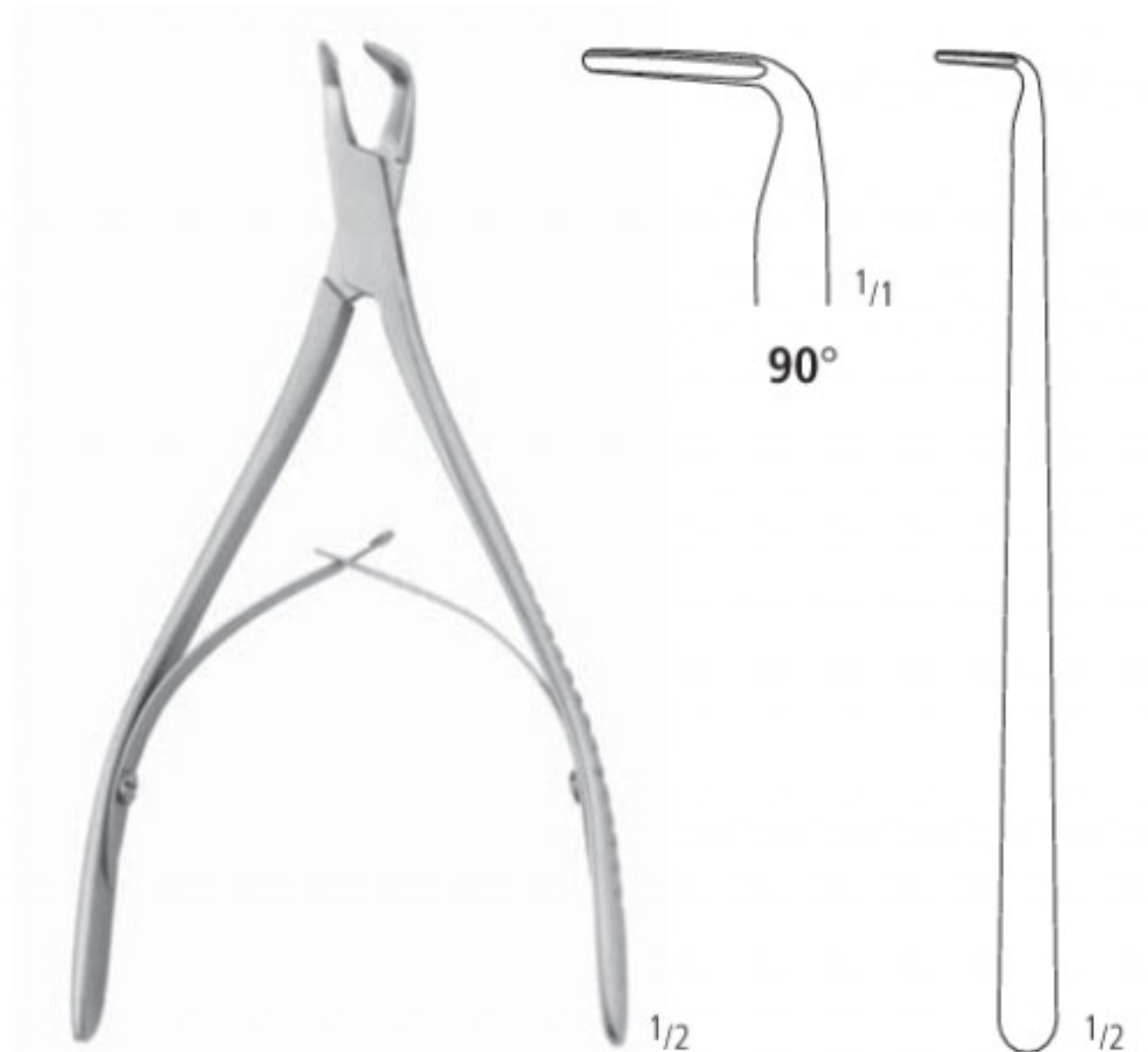

MICRO-FRIEDMAN
 KA 868/15
 14,5 cm/5³/₄"

AA
 AB
 AC
 AD
 AE
 AF
 AG
 AH
 AI
 AJ
 AK
 AL
 AO
 AP
 AQ
 AR
 AS
 AT
 AU
 AV
 AW
 AX
 AY
 AZ
 BA
 BB
 BC
 BD
 BE
 BF
 BG
 BH
 BI
 BJ
 BK
 BL
 BM
 BN
 BO
 BP
 BQ
 BR
 BS
 BT
 BU
 BV
 BW
 BX
 BY
 BZ
 CA
 CB
 CC
 CD
 CE
 CF
 CG
 CH
 CI
 CJ
 CK
 CL
 CM
 CN
 CO
 CP
 CQ
 CR
 CS
 CT
 CU
 CV
 CW
 CX
 CY
 CZ
 DA
 DB
 DC
 DD
 DE
 DF
 DG
 DH
 DI
 DJ
 DK
 DL
 DM
 DN
 DO
 DP
 DQ
 DR
 DS
 DT
 DU
 DV
 DW
 DX
 DY
 DZ
 EA
 EB
 EC
 ED
 EE
 EF
 EG
 EH
 EI
 EJ
 EK
 EL
 EM
 EN
 EO
 EP
 EQ
 ER
 ES
 ET
 EU
 EV
 EW
 EX
 EY
 EZ
 FA
 FB
 FC
 FD
 FE
 FF
 FG
 FH
 FI
 FJ
 FK
 FL
 FM
 FN
 FO
 FP
 FQ
 FR
 FS
 FT
 FU
 FV
 FW
 FX
 FY
 FZ
 GA
 GB
 GC
 GD
 GE
 GF
 GG
 GH
 GI
 GJ
 GK
 GL
 GM
 GN
 GO
 GP
 GQ
 GR
 GS
 GT
 GU
 GV
 GW
 GX
 GY
 GZ
 HA
 HB
 HC
 HD
 HE
 HF
 HG
 HH
 HI
 HJ
 HK
 HL
 HM
 HN
 HO
 HP
 HQ
 HR
 HS
 HT
 HU
 HV
 HW
 HX
 HY
 HZ
 IA
 IB
 IC
 ID
 IE
 IF
 IG
 IH
 II
 IJ
 IK
 IL
 IM
 IN
 IO
 IP
 IQ
 IR
 IS
 IT
 IU
 IV
 IW
 IX
 IY
 IZ
 JA
 JB
 JC
 JD
 JE
 JF
 JG
 JH
 JI
 JJ
 JK
 JL
 JM
 JN
 JO
 JP
 JQ
 JR
 JS
 JT
 JU
 JV
 JW
 JX
 JY
 JZ
 KA
 KB
 KC
 KD
 KE
 KF
 KG
 KH
 KI
 KJ
 KK
 KL
 KM
 KN
 KO
 KP
 KQ
 KR
 KS
 KT
 KU
 KV
 KW
 KX
 KY
 KZ
 LA
 LB
 LC
 LD
 LE
 LF
 LG
 LH
 LI
 LJ
 LK
 LL
 LM
 LN
 LO
 LP
 LQ
 LR
 LS
 LT
 LU
 LV
 LW
 LX
 LY
 LZ
 MA
 MB
 MC
 MD
 ME
 MF
 MG
 MH
 MI
 MJ
 MK
 ML
 MM
 MN
 MO
 MP
 MQ
 MR
 MS
 MT
 MU
 MV
 MW
 MX
 MY
 MZ
 NA
 NB
 NC
 ND
 NE
 NF
 NG
 NH
 NI
 NJ
 NK
 NL
 NM
 NN
 NO
 NP
 NQ
 NR
 NS
 NT
 NU
 NV
 NW
 NX
 NY
 NZ
 OA
 OB
 OC
 OD
 OE
 OF
 OG
 OH
 OI
 OJ
 OK
 OL
 OM
 ON
 OO
 OP
 OQ
 OR
 OS
 OT
 OU
 OV
 OW
 OX
 OY
 OZ
 PA
 PB
 PC
 PD
 PE
 PF
 PG
 PH
 PI
 PJ
 PK
 PL
 PM
 PN
 PO
 PP
 PQ
 PR
 PS
 PT
 PU
 PV
 PW
 PX
 PY
 PZ
 QA
 QB
 QC
 QD
 QE
 QF
 QG
 QH
 QI
 QJ
 QK
 QL
 QM
 QN
 QO
 QP
 QQ
 QR
 QS
 QT
 QU
 QV
 QW
 QX
 QY
 QZ
 RA
 RB
 RC
 RD
 RE
 RF
 RG
 RH
 RI
 RJ
 RK
 RL
 RM
 RN
 RO
 RP
 RQ
 RR
 RS
 RT
 RU
 RV
 RW
 RX
 RY
 RZ
 SA
 SB
 SC
 SD
 SE
 SF
 SG
 SH
 SI
 SJ
 SK
 SL
 SM
 SN
 SO
 SP
 SQ
 SR
 SS
 ST
 SU
 SV
 SW
 SX
 SY
 SZ
 TA
 TB
 TC
 TD
 TE
 TF
 TG
 TH
 TI
 TJ
 TK
 TL
 TM
 TN
 TO
 TP
 TQ
 TR
 TS
 TT
 TU
 TV
 TW
 TX
 TY
 TZ
 UA
 UB
 UC
 UD
 UE
 UF
 UG
 UH
 UI
 UJ
 UK
 UL
 UM
 UN
 UO
 UP
 UQ
 UR
 US
 UT
 UU
 UV
 UW
 UX
 UY
 UZ
 VA
 VB
 VC
 VD
 VE
 VF
 VG
 VH
 VI
 VJ
 VK
 VL
 VM
 VN
 VO
 VP
 VQ
 VR
 VS
 VT
 VU
 VV
 VW
 VX
 VY
 VZ
 WA
 WB
 WC
 WD
 WE
 WF
 WG
 WH
 WI
 WJ
 WK
 WL
 WM
 WN
 WO
 WP
 WQ
 WR
 WS
 WT
 WU
 WV
 WW
 WX
 WY
 WZ
 XA
 XB
 XC
 XD
 XE
 XF
 XG
 XH
 XI
 XJ
 XK
 XL
 XM
 XN
 XO
 XP
 XQ
 XR
 XS
 XT
 XU
 XV
 XW
 XX
 XY
 XZ
 YA
 YB
 YC
 YD
 YE
 YF
 YG
 YH
 YI
 YJ
 YK
 YL
 YM
 YN
 YO
 YP
 YQ
 YR
 YS
 YT
 YU
 YV
 YW
 YX
 YY
 YZ
 ZA
 ZB
 ZC
 ZD
 ZE
 ZF
 ZG
 ZH
 ZI
 ZJ
 ZK
 ZL
 ZM
 ZN
 ZO
 ZP
 ZQ
 ZR
 ZS
 ZT
 ZU
 ZV
 ZW
 ZX
 ZY
 ZZ

Knochensplitterzangen
 Bone Cutting Forceps
 Pinzas cortantes para huesos
 Pincas coupantes à os
 Cesioie per ossa

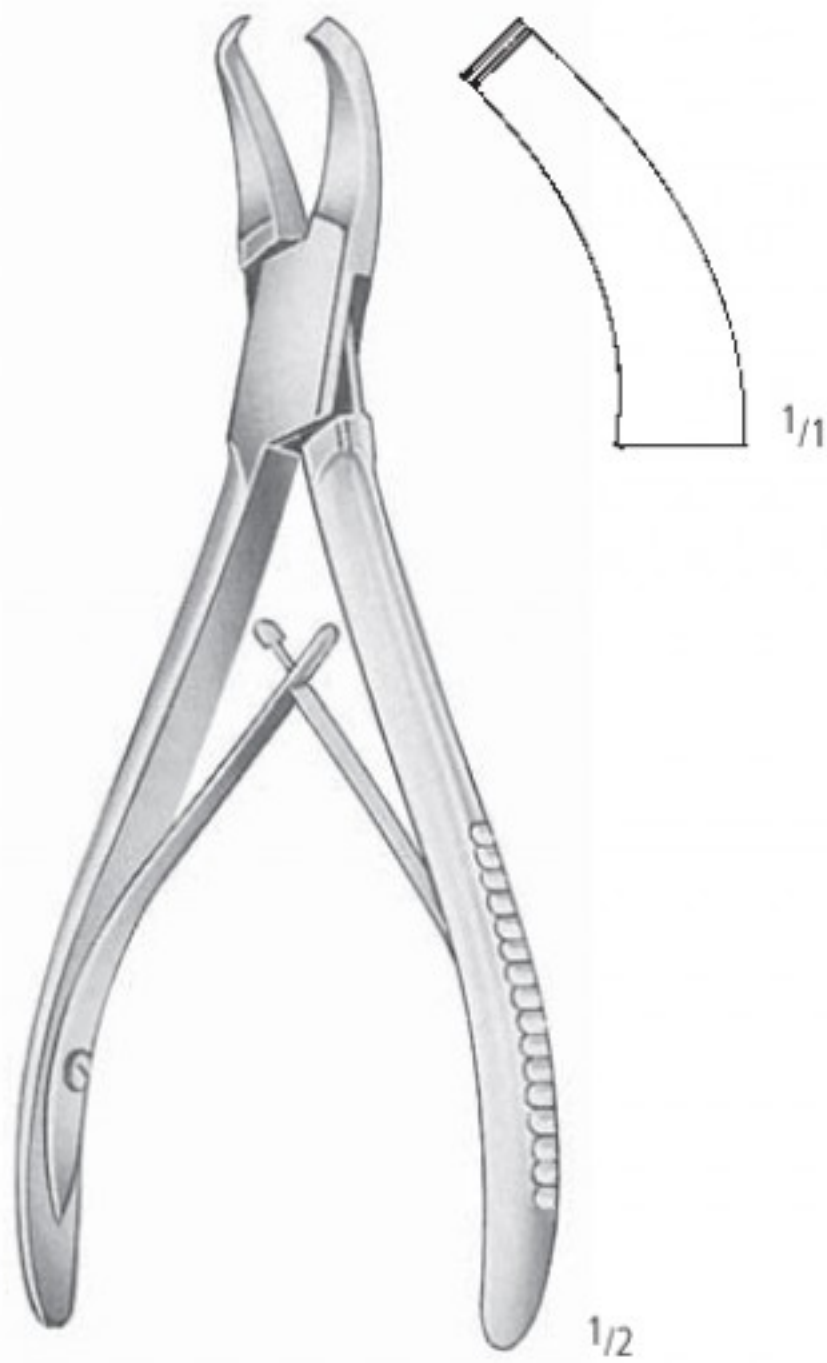

CLEVELAND-GARDENER
 KA 872/16
 18,0 cm/7"



LITTAUER-LISTON
 KA 882/15
 15,0 cm/6"

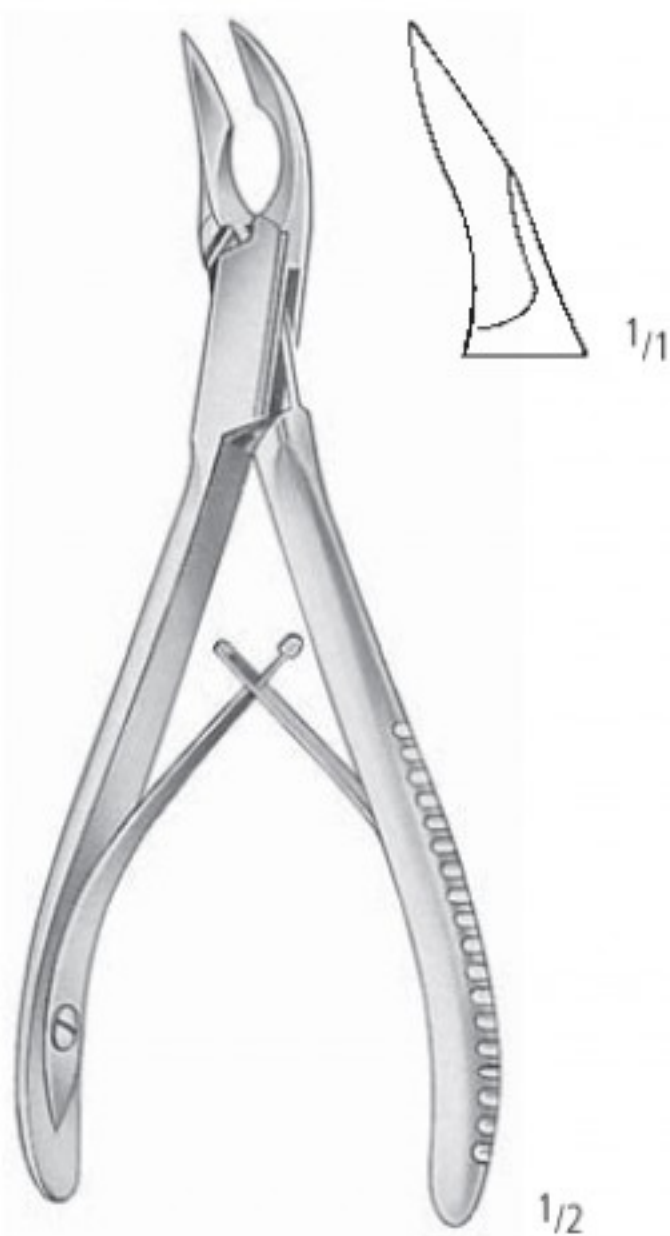

CLEVELAND
 KA 884/15
 15,0 cm/6"
 Fig. 5S

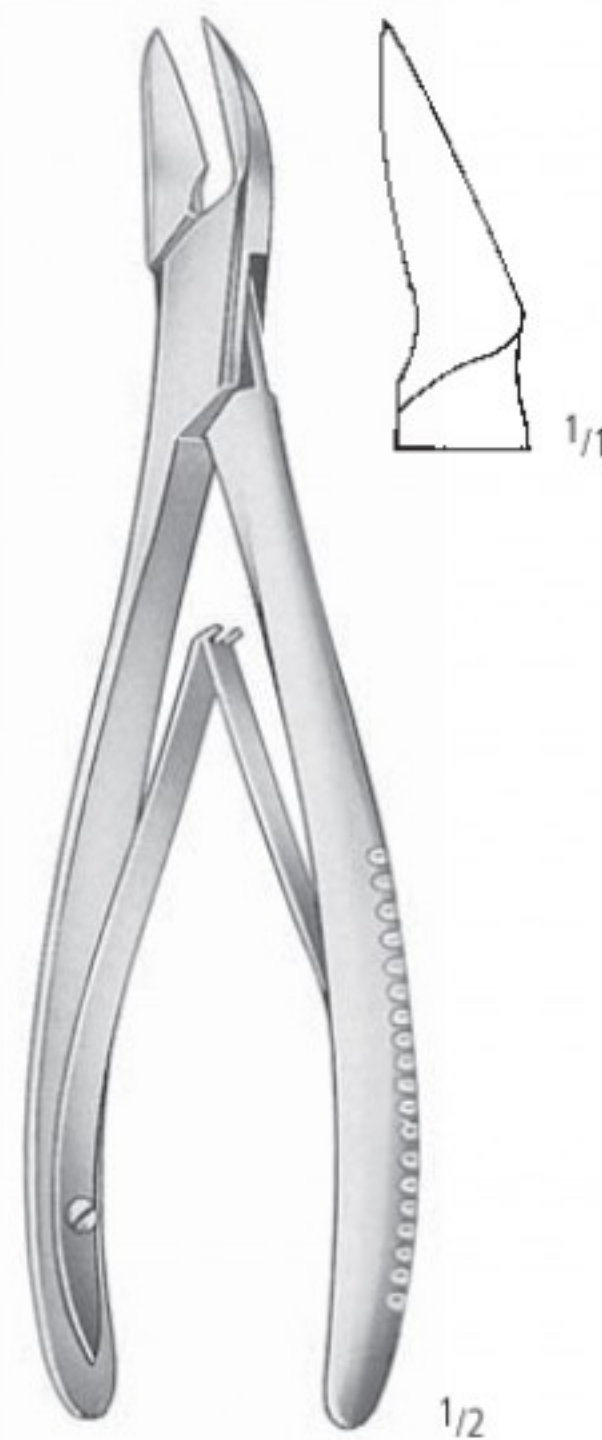

CLEVELAND
 KA 884/17
 17,0 cm/6³/₄"
 Fig. 5



KA 885/12
 12,0 cm/4³/₄"

Keilbeinstanzen
 Sphenoid Punches
 Pinzas para seno esfenoidal
 Pinces pour sinus sphénoïdal
 Pinze per seno sfenoidale

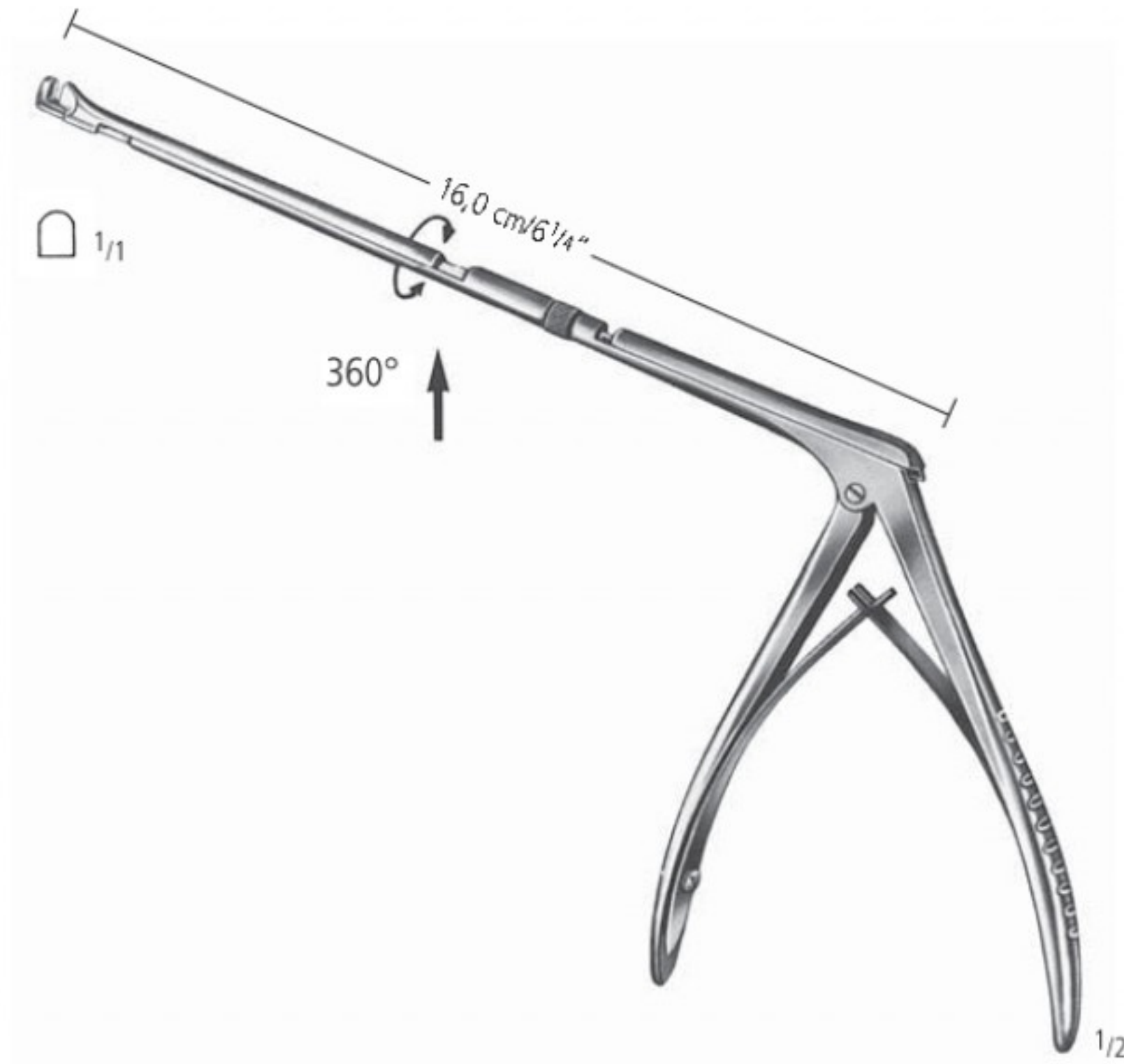

HAJEK-KOFFLER
 KO 274/16

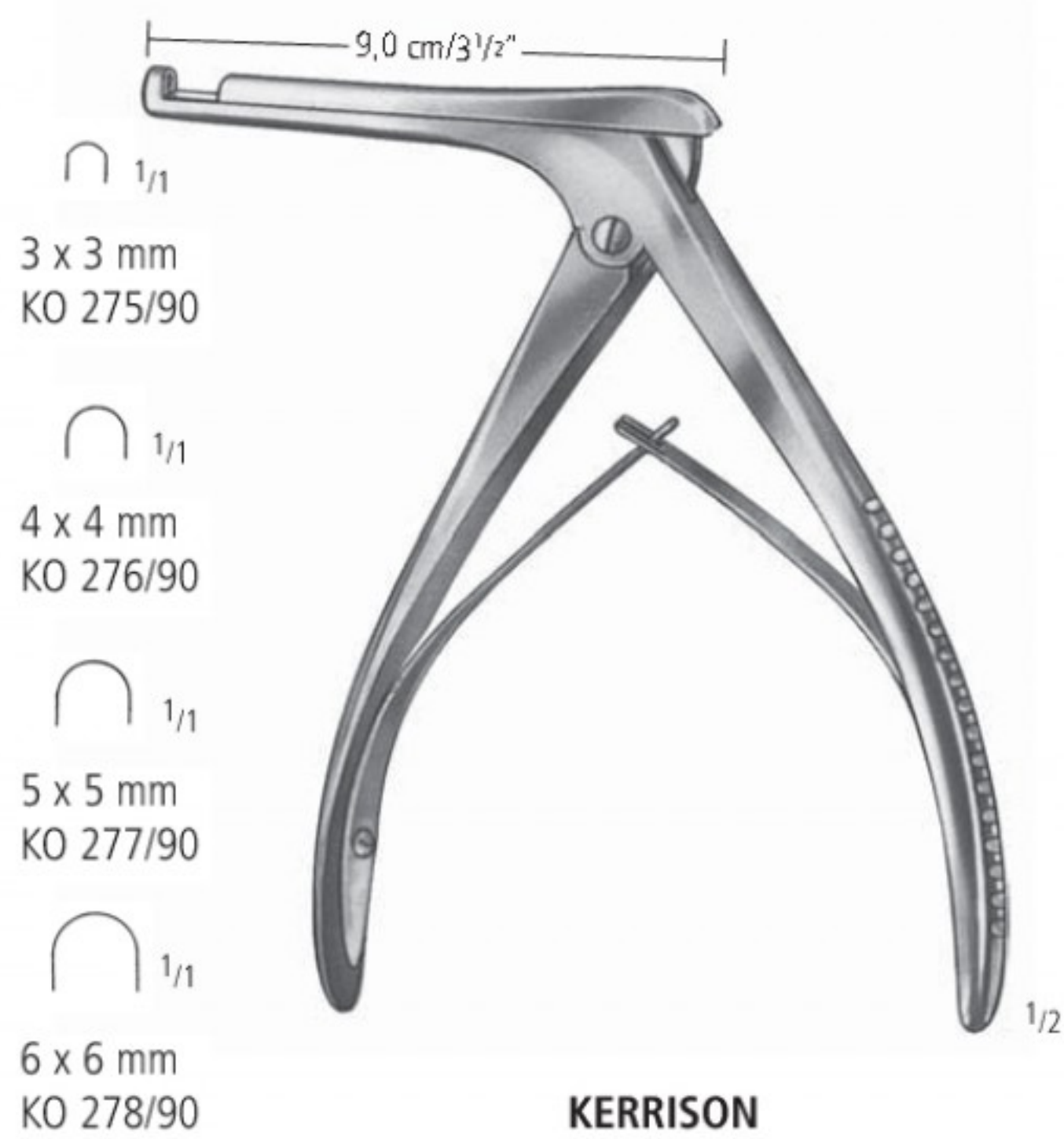

KERRISON

AA
 AB
 AC
 AD
 AE
 AF
 AG
 AH
 AI
 AJ
 AK
 AL
 AM
 AN
 AO
 AP
 AQ
 AR
 AS
 AT
 AU
 AV
 AW
 AX
 AY
 AZ
 BA
 BB
 BC
 BD
 BE
 BF
 BG
 BH
 BI
 BJ
 BK
 BL
 BM
 BN
 BO
 BP
 BQ
 BR
 BS
 BT
 BU
 BV
 BW
 BX
 BY
 BZ
 CA
 CB
 CC
 CD
 CE
 CF
 CG
 CH
 CI
 CJ
 CK
 CL
 CM
 CN
 CO
 CP
 CQ
 CR
 CS
 CT
 CU
 CV
 CW
 CX
 CY
 CZ
 DA
 DB
 DC
 DD
 DE
 DF
 DG
 DH
 DI
 DJ
 DK
 DL
 DM
 DN
 DO
 DP
 DQ
 DR
 DS
 DT
 DU
 DV
 DW
 DX
 DY
 DZ
 EA
 EB
 EC
 ED
 EE
 EF
 EG
 EH
 EI
 EJ
 EK
 EL
 EM
 EN
 EO
 EP
 EQ
 ER
 ES
 ET
 EU
 EV
 EW
 EX
 EY
 EZ
 FA
 FB
 FC
 FD
 FE
 FF
 FG
 FH
 FI
 FJ
 FK
 FL
 FM
 FN
 FO
 FP
 FQ
 FR
 FS
 FT
 FU
 FV
 FW
 FX
 FY
 FZ
 GA
 GB
 GC
 GD
 GE
 GF
 GG
 GH
 GI
 GJ
 GK
 GL
 GM
 GN
 GO
 GP
 GQ
 GR
 GS
 GT
 GU
 GV
 GW
 GX
 GY
 GZ
 HA
 HB
 HC
 HD
 HE
 HF
 HG
 HH
 HI
 HJ
 HK
 HL
 HM
 HN
 HO
 HP
 HQ
 HR
 HS
 HT
 HU
 HV
 HW
 HX
 HY
 HZ
 IA
 IB
 IC
 ID
 IE
 IF
 IG
 IH
 II
 IJ
 IK
 IL
 IM
 IN
 IO
 IP
 IQ
 IR
 IS
 IT
 IU
 IV
 IW
 IX
 IY
 IZ
 JA
 JB
 JC
 JD
 JE
 JF
 JG
 JH
 JI
 JJ
 JK
 JL
 JM
 JN
 JO
 JP
 JQ
 JR
 JS
 JT
 JU
 JV
 JW
 JX
 JY
 JZ
 KA
 KB
 KC
 KD
 KE
 KF
 KG
 KH
 KI
 KJ
 KK
 KL
 KM
 KN
 KO
 KP
 KQ
 KR
 KS
 KT
 KU
 KV
 KW
 KX
 KY
 KZ
 LA
 LB
 LC
 LD
 LE
 LF
 LG
 LH
 LI
 LJ
 LK
 LL
 LM
 LN
 LO
 LP
 LQ
 LR
 LS
 LT
 LU
 LV
 LW
 LX
 LY
 LZ
 MA
 MB
 MC
 MD
 ME
 MF
 MG
 MH
 MI
 MJ
 MK
 ML
 MM
 MN
 MO
 MP
 MQ
 MR
 MS
 MT
 MU
 MV
 MW
 MX
 MY
 MZ
 NA
 NB
 NC
 ND
 NE
 NF
 NG
 NH
 NI
 NJ
 NK
 NL
 NM
 NN
 NO
 NP
 NQ
 NR
 NS
 NT
 NU
 NV
 NW
 NX
 NY
 NZ
 OA
 OB
 OC
 OD
 OE
 OF
 OG
 OH
 OI
 OJ
 OK
 OL
 OM
 ON
 OO
 OP
 OQ
 OR
 OS
 OT
 OU
 OV
 OW
 OX
 OY
 OZ
 PA
 PB
 PC
 PD
 PE
 PF
 PG
 PH
 PI
 PJ
 PK
 PL
 PM
 PN
 PO
 PP
 PQ
 PR
 PS
 PT
 PU
 PV
 PW
 PX
 PY
 PZ
 QA
 QB
 QC
 QD
 QE
 QF
 QG
 QH
 QI
 QJ
 QK
 QL
 QM
 QN
 QO
 QP
 QQ
 QR
 QS
 QT
 QU
 QV
 QW
 QX
 QY
 QZ
 RA
 RB
 RC
 RD
 RE
 RF
 RG
 RH
 RI
 RJ
 RK
 RL
 RM
 RN
 RO
 RP
 RQ
 RR
 RS
 RT
 RU
 RV
 RW
 RX
 RY
 RZ
 SA
 SB
 SC
 SD
 SE
 SF
 SG
 SH
 SI
 SJ
 SK
 SL
 SM
 SN
 SO
 SP
 SQ
 SR
 SS
 ST
 SU
 SV
 SW
 SX
 SY
 SZ
 TA
 TB
 TC
 TD
 TE
 TF
 TG
 TH
 TI
 TJ
 TK
 TL
 TM
 TN
 TO
 TP
 TQ
 TR
 TS
 TT
 TU
 TV
 TW
 TX
 TY
 TZ
 UA
 UB
 UC
 UD
 UE
 UF
 UG
 UH
 UI
 UJ
 UK
 UL
 UM
 UN
 UO
 UP
 UQ
 UR
 US
 UT
 UY
 UZ
 VA
 VB
 VC
 VD
 VE
 VF
 VG
 VH
 VI
 VJ
 VK
 VL
 VM
 VN
 VO
 VP
 VQ
 VR
 VS
 VT
 VU
 VV
 VW
 VX
 VY
 VZ
 WA
 WB
 WC
 WD
 WE
 WF
 WG
 WH
 WI
 WJ
 WK
 WL
 WM
 WN
 WO
 WP
 WQ
 WR
 WS
 WT
 WU
 WV
 WW
 WX
 WY
 WZ
 XA
 XB
 XC
 XD
 XE
 XF
 XG
 XH
 XI
 XJ
 XK
 XL
 XM
 XN
 XO
 XP
 XQ
 XR
 XS
 XT
 XU
 XV
 XW
 XX
 XY
 XZ
 YA
 YB
 YC
 YD
 YE
 YF
 YG
 YH
 YI
 YJ
 YK
 YL
 YM
 YN
 YO
 YP
 YQ
 YR
 YS
 YT
 YU
 YV
 YW
 YX
 YZ
 ZA
 ZB
 ZC
 ZD
 ZE
 ZF
 ZG
 ZH
 ZI
 ZJ
 ZK
 ZL
 ZM
 ZN
 ZO
 ZP
 ZQ
 ZR
 ZS
 ZT
 ZU
 ZV
 ZW
 ZX
 ZY
 ZZ

Weisheitszahnhook
 Third molar hook
 Ganchito retractor de la muela del juicio
 Crochet à dent de sagesse
 Uncino per dente del giudizio



HENAHAN
 20,0 cm/8"



Fig. 1-1
 KA 897/01



Fig. 1-2
 KA 897/02



Fig. 1-3
 KA 897/03



MUND / ZUNGE
MOUTH / TONGUE
BOCA / LENGUA
BOUCHE / LANGUE
BOCCA / LINGUA

KL

nopa[®] instruments



KL MUND MOUTH BOCA BOUCHE BOCCA

Fingerschützer, Mundkeile, Mundsperrer
 Finger Protectors, Oral Wedges, Mouth Gags
 Dedales, Garrotes, Abre-bocas
 Doigtiers, Baillons, Ouvre-bouches
 Ditali, Atribocca



LANGENBECK

KL 015/01 KL 015/02 KL 015/03
 Ø 22,0 mm Ø 24,5 mm Ø 26,5 mm

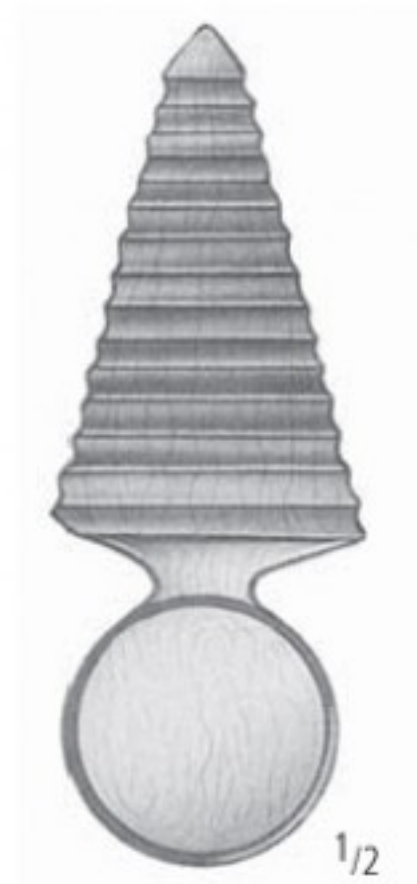

MAUNDER

KL 018/00



PITHA

KL 020/00



HEISTER

KL 030/13
 13,0 cm/5"



MOLT

KL 040/11
 11,0 cm/4 1/2"



MOLT

KL 040/14
 14,0 cm/5 1/2"

MUND MOUTH BOCA BOUCHE BOCCA

Mundsperrer
 Mouth Gags
 Abre-bocas
 Ouvre-bouches
 Apribocca



DENHART

KL 042/12

12,0 cm/4³/₄"



ROSER-KÖNIG

16,0 cm/6¹/₄"

KL 044/16

19,0 cm/7¹/₂"

KL 044/19

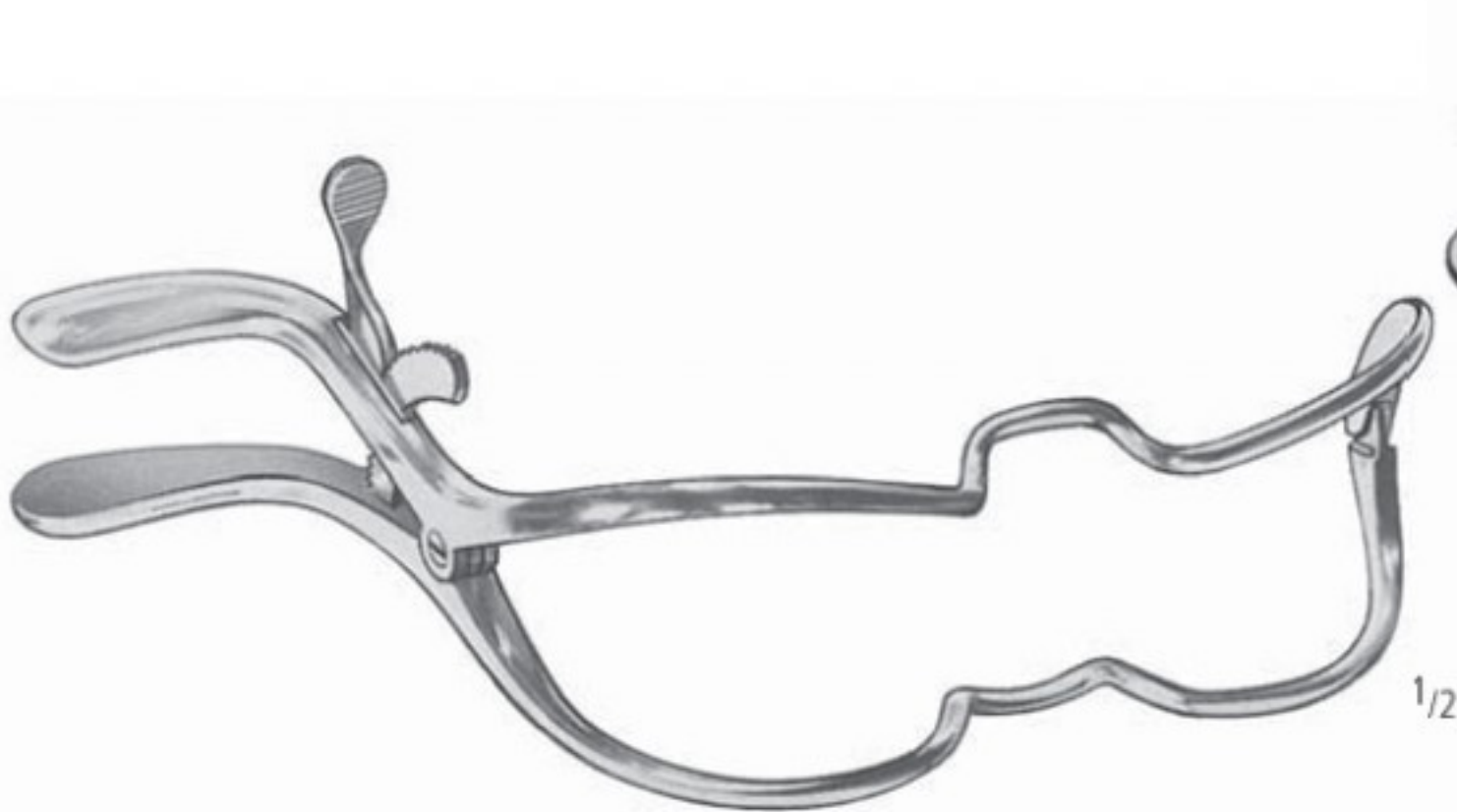

JENNINGS

KL 046/09

KL 046/11

KL 046/13

KL 046/15

9,0 cm/3¹/₂"

11,0 cm/4¹/₂"

13,0 cm/5"

15,0 cm/6"

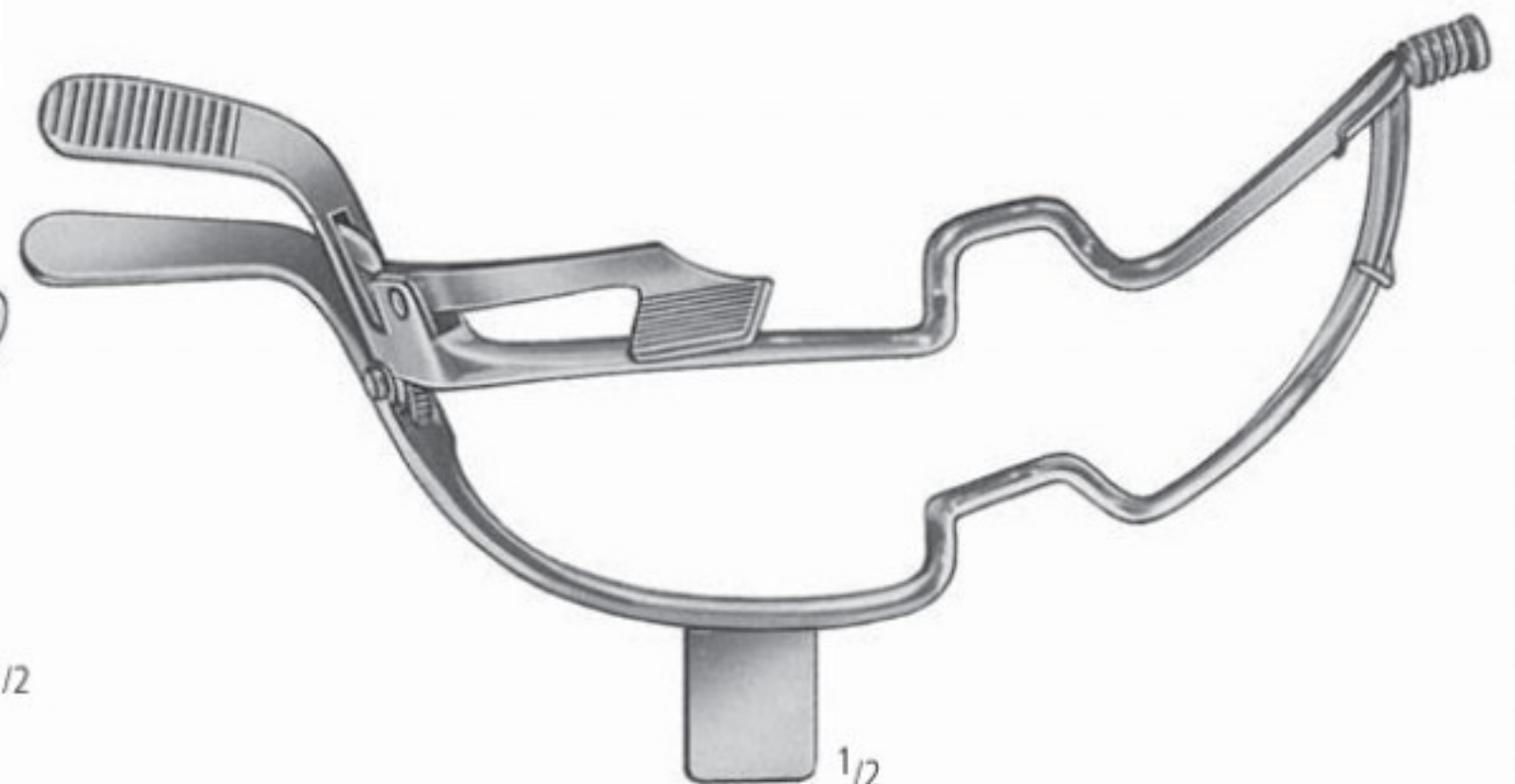

SEEMANN-SEIFFERT

KL 047/09

KL 047/11

KL 047/13

KL 047/15

AA
 AB
 AC
 AD
 AE
 AF
 AG
 AH
 AI
 AJ
 AK
 AL
 AM
 AN
 AO
 AP
 AQ
 AR
 AS
 AT
 AU
 AV
 AW
 AX
 AY
 AZ
 BA
 BB
 BC
 BD
 BE
 BF
 BG
 BH
 BI
 BJ
 BK
 BL
 BM
 BN
 BO
 BP
 BQ
 BR
 BS
 BT
 BU
 BV
 BW
 BX
 BY
 BZ
 CA
 CB
 CC
 CD
 CE
 CF
 CG
 CH
 CI
 CJ
 CK
 CL
 CM
 CN
 CO
 CP
 CQ
 CR
 CS
 CT
 CU
 CV
 CW
 CX
 CY
 CZ
 DA
 DB
 DC
 DD
 DE
 DF
 DG
 DH
 DI
 DJ
 DK
 DL
 DM
 DN
 DO
 DP
 DQ
 DR
 DS
 DT
 DU
 DV
 DW
 DX
 DY
 DZ
 EA
 EB
 EC
 ED
 EE
 EF
 EG
 EH
 EI
 EJ
 EK
 EL
 EM
 EN
 EO
 EP
 EQ
 ER
 ES
 ET
 EU
 EV
 EW
 EX
 EY
 EZ
 FA
 FB
 FC
 FD
 FE
 FF
 FG
 FH
 FI
 FJ
 FK
 FL
 FM
 FN
 FO
 FP
 FQ
 FR
 FS
 FT
 FU
 FV
 FW
 FX
 FY
 FZ
 GA
 GB
 GC
 GD
 GE
 GF
 GG
 GH
 GI
 GJ
 GK
 GL
 GM
 GN
 GO
 GP
 GQ
 GR
 GS
 GT
 GU
 GV
 GW
 GX
 GY
 GZ
 HA
 HB
 HC
 HD
 HE
 HF
 HG
 HH
 HI
 HJ
 HK
 HL
 HM
 HN
 HO
 HP
 HQ
 HR
 HS
 HT
 HU
 HV
 HW
 HX
 HY
 HZ
 IA
 IB
 IC
 ID
 IE
 IF
 IG
 IH
 II
 IJ
 IK
 IL
 IM
 IN
 IO
 IP
 IQ
 IR
 IS
 IT
 IU
 IV
 IW
 IX
 IY
 IZ
 JA
 JB
 JC
 JD
 JE
 JF
 JG
 JH
 JI
 JJ
 JK
 JL
 JM
 JN
 JO
 JP
 JQ
 JR
 JS
 JT
 JU
 JV
 JW
 JX
 JY
 JZ
 KA
 KB
 KC
 KD
 KE
 KF
 KG
 KH
 KI
 KJ
 KK
 KL
 KM
 KN
 KO
 KP
 KQ
 KR
 KS
 KT
 KU
 KV
 KW
 KX
 KY
 KZ
 LA
 LB
 LC
 LD
 LE
 LF
 LG
 LH
 LI
 LJ
 LK
 LL
 LM
 LN
 LO
 LP
 LQ
 LR
 LS
 LT
 LU
 LV
 LW
 LX
 LY
 LZ
 MA
 MB
 MC
 MD
 ME
 MF
 MG
 MH
 MI
 MJ
 MK
 ML
 MM
 MN
 MO
 MP
 MQ
 MR
 MS
 MT
 MU
 MV
 MW
 MX
 MY
 MZ
 NA
 NB
 NC
 ND
 NE
 NF
 NG
 NH
 NI
 NJ
 NK
 NL
 NM
 NN
 NO
 NP
 NQ
 NR
 NS
 NT
 NU
 NV
 NW
 NX
 NY
 NZ
 OA
 OB
 OC
 OD
 OE
 OF
 OG
 OH
 OI
 OJ
 OK
 OL
 OM
 ON
 OO
 OP
 OQ
 OR
 OS
 OT
 OU
 OV
 OW
 OX
 OY
 OZ
 PA
 PB
 PC
 PD
 PE
 PF
 PG
 PH
 PI
 PJ
 PK
 PL
 PM
 PN
 PO
 PP
 PQ
 PR
 PS
 PT
 PU
 PV
 PW
 PX
 PY
 PZ
 QA
 QB
 QC
 QD
 QE
 QF
 QG
 QH
 QI
 QJ
 QK
 QL
 QM
 QN
 QO
 QP
 QQ
 QR
 QS
 QT
 QU
 QV
 QW
 QX
 QY
 QZ
 RA
 RB
 RC
 RD
 RE
 RF
 RG
 RH
 RI
 RJ
 RK
 RL
 RM
 RN
 RO
 RP
 RQ
 RR
 RS
 RT
 RU
 RV
 RW
 RX
 RY
 RZ
 SA
 SB
 SC
 SD
 SE
 SF
 SG
 SH
 SI
 SJ
 SK
 SL
 SM
 SN
 SO
 SP
 SQ
 SR
 SS
 ST
 SU
 SV
 SW
 SX
 SY
 SZ
 TA
 TB
 TC
 TD
 TE
 TF
 TG
 TH
 TI
 TJ
 TK
 TL
 TM
 TN
 TO
 TP
 TQ
 TR
 TS
 TT
 TU
 TV
 TW
 TX
 TY
 TZ
 UA
 UB
 UC
 UD
 UE
 UF
 UG
 UH
 UI
 UJ
 UK
 UL
 UM
 UN
 UO
 UP
 UQ
 UR
 US
 UT
 UU
 UV
 UW
 UX
 UY
 UZ
 VA
 VB
 VC
 VD
 VE
 VF
 VG
 VH
 VI
 VJ
 VK
 VL
 VM
 VN
 VO
 VP
 VQ
 VR
 VS
 VT
 VU
 VV
 VW
 VX
 VY
 VZ
 WA
 WB
 WC
 WD
 WE
 WF
 WG
 WH
 WI
 WJ
 WK
 WL
 WM
 WN
 WO
 WP
 WQ
 WR
 WS
 WT
 WU
 WV
 WW
 WX
 WY
 WZ
 XA
 XB
 XC
 XD
 XE
 XF
 XG
 XH
 XI
 XJ
 XK
 XL
 XM
 XN
 XO
 XP
 XQ
 XR
 XS
 XT
 XU
 XV
 XW
 XX
 XY
 XZ
 YA
 YB
 YC
 YD
 YE
 YF
 YG
 YH
 YI
 YJ
 YK
 YL
 YM
 YN
 YO
 YP
 YQ
 YR
 YS
 YT
 YU
 YV
 YW
 YX
 YY
 YZ
 ZA
 ZB
 ZC
 ZD
 ZE
 ZF
 ZG
 ZH
 ZI
 ZJ
 ZK
 ZL
 ZM
 ZN
 ZO
 ZP
 ZQ
 ZR
 ZS
 ZT
 ZU
 ZV
 ZW
 ZX
 ZY
 ZZ

KL MUND MOUTH BOCA BOUCHE BOCCA

Mundsperrer
Mouth Gags
Abre-bocas
Ouvre-bouches
Apribocca

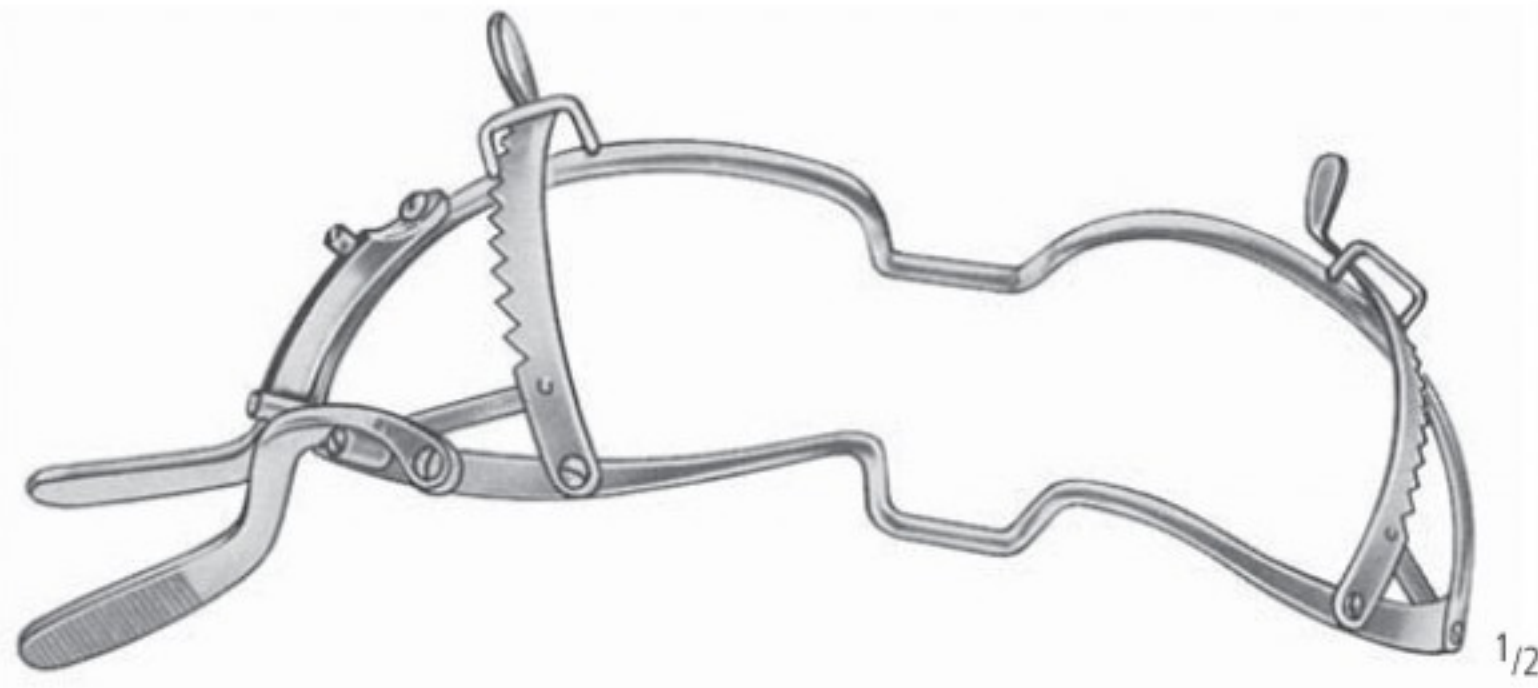

WHITEHEAD

KL 048/11
KL 048/13
KL 048/15

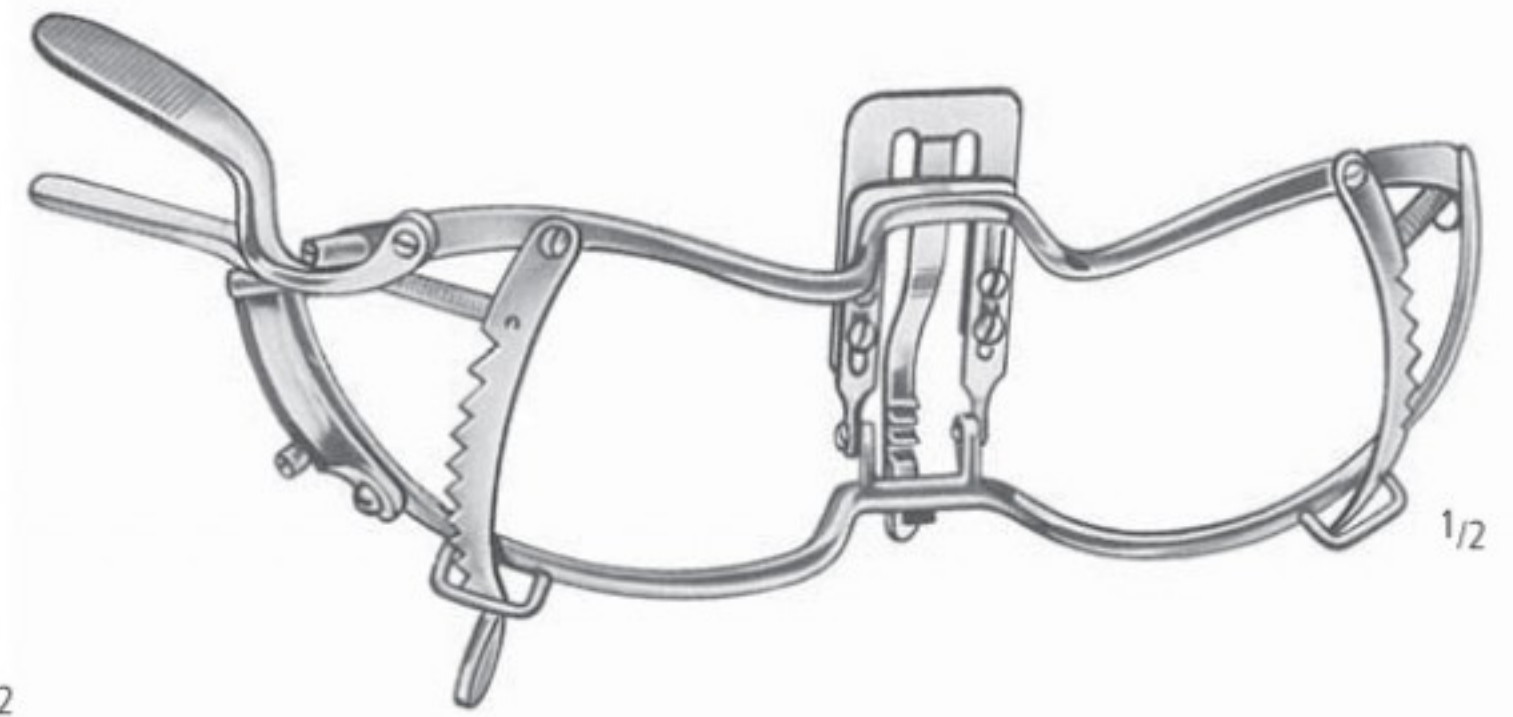

WHITEHEAD

KL 049/11
KL 049/13
KL 049/15

11,0 cm/4¹/₃"
13,0 cm/5"
15,0 cm/6"

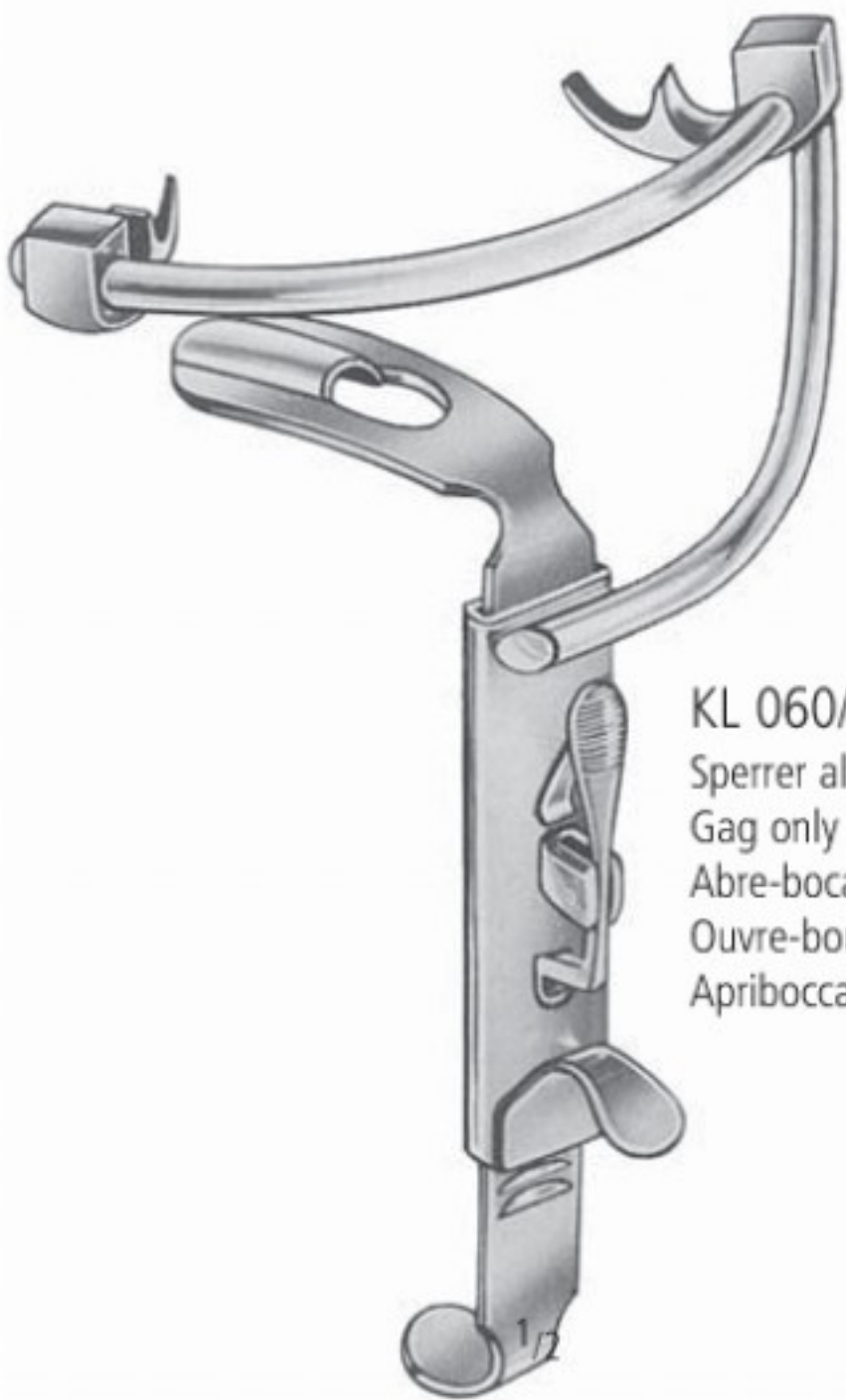

KILNER-DOUGHTY

KL 060/00

komplett
complete
completo
complet
completo

KL 060/04
Sperrer alleine
Gag only
Abre-boca suelto
Ouvre-bouche seul
Apribocca solo



Fig. 1
KL 060/01
65x28 mm



Fig. 2
KL 060/02
75x32 mm



Fig. 3
KL 060/03
80x37 mm



KL 060/08

MUND MOUTH BOCA BOUCHE BOCCA

Mundsperrer
Mouth Gags
Abre-bocas
Ouvre-bouches
Apribocca



Fig. 1
KL 061/01
55x25 mm



Fig. 2
KL 061/02
60x27 mm



Fig. 3
KL 061/03
70x30 mm

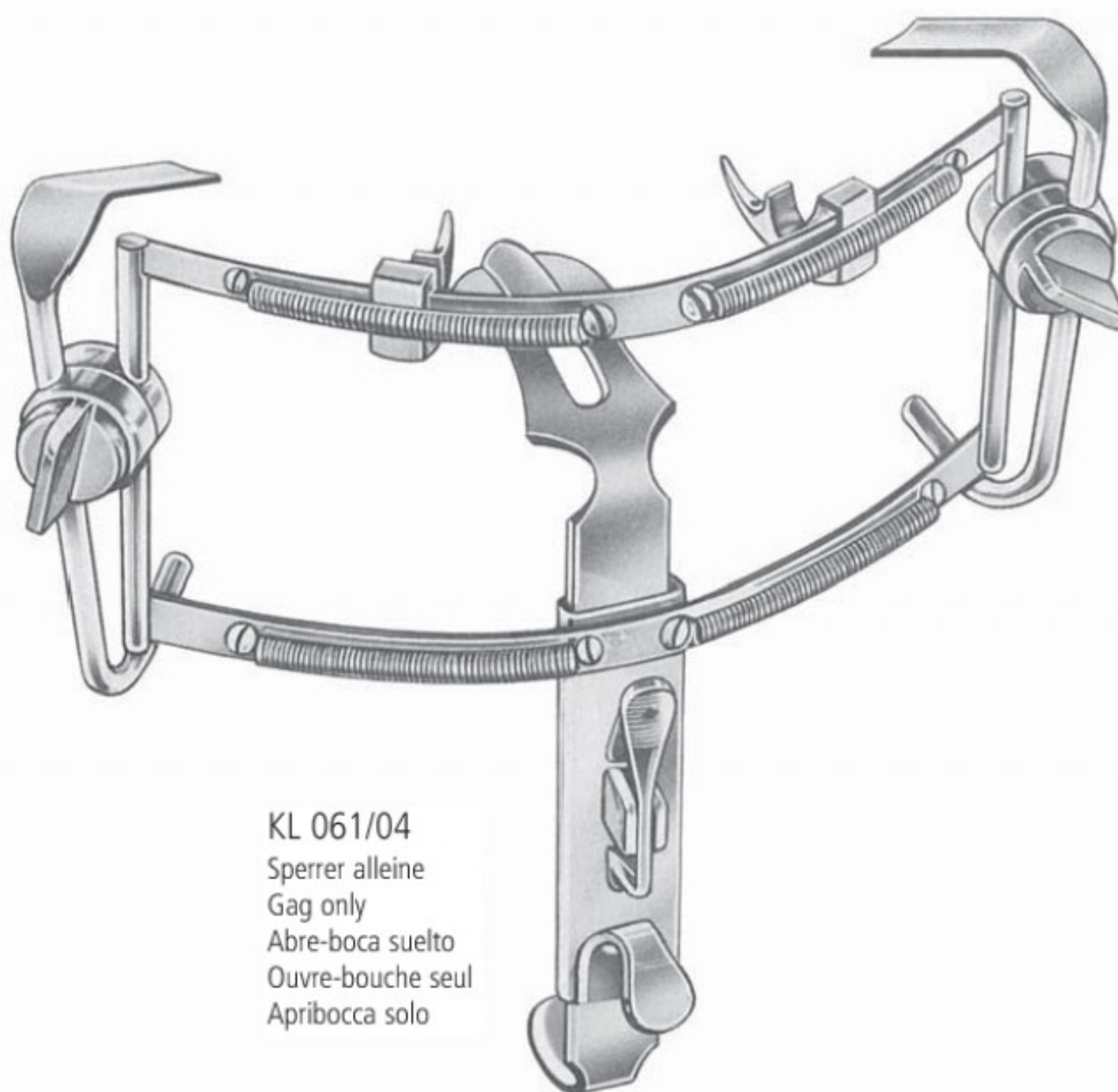

KL 061/04
Sperrer alleine
Gag only
Abre-boca suelto
Ouvre-bouche seul
Apribocca solo

DINGMANN

KL 061/00
komplett
complete
completo
complet
completo



KL 064/06
Sperrer alleine
Gag only
Abre-boca suelto
Ouvre-bouche seul
Apribocca solo



Fig. 1
KL 064/01
105x27 mm



Fig. 2
KL 064/02
90x25 mm



Fig. 3
KL 064/03
75x25 mm



Fig. 4
KL 064/04
60x22 mm



Fig. 5
KL 064/05
25x20 mm

DAVIS-BOYLE

KL 064/00
komplett
complete
completo
complet
completo

AA
AB
AC
AD
AE
AF
AK
AL
AO
AR
KA
KL
KU
PA
PB
PF
PI
PK
PL
PM
PP
PS
PT
PU
PV
KYE

KL MUND MOUTH BOCA BOUCHE BOCCA

Mundsperrer
 Mouth Gags
 Abre-bocas
 Ouvre-bouches
 Apribocca



KL 066/04
 Sperrer alleine
 Gag only
 Abre-boca suelto
 Ouvre-bouche seul
 Apribocca solo

MC IVOR
KL 066/00
 komplett
 complete
 completo
 complet
 completo



Fig. 1
KL 066/01
 95x27 mm



Fig. 2
KL 066/02
 85x22 mm



Fig. 3
KL 066/03
 70x22 mm



MODELL WÜRZBURG

Fig.		
1	66x28 mm	KL 068/01
2	75x32 mm	KL 068/02
3	83x34 mm	KL 068/03
4	93x37 mm	KL 068/04
5	100x38 mm	KL 068/05



NEGUS
KL 072/00

ZUNGE TONGUE LENGUA LANGUE LINGUA

Mundkeile
 Oral Wedges
 Garrotes
 Baïllons
 Apribocca

für Erwachsene
 for adults
 para adultos
 pour adultes
 per adulti

für Kinder
 for children
 para niños
 pour enfants
 per bambini



1/2

McKESSON
 KL 080/00-04

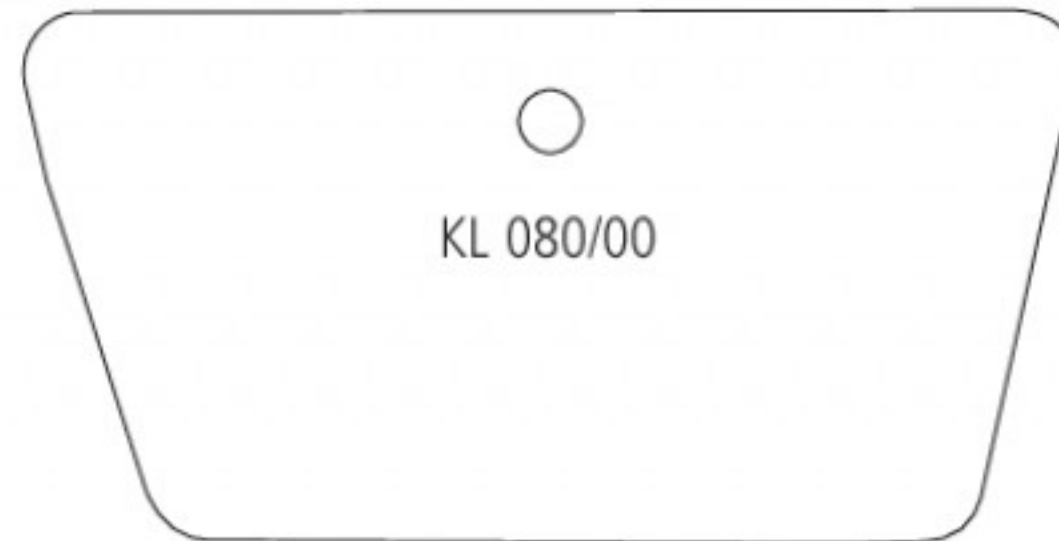

KL 080/00

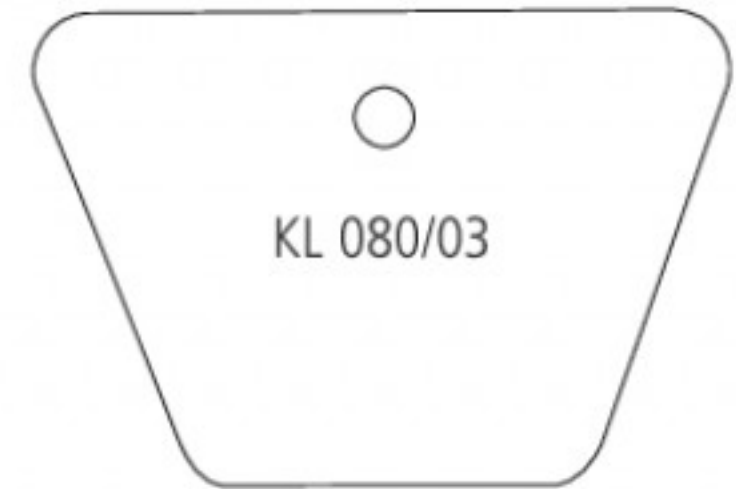

KL 080/03

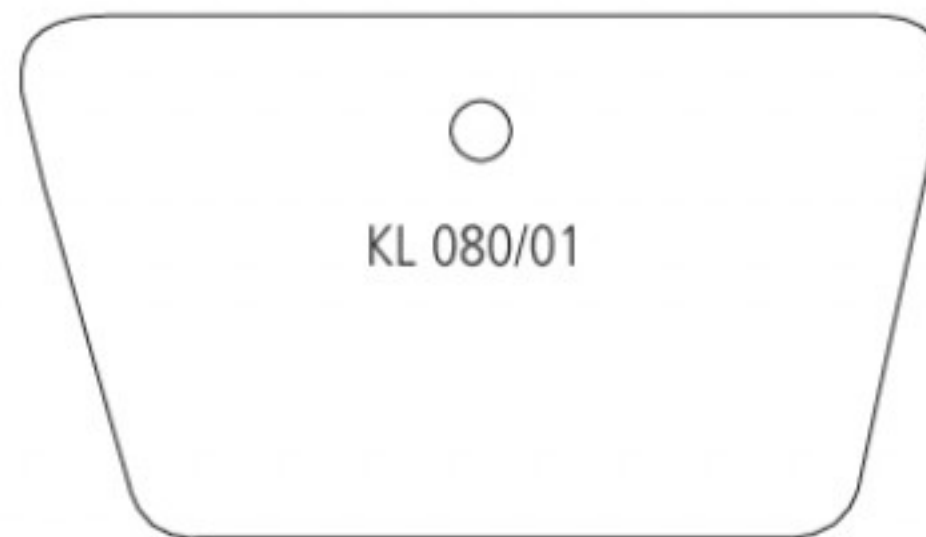

KL 080/01

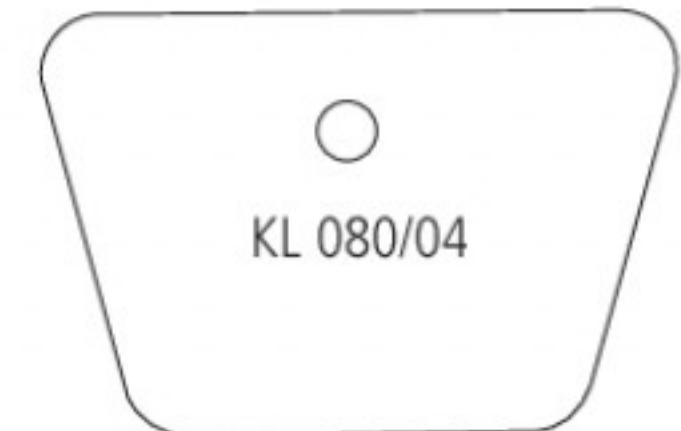

KL 080/04



KL 080/02



1/2

McKESSON
 KL 082/01-04



KL 082/01

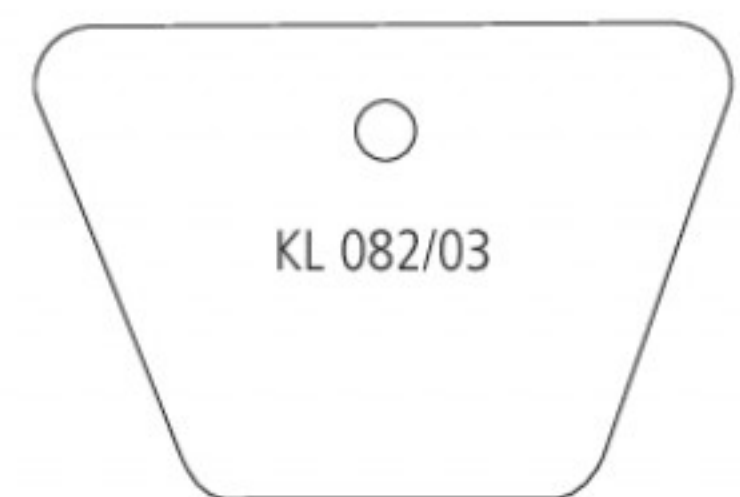

KL 082/03

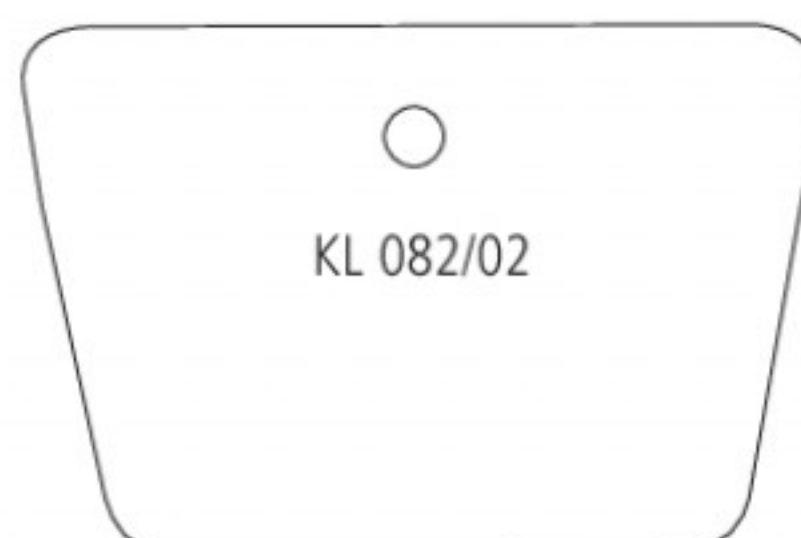

KL 082/02

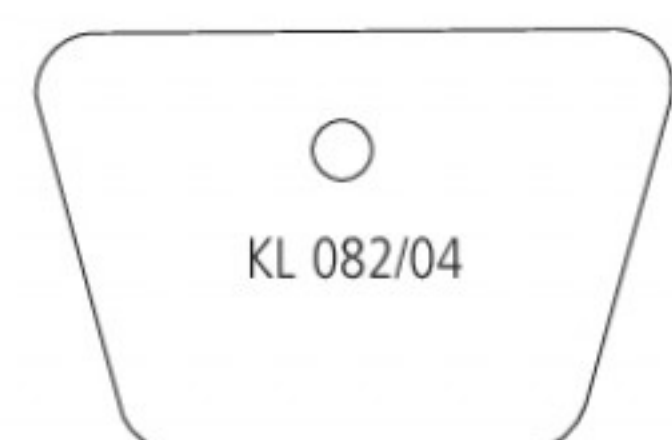

KL 082/04

AA AB AC AD AE AF AG AH AI AJ AK AL AM AN AO AP AQ AR AS AT AU AV AW AX AY AZ
 BA BB BC BD BE BF BG BH BI BJ BK BL BM BN BO BP BQ BR BS BT BU BV BW BX BY BZ
 CA CB CC CD CE CF CG CH CI CJ CK CL CM CN CO CP CQ CR CS CT CU CV CW CX CY CZ
 DA DB DC DD DE DF DG DH DI DJ DK DL DM DN DO DP DQ DR DS DT DU DV DW DX DY DZ
 EA EB EC ED EE EF EG EH EI EJ EK EL EM EN EO EP EQ ER ES ET EU EV EW EX EY EZ
 FA FB FC FD FE FF FG FH FI FJ FK FL FM FN FO FP FQ FR FS FT FU FV FW FX FY FZ
 GA GB GC GD GE GF GG GH GI GJ GK GL GM GN GO GP GQ GR GS GT GU GV GW GX GY GZ
 HA HB HC HD HE HF HG HH HI HJ HK HL HM HN HO HP HQ HR HS HT HU HV HW HX HY HZ
 IA IB IC ID IE IF IG IH II IJ IK IL IM IN IO IP IQ IR IS IT IU IV IW IX IY IZ
 JA JB JC JD JE JF JG JH JI JJ JK JL JM JN JO JP JQ JR JS JT JU JV JW JX JY JZ
 KA KB KC KD KE KF KG KH KI KJ KK KL KM KN KO KP KQ KR KS KT KU KV KW KX KY KZ
 LA LB LC LD LE LF LG LH LI LJ LK LL LM LN LO LP LQ LR LS LT LU LV LW LX LY LZ
 MA MB MC MD ME MF MG MH MI MJ MK ML MN MO MP MQ MR MS MT MU MV MW MX MY MZ
 NA NB NC ND NE NF NG NH NI NJ NK NL NM NO NP NQ NR NS NT NU NV NW NX NY NZ
 OA OB OC OD OE OF OG OH OI OJ OK OL OM ON OO OP OQ OR OS OT OU OV OW OX OY OZ
 PA PB PC PD PE PF PG PH PI PJ PK PL PM PN PO PP PQ PR PS PT PU PV PW PX PY PZ
 QA QB QC QD QE QF QG QH QI QJ QK QL QM QN QO QP QQ QR QS QT QU QV QW QX QY QZ
 RA RB RC RD RE RF RG RH RI RJ RK RL RM RN RO RP RQ RR RS RT RU RV RW RX RY RZ
 SA SB SC SD SE SF SG SH SI SJ SK SL SM SN SO SP SQ SR SS ST SU SV SW SX SY SZ
 TA TB TC TD TE TF TG TH TI TJ TK TL TM TN TO TP TQ TR TS TT TU TV TW TX TY TZ
 UA UB UC UD UE UF UG UH UI UJ UK UL UM UN UO UP UQ UR US UT UU UV UW UX UY UZ
 VA VB VC VD VE VF VG VH VI VJ VK VL VM VN VO VP VQ VR VS VT VU VV VW VX VY VZ
 WA WB WC WD WE WF WG WH WI WJ WK WL WM WN WO WP WQ WR WS WT WU WV WW WX WY WZ
 XA XB XC XD XE XF XG XH XI XJ XK XL XM XN XO XP XQ XR XS XT XU XV XW XX XY XZ
 YA YB YC YD YE YF YG YH YI YJ YK YL YM YN YO YP YQ YR YS YT YU YV YW YX YY YZ
 ZA ZB ZC ZD ZE ZF ZG ZH ZI ZJ ZK ZL ZM ZN ZO ZP ZQ ZR ZS ZT ZU ZV ZW ZX ZY ZZ

KL ZUNGE TONGUE LENGUA LANGUE LINGUA

Wangen- und Lippenhalter, Zungendrücker
 Cheek and Lip Retractors, Tongue Depressors
 Separadores para mejillas y labios, Abaja-lenguas
 Ecarteurs des joues et des lèvres, Abaisse-langues
 Divaricatori per guancie e labbra, Abbassalingua



SIMPLEX
 KL 100/11
 11,0 cm/4¹/₃"



STERNBERG
 KL 105/12 = 12,0 cm/4³/₄"
 KL 105/14 = 14,0 cm/5¹/₂"
 KL 105/16 = 16,0 cm/6¹/₄"



TOBOLD
 KL 112/14
 14,5 cm/5³/₄"



HARTMANN
 KL 114/15
 15,0 cm/6"



MORITZ-SCHMIDT
 KL 116/19
 19,0 cm/7¹/₂"



WIEDER
 14,5 cm/5³/₄"

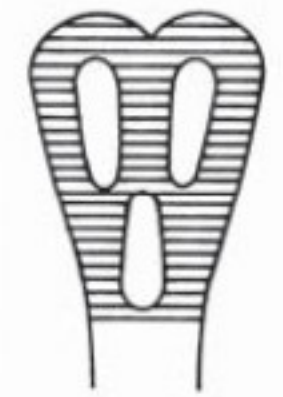

KL 120/14
 28 mm

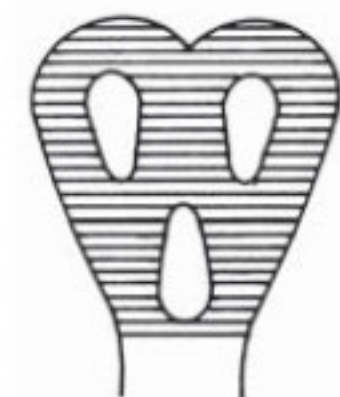

KL 120/15
 32 mm

ZUNGE TONGUE LENGUA LANGUE LINGUA

Wangen- und Lippenhalter, Zungendrucker
 Cheek and Lip Retractors, Tongue Depressors
 Separadores para mejillas y labios, Abaja-lenguas
 Ecarteurs des joues et des lèvres, Abaisse-langues
 Divaricatori per guancie e labbra, Abbassalingua



KL 122/19
 19,0 cm/7¹/₂"



STANDARD
 KL 124/14
 14,5 cm/5³/₄"



UNIV. MINNESOTA
 KL 125/14
 14,0 cm/5¹/₂"



KROENIG
 KL 126/15
 15,0 cm/6"



MAYO
 KL 128/17
 17,0 cm/6³/₄"



BRUENINGS
 KL 130/19
 19,0 cm/7¹/₂"



FRENZEL
 KL 131/16
 16,5 cm/6¹/₂"



KL 132/18
 18,0 cm/7"

AA
 AB
 AC
 AD
 AE
 AF
 AG
 AH
 AI
 AJ
 AK
 AL
 AO
 AP
 AQ
 AR
 AS
 AT
 AU
 AV
 AW
 AX
 AY
 AZ
 BA
 BB
 BC
 BD
 BE
 BF
 BG
 BH
 BI
 BJ
 BK
 BL
 BM
 BN
 BO
 BP
 BQ
 BR
 BS
 BT
 BU
 BV
 BW
 BX
 BY
 BZ
 CA
 CB
 CC
 CD
 CE
 CF
 CG
 CH
 CI
 CJ
 CK
 CL
 CM
 CN
 CO
 CP
 CQ
 CR
 CS
 CT
 CU
 CV
 CW
 CX
 CY
 CZ
 DA
 DB
 DC
 DD
 DE
 DF
 DG
 DH
 DI
 DJ
 DK
 DL
 DM
 DN
 DO
 DP
 DQ
 DR
 DS
 DT
 DU
 DV
 DW
 DX
 DY
 DZ
 EA
 EB
 EC
 ED
 EE
 EF
 EG
 EH
 EI
 EJ
 EK
 EL
 EM
 EN
 EO
 EP
 EQ
 ER
 ES
 ET
 EU
 EV
 EW
 EX
 EY
 EZ
 FA
 FB
 FC
 FD
 FE
 FF
 FG
 FH
 FI
 FJ
 FK
 FL
 FM
 FN
 FO
 FP
 FQ
 FR
 FS
 FT
 FU
 FV
 FW
 FX
 FY
 FZ
 GA
 GB
 GC
 GD
 GE
 GF
 GG
 GH
 GI
 GJ
 GK
 GL
 GM
 GN
 GO
 GP
 GQ
 GR
 GS
 GT
 GU
 GV
 GW
 GX
 GY
 GZ
 HA
 HB
 HC
 HD
 HE
 HF
 HG
 HH
 HI
 HJ
 HK
 HL
 HM
 HN
 HO
 HP
 HQ
 HR
 HS
 HT
 HU
 HV
 HW
 HX
 HY
 HZ
 IA
 IB
 IC
 ID
 IE
 IF
 IG
 IH
 II
 IJ
 IK
 IL
 IM
 IN
 IO
 IP
 IQ
 IR
 IS
 IT
 IU
 IV
 IW
 IX
 IY
 IZ
 JA
 JB
 JC
 JD
 JE
 JF
 JG
 JH
 JI
 JJ
 JK
 JL
 JM
 JN
 JO
 JP
 JQ
 JR
 JS
 JT
 JU
 JV
 JW
 JX
 JY
 JZ
 KA
 KB
 KC
 KD
 KE
 KF
 KG
 KH
 KI
 KJ
 KK
 KL
 KM
 KN
 KO
 KP
 KQ
 KR
 KS
 KT
 KU
 KV
 KW
 KX
 KY
 KZ
 LA
 LB
 LC
 LD
 LE
 LF
 LG
 LH
 LI
 LJ
 LK
 LL
 LM
 LN
 LO
 LP
 LQ
 LR
 LS
 LT
 LU
 LV
 LW
 LX
 LY
 LZ
 MA
 MB
 MC
 MD
 ME
 MF
 MG
 MH
 MI
 MJ
 MK
 ML
 MM
 MN
 MO
 MP
 MQ
 MR
 MS
 MT
 MU
 MV
 MW
 MX
 MY
 MZ
 NA
 NB
 NC
 ND
 NE
 NF
 NG
 NH
 NI
 NJ
 NK
 NL
 NM
 NN
 NO
 NP
 NQ
 NR
 NS
 NT
 NU
 NV
 NW
 NX
 NY
 NZ
 OA
 OB
 OC
 OD
 OE
 OF
 OG
 OH
 OI
 OJ
 OK
 OL
 OM
 ON
 OO
 OP
 OQ
 OR
 OS
 OT
 OU
 OV
 OW
 OX
 OY
 OZ
 PA
 PB
 PC
 PD
 PE
 PF
 PG
 PH
 PI
 PJ
 PK
 PL
 PM
 PN
 PO
 PP
 PQ
 PR
 PS
 PT
 PU
 PV
 PW
 PX
 PY
 PZ
 QA
 QB
 QC
 QD
 QE
 QF
 QG
 QH
 QI
 QJ
 QK
 QL
 QM
 QN
 QO
 QP
 QQ
 QR
 QS
 QT
 QU
 QV
 QW
 QX
 QY
 QZ
 RA
 RB
 RC
 RD
 RE
 RF
 RG
 RH
 RI
 RJ
 RK
 RL
 RM
 RN
 RO
 RP
 RQ
 RR
 RS
 RT
 RU
 RV
 RW
 RX
 RY
 RZ
 SA
 SB
 SC
 SD
 SE
 SF
 SG
 SH
 SI
 SJ
 SK
 SL
 SM
 SN
 SO
 SP
 SQ
 SR
 SS
 ST
 SU
 SV
 SW
 SX
 SY
 SZ
 TA
 TB
 TC
 TD
 TE
 TF
 TG
 TH
 TI
 TJ
 TK
 TL
 TM
 TN
 TO
 TP
 TQ
 TR
 TS
 TT
 TU
 TV
 TW
 TX
 TY
 TZ
 UA
 UB
 UC
 UD
 UE
 UF
 UG
 UH
 UI
 UJ
 UK
 UL
 UM
 UN
 UO
 UP
 UQ
 UR
 US
 UT
 UU
 UV
 UW
 UX
 UY
 UZ
 VA
 VB
 VC
 VD
 VE
 VF
 VG
 VH
 VI
 VJ
 VK
 VL
 VM
 VN
 VO
 VP
 VQ
 VR
 VS
 VT
 VU
 VV
 VW
 VX
 VY
 VZ
 WA
 WB
 WC
 WD
 WE
 WF
 WG
 WH
 WI
 WJ
 WK
 WL
 WM
 WN
 WO
 WP
 WQ
 WR
 WS
 WT
 WU
 WV
 WW
 WX
 WY
 WZ
 XA
 XB
 XC
 XD
 XE
 XF
 XG
 XH
 XI
 XJ
 XK
 XL
 XM
 XN
 XO
 XP
 XQ
 XR
 XS
 XT
 XU
 XV
 XW
 XX
 XY
 XZ
 YA
 YB
 YC
 YD
 YE
 YF
 YG
 YH
 YI
 YJ
 YK
 YL
 YM
 YN
 YO
 YP
 YQ
 YR
 YS
 YT
 YU
 YV
 YW
 YX
 YZ
 ZA
 ZB
 ZC
 ZD
 ZE
 ZF
 ZG
 ZH
 ZI
 ZJ
 ZK
 ZL
 ZM
 ZN
 ZO
 ZP
 ZQ
 ZR
 ZS
 ZT
 ZU
 ZV
 ZW
 ZX
 ZY
 ZZ

KL ZUNGE TONGUE LENGUA LANGUE LINGUA

Zungenzangen, Dissektoren, Tamponstopfer
 Tongue Holding Forceps, Dissectors, Gauze packers
 Pinzas tira-lengua, Disecadores, Taponeadores
 Pincas tire-langue, Dissecteurs, Porte-tampon
 Pinze tiralingua, Dissettori, Tamponatori



COLLIN
 KL 140/16
 16,0 cm/6¹/₄"



YOUNG
 KL 144/17
 17,0 cm/6³/₄"

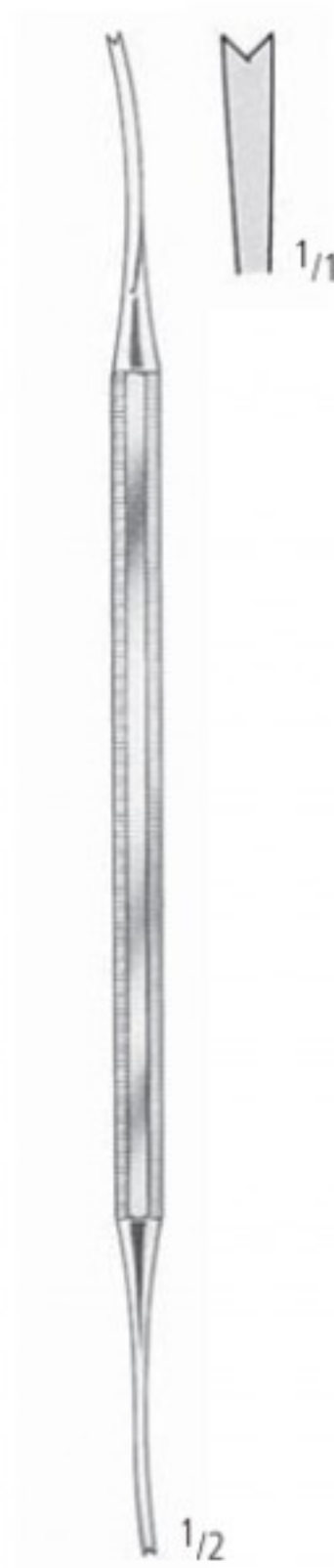

LUNIATSCHECK
 KL 262/19
 19,0 cm/7¹/₂"

MUND MOUTH BOCA BOUCHE BOCCA

Mundspiegelgriffe
 Mouth mirror handles
 Mangos para espejos de boca
 Manches pour miroirs à bouche
 Manici per specchietti



1/1

SECCO

KL 506/01
 14,0 cm/5 1/2"



1/1

KL 507/12
 12,0 cm/4 3/4"



1/1

KL 508/12
 12,0 cm/4 3/4"
 Ø 6 mm



1/1

KL 509/14
 14,0 cm/5 1/2"
 Ø 8 mm



1/1

KL 509/24
 14,0 cm/5 1/2"
 Ø 11 mm



1/1

KL 510/12
 12,0 cm/4 3/4"

AA AB AC AD AE AF AK AL AO AR KA **KL** KU PA PB PF PI PK PL PM PP PS PT PU PV KYE

KL MUND MOUTH BOCA BOUCHE BOCCA

Mundspiegelansätze
 Mouth mirrors
 Espejos de boca
 Mirrors à bouche
 Specchietti



Verpackungseinheit / packing unit 12 St./pc.

HILGER
 KL 513/02

Größe	plan, metr. Gewinde	metr. Gewinde, hohl
Size	plane, metr. thread	metr. thread, concave
Tamaño	plano, rosca métrica	rosca métrica, cóncavo
Taille	plan, filetage métrique	filetage métrique
Dimens.	piano, filettatura metrica	filettatura metrica, cavo

Ø mm

22	4
24	5

KL 511/04
KL 511/05

KL 512/04
KL 512/05

VERSCHIEDENES
VARIOUS ITEMS
DIVERSOS ARTICULOS
ARTICLES DIVERS
ARTICOLI DIVERSI

KU

nopa[®] instruments





KU 295/01
Ø 130 mm

KU 295/02
Ø 130 mm

Weichgummi
soft rubber
goma blanda
caoutchouc mou
gomma morbida

Kunststoff
plastic
plástico
plastique
plastica



Ø x h		
40 x 19 mm	0,05 l	KU 300/04
61 x 30 mm	0,07 l	KU 300/06
80 x 40 mm	0,14 l	KU 300/08
116 x 50 mm	0,35 l	KU 300/11
128 x 55 mm	0,45 l	KU 300/12
147 x 65 mm	0,70 l	KU 300/14



KU 301/01 = 0,25 l
KU 301/02 = 0,50 l
KU 301/03 = 1,00 l
KU 301/04 = 2,00 l



L = 170 mm	KU 302/17
L = 250 mm	KU 302/25
L = 275 mm	KU 302/27



KU 303/00
Ø = 65 mm



KU 304/50 = 50 x 25 x 4,5 mm
KU 304/65 = 65 x 42 x 8,0 mm
KU 304/75 = 75 x 25 x 4,5 mm



KU 306/15 = 150 x 95 x 13 mm



l x b x h	
230 x 155 x 30 mm	KU 307/23
300 x 175 x 30 mm	KU 307/30
300 x 175 x 40 mm	KU 308/30
350 x 240 x 36 mm	KU 308/35
400 x 300 x 50 mm	KU 308/50

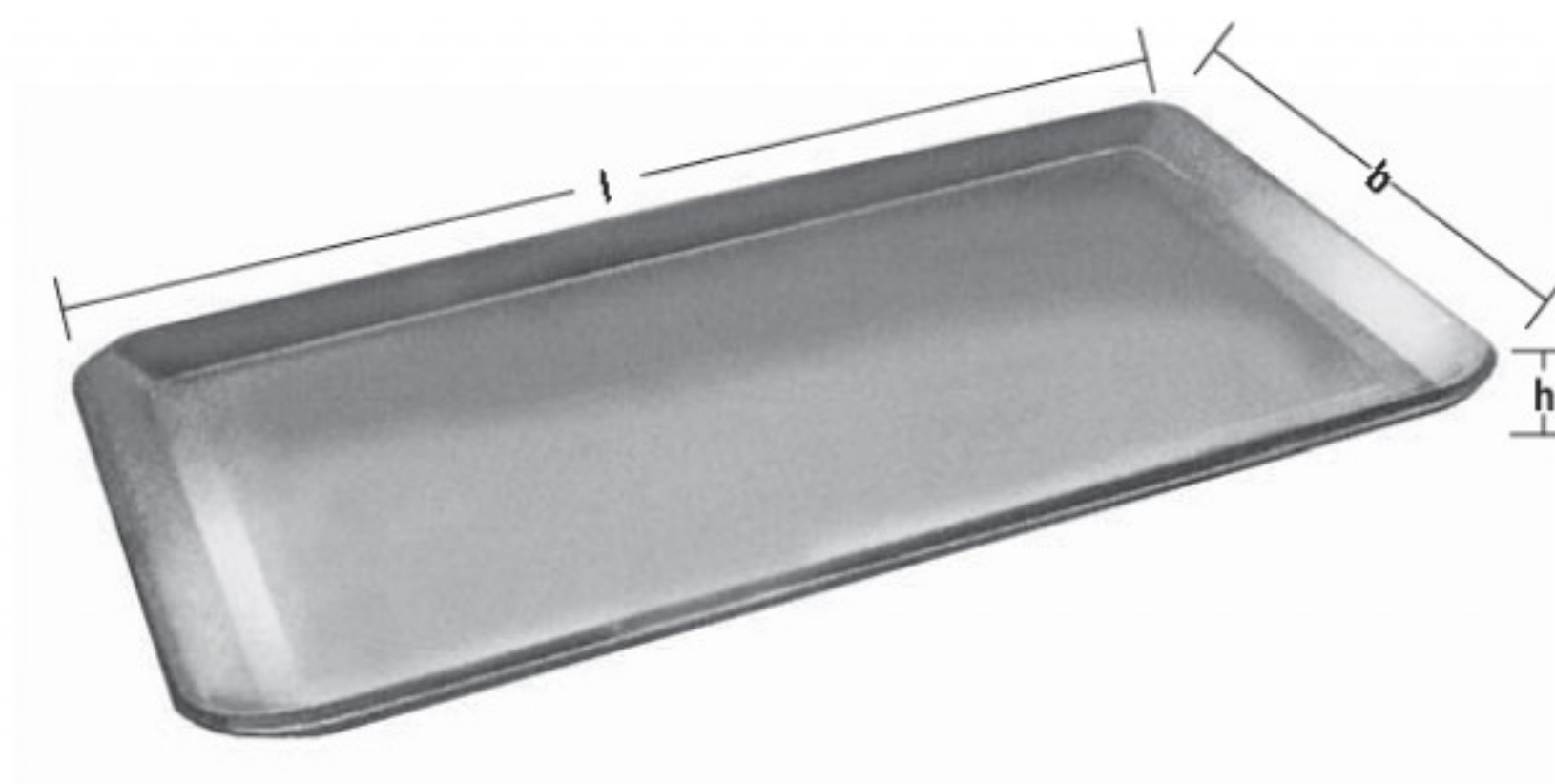

l x b x h	
210 x 160 x 10 mm	KU 309/21
240 x 180 x 10 mm	KU 309/24
310 x 150 x 10 mm	KU 309/31
310 x 210 x 10 mm	KU 310/31
350 x 240 x 10 mm	KU 310/35
400 x 270 x 20 mm	KU 310/40
420 x 280 x 10 mm	KU 310/42



Ø x h	l	
165 x 60 mm	0,75	KU 311/16
175 x 70 mm	1,00	KU 311/17
220 x 80 mm	2,00	KU 311/22
225 x 90 mm	2,50	KU 311/23
240 x 110 mm	3,00	KU 311/24
275 x 115 mm	4,50	KU 311/27
290 x 125 mm	6,00	KU 311/29
310 x 120 mm	6,00	KU 311/31
345 x 125 mm	8,50	KU 311/34
380 x 130 mm	11,00	KU 311/38



l x b x h	
16,5 x 9,0 x 3,5 cm	KU 312/16
20,0 x 10,0 x 5,0 cm	KU 312/20
22,0 x 15,0 x 5,0 cm	KU 312/22
26,0 x 15,0 x 5,0 cm	KU 312/26
30,5 x 20,5 x 5,0 cm	KU 312/30

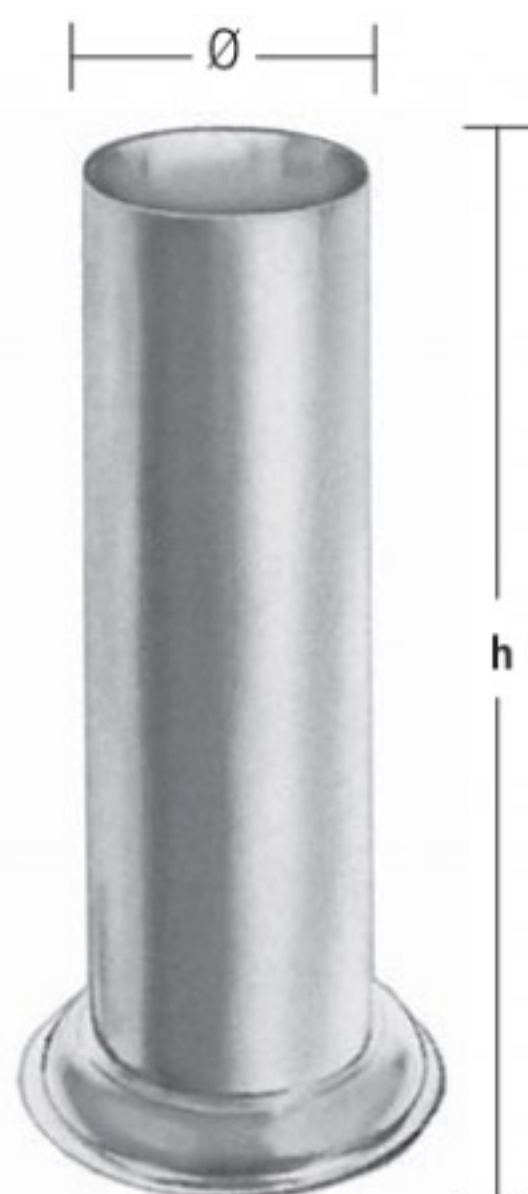

Ø x h	
30 x 90 mm	KU 314/09
50 x 100 mm	KU 314/10
50 x 130 mm	KU 314/13
50 x 175 mm	KU 314/17
75 x 100 mm	KU 315/10
75 x 130 mm	KU 315/13
75 x 175 mm	KU 315/17



ADAMS
KU 317/01



MAYO
KU 318/14
14,0 cm/5 1/2"



MAYO
KU 320/14
14,0 cm/5 1/2"

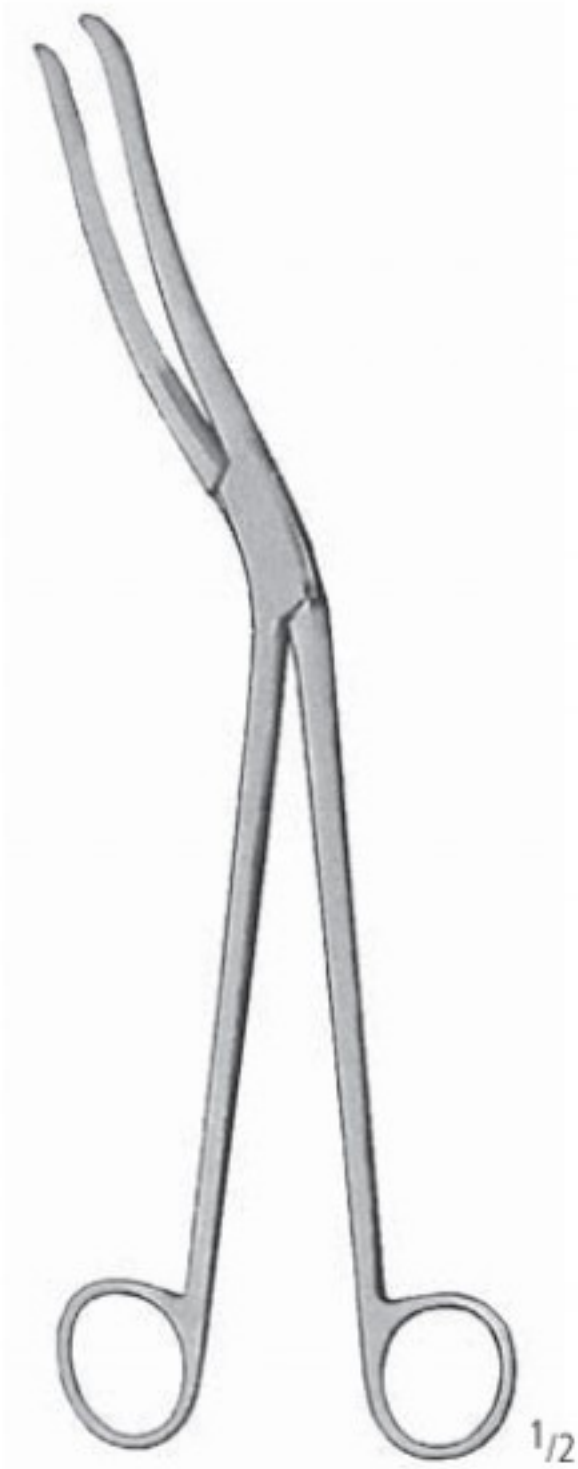

CHEATLE
KU 321/27
27,0 cm/10 3/4"



ROGGE
KU 322/23
23,0 cm/9"



PYE-SMITH (HARRISON)
KU 323/25 25,0 cm/10"
KU 323/30 30,0 cm/12"



KU 328/01
50 x 75 mm



KU 329/01
Ø 30,0 mm



KU 329/02
Ø 30,0 mm

Disposable dappen dish
Kunststoff - plastic - plástico - plastique - plastica



KU 332/01
Verpackungseinheit / packing unit 1000 St./pc.
250 pro Farbe / 250 per colour

Glass dappen dish
Glas - glass - cristal - verre - vetro



KU 333/01 KU 333/02 KU 333/03 KU 333/04

Verpackungseinheit / packing unit
2 St. pro Farbe / 2 pcs. per colour

Glas-Anmischplatten / glass mixing slabs

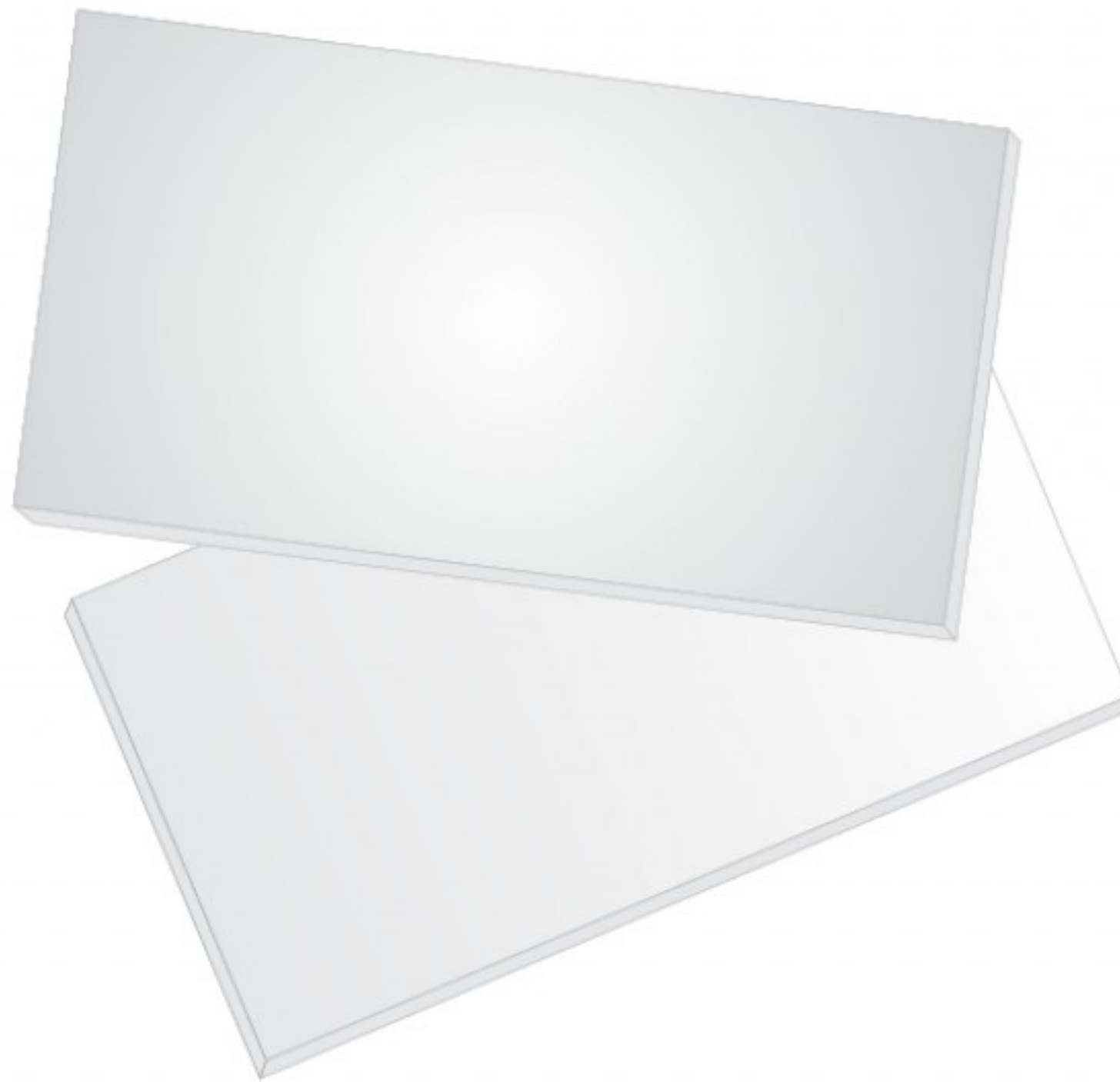

KU 335/02
150 x 80 x 2 mm



KU 340/01
Ø 11,0 mm
15,0 cm/6"



KU 340/02
Ø 11,0 mm
11,0 cm/4¹/₃"



KU 340/03
Ø 11,0 mm
14,0 cm/5¹/₂"

ZAHNZANGEN
EXTRACTING FORCEPS
FORCEPS DE EXTRACCION
DAVIERS
PINZA PER ESTRAZIONE

PA english pattern

nopa[®] instruments



Zahnzangen, englische Modelle
 Extracting forceps, english pattern
 Fórceps de extracción, forma inglesa
 Daviers, modèle anglaise
 Pinza per estrazione, modello inglese

Einsatzbereiche der Zahnzangen
 Application-Charts for extracting forceps
 Tablas de aplicación para Forceps de extracción
 Tableaux d'application des daviers
 Tabella d'applicazione delle pinze per estrazione

Oberkiefer, Upper jaw, Mandibula Superior, Mâchoire supérieure, Mandibola superiore																
	8	7	6	5	4	3	2	1	1	2	3	4	5	6	7	8
FDI	18	17	16	15	14	13	12	11	21	22	23	24	25	26	27	28
				55	54	53	52	51	61	62	63	64	65			
Milchzähne, Temporary teeth, Dentadura temporaria, Denture temporaire, Denti di latte																

	rechts, right side, lado derecho, côté droit, lato destra		links, left side, lado izquierdo, côté gauche, lato sinistra		
Zahn, Tooth, Diente, Dent, Un Dente			Zahn, Tooth, Diente, Dent, Un Dente		
FDI			FDI		
11 (1)	1, 3, 29, 30 34N, 35N		21 (1)	1, 3, 29, 30, 34N, 35N	
51 (1)	29S, 30S, 37, 137		61 (1)	29S, 30S, 37, 137	
12 (2)	2, 3, 29, 30, 34N, 35N		22 (2)	2, 3, 29, 30, 34N, 35N	
52 (2)	29S, 30S, 37, 137		62 (2)	29S, 30S, 37, 137	
13 (3)	1, 3		23 (3)	1, 3	
53 (3)	37, 137		63 (3)	37, 137	
14 (4)	2, 7, 34N, 35N, 76, 76N		24 (4)	2, 7, 34N, 35N, 76, 76N	
54 (4)	39, 39R, 139		64 (4)	39, 39L, 139	
15 (5)	2, 7, 34N, 35N, 76, 76N		25 (5)	2, 7, 34N, 35N, 76, 76N	
55 (5)	39, 39R, 139		65 (5)	39, 39L, 139	
16 (6)	17, 18A, 89		26 (6)	18, 18A, 90	
17 (7)	17, 18A, 89		27 (7)	18, 18A, 90	
18 (8)	17, 18A, 19, 67, 67A, 67N, 89		28 (8)	18, 18A, 19, 67, 67A, 67N, 90	

Wurzeln, Roots, Raíces, Racines, Radici	
11 (1) - 28 (8)	30, 44, 51, 51A, 76, 76N, 97, 146, 51LX, 151, 152, 153
51 (1) - 65 (5)	29S, 30S, 51S

ZAHNZANGEN EXTRACTING FORCEPS FORCEPS DE EXTRACCION DAVIERS PINZA PER ESTRAZIONE

Zahnzangen, englische Modelle
 Extracting forceps, english pattern
 Fórceps de extracción, forma inglesa
 Daviers, modèle anglaise
 Pinza per estrazione, modello inglese

Einsatzbereiche der Zahnzangen
 Application-Charts for extracting forceps
 Tablas de aplicación para Forceps de extracción
 Tableaux d'application des daviers
 Tabella d'applicazione delle pinze per estrazione

Unterkiefer, Lower jaw, Mandibula inferior, Mâchoire inférieure, Mandibola inferiore																
	8	7	6	5	4	3	2	1	1	2	3	4	5	6	7	8
FDI	48	47	46	45	44	43	42	41	31	32	33	34	35	36	37	38
				85	84	83	82	81	71	72	73	74	75			
Milchzähne, Temporary teeth, Dentadura temporaria, Denture temporaire, Denti di latte																

	rechts, right side, lado derecho, côté droit, lato destra		links, left side, lado izquierdo, côté gauche, lato sinistra		
Zahn, Tooth, Diente, Dent, Un Dente			Zahn, Tooth, Diente, Dent, Un Dente		
FDI			FDI		
41 (1)	4, 74, 74N, 74XN		31 (1)	4, 74, 74N, 74XN	
81 (1)	5, 38		71 (1)	5, 38	
42 (2)	4, 74, 74N, 74XN		32 (2)	4, 74, 74N, 74XN	
82 (2)	5, 38		72 (2)	5, 38	
43 (3)	4, 75		33 (3)	4, 75	
83 (3)	38		73 (3)	38	
44 (4)	8, 13, 36N, 46N, 75		34 (4)	8, 13, 36N, 46N, 75	
84 (4)	6, 13S, 22S		74 (4)	6, 13S, 22S	
45 (5)	8, 13, 36N, 46N, 75		35 (5)	8, 13, 36N, 46N, 75	
85 (5)	6, 13S, 22S		75 (5)	6, 13S, 22S	
46 (6)	21, 22, 23, 73, 86A, 86B, 86C, 87		36 (6)	21, 22, 24, 73, 86A, 86B, 86C, 87	
47 (7)	21, 22, 23, 73, 86A, 86B, 86C, 87		37 (7)	21, 22, 24, 73, 86A, 86B, 86C, 87	
48 (8)	79, 79A, 79N		38 (8)	79, 79A, 79N	

Wurzeln, Roots, Raíces, Racines, Radici	
31 (1) - 48 (8)	31, 33, 33A, 33M, 46L, 46LX, 74, 74N, 74XN, 146, 151, 152, 153
71 (1) - 85 (5)	7, 33S

AA AB AC AD AE AF AK AO AR KA KL KU PA PB PF PI PK PL PM PP PS PT PU PV KYE

Zahnzangen, englische Modelle
 Extracting forceps, english pattern
 Fórceps de extracción, forma inglesa
 Daviers, modèle anglaise
 Pinza per estrazione, modello inglese



Fig.1
 PA 001/00



Fig.2
 PA 002/00



Fig.3
 PA 003/00

ZAHNZANGEN EXTRACTING FORCEPS FORCEPS DE EXTRACCION DAVIERS PINZA PER ESTRAZIONE

Zahnzangen, englische Modelle
 Extracting forceps, english pattern
 Fórceps de extracción, forma inglesa
 Daviers, modèle anglaise
 Pinza per estrazione, modello inglese

AA
AB
AC
AD
AE
AF
AG
AH
AI
AJ
AK
AL
AO
AR
AS
AT
AU
AV
AW
AX
AY
AZ
BA
BB
BC
BD
BE
BF
BG
BH
BI
BJ
BK
BL
BM
BN
BO
BP
BQ
BR
BS
BT
BU
BV
BW
BX
BY
BZ
CA
CB
CC
CD
CE
CF
CG
CH
CI
CJ
CK
CL
CM
CN
CO
CP
CQ
CR
CS
CT
CU
CV
CW
CX
CY
CZ
DA
DB
DC
DD
DE
DF
DG
DH
DI
DJ
DK
DL
DM
DN
DO
DP
DQ
DR
DS
DT
DU
DV
DW
DX
DY
DZ
EA
EB
EC
ED
EE
EF
EG
EH
EI
EJ
EK
EL
EM
EN
EO
EP
EQ
ER
ES
ET
EU
EV
EW
EX
EY
EZ
FA
FB
FC
FD
FE
FF
FG
FH
FI
FJ
FK
FL
FM
FN
FO
FP
FQ
FR
FS
FT
FU
FV
FW
FX
FY
FZ
GA
GB
GC
GD
GE
GF
GG
GH
GI
GJ
GK
GL
GM
GN
GO
GP
GQ
GR
GS
GT
GU
GV
GW
GX
GY
GZ
HA
HB
HC
HD
HE
HF
HG
HH
HI
HJ
HK
HL
HM
HN
HO
HP
HQ
HR
HS
HT
HU
HV
HW
HX
HY
HZ
IA
IB
IC
ID
IE
IF
IG
IH
II
IJ
IK
IL
IM
IN
IO
IP
IQ
IR
IS
IT
IU
IV
IW
IX
IY
IZ
JA
JB
JC
JD
JE
JF
JG
JH
JI
JJ
JK
JL
JM
JN
JO
JP
JQ
JR
JS
JT
JU
JV
JW
JX
JY
JZ
KA
KB
KC
KD
KE
KF
KG
KH
KI
KJ
KK
KL
KM
KN
KO
KP
KQ
KR
KS
KT
KU
KV
KW
KX
KY
KZ
LA
LB
LC
LD
LE
LF
LG
LH
LI
LJ
LK
LL
LM
LN
LO
LP
LQ
LR
LS
LT
LU
LV
LW
LX
LY
LZ
MA
MB
MC
MD
ME
MF
MG
MH
MI
MJ
MK
ML
MM
MN
MO
MP
MQ
MR
MS
MT
MU
MV
MW
MX
MY
MZ
NA
NB
NC
ND
NE
NF
NG
NH
NI
NJ
NK
NL
NM
NN
NO
NP
NQ
NR
NS
NT
NU
NV
NW
NX
NY
NZ
OA
OB
OC
OD
OE
OF
OG
OH
OI
OJ
OK
OL
OM
ON
OO
OP
OQ
OR
OS
OT
OU
OV
OW
OX
OY
OZ
PA
PB
PC
PD
PE
PF
PG
PH
PI
PJ
PK
PL
PM
PN
PO
PP
PQ
PR
PS
PT
PU
PV
PW
PX
PY
PZ
QA
QB
QC
QD
QE
QF
QG
QH
QI
QJ
QK
QL
QM
QN
QO
QP
QQ
QR
QS
QT
QU
QV
QW
QX
QY
QZ
RA
RB
RC
RD
RE
RF
RG
RH
RI
RJ
RK
RL
RM
RN
RO
RP
RQ
RR
RS
RT
RU
RV
RW
RX
RY
RZ
SA
SB
SC
SD
SE
SF
SG
SH
SI
SJ
SK
SL
SM
SN
SO
SP
SQ
SR
SS
ST
SU
SV
SW
SX
SY
SZ
TA
TB
TC
TD
TE
TF
TG
TH
TI
TJ
TK
TL
TM
TN
TO
TP
TQ
TR
TS
TT
TU
TV
TW
TX
TY
TZ
UA
UB
UC
UD
UE
UF
UG
UH
UI
UJ
UK
UL
UM
UN
UO
UP
UQ
UR
US
UT
UU
UV
UW
UX
UY
UZ
VA
VB
VC
VD
VE
VF
VG
VH
VI
VJ
VK
VL
VM
VN
VO
VP
VQ
VR
VS
VT
VU
VV
VW
VX
VY
VZ
WA
WB
WC
WD
WE
WF
WG
WH
WI
WJ
WK
WL
WM
WN
WO
WP
WQ
WR
WS
WT
WU
WV
WW
WX
WY
WZ
XA
XB
XC
XD
XE
XF
XG
XH
XI
XJ
XK
XL
XM
XN
XO
XP
XQ
XR
XS
XT
XU
XV
XW
XX
XY
XZ
YA
YB
YC
YD
YE
YF
YG
YH
YI
YJ
YK
YL
YM
YN
YO
YP
YQ
YR
YS
YT
YU
YV
YW
YX
YY
YZ
ZA
ZB
ZC
ZD
ZE
ZF
ZG
ZH
ZI
ZJ
ZK
ZL
ZM
ZN
ZO
ZP
ZQ
ZR
ZS
ZT
ZU
ZV
ZW
ZX
ZY
ZZ



Fig.4
PA 004/00



Fig.7
PA 007/00



Fig.8
PA 008/00

Zahnzangen, englische Modelle
 Extracting forceps, english pattern
 Fórceps de extracción, forma inglesa
 Daviers, modèle anglaise
 Pinza per estrazione, modello inglese



Fig.13
 PA 013/00



Fig.17
 PA 017/00

ZAHNZANGEN EXTRACTING FORCEPS FORCEPS DE EXTRACCION DAVIERS PINZA PER ESTRAZIONE

Zahnzangen, englische Modelle
 Extracting forceps, english pattern
 Fórceps de extracción, forma inglesa
 Daviers, modèle anglaise
 Pinza per estrazione, modello inglese



Fig.18
 PA 018/00



Fig.18A
 PA 018/01

AA
 AB
 AC
 AD
 AE
 AF
 AK
 AL
 AO
 AR
 KA
 KL
 KU
 PA
 PB
 PF
 PI
 PK
 PL
 PM
 PP
 PS
 PT
 PU
 PV
 KYE

Zahnzangen, englische Modelle
 Extracting forceps, english pattern
 Fórceps de extracción, forma inglesa
 Daviers, modèle anglaise
 Pinza per estrazione, modello inglese



Fig.19
 PA 019/00



Fig.21
 PA 021/00



Fig.22
 PA 022/00

ZAHNZANGEN EXTRACTING FORCEPS FORCEPS DE EXTRACCION DAVIERS PINZA PER ESTRAZIONE

Zahnzangen, englische Modelle
 Extracting forceps, english pattern
 Fórceps de extracción, forma inglesa
 Daviers, modèle anglaise
 Pinza per estrazione, modello inglese

AA
AB
AC
AD
AE
AF
AK
AL
AO
AR
KA
KL
KU
PA
PB
PF
PI
PK
PL
PM
PP
PS
PT
PU
PV
KYE



Fig.23
PA 023/00



Fig.24
PA 024/00



Fig.29
PA 029/00

Zahnzangen, englische Modelle
 Extracting forceps, english pattern
 Fórceps de extracción, forma inglesa
 Daviers, modèle anglaise
 Pinza per estrazione, modello inglese



Fig.30
 PA 030/00



Fig.31
 PA 031/00

ZAHNZANGEN EXTRACTING FORCEPS FORCEPS DE EXTRACCION DAVIERS PINZA PER ESTRAZIONE

Zahnzangen, englische Modelle
 Extracting forceps, english pattern
 Fórceps de extracción, forma inglesa
 Daviers, modèle anglaise
 Pinza per estrazione, modello inglese



Fig.33
 PA 033/00



Fig.33A
 PA 033/01



Fig.33M
 PA 033/06

AA
 AB
 AC
 AD
 AE
 AF
 AK
 AL
 AO
 AR
 KA
 KL
 KU
 PA
 PB
 PF
 PI
 PK
 PL
 PM
 PP
 PS
 PT
 PU
 PV
 KYE

Zahnzangen, englische Modelle
 Extracting forceps, english pattern
 Fórceps de extracción, forma inglesa
 Daviers, modèle anglaise
 Pinza per estrazione, modello inglese



Fig.34N
 PA 034/00



Fig.35N
 PA 035/00

ZAHNZANGEN EXTRACTING FORCEPS FORCEPS DE EXTRACCION DAVIERS PINZA PER ESTRAZIONE

Zahnzangen, englische Modelle
 Extracting forceps, english pattern
 Fórceps de extracción, forma inglesa
 Daviers, modèle anglaise
 Pinza per estrazione, modello inglese



Fig.36N
 PA 036/00



Fig.44
 PA 044/00

AA
 AB
 AC
 AD
 AE
 AF
 AK
 AL
 AO
 AR
 KA
 KL
 KU
 PA
 PB
 PF
 PI
 PK
 PL
 PM
 PP
 PS
 PT
 PU
 PV
 KYE

Zahnzangen, englische Modelle
 Extracting forceps, english pattern
 Fórceps de extracción, forma inglesa
 Daviers, modèle anglaise
 Pinza per estrazione, modello inglese



Fig.46N
 PA 046/00



Fig.46L
 PA 046/01



Fig.46LX
 PA 046/02

ZAHNZANGEN EXTRACTING FORCEPS FORCEPS DE EXTRACCION DAVIERS PINZA PER ESTRAZIONE

Zahnzangen, englische Modelle
 Extracting forceps, english pattern
 Fórceps de extracción, forma inglesa
 Daviers, modèle anglaise
 Pinza per estrazione, modello inglese



Fig.51
 PA 051/00



Fig.51A
 PA 051/01



Fig.51LX
 PA 051/07

AA
 AB
 AC
 AD
 AE
 AF
 AG
 AH
 AI
 AJ
 AK
 AL
 AM
 AN
 AO
 AP
 AQ
 AR
 AS
 AT
 AU
 AV
 AW
 AX
 AY
 AZ
 BA
 BB
 BC
 BD
 BE
 BF
 BG
 BH
 BI
 BJ
 BK
 BL
 BM
 BN
 BO
 BP
 BQ
 BR
 BS
 BT
 BU
 BV
 BV
 BW
 BX
 BY
 BZ
 CA
 CB
 CC
 CD
 CE
 CF
 CG
 CH
 CI
 CJ
 CK
 CL
 CM
 CN
 CO
 CP
 CQ
 CR
 CS
 CT
 CU
 CV
 CW
 CX
 CY
 CZ
 DA
 DB
 DC
 DD
 DE
 DF
 DG
 DH
 DI
 DJ
 DK
 DL
 DM
 DN
 DO
 DP
 DP
 DQ
 DR
 DS
 DT
 DU
 DV
 DW
 DX
 DY
 DZ
 EA
 EB
 EC
 ED
 EE
 EF
 EG
 EH
 EI
 EJ
 EK
 EL
 EM
 EN
 EO
 EP
 EP
 EQ
 ER
 ES
 ET
 EU
 EV
 EW
 EX
 EY
 EZ
 FA
 FB
 FC
 FD
 FE
 FF
 FG
 FH
 FI
 FJ
 FK
 FL
 FM
 FN
 FO
 FP
 FP
 FQ
 FR
 FS
 FT
 FU
 FV
 FW
 FX
 FY
 FZ
 GA
 GB
 GC
 GD
 GE
 GF
 GG
 GH
 GI
 GJ
 GK
 GL
 GM
 GN
 GO
 GP
 GP
 GQ
 GR
 GS
 GT
 GU
 GV
 GW
 GX
 GY
 GZ
 HA
 HB
 HC
 HD
 HE
 HF
 HG
 HH
 HI
 HJ
 HK
 HL
 HM
 HN
 HO
 HP
 HP
 HQ
 HR
 HS
 HT
 HU
 HV
 HW
 HX
 HY
 HZ
 IA
 IB
 IC
 ID
 IE
 IF
 IG
 IH
 II
 IJ
 IK
 IL
 IM
 IN
 IO
 IP
 IP
 IQ
 IR
 IS
 IT
 IU
 IV
 IW
 IX
 IY
 IZ
 JA
 JB
 JC
 JD
 JE
 JF
 JG
 JH
 JI
 JJ
 JK
 JL
 JM
 JN
 JO
 JP
 JP
 JQ
 JR
 JS
 JT
 JU
 JV
 JW
 JX
 JY
 JZ
 KA
 KB
 KC
 KD
 KE
 KF
 KG
 KH
 KI
 KJ
 KK
 KL
 KM
 KN
 KO
 KP
 KP
 KQ
 KR
 KS
 KT
 KU
 KV
 KW
 KX
 KY
 KZ
 LA
 LB
 LC
 LD
 LE
 LF
 LG
 LH
 LI
 LJ
 LK
 LL
 LM
 LN
 LO
 LP
 LP
 LQ
 LR
 LS
 LT
 LU
 LV
 LW
 LX
 LY
 LZ
 MA
 MB
 MC
 MD
 ME
 MF
 MG
 MH
 MI
 MJ
 MK
 ML
 MM
 MN
 MO
 MP
 MP
 MQ
 MR
 MS
 MT
 MU
 MV
 MW
 MX
 MY
 MZ
 NA
 NB
 NC
 ND
 NE
 NF
 NG
 NH
 NI
 NJ
 NK
 NL
 NM
 NN
 NO
 NP
 NP
 NQ
 NR
 NS
 NT
 NU
 NV
 NW
 NX
 NY
 NZ
 OA
 OB
 OC
 OD
 OE
 OF
 OG
 OH
 OI
 OJ
 OK
 OL
 OM
 ON
 OO
 OP
 OP
 OQ
 OR
 OS
 OT
 OU
 OV
 OW
 OX
 OY
 OZ
 PA
 PB
 PC
 PD
 PE
 PF
 PG
 PH
 PI
 PJ
 PK
 PL
 PM
 PN
 PO
 PP
 PP
 PQ
 PR
 PS
 PT
 PU
 PV
 PW
 PX
 PY
 PZ
 QA
 QB
 QC
 QD
 QE
 QF
 QG
 QH
 QI
 QJ
 QK
 QL
 QM
 QN
 QO
 QP
 QP
 QQ
 QR
 QS
 QT
 QU
 QV
 QW
 QX
 QY
 QZ
 RA
 RB
 RC
 RD
 RE
 RF
 RG
 RH
 RI
 RJ
 RK
 RL
 RM
 RN
 RO
 RP
 RP
 RQ
 RR
 RS
 RT
 RU
 RV
 RW
 RX
 RY
 RZ
 SA
 SB
 SC
 SD
 SE
 SF
 SG
 SH
 SI
 SJ
 SK
 SL
 SM
 SN
 SO
 SP
 SP
 SQ
 SR
 SS
 ST
 SU
 SV
 SW
 SX
 SY
 SZ
 TA
 TB
 TC
 TD
 TE
 TF
 TG
 TH
 TI
 TJ
 TK
 TL
 TM
 TN
 TO
 TP
 TP
 TQ
 TR
 TS
 TT
 TU
 TV
 TW
 TX
 TY
 TZ
 UA
 UB
 UC
 UD
 UE
 UF
 UG
 UH
 UI
 UJ
 UK
 UL
 UM
 UN
 UO
 UP
 UP
 UQ
 UR
 US
 UT
 UU
 UV
 UW
 UX
 UY
 UZ
 VA
 VB
 VC
 VD
 VE
 VF
 VG
 VH
 VI
 VJ
 VK
 VL
 VM
 VN
 VO
 VP
 VP
 VQ
 VR
 VS
 VT
 VU
 VV
 VW
 VX
 VY
 VZ
 WA
 WB
 WC
 WD
 WE
 WF
 WG
 WH
 WI
 WJ
 WK
 WL
 WM
 WN
 WO
 WP
 WP
 WQ
 WR
 WS
 WT
 WU
 WV
 WW
 WX
 WY
 WZ
 XA
 XB
 XC
 XD
 XE
 XF
 XG
 XH
 XI
 XJ
 XK
 XL
 XM
 XN
 XO
 XP
 XP
 XQ
 XR
 XS
 XT
 XU
 XV
 XW
 XX
 XY
 XZ
 YA
 YB
 YC
 YD
 YE
 YF
 YG
 YH
 YI
 YJ
 YK
 YL
 YM
 YN
 YO
 YP
 YP
 YQ
 YR
 YS
 YT
 YU
 YV
 YW
 YX
 YZ
 ZA
 ZB
 ZC
 ZD
 ZE
 ZF
 ZG
 ZH
 ZI
 ZJ
 ZK
 ZL
 ZM
 ZN
 ZO
 ZP
 ZP
 ZQ
 ZR
 ZS
 ZT
 ZU
 ZV
 ZW
 ZX
 ZY
 ZZ

Zahnzangen, englische Modelle
 Extracting forceps, english pattern
 Fórceps de extracción, forma inglesa
 Daviers, modèle anglaise
 Pinza per estrazione, modello inglese



Fig.67
 PA 067/00



Fig.67A
 PA 067/01



Fig.67N
 PA 067/02

ZAHNZANGEN EXTRACTING FORCEPS FORCEPS DE EXTRACCION DAVIERS PINZA PER ESTRAZIONE

Zahnzangen, englische Modelle
 Extracting forceps, english pattern
 Fórceps de extracción, forma inglesa
 Daviers, modèle anglaise
 Pinza per estrazione, modello inglese



Fig.73
 PA 073/00



Fig.74
 PA 074/00

AA
 AB
 AC
 AD
 AE
 AF
 AK
 AL
 AO
 AR
 KA
 KL
 KU
 PA
 PB
 PF
 PI
 PK
 PL
 PM
 PP
 PS
 PT
 PU
 PV
 KYE

Zahnzangen, englische Modelle
 Extracting forceps, english pattern
 Fórceps de extracción, forma inglesa
 Daviers, modèle anglaise
 Pinza per estrazione, modello inglese



Fig. 74M
 PA 074/06



Fig. 74N
 PA 074/07



Fig. 75
 PA 075/00

ZAHNZANGEN EXTRACTING FORCEPS FORCEPS DE EXTRACCION DAVIERS PINZA PER ESTRAZIONE

Zahnzangen, englische Modelle
 Extracting forceps, english pattern
 Fórceps de extracción, forma inglesa
 Daviers, modèle anglaise
 Pinza per estrazione, modello inglese

AA
AB
AC
AD
AE
AF
AG
AH
AI
AJ
AK
AL
AO
AP
AQ
AR
AS
AT
AU
AV
AW
AX
AY
AZ
BA
BB
BC
BD
BE
BF
BG
BH
BI
BJ
BK
BL
BM
BN
BO
BP
BQ
BR
BS
BT
BU
BV
BW
BX
BY
BZ
CA
CB
CC
CD
CE
CF
CG
CH
CI
CJ
CK
CL
CM
CN
CO
CP
CQ
CR
CS
CT
CU
CV
CW
CX
CY
CZ
DA
DB
DC
DD
DE
DF
DG
DH
DI
DJ
DK
DL
DM
DN
DO
DP
DQ
DR
DS
DT
DU
DV
DW
DX
DY
DZ
EA
EB
EC
ED
EE
EF
EG
EH
EI
EJ
EK
EL
EM
EN
EO
EP
EQ
ER
ES
ET
EU
EV
EW
EX
EY
EZ
FA
FB
FC
FD
FE
FF
FG
FH
FI
FJ
FK
FL
FM
FN
FO
FP
FQ
FR
FS
FT
FU
FV
FW
FX
FY
FZ
GA
GB
GC
GD
GE
GF
GG
GH
GI
GJ
GK
GL
GM
GN
GO
GP
GQ
GR
GS
GT
GU
GV
GW
GX
GY
GZ
HA
HB
HC
HD
HE
HF
HG
HH
HI
HJ
HK
HL
HM
HN
HO
HP
HQ
HR
HS
HT
HU
HV
HW
HX
HY
HZ
IA
IB
IC
ID
IE
IF
IG
IH
II
IJ
IK
IL
IM
IN
IO
IP
IQ
IR
IS
IT
IU
IV
IW
IX
IY
IZ
JA
JB
JC
JD
JE
JF
JG
JH
JI
JJ
JK
JL
JM
JN
JO
JP
JQ
JR
JS
JT
JU
JV
JW
JX
JY
JZ
KA
KB
KC
KD
KE
KF
KG
KH
KI
KJ
KK
KL
KM
KN
KO
KP
KQ
KR
KS
KT
KU
KV
KW
KX
KY
KZ
LA
LB
LC
LD
LE
LF
LG
LH
LI
LJ
LK
LL
LM
LN
LO
LP
LQ
LR
LS
LT
LU
LV
LW
LX
LY
LZ
MA
MB
MC
MD
ME
MF
MG
MH
MI
MJ
MK
ML
MM
MN
MO
MP
MQ
MR
MS
MT
MU
MV
MW
MX
MY
MZ
NA
NB
NC
ND
NE
NF
NG
NH
NI
NJ
NK
NL
NM
NN
NO
NP
NQ
NR
NS
NT
NU
NV
NW
NX
NY
NZ
OA
OB
OC
OD
OE
OF
OG
OH
OI
OJ
OK
OL
OM
ON
OO
OP
OQ
OR
OS
OT
OU
OV
OW
OX
OY
OZ
PA
PB
PC
PD
PE
PF
PG
PH
PI
PJ
PK
PL
PM
PN
PO
PP
PQ
PR
PS
PT
PU
PV
PW
PX
PY
PZ
QA
QB
QC
QD
QE
QF
QG
QH
QI
QJ
QK
QL
QM
QN
QO
QP
QQ
QR
QS
QT
QU
QV
QW
QX
QY
QZ
RA
RB
RC
RD
RE
RF
RG
RH
RI
RJ
RK
RL
RM
RN
RO
RP
RQ
RR
RS
RT
RU
RV
RW
RX
RY
RZ
SA
SB
SC
SD
SE
SF
SG
SH
SI
SJ
SK
SL
SM
SN
SO
SP
SQ
SR
SS
ST
SU
SV
SW
SX
SY
SZ
TA
TB
TC
TD
TE
TF
TG
TH
TI
TJ
TK
TL
TM
TN
TO
TP
TQ
TR
TS
TT
TU
TV
TW
TX
TY
TZ
UA
UB
UC
UD
UE
UF
UG
UH
UI
UJ
UK
UL
UM
UN
UO
UP
UQ
UR
US
UT
UU
UV
UW
UX
UY
UZ
VA
VB
VC
VD
VE
VF
VG
VH
VI
VJ
VK
VL
VM
VN
VO
VP
VQ
VR
VS
VT
VU
VV
VW
VX
VY
VZ
WA
WB
WC
WD
WE
WF
WG
WH
WI
WJ
WK
WL
WM
WN
WO
WP
WQ
WR
WS
WT
WU
WV
WW
WX
WY
WZ
XA
XB
XC
XD
XE
XF
XG
XH
XI
XJ
XK
XL
XM
XN
XO
XP
XQ
XR
XS
XT
XU
XV
XW
XX
XY
XZ
YA
YB
YC
YD
YE
YF
YG
YH
YI
YJ
YK
YL
YM
YN
YO
YP
YQ
YR
YS
YT
YU
YV
YW
YX
YY
YZ
ZA
ZB
ZC
ZD
ZE
ZF
ZG
ZH
ZI
ZJ
ZK
ZL
ZM
ZN
ZO
ZP
ZQ
ZR
ZS
ZT
ZU
ZV
ZW
ZX
ZY
ZZ



LAWRENCE-READ
 Fig.76
 PA 076/00



LAWRENCE-READ
 Fig.76N
 PA 076/07

Zahnzangen, englische Modelle
 Extracting forceps, english pattern
 Fórceps de extracción, forma inglesa
 Daviers, modèle anglaise
 Pinza per estrazione, modello inglese



Fig.79
 PA 079/00



Fig.79A
 PA 079/01



Fig.79N
 PA 079/02

ZAHNZANGEN EXTRACTING FORCEPS FORCEPS DE EXTRACCION DAVIERS PINZA PER ESTRAZIONE

Zahnzangen, englische Modelle
 Extracting forceps, english pattern
 Fórceps de extracción, forma inglesa
 Daviers, modèle anglaise
 Pinza per estrazione, modello inglese



Fig.86A
 PA 086/01



Fig.86B
 PA 086/02



Fig.86C
 PA 086/03

AA
 AB
 AC
 AD
 AE
 AF
 AK
 AL
 AO
 AR
 KA
 KL
 KU
 PA
 PB
 PF
 PI
 PK
 PL
 PM
 PP
 PS
 PT
 PU
 PV
 KYE

Zahnzangen, englische Modelle
 Extracting forceps, english pattern
 Fórceps de extracción, forma inglesa
 Daviers, modèle anglaise
 Pinza per estrazione, modello inglese

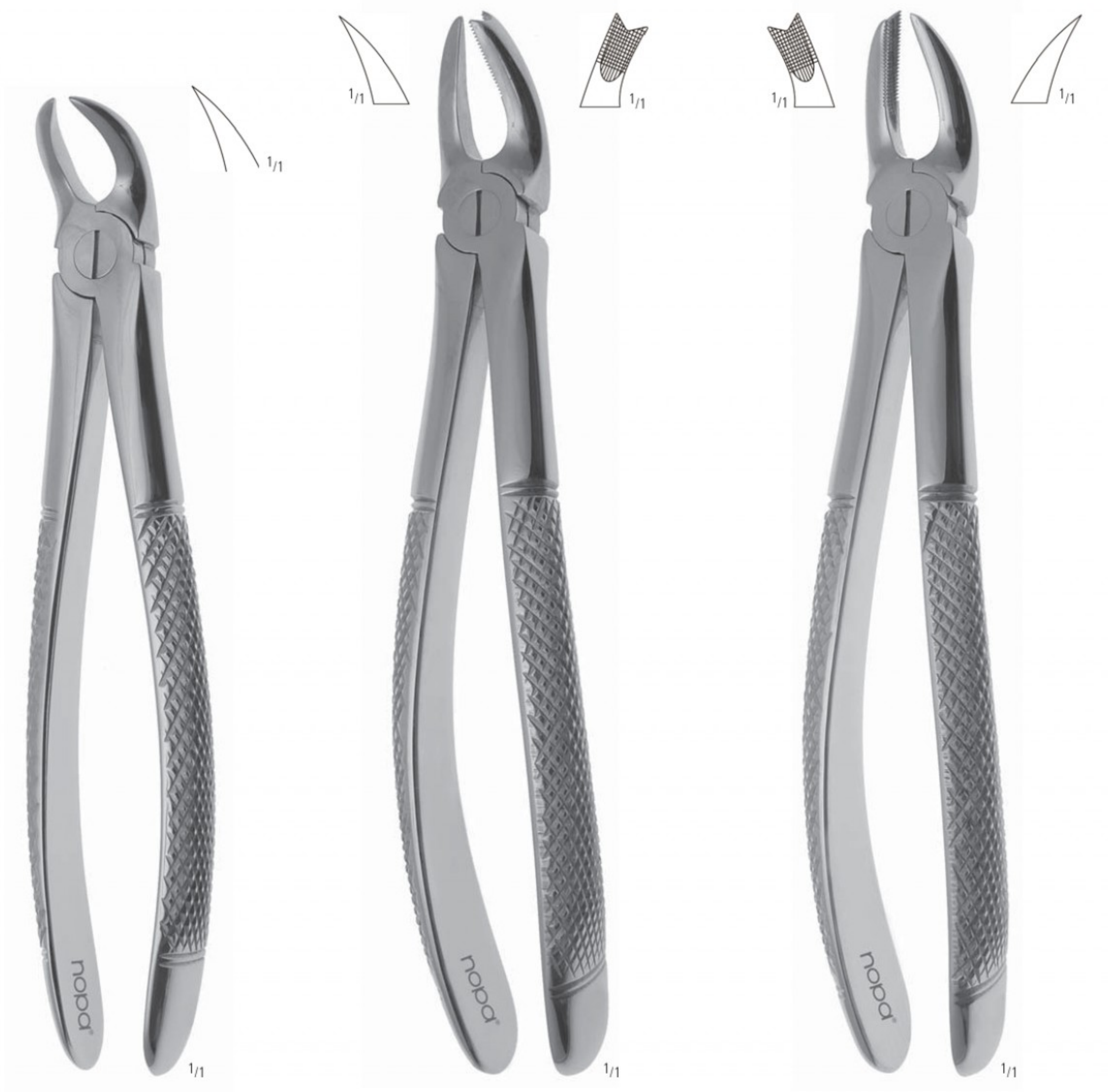

Fig.87
 PA 087/00

Fig.89
 PA 089/00

Fig.90
 PA 090/00

ZAHNZANGEN EXTRACTING FORCEPS FORCEPS DE EXTRACCION DAVIERS PINZA PER ESTRAZIONE

Zahnzangen, englische Modelle
 Extracting forceps, english pattern
 Fórceps de extracción, forma inglesa
 Daviers, modèle anglaise
 Pinza per estrazione, modello inglese



Fig.97
 PA 097/00



Fig.136
 PA 136/00

AA
 AB
 AC
 AD
 AE
 AF
 AK
 AL
 AO
 AR
 KA
 KL
 KU
 PA
 PB
 PF
 PI
 PK
 PL
 PM
 PP
 PS
 PT
 PU
 PV
 KYE

Zahnzangen, englische Modelle
 Extracting forceps, english pattern
 Fórceps de extracción, forma inglesa
 Daviers, modèle anglaise
 Pinza per estrazione, modello inglese



Fig.146
 PA 146/00



Fig.151
 PA 151/00

ZAHNZANGEN EXTRACTING FORCEPS FORCEPS DE EXTRACCION DAVIERS PINZA PER ESTRAZIONE

Zahnzangen, englische Modelle
 Extracting forceps, english pattern
 Fórceps de extracción, forma inglesa
 Daviers, modèle anglaise
 Pinza per estrazione, modello inglese



Fig.152
 PA 152/00



Fig.153
 PA 153/00

AA
 AB
 AC
 AD
 AE
 AF
 AG
 AH
 AI
 AJ
 AK
 AL
 AO
 AP
 AQ
 AR
 AS
 AT
 AU
 AV
 AW
 AX
 AY
 AZ
 BA
 BB
 BC
 BD
 BE
 BF
 BG
 BH
 BI
 BJ
 BK
 BL
 BM
 BN
 BO
 BP
 BQ
 BR
 BS
 BT
 BU
 BV
 BV
 BW
 BX
 BY
 BZ
 CA
 CB
 CC
 CD
 CE
 CF
 CG
 CH
 CI
 CJ
 CK
 CL
 CM
 CN
 CO
 CP
 CQ
 CR
 CS
 CT
 CU
 CV
 CW
 CX
 CY
 CZ
 DA
 DB
 DC
 DD
 DE
 DF
 DG
 DH
 DI
 DJ
 DK
 DL
 DM
 DN
 DO
 DP
 DQ
 DR
 DS
 DT
 DU
 DV
 DW
 DX
 DY
 DZ
 EA
 EB
 EC
 ED
 EE
 EF
 EG
 EH
 EI
 EJ
 EK
 EL
 EM
 EN
 EO
 EP
 EQ
 ER
 ES
 ET
 EU
 EV
 EW
 EX
 EY
 EZ
 FA
 FB
 FC
 FD
 FE
 FF
 FG
 FH
 FI
 FJ
 FK
 FL
 FM
 FN
 FO
 FP
 FQ
 FR
 FS
 FT
 FU
 FV
 FW
 FX
 FY
 FZ
 GA
 GB
 GC
 GD
 GE
 GF
 GG
 GH
 GI
 GJ
 GK
 GL
 GM
 GN
 GO
 GP
 GQ
 GR
 GS
 GT
 GU
 GV
 GW
 GX
 GY
 GZ
 HA
 HB
 HC
 HD
 HE
 HF
 HG
 HH
 HI
 HJ
 HK
 HL
 HM
 HN
 HO
 HP
 HQ
 HR
 HS
 HT
 HU
 HV
 HW
 HX
 HY
 HZ
 IA
 IB
 IC
 ID
 IE
 IF
 IG
 IH
 II
 IJ
 IK
 IL
 IM
 IN
 IO
 IP
 IQ
 IR
 IS
 IT
 IU
 IV
 IW
 IX
 IY
 IZ
 JA
 JB
 JC
 JD
 JE
 JF
 JG
 JH
 JI
 JJ
 JK
 JL
 JM
 JN
 JO
 JP
 JQ
 JR
 JS
 JT
 JU
 JV
 JW
 JX
 JY
 JZ
 KA
 KB
 KC
 KD
 KE
 KF
 KG
 KH
 KI
 KJ
 KK
 KL
 KM
 KN
 KO
 KP
 KQ
 KR
 KS
 KT
 KU
 KV
 KW
 KX
 KY
 KZ
 LA
 LB
 LC
 LD
 LE
 LF
 LG
 LH
 LI
 LJ
 LK
 LL
 LM
 LN
 LO
 LP
 LQ
 LR
 LS
 LT
 LU
 LV
 LW
 LX
 LY
 LZ
 MA
 MB
 MC
 MD
 ME
 MF
 MG
 MH
 MI
 MJ
 MK
 ML
 MM
 MN
 MO
 MP
 MQ
 MR
 MS
 MT
 MU
 MV
 MW
 MX
 MY
 MZ
 NA
 NB
 NC
 ND
 NE
 NF
 NG
 NH
 NI
 NJ
 NK
 NL
 NM
 NN
 NO
 NP
 NQ
 NR
 NS
 NT
 NU
 NV
 NW
 NX
 NY
 NZ
 OA
 OB
 OC
 OD
 OE
 OF
 OG
 OH
 OI
 OJ
 OK
 OL
 OM
 ON
 OO
 OP
 OQ
 OR
 OS
 OT
 OU
 OV
 OW
 OX
 OY
 OZ
 PA
 PB
 PC
 PD
 PE
 PF
 PG
 PH
 PI
 PJ
 PK
 PL
 PM
 PN
 PO
 PP
 PQ
 PR
 PS
 PT
 PU
 PV
 PW
 PX
 PY
 PZ
 QA
 QB
 QC
 QD
 QE
 QF
 QG
 QH
 QI
 QJ
 QK
 QL
 QM
 QN
 QO
 QP
 QQ
 QR
 QS
 QT
 QU
 QV
 QW
 QX
 QY
 QZ
 RA
 RB
 RC
 RD
 RE
 RF
 RG
 RH
 RI
 RJ
 RK
 RL
 RM
 RN
 RO
 RP
 RQ
 RR
 RS
 RT
 RU
 RV
 RW
 RX
 RY
 RZ
 SA
 SB
 SC
 SD
 SE
 SF
 SG
 SH
 SI
 SJ
 SK
 SL
 SM
 SN
 SO
 SP
 SQ
 SR
 SS
 ST
 SU
 SV
 SW
 SX
 SY
 SZ
 TA
 TB
 TC
 TD
 TE
 TF
 TG
 TH
 TI
 TJ
 TK
 TL
 TM
 TN
 TO
 TP
 TQ
 TR
 TS
 TT
 TU
 TV
 TW
 TX
 TY
 TZ
 UA
 UB
 UC
 UD
 UE
 UF
 UG
 UH
 UI
 UJ
 UK
 UL
 UM
 UN
 UO
 UP
 UQ
 UR
 US
 UT
 UU
 UV
 UW
 UX
 UY
 UZ
 VA
 VB
 VC
 VD
 VE
 VF
 VG
 VH
 VI
 VJ
 VK
 VL
 VM
 VN
 VO
 VP
 VQ
 VR
 VS
 VT
 VU
 VV
 VW
 VX
 VY
 VZ
 WA
 WB
 WC
 WD
 WE
 WF
 WG
 WH
 WI
 WJ
 WK
 WL
 WM
 WN
 WO
 WP
 WQ
 WR
 WS
 WT
 WU
 WV
 WW
 WX
 WY
 WZ
 XA
 XB
 XC
 XD
 XE
 XF
 XG
 XH
 XI
 XJ
 XK
 XL
 XM
 XN
 XO
 XP
 XQ
 XR
 XS
 XT
 XU
 XV
 XW
 XX
 XY
 XZ
 YA
 YB
 YC
 YD
 YE
 YF
 YG
 YH
 YI
 YJ
 YK
 YL
 YM
 YN
 YO
 YP
 YQ
 YR
 YS
 YT
 YU
 YV
 YW
 YX
 YZ
 ZA
 ZB
 ZC
 ZD
 ZE
 ZF
 ZG
 ZH
 ZI
 ZJ
 ZK
 ZL
 ZM
 ZN
 ZO
 ZP
 ZQ
 ZR
 ZS
 ZT
 ZU
 ZV
 ZW
 ZX
 ZY
 ZZ

Zahnzangen, englische Modelle
 Extracting forceps, english pattern
 Fórceps de extracción, forma inglesa
 Daviers, modèle anglaise
 Pinza per estrazione, modello inglese



MEAD
 Fig.MD3
 PA 160/03



MEAD
 Fig.MD4
 PA 160/04

Zahnzangen, englische Modelle
 Extracting forceps, english pattern
 Fórceps de extracción, forma inglesa
 Daviers, modèle anglaise
 Pinza per estrazione, modello inglese

Elegance



Fig.1
PA 401/00



Fig.2
PA 402/00



Fig.7
PA 407/00

AA
AB
AC
AD
AE
AF
AK
AL
AO
AR
KA
KL
KU
PA
PB
PF
PI
PK
PL
PM
PP
PS
PT
PU
PV
KYE

Zahnzangen, englische Modelle
 Extracting forceps, english pattern
 Fórceps de extracción, forma inglesa
 Daviers, modèle anglaise
 Pinza per estrazione, modello inglese

Elegance



Fig.13
 PA 413/00



Fig.13S
 PA 413/09

Zahnzangen, englische Modelle
 Extracting forceps, english pattern
 Fórceps de extracción, forma inglesa
 Daviers, modèle anglaise
 Pinza per estrazione, modello inglese

Elegance



Fig.17
 PA 417/00



Fig.18
 PA 418/00

Zahnzangen, englische Modelle
 Extracting forceps, english pattern
 Fórceps de extracción, forma inglesa
 Daviers, modèle anglaise
 Pinza per estrazione, modello inglese

Elegance



Fig.22
 PA 422/00



Fig.30
 PA 430/00

Zahnzangen, englische Modelle
 Extracting forceps, english pattern
 Fórceps de extracción, forma inglesa
 Daviers, modèle anglaise
 Pinza per estrazione, modello inglese

Elegance



Fig.33
 PA 433/00



Fig.39
 PA 439/00

AA
 AB
 AC
 AD
 AE
 AF
 AK
 AL
 AO
 AR
 KA
 KL
 KU
 PA
 PB
 PF
 PI
 PK
 PL
 PM
 PP
 PS
 PT
 PU
 PV
 KYE

Zahnzangen, englische Modelle
 Extracting forceps, english pattern
 Fórceps de extracción, forma inglesa
 Daviers, modèle anglaise
 Pinza per estrazione, modello inglese

Elegance



Fig.51
 PA 451/00



Fig.51A
 PA 451/01



Fig.67A
 PA 467/01

Zahnzangen, englische Modelle
 Extracting forceps, english pattern
 Fórceps de extracción, forma inglesa
 Daviers, modèle anglaise
 Pinza per estrazione, modello inglese

Elegance



Fig.73
 PA 473/00



Fig.74
 PA 474/00



Fig.74N
 PA 474/01

AA
 AB
 AC
 AD
 AE
 AF
 AK
 AL
 AO
 AR
 KA
 KL
 KU
 PA
 PB
 PF
 PI
 PK
 PL
 PM
 PP
 PS
 PT
 PU
 PV
 KYE

Zahnzangen, englische Modelle
Extracting forceps, english pattern
Fórceps de extracción, forma inglesa
Daviers, modèle anglaise
Pinza per estrazione, modello inglese

Elegance



Fig.79
PA 479/00

ZAHNZANGEN EXTRACTING FORCEPS FORCEPS DE EXTRACCION DAVIERS PINZA PER ESTRAZIONE

Kinderzahnzangen, englische Modelle
 Extracting forceps for children, english pattern
 Pinzas de extracción para niños, forma inglesa
 Daviers pour enfants, modèle anglaise
 Pinze per estrazione per bambini, modello inglese



Fig.135
 PA 513/09



Fig.225
 PA 522/09



Fig.295
 PA 529/09

AA AB AC AD AE AF AK AL AO AR KA KL KU PA PB PF PI PK PL PM PP PS PT PU PV KYE

Kinderzahnzangen, englische Modelle
 Extracting forceps for children, english pattern
 Fórceps de extracción para niños, forma inglesa
 Daviers pour enfants, modèle anglaise
 Pinze per estrazione per bambini, modello inglese



Fig.305
 PA 530/09



Fig.335
 PA 533/09



Fig.37
 PA 537/00

ZAHNZANGEN EXTRACTING FORCEPS FORCEPS DE EXTRACCION DAVIERS PINZA PER ESTRAZIONE

Kinderzahnzangen, englische Modelle
 Extracting forceps for children, english pattern
 Fórceps de extracción para niños, forma inglesa
 Daviers pour enfants, modèle anglaise
 Pinze per estrazione per bambini, modello inglese



Fig.38
PA 538/00

Fig.39
PA 539/00

Fig.39L
PA 539/05

AA
AB
AC
AD
AE
AF
AK
AL
AO
AR
KA
KL
KU
PA
PB
PF
PI
PK
PL
PM
PP
PS
PT
PU
PV
KYE

Kinderzahnzangen, englische Modelle
 Extracting forceps for children, english pattern
 Fórceps de extracción para niños, forma inglesa
 Daviers pour enfants, modèle anglaise
 Pinze per estrazione per bambini, modello inglese



Fig.39R
 PA 539/08



Fig.51S
 PA 551/09

ZAHNZANGEN EXTRACTING FORCEPS FORCEPS DE EXTRACCION DAVIERS PINZA PER ESTRAZIONE

Kinderzahnzangen, englische Modelle
 Extracting forceps for children, english pattern
 Fórceps de extracción para niños, forma inglesa
 Daviers pour enfants, modèle anglaise
 Pinze per estrazione per bambini, modello inglese



KLEIN
 Fig.3
 PA 603/00



Fig.5
 PA 605/00

AA
 AB
 AC
 AD
 AE
 AF
 AK
 AL
 AO
 AR
 KA
 KL
 KU
 PA
 PB
 PF
 PI
 PK
 PL
 PM
 PP
 PS
 PT
 PU
 PV
 KYE

Kinderzahnzangen, englische Modelle
 Extracting forceps for children, english pattern
 Fórceps de extracción para niños, forma inglesa
 Daviers pour enfants, modèle anglaise
 Pinze per estrazione per bambini, modello inglese



Fig.6
 PA 606/00



Fig.7
 PA 607/00

ZAHNZANGEN EXTRACTING FORCEPS FORCEPS DE EXTRACCION DAVIERS PINZA PER ESTRAZIONE

Kinderzahnzangen, englische Modelle
 Extracting forceps for children, english pattern
 Fórceps de extracción para niños, forma inglesa
 Daviers pour enfants, modèle anglaise
 Pinze per estrazione per bambini, modello inglese



KLEIN
 Fig.137
 PA 637/00



KLEIN
 Fig.139
 PA 639/00

AA
 AB
 AC
 AD
 AE
 AF
 AK
 AL
 AO
 AR
 KA
 KL
 KU
 PA
 PB
 PF
 PI
 PK
 PL
 PM
 PP
 PS
 PT
 PU
 PV
 KYE

Kinderzahnzangen, englische Modelle
Extracting forceps for children, english pattern
Fórceps de extracción para niños, forma inglesa
Daviers pour enfants, modèle anglaise
Pinze per estrazione per bambini, modello inglese



KLEIN
Fig.51S
PA 651/09

ZAHNZANGEN EXTRACTING FORCEPS FORCEPS DE EXTRACCION DAVIERS PINZA PER ESTRAZIONE

Wurzelsplitterzangen
 Root fragment forceps
 Fórceps para fragmentos de raíces
 Daviers à fragments des racines
 Pinze per radici e fragmenti



WITZEL
 Fig.1
 PA 705/01



WITZEL
 Fig.2
 PA 705/02

AA
 AB
 AC
 AD
 AE
 AF
 AK
 AL
 AO
 AR
 KA
 KL
 KU
PA
 PB
 PF
 PI
 PK
 PL
 PM
 PP
 PS
 PT
 PU
 PV
 KYE

ZAHNZANGEN
EXTRACTING FORCEPS
FORCEPS DE EXTRACCION
DAVIERS
PINZA PER ESTRAZIONE

PB american pattern

nopa[®] instruments



Zahnzangen, amerikanische Modelle
 Extracting forceps, american pattern
 Fórceps de extracción, forma americana
 Daviers, modèle américaine
 Pinza per estrazione, modello americano

Einsatzbereiche der Zahnzangen
 Application-Charts for extracting forceps
 Tablas de aplicación para Forceps de extracción
 Tableaux d'application des daviers
 Tabella d'applicazione delle pinze per estrazione

Oberkiefer, Upper jaw, Mandibula Superior, Mâchoire supérieure, Mandibola superiore																
	8	7	6	5	4	3	2	1	1	2	3	4	5	6	7	8
FDI	18	17	16	15	14	13	12	11	21	22	23	24	25	26	27	28
				55	54	53	52	51	61	62	63	64	65			
Milchzähne, Temporary teeth, Dentadura temporaria, Denture temporaire, Denti di latte																

	rechts, right side, lado derecho, côté droit, lato destra		links, left side, lado izquierdo, côté gauche, lato sinistra		
Zahn, Tooth, Diente, Dent, Un Dente			Zahn, Tooth, Diente, Dent, Un Dente		
FDI			FDI		
11 (1)	1, 1A, 62, 65, 99C, 150, 150A, AS, S, X		21 (1)	1, 1A, 62, 65, 99C, 150, 150A, AS, S, X	
51 (1)	62, 150SK		61 (1)	62, 150SK	
12 (2)	1, 1A, 62, 65, 99C, 150, 150A, AS, S, X		22 (2)	1, 1A, 62, 65, 99C, 150, 150A, AS, S, X	
52 (2)	62, 150 SK		62 (2)	62, 150SK	
13 (3)	1, 62, 99C, 150		23 (3)	1, 62, 99C, 150	
53 (3)	62, 150 SK		63 (3)	62, 150SK	
14 (4)	32, 32A, 62, 150, 150A, AS, S, X		24 (4)	32, 32A, 62, 99C, 150, 150A, AS, S, X	
54 (4)	62, 150SK		64 (4)	62, 150SK	
15 (5)	32, 32A, 62, 150, 150A, AS, S, X		25 (5)	32, 32A, 62, 150, 150A, AS, S, X	
55 (5)	62, 150SK		65 (5)	62, 150SK	
16 (6)	10S, 18R, 24, 32, 32A, 53R, 62, 88R		26 (6)	10S, 18L, 24, 32, 32A, 53L, 62, 88L	
17 (7)	10S, 18R, 24, 32, 32A, 53R, 62, 88R		27 (7)	10S, 18L, 24, 32, 32A, 53L, 62, 88L	
18 (8)	10S, 210H		28 (8)	10S, 210H	

Wurzeln, Roots, Raíces, Racines, Radici	
11 (1) - 28 (8)	32A, 62, 65, 69, 150, 150A, 150AS, 150S, 150X
51 (1) - 65 (5)	62, 150SK

ZAHNZANGEN EXTRACTING FORCEPS FORCEPS DE EXTRACCION DAVIERS PINZA PER ESTRAZIONE

Zahnzangen, amerikanische Modelle
 Extracting forceps, american pattern
 Fórceps de extracción, forma americana
 Daviers, modèle américaine
 Pinza per estrazione, modello americano

Einsatzbereiche der Zahnzangen
 Application-Charts for extracting forceps
 Tablas de aplicación para Forceps de extracción
 Tableaux d'application des daviers
 Tabella d'applicazione delle pinze per estrazione

Unterkiefer, Lower jaw, Mandibula inferior, Mâchoire inférieure, Mandibola inferiore																
	8	7	6	5	4	3	2	1	1	2	3	4	5	6	7	8
FDI	48	47	46	45	44	43	42	41	31	32	33	34	35	36	37	38
				85	84	83	82	81	71	72	73	74	75			
Milchzähne, Temporary teeth, Dentadura temporaria, Denture temporaire, Denti di latte																

	rechts, right side, lado derecho, côté droit, lato destra		links, left side, lado izquierdo, côté gauche, lato sinistra		
Zahn, Tooth, Diente, Dent, Un Dente			Zahn, Tooth, Diente, Dent, Un Dente		
FDI			FDI		
41 (1)	151, 151A, 151AS, 151S, 151X		31 (1)	151, 151A, 151AS, 151S, 151X	
81 (1)	151SK		71 (1)	151SK	
42 (2)	151, 151A, 151AS, 151S, 151X		32 (2)	151, 151A, 151AS, 151S, 151X	
82 (2)	151SK		72 (2)	151SK	
43 (3)	151S		33 (3)	151S	
83 (3)	151SK		73 (3)	151SK	
44 (4)	151, 151A, 151AS, 151S, 151X		34 (4)	151, 151A, 151AS, 151S, 151X	
84 (4)	17SK, 23SK, 151SK		74 (4)	17SK, 23SK, 151SK	
45 (5)	151, 151A, 151AS, 151S, 151X		35 (5)	151, 151A, 151AS, 151S, 151X	
85 (5)	17SK, 23SK, 151SK		75 (5)	17SK, 23SK, 151SK	
46 (6)	3FS, 15, 16, 17, 23, 151S		36 (6)	3FS, 15, 16, 17, 23, 151S	
47 (7)	3FS, 15, 16, 17, 23, 151S		37 (7)	3FS, 15, 16, 17, 23, 151S	
48 (8)	151S, 222		38 (8)	151S, 222	

Wurzeln, Roots, Raíces, Racines, Radici	
31 (1) - 48 (8)	69, 151, 151A, 151AS, 151S, 151X
71 (1) - 85 (5)	151SK

AA
AB
AC
AD
AE
AF
AK
AL
AO
AR
KA
KL
KU
PA
PB
PF
PI
PK
PL
PM
PP
PS
PT
PU
PV
KYE

Zahnzangen, amerikanische Modelle
 Extracting forceps, american pattern
 Fórceps de extracción, forma americana
 Daviers, modèle américaine
 Pinza per estrazione, modello americano



Fig.1
 PB 001/00



Fig.1A
 PB 001/01

ZAHNZANGEN EXTRACTING FORCEPS FORCEPS DE EXTRACCION DAVIERS PINZA PER ESTRAZIONE

Zahnzangen, amerikanische Modelle
 Extracting forceps, american pattern
 Fórceps de extracción, forma americana
 Daviers, modèle americaine
 Pinza per estrazione, modello americano



WOODWARD
 Fig.3FS
 PB 003/09



Fig.10S
 PB 010/09

AA
 AB
 AC
 AD
 AE
 AF
 AG
 AH
 AI
 AJ
 AK
 AL
 AM
 AN
 AO
 AP
 AQ
 AR
 AS
 AT
 AU
 AV
 AW
 AX
 AY
 AZ
 BA
 BB
 BC
 BD
 BE
 BF
 BG
 BH
 BI
 BJ
 BK
 BL
 BM
 BN
 BO
 BP
 BQ
 BR
 BS
 BT
 BU
 BV
 BW
 BX
 BY
 BZ
 CA
 CB
 CC
 CD
 CE
 CF
 CG
 CH
 CI
 CJ
 CK
 CL
 CM
 CN
 CO
 CP
 CQ
 CR
 CS
 CT
 CU
 CV
 CW
 CX
 CY
 CZ
 DA
 DB
 DC
 DD
 DE
 DF
 DG
 DH
 DI
 DJ
 DK
 DL
 DM
 DN
 DO
 DP
 DQ
 DR
 DS
 DT
 DU
 DV
 DW
 DX
 DY
 DZ
 EA
 EB
 EC
 ED
 EE
 EF
 EG
 EH
 EI
 EJ
 EK
 EL
 EM
 EN
 EO
 EP
 EQ
 ER
 ES
 ET
 EU
 EV
 EW
 EX
 EY
 EZ
 FA
 FB
 FC
 FD
 FE
 FF
 FG
 FH
 FI
 FJ
 FK
 FL
 FM
 FN
 FO
 FP
 FQ
 FR
 FS
 FT
 FU
 FV
 FW
 FX
 FY
 FZ
 GA
 GB
 GC
 GD
 GE
 GF
 GG
 GH
 GI
 GJ
 GK
 GL
 GM
 GN
 GO
 GP
 GQ
 GR
 GS
 GT
 GU
 GV
 GW
 GX
 GY
 GZ
 HA
 HB
 HC
 HD
 HE
 HF
 HG
 HH
 HI
 HJ
 HK
 HL
 HM
 HN
 HO
 HP
 HQ
 HR
 HS
 HT
 HU
 HV
 HW
 HX
 HY
 HZ
 IA
 IB
 IC
 ID
 IE
 IF
 IG
 IH
 II
 IJ
 IK
 IL
 IM
 IN
 IO
 IP
 IQ
 IR
 IS
 IT
 IU
 IV
 IW
 IX
 IY
 IZ
 JA
 JB
 JC
 JD
 JE
 JF
 JG
 JH
 JI
 JJ
 JK
 JL
 JM
 JN
 JO
 JP
 JQ
 JR
 JS
 JT
 JU
 JV
 JW
 JX
 JY
 JZ
 KA
 KB
 KC
 KD
 KE
 KF
 KG
 KH
 KI
 KJ
 KK
 KL
 KM
 KN
 KO
 KP
 KQ
 KR
 KS
 KT
 KU
 KV
 KW
 KX
 KY
 KZ
 LA
 LB
 LC
 LD
 LE
 LF
 LG
 LH
 LI
 LJ
 LK
 LL
 LM
 LN
 LO
 LP
 LQ
 LR
 LS
 LT
 LU
 LV
 LW
 LX
 LY
 LZ
 MA
 MB
 MC
 MD
 ME
 MF
 MG
 MH
 MI
 MJ
 MK
 ML
 MM
 MN
 MO
 MP
 MQ
 MR
 MS
 MT
 MU
 MV
 MW
 MX
 MY
 MZ
 NA
 NB
 NC
 ND
 NE
 NF
 NG
 NH
 NI
 NJ
 NK
 NL
 NM
 NN
 NO
 NP
 NQ
 NR
 NS
 NT
 NU
 NV
 NW
 NX
 NY
 NZ
 OA
 OB
 OC
 OD
 OE
 OF
 OG
 OH
 OI
 OJ
 OK
 OL
 OM
 ON
 OO
 OP
 OQ
 OR
 OS
 OT
 OU
 OV
 OW
 OX
 OY
 OZ
 PA
 PB
 PC
 PD
 PE
 PF
 PG
 PH
 PI
 PJ
 PK
 PL
 PM
 PN
 PO
 PP
 PQ
 PR
 PS
 PT
 PU
 PV
 PW
 PX
 PY
 PZ
 QA
 QB
 QC
 QD
 QE
 QF
 QG
 QH
 QI
 QJ
 QK
 QL
 QM
 QN
 QO
 QP
 QQ
 QR
 QS
 QT
 QU
 QV
 QW
 QX
 QY
 QZ
 RA
 RB
 RC
 RD
 RE
 RF
 RG
 RH
 RI
 RJ
 RK
 RL
 RM
 RN
 RO
 RP
 RQ
 RR
 RS
 RT
 RU
 RV
 RW
 RX
 RY
 RZ
 SA
 SB
 SC
 SD
 SE
 SF
 SG
 SH
 SI
 SJ
 SK
 SL
 SM
 SN
 SO
 SP
 SQ
 SR
 SS
 ST
 SU
 SV
 SW
 SX
 SY
 SZ
 TA
 TB
 TC
 TD
 TE
 TF
 TG
 TH
 TI
 TJ
 TK
 TL
 TM
 TN
 TO
 TP
 TQ
 TR
 TS
 TT
 TU
 TV
 TW
 TX
 TY
 TZ
 UA
 UB
 UC
 UD
 UE
 UF
 UG
 UH
 UI
 UJ
 UK
 UL
 UM
 UN
 UO
 UP
 UQ
 UR
 US
 UT
 UU
 UV
 UW
 UX
 UY
 UZ
 VA
 VB
 VC
 VD
 VE
 VF
 VG
 VH
 VI
 VJ
 VK
 VL
 VM
 VN
 VO
 VP
 VQ
 VR
 VS
 VT
 VU
 VV
 VW
 VX
 VY
 VZ
 WA
 WB
 WC
 WD
 WE
 WF
 WG
 WH
 WI
 WJ
 WK
 WL
 WM
 WN
 WO
 WP
 WQ
 WR
 WS
 WT
 WU
 WV
 WW
 WX
 WY
 WZ
 XA
 XB
 XC
 XD
 XE
 XF
 XG
 XH
 XI
 XJ
 XK
 XL
 XM
 XN
 XO
 XP
 XQ
 XR
 XS
 XT
 XU
 XV
 XW
 XX
 XY
 XZ
 YA
 YB
 YC
 YD
 YE
 YF
 YG
 YH
 YI
 YJ
 YK
 YL
 YM
 YN
 YO
 YP
 YQ
 YR
 YS
 YT
 YU
 YV
 YW
 YX
 YZ
 ZA
 ZB
 ZC
 ZD
 ZE
 ZF
 ZG
 ZH
 ZI
 ZJ
 ZK
 ZL
 ZM
 ZN
 ZO
 ZP
 ZQ
 ZR
 ZS
 ZT
 ZU
 ZV
 ZW
 ZX
 ZY
 ZZ

Zahnzangen, amerikanische Modelle
 Extracting forceps, american pattern
 Fórceps de extracción, forma americana
 Daviers, modèle américaine
 Pinza per estrazione, modello americano



Fig.15
 PB 015/00



Fig.16
 PB 016/00

ZAHNZANGEN EXTRACTING FORCEPS FORCEPS DE EXTRACCION DAVIERS PINZA PER ESTRAZIONE

Zahnzangen, amerikanische Modelle
 Extracting forceps, american pattern
 Fórceps de extracción, forma americana
 Daviers, modèle américaine
 Pinza per estrazione, modello americano



Fig.17
 PB 017/00

AA
 AB
 AC
 AD
 AE
 AF
 AK
 AL
 AO
 AR
 KA
 KL
 KU
 PA
PB
 PF
 PI
 PK
 PL
 PM
 PP
 PS
 PT
 PU
 PV
 KYE

Zahnzangen, amerikanische Modelle
 Extracting forceps, american pattern
 Fórceps de extracción, forma americana
 Daviers, modèle américaine
 Pinza per estrazione, modello americano



HARRIS
 Fig.18L
 PB 018/05



HARRIS
 Fig.18R
 PB 018/08

ZAHNZANGEN EXTRACTING FORCEPS FORCEPS DE EXTRACCION DAVIERS PINZA PER ESTRAZIONE

Zahnzangen, amerikanische Modelle
 Extracting forceps, american pattern
 Fórceps de extracción, forma americana
 Daviers, modèle américaine
 Pinza per estrazione, modello americano



Fig.23
 PB 023/00



Fig.24
 PB 024/00

AA
 AB
 AC
 AD
 AE
 AF
 AK
 AL
 AO
 AR
 KA
 KL
 KU
 PA
PB
 PF
 PI
 PK
 PL
 PM
 PP
 PS
 PT
 PU
 PV
 KYE

Zahnzangen, amerikanische Modelle
 Extracting forceps, american pattern
 Fórceps de extracción, forma americana
 Daviers, modèle américaine
 Pinza per estrazione, modello americano



PARMLY
 Fig.32
 PB 032/00



PARMLY
 Fig.32A
 PB 032/01

ZAHNZANGEN EXTRACTING FORCEPS FORCEPS DE EXTRACCION DAVIERS PINZA PER ESTRAZIONE

Zahnzangen, amerikanische Modelle
 Extracting forceps, american pattern
 Fórceps de extracción, forma americana
 Daviers, modèle americaine
 Pinza per estrazione, modello americano



Fig.53L
 PB 053/05

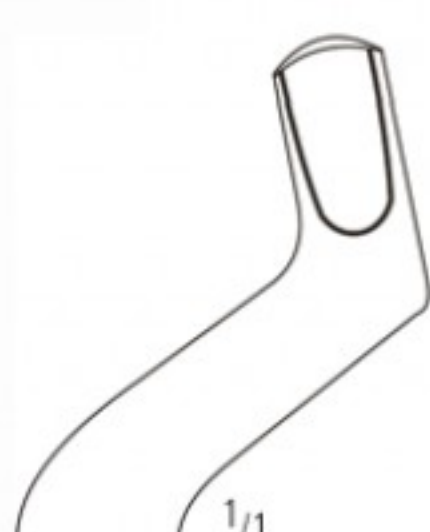

Fig.53R
 PB 053/08

AA
 AB
 AC
 AD
 AE
 AF
 AK
 AL
 AO
 AR
 KA
 KL
 KU
 PA
PB
 PF
 PI
 PK
 PL
 PM
 PP
 PS
 PT
 PU
 PV
 KYE

Zahnzangen, amerikanische Modelle
 Extracting forceps, american pattern
 Fórceps de extracción, forma americana
 Daviers, modèle americaine
 Pinza per estrazione, modello americano



Fig.62
 PB 062/00



Fig.65
 PB 065/00



TOMES
 Fig.69
 PB 069/00

ZAHNZANGEN EXTRACTING FORCEPS FORCEPS DE EXTRACCION DAVIERS PINZA PER ESTRAZIONE

Zahnzangen, amerikanische Modelle
 Extracting forceps, american pattern
 Fórceps de extracción, forma americana
 Daviers, modèle américaine
 Pinza per estrazione, modello americano



NEVIUS
 Fig.88L
 PB 088/05



NEVIUS
 Fig.88R
 PB 088/08

AA
 AB
 AC
 AD
 AE
 AF
 AG
 AH
 AI
 AJ
 AK
 AL
 AO
 AP
 AQ
 AR
 AS
 AT
 AU
 AV
 AW
 AX
 AY
 AZ
 BA
 BB
 BC
 BD
 BE
 BF
 BG
 BH
 BI
 BJ
 BK
 BL
 BM
 BN
 BO
 BP
 BQ
 BR
 BS
 BT
 BU
 BV
 BW
 BX
 BY
 BZ
 CA
 CB
 CC
 CD
 CE
 CF
 CG
 CH
 CI
 CJ
 CK
 CL
 CM
 CN
 CO
 CP
 CQ
 CR
 CS
 CT
 CU
 CV
 CW
 CX
 CY
 CZ
 DA
 DB
 DC
 DD
 DE
 DF
 DG
 DH
 DI
 DJ
 DK
 DL
 DM
 DN
 DO
 DP
 DQ
 DR
 DS
 DT
 DU
 DV
 DW
 DX
 DY
 DZ
 EA
 EB
 EC
 ED
 EE
 EF
 EG
 EH
 EI
 EJ
 EK
 EL
 EM
 EN
 EO
 EP
 EQ
 ER
 ES
 ET
 EU
 EV
 EW
 EX
 EY
 EZ
 FA
 FB
 FC
 FD
 FE
 FF
 FG
 FH
 FI
 FJ
 FK
 FL
 FM
 FN
 FO
 FP
 FQ
 FR
 FS
 FT
 FU
 FV
 FW
 FX
 FY
 FZ
 GA
 GB
 GC
 GD
 GE
 GF
 GG
 GH
 GI
 GJ
 GK
 GL
 GM
 GN
 GO
 GP
 GQ
 GR
 GS
 GT
 GU
 GV
 GW
 GX
 GY
 GZ
 HA
 HB
 HC
 HD
 HE
 HF
 HG
 HH
 HI
 HJ
 HK
 HL
 HM
 HN
 HO
 HP
 HQ
 HR
 HS
 HT
 HU
 HV
 HW
 HX
 HY
 HZ
 IA
 IB
 IC
 ID
 IE
 IF
 IG
 IH
 II
 IJ
 IK
 IL
 IM
 IN
 IO
 IP
 IQ
 IR
 IS
 IT
 IU
 IV
 IW
 IX
 IY
 IZ
 JA
 JB
 JC
 JD
 JE
 JF
 JG
 JH
 JI
 JJ
 JK
 JL
 JM
 JN
 JO
 JP
 JQ
 JR
 JS
 JT
 JU
 JV
 JW
 JX
 JY
 JZ
 KA
 KB
 KC
 KD
 KE
 KF
 KG
 KH
 KI
 KJ
 KK
 KL
 KM
 KN
 KO
 KP
 KQ
 KR
 KS
 KT
 KU
 KV
 KW
 KX
 KY
 KZ
 LA
 LB
 LC
 LD
 LE
 LF
 LG
 LH
 LI
 LJ
 LK
 LL
 LM
 LN
 LO
 LP
 LQ
 LR
 LS
 LT
 LU
 LV
 LW
 LX
 LY
 LZ
 MA
 MB
 MC
 MD
 ME
 MF
 MG
 MH
 MI
 MJ
 MK
 ML
 MM
 MN
 MO
 MP
 MQ
 MR
 MS
 MT
 MU
 MV
 MW
 MX
 MY
 MZ
 NA
 NB
 NC
 ND
 NE
 NF
 NG
 NH
 NI
 NJ
 NK
 NL
 NM
 NN
 NO
 NP
 NQ
 NR
 NS
 NT
 NU
 NV
 NW
 NX
 NY
 NZ
 OA
 OB
 OC
 OD
 OE
 OF
 OG
 OH
 OI
 OJ
 OK
 OL
 OM
 ON
 OO
 OP
 OQ
 OR
 OS
 OT
 OU
 OV
 OW
 OX
 OY
 OZ
 PA
 PB
 PC
 PD
 PE
 PF
 PG
 PH
 PI
 PJ
 PK
 PL
 PM
 PN
 PO
 PP
 PQ
 PR
 PS
 PT
 PU
 PV
 PW
 PX
 PY
 PZ
 QA
 QB
 QC
 QD
 QE
 QF
 QG
 QH
 QI
 QJ
 QK
 QL
 QM
 QN
 QO
 QP
 QQ
 QR
 QS
 QT
 QU
 QV
 QW
 QX
 QY
 QZ
 RA
 RB
 RC
 RD
 RE
 RF
 RG
 RH
 RI
 RJ
 RK
 RL
 RM
 RN
 RO
 RP
 RQ
 RR
 RS
 RT
 RU
 RV
 RW
 RX
 RY
 RZ
 SA
 SB
 SC
 SD
 SE
 SF
 SG
 SH
 SI
 SJ
 SK
 SL
 SM
 SN
 SO
 SP
 SQ
 SR
 SS
 ST
 SU
 SV
 SW
 SX
 SY
 SZ
 TA
 TB
 TC
 TD
 TE
 TF
 TG
 TH
 TI
 TJ
 TK
 TL
 TM
 TN
 TO
 TP
 TQ
 TR
 TS
 TT
 TU
 TV
 TW
 TX
 TY
 TZ
 UA
 UB
 UC
 UD
 UE
 UF
 UG
 UH
 UI
 UJ
 UK
 UL
 UM
 UN
 UO
 UP
 UQ
 UR
 US
 UT
 UU
 UV
 UW
 UX
 UY
 UZ
 VA
 VB
 VC
 VD
 VE
 VF
 VG
 VH
 VI
 VJ
 VK
 VL
 VM
 VN
 VO
 VP
 VQ
 VR
 VS
 VT
 VU
 VV
 VW
 VX
 VY
 VZ
 WA
 WB
 WC
 WD
 WE
 WF
 WG
 WH
 WI
 WJ
 WK
 WL
 WM
 WN
 WO
 WP
 WQ
 WR
 WS
 WT
 WU
 WV
 WW
 WX
 WY
 WZ
 XA
 XB
 XC
 XD
 XE
 XF
 XG
 XH
 XI
 XJ
 XK
 XL
 XM
 XN
 XO
 XP
 XQ
 XR
 XS
 XT
 XU
 XV
 XW
 XX
 XY
 XZ
 YA
 YB
 YC
 YD
 YE
 YF
 YG
 YH
 YI
 YJ
 YK
 YL
 YM
 YN
 YO
 YP
 YQ
 YR
 YS
 YT
 YU
 YV
 YW
 YX
 YZ
 ZA
 ZB
 ZC
 ZD
 ZE
 ZF
 ZG
 ZH
 ZI
 ZJ
 ZK
 ZL
 ZM
 ZN
 ZO
 ZP
 ZQ
 ZR
 ZS
 ZT
 ZU
 ZV
 ZW
 ZX
 ZY
 ZZ

Zahnzangen, amerikanische Modelle
 Extracting forceps, american pattern
 Fórceps de extracción, forma americana
 Daviers, modèle americaine
 Pinza per estrazione, modello americano



CRYER
 Fig.150
 PB 150/00



CRYER
 Fig.150A
 PB 150/01



Fig.150X
 PB 150/02

ZAHNZANGEN EXTRACTING FORCEPS FORCEPS DE EXTRACCION DAVIERS PINZA PER ESTRAZIONE

Zahnzangen, amerikanische Modelle
 Extracting forceps, american pattern
 Fórceps de extracción, forma americana
 Daviers, modèle américaine
 Pinza per estrazione, modello americano



Fig.150AS
 PB 150/03



Fig.150S
 PB 150/09

AA
 AB
 AC
 AD
 AE
 AF
 AK
 AL
 AO
 AR
 KA
 KL
 KU
 PA
PB
 PF
 PI
 PK
 PL
 PM
 PP
 PS
 PT
 PU
 PV
 KYE

Zahnzangen, amerikanische Modelle
 Extracting forceps, american pattern
 Fórceps de extracción, forma americana
 Daviers, modèle américaine
 Pinza per estrazione, modello americano



CRYER
 Fig.151
 PB 151/00



CRYER
 Fig.151A
 PB 151/01



CRYER
 Fig.151X
 PB 151/02

ZAHNZANGEN EXTRACTING FORCEPS FORCEPS DE EXTRACCION DAVIERS PINZA PER ESTRAZIONE

Zahnzangen, amerikanische Modelle
 Extracting forceps, american pattern
 Fórceps de extracción, forma americana
 Daviers, modèle américaine
 Pinza per estrazione, modello americano



Fig.151AS
 PB 151/08



CRYER
 Fig.151S
 PB 151/09

AA
 AB
 AC
 AD
 AE
 AF
 AG
 AH
 AI
 AJ
 AK
 AL
 AO
 AP
 AQ
 AR
 AS
 AT
 AU
 AV
 AW
 AX
 AY
 AZ
 BA
 BB
 BC
 BD
 BE
 BF
 BG
 BH
 BI
 BJ
 BK
 BL
 BM
 BN
 BO
 BP
 BQ
 BR
 BS
 BT
 BU
 BV
 BW
 BX
 BY
 BZ
 CA
 CB
 CC
 CD
 CE
 CF
 CG
 CH
 CI
 CJ
 CK
 CL
 CM
 CN
 CO
 CP
 CQ
 CR
 CS
 CT
 CU
 CV
 CW
 CX
 CY
 CZ
 DA
 DB
 DC
 DD
 DE
 DF
 DG
 DH
 DI
 DJ
 DK
 DL
 DM
 DN
 DO
 DP
 DQ
 DR
 DS
 DT
 DU
 DV
 DW
 DX
 DY
 DZ
 EA
 EB
 EC
 ED
 EE
 EF
 EG
 EH
 EI
 EJ
 EK
 EL
 EM
 EN
 EO
 EP
 EQ
 ER
 ES
 ET
 EU
 EV
 EW
 EX
 EY
 EZ
 FA
 FB
 FC
 FD
 FE
 FF
 FG
 FH
 FI
 FJ
 FK
 FL
 FM
 FN
 FO
 FP
 FQ
 FR
 FS
 FT
 FU
 FV
 FW
 FX
 FY
 FZ
 GA
 GB
 GC
 GD
 GE
 GF
 GG
 GH
 GI
 GJ
 GK
 GL
 GM
 GN
 GO
 GP
 GQ
 GR
 GS
 GT
 GU
 GV
 GW
 GX
 GY
 GZ
 HA
 HB
 HC
 HD
 HE
 HF
 HG
 HH
 HI
 HJ
 HK
 HL
 HM
 HN
 HO
 HP
 HQ
 HR
 HS
 HT
 HU
 HV
 HW
 HX
 HY
 HZ
 IA
 IB
 IC
 ID
 IE
 IF
 IG
 IH
 II
 IJ
 IK
 IL
 IM
 IN
 IO
 IP
 IQ
 IR
 IS
 IT
 IU
 IV
 IW
 IX
 IY
 IZ
 JA
 JB
 JC
 JD
 JE
 JF
 JG
 JH
 JI
 JJ
 JK
 JL
 JM
 JN
 JO
 JP
 JQ
 JR
 JS
 JT
 JU
 JV
 JW
 JX
 JY
 JZ
 KA
 KB
 KC
 KD
 KE
 KF
 KG
 KH
 KI
 KJ
 KK
 KL
 KM
 KN
 KO
 KP
 KQ
 KR
 KS
 KT
 KU
 KV
 KW
 KX
 KY
 KZ
 LA
 LB
 LC
 LD
 LE
 LF
 LG
 LH
 LI
 LJ
 LK
 LL
 LM
 LN
 LO
 LP
 LQ
 LR
 LS
 LT
 LU
 LV
 LW
 LX
 LY
 LZ
 MA
 MB
 MC
 MD
 ME
 MF
 MG
 MH
 MI
 MJ
 MK
 ML
 MM
 MN
 MO
 MP
 MQ
 MR
 MS
 MT
 MU
 MV
 MW
 MX
 MY
 MZ
 NA
 NB
 NC
 ND
 NE
 NF
 NG
 NH
 NI
 NJ
 NK
 NL
 NM
 NN
 NO
 NP
 NQ
 NR
 NS
 NT
 NU
 NV
 NW
 NX
 NY
 NZ
 OA
 OB
 OC
 OD
 OE
 OF
 OG
 OH
 OI
 OJ
 OK
 OL
 OM
 ON
 OO
 OP
 OQ
 OR
 OS
 OT
 OU
 OV
 OW
 OX
 OY
 OZ
 PA
 PB
 PC
 PD
 PE
 PF
 PG
 PH
 PI
 PJ
 PK
 PL
 PM
 PN
 PO
 PP
 PQ
 PR
 PS
 PT
 PU
 PV
 PW
 PX
 PY
 PZ
 QA
 QB
 QC
 QD
 QE
 QF
 QG
 QH
 QI
 QJ
 QK
 QL
 QM
 QN
 QO
 QP
 QQ
 QR
 QS
 QT
 QU
 QV
 QW
 QX
 QY
 QZ
 RA
 RB
 RC
 RD
 RE
 RF
 RG
 RH
 RI
 RJ
 RK
 RL
 RM
 RN
 RO
 RP
 RQ
 RR
 RS
 RT
 RU
 RV
 RW
 RX
 RY
 RZ
 SA
 SB
 SC
 SD
 SE
 SF
 SG
 SH
 SI
 SJ
 SK
 SL
 SM
 SN
 SO
 SP
 SQ
 SR
 SS
 ST
 SU
 SV
 SW
 SX
 SY
 SZ
 TA
 TB
 TC
 TD
 TE
 TF
 TG
 TH
 TI
 TJ
 TK
 TL
 TM
 TN
 TO
 TP
 TQ
 TR
 TS
 TT
 TU
 TV
 TW
 TX
 TY
 TZ
 UA
 UB
 UC
 UD
 UE
 UF
 UG
 UH
 UI
 UJ
 UK
 UL
 UM
 UN
 UO
 UP
 UQ
 UR
 US
 UT
 UU
 UV
 UW
 UX
 UY
 UZ
 VA
 VB
 VC
 VD
 VE
 VF
 VG
 VH
 VI
 VJ
 VK
 VL
 VM
 VN
 VO
 VP
 VQ
 VR
 VS
 VT
 VU
 VV
 VW
 VX
 VY
 VZ
 WA
 WB
 WC
 WD
 WE
 WF
 WG
 WH
 WI
 WJ
 WK
 WL
 WM
 WN
 WO
 WP
 WQ
 WR
 WS
 WT
 WU
 WV
 WW
 WX
 WY
 WZ
 XA
 XB
 XC
 XD
 XE
 XF
 XG
 XH
 XI
 XJ
 XK
 XL
 XM
 XN
 XO
 XP
 XQ
 XR
 XS
 XT
 XU
 XV
 XW
 XX
 XY
 XZ
 YA
 YB
 YC
 YD
 YE
 YF
 YG
 YH
 YI
 YJ
 YK
 YL
 YM
 YN
 YO
 YP
 YQ
 YR
 YS
 YT
 YU
 YV
 YW
 YX
 YZ
 ZA
 ZB
 ZC
 ZD
 ZE
 ZF
 ZG
 ZH
 ZI
 ZJ
 ZK
 ZL
 ZM
 ZN
 ZO
 ZP
 ZQ
 ZR
 ZS
 ZT
 ZU
 ZV
 ZW
 ZX
 ZY
 ZZ

Zahnzangen, amerikanische Modelle
 Extracting forceps, american pattern
 Fórceps de extracción, forma americana
 Daviers, modèle américaine
 Pinza per estrazione, modello americano



KELLS
 Fig.99C
 PB 199/03



Fig.210H
 PB 210/04



Fig.222
 PB 222/00

ZAHNZANGEN EXTRACTING FORCEPS FORCEPS DE EXTRACCION DAVIERS PINZA PER ESTRAZIONE

Kinderzahnzangen, amerikanische Modelle
 Extracting forceps for children, american pattern
 Fórceps de extracción para niños, forma americana
 Daviers pour enfants, modèle americaine
 Pinze per estrazione per bambini, modello americano



Fig.17SK
 PB 517/09



Fig.23SK
 PB 523/09

AA
 AB
 AC
 AD
 AE
 AF
 AK
 AL
 AO
 AR
 KA
 KL
 KU
 PA
PB
 PF
 PI
 PK
 PL
 PM
 PP
 PS
 PT
 PU
 PV
 KYE

Kinderzahnzangen, amerikanische Modelle
 Extracting forceps for children, american pattern
 Fórceps de extracción para niños, forma americana
 Daviers pour enfants, modèle américaine
 Pinze per estrazione per bambini, modello americano



Fig.150 SK
PB 550/09



Fig.151 SK
PB 551/09

WURZELHEBER
ROOT ELEVATORS
ELEVADORES PARA RAICES
ELEVATEURS A RACINES
ELEVATORI PER RADICI

PF

nopa[®] instruments



WURZELHEBER ROOT ELEVATORS ELEVADORES PARA RAICES ELEVATEURS A RACINES ELEVATORI PER RADICI

Wurzelheber
 Root elevators
 Elevadores para raíces
 Elevateurs à racines
 Elevatori per radici



FLOHR
 15,0 cm/6"



Fig.1
 PF 001/01



Fig.2
 PF 001/02



Fig.3
 PF 001/03

AA
 AB
 AC
 AD
 AE
 AF
 AK
 AL
 AO
 AR
 KA
 KL
 KU
 PA
 PB
PF
 PI
 PK
 PL
 PM
 PP
 PS
 PT
 PU
 PV
 KYE

Wurzelheber
 Root elevators
 Elevadores para raíces
 Elevateurs à racines
 Elevatori per radici



CRYER
 15,0 cm/6"

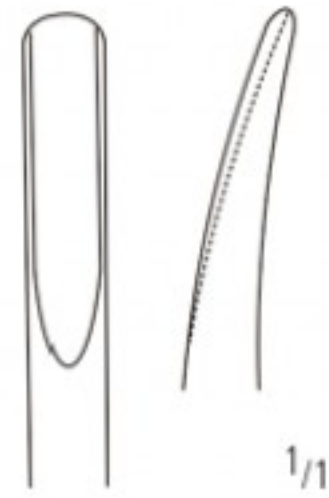

Fig.3A
 PF 002/03

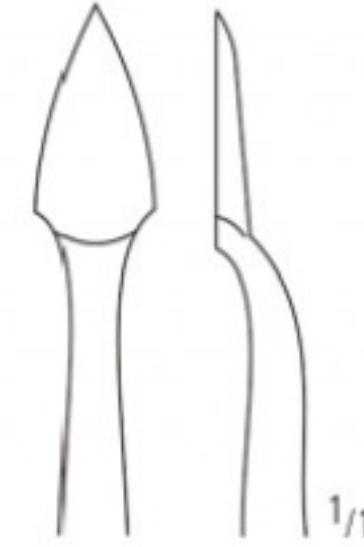

Fig.12
 PF 002/12



Fig.27
 PF 002/27



Fig.28
 PF 002/28



Fig.39
 PF 002/39



Fig.40
 PF 002/40

WURZELHEBER ROOT ELEVATORS ELEVADORES PARA RAICES ELEVATEURS A RACINES ELEVATORI PER RADICI

Wurzelheber
 Root elevators
 Elevadores para raíces
 Elevateurs à racines
 Elevatori per radici



APICAL
 15,0 cm/6"



Fig.2
 PF 003/02



Fig.3
 PF 003/03



Fig.4
 PF 003/04



Fig.1A
 PF 003/11



Fig.2A
 PF 003/12



Fig.3A
 PF 003/13



Fig.4A
 PF 003/14

AA
 AB
 AC
 AD
 AE
 AF
 AG
 AH
 AI
 AJ
 AK
 AL
 AM
 AN
 AO
 AP
 AQ
 AR
 AS
 AT
 AU
 AV
 AW
 AX
 AY
 AZ
 BA
 BB
 BC
 BD
 BE
 BF
 BG
 BH
 BI
 BJ
 BK
 BL
 BM
 BN
 BO
 BP
 BQ
 BR
 BS
 BT
 BU
 BV
 BW
 BX
 BY
 BZ
 CA
 CB
 CC
 CD
 CE
 CF
 CG
 CH
 CI
 CJ
 CK
 CL
 CM
 CN
 CO
 CP
 CQ
 CR
 CS
 CT
 CU
 CV
 CW
 CX
 CY
 CZ
 DA
 DB
 DC
 DD
 DE
 DF
 DG
 DH
 DI
 DJ
 DK
 DL
 DM
 DN
 DO
 DP
 DQ
 DR
 DS
 DT
 DU
 DV
 DW
 DX
 DY
 DZ
 EA
 EB
 EC
 ED
 EE
 EF
 EG
 EH
 EI
 EJ
 EK
 EL
 EM
 EN
 EO
 EP
 EQ
 ER
 ES
 ET
 EU
 EV
 EW
 EX
 EY
 EZ
 FA
 FB
 FC
 FD
 FE
 FF
 FG
 FH
 FI
 FJ
 FK
 FL
 FM
 FN
 FO
 FP
 FQ
 FR
 FS
 FT
 FU
 FV
 FW
 FX
 FY
 FZ
 GA
 GB
 GC
 GD
 GE
 GF
 GG
 GH
 GI
 GJ
 GK
 GL
 GM
 GN
 GO
 GP
 GQ
 GR
 GS
 GT
 GU
 GV
 GW
 GX
 GY
 GZ
 HA
 HB
 HC
 HD
 HE
 HF
 HG
 HH
 HI
 HJ
 HK
 HL
 HM
 HN
 HO
 HP
 HQ
 HR
 HS
 HT
 HU
 HV
 HW
 HX
 HY
 HZ
 IA
 IB
 IC
 ID
 IE
 IF
 IG
 IH
 II
 IJ
 IK
 IL
 IM
 IN
 IO
 IP
 IQ
 IR
 IS
 IT
 IU
 IV
 IW
 IX
 IY
 IZ
 JA
 JB
 JC
 JD
 JE
 JF
 JG
 JH
 JI
 JJ
 JK
 JL
 JM
 JN
 JO
 JP
 JQ
 JR
 JS
 JT
 JU
 JV
 JW
 JX
 JY
 JZ
 KA
 KB
 KC
 KD
 KE
 KF
 KG
 KH
 KI
 KJ
 KK
 KL
 KM
 KN
 KO
 KP
 KQ
 KR
 KS
 KT
 KU
 KV
 KW
 KX
 KY
 KZ
 LA
 LB
 LC
 LD
 LE
 LF
 LG
 LH
 LI
 LJ
 LK
 LL
 LM
 LN
 LO
 LP
 LQ
 LR
 LS
 LT
 LU
 LV
 LW
 LX
 LY
 LZ
 MA
 MB
 MC
 MD
 ME
 MF
 MG
 MH
 MI
 MJ
 MK
 ML
 MM
 MN
 MO
 MP
 MQ
 MR
 MS
 MT
 MU
 MV
 MW
 MX
 MY
 MZ
 NA
 NB
 NC
 ND
 NE
 NF
 NG
 NH
 NI
 NJ
 NK
 NL
 NM
 NN
 NO
 NP
 NQ
 NR
 NS
 NT
 NU
 NV
 NW
 NX
 NY
 NZ
 OA
 OB
 OC
 OD
 OE
 OF
 OG
 OH
 OI
 OJ
 OK
 OL
 OM
 ON
 OO
 OP
 OQ
 OR
 OS
 OT
 OU
 OV
 OW
 OX
 OY
 OZ
 PA
 PB
 PC
 PD
 PE
 PF
 PG
 PH
 PI
 PJ
 PK
 PL
 PM
 PN
 PO
 PP
 PQ
 PR
 PS
 PT
 PU
 PV
 PW
 PX
 PY
 PZ
 QA
 QB
 QC
 QD
 QE
 QF
 QG
 QH
 QI
 QJ
 QK
 QL
 QM
 QN
 QO
 QP
 QQ
 QR
 QS
 QT
 QU
 QV
 QW
 QX
 QY
 QZ
 RA
 RB
 RC
 RD
 RE
 RF
 RG
 RH
 RI
 RJ
 RK
 RL
 RM
 RN
 RO
 RP
 RQ
 RR
 RS
 RT
 RU
 RV
 RW
 RX
 RY
 RZ
 SA
 SB
 SC
 SD
 SE
 SF
 SG
 SH
 SI
 SJ
 SK
 SL
 SM
 SN
 SO
 SP
 SQ
 SR
 SS
 ST
 SU
 SV
 SW
 SX
 SY
 SZ
 TA
 TB
 TC
 TD
 TE
 TF
 TG
 TH
 TI
 TJ
 TK
 TL
 TM
 TN
 TO
 TP
 TQ
 TR
 TS
 TT
 TU
 TV
 TW
 TX
 TY
 TZ
 UA
 UB
 UC
 UD
 UE
 UF
 UG
 UH
 UI
 UJ
 UK
 UL
 UM
 UN
 UO
 UP
 UQ
 UR
 US
 UT
 UY
 UZ
 VA
 VB
 VC
 VD
 VE
 VF
 VG
 VH
 VI
 VJ
 VK
 VL
 VM
 VN
 VO
 VP
 VQ
 VR
 VS
 VT
 VU
 VV
 VW
 VX
 VY
 VZ
 WA
 WB
 WC
 WD
 WE
 WF
 WG
 WH
 WI
 WJ
 WK
 WL
 WM
 WN
 WO
 WP
 WQ
 WR
 WS
 WT
 WU
 WV
 WW
 WX
 WY
 WZ
 XA
 XB
 XC
 XD
 XE
 XF
 XG
 XH
 XI
 XJ
 XK
 XL
 XM
 XN
 XO
 XP
 XQ
 XR
 XS
 XT
 XU
 XV
 XW
 XX
 XY
 XZ
 YA
 YB
 YC
 YD
 YE
 YF
 YG
 YH
 YI
 YJ
 YK
 YL
 YM
 YN
 YO
 YP
 YQ
 YR
 YS
 YT
 YU
 YV
 YW
 YX
 YZ
 ZA
 ZB
 ZC
 ZD
 ZE
 ZF
 ZG
 ZH
 ZI
 ZJ
 ZK
 ZL
 ZM
 ZN
 ZO
 ZP
 ZQ
 ZR
 ZS
 ZT
 ZU
 ZV
 ZW
 ZX
 ZY
 ZZ

Wurzelheber
 Root elevators
 Elevadores para raíces
 Elevateurs à racines
 Elevatori per radici



APICAL
 15,0 cm/6"



Fig.301
 PF 003/31



Fig.302
 PF 003/32

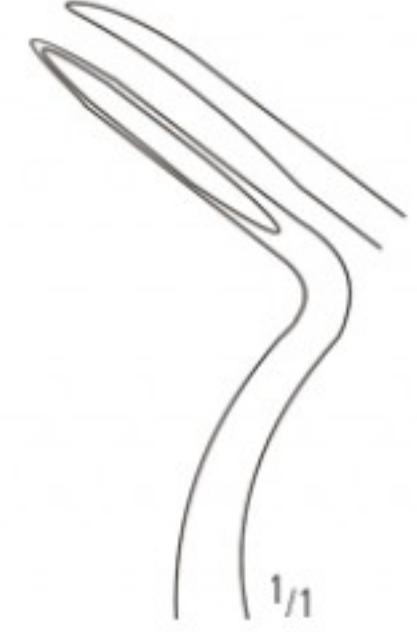

Fig.303
 PF 003/33

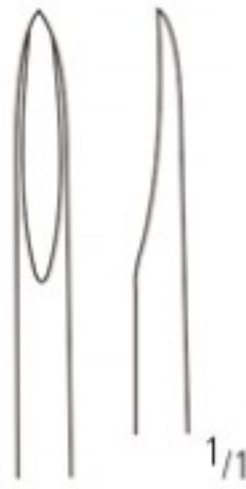

Fig.304
 PF 003/34

WURZELHEBER ROOT ELEVATORS ELEVADORES PARA RAICES ELEVATEURS A RACINES ELEVATORI PER RADICI

Wurzelheber
 Root elevators
 Elevadores para raíces
 Elevateurs à racines
 Elevatori per radici



SELDIN
 15,0 cm/6"



Fig.2
 PF 004/02

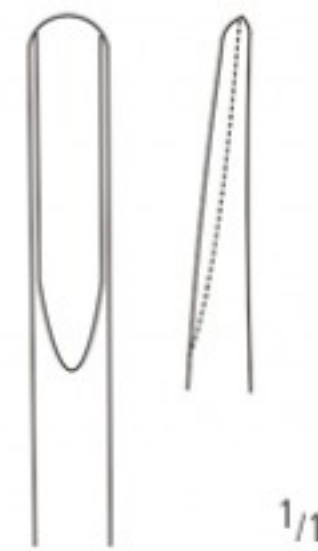

Fig.3
 PF 004/03

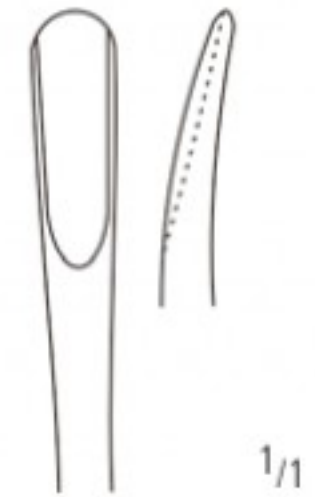

Fig.34
 PF 004/34



Fig.34S
 PF 004/35



Fig.301
 PF 004/36



Fig.77R
 PF 004/40



Fig.1L
 PF 005/01



Fig.1R
 PF 005/02



Fig.4L
 PF 007/01



Fig.4R
 PF 007/02

AA
 AB
 AC
 AD
 AE
 AF
 AG
 AH
 AI
 AJ
 AK
 AL
 AM
 AN
 AO
 AP
 AQ
 AR
 AS
 AT
 AU
 AV
 AW
 AX
 AY
 AZ
 BA
 BB
 BC
 BD
 BE
 BF
 BG
 BH
 BI
 BJ
 BK
 BL
 BM
 BN
 BO
 BP
 BQ
 BR
 BS
 BT
 BU
 BV
 BW
 BX
 BY
 BZ
 CA
 CB
 CC
 CD
 CE
 CF
 CG
 CH
 CI
 CJ
 CK
 CL
 CM
 CN
 CO
 CP
 CQ
 CR
 CS
 CT
 CU
 CV
 CW
 CX
 CY
 CZ
 DA
 DB
 DC
 DD
 DE
 DF
 DG
 DH
 DI
 DJ
 DK
 DL
 DM
 DN
 DO
 DP
 DQ
 DR
 DS
 DT
 DU
 DV
 DW
 DX
 DY
 DZ
 EA
 EB
 EC
 ED
 EE
 EF
 EG
 EH
 EI
 EJ
 EK
 EL
 EM
 EN
 EO
 EP
 EQ
 ER
 ES
 ET
 EU
 EV
 EW
 EX
 EY
 EZ
 FA
 FB
 FC
 FD
 FE
 FF
 FG
 FH
 FI
 FJ
 FK
 FL
 FM
 FN
 FO
 FP
 FQ
 FR
 FS
 FT
 FU
 FV
 FW
 FX
 FY
 FZ
 GA
 GB
 GC
 GD
 GE
 GF
 GG
 GH
 GI
 GJ
 GK
 GL
 GM
 GN
 GO
 GP
 GQ
 GR
 GS
 GT
 GU
 GV
 GW
 GX
 GY
 GZ
 HA
 HB
 HC
 HD
 HE
 HF
 HG
 HH
 HI
 HJ
 HK
 HL
 HM
 HN
 HO
 HP
 HQ
 HR
 HS
 HT
 HU
 HV
 HW
 HX
 HY
 HZ
 IA
 IB
 IC
 ID
 IE
 IF
 IG
 IH
 II
 IJ
 IK
 IL
 IM
 IN
 IO
 IP
 IQ
 IR
 IS
 IT
 IU
 IV
 IW
 IX
 IY
 IZ
 JA
 JB
 JC
 JD
 JE
 JF
 JG
 JH
 JI
 JJ
 JK
 JL
 JM
 JN
 JO
 JP
 JQ
 JR
 JS
 JT
 JU
 JV
 JW
 JX
 JY
 JZ
 KA
 KB
 KC
 KD
 KE
 KF
 KG
 KH
 KI
 KJ
 KK
 KL
 KM
 KN
 KO
 KP
 KQ
 KR
 KS
 KT
 KU
 KV
 KW
 KX
 KY
 KZ
 LA
 LB
 LC
 LD
 LE
 LF
 LG
 LH
 LI
 LJ
 LK
 LL
 LM
 LN
 LO
 LP
 LQ
 LR
 LS
 LT
 LU
 LV
 LW
 LX
 LY
 LZ
 MA
 MB
 MC
 MD
 ME
 MF
 MG
 MH
 MI
 MJ
 MK
 ML
 MM
 MN
 MO
 MP
 MQ
 MR
 MS
 MT
 MU
 MV
 MW
 MX
 MY
 MZ
 NA
 NB
 NC
 ND
 NE
 NF
 NG
 NH
 NI
 NJ
 NK
 NL
 NM
 NN
 NO
 NP
 NQ
 NR
 NS
 NT
 NU
 NV
 NW
 NX
 NY
 NZ
 OA
 OB
 OC
 OD
 OE
 OF
 OG
 OH
 OI
 OJ
 OK
 OL
 OM
 ON
 OO
 OP
 OQ
 OR
 OS
 OT
 OU
 OV
 OW
 OX
 OY
 OZ
 PA
 PB
 PC
 PD
 PE
 PF
 PG
 PH
 PI
 PJ
 PK
 PL
 PM
 PN
 PO
 PP
 PQ
 PR
 PS
 PT
 PU
 PV
 PW
 PX
 PY
 PZ
 QA
 QB
 QC
 QD
 QE
 QF
 QG
 QH
 QI
 QJ
 QK
 QL
 QM
 QN
 QO
 QP
 QQ
 QR
 QS
 QT
 QU
 QV
 QW
 QX
 QY
 QZ
 RA
 RB
 RC
 RD
 RE
 RF
 RG
 RH
 RI
 RJ
 RK
 RL
 RM
 RN
 RO
 RP
 RQ
 RR
 RS
 RT
 RU
 RV
 RW
 RX
 RY
 RZ
 SA
 SB
 SC
 SD
 SE
 SF
 SG
 SH
 SI
 SJ
 SK
 SL
 SM
 SN
 SO
 SP
 SQ
 SR
 SS
 ST
 SU
 SV
 SW
 SX
 SY
 SZ
 TA
 TB
 TC
 TD
 TE
 TF
 TG
 TH
 TI
 TJ
 TK
 TL
 TM
 TN
 TO
 TP
 TQ
 TR
 TS
 TT
 TU
 TV
 TW
 TX
 TY
 TZ
 UA
 UB
 UC
 UD
 UE
 UF
 UG
 UH
 UI
 UJ
 UK
 UL
 UM
 UN
 UO
 UP
 UQ
 UR
 US
 UT
 UY
 UZ
 VA
 VB
 VC
 VD
 VE
 VF
 VG
 VH
 VI
 VJ
 VK
 VL
 VM
 VN
 VO
 VP
 VQ
 VR
 VS
 VT
 VU
 VV
 VW
 VX
 VY
 VZ
 WA
 WB
 WC
 WD
 WE
 WF
 WG
 WH
 WI
 WJ
 WK
 WL
 WM
 WN
 WO
 WP
 WQ
 WR
 WS
 WT
 WU
 WV
 WW
 WX
 WY
 WZ
 XA
 XB
 XC
 XD
 XE
 XF
 XG
 XH
 XI
 XJ
 XK
 XL
 XM
 XN
 XO
 XP
 XQ
 XR
 XS
 XT
 XU
 XV
 XW
 XX
 XY
 XZ
 YA
 YB
 YC
 YD
 YE
 YF
 YG
 YH
 YI
 YJ
 YK
 YL
 YM
 YN
 YO
 YP
 YQ
 YR
 YS
 YT
 YU
 YV
 YW
 YX
 YZ
 ZA
 ZB
 ZC
 ZD
 ZE
 ZF
 ZG
 ZH
 ZI
 ZJ
 ZK
 ZL
 ZM
 ZN
 ZO
 ZP
 ZQ
 ZR
 ZS
 ZT
 ZU
 ZV
 ZW
 ZX
 ZY
 ZZ

Wurzelheber
 Root elevators
 Elevadores para raíces
 Elevateurs à racines
 Elevatori per radici



1/1

COLEMAN
 15,0 cm/6"



Fig.1
 PF 080/01



Fig.2L
 PF 080/02



Fig.3R
 PF 080/03

WURZELHEBER ROOT ELEVATORS ELEVADORES PARA RAICES ELEVATEURS A RACINES ELEVATORI PER RADICI

Wurzelheber
 Root elevators
 Elevadores para raíces
 Elevateurs à racines
 Elevatori per radici



COUPLAND
 15,0 cm/6"



Fig.1
 PF 082/01



Fig.2
 PF 082/02



Fig.3
 PF 082/03

AA
 AB
 AC
 AD
 AE
 AF
 AG
 AH
 AI
 AJ
 AK
 AL
 AM
 AN
 AO
 AP
 AQ
 AR
 AS
 AT
 AU
 AV
 AW
 AX
 AY
 AZ
 BA
 BB
 BC
 BD
 BE
 BF
 BG
 BH
 BI
 BJ
 BK
 BL
 BM
 BN
 BO
 BP
 BQ
 BR
 BS
 BT
 BU
 BV
 BW
 BX
 BY
 BZ
 CA
 CB
 CC
 CD
 CE
 CF
 CG
 CH
 CI
 CJ
 CK
 CL
 CM
 CN
 CO
 CP
 CQ
 CR
 CS
 CT
 CU
 CV
 CW
 CX
 CY
 CZ
 DA
 DB
 DC
 DD
 DE
 DF
 DG
 DH
 DI
 DJ
 DK
 DL
 DM
 DN
 DO
 DP
 DQ
 DR
 DS
 DT
 DU
 DV
 DW
 DX
 DY
 DZ
 EA
 EB
 EC
 ED
 EE
 EF
 EG
 EH
 EI
 EJ
 EK
 EL
 EM
 EN
 EO
 EP
 EQ
 ER
 ES
 ET
 EU
 EV
 EW
 EX
 EY
 EZ
 FA
 FB
 FC
 FD
 FE
 FF
 FG
 FH
 FI
 FJ
 FK
 FL
 FM
 FN
 FO
 FP
 FQ
 FR
 FS
 FT
 FU
 FV
 FW
 FX
 FY
 FZ
 GA
 GB
 GC
 GD
 GE
 GF
 GG
 GH
 GI
 GJ
 GK
 GL
 GM
 GN
 GO
 GP
 GQ
 GR
 GS
 GT
 GU
 GV
 GW
 GX
 GY
 GZ
 HA
 HB
 HC
 HD
 HE
 HF
 HG
 HH
 HI
 HJ
 HK
 HL
 HM
 HN
 HO
 HP
 HQ
 HR
 HS
 HT
 HU
 HV
 HW
 HX
 HY
 HZ
 IA
 IB
 IC
 ID
 IE
 IF
 IG
 IH
 II
 IJ
 IK
 IL
 IM
 IN
 IO
 IP
 IQ
 IR
 IS
 IT
 IU
 IV
 IW
 IX
 IY
 IZ
 JA
 JB
 JC
 JD
 JE
 JF
 JG
 JH
 JI
 JJ
 JK
 JL
 JM
 JN
 JO
 JP
 JQ
 JR
 JS
 JT
 JU
 JV
 JW
 JX
 JY
 JZ
 KA
 KB
 KC
 KD
 KE
 KF
 KG
 KH
 KI
 KJ
 KK
 KL
 KM
 KN
 KO
 KP
 KQ
 KR
 KS
 KT
 KU
 KV
 KW
 KX
 KY
 KZ
 LA
 LB
 LC
 LD
 LE
 LF
 LG
 LH
 LI
 LJ
 LK
 LL
 LM
 LN
 LO
 LP
 LQ
 LR
 LS
 LT
 LU
 LV
 LW
 LX
 LY
 LZ
 MA
 MB
 MC
 MD
 ME
 MF
 MG
 MH
 MI
 MJ
 MK
 ML
 MM
 MN
 MO
 MP
 MQ
 MR
 MS
 MT
 MU
 MV
 MW
 MX
 MY
 MZ
 NA
 NB
 NC
 ND
 NE
 NF
 NG
 NH
 NI
 NJ
 NK
 NL
 NM
 NN
 NO
 NP
 NQ
 NR
 NS
 NT
 NU
 NV
 NW
 NX
 NY
 NZ
 OA
 OB
 OC
 OD
 OE
 OF
 OG
 OH
 OI
 OJ
 OK
 OL
 OM
 ON
 OO
 OP
 OQ
 OR
 OS
 OT
 OU
 OV
 OW
 OX
 OY
 OZ
 PA
 PB
 PC
 PD
 PE
 PF
 PG
 PH
 PI
 PJ
 PK
 PL
 PM
 PN
 PO
 PP
 PQ
 PR
 PS
 PT
 PU
 PV
 PW
 PX
 PY
 PZ
 QA
 QB
 QC
 QD
 QE
 QF
 QG
 QH
 QI
 QJ
 QK
 QL
 QM
 QN
 QO
 QP
 QQ
 QR
 QS
 QT
 QU
 QV
 QW
 QX
 QY
 QZ
 RA
 RB
 RC
 RD
 RE
 RF
 RG
 RH
 RI
 RJ
 RK
 RL
 RM
 RN
 RO
 RP
 RQ
 RR
 RS
 RT
 RU
 RV
 RW
 RX
 RY
 RZ
 SA
 SB
 SC
 SD
 SE
 SF
 SG
 SH
 SI
 SJ
 SK
 SL
 SM
 SN
 SO
 SP
 SQ
 SR
 SS
 ST
 SU
 SV
 SW
 SX
 SY
 SZ
 TA
 TB
 TC
 TD
 TE
 TF
 TG
 TH
 TI
 TJ
 TK
 TL
 TM
 TN
 TO
 TP
 TQ
 TR
 TS
 TT
 TU
 TV
 TW
 TX
 TY
 TZ
 UA
 UB
 UC
 UD
 UE
 UF
 UG
 UH
 UI
 UJ
 UK
 UL
 UM
 UN
 UO
 UP
 UQ
 UR
 US
 UT
 UY
 UZ
 VA
 VB
 VC
 VD
 VE
 VF
 VG
 VH
 VI
 VJ
 VK
 VL
 VM
 VN
 VO
 VP
 VQ
 VR
 VS
 VT
 VU
 VV
 VW
 VX
 VY
 VZ
 WA
 WB
 WC
 WD
 WE
 WF
 WG
 WH
 WI
 WJ
 WK
 WL
 WM
 WN
 WO
 WP
 WQ
 WR
 WS
 WT
 WU
 WV
 WW
 WX
 WY
 WZ
 XA
 XB
 XC
 XD
 XE
 XF
 XG
 XH
 XI
 XJ
 XK
 XL
 XM
 XN
 XO
 XP
 XQ
 XR
 XS
 XT
 XU
 XV
 XW
 XX
 XY
 XZ
 YA
 YB
 YC
 YD
 YE
 YF
 YG
 YH
 YI
 YJ
 YK
 YL
 YM
 YN
 YO
 YP
 YQ
 YR
 YS
 YT
 YU
 YV
 YW
 YX
 YZ
 ZA
 ZB
 ZC
 ZD
 ZE
 ZF
 ZG
 ZH
 ZI
 ZJ
 ZK
 ZL
 ZM
 ZN
 ZO
 ZP
 ZQ
 ZR
 ZS
 ZT
 ZU
 ZV
 ZW
 ZX
 ZY
 ZZ

Wurzelheber
 Root elevators
 Elevadores para raíces
 Elevateurs à racines
 Elevatori per radici



1/1

FRIEDMAN
 15,0 cm/6"



1/1

Fig.1
 PF 084/01



1/1

Fig.2L
 PF 084/02



1/1

Fig.3R
 PF 084/03

WURZELHEBER ROOT ELEVATORS ELEVADORES PARA RAICES ELEVATEURS A RACINES ELEVATORI PER RADICI

Wurzelheber
 Root elevators
 Elevadores para raíces
 Elevateurs à racines
 Elevatori per radici

AA
 AB
 AC
 AD
 AE
 AF
 AK
 AL
 AO
 AR
 KA
 KL
 KU
 PA
 PB
PF
 PI
 PK
 PL
 PM
 PP
 PS
 PT
 PU
 PV
 KYE



1/1

LINDO LEVIAN
 15,0 cm/6"

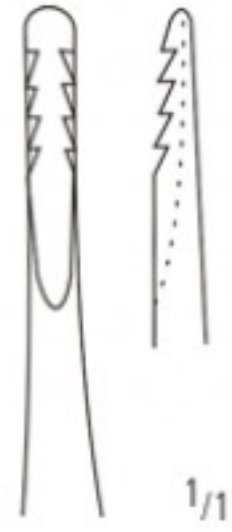

1/1

Fig.1
 PF 085/01

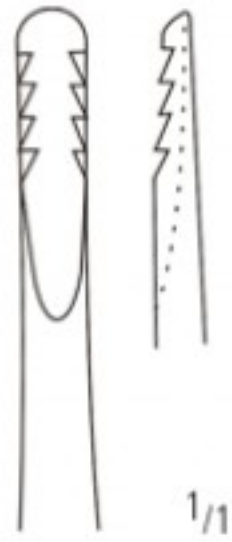

1/1

Fig.3
 PF 085/03



1/1

MILLER-APEVO
 15,0 cm/6"



1/1

Fig.10
 PF 085/10



1/1

Fig.11
 PF 085/11

Wurzelheber
 Root elevators
 Elevadores para raíces
 Elevateurs à racines
 Elevatori per radici



HYLIN
 14,0 cm/5½"



Fig.1
 PF 086/01

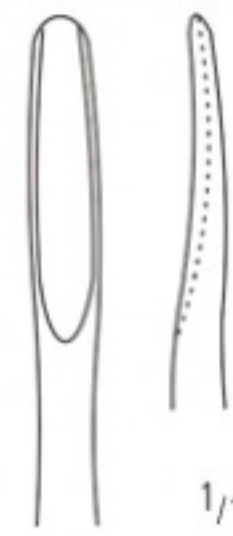

Fig.2
 PF 086/02



Fig.3L
 PF 086/03



Fig.4R
 PF 086/04

WURZELHEBER ROOT ELEVATORS ELEVADORES PARA RAICES ELEVATEURS A RACINES ELEVATORI PER RADICI

Wurzelheber
 Root elevators
 Elevadores para raíces
 Elevateurs à racines
 Elevatori per radici



Fig.0
 PF 090/00



Fig.1
 PF 090/01

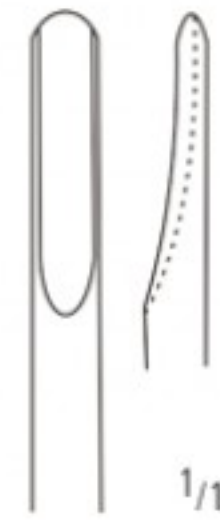

Fig.2
 PF 090/02



Fig.0A
 PF 091/00



Fig.1A
 PF 091/01

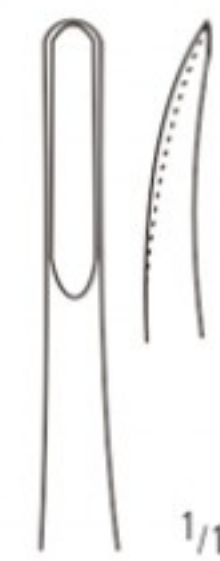

Fig.2A
 PF 091/02



BEIN
 13,0 cm/5"

AA
 AB
 AC
 AD
 AE
 AF
 AK
 AL
 AO
 AR
 KA
 KL
 KU
 PA
 PB
PF
 PI
 PK
 PL
 PM
 PP
 PS
 PT
 PU
 PV
 KYE

Wurzelheber
 Root elevators
 Elevadores para raíces
 Elevateurs à racines
 Elevatori per radici



16,0 cm/6¹/₄"

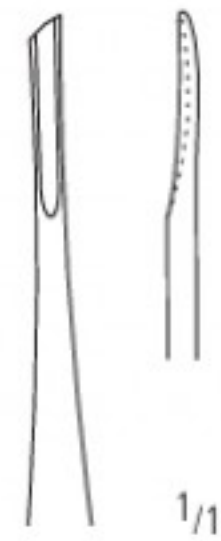

Fig.1
PF 092/01

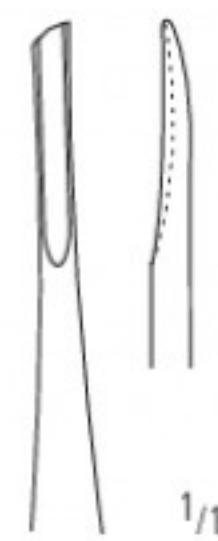

Fig.2
PF 092/02

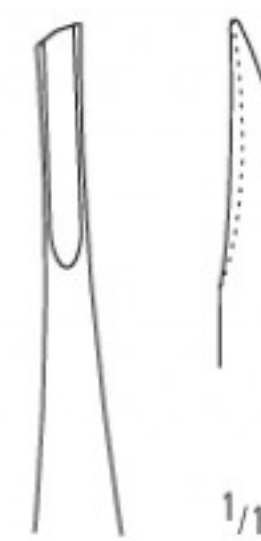

Fig.3
PF 092/03

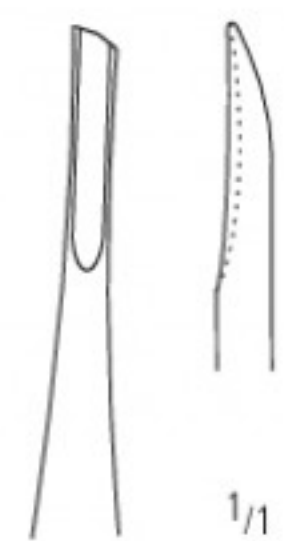

Fig.4
PF 092/04



Fig.7
PF 092/07



Fig.8
PF 092/08



Fig.11
PF 092/11



Fig.12
PF 092/12

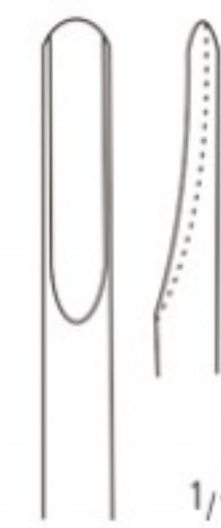

Fig.13
PF 092/13

WURZELHEBER ROOT ELEVATORS ELEVADORES PARA RAICES ELEVATEURS A RACINES ELEVATORI PER RADICI

Wurzelheber
 Root elevators
 Elevadores para raíces
 Elevateurs à racines
 Elevatori per radici



16,0 cm/6¹/₄"



Fig.16
 PF 092/16



Fig.17
 PF 092/17



Fig.18
 PF 092/18



Fig.19
 PF 092/19

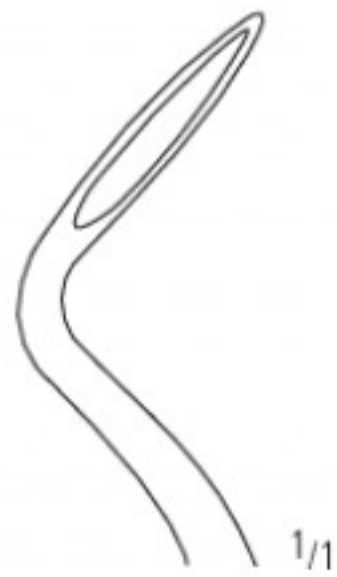

Fig.20
 PF 092/20



Fig.21
 PF 092/21

AA
 AB
 AC
 AD
 AE
 AF
 AG
 AH
 AI
 AJ
 AK
 AL
 AM
 AN
 AO
 AP
 AQ
 AR
 AS
 AT
 AU
 AV
 AW
 AX
 AY
 AZ
 BA
 BB
 BC
 BD
 BE
 BF
 BG
 BH
 BI
 BJ
 BK
 BL
 BM
 BN
 BO
 BP
 BQ
 BR
 BS
 BT
 BU
 BV
 BW
 BX
 BY
 BZ
 CA
 CB
 CC
 CD
 CE
 CF
 CG
 CH
 CI
 CJ
 CK
 CL
 CM
 CN
 CO
 CP
 CQ
 CR
 CS
 CT
 CU
 CV
 CW
 CX
 CY
 CZ
 DA
 DB
 DC
 DD
 DE
 DF
 DG
 DH
 DI
 DJ
 DK
 DL
 DM
 DN
 DO
 DP
 DQ
 DR
 DS
 DT
 DU
 DV
 DW
 DX
 DY
 DZ
 EA
 EB
 EC
 ED
 EE
 EF
 EG
 EH
 EI
 EJ
 EK
 EL
 EM
 EN
 EO
 EP
 EQ
 ER
 ES
 ET
 EU
 EV
 EW
 EX
 EY
 EZ
 FA
 FB
 FC
 FD
 FE
 FF
 FG
 FH
 FI
 FJ
 FK
 FL
 FM
 FN
 FO
 FP
 FQ
 FR
 FS
 FT
 FU
 FV
 FW
 FX
 FY
 FZ
 GA
 GB
 GC
 GD
 GE
 GF
 GG
 GH
 GI
 GJ
 GK
 GL
 GM
 GN
 GO
 GP
 GQ
 GR
 GS
 GT
 GU
 GV
 GW
 GX
 GY
 GZ
 HA
 HB
 HC
 HD
 HE
 HF
 HG
 HH
 HI
 HJ
 HK
 HL
 HM
 HN
 HO
 HP
 HQ
 HR
 HS
 HT
 HU
 HV
 HW
 HX
 HY
 HZ
 IA
 IB
 IC
 ID
 IE
 IF
 IG
 IH
 II
 IJ
 IK
 IL
 IM
 IN
 IO
 IP
 IQ
 IR
 IS
 IT
 IU
 IV
 IW
 IX
 IY
 IZ
 JA
 JB
 JC
 JD
 JE
 JF
 JG
 JH
 JI
 JJ
 JK
 JL
 JM
 JN
 JO
 JP
 JQ
 JR
 JS
 JT
 JU
 JV
 JW
 JX
 JY
 JZ
 KA
 KB
 KC
 KD
 KE
 KF
 KG
 KH
 KI
 KJ
 KK
 KL
 KM
 KN
 KO
 KP
 KQ
 KR
 KS
 KT
 KU
 KV
 KW
 KX
 KY
 KZ
 LA
 LB
 LC
 LD
 LE
 LF
 LG
 LH
 LI
 LJ
 LK
 LL
 LM
 LN
 LO
 LP
 LQ
 LR
 LS
 LT
 LU
 LV
 LW
 LX
 LY
 LZ
 MA
 MB
 MC
 MD
 ME
 MF
 MG
 MH
 MI
 MJ
 MK
 ML
 MM
 MN
 MO
 MP
 MQ
 MR
 MS
 MT
 MU
 MV
 MW
 MX
 MY
 MZ
 NA
 NB
 NC
 ND
 NE
 NF
 NG
 NH
 NI
 NJ
 NK
 NL
 NM
 NN
 NO
 NP
 NQ
 NR
 NS
 NT
 NU
 NV
 NW
 NX
 NY
 NZ
 OA
 OB
 OC
 OD
 OE
 OF
 OG
 OH
 OI
 OJ
 OK
 OL
 OM
 ON
 OO
 OP
 OQ
 OR
 OS
 OT
 OU
 OV
 OW
 OX
 OY
 OZ
 PA
 PB
 PC
 PD
 PE
 PF
 PG
 PH
 PI
 PJ
 PK
 PL
 PM
 PN
 PO
 PP
 PQ
 PR
 PS
 PT
 PU
 PV
 PW
 PX
 PY
 PZ
 QA
 QB
 QC
 QD
 QE
 QF
 QG
 QH
 QI
 QJ
 QK
 QL
 QM
 QN
 QO
 QP
 QQ
 QR
 QS
 QT
 QU
 QV
 QW
 QX
 QY
 QZ
 RA
 RB
 RC
 RD
 RE
 RF
 RG
 RH
 RI
 RJ
 RK
 RL
 RM
 RN
 RO
 RP
 RQ
 RR
 RS
 RT
 RU
 RV
 RW
 RX
 RY
 RZ
 SA
 SB
 SC
 SD
 SE
 SF
 SG
 SH
 SI
 SJ
 SK
 SL
 SM
 SN
 SO
 SP
 SQ
 SR
 SS
 ST
 SU
 SV
 SW
 SX
 SY
 SZ
 TA
 TB
 TC
 TD
 TE
 TF
 TG
 TH
 TI
 TJ
 TK
 TL
 TM
 TN
 TO
 TP
 TQ
 TR
 TS
 TT
 TU
 TV
 TW
 TX
 TY
 TZ
 UA
 UB
 UC
 UD
 UE
 UF
 UG
 UH
 UI
 UJ
 UK
 UL
 UM
 UN
 UO
 UP
 UQ
 UR
 US
 UT
 UY
 UZ
 VA
 VB
 VC
 VD
 VE
 VF
 VG
 VH
 VI
 VJ
 VK
 VL
 VM
 VN
 VO
 VP
 VQ
 VR
 VS
 VT
 VU
 VV
 VW
 VX
 VY
 VZ
 WA
 WB
 WC
 WD
 WE
 WF
 WG
 WH
 WI
 WJ
 WK
 WL
 WM
 WN
 WO
 WP
 WQ
 WR
 WS
 WT
 WU
 WV
 WW
 WX
 WY
 WZ
 XA
 XB
 XC
 XD
 XE
 XF
 XG
 XH
 XI
 XJ
 XK
 XL
 XM
 XN
 XO
 XP
 XQ
 XR
 XS
 XT
 XU
 XV
 XW
 XX
 XY
 XZ
 YA
 YB
 YC
 YD
 YE
 YF
 YG
 YH
 YI
 YJ
 YK
 YL
 YM
 YN
 YO
 YP
 YQ
 YR
 YS
 YT
 YU
 YV
 YW
 YX
 YZ
 ZA
 ZB
 ZC
 ZD
 ZE
 ZF
 ZG
 ZH
 ZI
 ZJ
 ZK
 ZL
 ZM
 ZN
 ZO
 ZP
 ZQ
 ZR
 ZS
 ZT
 ZU
 ZV
 ZW
 ZX
 ZY
 ZZ

Wurzelheber
 Root elevators
 Elevadores para raíces
 Elevateurs à racines
 Elevatori per radici



Fig.1
 PF 096/01



Fig.2
 PF 096/02

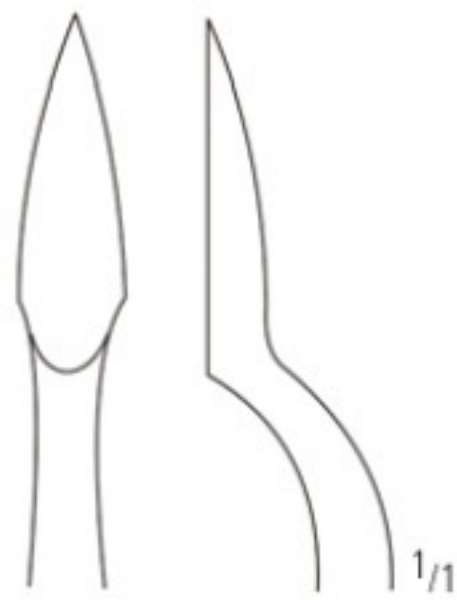
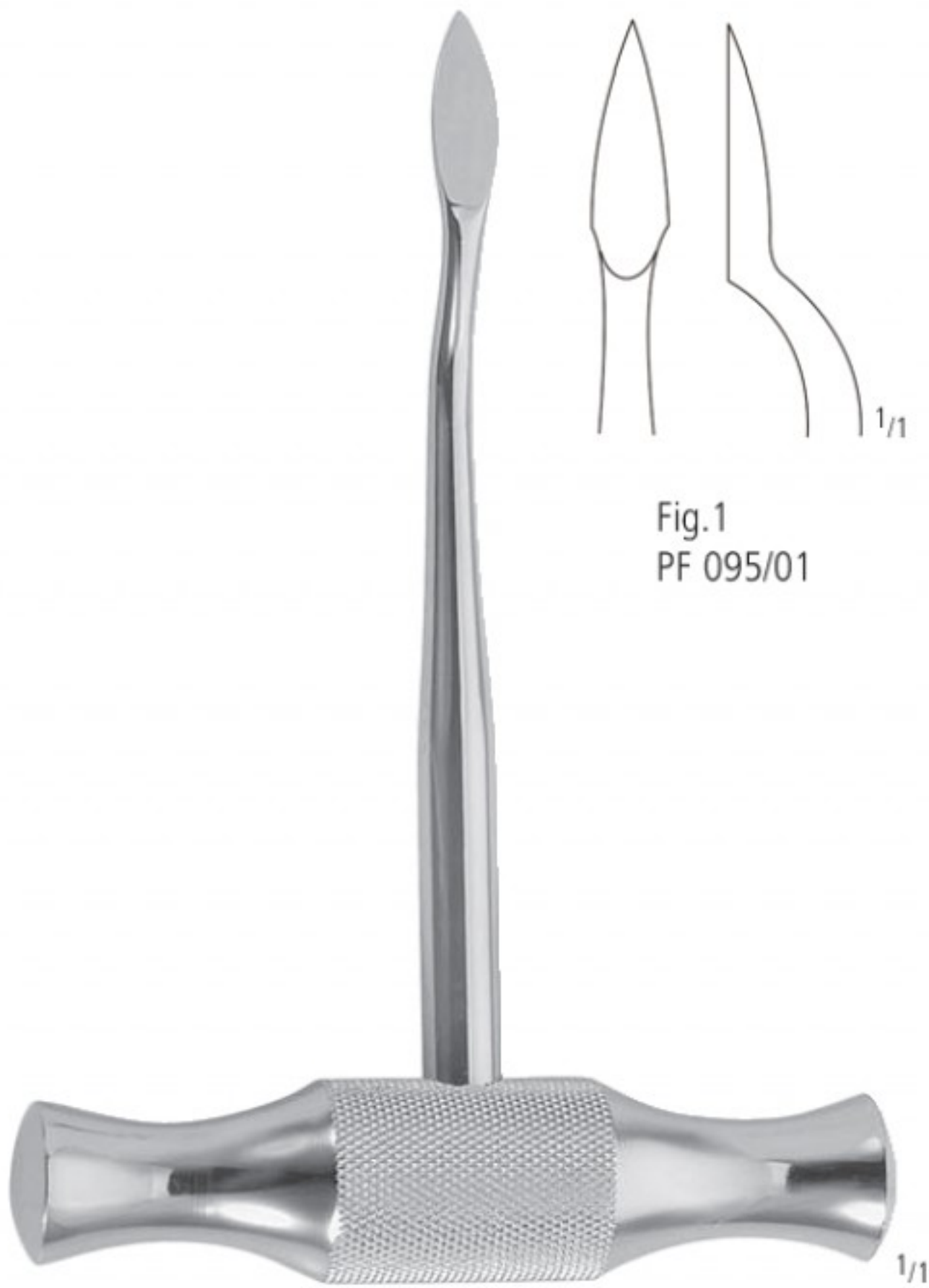
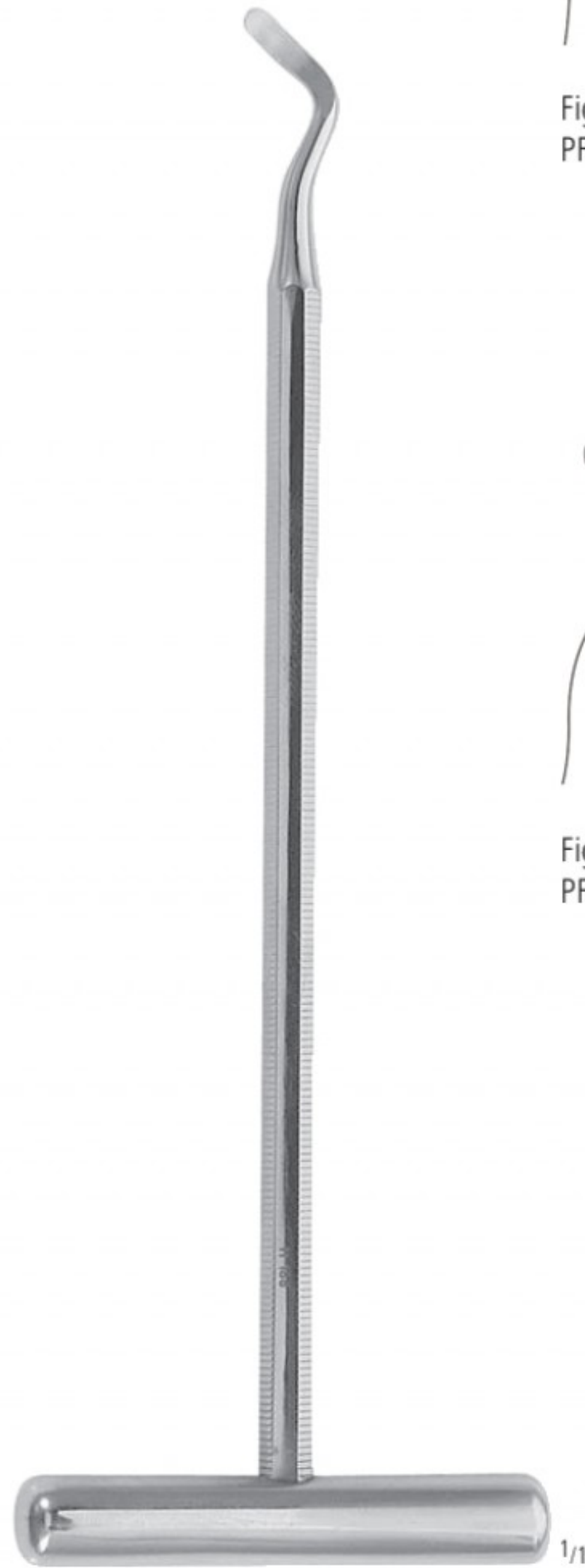

Fig.1
 PF 095/01



LECLUSE
 11,0 cm/4 1/3"



POTT
 15,0 cm/6"

WURZELHEBER ROOT ELEVATORS ELEVADORES PARA RAICES ELEVATEURS A RACINES ELEVATORI PER RADICI

Wurzelheber
 Root elevators
 Elevadores para raíces
 Elevateurs à racines
 Elevatori per radici



WARWICK-JAMES
 16,0 cm/6¹/₄"



Fig.1
 PF 100/01



Fig.2L
 PF 100/02



Fig.3R
 PF 100/03

AA
 AB
 AC
 AD
 AE
 AF
 AK
 AL
 AO
 AR
 KA
 KL
 KU
 PA
 PB
PF
 PI
 PK
 PL
 PM
 PP
 PS
 PT
 PU
 PV
 KYE

Wurzelheber
 Root elevators
 Elevadores para raíces
 Elevateurs à racines
 Elevatori per radici



Fig.320L
 PF 210/01



Fig.321R
 PF 210/02



Fig.322L
 PF 211/01



Fig.323R
 PF 211/02



W.F. BARRY
 11,0 cm/4¹/₃"

WURZELHEBER ROOT ELEVATORS ELEVADORES PARA RAICES ELEVATEURS A RACINES ELEVATORI PER RADICI

Wurzelheber
 Root elevators
 Elevadores para raíces
 Elevateurs à racines
 Elevatori per radici



WINTER
 11,0 cm/4¹/₃"



Fig.11L
 PF 220/01



Fig.11R
 PF 220/02



Fig.12L
 PF 221/01



Fig.12R
 PF 221/02



Fig.13L
 PF 222/01



Fig.13R
 PF 222/02



Fig.14L
 PF 224/01



Fig.14R
 PF 224/02

AA
 AB
 AC
 AD
 AE
 AF
 AK
 AL
 AO
 AR
 KA
 KL
 KU
 PA
 PB
PF
 PI
 PK
 PL
 PM
 PP
 PS
 PT
 PU
 PV
 KYE

Wurzelheber
 Root elevators
 Elevadores para raíces
 Elevateurs à racines
 Elevatori per radici



Fig.1
 PF 310/01



Fig.2
 PF 310/02



Fig.3
 PF 310/03



Fig.1
 PF 310/11

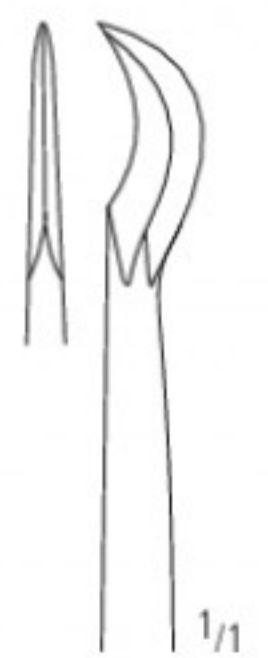

Fig.3
 PF 310/13



CHOMPRET
 16,0 cm/6¹/₄"

CHOMPRET
 16,0 cm/6¹/₄"
 massiv
 solid
 masivo
 massif
 massiccio

WURZELHEBER ROOT ELEVATORS ELEVADORES PARA RAICES ELEVATEURS A RACINES ELEVATORI PER RADICI

Wurzelheber
 Root elevators
 Elevadores para raíces
 Elevateurs à racines
 Elevatori per radici



HEIDBRINK
 14,0 cm/5 1/2"



Fig.1
 PF 311/01



Fig.2
 PF 311/02



Fig.3
 PF 311/03

AA
 AB
 AC
 AD
 AE
 AF
 AK
 AL
 AO
 AR
 KA
 KL
 KU
 PA
 PB
PF
 PI
 PK
 PL
 PM
 PP
 PS
 PT
 PU
 PV
 KYE

Wurzelheber
 Root elevators
 Elevadores para raíces
 Elevateurs à racines
 Elevatori per radici



1/1

16,0 cm/6¹/₄"



1/1

PF 311/13
 1,3 mm



1/1

PF 311/18
 1,8 mm



1/1

PF 311/23
 2,3 mm



1/1

PF 311/30
 1,3 mm



1/1

PF 311/31
 1,3 mm

WURZELHEBER ROOT ELEVATORS ELEVADORES PARA RAICES ELEVATEURS A RACINES ELEVATORI PER RADICI

Wurzelheber
 Root elevators
 Elevadores para raíces
 Elevateurs à racines
 Elevatori per radici



HEIDBRINK
 20,0 cm/8"



Fig.1
 PF 312/01



Fig.2
 PF 312/02



Fig.3
 PF 312/03

AA
 AB
 AC
 AD
 AE
 AF
 AK
 AL
 AO
 AR
 KA
 KL
 KU
 PA
 PB
PF
 PI
 PK
 PL
 PM
 PP
 PS
 PT
 PU
 PV
 KYE

Wurzelheber
 Root elevators
 Elevadores para raíces
 Elevateurs à racines
 Elevatori per radici



WEST
 16,0 cm/6¹/₄"



Fig.1
 PF 313/01



Fig.2
 PF 313/02



Fig.3
 PF 313/03

ZAHNREINIGER
DENTAL SCALERS
LIMPIADORES DE SARRO
INSTRUMENTS A DETARTRER
LEVATARTARI DENTALI

PI

nopa[®] instruments



Zahnreiniger
Dental scalers
Limpiadores de sarro
Instruments à détartrer
Levatartari dentali



15,5 cm/6"

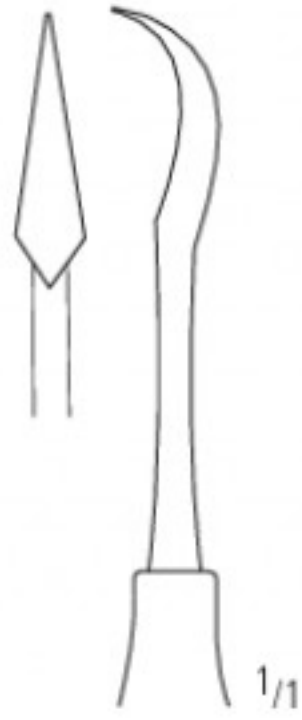

Fig.1
PI 010/01

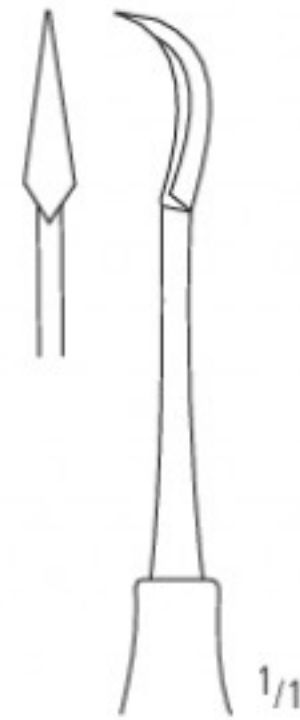

Fig.2
PI 010/02



Fig.33A
PI 010/03



Fig.11
PI 010/11

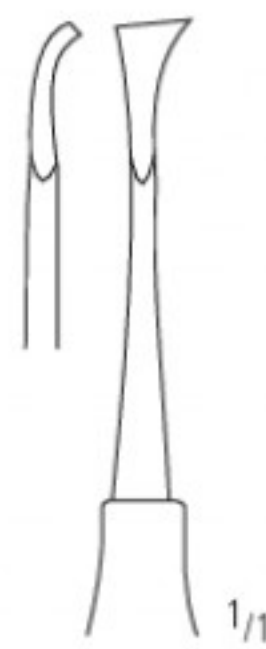

Fig.33
PI 010/33



Fig.34
PI 010/34

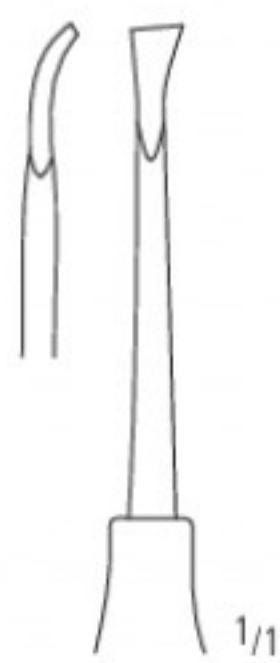

Fig.35
PI 010/35

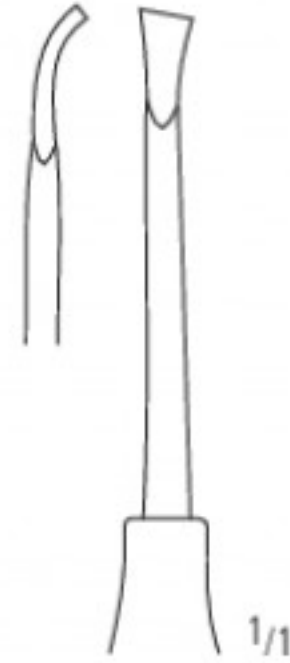

Fig.36
PI 010/36



Fig.17
PI 011/01

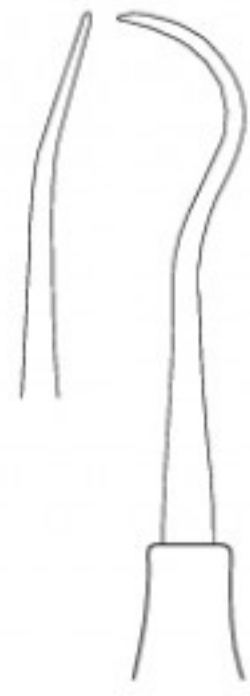

Fig.18
PI 011/02

Zahnreiniger
Dental scalers
Limpiadores de sarro
Instruments à détartrer
Levatartari dentali



17,5 cm/7"



McCALL
Fig.17/18
PI 011/17



YOUNGER-GOOD
Fig.33/34
PI 031/02



CUMINE
Fig.33
PI 031/33

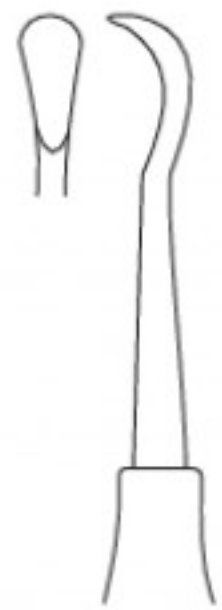
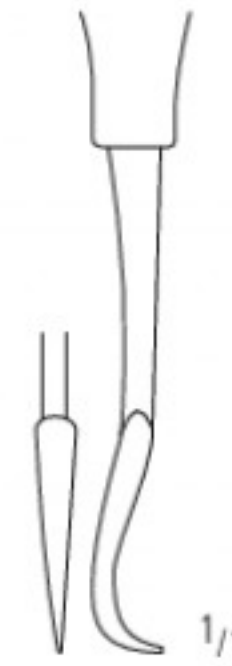

MITCHELL
Fig.34
PI 031/34

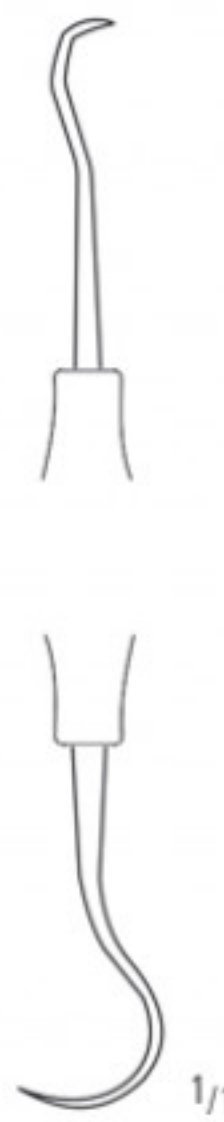

TOWNER
Fig.15/33
PI 043/30



Fig.15/30
PI 043/33



TOWNER
Fig.5/33
PI 044/33

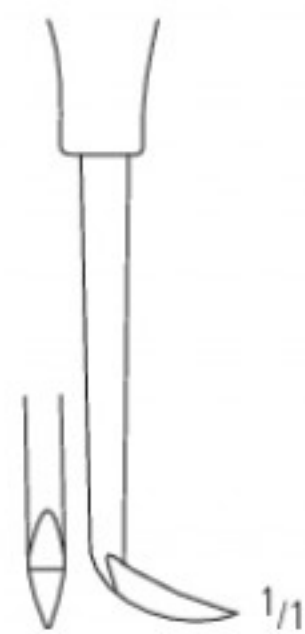

AA AB AC AD AE AF AG AH AI AJ AK AL AO AP AQ AR AS AT AU AV AW AX AY AZ
BA BB BC BD BE BF BG BH BI BJ BK BL BM BN BO BP BQ BR BS BT BU BV BW BX BY BZ
CA CB CC CD CE CF CG CH CI CJ CK CL CM CN CO CP CQ CR CS CT CU CV CW CX CY CZ
DA DB DC DD DE DF DG DH DI DJ DK DL DM DN DO DP DQ DR DS DT DU DV DW DX DY DZ
EA EB EC ED EE EF EG EH EI EJ EK EL EM EN EO EP EQ ER ES ET EU EV EW EX EY EZ
FA FB FC FD FE FF FG FH FI FJ FK FL FM FN FO FP FQ FR FS FT FU FV FW FX FY FZ
GA GB GC GD GE GF GG GH GI GJ GK GL GM GN GO GP GQ GR GS GT GU GV GW GX GY GZ
HA HB HC HD HE HF HG HH HI HJ HK HL HM HN HO HP HQ HR HS HT HU HV HW HX HY HZ
IA IB IC ID IE IF IG IH II IJ IK IL IM IN IO IP IQ IR IS IT IU IV IW IX IY IZ
JA JB JC JD JE JF JG JH JI JJ JK JL JM JN JO JP JQ JR JS JT JU JV JW JX JY JZ
KA KB KC KD KE KF KG KH KI KJ KL KM KN KO KP KQ KR KS KT KU KV KW KX KY KZ
LA LB LC LD LE LF LG LH LI LJ LK LL LM LN LO LP LQ LR LS LT LU LV LW LX LY LZ
MA MB MC MD ME MF MG MH MI MJ MK ML MN MO MP MQ MR MS MT MU MV MW MX MY MZ
NA NB NC ND NE NF NG NH NI NJ NK NL NO NP NQ NR NS NT NU NV NW NX NY NZ
OA OB OC OD OE OF OG OH OI OJ OK OL OM ON OO OP OQ OR OS OT OU OV OW OX OY OZ
PA PB PC PD PE PF PG PH PI **PI** PK PL PM PN PO PP PQ PR PS PT PU PV PW PX PY PZ
QA QB QC QD QE QF QG QH QI QJ QK QL QM QN QO QP QQ QR QS QT QU QV QW QX QY QZ
RA RB RC RD RE RF RG RH RI RJ RK RL RM RN RO RP RQ RR RS RT RU RV RW RX RY RZ
SA SB SC SD SE SF SG SH SI SJ SK SL SM SN SO SP SQ SR SS ST SU SV SW SX SY SZ
TA TB TC TD TE TF TG TH TI TJ TK TL TM TN TO TP TQ TR TS TT TU TV TW TX TY TZ
UA UB UC UD UE UF UG UH UI UJ UK UL UM UN UO UP UQ UR US UT UU UV UW UX UY UZ
VA VB VC VD VE VF VG VH VI VJ VK VL VM VN VO VP VQ VR VS VT VU VV VW VX VY VZ
WA WB WC WD WE WF WG WH WI WJ WK WL WM WN WO WP WQ WR WS WT WU WV WW WX WY WZ
XA XB XC XD XE XF XG XH XI XJ XK XL XM XN XO XP XQ XR XS XT XU XV XW XX XY XZ
YA YB YC YD YE YF YG YH YI YJ YK YL YM YN YO YP YQ YR YS YT YU YV YW YX YY YZ
ZA ZB ZC ZD ZE ZF ZG ZH ZI ZJ ZK ZL ZM ZN ZO ZP ZQ ZR ZS ZT ZU ZV ZW ZX ZY ZZ

Zahnreiniger
Dental scalers
Limpiadores de sarro
Instruments à détartrer
Levatartari dentali



17,5 cm/7"

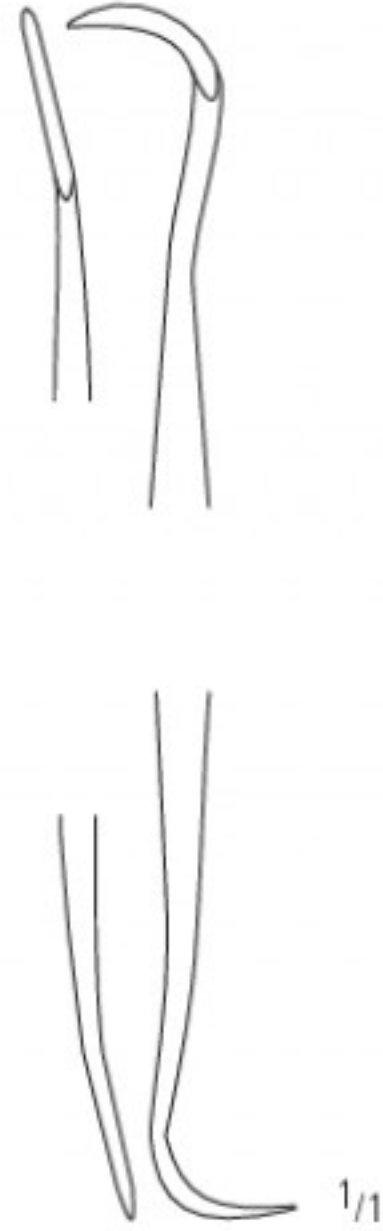

HYGIENIST
Fig.H6/H7
PI 045/06

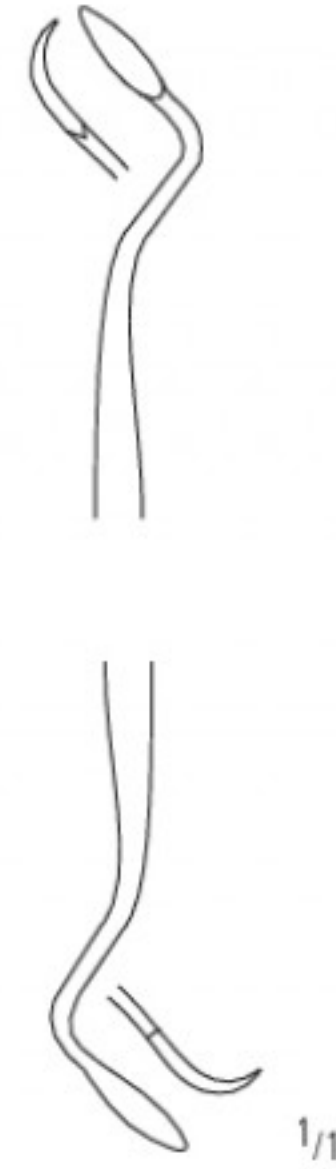

Fig.T 2/3
PI 045/35

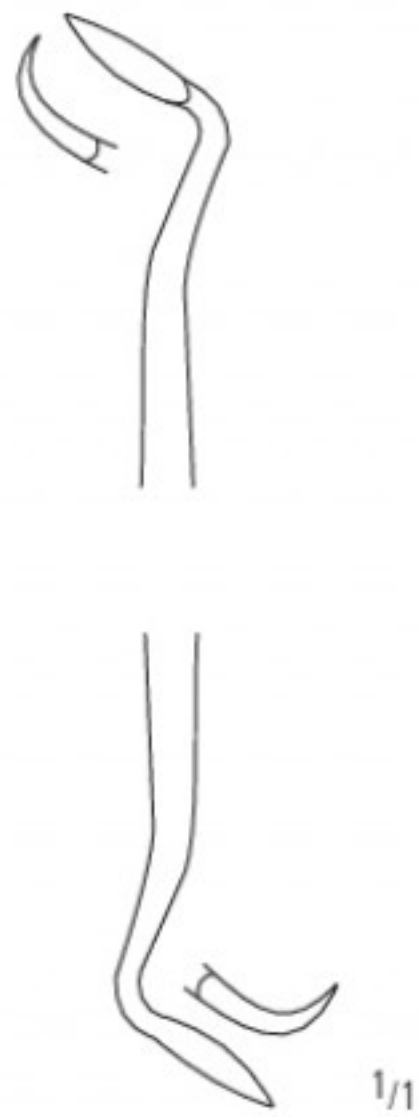

Fig.204
PI 045/36

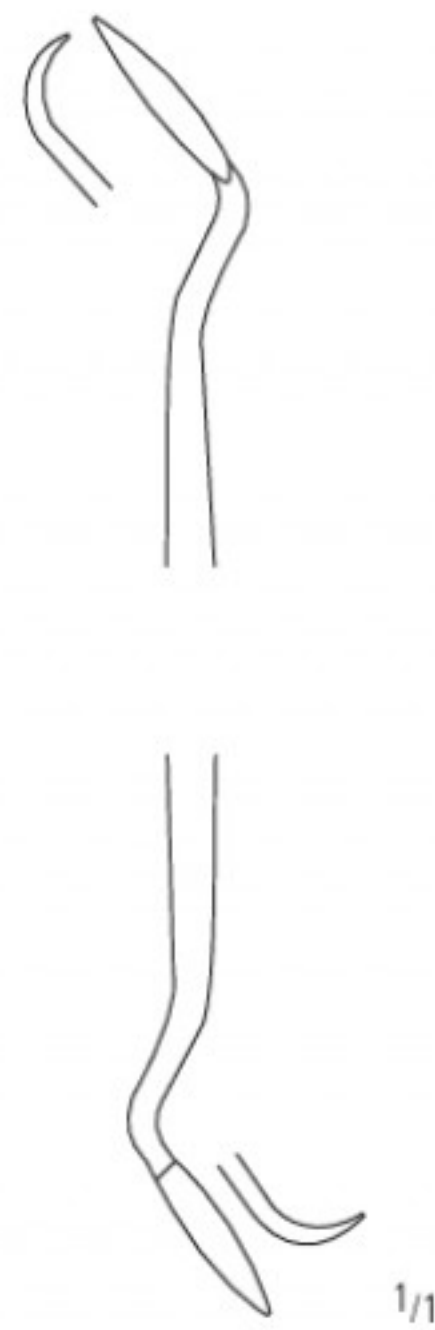

Fig.CI 2/3
PI 045/38

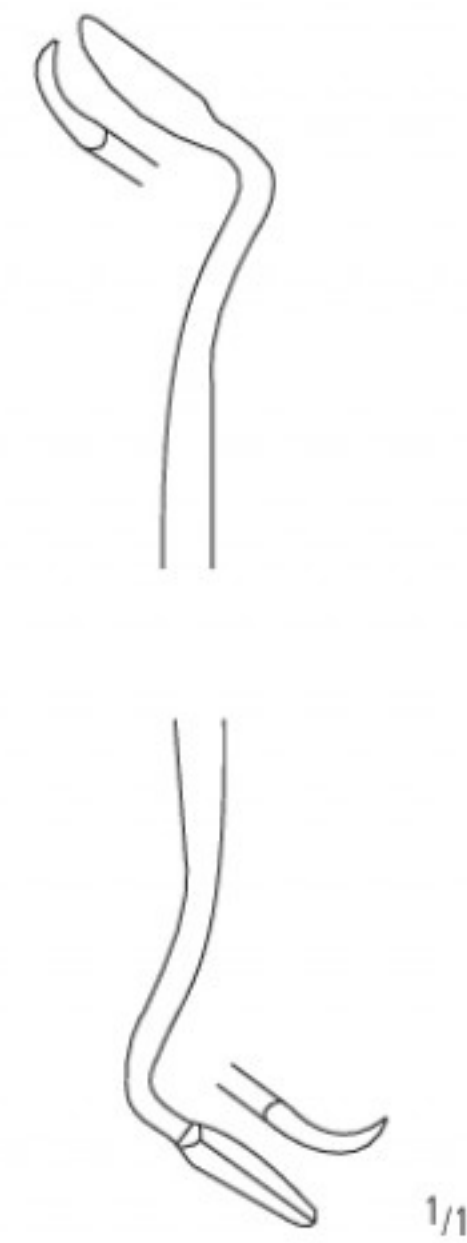

Fig.CC 6
PI 045/39

PARODONTOLOGIE
PERIODONTOLOGY
PARODONTOLOGIA
PARODONTOLOGIE
PARODONTOLOGIA

PK

nopa[®] instruments



Küretten, subgingival
 Curettes, subgingival
 Curetas, subgingival
 Curettes, subgingival
 Curette, subgingivale



McCALL
 17,5 cm/7"

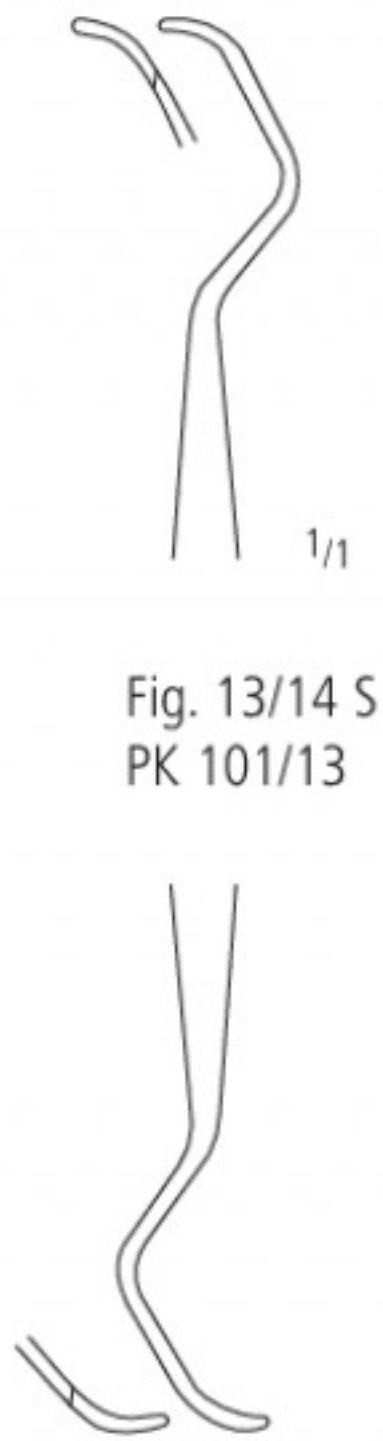

Fig. 13/14 S
 PK 101/13



Fig. 17/18 S
 PK 101/17



COLUMBIA
 17,5 cm/7"



Fig. 4 R/L
 PK 102/04

AA AB AC AD AE AF AG AH AI AJ AK AL AO AP AQ AR AS AT AU AV AW AX AY AZ
 BA BB BC BD BE BF BG BH BI BJ BK BL BM BN BO BP BQ BR BS BT BU BV BW BX BY BZ
 CA CB CC CD CE CF CG CH CI CJ CK CL CM CN CO CP CQ CR CS CT CU CV CW CX CY CZ
 DA DB DC DD DE DF DG DH DI DJ DK DL DM DN DO DP DQ DR DS DT DU DV DW DX DY DZ
 EA EB EC ED EE EF EG EH EI EJ EK EL EM EN EO EP EQ ER ES ET EU EV EW EX EY EZ
 FA FB FC FD FE FF FG FH FI FJ FK FL FM FN FO FP FQ FR FS FT FU FV FW FX FY FZ
 GA GB GC GD GE GF GG GH GI GJ GK GL GM GN GO GP GQ GR GS GT GU GV GW GX GY GZ
 HA HB HC HD HE HF HG HH HI HJ HK HL HM HN HO HP HQ HR HS HT HU HV HW HX HY HZ
 IA IB IC ID IE IF IG IH II IJ IK IL IM IN IO IP IQ IR IS IT IU IV IW IX IY IZ
 JA JB JC JD JE JF JG JH JI JJ JK JL JM JN JO JP JQ JR JS JT JU JV JW JX JY JZ
 KA KB KC KD KE KF KG KH KI KJ KL KM KN KO KP KQ KR KS KT KU KV KW KX KY KZ
 LA LB LC LD LE LF LG LH LI LJ LK LL LM LN LO LP LQ LR LS LT LU LV LW LX LY LZ
 MA MB MC MD ME MF MG MH MI MJ MK ML MN MO MP MQ MR MS MT MU MV MW MX MY MZ
 NA NB NC ND NE NF NG NH NI NJ NK NL NO NP NQ NR NS NT NU NV NW NX NY NZ
 OA OB OC OD OE OF OG OH OI OJ OK OL OM ON OO OP OQ OR OS OT OU OV OW OX OY OZ
 PA PB PC PD PE PF PG PH PI PJ PK PL PM PN PO PP PQ PR PS PT PU PV PW PX PY PZ
 QA QB QC QD QE QF QG QH QI QJ QK QL QM QN QO QQ QR QS QT QU QV QW QX QY QZ
 RA RB RC RD RE RF RG RH RI RJ RK RL RM RN RO RP RQ RR RS RT RU RV RW RX RY RZ
 SA SB SC SD SE SF SG SH SI SJ SK SL SM SN SO SP SQ SR SS ST SU SV SW SX SY SZ
 TA TB TC TD TE TF TG TH TI TJ TK TL TM TN TO TP TQ TR TS TT TU TV TW TX TY TZ
 UA UB UC UD UE UF UG UH UI UJ UK UL UM UN UO UP UQ UR US UT UU UV UW UX UY UZ
 VA VB VC VD VE VF VG VH VI VJ VK VL VM VN VO VP VQ VR VS VT VU VV VW VX VY VZ
 WA WB WC WD WE WF WG WH WI WJ WK WL WM WN WO WP WQ WR WS WT WU WV WW WX WY WZ
 XA XB XC XD XE XF XG XH XI XJ XK XL XM XN XO XP XQ XR XS XT XU XV XW XX XY XZ
 YA YB YC YD YE YF YG YH YI YJ YK YL YM YN YO YP YQ YR YS YT YU YV YW YX YZ
 ZA ZB ZC ZD ZE ZF ZG ZH ZI ZJ ZK ZL ZM ZN ZO ZP ZQ ZR ZS ZT ZU ZV ZW ZX ZY ZZ

Standard-Küretten, subgingival
 Standard-curettes, subgingival
 Curetas estándar, subgingival
 Curettes standard, subgingival
 Curette standard, subgingivale



GRACEY-STANDARD
 17,5 cm/7"



Fig. 1/2
 PK 104/02



Fig. 3/4
 PK 104/04



Fig. 5/6
 PK 104/06



Fig. 7/8
 PK 104/08



Fig. 9/10
 PK 104/10



Fig. 11/12
 PK 104/12



Fig. 13/14
 PK 104/14



Fig. 15/16
 PK 104/16



Küretten, subgingival
 Curettes, subgingival
 Curetas, subgingival
 Curettes, subgingival
 Curette, subgingivale



17,5 cm/7"



FIG. 1/2
 PK 105/02

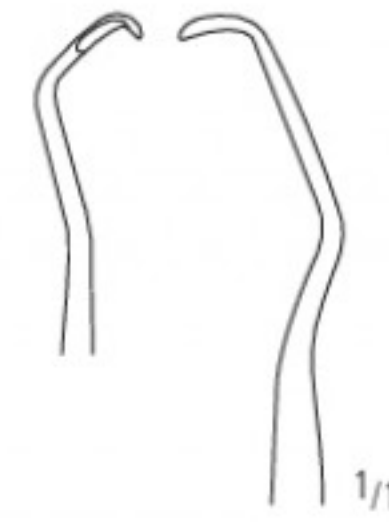

FIG. 3/4
 PK 105/04



FIG. 5/6
 PK 105/06



AA
 AB
 AC
 AD
 AE
 AF
 AG
 AH
 AI
 AJ
 AK
 AL
 AO
 AP
 AQ
 AR
 AS
 AT
 AU
 AV
 AW
 AX
 AY
 AZ
 BA
 BB
 BC
 BD
 BE
 BF
 BG
 BH
 BI
 BJ
 BK
 BL
 BM
 BN
 BO
 BP
 BQ
 BR
 BS
 BT
 BU
 BV
 BW
 BX
 BY
 BZ
 CA
 CB
 CC
 CD
 CE
 CF
 CG
 CH
 CI
 CJ
 CK
 CL
 CM
 CN
 CO
 CP
 CQ
 CR
 CS
 CT
 CU
 CV
 CW
 CX
 CY
 CZ
 DA
 DB
 DC
 DD
 DE
 DF
 DG
 DH
 DI
 DJ
 DK
 DL
 DM
 DN
 DO
 DP
 DQ
 DR
 DS
 DT
 DU
 DV
 DW
 DX
 DY
 DZ
 EA
 EB
 EC
 ED
 EE
 EF
 EG
 EH
 EI
 EJ
 EK
 EL
 EM
 EN
 EO
 EP
 EQ
 ER
 ES
 ET
 EU
 EV
 EW
 EX
 EY
 EZ
 FA
 FB
 FC
 FD
 FE
 FF
 FG
 FH
 FI
 FJ
 FK
 FL
 FM
 FN
 FO
 FP
 FQ
 FR
 FS
 FT
 FU
 FV
 FW
 FX
 FY
 FZ
 GA
 GB
 GC
 GD
 GE
 GF
 GG
 GH
 GI
 GJ
 GK
 GL
 GM
 GN
 GO
 GP
 GQ
 GR
 GS
 GT
 GU
 GV
 GW
 GX
 GY
 GZ
 HA
 HB
 HC
 HD
 HE
 HF
 HG
 HH
 HI
 HJ
 HK
 HL
 HM
 HN
 HO
 HP
 HQ
 HR
 HS
 HT
 HU
 HV
 HW
 HX
 HY
 HZ
 IA
 IB
 IC
 ID
 IE
 IF
 IG
 IH
 II
 IJ
 IK
 IL
 IM
 IN
 IO
 IP
 IQ
 IR
 IS
 IT
 IU
 IV
 IW
 IX
 IY
 IZ
 JA
 JB
 JC
 JD
 JE
 JF
 JG
 JH
 JI
 JJ
 JK
 JL
 JM
 JN
 JO
 JP
 JQ
 JR
 JS
 JT
 JU
 JV
 JW
 JX
 JY
 JZ
 KA
 KB
 KC
 KD
 KE
 KF
 KG
 KH
 KI
 KJ
 KK
 KL
 KM
 KN
 KO
 KP
 KQ
 KR
 KS
 KT
 KU
 KV
 KW
 KX
 KY
 KZ
 LA
 LB
 LC
 LD
 LE
 LF
 LG
 LH
 LI
 LJ
 LK
 LL
 LM
 LN
 LO
 LP
 LQ
 LR
 LS
 LT
 LU
 LV
 LW
 LX
 LY
 LZ
 MA
 MB
 MC
 MD
 ME
 MF
 MG
 MH
 MI
 MJ
 MK
 ML
 MM
 MN
 MO
 MP
 MQ
 MR
 MS
 MT
 MU
 MV
 MW
 MX
 MY
 MZ
 NA
 NB
 NC
 ND
 NE
 NF
 NG
 NH
 NI
 NJ
 NK
 NL
 NM
 NN
 NO
 NP
 NQ
 NR
 NS
 NT
 NU
 NV
 NW
 NX
 NY
 NZ
 OA
 OB
 OC
 OD
 OE
 OF
 OG
 OH
 OI
 OJ
 OK
 OL
 OM
 ON
 OO
 OP
 OQ
 OR
 OS
 OT
 OU
 OV
 OW
 OX
 OY
 OZ
 PA
 PB
 PC
 PD
 PE
 PF
 PG
 PH
 PI
 PJ
 PK
 PL
 PM
 PN
 PO
 PP
 PQ
 PR
 PS
 PT
 PU
 PV
 PW
 PX
 PY
 PZ
 QA
 QB
 QC
 QD
 QE
 QF
 QG
 QH
 QI
 QJ
 QK
 QL
 QM
 QN
 QO
 QP
 QQ
 QR
 QS
 QT
 QU
 QV
 QW
 QX
 QY
 QZ
 RA
 RB
 RC
 RD
 RE
 RF
 RG
 RH
 RI
 RJ
 RK
 RL
 RM
 RN
 RO
 RP
 RQ
 RR
 RS
 RT
 RU
 RV
 RW
 RX
 RY
 RZ
 SA
 SB
 SC
 SD
 SE
 SF
 SG
 SH
 SI
 SJ
 SK
 SL
 SM
 SN
 SO
 SP
 SQ
 SR
 SS
 ST
 SU
 SV
 SW
 SX
 SY
 SZ
 TA
 TB
 TC
 TD
 TE
 TF
 TG
 TH
 TI
 TJ
 TK
 TL
 TM
 TN
 TO
 TP
 TQ
 TR
 TS
 TT
 TU
 TV
 TW
 TX
 TY
 TZ
 UA
 UB
 UC
 UD
 UE
 UF
 UG
 UH
 UI
 UJ
 UK
 UL
 UM
 UN
 UO
 UP
 UQ
 UR
 US
 UT
 UY
 UZ
 VA
 VB
 VC
 VD
 VE
 VF
 VG
 VH
 VI
 VJ
 VK
 VL
 VM
 VN
 VO
 VP
 VQ
 VR
 VS
 VT
 VU
 VV
 VW
 VX
 VY
 VZ
 WA
 WB
 WC
 WD
 WE
 WF
 WG
 WH
 WI
 WJ
 WK
 WL
 WM
 WN
 WO
 WP
 WQ
 WR
 WS
 WT
 WU
 WV
 WW
 WX
 WY
 WZ
 XA
 XB
 XC
 XD
 XE
 XF
 XG
 XH
 XI
 XJ
 XK
 XL
 XM
 XN
 XO
 XP
 XQ
 XR
 XS
 XT
 XU
 XV
 XW
 XX
 XY
 XZ
 YA
 YB
 YC
 YD
 YE
 YF
 YG
 YH
 YI
 YJ
 YK
 YL
 YM
 YN
 YO
 YP
 YQ
 YR
 YS
 YT
 YU
 YV
 YW
 YX
 YZ
 ZA
 ZB
 ZC
 ZD
 ZE
 ZF
 ZG
 ZH
 ZI
 ZJ
 ZK
 ZL
 ZM
 ZN
 ZO
 ZP
 ZQ
 ZR
 ZS
 ZT
 ZU
 ZV
 ZW
 ZX
 ZY
 ZZ

Sinus-Lift-Küretten
 Sinus lift curettes
 Curetas para sinus lift
 Curettes pour sinus lift
 Curette per sinus lift

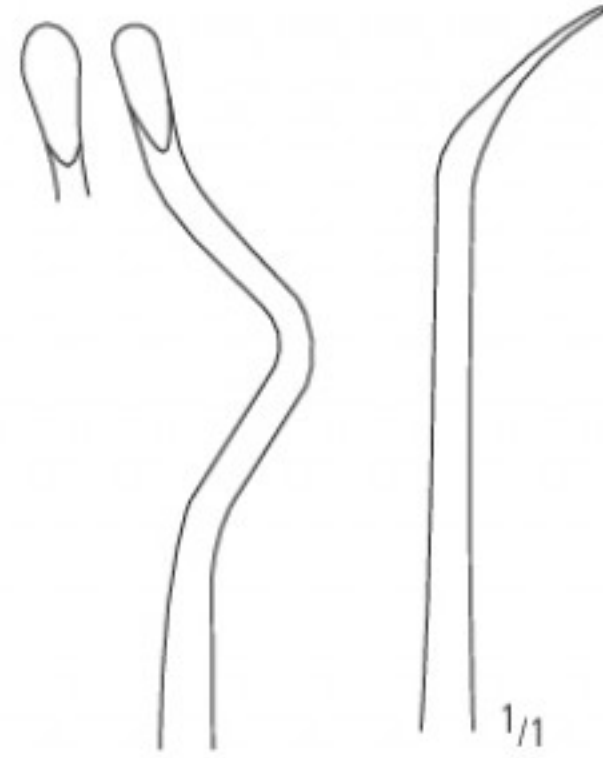

Fig. 1
 PK 108/01
 19,0 cm/7 1/2"



Fig. 2
 PK 108/02
 20,0 cm/8"

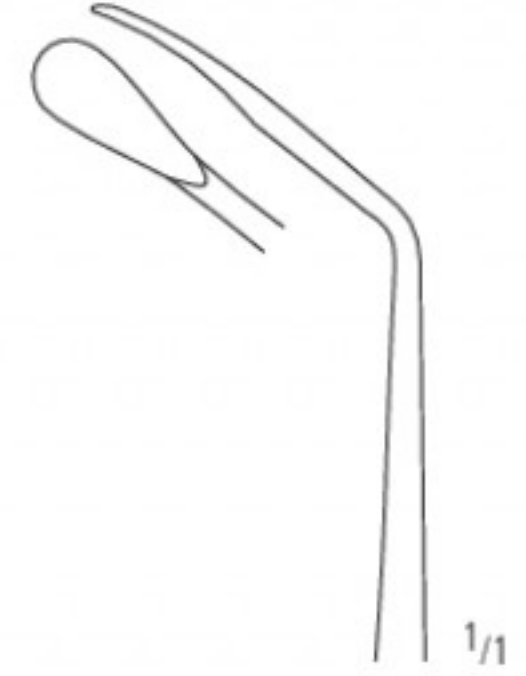

Fig. 3
 PK 108/03
 19,0 cm/7 1/2"



Fig. 4
 PK 108/04
 17,0 cm/6 3/4"

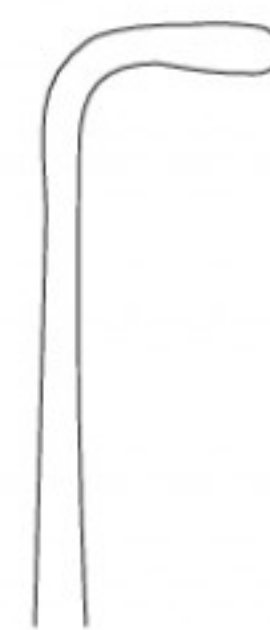

Fig. 5
 PK 108/05
 18,0 cm/7"



Scaler, supragingival
 Scalers, supragingival
 Limpiadores de sarro, supragingival
 Instruments à détartrer, supragingival
 Ablatori di tartaro, supragingival



GOLDMAN-FOX
 17,5 cm/7"



Fig. 1
 PK 110/01



Fig. 2
 PK 110/02

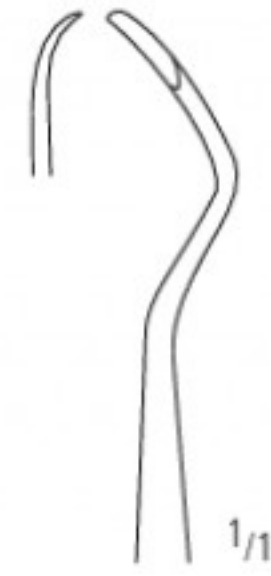

Fig. 3
 PK 110/03



Fig. 4
 PK 110/04



Fig. 5
 PK 110/05

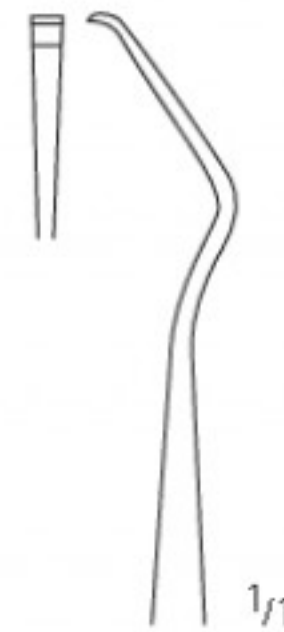

Fig. 6
 PK 110/06



AA
 AB
 AC
 AD
 AE
 AF
 AG
 AH
 AI
 AJ
 AK
 AL
 AM
 AN
 AO
 AP
 AQ
 AR
 AS
 AT
 AU
 AV
 AW
 AX
 AY
 AZ
 BA
 BB
 BC
 BD
 BE
 BF
 BG
 BH
 BI
 BJ
 BK
 BL
 BM
 BN
 BO
 BP
 BQ
 BR
 BS
 BT
 BU
 BV
 BW
 BX
 BY
 BZ
 CA
 CB
 CC
 CD
 CE
 CF
 CG
 CH
 CI
 CJ
 CK
 CL
 CM
 CN
 CO
 CP
 CQ
 CR
 CS
 CT
 CU
 CV
 CW
 CX
 CY
 CZ
 DA
 DB
 DC
 DD
 DE
 DF
 DG
 DH
 DI
 DJ
 DK
 DL
 DM
 DN
 DO
 DP
 DQ
 DR
 DS
 DT
 DU
 DV
 DW
 DX
 DY
 DZ
 EA
 EB
 EC
 ED
 EE
 EF
 EG
 EH
 EI
 EJ
 EK
 EL
 EM
 EN
 EO
 EP
 EQ
 ER
 ES
 ET
 EU
 EV
 EW
 EX
 EY
 EZ
 FA
 FB
 FC
 FD
 FE
 FF
 FG
 FH
 FI
 FJ
 FK
 FL
 FM
 FN
 FO
 FP
 FQ
 FR
 FS
 FT
 FU
 FV
 FW
 FX
 FY
 FZ
 GA
 GB
 GC
 GD
 GE
 GF
 GG
 GH
 GI
 GJ
 GK
 GL
 GM
 GN
 GO
 GP
 GQ
 GR
 GS
 GT
 GU
 GV
 GW
 GX
 GY
 GZ
 HA
 HB
 HC
 HD
 HE
 HF
 HG
 HH
 HI
 HJ
 HK
 HL
 HM
 HN
 HO
 HP
 HQ
 HR
 HS
 HT
 HU
 HV
 HW
 HX
 HY
 HZ
 IA
 IB
 IC
 ID
 IE
 IF
 IG
 IH
 II
 IJ
 IK
 IL
 IM
 IN
 IO
 IP
 IQ
 IR
 IS
 IT
 IU
 IV
 IW
 IX
 IY
 IZ
 JA
 JB
 JC
 JD
 JE
 JF
 JG
 JH
 JI
 JJ
 JK
 JL
 JM
 JN
 JO
 JP
 JQ
 JR
 JS
 JT
 JU
 JV
 JW
 JX
 JY
 JZ
 KA
 KB
 KC
 KD
 KE
 KF
 KG
 KH
 KI
 KJ
 KK
 KL
 KM
 KN
 KO
 KP
 KQ
 KR
 KS
 KT
 KU
 KV
 KW
 KX
 KY
 KZ
 LA
 LB
 LC
 LD
 LE
 LF
 LG
 LH
 LI
 LJ
 LK
 LL
 LM
 LN
 LO
 LP
 LQ
 LR
 LS
 LT
 LU
 LV
 LW
 LX
 LY
 LZ
 MA
 MB
 MC
 MD
 ME
 MF
 MG
 MH
 MI
 MJ
 MK
 ML
 MM
 MN
 MO
 MP
 MQ
 MR
 MS
 MT
 MU
 MV
 MW
 MX
 MY
 MZ
 NA
 NB
 NC
 ND
 NE
 NF
 NG
 NH
 NI
 NJ
 NK
 NL
 NM
 NN
 NO
 NP
 NQ
 NR
 NS
 NT
 NU
 NV
 NW
 NX
 NY
 NZ
 OA
 OB
 OC
 OD
 OE
 OF
 OG
 OH
 OI
 OJ
 OK
 OL
 OM
 ON
 OO
 OP
 OQ
 OR
 OS
 OT
 OU
 OV
 OW
 OX
 OY
 OZ
 PA
 PB
 PC
 PD
 PE
 PF
 PG
 PH
 PI
 PJ
 PK
 PL
 PM
 PN
 PO
 PP
 PQ
 PR
 PS
 PT
 PU
 PV
 PW
 PX
 PY
 PZ
 QA
 QB
 QC
 QD
 QE
 QF
 QG
 QH
 QI
 QJ
 QK
 QL
 QM
 QN
 QO
 QP
 QQ
 QR
 QS
 QT
 QU
 QV
 QW
 QX
 QY
 QZ
 RA
 RB
 RC
 RD
 RE
 RF
 RG
 RH
 RI
 RJ
 RK
 RL
 RM
 RN
 RO
 RP
 RQ
 RR
 RS
 RT
 RU
 RV
 RW
 RX
 RY
 RZ
 SA
 SB
 SC
 SD
 SE
 SF
 SG
 SH
 SI
 SJ
 SK
 SL
 SM
 SN
 SO
 SP
 SQ
 SR
 SS
 ST
 SU
 SV
 SW
 SX
 SY
 SZ
 TA
 TB
 TC
 TD
 TE
 TF
 TG
 TH
 TI
 TJ
 TK
 TL
 TM
 TN
 TO
 TP
 TQ
 TR
 TS
 TT
 TU
 TV
 TW
 TX
 TY
 TZ
 UA
 UB
 UC
 UD
 UE
 UF
 UG
 UH
 UI
 UJ
 UK
 UL
 UM
 UN
 UO
 UP
 UQ
 UR
 US
 UT
 UY
 UZ
 VA
 VB
 VC
 VD
 VE
 VF
 VG
 VH
 VI
 VJ
 VK
 VL
 VM
 VN
 VO
 VP
 VQ
 VR
 VS
 VT
 VU
 VV
 VW
 VX
 VY
 VZ
 WA
 WB
 WC
 WD
 WE
 WF
 WG
 WH
 WI
 WJ
 WK
 WL
 WM
 WN
 WO
 WP
 WQ
 WR
 WS
 WT
 WU
 WV
 WW
 WX
 WY
 WZ
 XA
 XB
 XC
 XD
 XE
 XF
 XG
 XH
 XI
 XJ
 XK
 XL
 XM
 XN
 XO
 XP
 XQ
 XR
 XS
 XT
 XU
 XV
 XW
 XX
 XY
 XZ
 YA
 YB
 YC
 YD
 YE
 YF
 YG
 YH
 YI
 YJ
 YK
 YL
 YM
 YN
 YO
 YP
 YQ
 YR
 YS
 YT
 YU
 YV
 YW
 YX
 YZ
 ZA
 ZB
 ZC
 ZD
 ZE
 ZF
 ZG
 ZH
 ZI
 ZJ
 ZK
 ZL
 ZM
 ZN
 ZO
 ZP
 ZQ
 ZR
 ZS
 ZT
 ZU
 ZV
 ZW
 ZX
 ZY
 ZZ

Gingivektomiemesser
 Gingivectomy knives
 Bisturios para la gingivectomía
 Bistouris pour la gingivectomie
 Bisturie per gengivectomia



GOLDMAN-FOX
 17,5 cm/7"



Fig. 7
 PK 210/07



Fig. 8
 PK 210/08



Fig. 9
 PK 210/09



Fig. 10
 PK 210/10



PARODONTOLOGIE PERIODONTOLOGY PARODONTOLOGIA PARODONTOLOGIE PARODONTOLOGIA

Gingivektomiemesser
 Gingivectomy knives
 Bisturios para la gingivectomía
 Bistouris pour la gingivectomie
 Bisturie per gengivectomia



17,5 cm/7"



KIRKLAND
PK 220/15



KIRKLAND
PK 220/16

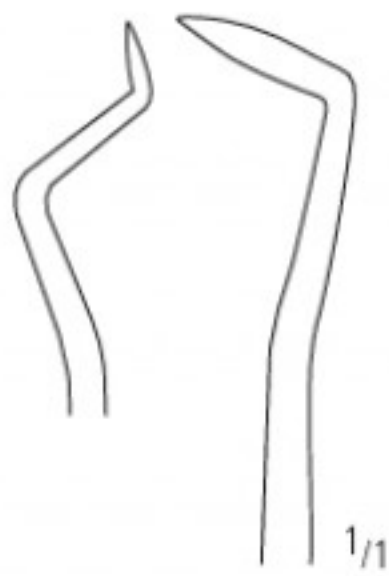

ORBAN
PK 222/01
Fig. 1

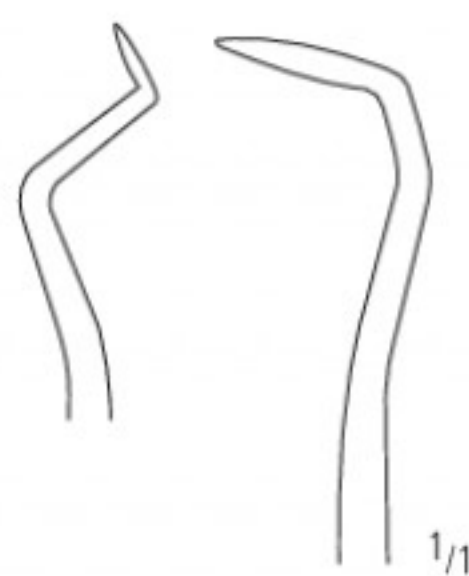

ORBAN
PK 222/02
Fig. 2



17,5 cm/7"



KIRKLAND
PK 221/00

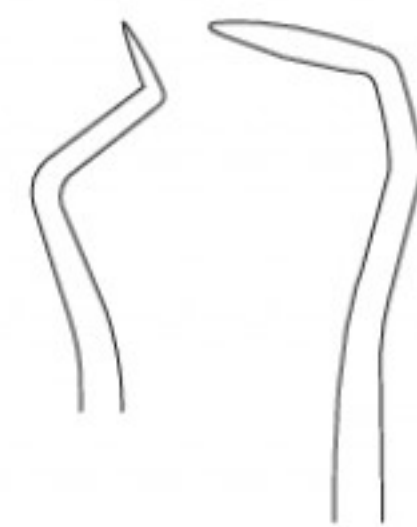

ORBAN
PK 222/03
Fig. 1/2

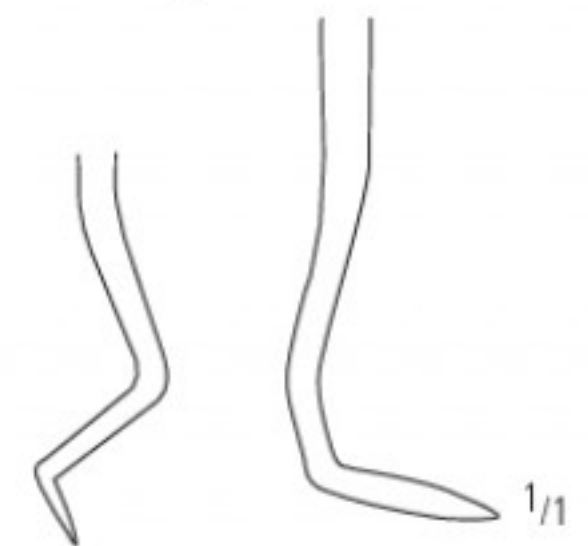

AA
AB
AC
AD
AE
AF
AK
AL
AO
AR
KA
KL
KU
PA
PB
PF
PI
PK
PL
PM
PP
PS
PT
PU
PV
KYE

Parodontalmeißel
 Periodontal chisels
 Cinceles de periodoncia
 Burins de parodontie
 Sgorbie per parodontologia

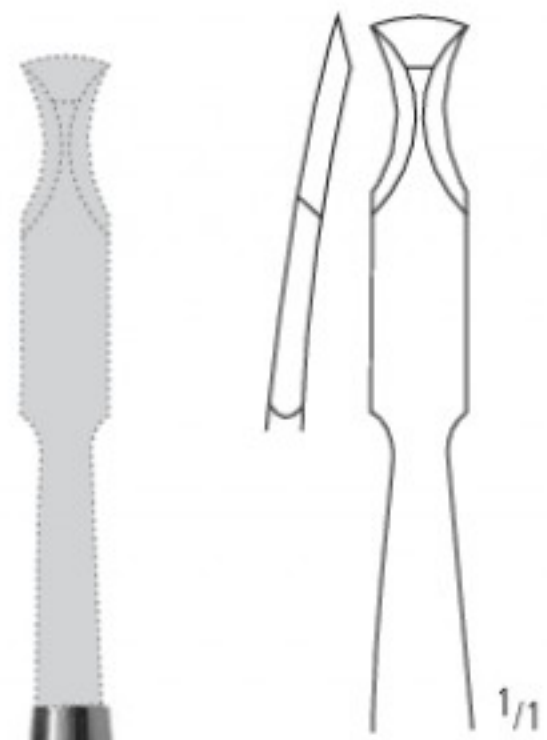

Fig. 1
 PK 357/01

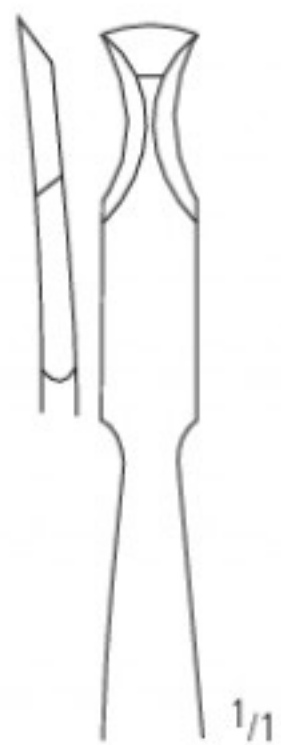

Fig. 2
 PK 357/02

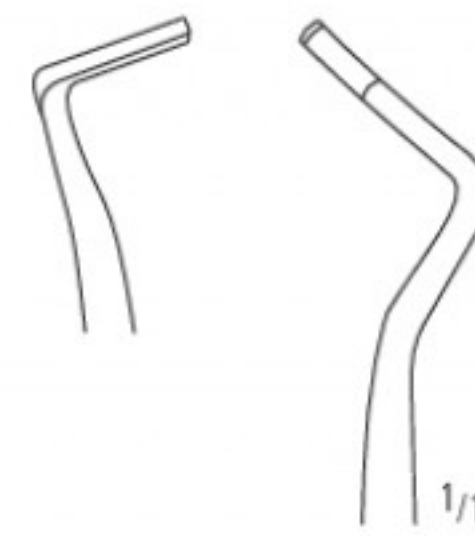
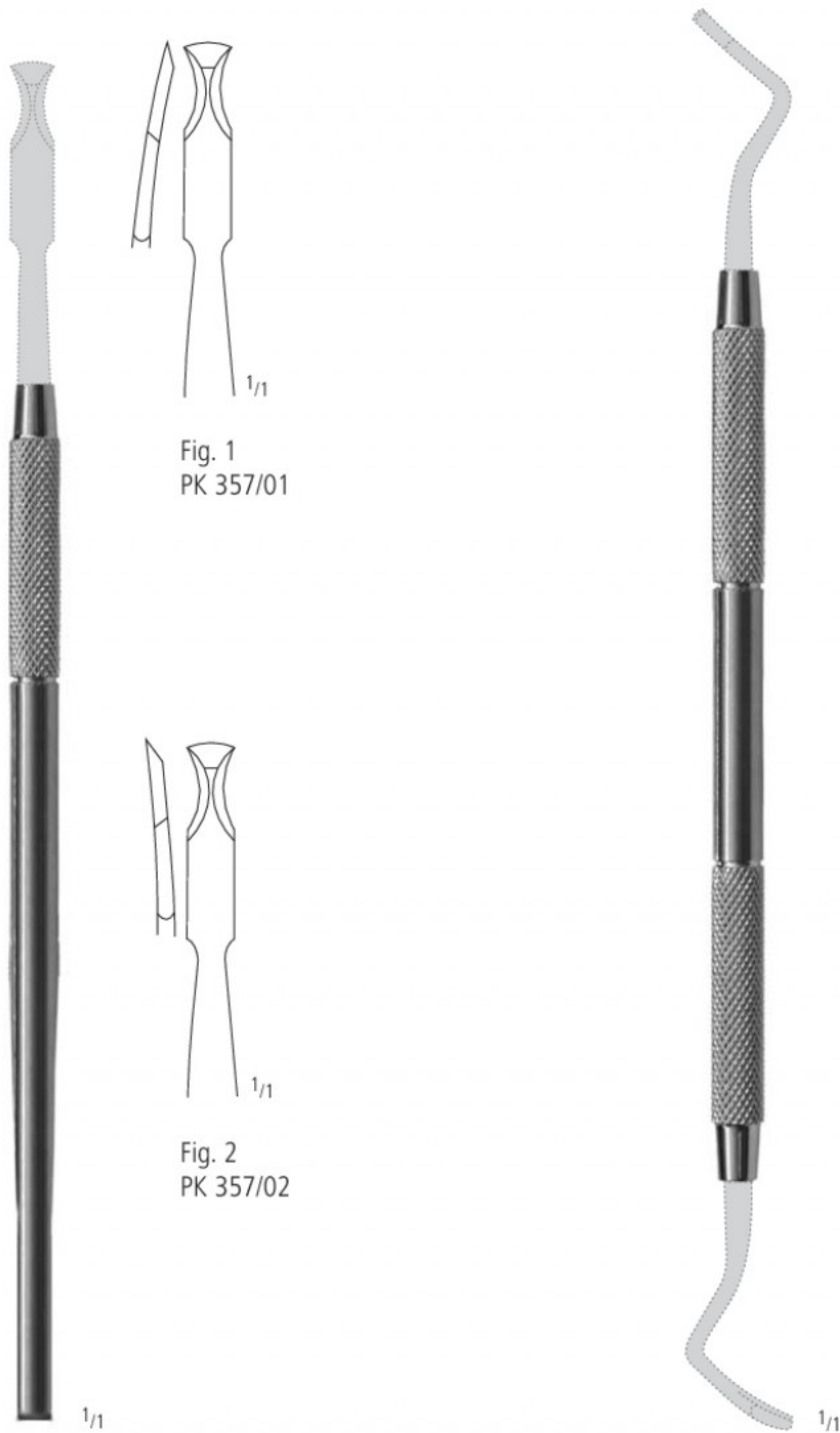
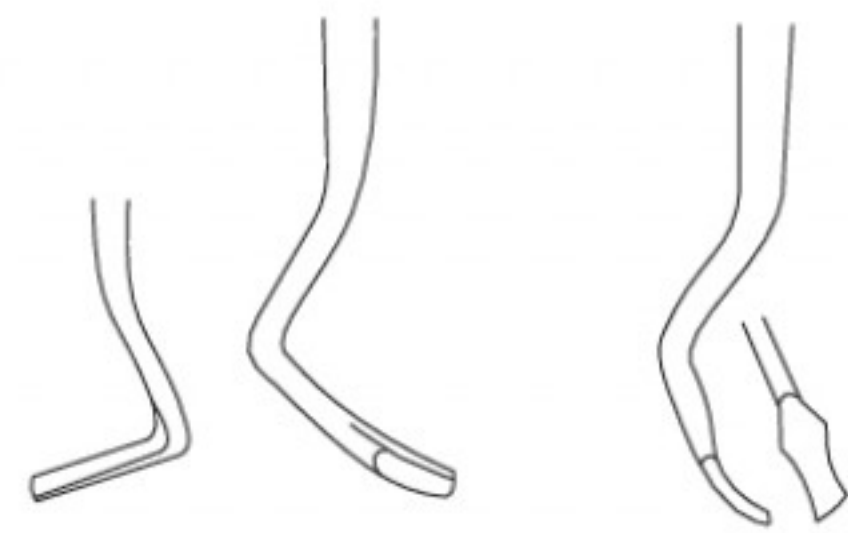

Fig. 3
 PK 357/03



Fig. 4
 PK 357/04



OCHSENBEIN
 17,0 cm/6³/₄"

OCHSENBEIN
 17,5 cm/7"

Raspatorien
Raspatories
Raspadores
Rugines-Raspatoires
Peristotomi

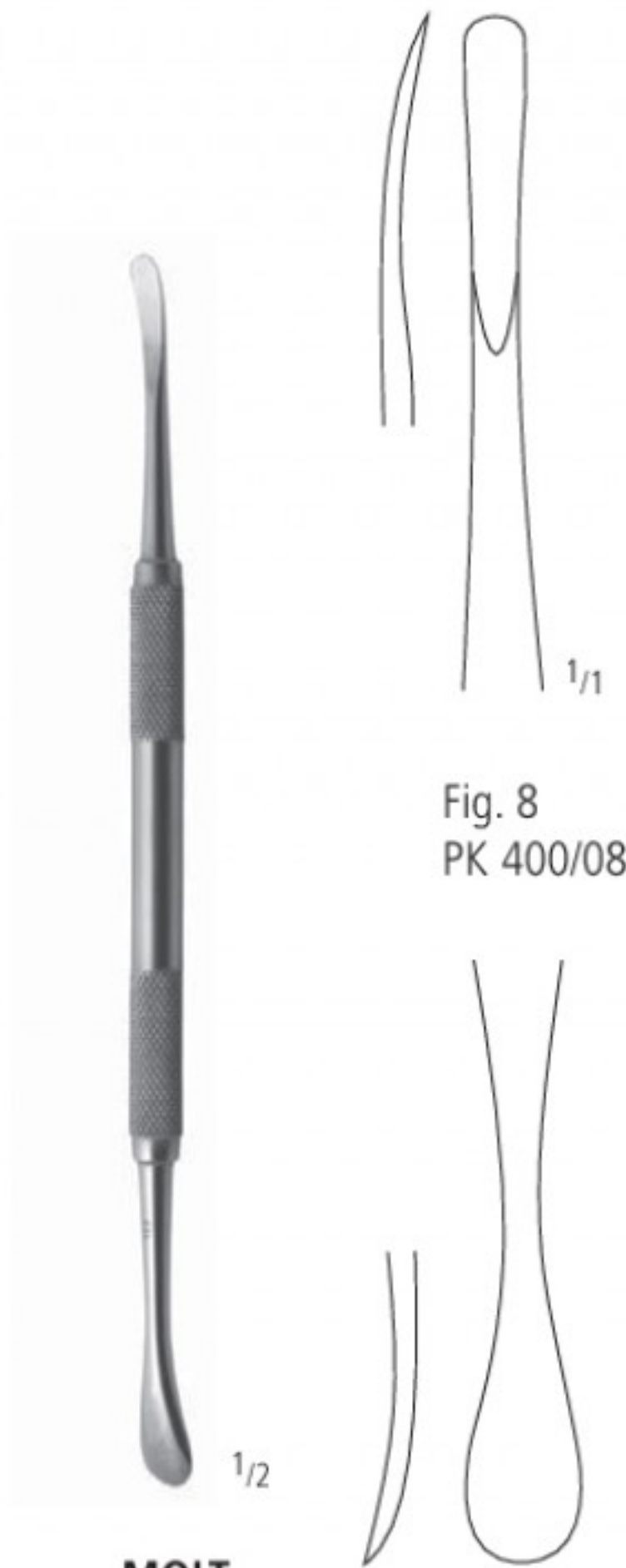

Fig. 8
PK 400/08

MOLT
18,0 cm/7"

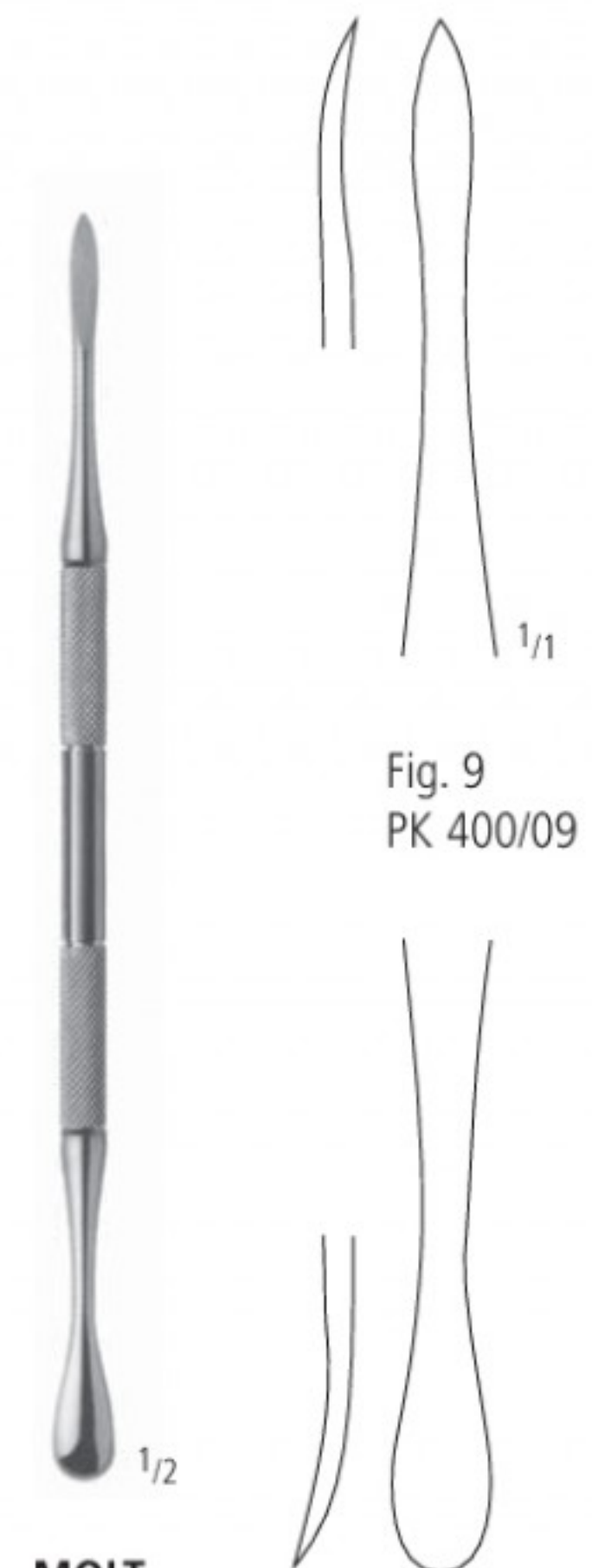
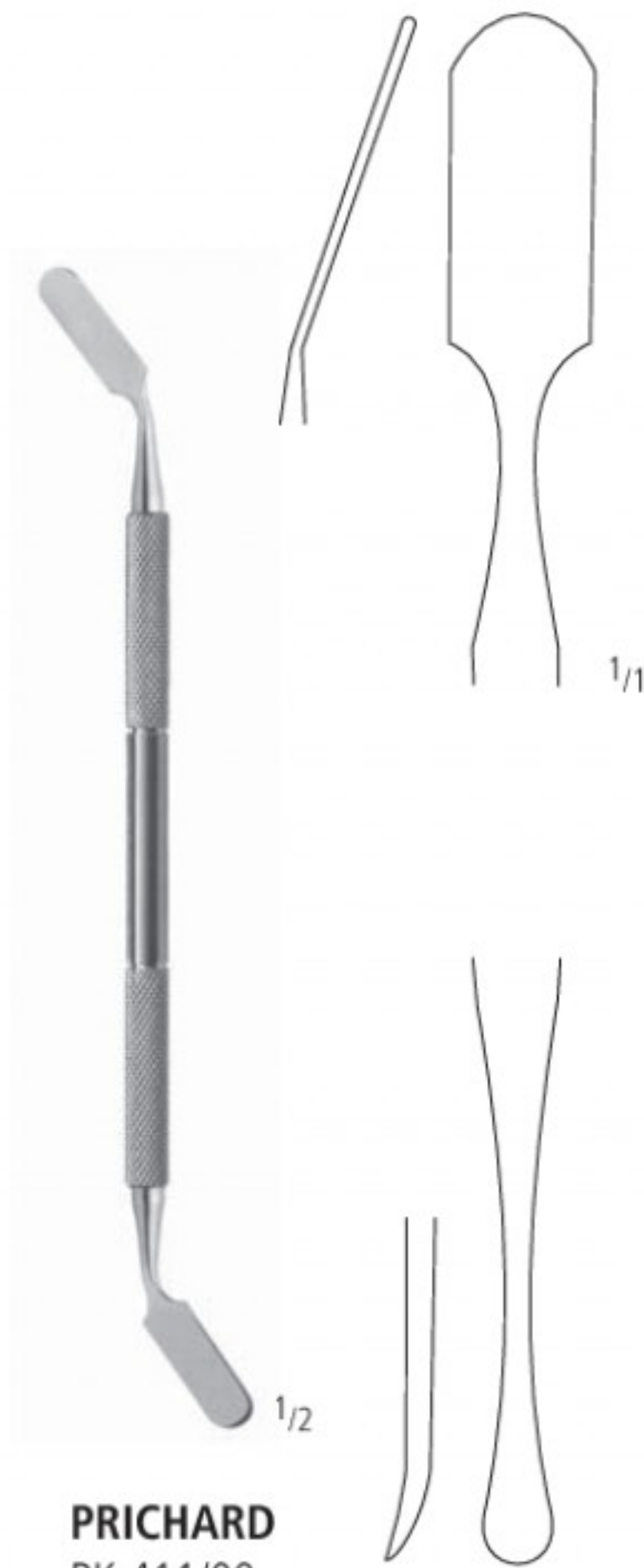

Fig. 9
PK 400/09

MOLT
18,0 cm/7"



PRICHARD
PK 411/00
17,0 cm/6³/₄"

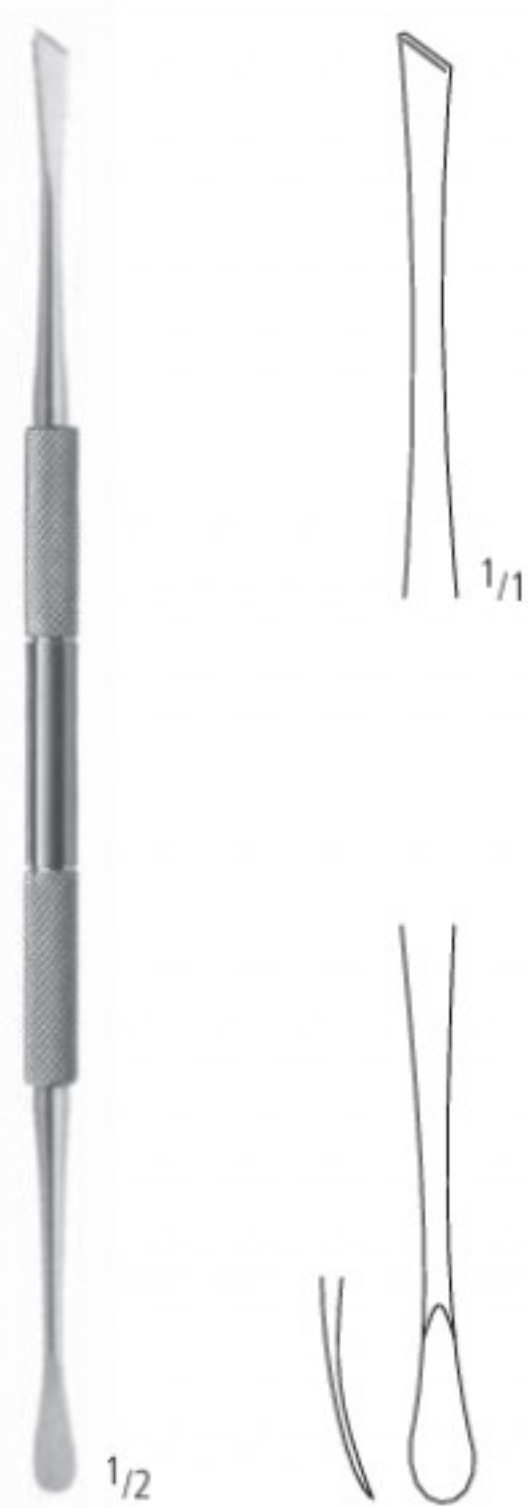

Fig. 23

SELDIN
PK 412/23
18 cm/7"

AA
AB
AC
AD
AE
AF
AK
AL
AO
AR
KA
KL
KU
PA
PB
PF
PI
PK
PL
PM
PP
PS
PT
PU
PV
KYE

Raspatorien
 Raspatories
 Raspadores
 Rugines-Raspatoires
 Peristotomi



WEST
 PK 415/00
 18,0 cm/7"

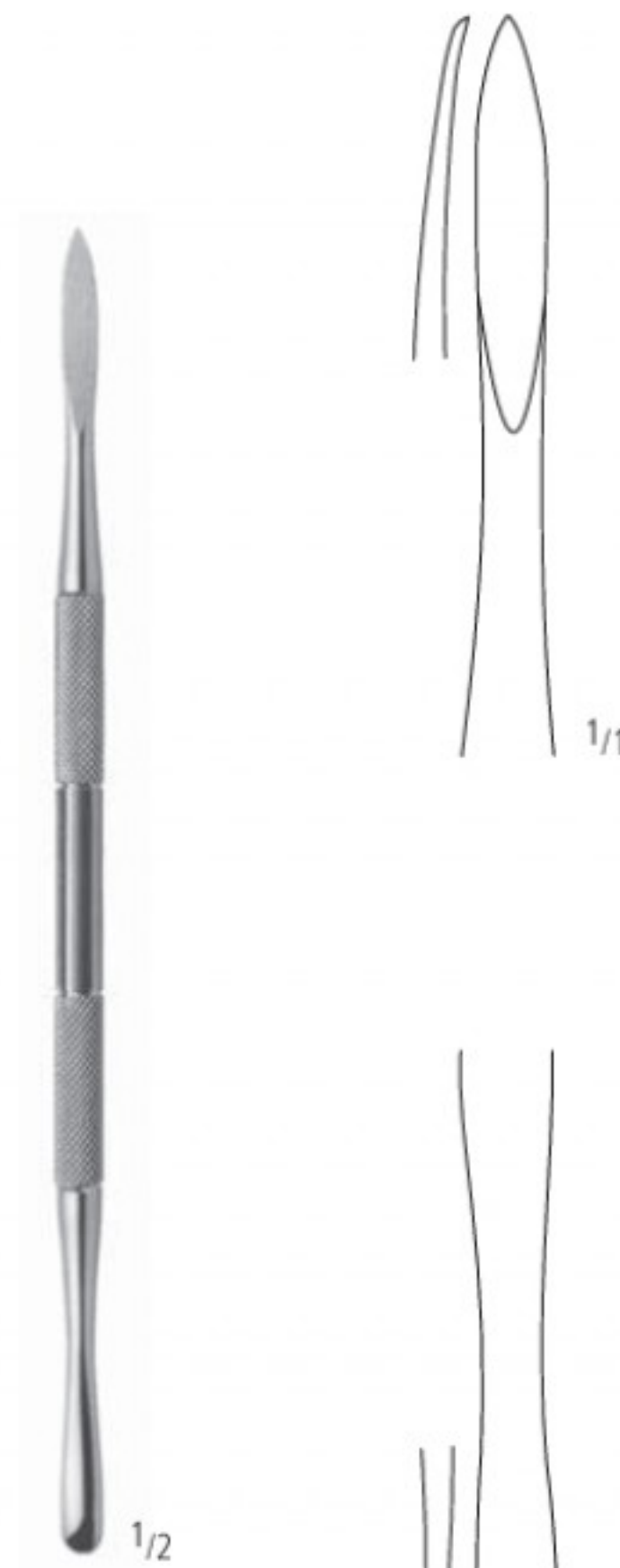

OHL
 PK 417/00
 18,0 cm/7"

Knochenfeilen
 Bone files
 Limas para huesos
 Limes à os
 Lime per ossa



MILLER-COLBURN
 18,0 cm / 7"

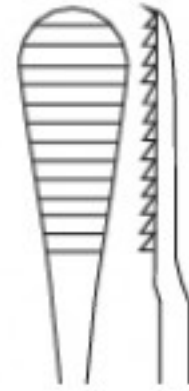

Fig. 1
 PK 420/01

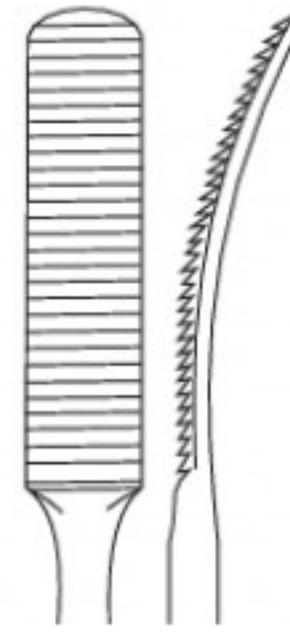

Fig. 2
 PK 420/02

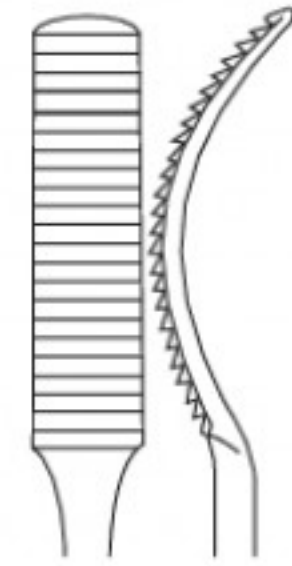

Fig. 3
 PK 420/03

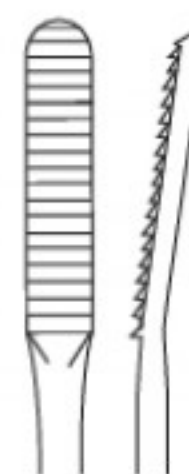
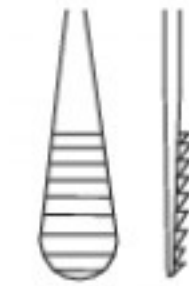
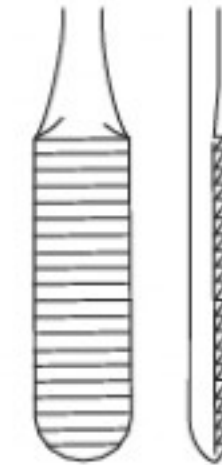

Fig. 4
 PK 420/04

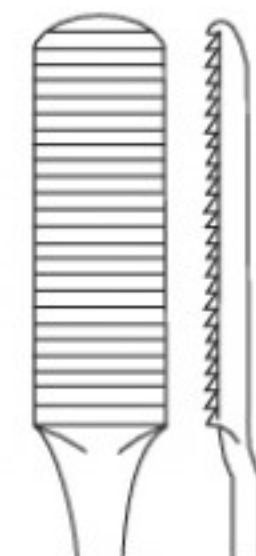
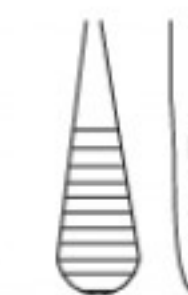

Fig. 5
 PK 420/05



AA
 AB
 AC
 AD
 AE
 AF
 AK
 AL
 AO
 AR
 KA
 KL
 KU
 PA
 PB
 PF
 PI
PK
 PL
 PM
 PP
 PS
 PT
 PU
 PV
 KYE

Knochenfeilen
 Bone files
 Limas para huesos
 Limes à os
 Lime per ossa



1/2

MILLER-COLBURN
 18,0 cm / 7"

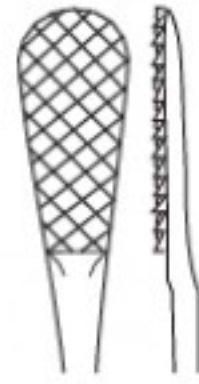

Fig. 1
 PK 421/01

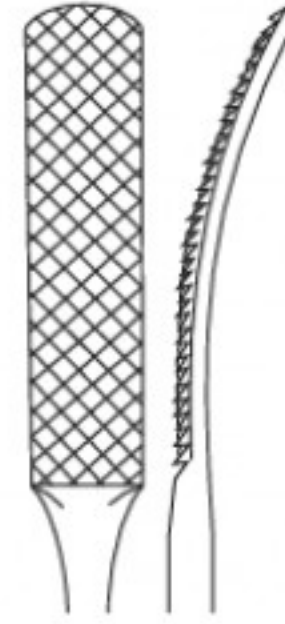

Fig. 2
 PK 421/02

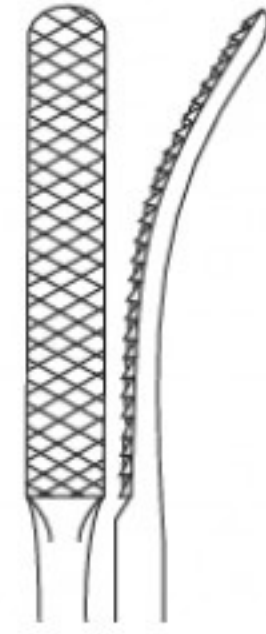

Fig. 3
 PK 421/03

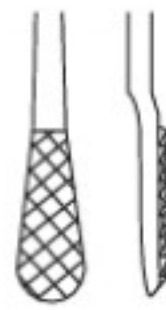

Fig. 4
 PK 421/04

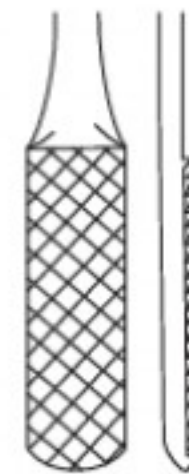
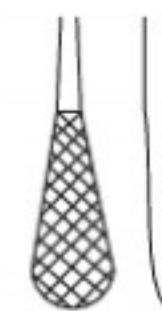
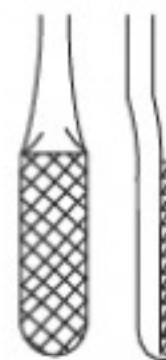

Fig. 5
 PK 421/05



Knochenfeilen
 Bone files
 Limas para huesos
 Limes à os
 Lime per ossa



17,5 cm/7"



Fig. 3/7
 PK 422/07



Fig. 5/11
 PK 422/11



AA
 AB
 AC
 AD
 AE
 AF
 AK
 AL
 AO
 AR
 KA
 KL
 KU
 PA
 PB
 PF
 PI
PK
 PL
 PM
 PP
 PS
 PT
 PU
 PV
 KYE

SONDEN
PROBES
SONDAS
SONDES
SONDE

PL

nopa[®] instruments



SONDEN PROBES SONDAS SONDES SONDE

Zahnsonden
Explorers
Sondas
Sondes
Sonde



17,5 cm/7"



Fig. 3
PL 060/03



Fig. 6
PL 060/06

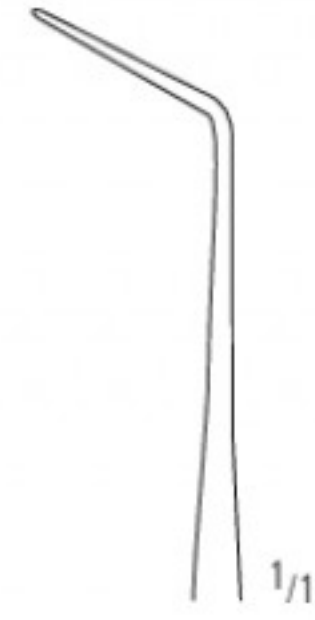

Fig. 6XL
PL 060/07



Fig. 8
PL 060/08



Fig. 9
PL 060/09



Fig. 17
PL 060/17



Fig. 23
PL 060/23

AA
AB
AC
AD
AE
AF
AK
AL
AO
AR
KA
KL
KU
PA
PB
PF
PI
PK
PL
PM
PP
PS
PT
PU
PV
KYE

Zahnsonden
Explorers
Sondas
Sondes
Sonde



17,5 cm/7"



Fig. 2/2
PL 211/02

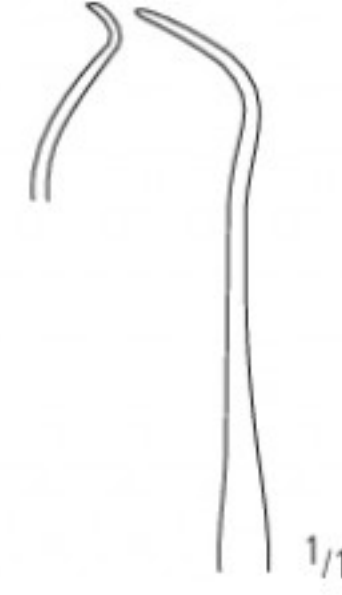

Fig. 3/3
PL 211/03

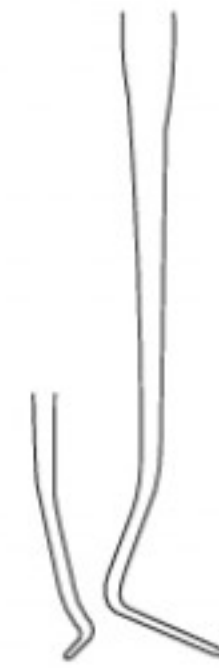

Fig. 5/6
PL 211/05

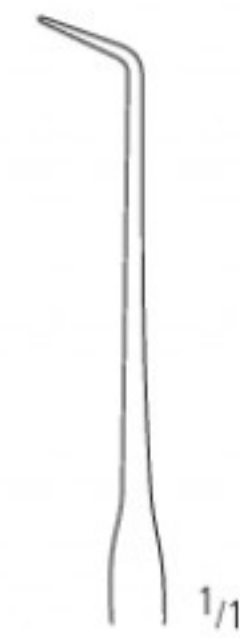

Fig. 23/6
PL 211/06



Fig. 17/23
PL 211/17



SONDEN PROBES SONDAS SONDES SONDE

Spreizer, Wurzelkanalstopfer
 Spreader, root canal plugger
 Extendedor, obturador
 Etendeur, fouloir à canaux
 Estensore, otturatore

AA
AB
AC
AD
AE
AF
AK
AL
AO
AR
KA
KL
KU
PA
PB
PF
PI
PK
PL
PM
PP
PS
PT
PU
PV
KYE



16,0 cm/6¹/₄"

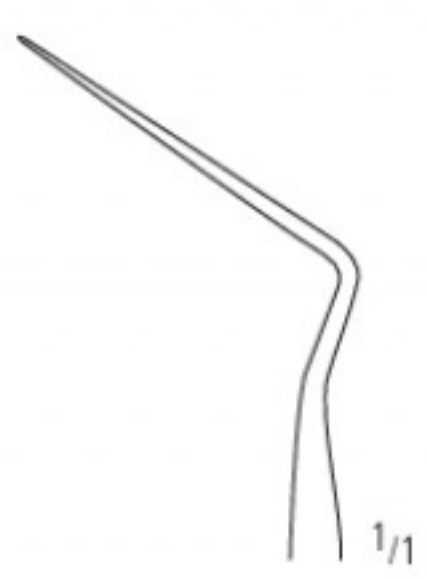

Fig. 20
PL 220/20

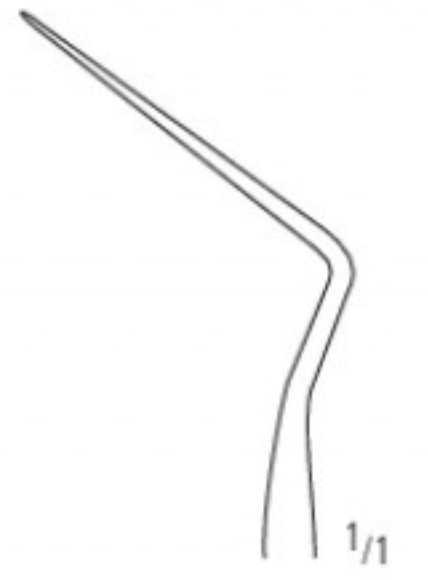

Fig. 30
PL 220/30

Spreizer Spreader Extendedor Etendeur Estensore

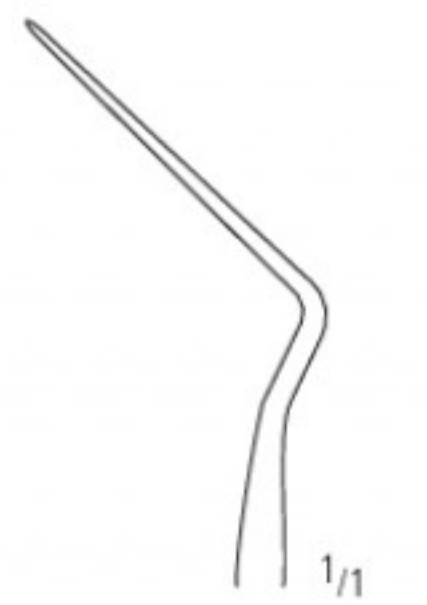

Fig. 40
PL 220/40

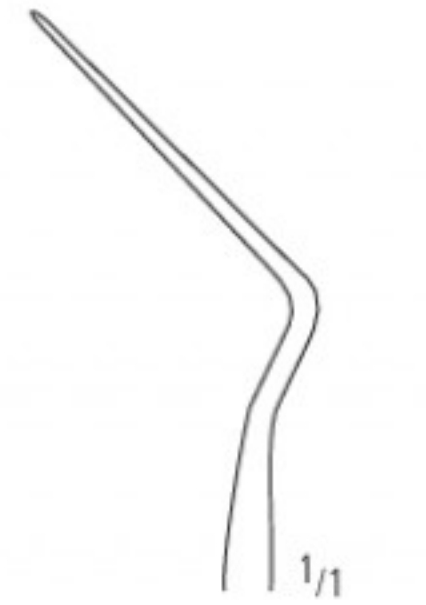

Fig. 50
PL 220/50



16,0 cm/6¹/₄"



0,6
PL 240/06



0,8
PL 240/08

Stopfer Plugger Obturador Obturateur Otturatore



1,0
PL 240/10

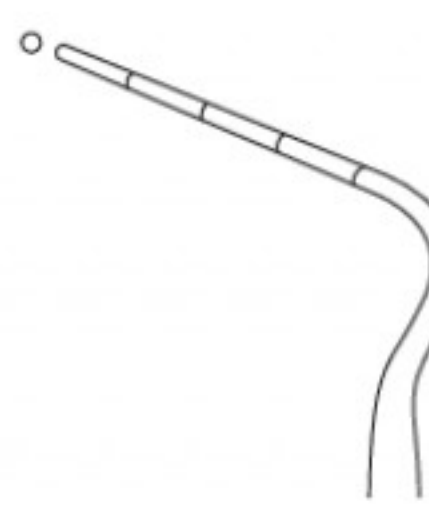

1,2
PL 240/12

PL

PL SONDEN PROBES SONDAS SONDES SONDE

Parodontometer
 Periodontal probes
 Sondas parodontales
 Sondes parodontales
 Sonde parodontali



16,0 cm/6¹/₄"



Fig. 11
 Grad. 3-6-8-11
 PL 251/11



Fig. 12
 Grad. 3-6-9-12
 PL 251/12



16,0 cm/6¹/₄"



OMS
 Fig. CPG 12
 Grad. 3-6-9-12
 PL 251/22



Fig. 15
 Grad. 1-2-3-5-7-8-9-10-11-12-13-14-15
 PL 251/15



Fig. 18
 Grad. 3-5-8-10
 PL 251/18



WHO
 Fig. CPG 11,5
 Grad. 3,5-5,5-8,5-11,5
 PL 251/23

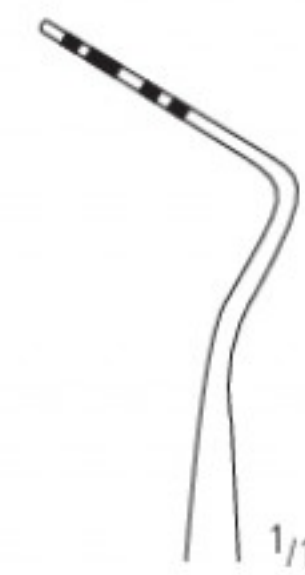

Fig 10
 Grad. 1-2-3-5-7-8-9-10
 PL 251/24



Fig. W
 Grad. 1-2-3-5-7-9-10
 PL 251/25

EXKAVATOREN
EXCAVATORS
EXCAVADORES
EXCAVATEURS
ESCAVATORI

PM

nopa[®] instruments



EXKAVATOREN EXCAVATORS EXCAVADORES EXCAVATEURS ESCAVATORI

Exkavatoren
Excavators
Excavadores
Excavateurs
Escavatori



17,5 cm/7"



Fig. 0
PM 100/00



Fig. 1
PM 100/01



Fig. 2
PM 100/02



Fig. 3
PM 100/03



Fig. 4
PM 100/04



AA
AB
AC
AD
AE
AF
AK
AL
AO
AR
KA
KL
KU
PA
PB
PF
PI
PK
PL
PM
PP
PS
PT
PU
PV
KYE

Exkavatoren
Excavators
Excavadores
Excavateurs
Escavatori



WHITE
17,5 cm/7"



Fig. 17
PM 120/17



Fig. 18
PM 120/18



Fig. 19
PM 120/19



EXKAVATOREN EXCAVATORS EXCAVADORES EXCAVATEURS ESCAVATORI

Exkavatoren
Excavators
Excavadores
Excavateurs
Escavatori



17,5 cm/7"



Fig. 17
PM 121/17



Fig. 18
PM 121/18



Fig. 19
PM 121/19



Fig. 31L
PM 121/31

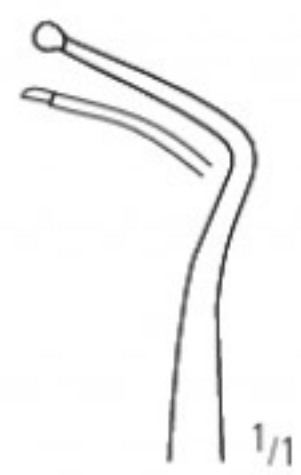

Fig. 32L
PM 121/32



Fig. 33L
PM 121/33



AA
AB
AC
AD
AE
AF
AK
AL
AO
AR
KA
KL
KU
PA
PB
PF
PI
PK
PL
PM
PP
PS
PT
PU
PV
KYE

SCHMELZMEISSEL
ENAMEL CHISELS
CINCELES PARA ESMALTE
CISEAUX A EMAIL
TAGLIASMALTO

PP

nopa[®] instruments



SCHMELZMEISSEL ENAMEL CHISELS CINCELES PARA ESMALTE CISEAUX A EMAIL TAGLIASMALTO

Schmelzmeißel
Enamel chisels
Cinceles para esmalte
Ciseaux à émail
Tagliasmaltos



BLACK
17,5 cm/7"



Fig. 51/52
PP 110/51



Fig. 53/54
PP 110/53



Fig. 63/64
PP 110/63



Fig. 65/66
PP 110/65



Fig. 77/78
PP 110/77



Fig. 79/80
PP 110/79



AA
AB
AC
AD
AE
AF
AK
AL
AO
AR
KA
KL
KU
PA
PB
PF
PI
PK
PL
PM
PP
PS
PT
PU
PV
KYE

Schmelzmeißel
 Enamel chisels
 Cinceles para esmalte
 Ciseaux à émail
 Tagliasmaltos



1/1

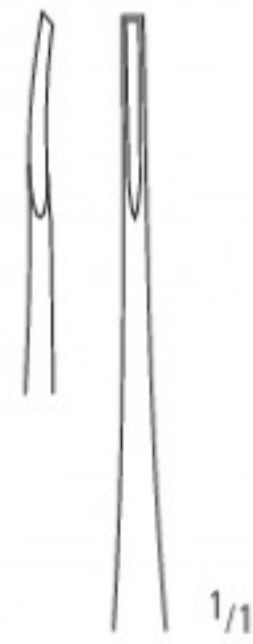

Fig. 1/2
 PP 120/01

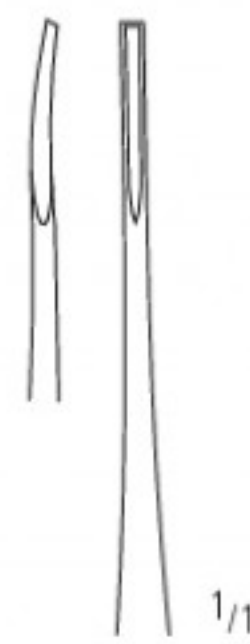

Fig. 3/4
 PP 120/03

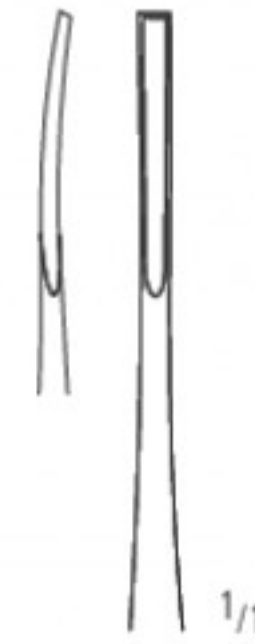
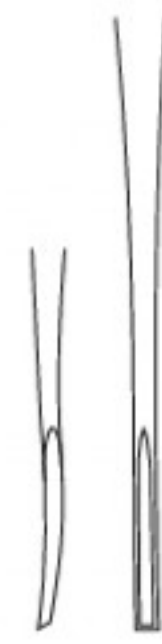
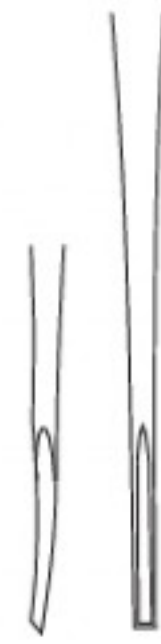

Fig. 5/6
 PP 120/06



WEDELSTAEDT
 17,5 cm/7"

FÜLLUNGSINSTRUMENTE
FILLING INSTRUMENTS
INSTRUMENTOS PARA OBTURACIONES
INSTRUMENTS POUR PLOMBAGES
OTTURATORI

PS

nopa[®] instruments



Füllungsinstrumente
 Filling instruments
 Instrumentos para obturaciones
 Instruments pour plombages
 Otturatori



HOLLENBACK
 17,5 cm/7"



Fig. 1
 PS 010/01



Fig. 2
 PS 010/02



Fig. 3
 PS 010/03



Fig. 4
 PS 010/04



AA
 AB
 AC
 AD
 AE
 AF
 AK
 AL
 AO
 AR
 KA
 KL
 KU
 PA
 PB
 PF
 PI
 PK
 PL
 PM
 PP
 PS
 PT
 PU
 PV
 KYE

Füllungsinstrumente
 Filling instruments
 Instrumentos para obturaciones
 Instruments pour plombages
 Otturatori



17,5 cm/7"



Fig. 1P
 PS 011/00



Fig. 3P
 PS 011/01



Fig. 4P
 PS 012/00



Fig. 3S
 PS 013/03



Fig. 4S
 PS 013/04



Planstopfer
 Plane condenser
 Condensador plano
 Obturateur plan
 Otturatore piano



17,5 cm/7"



Fig. 1S
 PS 020/01



Fig. 2S
 PS 020/02



Fig. 3S
 PS 020/03



AA AB AC AD AE AF AG AH AI AJ AK AL AM AN AO AP AQ AR AS AT AU AV AW AX AY AZ BA BB BC BD BE BF BG BH BI BJ BK BL BM BN BO BP BQ BR BS BT BU BV BW BX BY BZ CA CB CC CD CE CF CG CH CI CJ CK CL CM CN CO CP CQ CR CS CT CU CV CW CX CY CZ DA DB DC DD DE DF DG DH DI DJ DK DL DM DN DO DP DQ DR DS DT DU DV DW DX DY DZ EA EB EC ED EE EF EG EH EI EJ EK EL EM EN EO EP EQ ER ES ET EU EV EW EX EY EZ FA FB FC FD FE FF FG FH FI FJ FK FL FM FN FO FP FQ FR FS FT FU FV FW FX FY FZ GA GB GC GD GE GF GG GH GI GJ GK GL GM GN GO GP GQ GR GS GT GU GV GW GX GY GZ HA HB HC HD HE HF HG HH HI HJ HK HL HM HN HO HP HQ HR HS HT HU HV HW HX HY HZ IA IB IC ID IE IF IG IH II IJ IK IL IM IN IO IP IQ IR IS IT IU IV IW IX IY IZ JA JB JC JD JE JF JG JH JI JJ JK JL JM JN JO JP JQ JR JS JT JU JV JW JX JY JZ KA KB KC KD KE KF KG KH KI KJ KL KM KN KO KP KQ KR KS KT KU KV KW KX KY KZ LA LB LC LD LE LF LG LH LI LJ LK LL LM LN LO LP LQ LR LS LT LU LV LW LX LY LZ MA MB MC MD ME MF MG MH MI MJ MK ML MN MO MP MQ MR MS MT MU MV MW MX MY MZ NA NB NC ND NE NF NG NH NI NJ NK NL NM NO NP NQ NR NS NT NU NV NW NX NY NZ OA OB OC OD OE OF OG OH OI OJ OK OL OM ON OO OP OQ OR OS OT OU OV OW OX OY OZ PA PB PC PD PE PF PG PH PI PJ PK PL PM PN PO PP PQ PR PS PT PU PV PW PX PY PZ QA QB QC QD QE QF QG QH QI QJ QK QL QM QN QO QP QQ QR QS QT QU QV QW QX QY QZ RA RB RC RD RE RF RG RH RI RJ RK RL RM RN RO RP RQ RR RS RT RU RV RW RX RY RZ SA SB SC SD SE SF SG SH SI SJ SK SL SM SN SO SP SQ SR SS ST SU SV SW SX SY SZ TA TB TC TD TE TF TG TH TI TJ TK TL TM TN TO TP TQ TR TS TT TU TV TW TX TY TZ UA UB UC UD UE UF UG UH UI UJ UK UL UM UN UO UP UQ UR US UT UY UZ VA VB VC VD VE VF VG VH VI VJ VK VL VM VN VO VP VQ VR VS VT VY VZ WA WB WC WD WE WF WG WH WI WJ WK WL WM WN WO WP WQ WR WS WT WY WZ XA XB XC XD XE XF XG XH XI XJ XK XL XM XN XO XP XQ XR XS XT XU XV XW XX XY XZ YA YB YC YD YE YF YG YH YI YJ YK YL YM YN YO YP YQ YR YS YT YU YV YW YX YY YZ ZA ZB ZC ZD ZE ZF ZG ZH ZI ZJ ZK ZL ZM ZN ZO ZP ZQ ZR ZS ZT ZU ZV ZW ZX ZY ZZ

PS

Kompositinstrumente
Composite instruments
Instrumentos para composites
Instruments pour composites
Strumenti composito

TINI[®] = TI

Arbeitsenden Titan-Nitrit beschichtet (TINI[®])
Working ends Titanium-Nitride coating (TINI[®])



Füllungsinstrumente
Filling instruments
Instrumentos para obturaciones
Instruments pour plombages
Otturatori

AA
AB
AC
AD
AE
AF
AK
AL
AO
AR
KA
KL
KU
PA
PB
PF
PI
PK
PL
PM
PP
PS
PT
PU
PV
KYE



HEIDEMANN
18,0 cm/7"



Fig. 1
PS 030/01
PS 030/01**TI**



2,0 mm



Fig. 2
PS 030/02
PS 030/02**TI**



2,5 mm



Fig. 3
PS 030/03
PS 030/03**TI**



3,0 mm



USA
17,5 cm/7"



Fig. 1
PS 040/01
PS 040/01**TI**



Fig. 2
PS 040/02
PS 040/02**TI**



Füllungsinstrumente
 Filling instruments
 Instrumentos para obturaciones
 Instruments pour plombages
 Otturatori



WOODSON
 18,0 cm/7"



Fig. 1
 PS 070/01

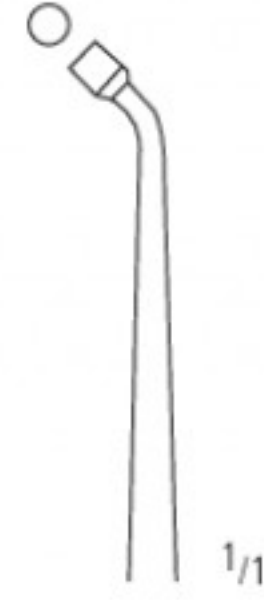

Fig. 2
 PS 070/02



Fig. 3
 PS 070/03



Planstopfer, Füllungsinstrumente
 Plane condenser, filling instruments
 Condensador plano, instrumentos para obturaciones
 Obturateur plan, instruments pour plombages
 Otturatore piano, otturatori



17,5 cm/7"



Fig. 1
PS 090/01



Fig. 2
PS 090/02



Fig. 3
PS 090/03



Fig. 1D
PS 100/01
PS 100/01TI



Fig. 2D
PS 100/02
PS 100/02TI



Fig. T 1
PS 100/03
PS 100/03TI



AA AB AC AD AE AF AG AH AI AJ AK AL AM AN AO AP AQ AR AS AT AU AV AW AX AY AZ BA BB BC BD BE BF BG BH BI BJ BK BL BM BN BO BP BQ BR BS BT BU BV BW BX BY BZ CA CB CC CD CE CF CG CH CI CJ CK CL CM CN CO CP CQ CR CS CT CU CV CW CX CY CZ DA DB DC DE DF DG DH DI DJ DK DL DM DN DO DP DQ DR DS DT DU DV DW DX DY DZ EA EB EC ED EE EF EG EH EI EJ EK EL EM EN EO EP EQ ER ES ET EU EV EW EX EY EZ FA FB FC FD FE FF FG FH FI FJ FK FL FM FN FO FP FQ FR FS FT FU FV FW FX FY FZ GA GB GC GD GE GF GG GH GI GJ GK GL GM GN GO GP GQ GR GS GT GU GV GW GX GY GZ HA HB HC HD HE HF HG HH HI HJ HK HL HM HN HO HP HQ HR HS HT HU HV HW HX HY HZ IA IB IC ID IE IF IG IH II IJ IK IL IM IN IO IP IQ IR IS IT IU IV IW IX IY IZ JA JB JC JD JE JF JG JH JI JJ JK JL JM JN JO JP JQ JR JS JT JU JV JW JX JY JZ KA KB KC KD KE KF KG KH KI KJ KL KM KN KO KP KQ KR KS KT KU KV KW KX KY KZ LA LB LC LD LE LF LG LH LI LJ LK LL LM LN LO LP LQ LR LS LT LU LV LW LX LY LZ MA MB MC MD ME MF MG MH MI MJ MK ML MN MO MP MQ MR MS MT MU MV MW MX MY MZ NA NB NC ND NE NF NG NH NI NJ NK NL NO NP NQ NR NS NT NU NV NW NX NY NZ OA OB OC OD OE OF OG OH OI OJ OK OL OM ON OO OP OQ OR OS OT OU OV OW OX OY OZ PA PB PC PD PE PF PG PH PI PJ PK PL PM PN PO PP PQ PR PS PT PU PV PW PX PY PZ QA QB QC QD QE QF QG QH QI QJ QK QL QM QN QO QP QQ QR QS QT QU QV QW QX QY QZ RA RB RC RD RE RF RG RH RI RJ RK RL RM RN RO RP RQ RR RS RT RU RV RW RX RY RZ SA SB SC SD SE SF SG SH SI SJ SK SL SM SN SO SP SQ SR SS ST SU SV SW SX SY SZ TA TB TC TD TE TF TG TH TI TJ TK TL TM TN TO TP TQ TR TS TT TU TV TW TX TY TZ UA UB UC UD UE UF UG UH UI UJ UK UL UM UN UO UP UQ UR US UT UU UV UW UX UY UZ VA VB VC VD VE VF VG VH VI VJ VK VL VM VN VO VP VQ VR VS VT VU VW VX VY VZ WA WB WC WD WE WF WG WH WI WJ WK WL WM WN WO WP WQ WR WS WT WU WV WW WX WY WZ XA XB XC XD XE XF XG XH XI XJ XK XL XM XN XO XP XQ XR XS XT XU XV XW XX XY XZ YA YB YC YD YE YF YG YH YI YJ YK YL YM YN YO YP YQ YR YS YT YU YV YW YX YY YZ ZA ZB ZC ZD ZE ZF ZG ZH ZI ZJ ZK ZL ZM ZN ZO ZP ZQ ZR ZS ZT ZU ZV ZW ZX ZY ZZ

PS

Füllungsinstrumente
 Filling instruments
 Instrumentos para obturaciones
 Instruments pour plombages
 Otturatori



17,0 cm/6³/₄"



Fig. 26/27S
 PS 102/26



Fig. 27/29
 PS 102/27



Fig. 28/29
 PS 102/28



Fig. 7A
 PS 104/00



Kugelstopfer
 Ball type condenser
 Condensador tipo bola
 Obturateur à bille
 Otturatore a sfera



17,0 cm/6³/₄"



Fig. 1
PS 110/01



Fig. 2
PS 110/02



Fig. 3
PS 110/03



Fig. 4
PS 110/04



Fig. 5
PS 110/05



AA
AB
AC
AD
AE
AF
AK
AL
AO
AR
KA
KL
KU
PA
PB
PF
PI
PK
PL
PM
PP
PS
PT
PU
PV
KYE

Kugel/Spatel-Kombination
 Ball/spatula combination
 Combinación bola/espátula
 Combinaison bille/spatule
 Combinazione sfera/spatola



17,0 cm/6³/₄"



Fig. 1
PS 115/01



Fig. 2
PS 115/02

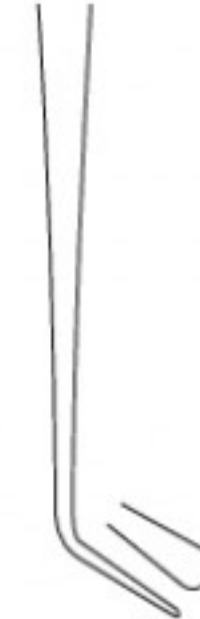

Fig. 3
PS 115/03



Spatel
Spatula
Espátula
Spatule
Spatola



17,5 cm/7"



Fig. 1
PS 120/01



Fig. 2
PS 120/02



Fig. 3
PS 120/03



Fig. 6
PS 120/06



Fig. 12
PS 120/12



AA AB AC AD AE AF AG AH AI AJ AK AL AM AN AO AP AQ AR AS AT AU AV AW AX AY AZ
BA BB BC BD BE BF BG BH BI BJ BK BL BM BN BO BP BQ BR BS BT BU BV BW BX BY BZ
CA CB CC CD CE CF CG CH CI CJ CK CL CM CN CO CP CQ CR CS CT CU CV CW CX CY CZ
DA DB DC DD DE DF DG DH DI DJ DK DL DM DN DO DP DQ DR DS DT DU DV DW DX DY DZ
EA EB EC ED EE EF EG EH EI EJ EK EL EM EN EO EP EQ ER ES ET EU EV EW EX EY EZ
FA FB FC FD FE FF FG FH FI FJ FK FL FM FN FO FP FQ FR FS FT FU FV FW FX FY FZ
GA GB GC GD GE GF GG GH GI GJ GK GL GM GN GO GP GQ GR GS GT GU GV GW GX GY GZ
HA HB HC HD HE HF HG HH HI HJ HK HL HM HN HO HP HQ HR HS HT HU HV HW HX HY HZ
IA IB IC ID IE IF IG IH II IJ IK IL IM IN IO IP IQ IR IS IT IU IV IW IX IY IZ
JA JB JC JD JE JF JG JH JI JJ JK JL JM JN JO JP JQ JR JS JT JU JV JW JX JY JZ
KA KB KC KD KE KF KG KH KI KJ KL KM KN KO KP KQ KR KS KT KU KV KW KX KY KZ
LA LB LC LD LE LF LG LH LI LJ LK LL LM LN LO LP LQ LR LS LT LU LV LW LX LY LZ
MA MB MC MD ME MF MG MH MI MJ MK ML MN MO MP MQ MR MS MT MU MV MW MX MY MZ
NA NB NC ND NE NF NG NH NI NJ NK NL NN NO NP NQ NR NS NT NU NV NW NX NY NZ
OA OB OC OD OE OF OG OH OI OJ OK OL OM ON OO OP OQ OR OS OT OU OV OW OX OY OZ
PA PB PC PD PE PF PG PH PI PJ PK PL PM PN PO PP PQ PR PS PT PU PV PW PX PY PZ
QA QB QC QD QE QF QG QH QI QJ QK QL QM QN QO QQ QR QS QT QU QV QW QX QY QZ
RA RB RC RD RE RF RG RH RI RJ RK RL RM RN RO RP RQ RR RS RT RU RV RW RX RY RZ
SA SB SC SD SE SF SG SH SI SJ SK SL SM SN SO SP SQ SR SS ST SU SV SW SX SY SZ
TA TB TC TD TE TF TG TH TI TJ TK TL TM TN TO TP TQ TR TS TT TU TV TW TX TY TZ
UA UB UC UD UE UF UG UH UI UJ UK UL UM UN UO UP UQ UR US UT UU UV UW UX UY UZ
VA VB VC VD VE VF VG VH VI VJ VK VL VM VN VO VP VQ VR VS VT VU VV VW VX VY VZ
WA WB WC WD WE WF WG WH WI WJ WK WL WM WN WO WP WQ WR WS WT WU WV WW WX WY WZ
XA XB XC XD XE XF XG XH XI XJ XK XL XM XN XO XP XQ XR XS XT XU XV XW XX XY XZ
YA YB YC YD YE YF YG YH YI YJ YK YL YM YN YO YP YQ YR YS YT YU YV YW YX YY YZ
ZA ZB ZC ZD ZE ZF ZG ZH ZI ZJ ZK ZL ZM ZN ZO ZP ZQ ZR ZS ZT ZU ZV ZW ZX ZY ZZ

PS

Füllungsinstrumente
 Filling instruments
 Instrumentos para obturaciones
 Instruments pour plombages
 Otturatori



BENNET
 PS 150/07



PS 160/00
 16,5 cm/6 1/2"



Fig. 1



Elefantenfußstopfer
 Elephant foot condenser
 Condensador pie de elefante
 Obturateur pied d' éléphant
 Otturatore a piede di elefante



17,5 cm/7"



Fig. T 2
 PS 161/00



Fig. M 2
 PS 162/00



Amalgaminstrumente
Amalgam instruments
Instrumentos amalgamas
Instruments à amalgame
Strumenti per amalgama



PS 180/01



PS 180/02

Kunststoffansatz
Plastic tip



PS 181/01

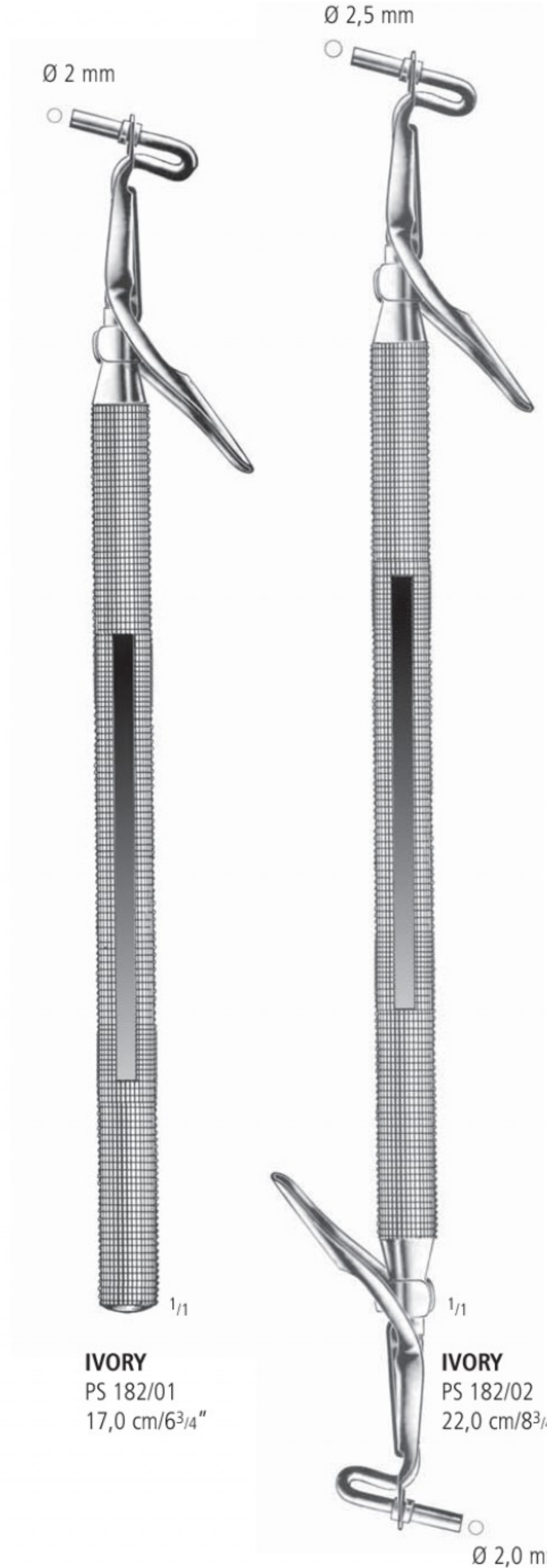

AA
AB
AC
AD
AE
AF
AK
AL
AO
AR
KA
KL
KU
PA
PB
PF
PI
PK
PL
PM
PP
PS
PT
PU
PV
KYE

Zementspatel
 Cement mixing spatula
 Espátula para mezclar
 Spatule à plâtre
 Spatola per cemento



18,0 cm/7"

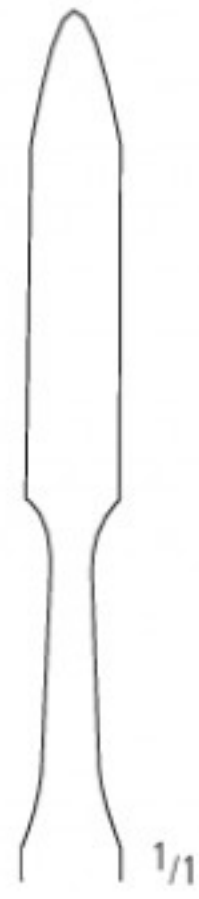

Fig. 1
PS 300/01



Fig. 2
PS 300/02

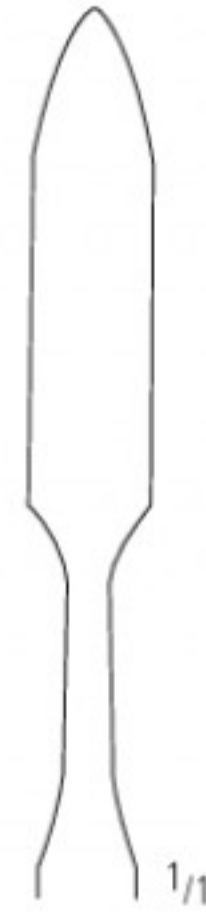
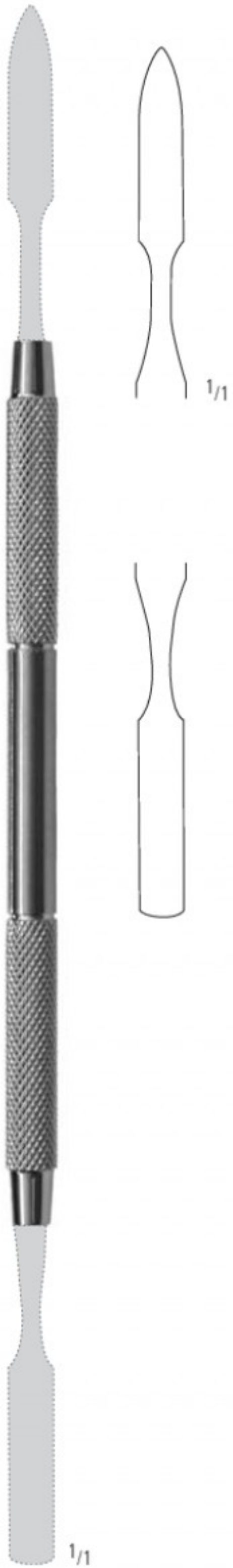

Fig. 3
PS 300/03



Zementspatel
 Cement mixing spatula
 Espátula para mezclar
 Spatule à plâtre
 Spatola per cemento



PS 302/18
 19,0 cm/7¹/₂"



21,0 cm/8¹/₄"

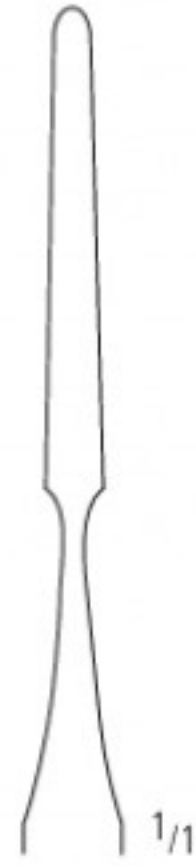

Fig. 00
 PS 303/01

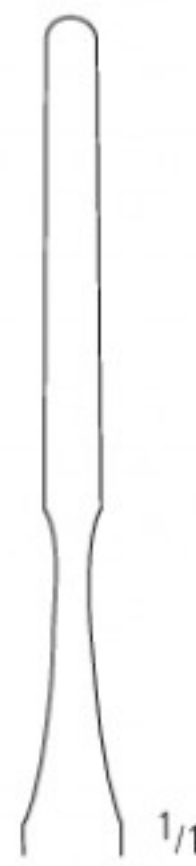

Fig. 0
 PS 303/02



PS 304/02
 19,0 cm/7¹/₂"

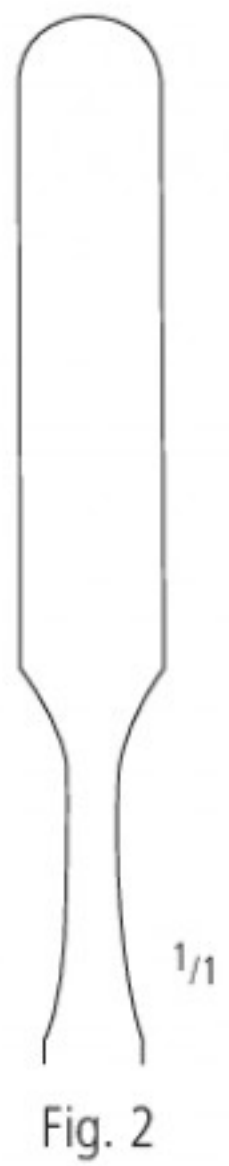

Fig. 2

AA
 AB
 AC
 AD
 AE
 AF
 AK
 AL
 AO
 AR
 KA
 KL
 KU
 PA
 PB
 PF
 PI
 PK
 PL
 PM
 PP
 PS
 PT
 PU
 PV
 KYE

Kompositinstrumente
 Composite instruments
 Instrumentos para composites
 Instruments pour composites
 Strumenti composito



17,5 cm/7"



FELT
 Fig. 1
 PS 306/01



FELT
 Fig. 2
 PS 306/02

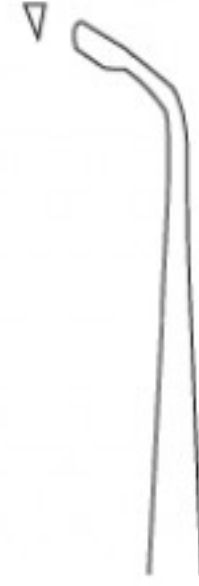
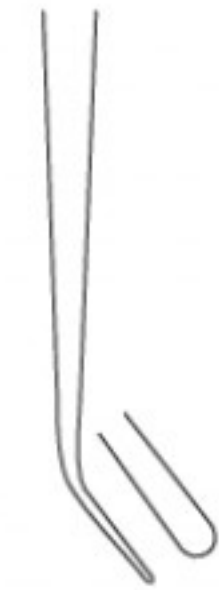

FELT
 Fig. 3
 PS 306/03



FELT
 Fig. 4
 PS 306/04

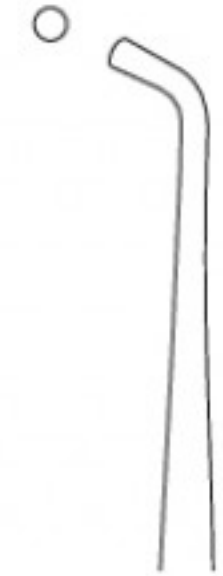

FELT
 Fig. 5
 PS 306/05



FELT
 Fig. 6
 PS 306/06

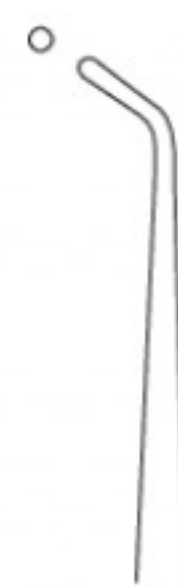

GOLDSTEIN
 Fig. 1
 PS 307/01



GOLDSTEIN
 Fig. 2
 PS 307/02



GOLDSTEIN
 Fig. 3
 PS 307/03



GOLDSTEIN
 Fig. 4
 PS 307/04



PROTHETIK UND ORTHODONTIE
PROTHETICS AND ORTHODONTIA
PROTESIS Y ORTODONCIA
PROTHESE ET ORTHODONTIE
PROTESI E ORTODONZIA

PT

nopa[®] instruments



Wachs-, Porzellan- und Modellierinstrumente
 Wax, porcelain and modelling carvers
 Talladores y espátulas para cera, porcelana y modelar
 Instruments à modeler
 Strumenti per modellare



Fig. 1S



WARD
PT 010/01



Fig. 2



WARD
PT 010/02



Fig. 2/3



FRAHM
PT 020/01



Fig. 1/2



HOLLENBACK
PT 050/01



Fig. 2



HOLLENBACK
PT 050/03

AA
AB
AC
AD
AE
AF
AK
AL
AO
AR
KA
KL
KU
PA
PB
PF
PI
PK
PL
PM
PP
PS
PT
PU
PV
KYE

Wachs-, Porzellan- und Modellierinstrumente
 Wax, porcelain and modelling carvers
 Talladores y espátulas para cera, porcelana y modelar
 Instruments à modeler
 Strumenti per modellare



HYLIN



HYLIN
 PT 080/00
 17,0 cm/6³/₄"



ZAHLE
 PT 090/00
 15,0 cm/6"



LE CRON Fig. 1
 PT 100/00
 16,0 cm/6¹/₄"



BEALE Fig. 1
 PT 120/00
 16,0 cm/6¹/₄"



Wachs-, Porzellan- und Modellierinstrumente
 Wax, porcelain and modelling carvers
 Talladores y espátulas para cera, porcelana y modelar
 Instruments à modeler
 Strumenti per modellare



THOMAS
 17,5 cm/7"



Fig. 1
 PT 130/01



Fig. 2
 PT 130/02



Fig. 3
 PT 130/03

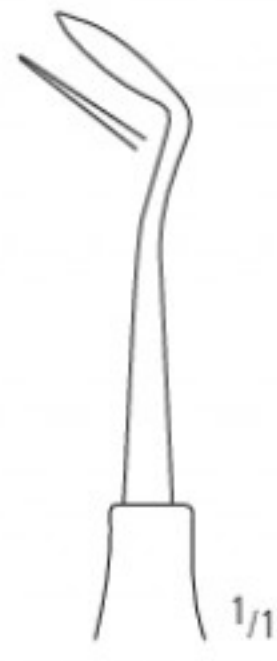

Fig. 4
 PT 130/04



Fig. 5
 PT 130/05



AA
 AB
 AC
 AD
 AE
 AF
 AK
 AL
 AO
 AR
 KA
 KL
 KU
 PA
 PB
 PF
 PI
 PK
 PL
 PM
 PP
 PS
PT
 PU
 PV
 KYE

Wachs-, Porzellan- und Modellierinstrumente
 Wax, porcelain and modelling carvers
 Talladores y espátulas para cera, porcelana y modelar
 Instruments à modeler
 Strumenti per modellare



PT 200/13
 13,0 cm/5"

PT 200/17
 17,0 cm/6³/₄"

1/1

FAHNENSTOCK



1/1

GRITMANN
 PT 205/17
 17,0 cm/6³/₄"



1/1

LICHTENSTEIN
 PT 208/17
 17,0 cm/6³/₄"

Kroneninstrumente
 Instruments for crown work
 Instrumentos para coronas
 Instruments de couronnes
 Strumenti per corone

AA
AB
AC
AD
AE
AF
AK
AL
AO
AR
KA
KL
KU
PA
PB
PF
PI
PK
PL
PM
PP
PS
PT
PU
PV
KYE



MERSHON
 PT 220/00
 14,5 cm/5³/₄"



PT 230/00
 14,0 cm/5¹/₂"



TREYMAN
 PT 240/00
 16,0 cm/6¹/₄"

Kroneninstrumente
 Instruments for crown work
 Instrumentos para coronas
 Instruments de couronnes
 Strumenti per corone



CROWN-REMOVER
 PT 250/00
 15,0 cm/6"



Fig. 1
 PT 250/01

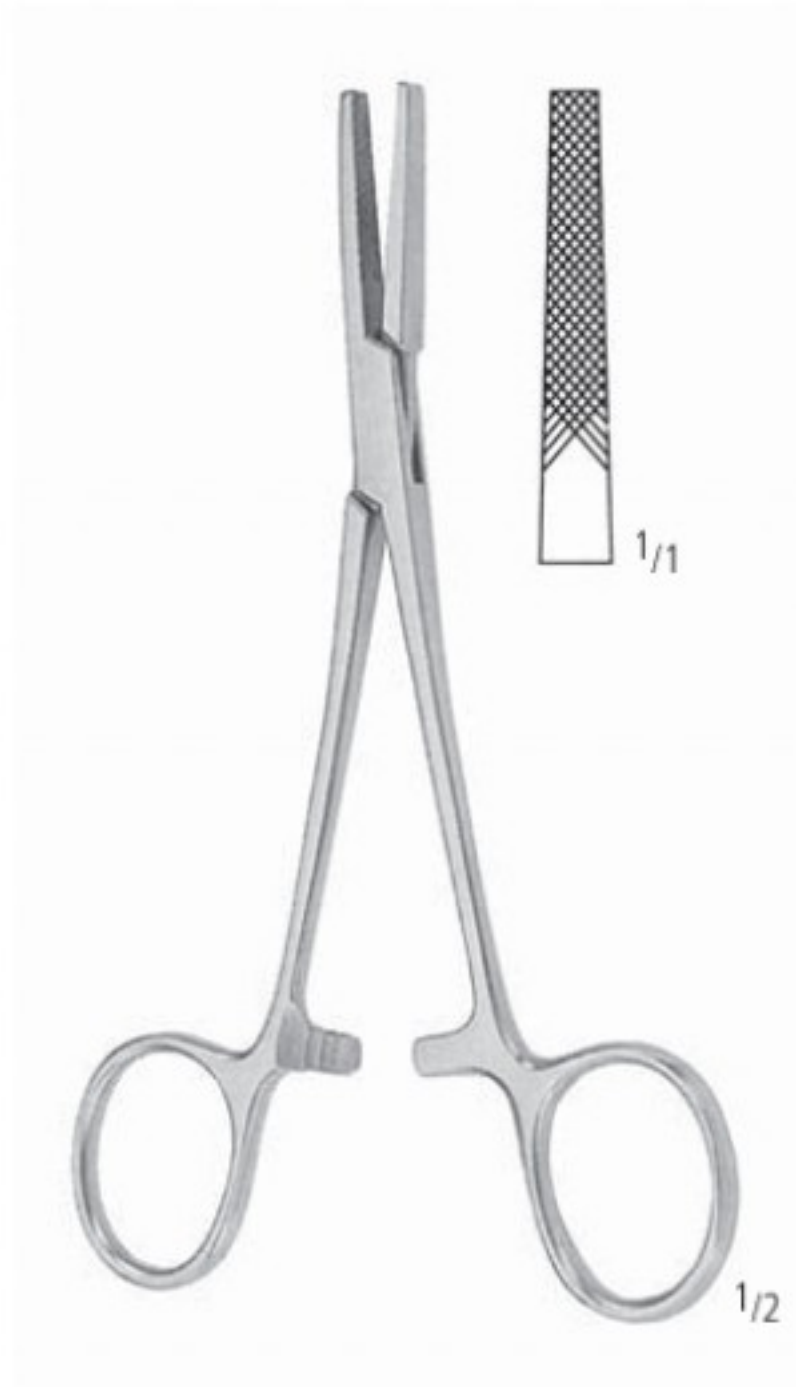

Fig. 2
 PT 250/02



Fig. 3
 PT 250/03

Drahtzangen
Wire Forceps
Pinzas para hilos
Pinces à fil
Tenaglie fili



KA 250/00
15,0 cm/6"



KA 250/14
14,0 cm/5 1/2"

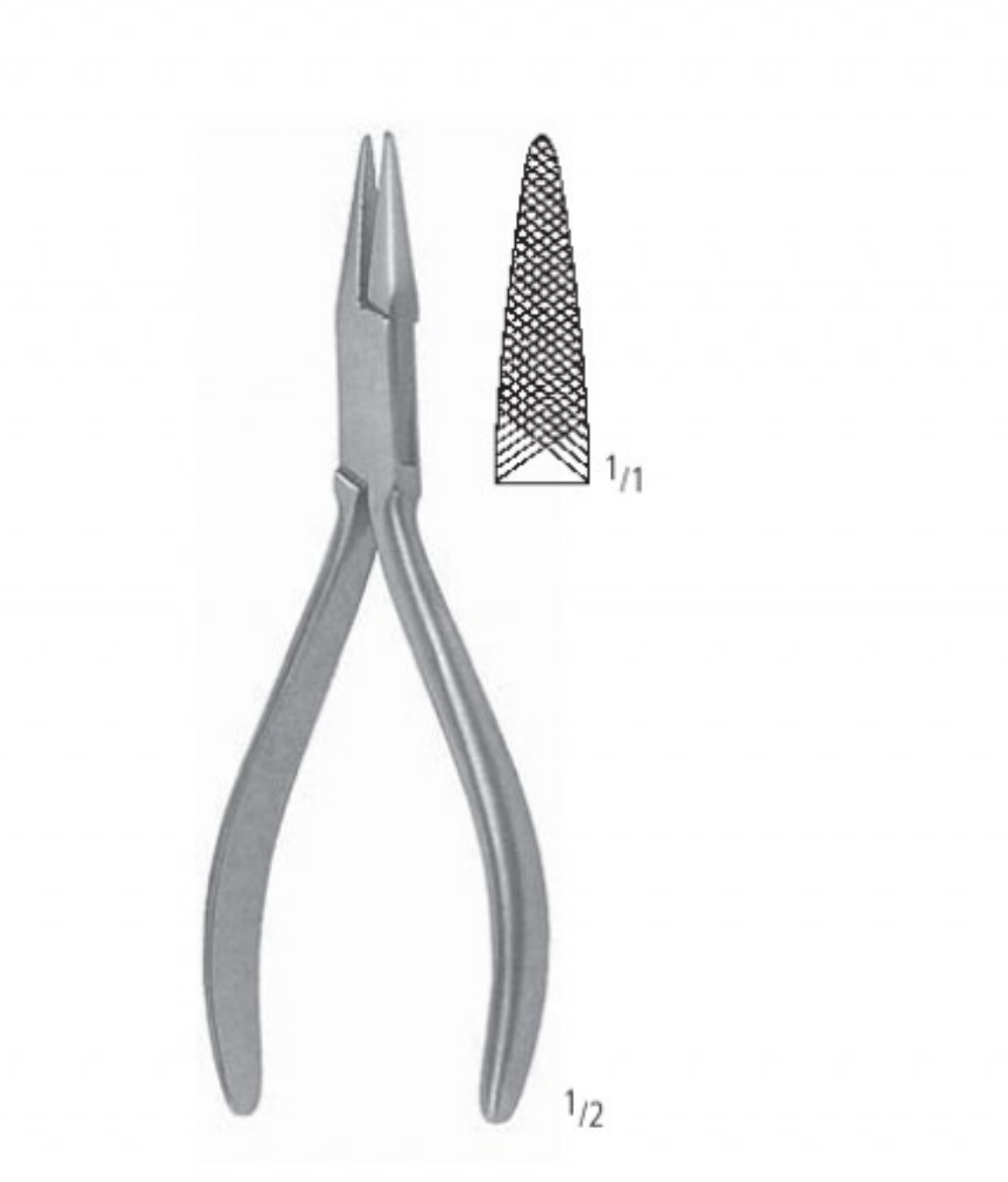

KA 251/14
14,0 cm/5 1/2"



KA 252/16
16,0 cm/6 1/4"

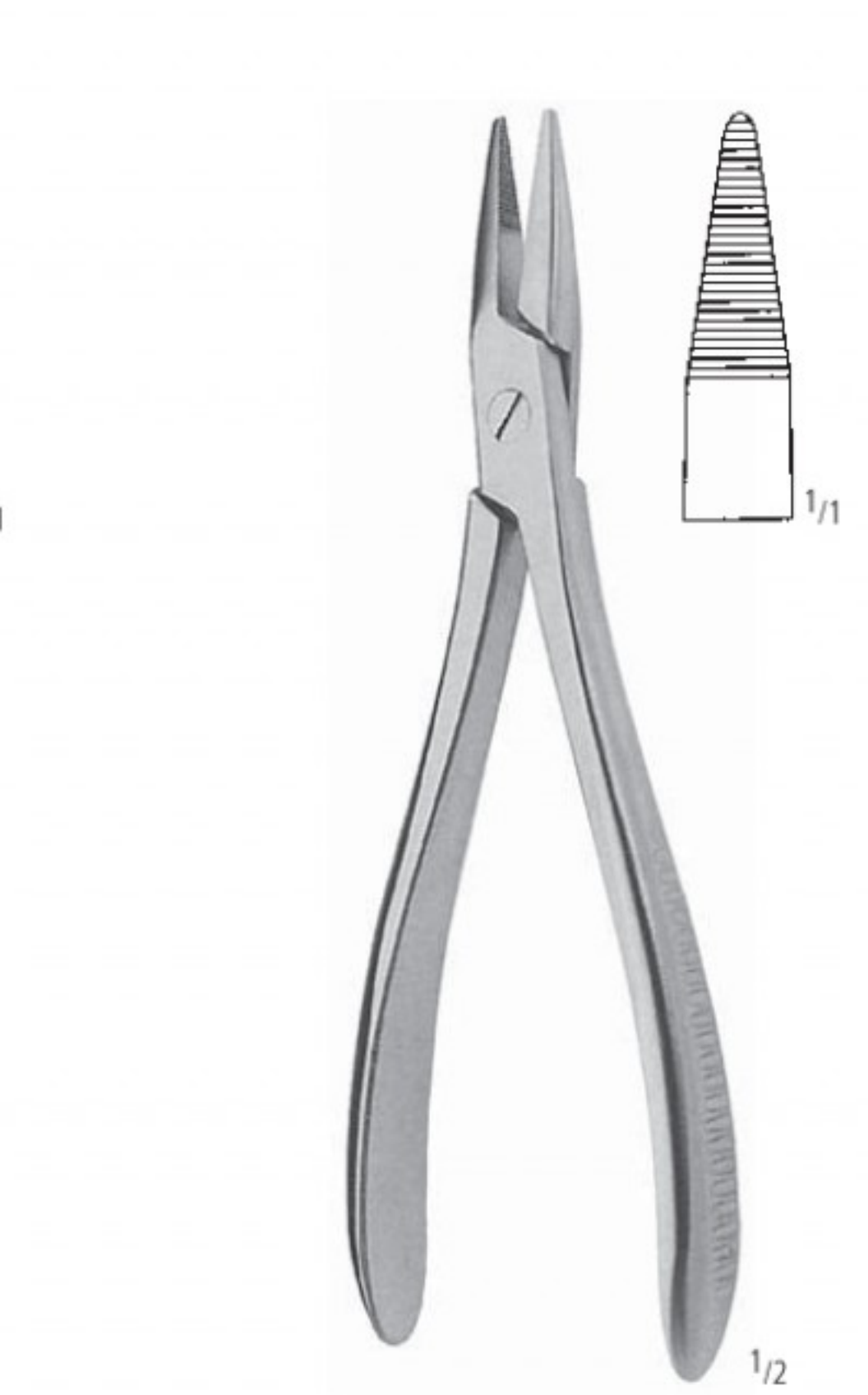

KA 253/19
19,0 cm/7 1/2"

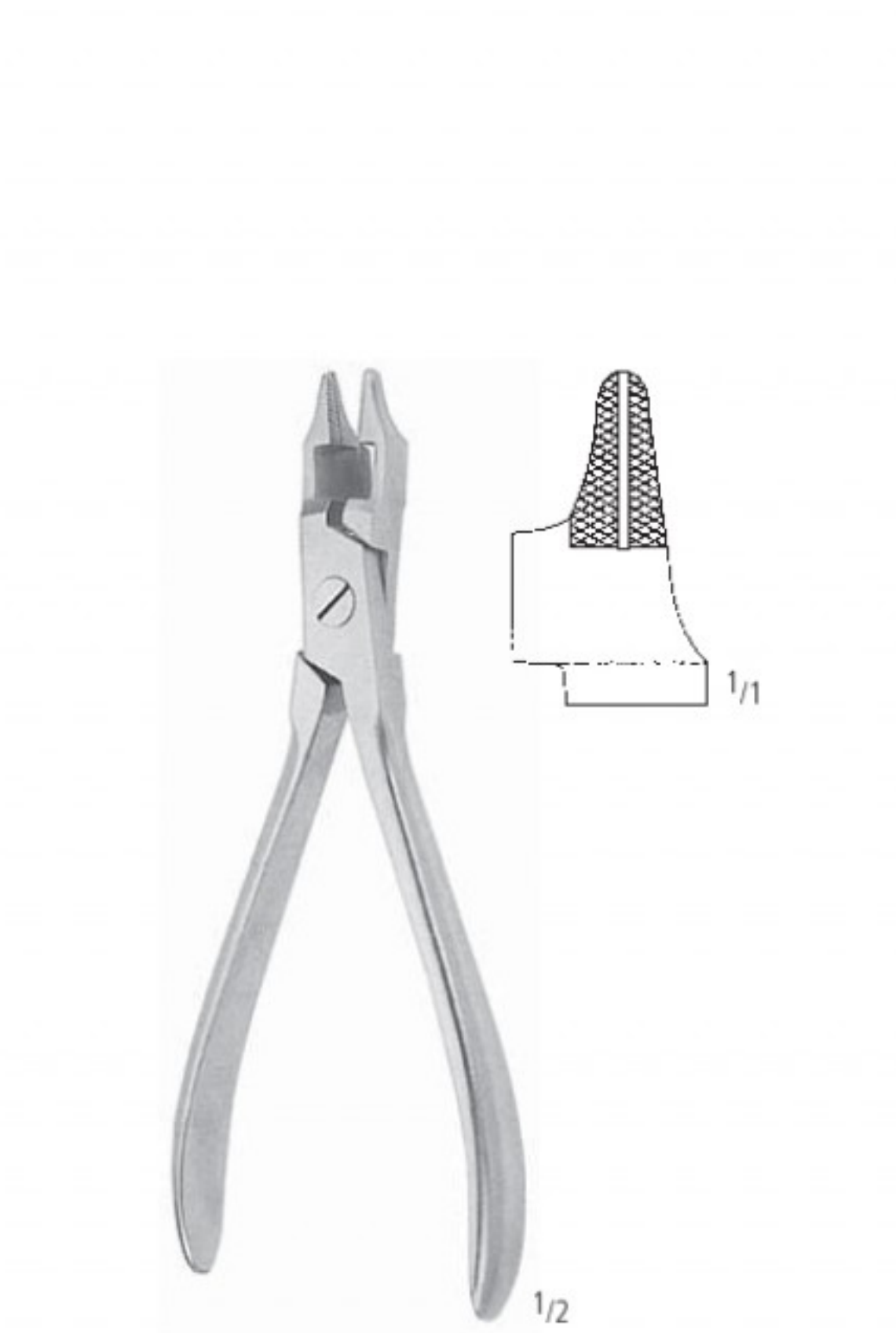

KA 257/15
15,0 cm/6"

AA
AB
AC
AD
AE
AF
AK
AL
AO
AR
KA
KL
KU
PA
PB
PF
PI
PK
PL
PM
PP
PS
PT
PU
PV
KYE

Drahtzangen
Wire Forceps
Pinzas para hilos
Pinces à fil
Tenaglie fili



STERNUM

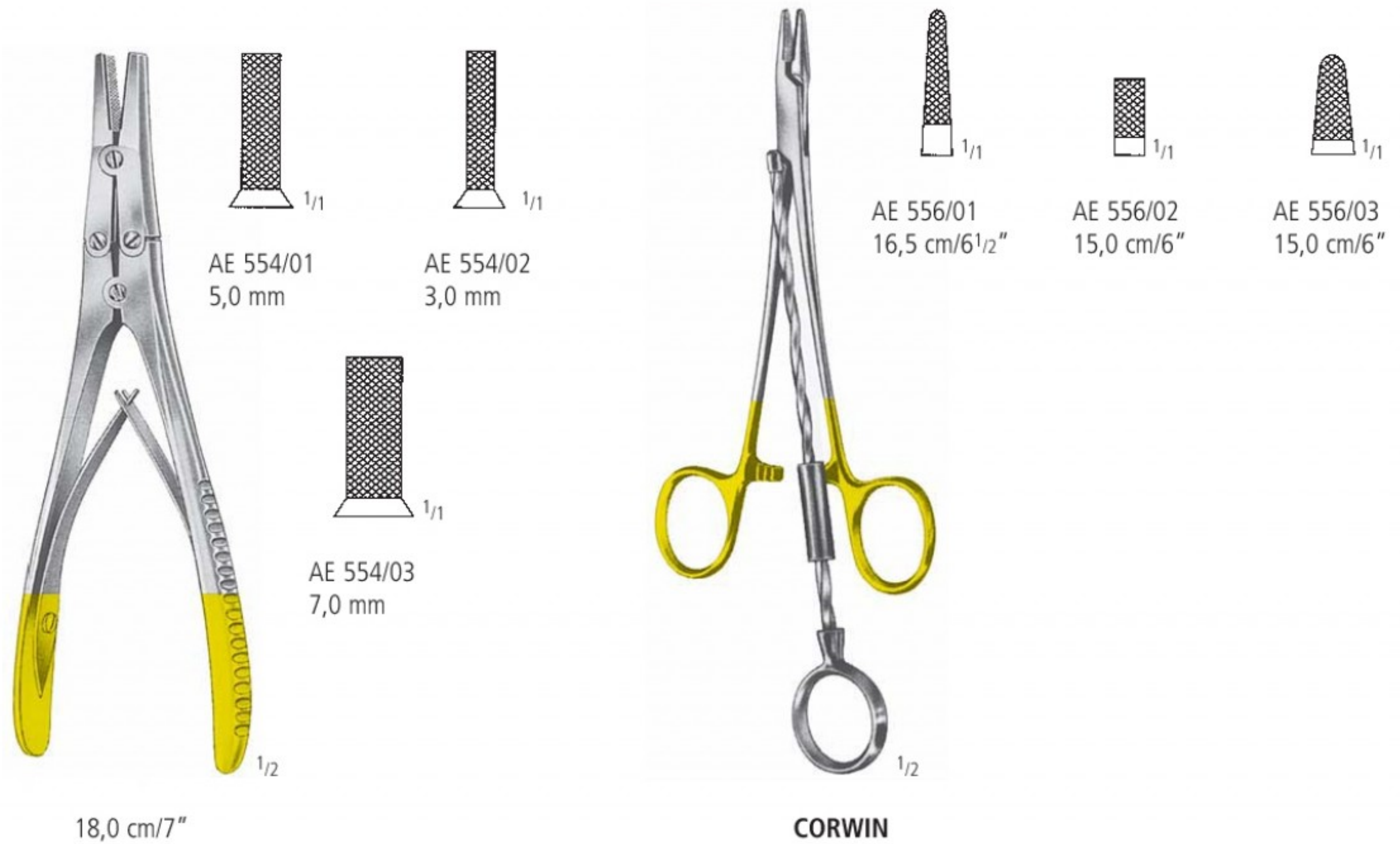

Flachzangen und Drahtzangen
 Flat Nose Pliers and Wire Forceps
 Alicates planos y pinzas para hilos
 Pinces plates et pinces à fil
 Tenaglie piatte e tenaglie fili

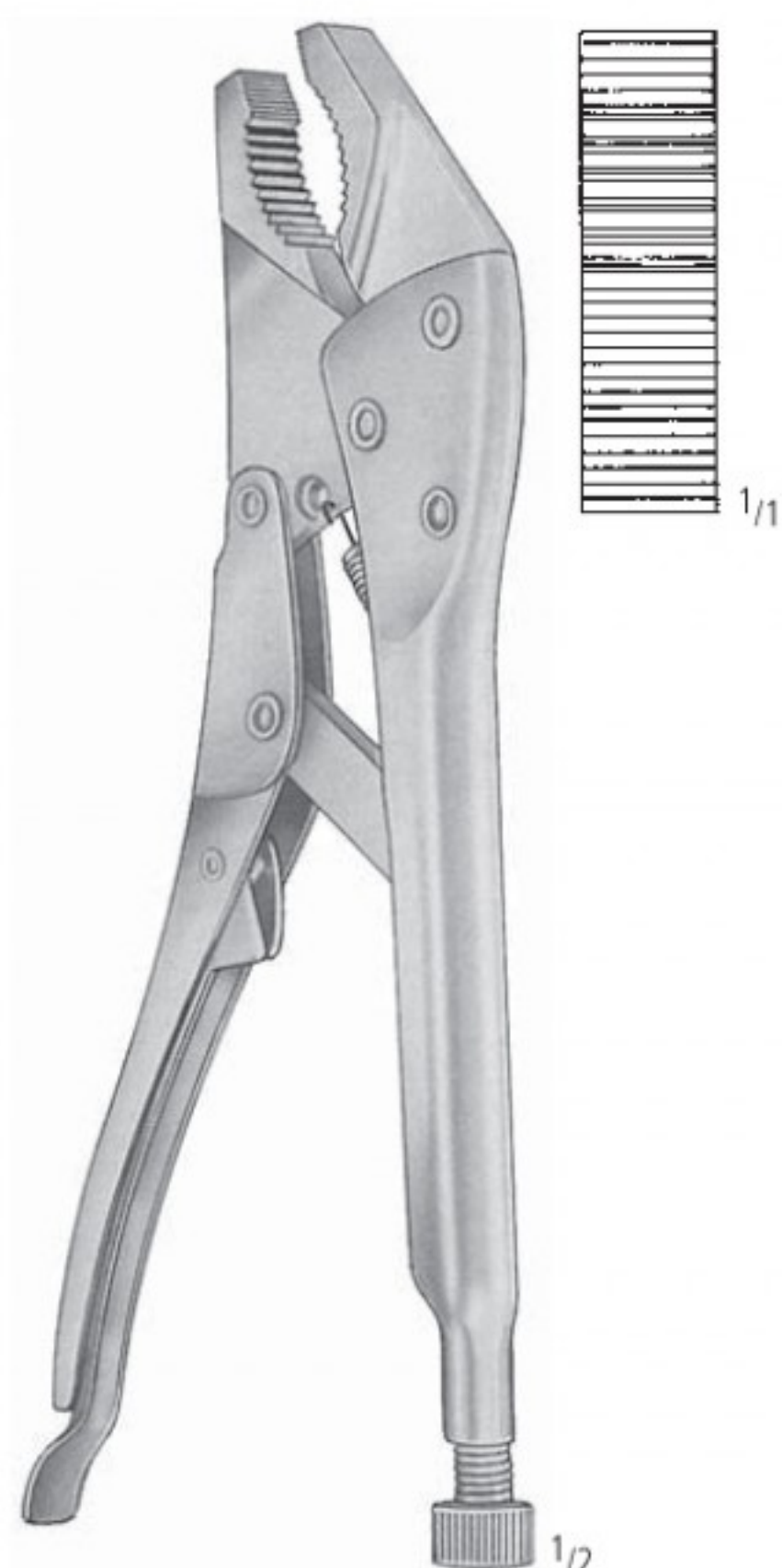

KA 265/18
 18,0 cm/7"

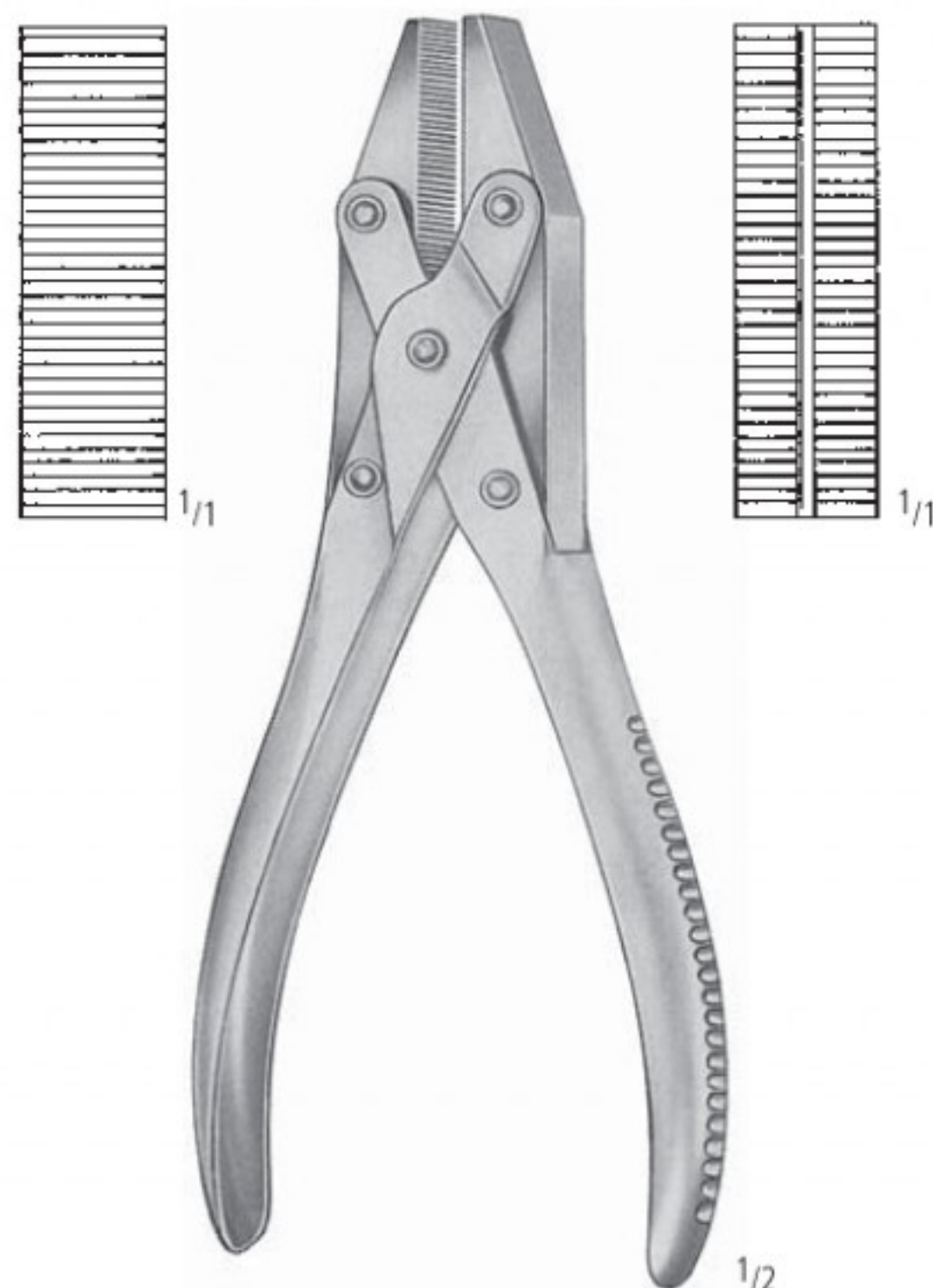

KA 266/17
 17,0 cm/6³/₄"



KA 270/15
 15,0 cm/6"



KA 271/16
 16 cm/6¹/₄"

- >> Draht- und Kronenscheren finden Sie in der Gruppe AC.
- >> For wire cutting and crown scissors, kindly see Instrument group AC.
- >> Para cizallas cortar alambres y tijeras para coronas por favor se encuentra en el grupo de Instrumentos AC.
- >> Pour des cisailles à fils et des ciseaux à couronnes, consultez la section des instruments AC.
- >> Per forbici per filo metallico e per corone consultare il gruppo strumenti AC.

AA
AB
AC
AD
AE
AF
AK
AL
AO
AR
KA
KL
KU
PA
PB
PF
PI
PK
PL
PM
PP
PS
PT
PU
PV
KYE

Drahtzangen
Wire Forceps
Pinzas para hilos
Pinces à fil
Tenaglie fili



für weiche Drähte bis 2,0 mm Ø
for soft wires up to 2,0 mm Ø
para hilos blandos hasta 2,0 mm de Ø
pour fils mous jusqu'à 2,0 mm de Ø
per fili morbidi sino a mm 2,0 di Ø

für harte Drähte bis 1,5 mm Ø
for hard wires up to 1,5 mm Ø
para hilos duros hasta 1,5 mm de Ø
pour fils durs jusqu'à 1,5 mm de Ø
per fili duri sino a mm 1,5 di Ø

KA 272/18
18,0 cm/7"



für weiche Drähte bis 2,0 mm Ø
for soft wires up to 2,0 mm Ø
para hilos blandos hasta 2,0 mm de Ø
pour fils mous jusqu'à 2,0 mm de Ø
per fili morbidi sino a mm 2,0 di Ø

für harte Drähte bis 1,6 mm Ø
for hard wires up to 1,6 mm Ø
para hilos duros hasta 1,6 mm de Ø
pour fils durs jusqu'à 1,6 mm de Ø
per fili duri sino a mm 1,6 di Ø

KA 273/17
17,0 cm/6³/₄"

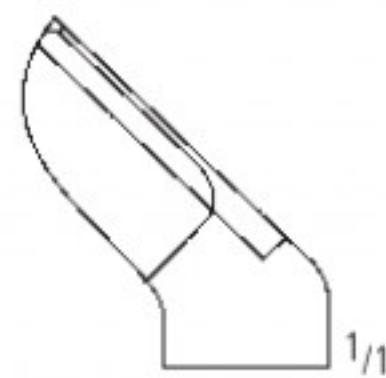

für Drähte bis 2,5 mm Ø
for wires up to 2,5 mm Ø
para hilos hasta 2,5 mm de Ø
pour fils jusqu'à 2,5 mm de Ø
per fili sino a mm 2,5 di Ø

KA 273/22
22,0 cm/8³/₄"

- >> Draht- und Kronenscheren finden Sie in der Gruppe AC.
- >> For wire cutting and crown scissors, kindly see Instrument group AC.
- >> Para cizallas cortar alambres y tijeras para coronas por favor se encuentra en el grupo de Instrumentos AC.
- >> Pour des cisailles à fils y des ciseaux à couronnes, consultez la section des instruments AC.
- >> Per forbici per filo metallico e per corone consultare il gruppo strumenti AC.

Bügelbiegezangen
 Bar Bending Pliers
 Alicates para doblar alambres
 Pincers à courber les branches
 Tenaglie per la piegatura di staffe



SCHWARZ
 13,0 cm/5"

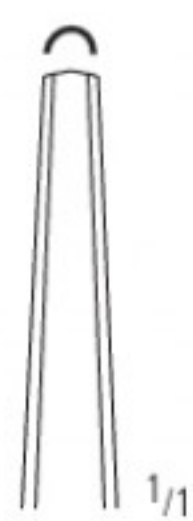

Fig. 1
 PT 300/01



Fig. 2
 PT 300/02

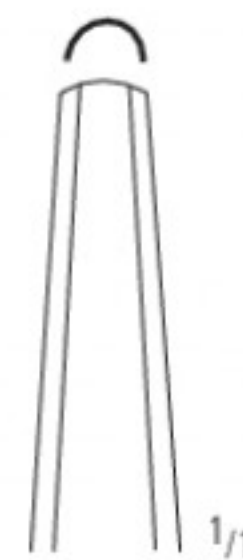

Fig. 3
 PT 300/03

AA
 AB
 AC
 AD
 AE
 AF
 AK
 AL
 AO
 AR
 KA
 KL
 KU
 PA
 PB
 PF
 PI
 PK
 PL
 PM
 PP
 PS
PT
 PU
 PV
 KYE

Zwickzangen, Bügelbiegezangen
 End and side nippers, bar bending pliers
 Alicates cortantes y alicates para doblar alambres
 Pincers, pinces à courber les branches
 Tenaglie, tenaglie per la piegatura di staffe



PT 308/12
 12,5 cm/5"



PT 309/11
 11,0 cm/4¹/₃"

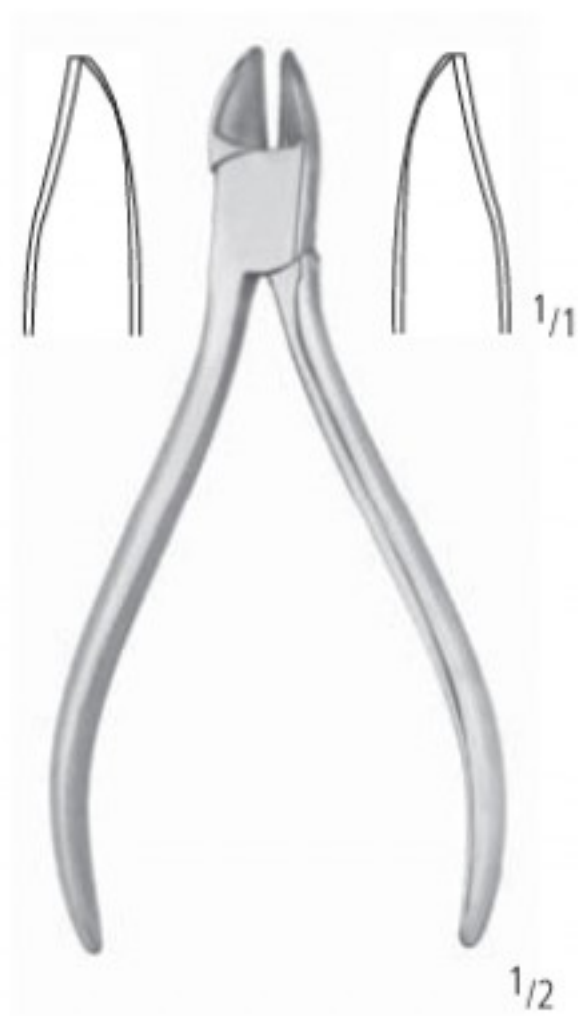

PT 310/11
 11,0 cm/4¹/₃"

PT 310/15
 15,0 cm/6"

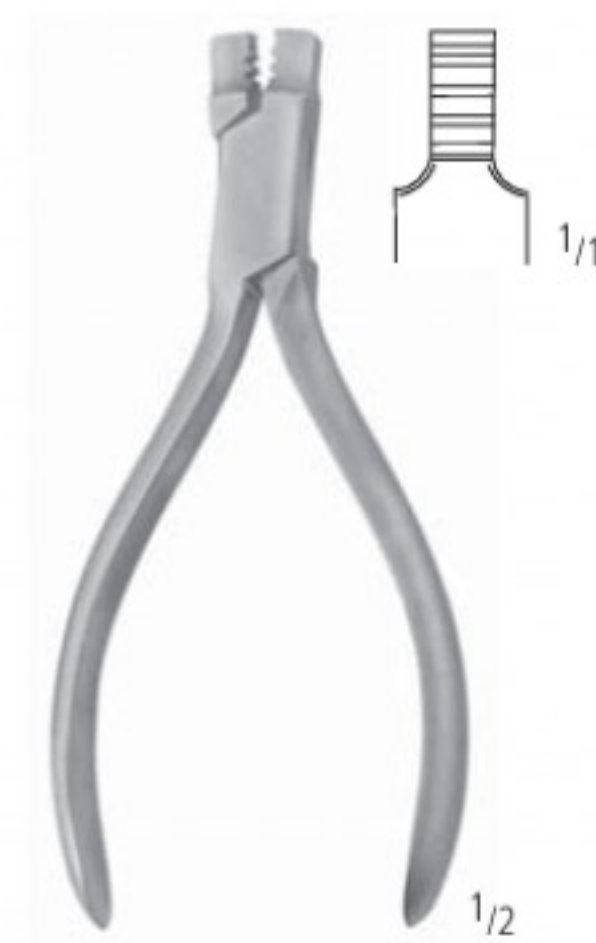

PT 315/00
 11,0 cm/4¹/₃"

Universalzangen
 Universal Pliers
 Alicates universales
 Pincers universelles
 Tenaglie universali



UNIVERSAL
 PT 316/15
 15,0 cm/6"



WALDSACHS
 PT 316/16
 16,0 cm/6 1/4"

AA
 AB
 AC
 AD
 AE
 AF
 AK
 AL
 AO
 AR
 KA
 KL
 KU
 PA
 PB
 PF
 PI
 PK
 PL
 PM
 PP
 PS
PT
 PU
 PV
 KYE

Ligaturzangen
 Ligature Pliers
 Alicates para ligatura
 Pincers à ligature
 Tenaglie per legatura

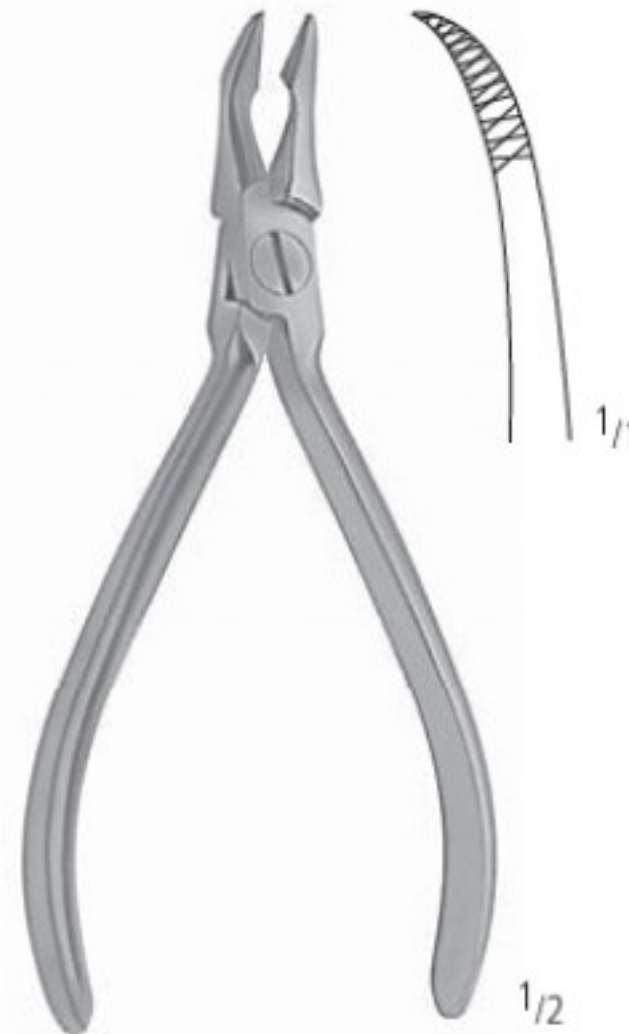

WEINGART
 PT 319/12
 12,5 cm/5"



HOW
 14,0 cm/5¹/₂"



HOW
 PT 320/14
 14,0 cm/5¹/₂"



HOW
 PT 322/14
 14,0 cm/5¹/₂"



HOW
 PT 321/14
 14,0 cm/5¹/₂"



HOW
 PT 323/14
 14,0 cm/5¹/₂"

Distalschneider, Drahtbiegezange
 Distal cutter, wire bending pliers
 Alicates para cortar alambres, alicates para doblar alambres
 Pince coupeur distale, pince pour technique
 Pinza per tagliare filo, pinza tecnica per filo con scanalatura

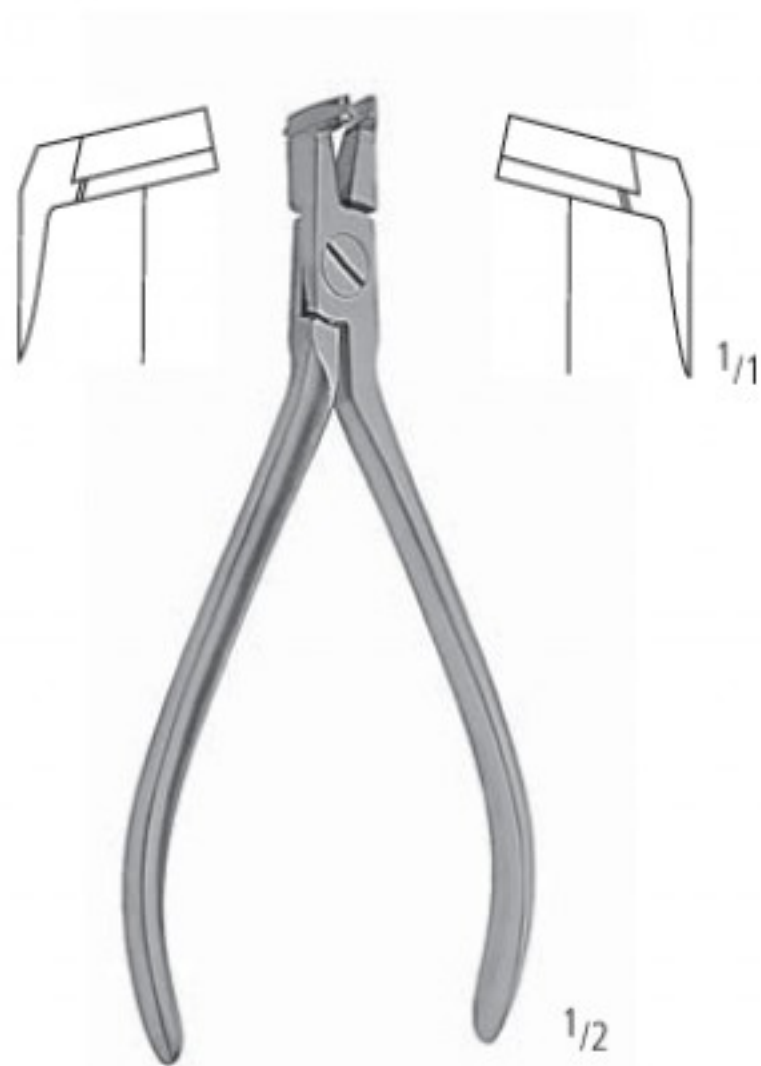

PT 324/12
 12,0 cm/4³/₄"



ANGLE
PT 325/12
 12,0 cm/4³/₄"



ANGLE
PT 326/12
 12,5 cm/5"



ADERER
PT 327/15
 14,5 cm/5³/₄"



ADAMS
PT 328/13
 12,5 cm/5"



NANCE
PT 329/13
 12,5 cm/5"

AA
 AB
 AC
 AD
 AE
 AF
 AK
 AL
 AO
 AR
 KA
 KL
 KU
 PA
 PB
 PF
 PI
 PK
 PL
 PM
 PP
 PS
PT
 PU
 PV
 KYE

Klammerbiegezangen
 Clasp Bending Pliers
 Alicates para doblar ganchos
 Pincers à courber agrafes
 Tenaglie per la piegatura di graffe



ADERER
 PT 330/14
 14,0 cm/5¹/₂"



NANCE
 PT 331/13
 13,0 cm/5"



SCHWARZ
 PT 333/14
 14,0 cm/5¹/₂"

Drahtbiegezaugen
 Wire Bending Pliers
 Alicates para doblar alambres
 Pincers à courber fils
 Tenaglie per la piegatura di fili metallici

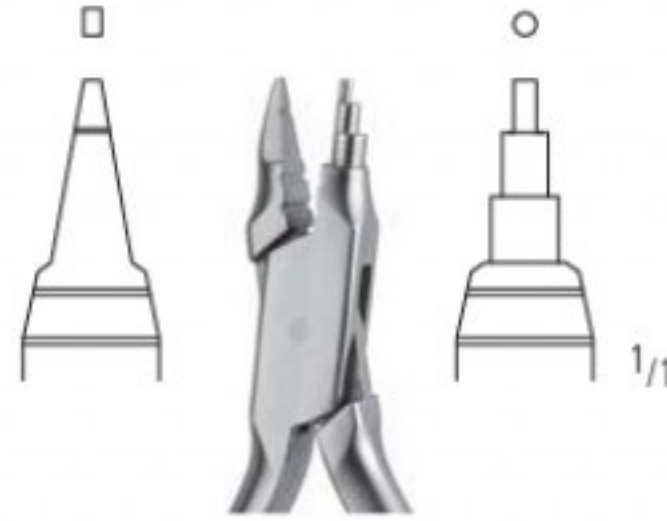

YOUNG
 PT 336/13
 13,0 cm/5"



PT 337/12
 12,0 cm/4³/₄"



SCHWARZ
 PT 340/14
 14,0 cm/5¹/₂"



ADERER
 PT 338/12
 12,0 cm/4³/₄"



ADERER
 PT 339/12
 12,0 cm/4³/₄"

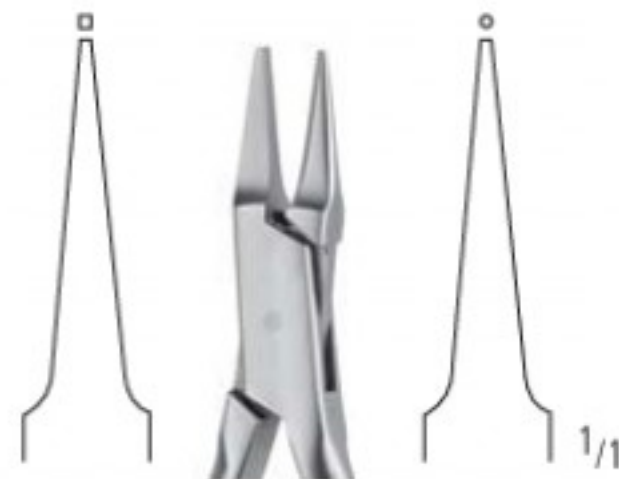

ADERER
 PT 341/13
 13,0 cm/5"

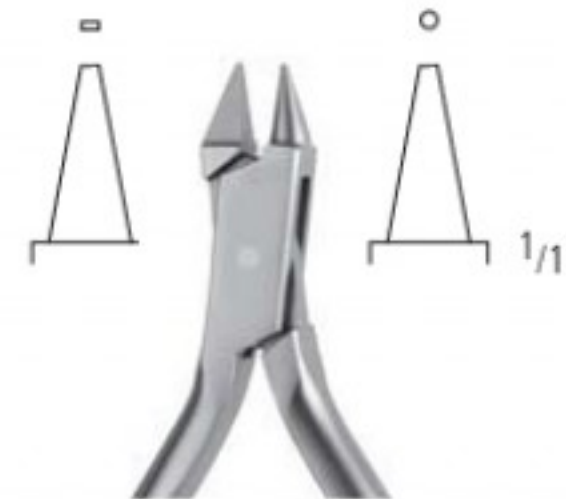

ANGLE
 PT 342/12
 12,0 cm/4³/₄"

AA
AB
AC
AD
AE
AF
AK
AL
AO
AR
KA
KL
KU
PA
PB
PF
PI
PK
PL
PM
PP
PS
PT
PU
PV
KYE

Rund-/Flachzangen
 Flat nose pliers
 Alicates de pico plano
 Pincers plates, rondes
 Tenaglie piatte

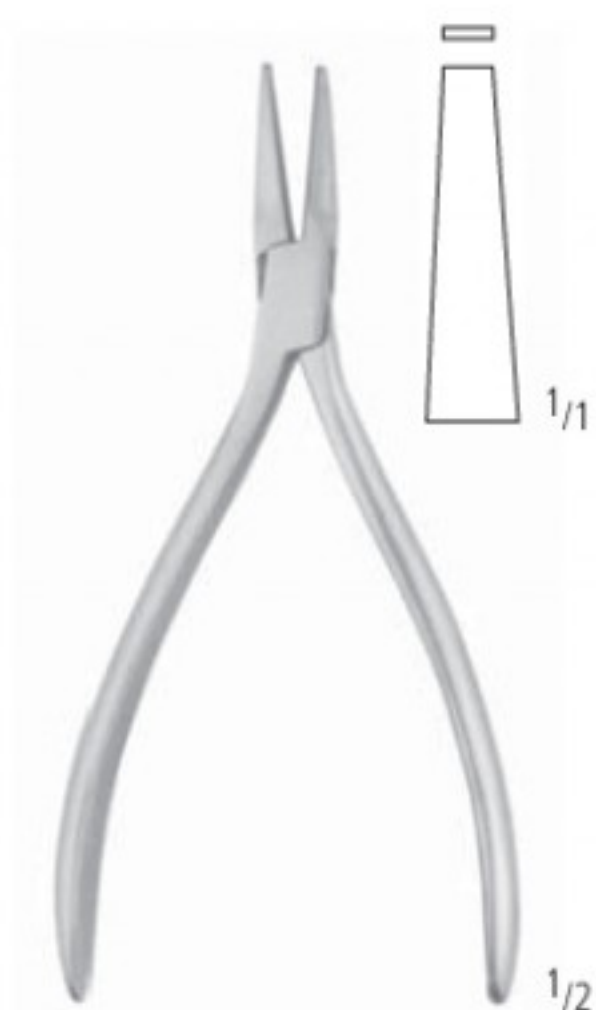

DUMONT
 PT 400/11
 11,5 cm/4¹/₂"

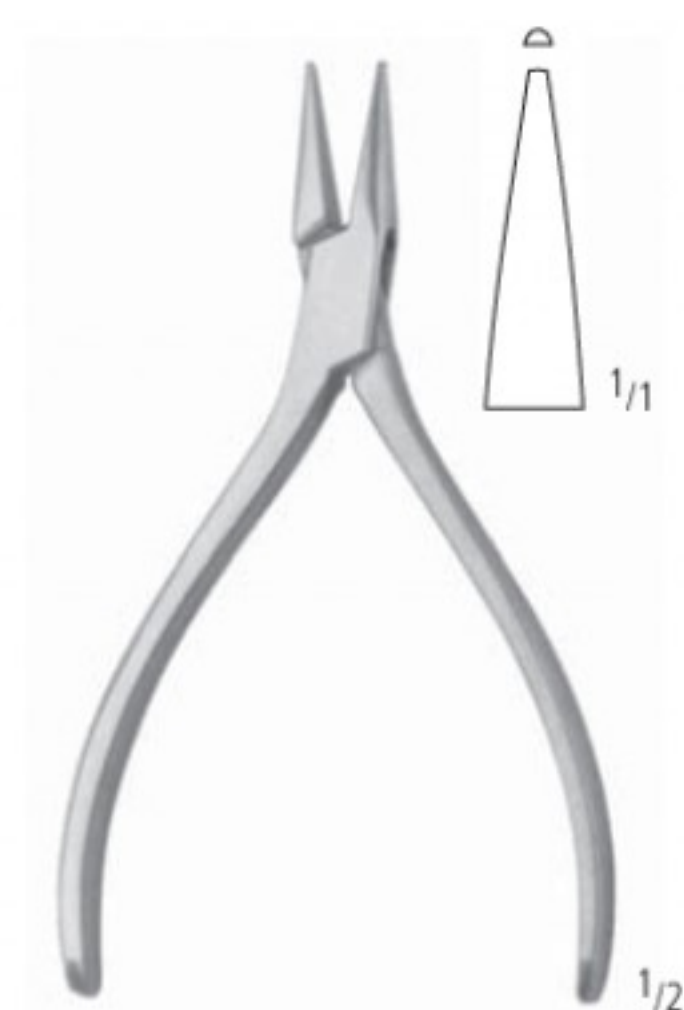

DUMONT
 PT 401/11
 11,5 cm/4¹/₂"

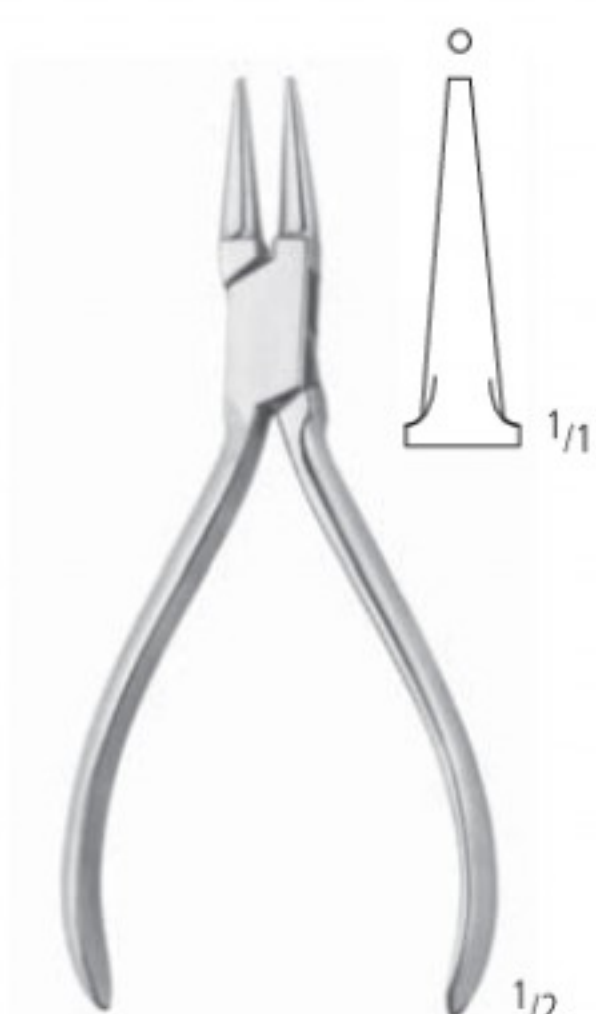

DUMONT
 PT 402/11
 11,5 cm/4¹/₂"



HOLLOW-CHOP
 PT 403/14
 14,0 cm/5¹/₂"

Rund-/Flachzangen
 Flat nose pliers
 Alicates de pico plano
 Pincers plates, rondes
 Tenaglie piatte

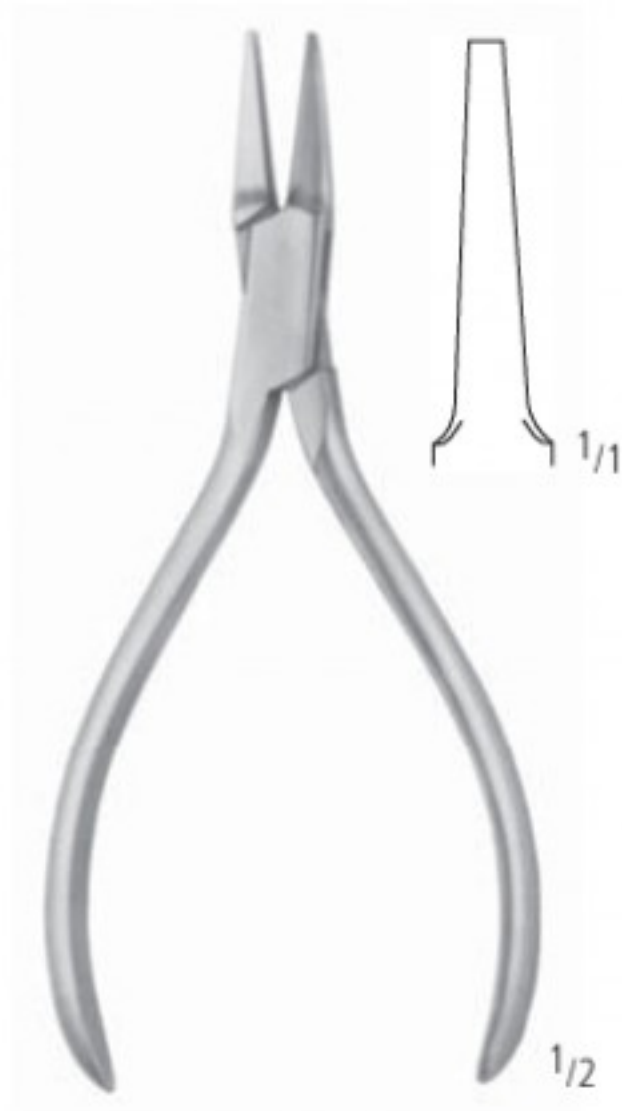

PT 411/13
 13,0 cm/5"

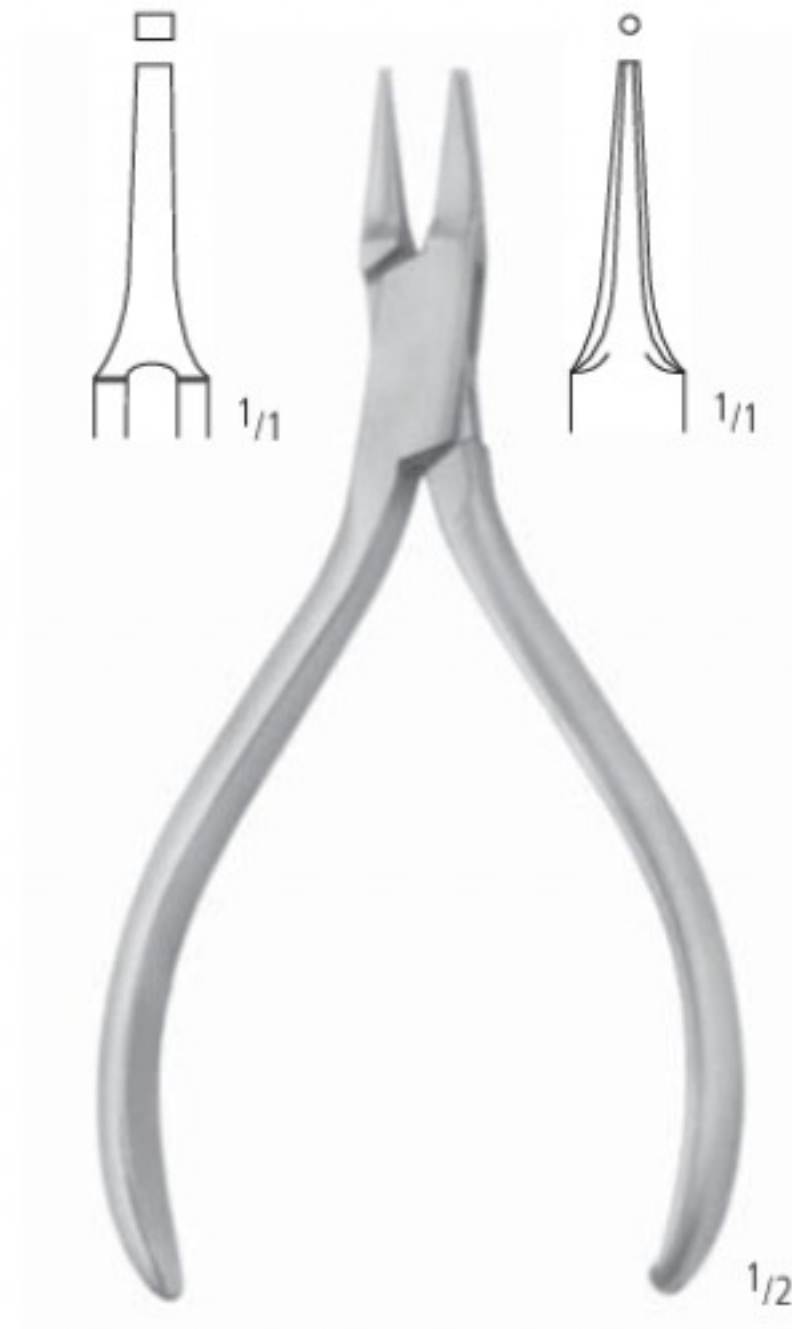

PT 415/15
 15,0 cm/6"

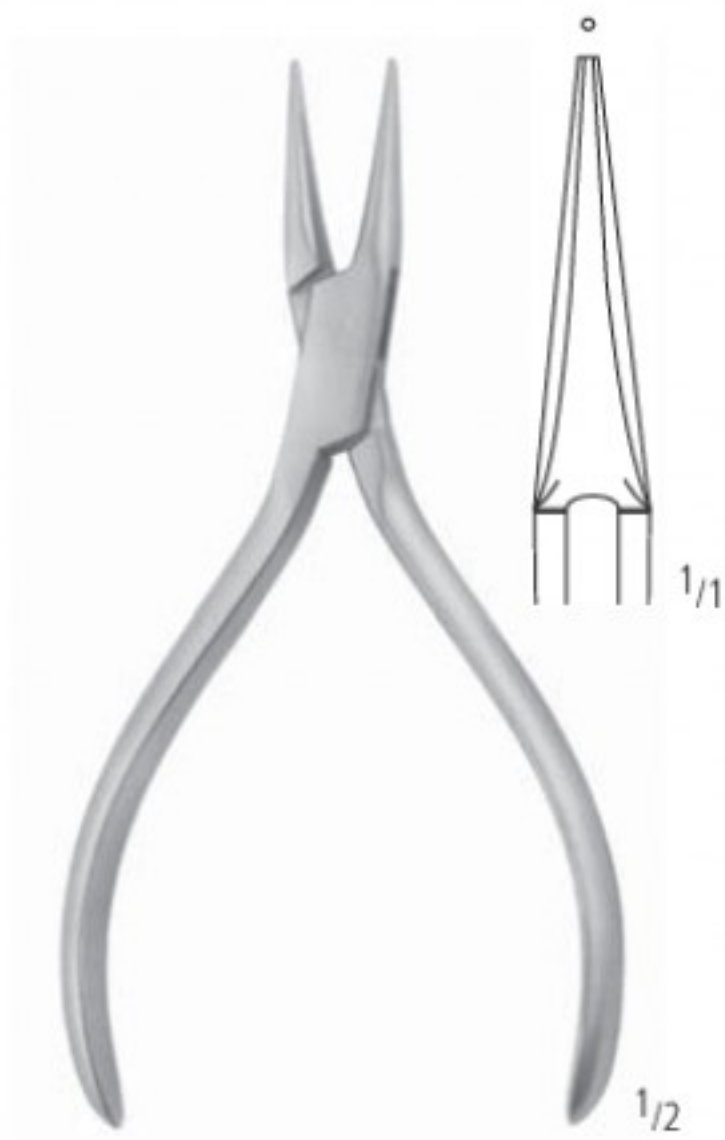

PT 420/13
 13,0 cm/5"

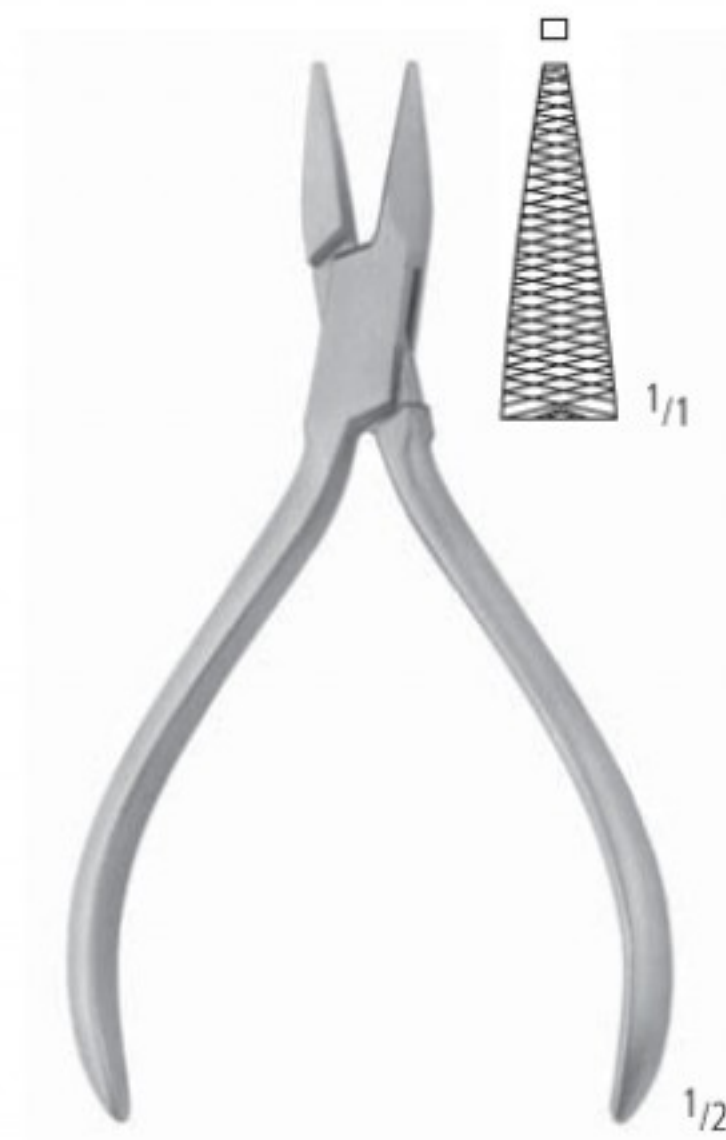

PT 440/13
 13,0 cm/5"

AA
 AB
 AC
 AD
 AE
 AF
 AK
 AL
 AO
 AR
 KA
 KL
 KU
 PA
 PB
 PF
 PI
 PK
 PL
 PM
 PP
 PS
PT
 PU
 PV
 KYE

Rund-/Flachzangen
 Flat nose pliers
 Alicates de pico plano
 Pincers plates, rondes
 Tenaglie piatte



GOSLEE
 PT 441/14
 14,5 cm/5³/₄"

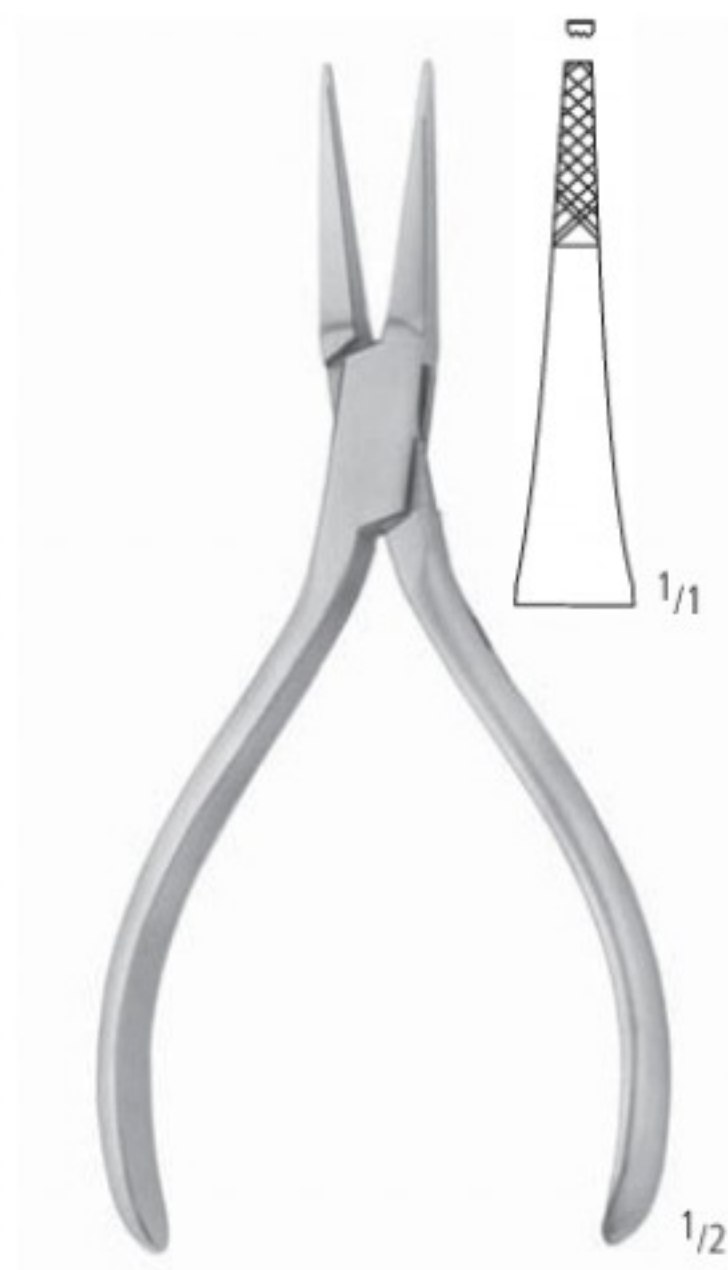

PT 450/14
 14,5 cm/5³/₄"

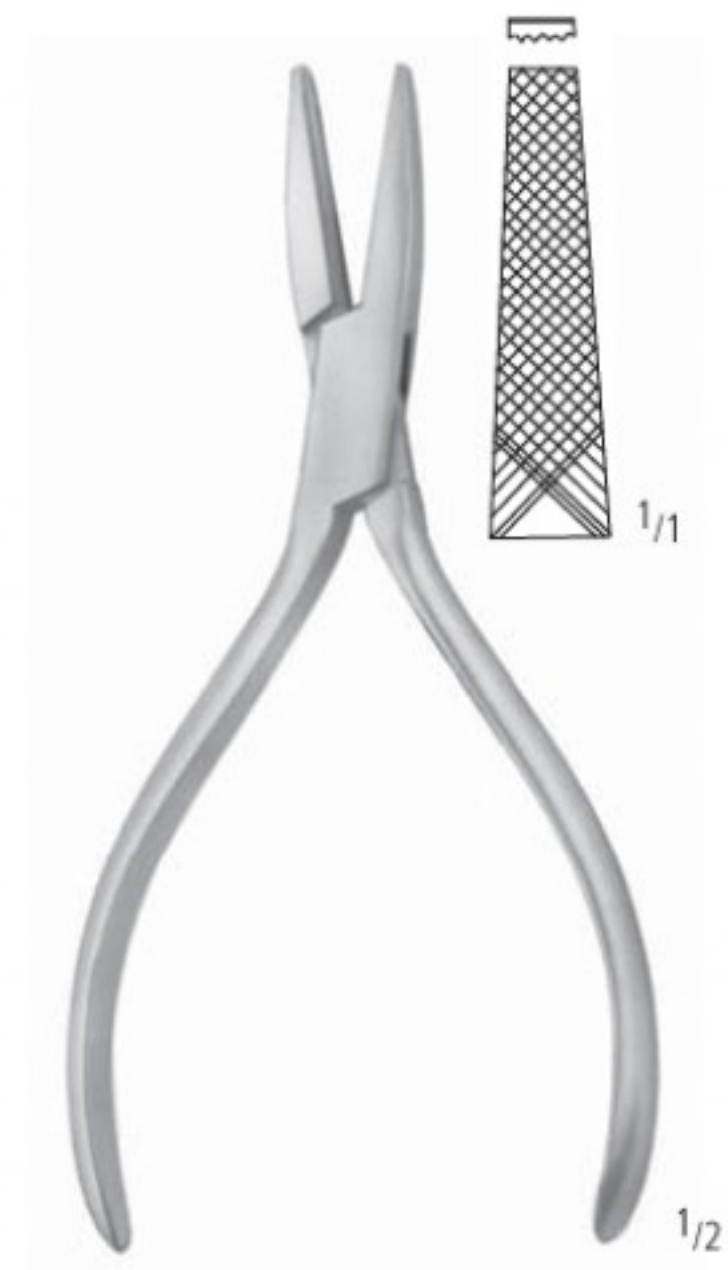

PT 451/14
 14,5 cm/5³/₄"

Teleskopkronenzangen
 Telescopic Crown Pliers
 Alicates para coronas telescópicas
 Pincers pour couronnes télescopes
 Pinza telescopiche per coroni



BÖHM
 PT 461/13
 13,0 cm/5"



PT 462/14
 13,5 cm/5¹/₄"

AA
 AB
 AC
 AD
 AE
 AF
 AK
 AL
 AO
 AR
 KA
 KL
 KU
 PA
 PB
 PF
 PI
 PK
 PL
 PM
 PP
 PS
PT
 PU
 PV
 KYE

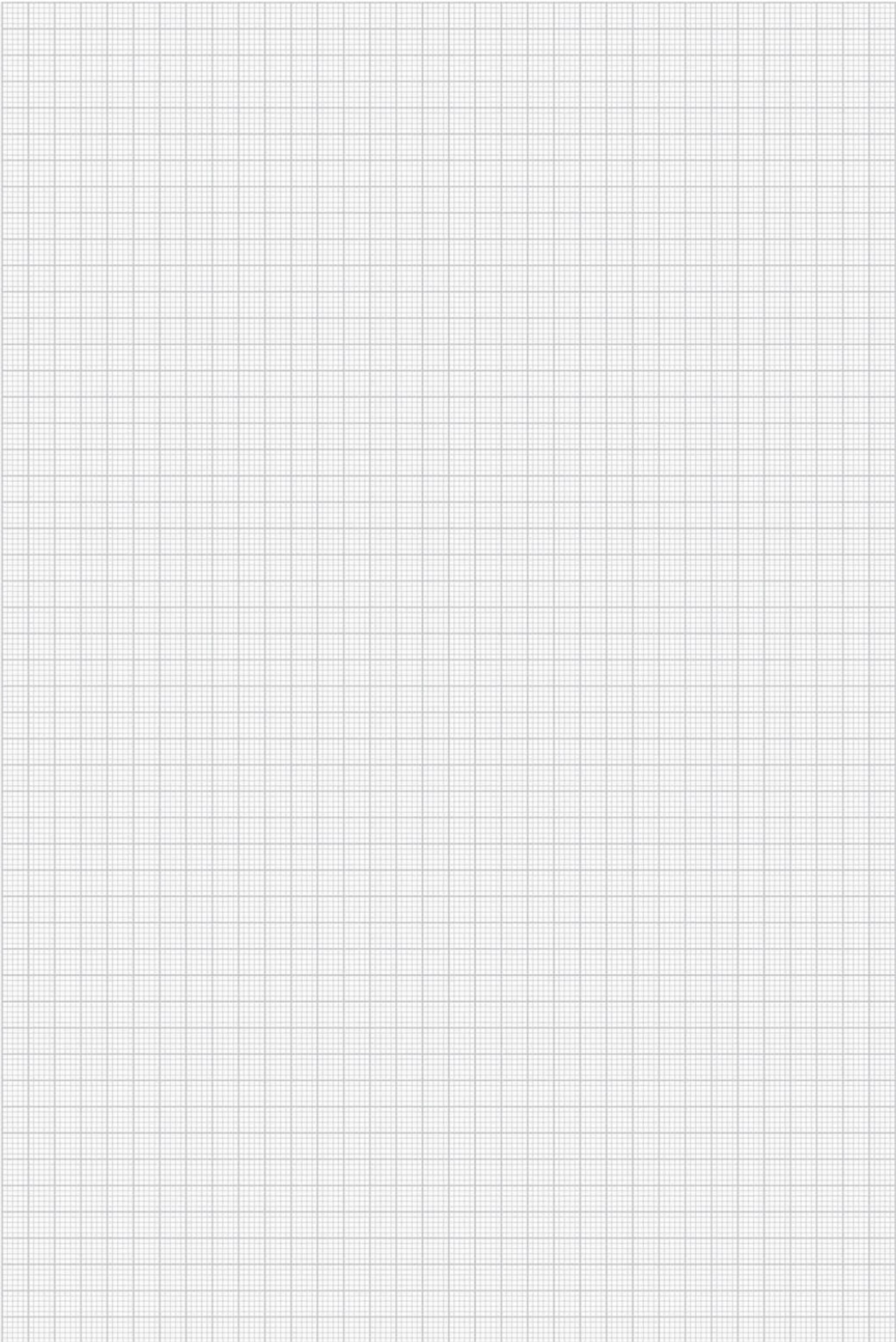

Abdrucklöffel
 Impression Trays
 Cubetas para impresiones
 Porte empreintes
 Portaimpronte



Form BO (SUP/B)
 für bezahnte Oberkiefer, gelocht
 for toothed upper jaws, perforated
 para mandibulas superiores dentadas, perforadas
 pour maxillaires dentés, perforés
 per mascella superiore dentata, perforata

- PT 601/00 Fig. 0
- PT 601/01 Fig. 1
- PT 601/02 Fig. 2
- PT 601/03 Fig. 3
- PT 601/04 Fig. 4

Fig. 0 für Kinder / for children / para niños
 pour enfants / per bambini

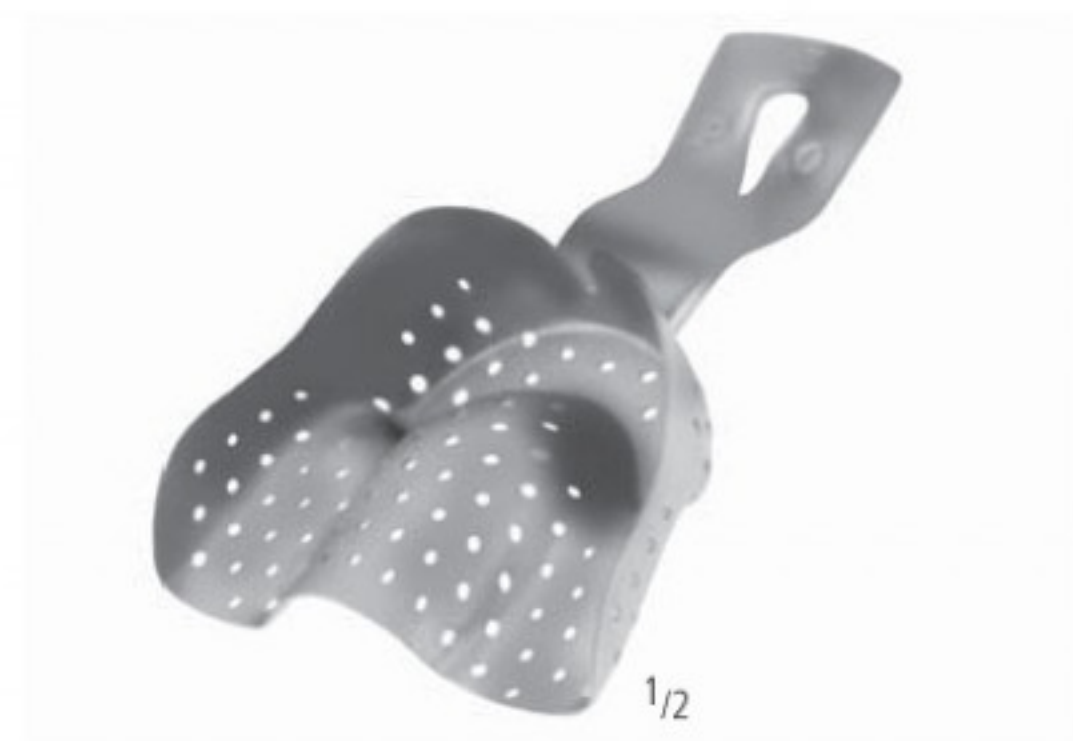

Form PO (SUP/P)
 für partiell bezahnte Oberkiefer, gelocht
 for partially toothed upper jaws, perforated
 para mandibulas superiores parcialmente dentadas, perforadas
 pour maxillaires partiellement dentés, perforés
 per mascella superiore parzialmente dentata, perforata

- PT 602/01 Fig. 1
- PT 602/02 Fig. 2
- PT 602/03 Fig. 3



Form UO (SUP/U)
 für unbezahnte Oberkiefer, gelocht
 for edentulous upper jaws, perforated
 para mandibulas superiores desdentadas, perforadas
 pour maxillaires édentés, perforés
 per mascella superiore edentula, perforata

- PT 603/01 Fig. 1
- PT 603/02 Fig. 2
- PT 603/03 Fig. 3



Form FO (SUP/F)
 für Funktionsabdrücke im Oberkiefer, gelocht
 for upper functional impressions, perforated
 para impresiones funcionales superiores, perforadas
 pour maxillaires, empreintes fonctionelles, perforés
 per impronte funzionali nella mascella superiore dentata, perforata

- PT 604/01 Fig. 1
- PT 604/02 Fig. 2
- PT 604/03 Fig. 3

AA
 AB
 AC
 AD
 AE
 AF
 AK
 AL
 AO
 AR
 KA
 KL
 KU
 PA
 PB
 PF
 PI
 PK
 PL
 PM
 PP
 PS
 PT
 PU
 PV
 KYE

Abdrucklöffel
 Impression Trays
 Cubetas para impresiones
 Porte empreintes
 Portaimpronte



Form BU (INF/B)
 für bezahnte Unterkiefer, gelocht
 for toothed lower jaws, perforated
 para mandibulas inferiores dentadas, perforadas
 pour maxillaires dentés, perforés
 per mascella inferiore dentata, perforata

Form PU (INF/P)
 für partiell bezahnte Unterkiefer, gelocht
 for partially toothed lower jaws, perforated
 para mandibulas inferiores parcialmente dentadas, perforadas
 pour maxillaires partiellement dentés, perforés
 per mascella inferiore parzialmente dentata, perforata

- PT 610/00 Fig. 0
- PT 610/01 Fig. 1
- PT 610/02 Fig. 2
- PT 610/03 Fig. 3
- PT 610/04 Fig. 4

- PT 611/01 Fig. 1
- PT 611/02 Fig. 2
- PT 611/03 Fig. 3

Fig. 0 für Kinder / for children / para niños
 pour enfants / per bambini



Form UU (INF/U)
 für unbezahnte Unterkiefer, gelocht
 for edentulous lower jaws, perforated
 para mandibulas inferiores desdentadas, perforadas
 pour mandibules édentés, perforés
 per mascella inferiore edentula, perforata

- PT 612/01 Fig. 1
- PT 612/02 Fig. 2
- PT 612/03 Fig. 3

Abdrucklöffel
 Impression Trays
 Cubetas para impresiones
 Porte empreintes
 Portaimpronte



Form BO (SUP/B)
 für bezahnte Oberkiefer, ungelocht
 for toothed upper jaws, non perforated
 para mandibulas superiores dentadas, no perforadas
 pour maxillaires dentés, non perforés
 per mascella superiore dentata, non perforata

- PT 621/00 Fig. 0
- PT 621/01 Fig. 1
- PT 621/02 Fig. 2
- PT 621/03 Fig. 3
- PT 621/04 Fig. 4

Fig. 0 für Kinder / for children / para niños
 pour enfants / per bambini



Form UO (SUP/U)
 für unbezahnte Oberkiefer, ungelocht
 for edentulous upper jaws, non perforated
 para mandibulas superiores desdentadas, no perforadas
 pour maxillaires édentés, non perforés
 per mascella superiore edentula, non perforata

- PT 623/01 Fig. 1
- PT 623/02 Fig. 2
- PT 623/03 Fig. 3



Form PO (SUP/P)
 für partiell bezahnte Oberkiefer, ungelocht
 for partially toothed upper jaws, non perforated
 para mandibulas superiores parcialmente dentadas, no perforadas
 pour maxillaires partiellement dentés, non perforés
 per mascella superiore parzialmente dentata, non perforata

- PT 622/01 Fig. 1
- PT 622/02 Fig. 2
- PT 622/03 Fig. 3



Form FO (SUP/F)
 für Funktionsabdrücke im Oberkiefer, ungelocht
 for upper functional impressions, non perforated
 para impresiones funcionales superiores, no perforadas
 pour maxillaires, empreintes fonctionelles, non perforés
 per impronte funzionali nella mascella superiore dentata, non perforata

- PT 624/01 Fig. 1
- PT 624/02 Fig. 2
- PT 624/03 Fig. 3

AA
 AB
 AC
 AD
 AE
 AF
 AG
 AH
 AI
 AJ
 AK
 AL
 AO
 AP
 AQ
 AR
 AS
 AT
 AU
 AV
 AW
 AX
 AY
 AZ
 BA
 BB
 BC
 BD
 BE
 BF
 BG
 BH
 BI
 BJ
 BK
 BL
 BM
 BN
 BO
 BP
 BQ
 BR
 BS
 BT
 BU
 BV
 BW
 BX
 BY
 BZ
 CA
 CB
 CC
 CD
 CE
 CF
 CG
 CH
 CI
 CJ
 CK
 CL
 CM
 CN
 CO
 CP
 CQ
 CR
 CS
 CT
 CU
 CV
 CW
 CX
 CY
 CZ
 DA
 DB
 DC
 DD
 DE
 DF
 DG
 DH
 DI
 DJ
 DK
 DL
 DM
 DN
 DO
 DP
 DQ
 DR
 DS
 DT
 DU
 DV
 DW
 DX
 DY
 DZ
 EA
 EB
 EC
 ED
 EE
 EF
 EG
 EH
 EI
 EJ
 EK
 EL
 EM
 EN
 EO
 EP
 EQ
 ER
 ES
 ET
 EU
 EV
 EW
 EX
 EY
 EZ
 FA
 FB
 FC
 FD
 FE
 FF
 FG
 FH
 FI
 FJ
 FK
 FL
 FM
 FN
 FO
 FP
 FQ
 FR
 FS
 FT
 FU
 FV
 FW
 FX
 FY
 FZ
 GA
 GB
 GC
 GD
 GE
 GF
 GG
 GH
 GI
 GJ
 GK
 GL
 GM
 GN
 GO
 GP
 GQ
 GR
 GS
 GT
 GU
 GV
 GW
 GX
 GY
 GZ
 HA
 HB
 HC
 HD
 HE
 HF
 HG
 HH
 HI
 HJ
 HK
 HL
 HM
 HN
 HO
 HP
 HQ
 HR
 HS
 HT
 HU
 HV
 HW
 HX
 HY
 HZ
 IA
 IB
 IC
 ID
 IE
 IF
 IG
 IH
 II
 IJ
 IK
 IL
 IM
 IN
 IO
 IP
 IQ
 IR
 IS
 IT
 IU
 IV
 IW
 IX
 IY
 IZ
 JA
 JB
 JC
 JD
 JE
 JF
 JG
 JH
 JI
 JJ
 JK
 JL
 JM
 JN
 JO
 JP
 JQ
 JR
 JS
 JT
 JU
 JV
 JW
 JX
 JY
 JZ
 KA
 KB
 KC
 KD
 KE
 KF
 KG
 KH
 KI
 KJ
 KK
 KL
 KM
 KN
 KO
 KP
 KQ
 KR
 KS
 KT
 KU
 KV
 KW
 KX
 KY
 KZ
 LA
 LB
 LC
 LD
 LE
 LF
 LG
 LH
 LI
 LJ
 LK
 LL
 LM
 LN
 LO
 LP
 LQ
 LR
 LS
 LT
 LU
 LV
 LW
 LX
 LY
 LZ
 MA
 MB
 MC
 MD
 ME
 MF
 MG
 MH
 MI
 MJ
 MK
 ML
 MM
 MN
 MO
 MP
 MQ
 MR
 MS
 MT
 MU
 MV
 MW
 MX
 MY
 MZ
 NA
 NB
 NC
 ND
 NE
 NF
 NG
 NH
 NI
 NJ
 NK
 NL
 NM
 NN
 NO
 NP
 NQ
 NR
 NS
 NT
 NU
 NV
 NW
 NX
 NY
 NZ
 OA
 OB
 OC
 OD
 OE
 OF
 OG
 OH
 OI
 OJ
 OK
 OL
 OM
 ON
 OO
 OP
 OQ
 OR
 OS
 OT
 OU
 OV
 OW
 OX
 OY
 OZ
 PA
 PB
 PC
 PD
 PE
 PF
 PG
 PH
 PI
 PJ
 PK
 PL
 PM
 PN
 PO
 PP
 PQ
 PR
 PS
 PT
 PU
 PV
 PW
 PX
 PY
 PZ
 QA
 QB
 QC
 QD
 QE
 QF
 QG
 QH
 QI
 QJ
 QK
 QL
 QM
 QN
 QO
 QP
 QQ
 QR
 QS
 QT
 QU
 QV
 QW
 QX
 QY
 QZ
 RA
 RB
 RC
 RD
 RE
 RF
 RG
 RH
 RI
 RJ
 RK
 RL
 RM
 RN
 RO
 RP
 RQ
 RR
 RS
 RT
 RU
 RV
 RW
 RX
 RY
 RZ
 SA
 SB
 SC
 SD
 SE
 SF
 SG
 SH
 SI
 SJ
 SK
 SL
 SM
 SN
 SO
 SP
 SQ
 SR
 SS
 ST
 SU
 SV
 SW
 SX
 SY
 SZ
 TA
 TB
 TC
 TD
 TE
 TF
 TG
 TH
 TI
 TJ
 TK
 TL
 TM
 TN
 TO
 TP
 TQ
 TR
 TS
 TT
 TU
 TV
 TW
 TX
 TY
 TZ
 UA
 UB
 UC
 UD
 UE
 UF
 UG
 UH
 UI
 UJ
 UK
 UL
 UM
 UN
 UO
 UP
 UQ
 UR
 US
 UT
 UU
 UV
 UW
 UX
 UY
 UZ
 VA
 VB
 VC
 VD
 VE
 VF
 VG
 VH
 VI
 VJ
 VK
 VL
 VM
 VN
 VO
 VP
 VQ
 VR
 VS
 VT
 VU
 VV
 VW
 VX
 VY
 VZ
 WA
 WB
 WC
 WD
 WE
 WF
 WG
 WH
 WI
 WJ
 WK
 WL
 WM
 WN
 WO
 WP
 WQ
 WR
 WS
 WT
 WU
 WV
 WW
 WX
 WY
 WZ
 XA
 XB
 XC
 XD
 XE
 XF
 XG
 XH
 XI
 XJ
 XK
 XL
 XM
 XN
 XO
 XP
 XQ
 XR
 XS
 XT
 XU
 XV
 XW
 XX
 XY
 XZ
 YA
 YB
 YC
 YD
 YE
 YF
 YG
 YH
 YI
 YJ
 YK
 YL
 YM
 YN
 YO
 YP
 YQ
 YR
 YS
 YT
 YU
 YV
 YW
 YX
 YZ
 ZA
 ZB
 ZC
 ZD
 ZE
 ZF
 ZG
 ZH
 ZI
 ZJ
 ZK
 ZL
 ZM
 ZN
 ZO
 ZP
 ZQ
 ZR
 ZS
 ZT
 ZU
 ZV
 ZW
 ZX
 ZY
 ZZ

Abdrucklöffel
 Impression Trays
 Cubetas para impresiones
 Porte empreintes
 Portaimpronte



Form BU (INF/B)
 für bezahnte Unterkiefer, ungelocht
 for toothed lower jaws, non perforated
 para mandibulas inferiores dentadas, no perforadas
 pour maxillaires dentés, non perforés
 per mascella inferiore dentata, non perforata

- PT 630/00 Fig. 0
- PT 630/01 Fig. 1
- PT 630/02 Fig. 2
- PT 630/03 Fig. 3
- PT 630/04 Fig. 4

Fig. 0 für Kinder / for children / para niños
 pour enfants / per bambini



Form PU (INF/P)
 für partiell bezahnte Unterkiefer, ungelocht
 for partially toothed lower jaws, non perforated
 para mandibulas inferiores parcialmente dentadas, no perforadas
 pour maxillaires partiellement dentés, non perforés
 per mascella inferiore parzialmente dentata, non perforata

- PT 631/01 Fig. 1
- PT 631/02 Fig. 2
- PT 631/03 Fig. 3



Form UU (INF/U)
 für unbezahnte Unterkiefer, ungelocht
 for edentulous lower jaws, non perforated
 para mandibulas inferiores desdentadas, no perforadas
 pour maxillaires édentés, non perforés
 per mascella inferiore edentula, non perforata

- PT 632/01 Fig. 1
- PT 632/02 Fig. 2
- PT 632/03 Fig. 3

Abdrucklöffel für partielle Abdrücke
 Impression trays for partial impressions
 Cubetas para impresiones parciales
 Porte empreintes partiels
 Portaimpronte parziali



Form C1/2L
 gelocht
 perforated
 perforada
 perforé
 perforato

PT 650/01 Fig. 1
 PT 650/02 Fig. 2
 PT 650/03 Fig. 3



Form C1/2R
 gelocht
 perforated
 perforada
 perforé
 perforato

PT 651/01 Fig. 1
 PT 651/02 Fig. 2
 PT 651/03 Fig. 3



PT 655/01

gelocht
 perforated
 perforada
 perforé
 perforato



PT 655/02

mit drehbarem Griff
 with swivel handle
 con mango giratorio
 avec poignée pivotante
 con impugnatura girevole
 gelocht
 perforated
 perforada
 perforé
 perforato

AA
 AB
 AC
 AD
 AE
 AF
 AK
 AL
 AO
 AR
 KA
 KL
 KU
 PA
 PB
 PF
 PI
 PK
 PL
 PM
 PP
 PS
 PT
 PU
 PV
 KYE

Abdrucklöffel für partielle Abdrücke
 Impression trays for partial impressions
 Cubetas para impresiones parciales
 Porte empreintes partiels
 Portaimpronte parziali



Form C1/2L
 ungelocht
 unperforated
 no perforada
 non perforé
 non perforato

Form C1/2R
 ungelocht
 unperforated
 no perforada
 non perforé
 non perforato

PT 660/01 Fig. 1
 PT 660/02 Fig. 2
 PT 660/03 Fig. 3

PT 661/01 Fig. 1
 PT 661/02 Fig. 2
 PT 661/03 Fig. 3



PT 665/01

PT 665/02

ungelocht
 unperforated
 no perforada
 non perforé
 non perforato

mit drehbarem Griff
 with swivel handle
 con mango giratorio
 avec poignée pivotante
 con impugnatura girevole
 ungelocht
 unperforated
 no perforada
 non perforé
 non perforato

MATRIZEN
MATRIX
MATRICES
MATRICES
MATRICI

PU

nopa[®] instruments



MATRIZEN MATRIX MATRICES MATRICES MATRICI

Matrizen und Matrizenspanner
 Matrix bands and retainers
 Portamatrices y matrices
 Porte matrices et matrices
 Portamatrici e matrici



IVORY
 PU 020/01
 Fig. 1



IVORY
 PU 020/12
 Fig. 12



IVORY
 PU 021/12
 Fig. 12A

12 Stück
 12 pieces
 12 piezas
 12 pièces
 12 pezzi



Fig. 1
 PU 022/01



Fig. 2
 PU 022/02



Fig. 3
 PU 022/03

12 Stück
 12 pieces
 12 piezas
 12 pièces
 12 pezzi



Fig. 4
 PU 022/04



Fig. 5
 PU 022/05



Fig. 6
 PU 022/06

AA
 AB
 AC
 AD
 AE
 AF
 AK
 AL
 AO
 AR
 KA
 KL
 KU
 PA
 PB
 PF
 PI
 PK
 PL
 PM
 PP
 PS
 PT
 PU
 PV
 KYE

Matrizen und Matrizenspanner
 Matrix bands and retainers
 Portamatrices y matrices
 Porte matrices et matrices
 Portamatrici e matrici



IVORY
 PU 040/05
 Fig. 8
 5 mm



IVORY
 PU 040/06
 Fig. 8
 6 mm



Fig. 7
 PU 041/07



Fig. 8
 PU 041/08



Fig. 9
 PU 041/09



Fig. 10
 PU 041/10



Fig. 11
 PU 041/11



Fig. 12
 PU 041/12



Fig. 13
 PU 041/13

MATRIZEN MATRIX MATRICES MATRICES MATRICI

Matrizen und Matrizenhalter
 Matrix bands and retainers
 Portamatrices y matrices
 Porte matrices et matrices
 Portamatrici e matrici

AA
AB
AC
AD
AE
AF
AK
AL
AO
AR
KA
KL
KU
PA
PB
PF
PI
PK
PL
PM
PP
PS
PT
PU
PV
KYE



PU 042/05 5 mm x 1 m
 PU 042/06 6 mm x 1 m
 PU 042/07 7 mm x 1 m



TOFFLEMIRE-UNIVERSAL
 PU 050/00

12 Stück
 12 pieces
 12 piezas
 12 pièces
 12 pezzi



TOFFLEMIRE
 PU 051/01
 Fig. 1



TOFFLEMIRE
 PU 051/13
 Fig. 13

PU MATRIZEN MATRIX MATRICES MATRICES MATRICI

Kofferdam-Lochzange, Kofferdam-Klammerzange
 Punch forceps, clamp forceps
 Perforadores, portaclamps
 Pincès à perforer, pincès porte crampons
 Pinze foradiga, pinze per uncini



AINSWORTH
 PU 080/16
 16,0 cm/6¹/₄"



USA
 PU 081/15
 15,0 cm/6"



STOCKES
 PU 082/17
 17,0 cm/6³/₄"



IVORY
 PU 083/16
 16,0 cm/6¹/₄"



BREWER
 PU 084/17
 17,0 cm/6³/₄"

IMPLANTOLOGIE
IMPLANTOLOGY
IMPLANTOLOGIA
IMPLANTOLOGIE
IMPLANTOLOGIA

PV

nopa[®] instruments



Applikationspritzen
 Application syringes
 Jeringas de aplicación
 Seringue d'application
 Siringa di applicazione

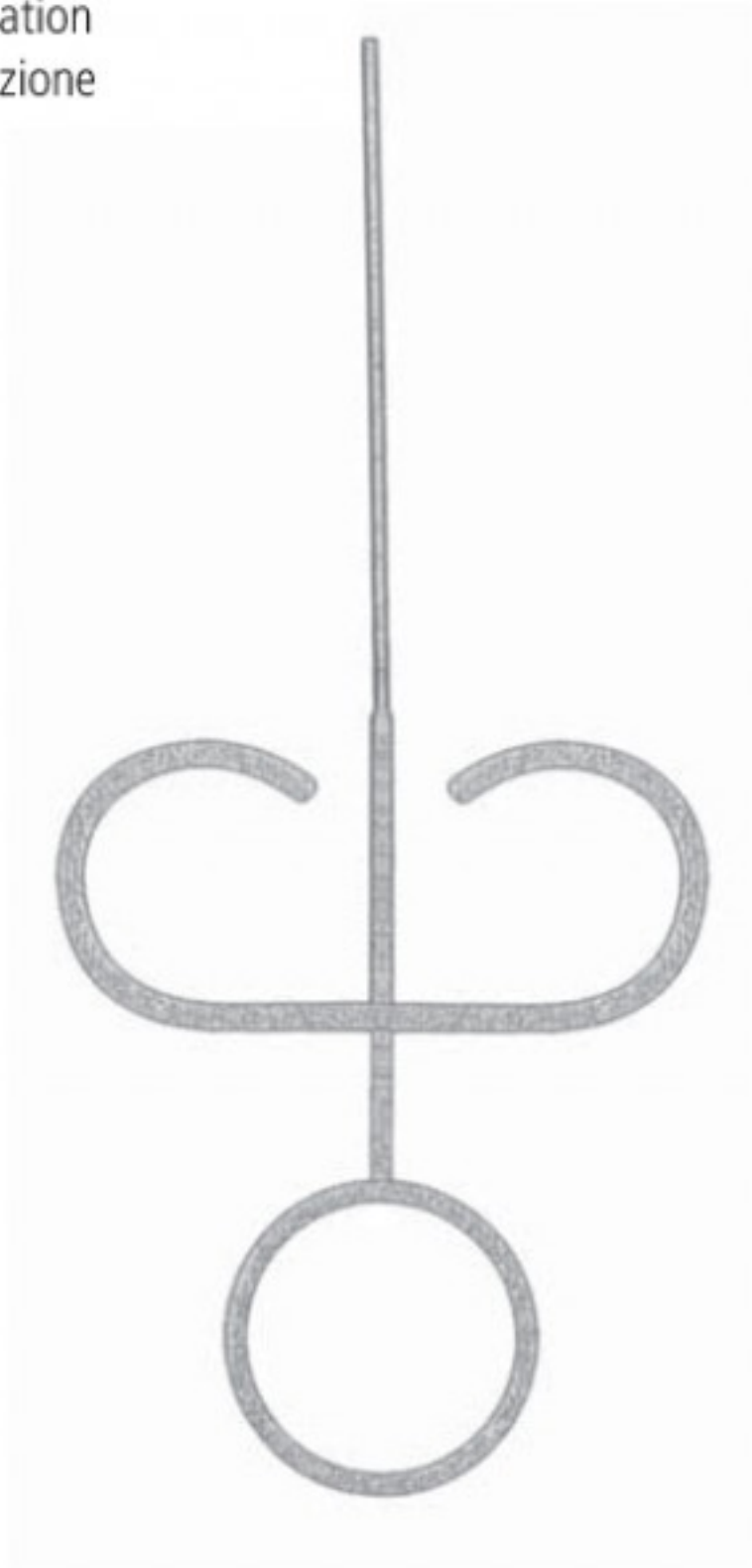

PV 010/12
 1,2 mm

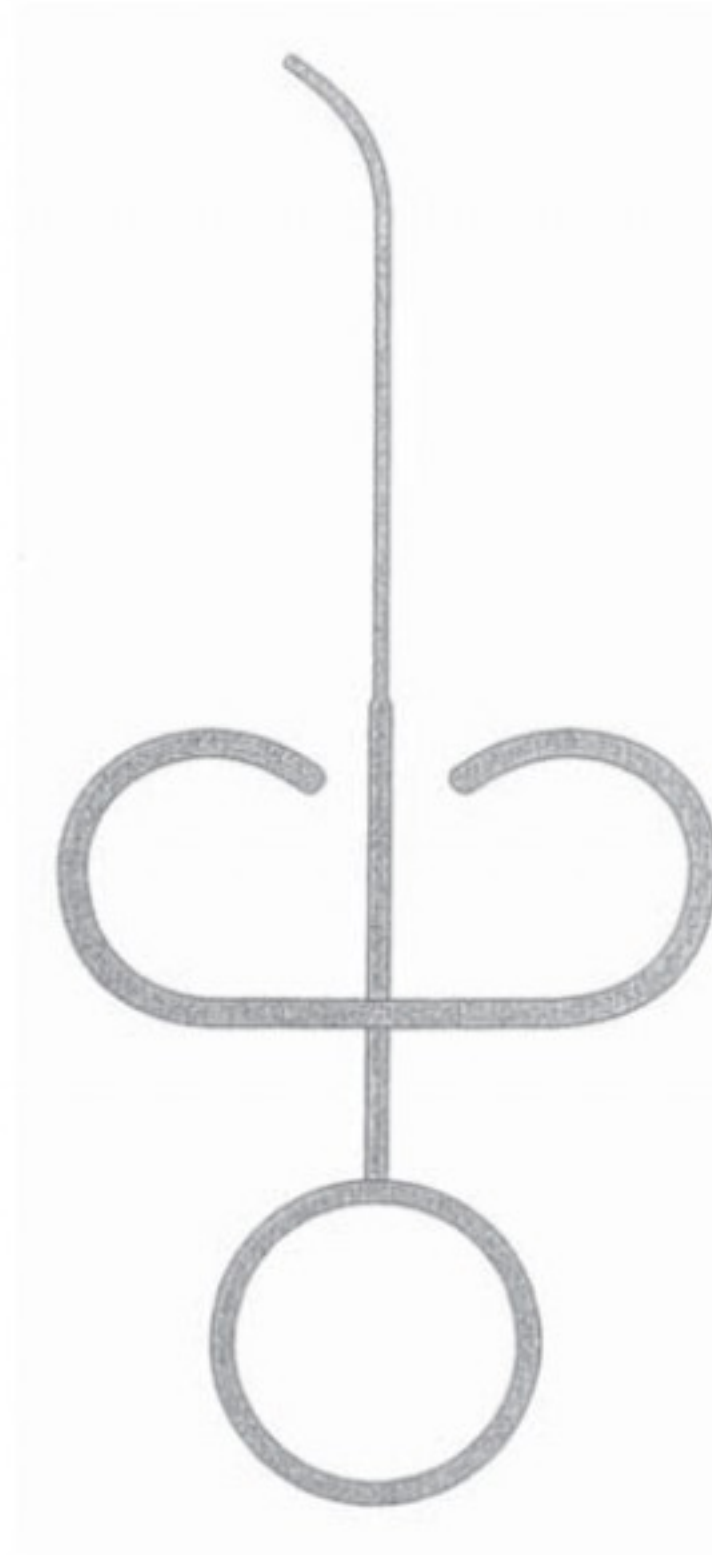

PV 011/12
 1,2 mm

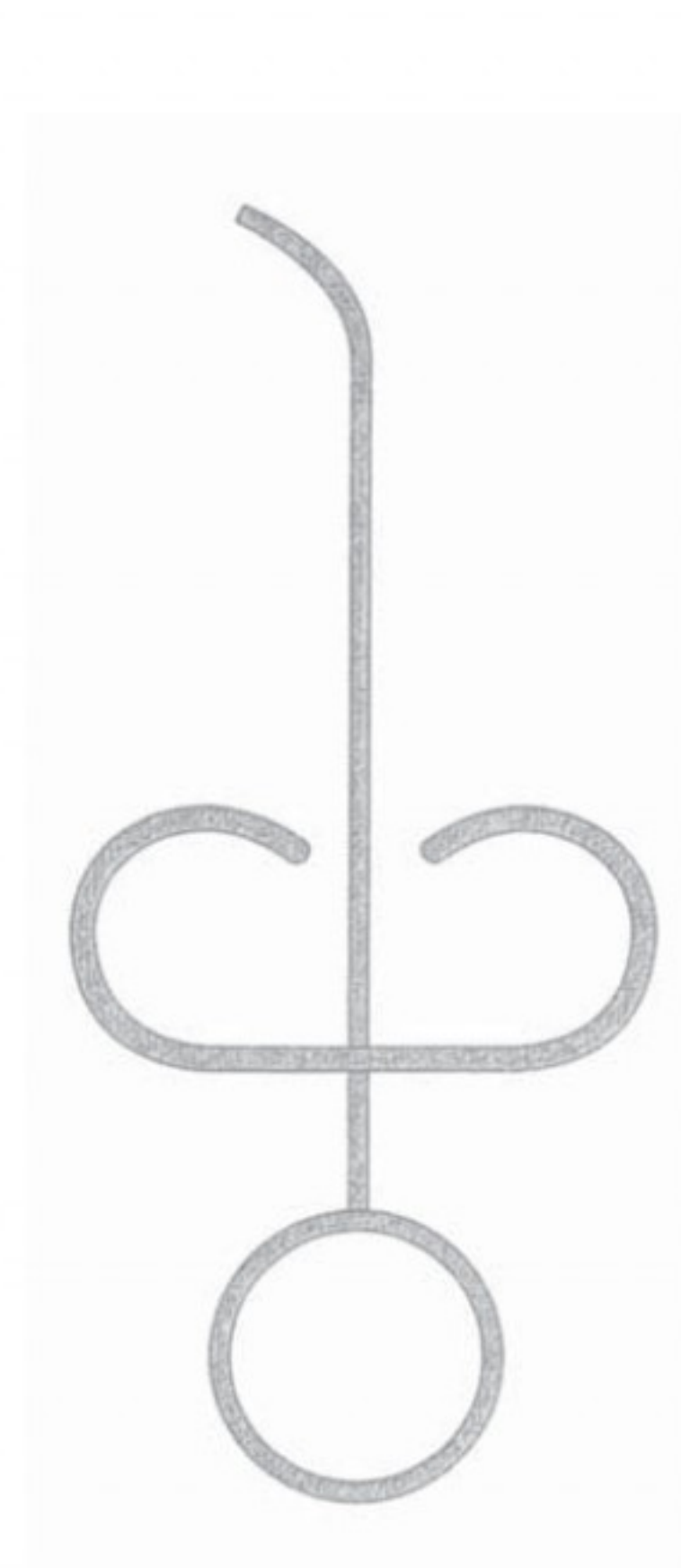

PV 015/18
 1,8 mm

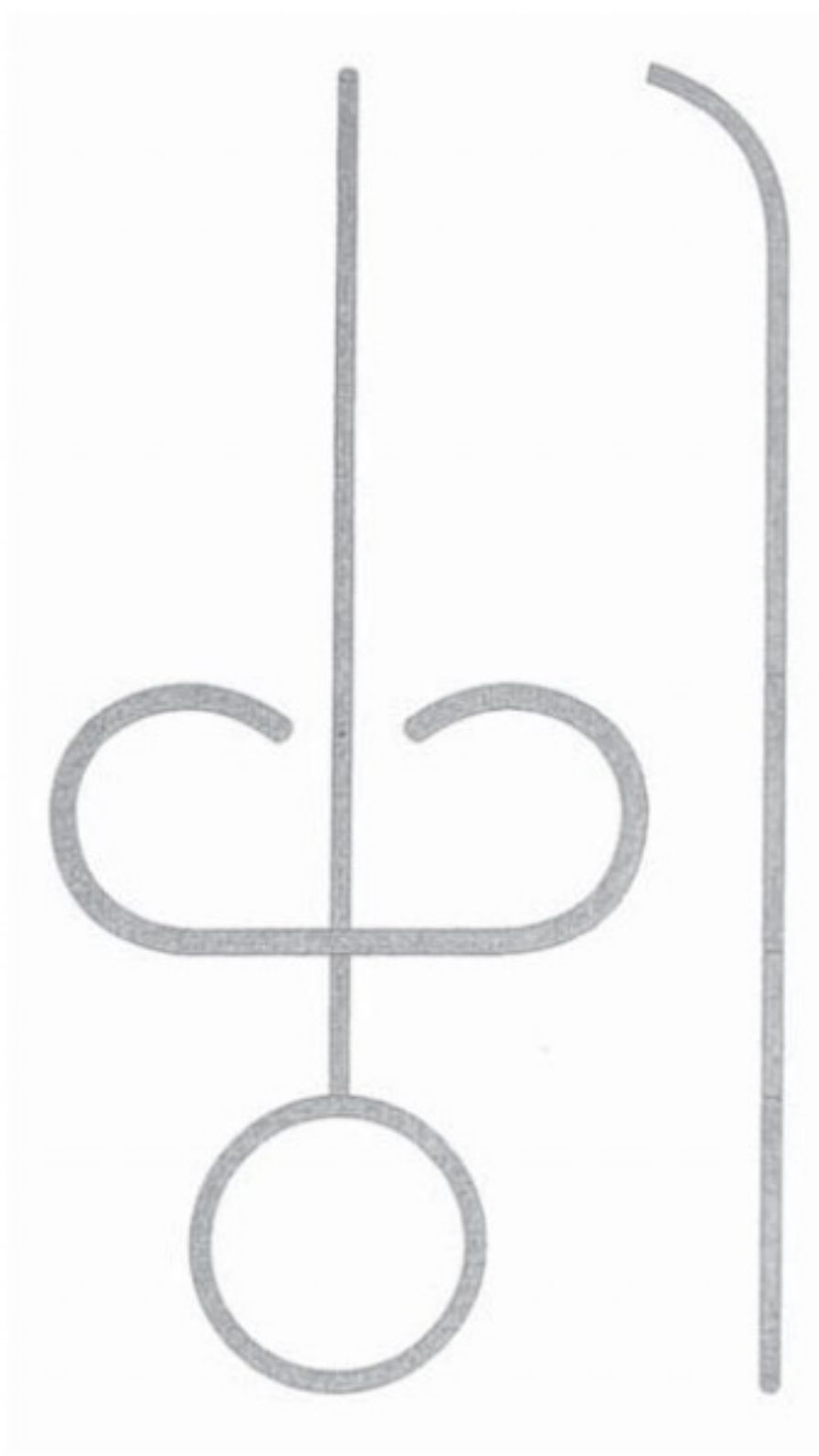

PV 017/18
 1,8 mm

AA AB AC AD AE AF AG AH AI AJ AK AL AM AN AO AP AQ AR AS AT AU AV AW AX AY AZ
 BA BB BC BD BE BF BG BH BI BJ BK BL BM BN BO BP BQ BR BS BT BU BV BW BX BY BZ
 CA CB CC CD CE CF CG CH CI CJ CK CL CM CN CO CP CQ CR CS CT CU CV CW CX CY CZ
 DA DB DC DD DE DF DG DH DI DJ DK DL DM DN DO DP DQ DR DS DT DU DV DW DX DY DZ
 EA EB EC ED EE EF EG EH EI EJ EK EL EM EN EO EP EQ ER ES ET EU EV EW EX EY EZ
 FA FB FC FD FE FF FG FH FI FJ FK FL FM FN FO FP FQ FR FS FT FU FV FW FX FY FZ
 GA GB GC GD GE GF GG GH GI GJ GK GL GM GN GO GP GQ GR GS GT GU GV GW GX GY GZ
 HA HB HC HD HE HF HG HH HI HJ HK HL HM HN HO HP HQ HR HS HT HU HV HW HX HY HZ
 IA IB IC ID IE IF IG IH II IJ IK IL IM IN IO IP IQ IR IS IT IU IV IW IX IY IZ
 JA JB JC JD JE JF JG JH JI JJ JK JL JM JN JO JP JQ JR JS JT JU JV JW JX JY JZ
 KA KB KC KD KE KF KG KH KI KJ KK KL KM KN KO KP KQ KR KS KT KU KV KW KX KY KZ
 LA LB LC LD LE LF LG LH LI LJ LK LL LM LN LO LP LQ LR LS LT LU LV LW LX LY LZ
 MA MB MC MD ME MF MG MH MI MJ MK ML MN MO MP MQ MR MS MT MU MV MW MX MY MZ
 NA NB NC ND NE NF NG NH NI NJ NK NL NM NO NP NQ NR NS NT NU NV NW NX NY NZ
 OA OB OC OD OE OF OG OH OI OJ OK OL OM ON OO OP OQ OR OS OT OU OV OW OX OY OZ
 PA PB PC PD PE PF PG PH PI PJ PK PL PM PN PO PP PQ PR PS PT PU PV PW PX PY PZ
 QA QB QC QD QE QF QG QH QI QJ QK QL QM QN QO QQ QR QS QT QU QV QW QX QY QZ
 RA RB RC RD RE RF RG RH RI RJ RK RL RM RN RO RP RQ RR RS RT RU RV RW RX RY RZ
 SA SB SC SD SE SF SG SH SI SJ SK SL SM SN SO SP SQ SR SS ST SU SV SW SX SY SZ
 TA TB TC TD TE TF TG TH TI TJ TK TL TM TN TO TP TQ TR TS TT TU TV TW TX TY TZ
 UA UB UC UD UE UF UG UH UI UJ UK UL UM UN UO UP UQ UR US UT UU UV UW UX UY UZ
 VA VB VC VD VE VF VG VH VI VJ VK VL VM VN VO VP VQ VR VS VT VU VW VX VY VZ
 WA WB WC WD WE WF WG WH WI WJ WK WL WM WN WO WP WQ WR WS WT WU WV WW WX WY WZ
 XA XB XC XD XE XF XG XH XI XJ XK XL XM XN XO XP XQ XR XS XT XU XV XW XX XY XZ
 YA YB YC YD YE YF YG YH YI YJ YK YL YM YN YO YP YQ YR YS YT YU YV YW YX YZ
 ZA ZB ZC ZD ZE ZF ZG ZH ZI ZJ ZK ZL ZM ZN ZO ZP ZQ ZR ZS ZT ZU ZV ZW ZX ZY ZZ

PV

Knochenspritzen
 Bone carriers
 Jeringas de hueso
 Seringue à os
 Siringhe per osso

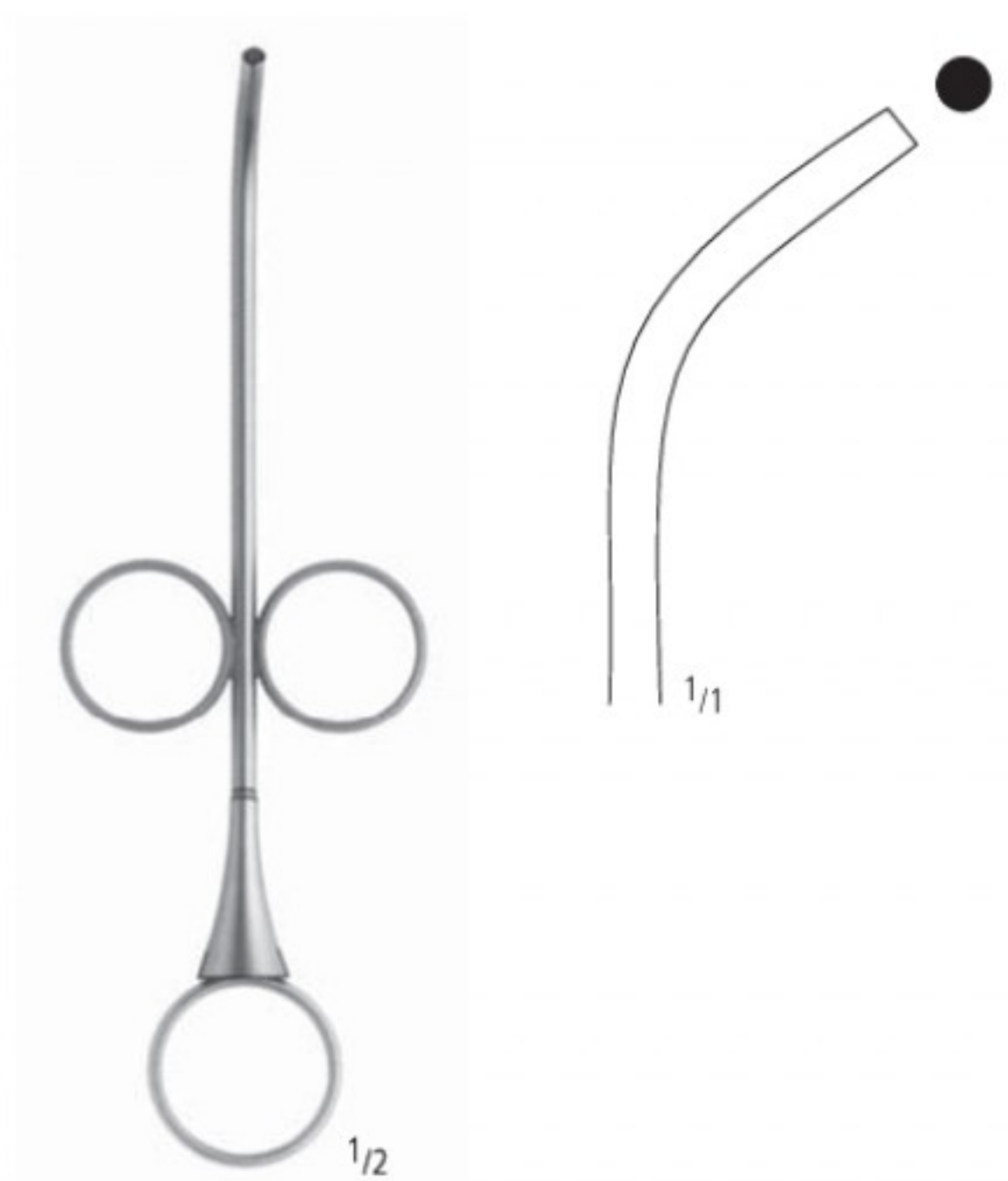

Fig. 01
 PV 020/01
 2,5/3,5 mm

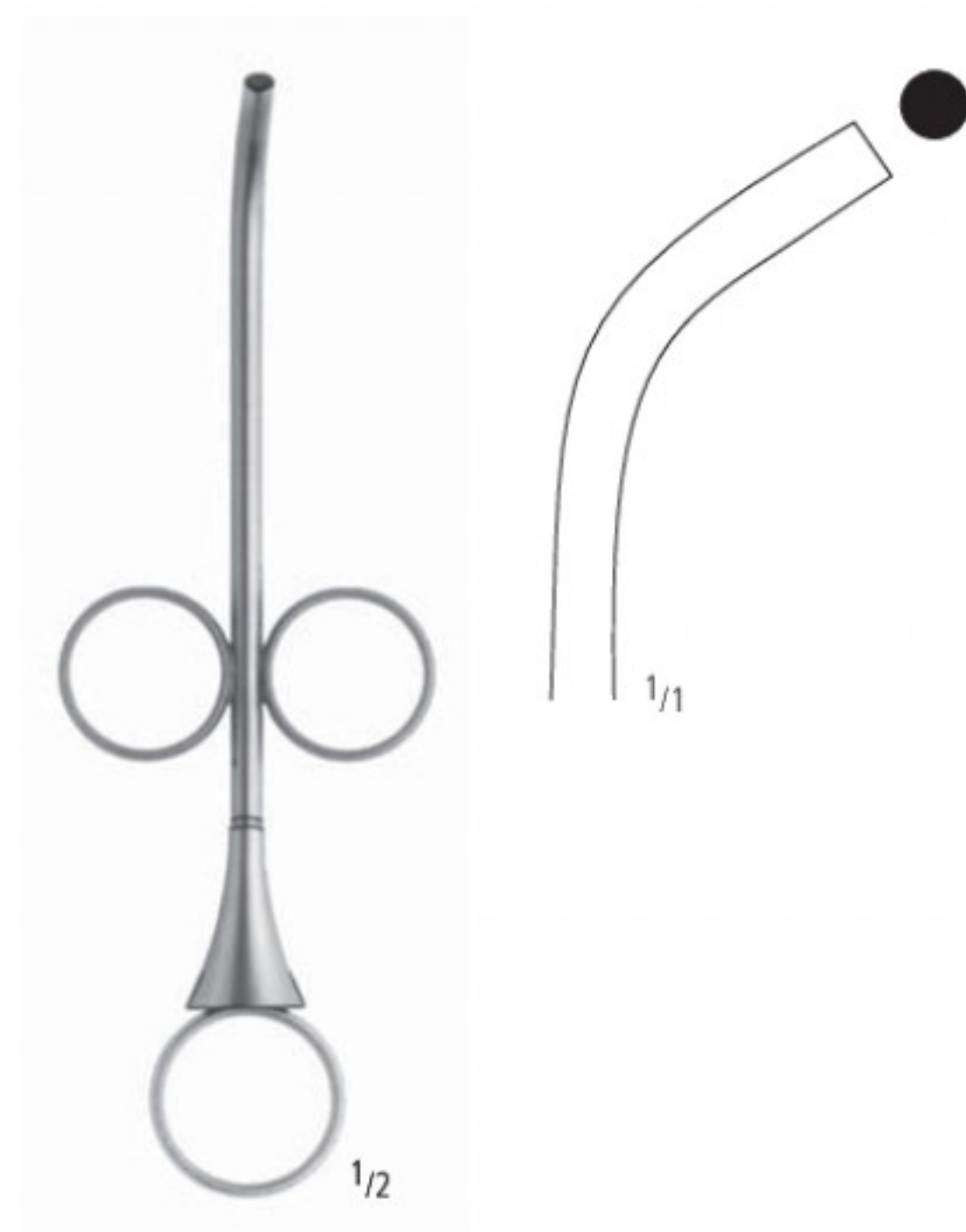

Fig. 02
 PV 020/02
 3,5/4,5 mm

Knochenspritzen
 Bone carriers
 Jeringas de hueso
 Seringue à os
 Siringhe per osso

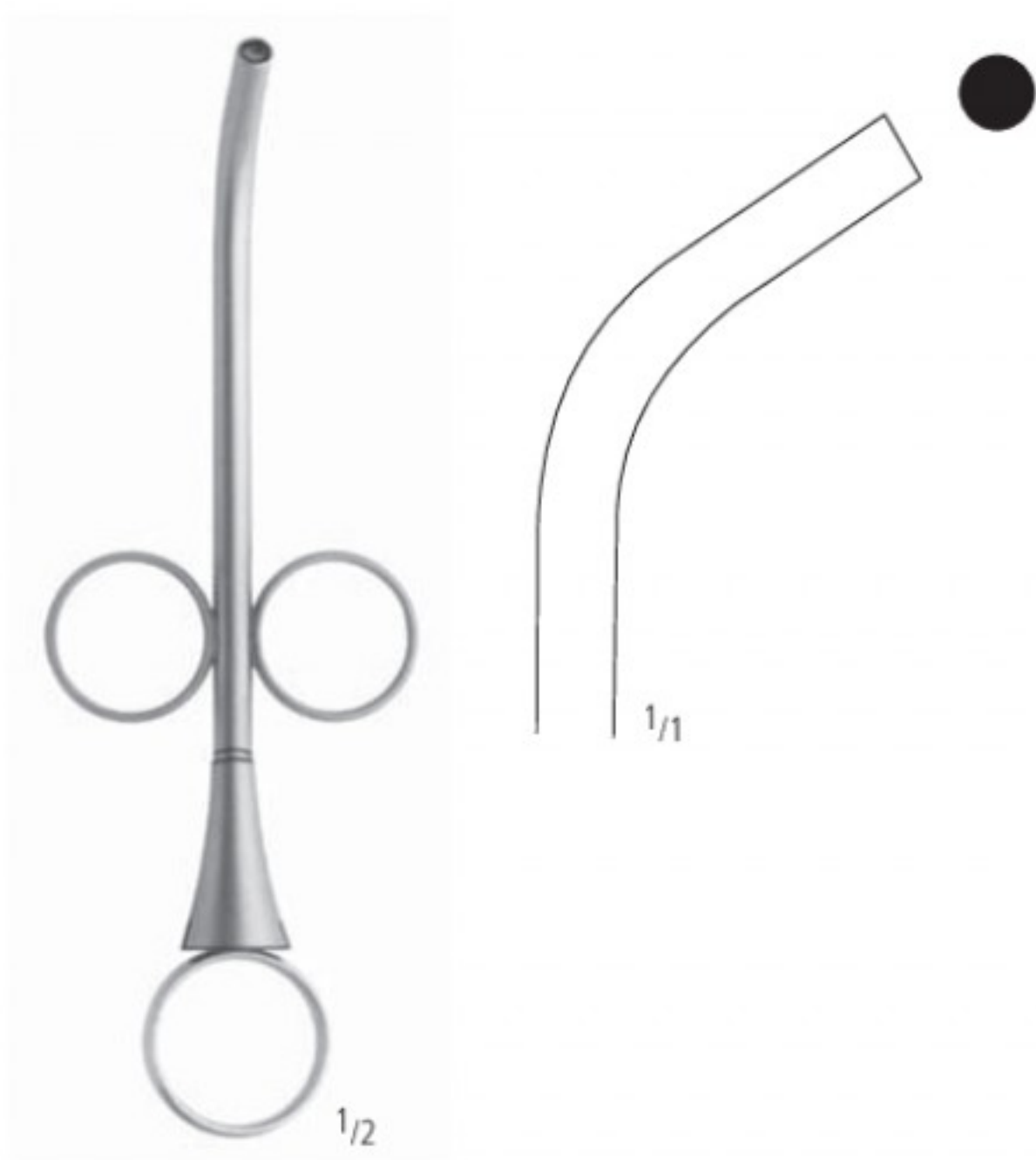

Fig. 03
 PV 020/03
 4,5/5,5 mm

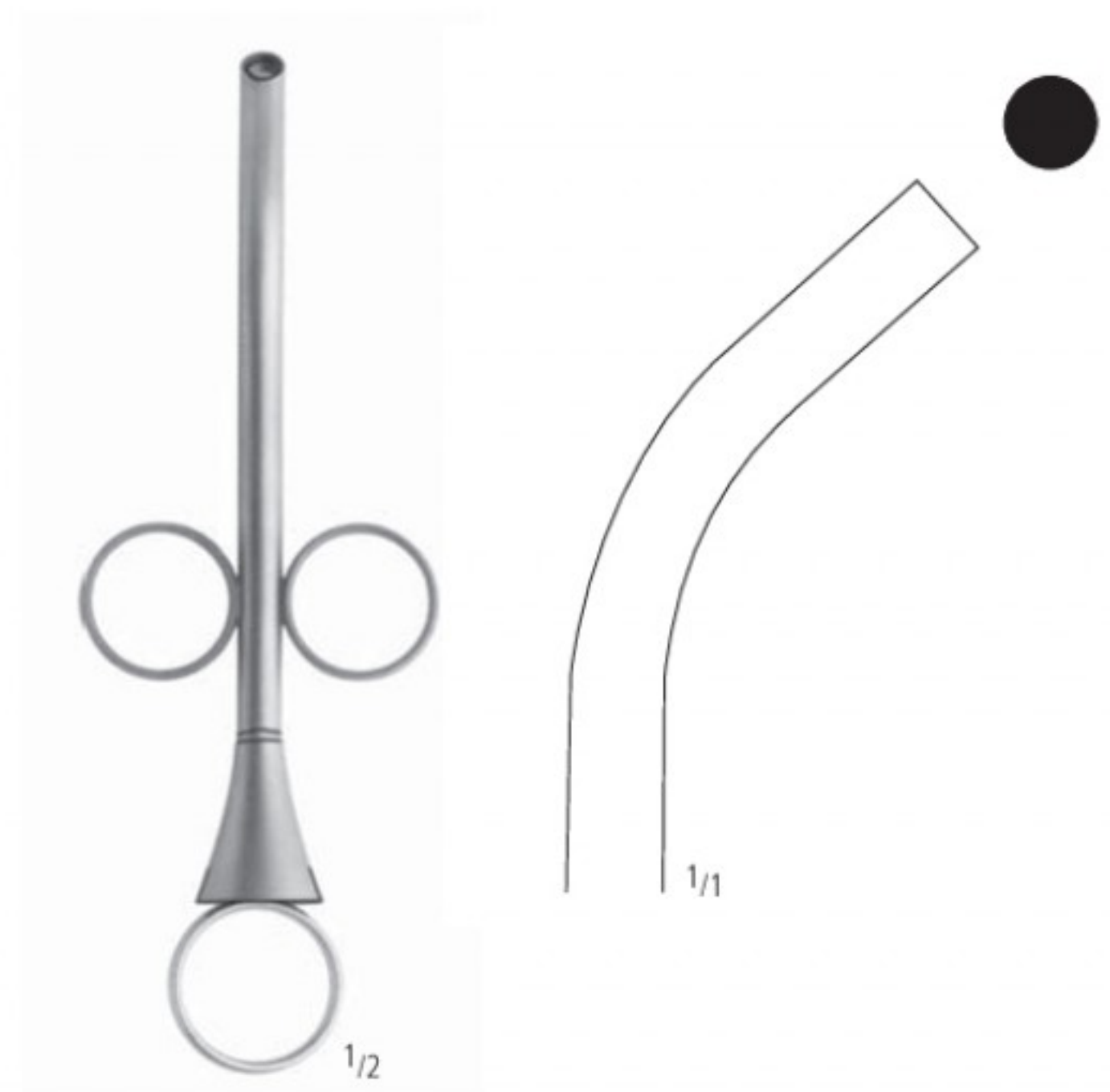
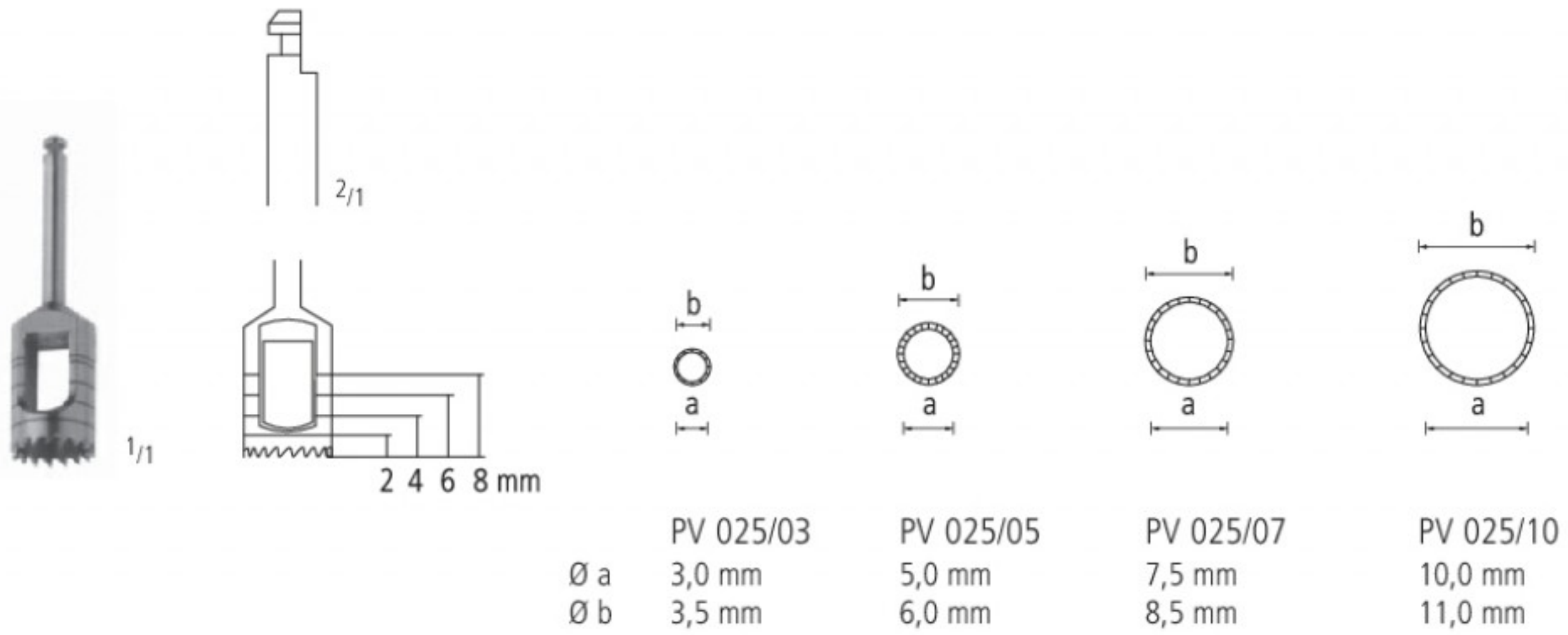

Fig. 04
 PV 020/04
 6/7 mm

AA
 AB
 AC
 AD
 AE
 AF
 AK
 AL
 AO
 AR
 KA
 KL
 KU
 PA
 PB
 PF
 PI
 PK
 PL
 PM
 PP
 PS
 PT
 PU
PV
 KYE

Trepanbohrer, Implantat-Messzange
 Trepine burrs, implantology caliper
 Fresas trephines, calibradores de implantología
 Fraises trépan, calibres d'implantologie
 Frese trephine, calibri per implantologia



PV 030/15
 15,0 cm/6"



PV 031/15
 15,0 cm/6"

Knochenmühle
 Bone mill
 Molino de huesos
 Broyer d'os
 Mulino d'osso



PV 759/00

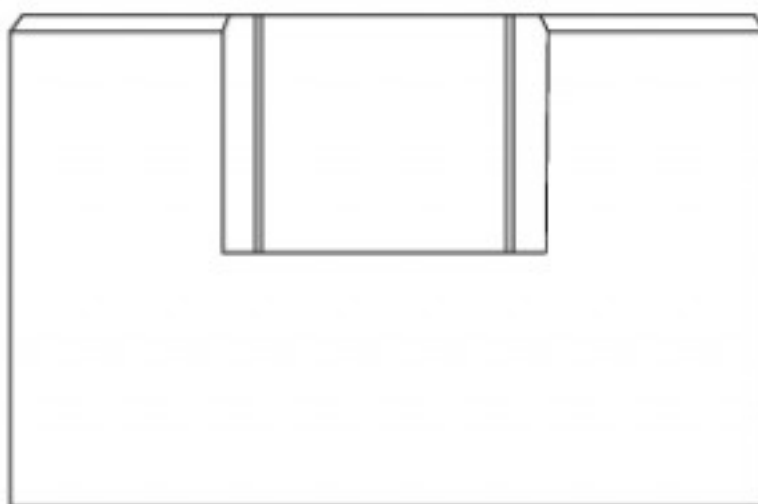
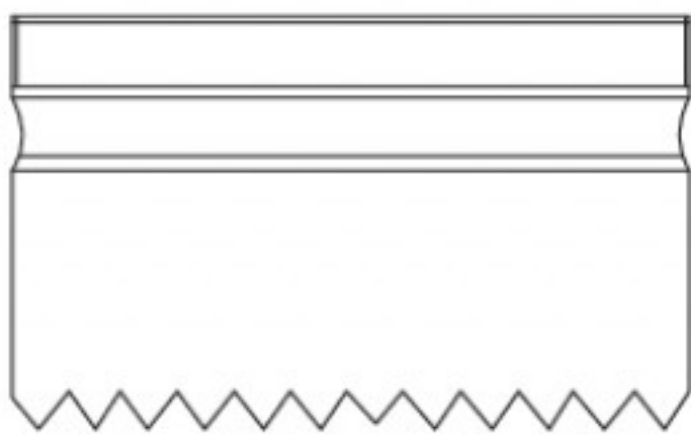
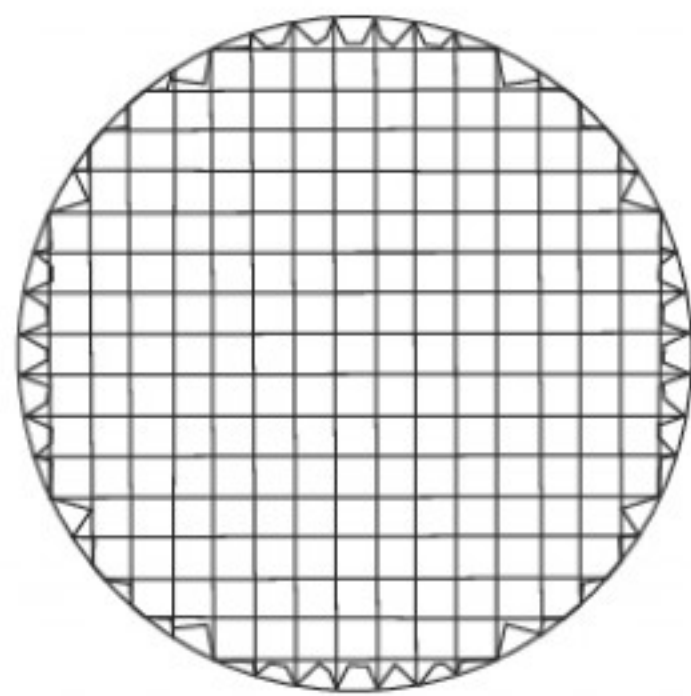

1/1



PV 760/00
 16,5 cm/6 1/2"

1/1

AA AB AC AD AE AF AK AL AO AR KA KL KU PA PB PF PI PK PL PM PP PS PT PU PV

PV

KYE

STERILISATIONSBEHÄLTNISSE
UND NORM-TRAYS

STERILIZING CONTAINERS
AND STANDARD TRAYS

CAJAS PARA ESTERILIZACION
Y BANDEJAS ESTANDAR

DES BOITES A INSTRUMENTS ET POUR LA
STERILISATION ET TRAYS STANDARD

ASTUCCI PER LA STERILIZZAZIONE
E BACINELLE STANDARD

KYE

nopa[®] instruments

Unser komplettes Container Programm finden Sie
in unserem Katalog „Container System“.

For our complete range of sterilizing containers
kindly refer to our catalogue "Container system".

Para nuestro gama completa de contenedores,
por favor consulte nuestro catálogo de
"Sistema de contenedor".

Pour notre gamme complet des conteneurs, consultez
notre catalogue „Système de conteneur“.







Per nostro assortimento completo di contenitore,
consultare il nostro catalogo "Sistema del Contenitore".

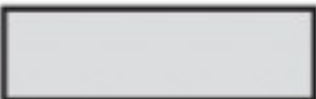

Dental Container



Nur Deckel farbig
Lid colored only
Solamente tapas en diferentes colores
Couvercle de couleur seulement
Solo coperchio colorato

L(mm)	B(mm)	H(mm)						
310	190	40	KYE 370/01	KYE 370/02	KYE 370/03	KYE 370/04	KYE 370/05	KYE 370/06
310	190	65	KYE 371/01	KYE 371/02	KYE 371/03	KYE 371/04	KYE 371/05	KYE 371/06
310	190	130	KYE 372/01	KYE 372/02	KYE 372/03	KYE 372/04	KYE 372/05	KYE 372/06



Nur Deckel farbig
Lid colored only
Solamente tapas en diferentes colores
Couvercle de couleur seulement
Solo coperchio colorato

L(mm)	B(mm)	H(mm)						
310	190	40	KYE 373/01	KYE 373/02	KYE 373/03	KYE 373/04	KYE 373/05	KYE 373/06
310	190	65	KYE 374/01	KYE 374/02	KYE 374/03	KYE 374/04	KYE 374/05	KYE 374/06
310	190	130	KYE 375/01	KYE 375/02	KYE 375/03	KYE 375/04	KYE 375/05	KYE 375/06



L(mm)	B(mm)	H(mm)	
310	190	40	KYE 365/04
310	190	65	KYE 365/06
310	190	130	KYE 365/13



L(mm)	B(mm)	H(mm)	
310	190	40	KYE 366/04
310	190	65	KYE 366/06
310	190	130	KYE 366/13



L(mm)	B(mm)
310	190



KYE 280/71 KYE 280/72 KYE 280/73 KYE 280/74 KYE 280/75 KYE 280/76



L(mm)	B(mm)
310	190



KYE 289/71 KYE 289/72 KYE 289/73 KYE 289/74 KYE 289/75 KYE 289/76

AA AB AC AD AE AF AK AL AO AR KA KL KU PA PB PF PI PK PL PM PP PS PT PU PV

KYE



L(mm)	B(mm)	H(mm)	
274	172	43	SK 435/04

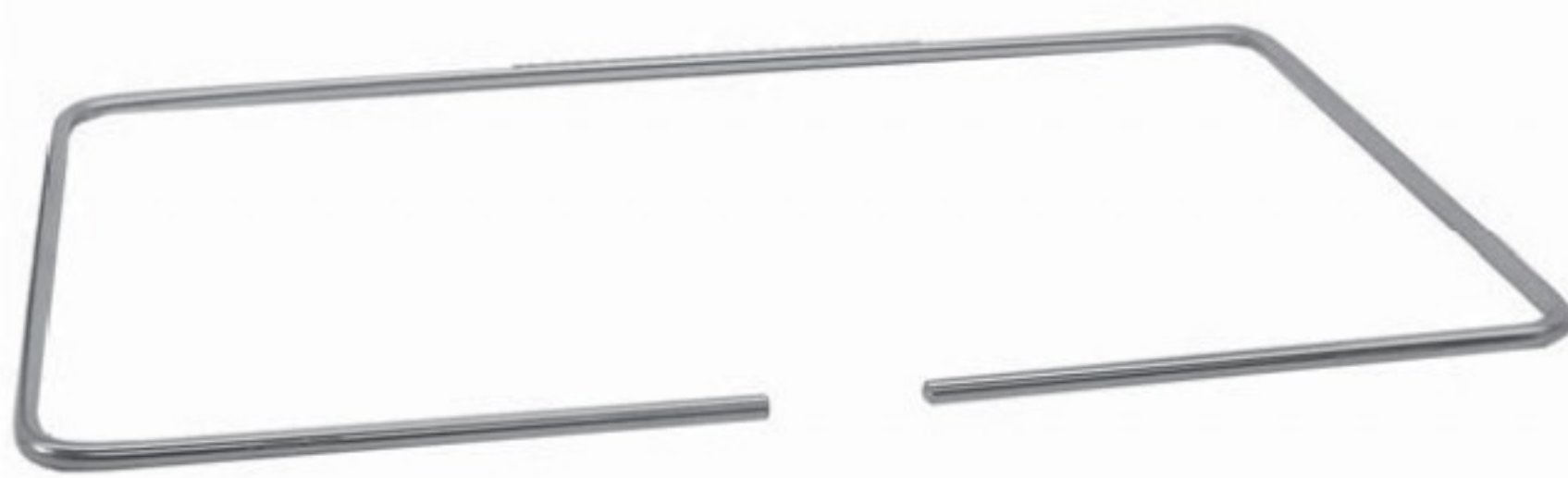

L(mm)	B(mm)	
274	172	SK 435/61

- >> BÜRSTENSPENDER FÜR 20 BÜRSTEN (OHNE BÜRSTEN)
- >> BRUSH DISPENSER FOR 20 BRUSHES (WITHOUT BRUSHES)
- >> DISTRIBUIDOR DE CEPILLOS PARA 20 CEPILLOS (SIN CEPILLOS)
- >> DISTRIBUTEUR DE BROSSES POUR 20 BROSSES (SANS BROSSES)
- >> DISTRIBUTORE DI SPAZZOLE PER 20 SPAZZOLE (SENZA SPAZZOLE)



KY 900/00
 autoklavierbar
 autoclavable
 autoclavable
 autoclavable
 autoclavabile

AA AB AC AD AE AF AK AL AO AR KA KL KU PA PB PF PI PK PL PM PP PS PT PU PV

KYE

Norm-Trays und Zubehör
Standard trays and accessories

Bandejas estándar y accesorios
Trays standard et accessoires
Bacinelle standard ed accessori

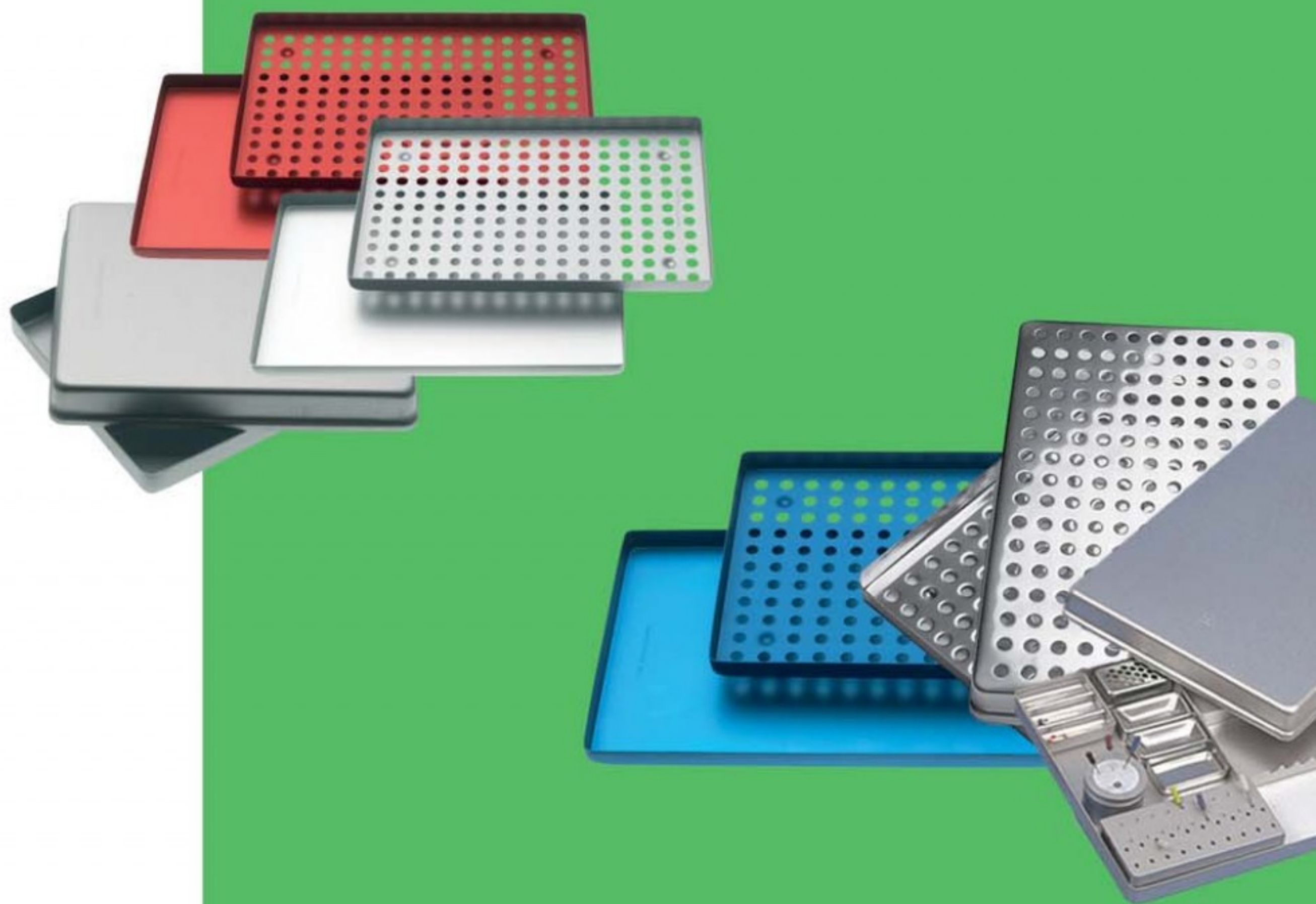

ALU

NORM-TRAYS



L(mm) B(mm) H(mm)
285 185 40

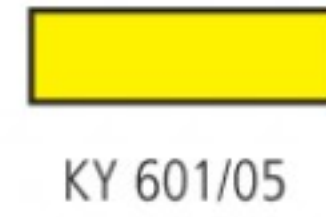
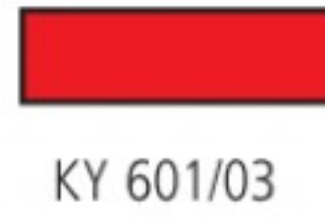
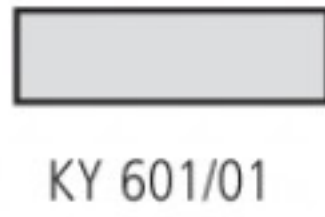

L(mm) B(mm) H(mm)
285 185 40

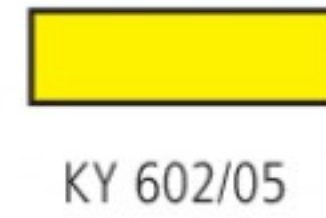
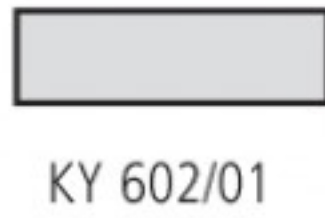

L(mm) B(mm) H(mm)
285 185 17

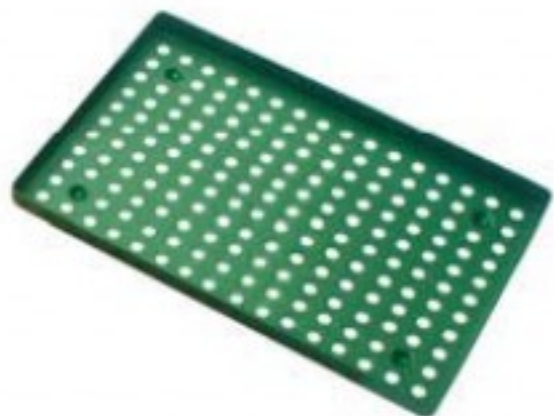
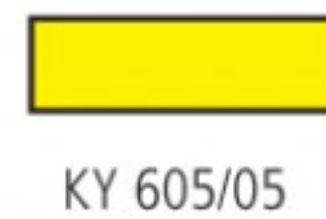
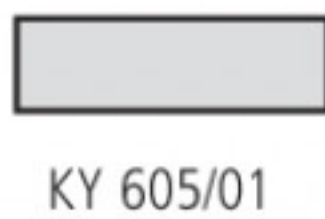

L(mm) B(mm) H(mm)
285 185 17

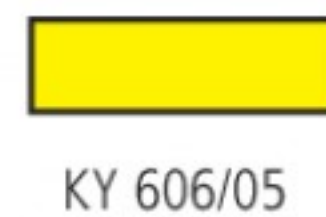

L(mm) B(mm) H(mm)
285 185 26

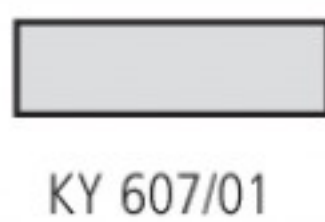

ALU



für 10 Instrumente
for 10 instruments

KY 610/10



für 14 Instrumente
for 14 instruments

KY 610/14

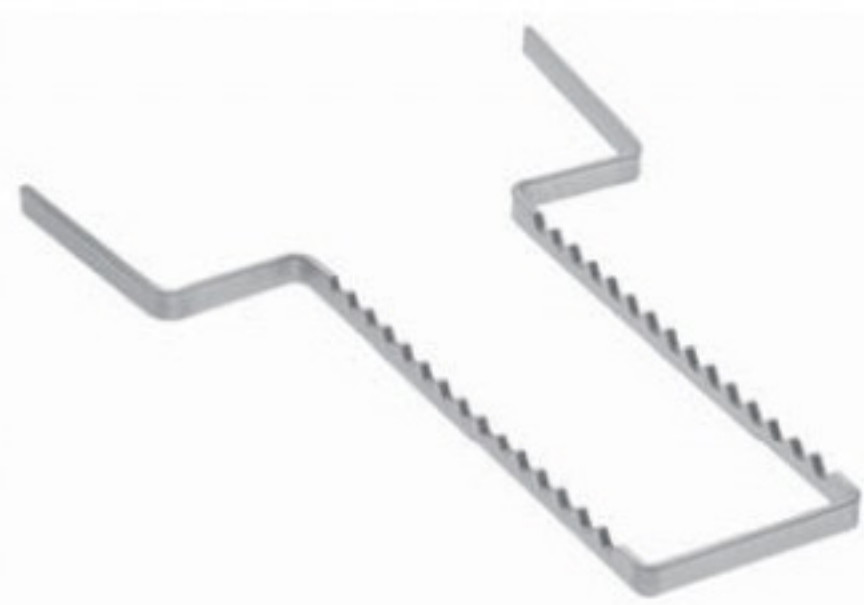

für 15 Instrumente
for 15 instruments

KY 610/15



KY 612/07
78 x 40 x 7 mm



KY 612/24
105 x 50 x 24 mm



KY 613/03
50 x 50 x 12 mm



KY 613/12
90 x 45 x 12 mm

AA AB AC AD AE AF AK AL AO AR KA KL KU PA PB PF PI PK PL PM PP PS PT PU PV KYE

ALU

MINI







L(mm)	B(mm)	H(mm)					
184	140	40	KY 621/01	KY 621/02	KY 621/03	KY 621/04	KY 621/05



L(mm)	B(mm)	H(mm)					
184	140	40	KY 622/01	KY 622/02	KY 622/03	KY 622/04	KY 622/05



L(mm)	B(mm)	H(mm)					
184	140	17	KY 625/01	KY 625/02	KY 625/03	KY 625/04	KY 625/05

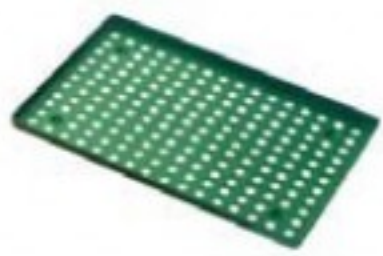

L(mm)	B(mm)	H(mm)					
184	140	17	KY 626/01	KY 626/02	KY 626/03	KY 626/04	KY 626/05



L(mm)	B(mm)	H(mm)	
184	140	26	KY 627/01

MINI

ALU



für 7 Instrumente
for 7 instruments

KY 630/07

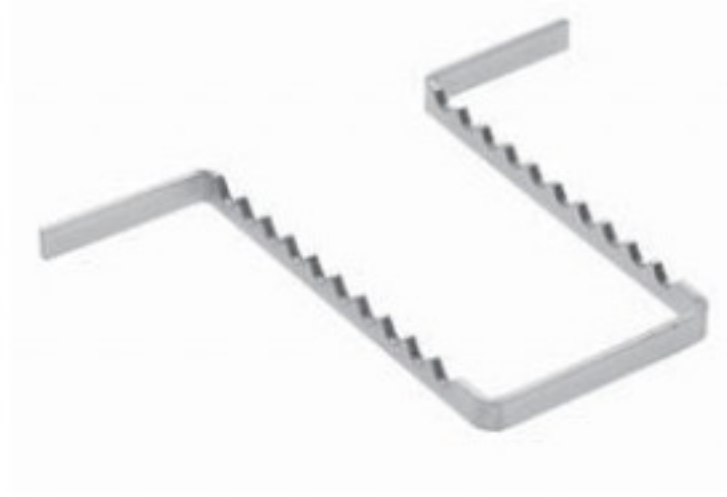

für 10 Instrumente
for 10 instruments

KY 630/10



KY 632/12
40 x 40 x 12 mm

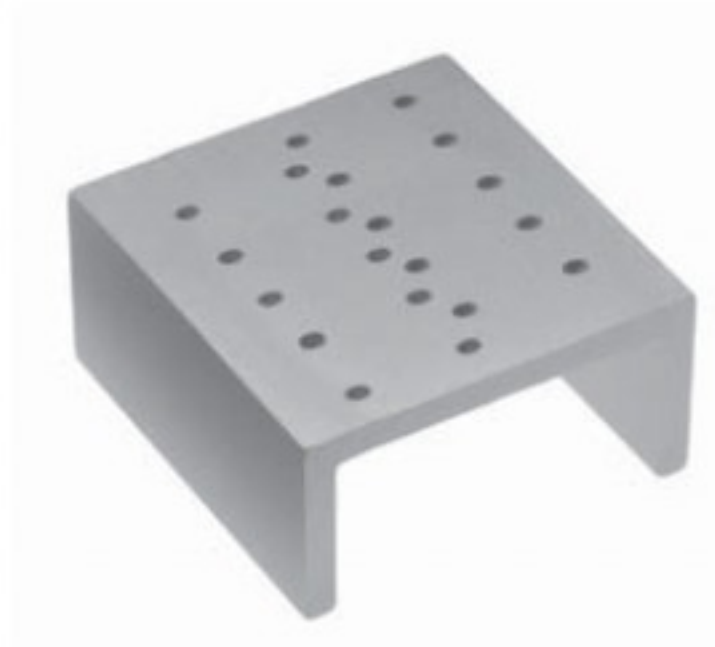

KY 632/24
52 x 50 x 24 mm

AA
AB
AC
AD
AE
AF
AK
AL
AO
AR
KA
KL
KU
PA
PB
PF
PI
PK
PL
PM
PP
PS
PT
PU
PV
KYE

ALU



KY 635/00

Endodontic Tray S

KY 635/00 =	KY 635/01	Grey Tray and Lid	1 pc
	KY 635/02	Insert Frame S	1 pc
	KY 635/03	Reamer Stand	1 pc
	KY 635/04	Pellet Container	1 pc
	KY 635/05	Burr	1 pc
	KY 635/06	Box	1 pc
	KY 635/07	Clean-Grip	1 pc
	KY 635/08	Box for Points	1 pc
	KY 635/09	Medicament Cups	2 pc



KY 636/00

Endodontic Mini Tray S

KY 636/00 =	KY 636/01	Grey Tray and Lid	1 pc
	KY 636/02	Insert Mini Endo	1 pc
	KY 636/03	Box for Points	1 pc
	KY 636/04	Medicament Cup	1 pc
	KY 636/05	Clean Grip	1 pc
	KY 636/06	Reamer Stand Mini	1 pc

NORM-TRAYS

STAINLESS STEEL



L(mm)	B(mm)	H(mm)	
284	184	40	KY 650/01

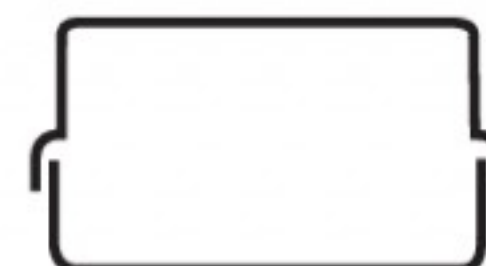

L(mm)	B(mm)	H(mm)	
284	184	40	KY 650/02

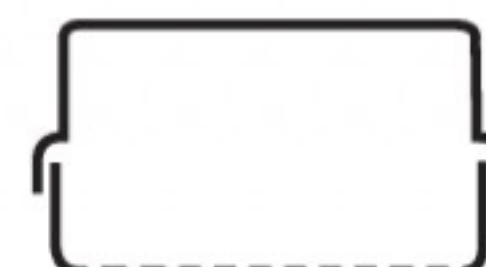

L(mm)	B(mm)	H(mm)	
284	184	17	KY 653/01



L(mm)	B(mm)	H(mm)	
284	184	17	KY 653/02



L(mm)	B(mm)	H(mm)	
287	186	26	KY 654/01



L(mm)	B(mm)	H(mm)	
287	186	26	KY 654/02



AA AB AC AD AE AF AG AH AI AJ AK AL AM AN AO AP AQ AR AS AT AU AV AW AX AY AZ BA BB BC BD BE BF BG BH BI BJ BK BL BM BN BO BP BQ BR BS BT BU BV BW BX BY BZ CA CB CC CD CE CF CG CH CI CJ CK CL CM CN CO CP CQ CR CS CT CU CV CW CX CY CZ DA DB DC DE DF DG DH DI DJ DK DL DM DN DO DP DQ DR DS DT DU DV DW DX DY DZ EA EB EC ED EE EF EG EH EI EJ EK EL EM EN EO EP EQ ER ES ET EU EV EW EX EY EZ FA FB FC FD FE FF FG FH FI FJ FK FL FM FN FO FP FQ FR FS FT FU FV FW FX FY FZ GA GB GC GD GE GF GG GH GI GJ GK GL GM GN GO GP GQ GR GS GT GU GV GW GX GY GZ HA HB HC HD HE HF HG HH HI HJ HK HL HM HN HO HP HQ HR HS HT HU HV HW HX HY HZ IA IB IC ID IE IF IG IH II IJ IK IL IM IN IO IP IQ IR IS IT IU IV IW IX IY IZ JA JB JC JD JE JF JG JH JI JJ JK JL JM JN JO JP JQ JR JS JT JU JV JW JX JY JZ KA KB KC KD KE KF KG KH KI KJ KK KL KM KN KO KP KQ KR KS KT KU KV KW KX KY KZ LA LB LC LD LE LF LG LH LI LJ LK LL LM LN LO LP LQ LR LS LT LU LV LW LX LY LZ MA MB MC MD ME MF MG MH MI MJ MK ML MN MO MP MQ MR MS MT MU MV MW MX MY MZ NA NB NC ND NE NF NG NH NI NJ NK NL NO NP NQ NR NS NT NU NV NW NX NY NZ OA OB OC OD OE OF OG OH OI OJ OK OL OM ON OO OP OQ OR OS OT OU OV OW OX OY OZ PA PB PC PD PE PF PG PH PI PJ PK PL PM PN PO PP PQ PR PS PT PU PV PW PX PY PZ QA QB QC QD QE QF QG QH QI QJ QK QL QM QN QO QP QQ QR QS QT QU QV QW QX QY QZ RA RB RC RD RE RF RG RH RI RJ RK RL RM RN RO RP RQ RR RS RT RU RV RW RX RY RZ SA SB SC SD SE SF SG SH SI SJ SK SL SM SN SO SP SQ SR SS ST SU SV SW SX SY SZ TA TB TC TD TE TF TG TH TI TJ TK TL TM TN TO TP TQ TR TS TT TU TV TW TX TY TZ UA UB UC UD UE UF UG UH UI UJ UK UL UM UN UO UP UQ UR US UT UY UZ VA VB VC VD VE VF VG VH VI VJ VK VL VM VN VO VP VQ VR VS VT VY VZ WA WB WC WD WE WF WG WH WI WJ WK WL WM WN WO WP WQ WR WS WT WY WZ XA XB XC XD XE XF XG XH XI XJ XK XL XM XN XO XP XQ XR XS XT XU XV XW XX XY XZ YA YB YC YD YE YF YG YH YI YJ YK YL YM YN YO YP YQ YR YS YT YU YV YW YX YY YZ ZA ZB ZC ZD ZE ZF ZG ZH ZI ZJ ZK ZL ZM ZN ZO ZP ZQ ZR ZS ZT ZU ZV ZW ZX ZY ZZ

KYE

STAINLESS STEEL

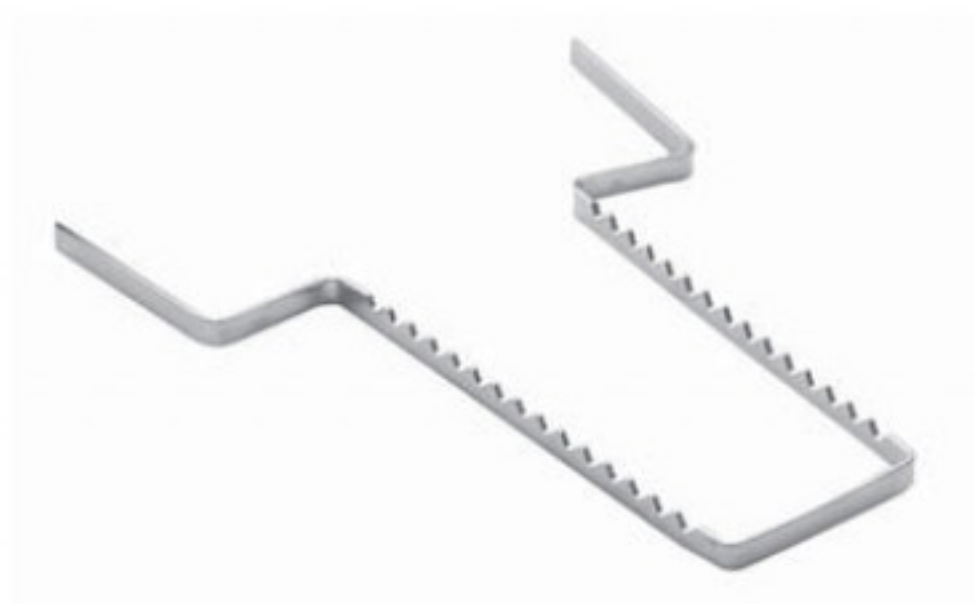

für 11 Instrumente
for 11 instruments

KY 660/11



KY 660/50
284 x 183 mm



KY 660/51
48 x 27 x 9 mm

Lagerungstray
 Storing tray
 Tray para depositar
 Plateau pour déposer instruments
 Bacinella per il deposito degli strumenti

STAINLESS STEEL



180 x 60 x 22 mm
 für 5 Instrumente
 for 5 instruments
 para 5 instrumentos
 pour 5 instruments
 per 5 strumenti

KY 670/05



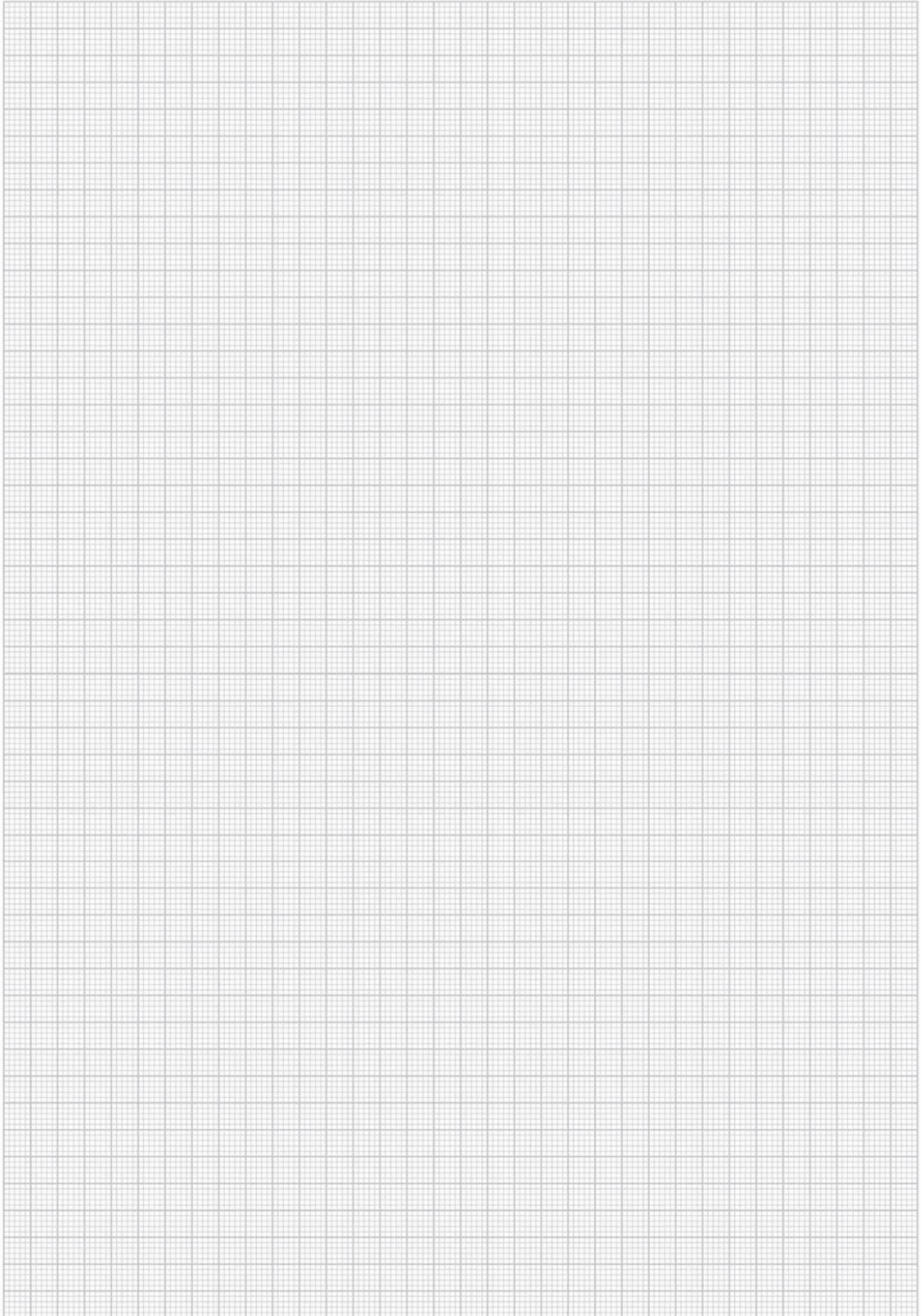

180 x 140 x 22 mm
 für 10 Instrumente
 for 10 instruments
 para 10 instrumentos
 pour 10 instruments
 per 10 strumenti

KY 670/10



STERILISATION STERILIZATION ESTERILIZACION STERILISATION STERILIZZAZIONE

Siebkörbe aus Lochblech
 Perforated steel basket
 Cestillo de acero perforado
 Panier d'acier poinçonné
 Cestello in acciaio perforato

	h mm	 box and lid	 box	 lid
 265 x 125 x h	50	SU 450/05	SU 450/55	SU 450/65
 275 x 175 x h	40 95	SU 451/04 SU 451/09	SU 451/54 SU 451/59	SU 451/65

AA AB AC AD AE AF AK AL AO AR KA KL KU PA PB PF PI PK PL PM PP PS PT PU PV

